

User's Guide

ORECK[®]

Steam-All[™] Canister

STEAM200

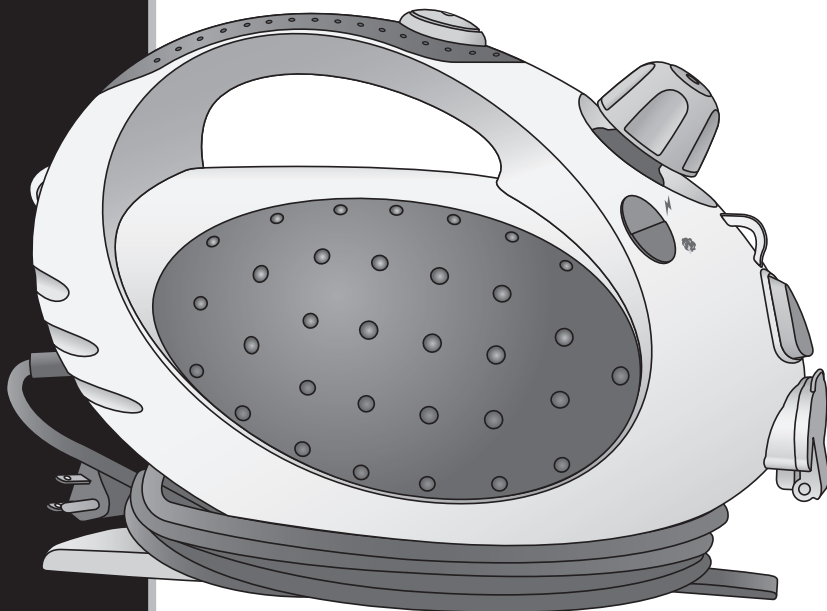

clean home[®]

Important!

Read this manual carefully,
and keep for future reference.

Enjoy

Thank You for purchasing our top-of-the-line Oreck Steam-All™ Canister Steam Cleaner. This powerful, environmentally friendly cleaner will help you clean both hard floors and refresh carpets.



At Oreck, we understand that our customers are unique and expect superior service. To meet your needs, we offer different customer service options to accommodate your lifestyle and preference.

Welcome to our **Call. Click. Visit.** customer service program. To speak with an Oreck representative call, click or visit using the information below.

Call



USA: **1•800•989•3535**
Canada: **1•888•676•7325**

Click



On the web, point and click at: **www.oreck.com**
or visit www.oreck.com and click locate a store on the top right.

Visit



Visit us in person at one our store locations.
To find the nearest store, please call **888•oreck**
(**1•888•673•2578**).

Contents

Safety	4
General Warnings	4
Parts	7
Product Components	7
Features	8
Assembly	9
Attach the Hose/Handle	9
Attach the Floor Nozzle	9
Attaching the Jet Adaptor to Nozzles	10
Use	12
Choose the Attachments	12
Adaptors	12
Nozzles and Their Accessories	12
Before You Begin Cleaning	13
Apply Steam	16
After Using the Steamer	18
Maintenance	19
Rinsing the Boiler Tank	19
De-scaling the Boiler Tank	19
Troubleshooting	20
Replacement Parts	21
Warranty	22



IMPORTANT SAFETY INSTRUCTIONS

Read all instructions before using the steam cleaner.

WARNING! To reduce the risk of fire, electric shock, or injury when using an electrical appliance, basic precautions should always be followed, including the following:

- Do not leave appliance unattended when plugged in. Unplug from outlet when not in use and before servicing.
- To prevent shock, do not use outdoors. The steam cleaner is intended for household use only.
- Do not let the unit run while in any one stationary position for any period of time. Keep the unit moving during use.
- Do not allow to be used as a toy.
- This product is not to be used by children.
- Do not use the steam cleaner directly overhead.
- Do not put any objects into openings or operate with openings blocked.
- Never immerse the steam cleaner in water or liquids.
- Use only as described in this manual. Use only manufacturer's recommended attachments.
- Do not use with damaged cord or plug. If appliance is not working as it should, has been dropped, damaged, left outdoors, or dropped into water, return it to a service center or call customer service at: US: 1-800-989-3535
Canada: 1-888-676-7325.
- Do not pull or carry by the power cord, use cord as a handle, close a door on the power cord, or pull the power cord around sharp edges or corners.
- Keep the power cord away from heated surfaces.
- Do not run the steam cleaner over the power cord.
- Do not use an extension cord.
- Turn off all controls before unplugging. Always remove the power cord from the outlet and handle the steam cleaner with care when filling the boiler tank with water.
- Do not unplug by pulling on the power cord. To unplug, grasp the plug, not the power cord.

- Do not handle the plug or appliance with wet hands.
- Do not over fill the boiler tank. Do not exceed the maximum fill level. Use the measuring jug to measure the correct amount of water.
- Do not use without the filler cap in place. Check that the filler cap is completely screwed down before use.
- Do not operate without water in the boiler tank.
- Do not fill the water tank with anything other than water or Oreck Fresh Air® Steam Mop Essence. Never put additives (such as perfume, stain remover, or products containing alcohol) in the water as they may damage the steam cleaner or make it dangerous to use.
- Empty the boiler tank when the steam cleaner is not in use.
- Do not touch any hot areas on the steam cleaner or accessories. Allow them to cool down before handling them.
- The force and heat of the steam may have an adverse effect on some materials. Always test the steamer on a small concealed area to determine if it is suitable for treatment.
- Never point or aim the steam cleaner at people, animals (risk of scalding!), plants, electrical systems or wires.
- Do not use to treat clothing being worn on the body.
- Connecting the steam cleaner to improper voltage may result in damage to the steam cleaner and possible injury. Always plug the steam cleaner into a power outlet with the correct voltage. See the rating label on the unit for the correct voltage.
- Put in storage after each use to prevent tripping accidents.
- Steam through the hose and handle may cause them to get hot. Avoid contact with hot areas.

WARNING! This steamer product is equipped with a safety locking filler cap. The red button, located in the center of the cap, will rise above flush with cap when the system is heating and under pressure. This will prevent the user from removing the cap. Do not defeat the safety mechanism. Turn the unit “OFF” and depress the trigger to relieve pressure. Do not attempt to remove the cap and fill the tank until you have relieved as much pressure as possible and the unit has cooled or the red button returns to its original position. Always use caution when removing the cap.

DANGER

Improper connection of the equipment-grounding conductor can result in a risk of electrical shock. Check with a qualified electrician or service person if you are in doubt as to whether the outlet is grounded. If not, have a proper outlet installed by a qualified electrician.

This appliance is for use on nominal 120-volt circuit. It has a grounding plug similar to the example shown. Make sure the appliance is connected to an outlet with the same configuration as the plug. No adapter should be used with this appliance.

Grounded Plug

This appliance must be grounded. If it should malfunction or break down, grounding provides a safe path of least resistance for electrical current, reducing the risk of electrical shock. The cord for this appliance has an equipment-grounding conductor and a grounding plug. It must only be plugged into an electrical outlet that is properly installed and grounded in accordance with all local codes and ordinances.

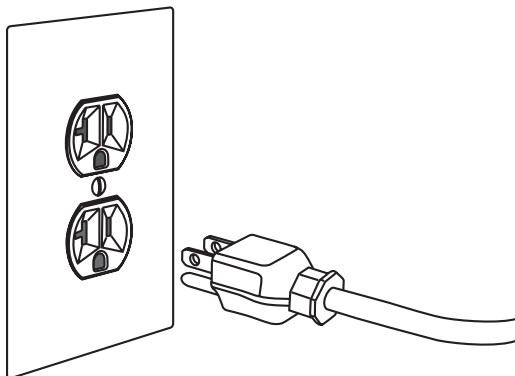

SAVE THESE INSTRUCTIONS
For household use only

Parts

Product Components



1. Steam-All™ Steamer
2. Shoulder strap
3. Handle/hose
4. Extension tube (3)
5. Floor nozzle adaptor
6. Floor nozzle
7. Cotton floor towel
8. Jet nozzle adaptor
9. Jet nozzle
10. Large brush
11. Small brush
12. Angled nozzle
13. Upholstery nozzle
14. Cotton Bonnet for upholstery nozzle
15. Window squeegee
16. Funnel
17. Measuring cup

Features

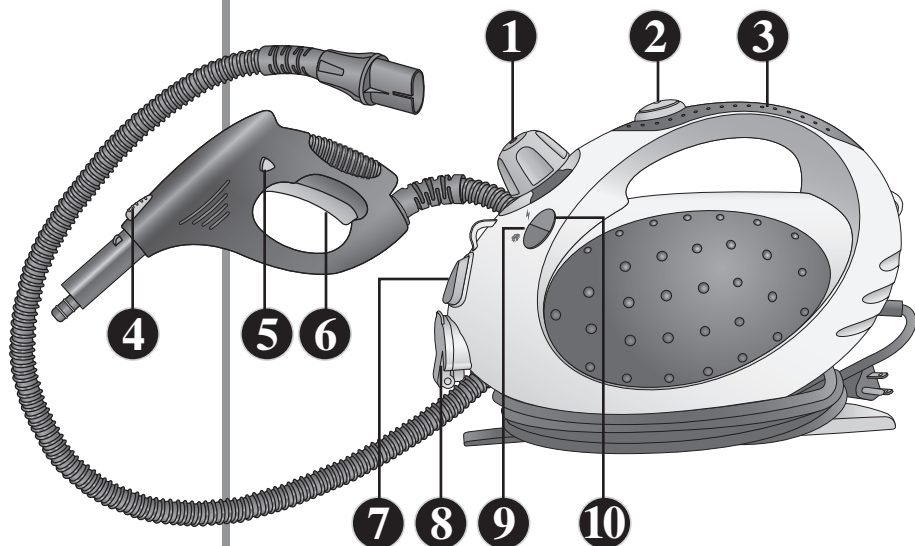

1. Filler Cap and Boiler Tank

The filler cap prevents steam from escaping from the boiler tank. The boiler tank holds the water/steam.

2. ON/OFF Button

Turns the steamer on and off.

3. Carrying Handle

Used to carry the steamer and hold during use.

4. Hose handle button

Used to control the direction of the steam and connect the attachments to the steamer.

5. Safety lock button

Used to lock the trigger and prevent accidental release of steam.

6. Steam trigger

Used to apply steam.

7. Hose Release Button

Releases hose.

8. Hose Inlet and Flap

Hose connection location.

9. Thermostat Indicator Light

Illuminates when steamer is turned ON and steam is building up. Turns off when the correct steam temperature has been reached.

10. Power Light

Indicates steamer has been turned ON.

11. Cord Storage Foot

Use to wrap the power cord when storing the Steam-All™ Steamer.

WARNING!



To reduce the risk of personal injury, unplug the power cord from the electrical outlet and let the unit/accessories cool down completely before handling.

Attach the Hose/Handle

1. Pull the hose inlet flap down.
2. Line up the keyway on the hose/handle with the socket of the Steam-All™ Steamer.
3. Push the keyway into the socket.

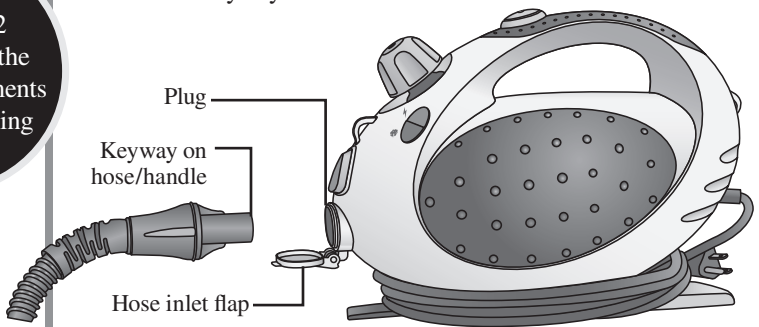

Tip!

See page 12 to determine the correct attachments for your cleaning job.

Attach the Floor Nozzle

1. Position the floor nozzle adaptor so the tube portion is pointing down.
2. Insert floor nozzle adaptor into the floor nozzle and rotate the adaptor so the tube is now pointing up.
3. Pull on the floor nozzle adaptor to make sure it is locked.
4. Place the floor nozzle assembly on the hose/handle, or extension tube until they are locked together. You will hear a click and the yellow interlock should be in the hole on the attachment.

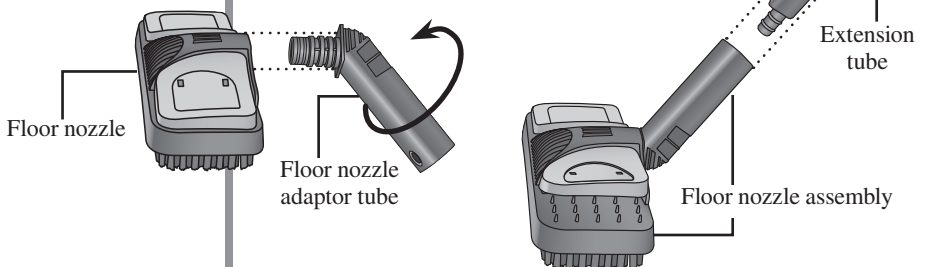

Attaching the Jet Adaptor to Nozzles

Note: The jet adaptor is used when attaching the upholstery nozzle and jet nozzle.

1. Align the keyway on the jet nozzle adaptor so it is lined up with the key in the nozzle.
2. Insert the jet adaptor into the nozzle of choice and rotate so the two are locked together.
3. Insert the assembly into the hose/handle, or extension tube until they are locked together. You will hear a click and the yellow interlock should be in the hole on the attachment.

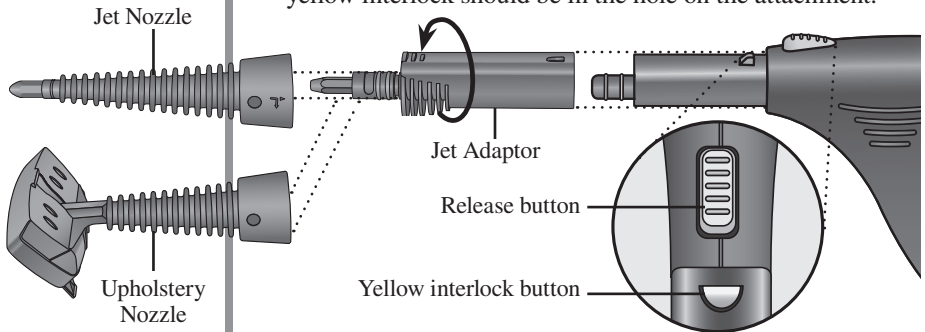

Attaching the Accessories

To attach the window squeegee to the upholstery nozzle:

1. Slide the two tabs on the upholstery nozzle under the two tabs on the window squeegee.
2. Rotate the upholstery nozzle forward until it engages with the front clip of the squeegee.

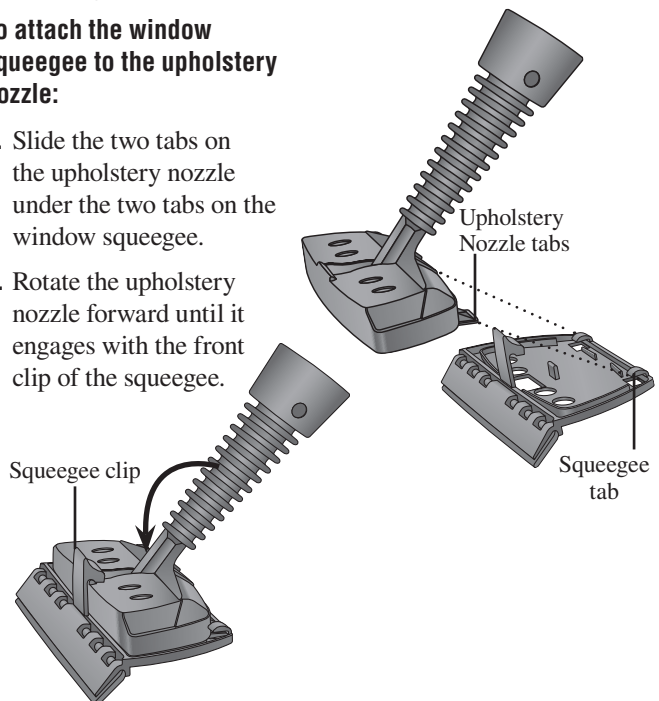

To attach the cotton floor towel to the floor nozzle:

1. Lift the clip on the top of the floor nozzle.
2. Place the cotton towel under clip and release.
3. Repeat steps one and two for the opposite clip on the floor nozzle.

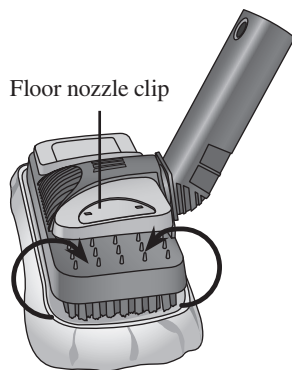

To attach the shoulder strap:

If you would like to use the shoulder strap:

1. Attach the hooks on the strap to the plastic rings on the Steam-All™.
2. Adjust for comfort by sliding the strap length adjuster.

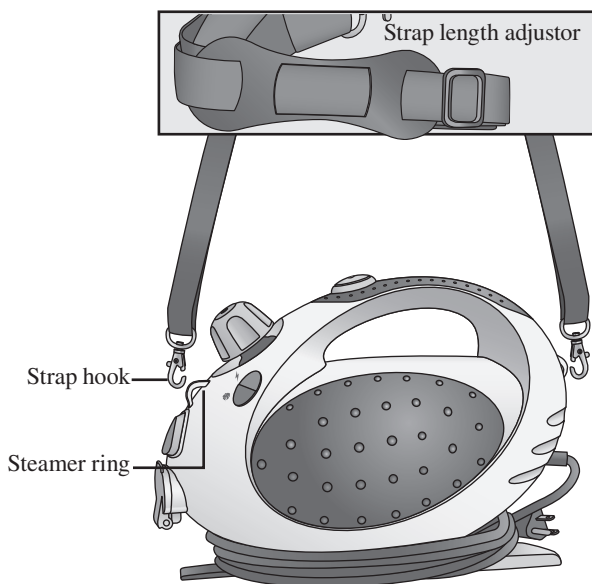

Use

Choose the Attachments

To determine the right tool for the job, you must first choose the correct adaptor, nozzle and accessory.

Adaptors

Extension Tube: Use for additional reach. There are three extension tubes to extend your reach an additional forty inches.

Floor Nozzle Adaptor: Attaches to the Floor Nozzle.

Jet Nozzle Adaptor: Attaches to the Jet Nozzle and Upholstery Nozzle.

Nozzles and Their Accessories

Floor Nozzle

The floor nozzle is used for cleaning large floor areas.

Floor Nozzle Accessories

Cotton Towel: Cleans sensitive surfaces such as sealed wood and linoleum.

Upholstery Nozzle

The upholstery nozzle is used for cleaning cushions, carpets and car seats.

Upholstery Nozzle Accessories

Squeegee: Cleans glass surfaces, mirrors, ceramic tile, and other non-porous surfaces.

Important! Sudden application of excessive heat may shatter glass (see Safety Warning on page 17).

Large Cotton Bonnet: Cleans sensitive surfaces.

Jet Nozzle

Cleans multiple surfaces such as stainless steel and enamel.

Jet Nozzle Accessories:

Brushes: Best for removing stains.

Angled Nozzle: Use for hard to reach areas such as corners, blinds, radiators and toilets.

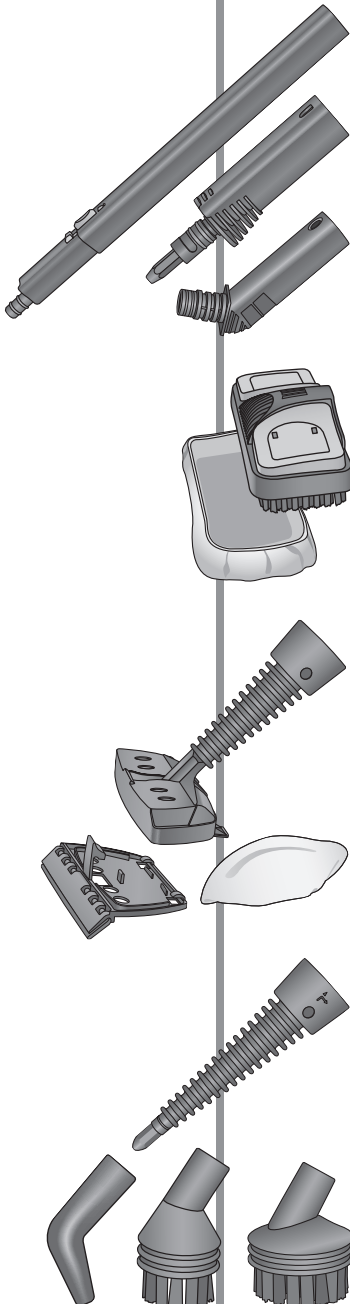

Before You Begin Cleaning

⚠ WARNING!



To reduce the risk of personal injury, unplug the power cord from the electrical outlet and let the unit/accessories cool down completely before handling.



Steam may cause serious injury if in contact with body parts. Always allow the steamer to cool down before handling.

Do not fill the water tank with any thing other than water or Oreck Fresh Air® Steam Mop Essence. Never put additives (such as perfume, stain remover, or products containing alcohol) in the water as they may damage the steam cleaner or make it dangerous to use.

Fill the Boiler Tank

1. Unplug the power cord and remove the filler cap by pressing down and turning it counter-clockwise.
2. Using the measuring cup and funnel, fill the boiler tank. The boiler tank can hold twenty-five fl. oz. (739 ml). Do not overfill.
3. Replace the filler cap on the boiler tank.

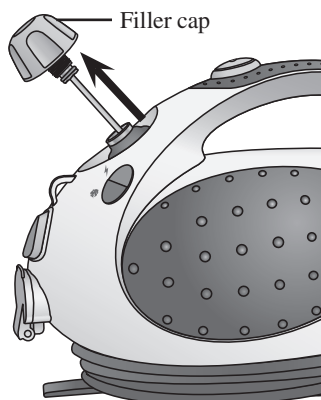

Cleaning Tips

Using warm water will reduce heat-up time and risk of spitting out water during start-up.

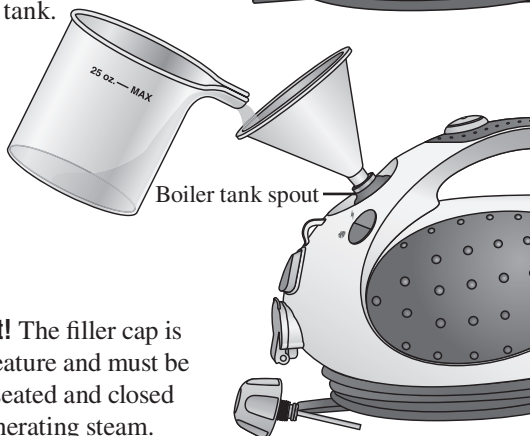

Important! The filler cap is a safety feature and must be properly seated and closed before generating steam.

Refilling the Boiler Tank

⚠ WARNING!



To reduce the risk of personal injury, unplug the power cord from the electrical outlet and let the unit/accessories cool down completely before handling.



Steam may cause serious injury if in contact with body parts. Always release all steam pressure before removing the filler cap.

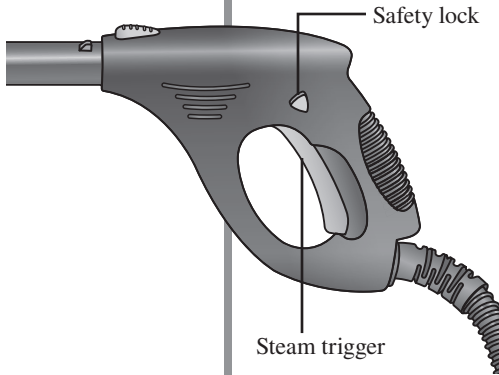

1. Press the steam trigger and release all the steam pressure.
2. Allow the steamer and assembly to cool down.
3. Refill the boiler tank (see Filling the Boiler Tank on page 13).

Important! If the boiler tank is dry, turn the steamer OFF and allow it to cool down until the red indicator on the filler cap has gone back in. It is now safe to refill the boiler tank. Do not attempt to remove the cap when the indicator is pushed out.

Connect the Hose/Handle and Attachments

1. Choose the adaptor, nozzle and accessory needed for your cleaning job.
2. Follow the assembly steps as described on page 9 to assemble the Steamer in the configuration that you need.

Turn the Steamer ON

! WARNING!



Steam may cause serious injury if in contact with body parts. Ensure the filler cap is seated properly and tight, and the safety lock button on the hose handle is engaged before turning the steamer ON.

Always direct the trigger away from the user and away from any bystanders.

Important! The red indicator on the filler cap is a safety device. It will push out when there is steam pressure in the boiler and go back in when it is safe to refill the boiler tank. Do not attempt to remove the cap when the indicator is pushed out. Turning the unit off and depressing the trigger will assist in reducing pressure in the system.

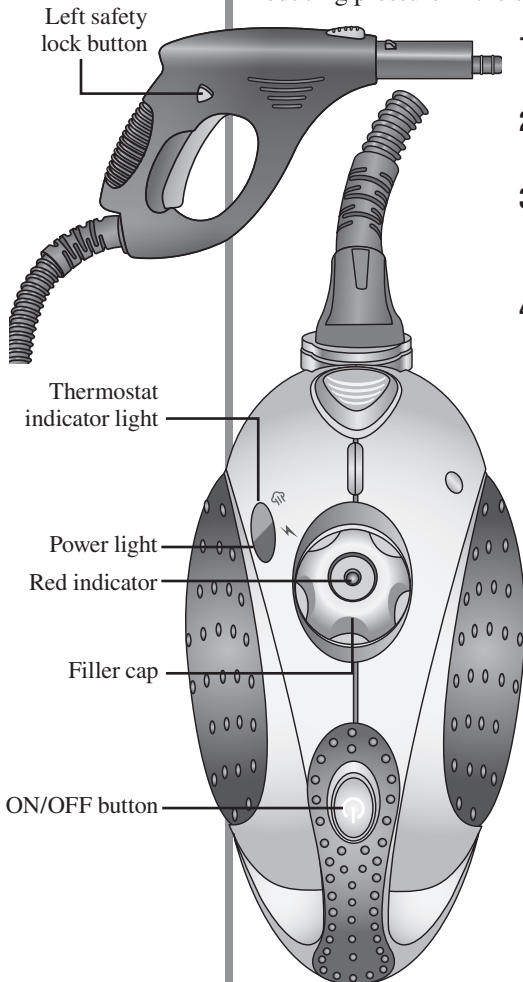

1. Insert the power plug into a polarized electrical outlet.
2. Check the filler cap is seated properly and tight.
3. Engage the trigger lock by pushing the safety lock button on the **left** side of the hose handle.
4. Press down on the ON/OFF button. The power and thermostat indicator will illuminate.

Important! Turning the unit off and depressing the trigger will assist in reducing pressure in the system.

It takes approximately five minutes to reach the correct temperature. The thermostat indicator light turns off when the correct temperature has been reached.

Tip!

Filling the unit with hot water will reduce the preheat time.

Apply Steam

WARNING!



To reduce the risk of personal injury, unplug the power cord from the electrical outlet and let the unit/accessories cool down completely before handling.



Hot water may be ejected at start-up and possibly cause serious injury if in contact with body parts. Always direct the steam into a cloth, bucket or sink until the steam is emitted evenly.

The steam may cause serious injury if in contact with body parts. Never point the steamer at people or pets when in use. Always turn the steamer OFF and unplug when the steamer is not in use.

NOTICE

- Using the steamer on objects or surfaces that cannot resist extreme temperatures (ie: unsealed wooden surfaces, laminates, plastics, delicate materials) may cause damage. Always check with the manufacturer if there is a doubt about using the steamer on a surface or fabric.
- Do not concentrate steam in one place for an extended period of time. This may damage the surface or fabric. Always test a hidden area before using steam on any surface or fabric.

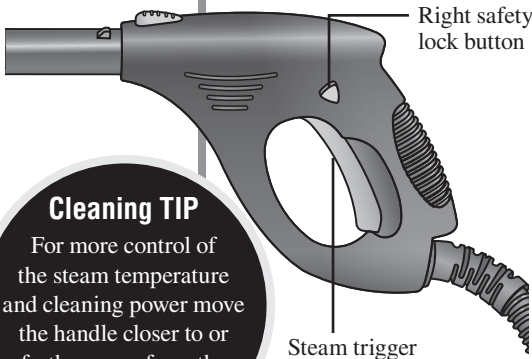

Cleaning TIP

For more control of the steam temperature and cleaning power move the handle closer to or farther away from the surface being cleaned.

1. Disengage the trigger lock by pushing the safety lock button on the right side of the hose handle.
2. Test how the steam will effect the surface or fabric.
3. Press and hold the steam trigger. Direct the steam at the surface to be cleaned. Remove the dirt by moving the steam jet backwards and forwards over the area.
4. Release steam trigger to stop the steam jet.

Cleaning Glass Surfaces

WARNING!

Sudden application of excessive heat may shatter glass and cause serious injury. Always warm glass surfaces gradually when applying steam to the glass.

1. Warm the glass by applying the steam evenly to the glass from a distance of eight to ten inches.
2. Apply steam to clean the glass at a distance of four to six inches.
3. Switch the steam OFF and wipe the moisture off the glass (top to bottom) with the window squeegee.
4. Wipe the squeegee and lower edge of the glass. Dry after each pass.

Bedding and Upholstery

1. Attach the upholstery nozzle.
2. Pass the steam slowly and evenly over the surfaces ensuring all areas are cleaned.
3. Repeat the process in a cross pattern.
4. Allow the mattress or furniture to dry before covering with bedding or covers.

Cleaning TIPS

- To clean very dirty areas move the nozzle slowly across the surface.
- Turn the cloth and change regularly to optimize cleaning power of the cloth.

After Using the Steamer

- 1.** Switch the steamer OFF, unplug the power cord and allow the steamer to cool off.
- 2.** Press the steam trigger and release any steam pressure.
- 3.** Engage the steam safety lock button.
- 4.** Remove the filler cap.
- 5.** Empty the boiler tank and allow the tank to dry before placing the cap back on.
- 6.** Press the hose release button and release the hose.
- 7.** Wrap the cord around the cord storage foot and storage release lever. For quick release of the cord rotate the storage release lever.

Maintenance

Rinsing the Boiler Tank

WARNING!



To reduce the risk of personal injury, unplug the power cord from the electrical outlet and let the unit/accessories cool down completely before handling.

1. Fill the boiler tank with water.
2. Place the filler cap on and shake vigorously to release lime scale deposits on the bottom of the boiler tank.
3. Over a sink, remove the filler cap and pour the water out.

De-scaling the Boiler Tank

WARNING!

Do not fill the water tank with anything other than water or Oreck Fresh Air® Steam Mop Essence. Never put additives (such as perfume, stain remover, or products containing alcohol) in the water as they may damage the steam cleaner or make it dangerous to use.

Do not preheat unit when de-scaling.

User should release pressure with the trigger any time they are cooling and removing the cap.

1. Switch the steamer OFF, unplug the power cord and allow the steamer to cool off.
2. Remove the filler cap and empty the water out.
3. Pour 25 fl. oz. (739 ml) of de-scaler solution into the tank.
4. Place the filler cap back on and swirl the solution around the tank.
5. Let the solution sit for thirty minutes.
6. Empty the solution.
7. Wipe the traces of the solution off the steamer housing.

Troubleshooting

Service problems that appear to be major can often be solved easily. You can be your own troubleshooter by reviewing this guide. All other servicing should be done by an Oreck authorized service center.

Problem	Check	Solution
<ul style="list-style-type: none"> • Unit fails to steam • Heating indicator light does not illuminate, power light is illuminated but unit fails to steam 	<ul style="list-style-type: none"> • Not plugged in properly. • Household circuit breaker/ground fault interrupter has tripped or blown a fuse. 	<ul style="list-style-type: none"> • Be sure cleaner is firmly plugged into wall outlet. • Reset circuit breaker/ground fault interrupter, or replace fuse. If you need assistance contact a licensed electrician.
Thermostat indicator light does illuminate, but unit fails to steam.	<ul style="list-style-type: none"> • Mineral build-up in unit. • Unit may be suffering from internal mechanical problems. 	<ul style="list-style-type: none"> • See <i>De-scaling the Boiler Tank</i> on page 19. • Unplug unit and contact Customer support for repair or replacement assistance.
Steam output is weak or intermittent.	Mineral build-up in unit.	It is normal for the unit to periodically stop steaming for a few seconds. If steam stays off for longer periods, follow the <i>De-scaling the Boiler Tank</i> instructions on page 19.
<ul style="list-style-type: none"> • Excessive gurgling in hose handle. • Water drips from nozzle. 	<ul style="list-style-type: none"> • Water condensation in hose/handle. • Boiler has been overfilled 	<ul style="list-style-type: none"> • Some gurgling is a natural effect of the steaming process. For excessive gurgling or dripping water, point the nozzle towards the ground and shake to remove the excess water. • Empty some water out of the boiler so that it contains no more than 25 oz. of water.

Replacement Parts

All accessories and replacement parts are sold separately. To order, call our customer service group or visit our website. Please have your model number from the data label on the bottom of the unit.

Item	Number
Accessories	
Four cotton floor towels, two cotton bonnets	STEAMKIT200
Replacement Parts	
Steam-All Shoulder Strap	53547-01
Steam-All Extension Tube	53548-01
Steam-All Hose	53549-01
Steam-All Floor Nozzle	53550-01
Steam-All Upholstery Nozzle	53551-01
Steam-All Window Squeegee	53552-01
Steam-All Measuring Cup	53553-01
Steam-All Jet Nozzle	53554-01
Steam-All Funnel	53555-01
Steam-All Jet Nozzle Adaptor	53556-01
Steam-All Large Cleaning Brush	53557-01
Steam-All Small Cleaning Brush	53558-01
Steam-All Angled Nozzle	53559-01

Warranty

Steam-All Canister

ORECK MANUFACTURING COMPANY: (Oreck Manufacturing Company gives you the following limited warranty for this product only if it was originally purchased for residential use, not resale, from Oreck or an Oreck Authorized Retail Dealer.)

Oreck will repair or replace, free of charge, to the original purchaser, any part that is found to be defective in material or workmanship within one (1) year of the date of purchase. This limited warranty applies to normal domestic use. Any commercial use of this product will void this limited warranty.

This limited warranty does not cover the replacement of expendable or consumable parts such as towels, bonnets and other parts subject to normal wear unless they are defective in material or workmanship.

This limited warranty does not apply to any part subjected to accident, abuse, commercial use, alteration, misuse, damage caused by act of God, the use of voltages other than indicated on the serial number displayed on this product or service of this product by other than Oreck or a participating Factory Authorized Service Center. Oreck does not authorize any person or representative to assume or grant any other warranty obligation with the sale of this product.

Oreck's limited warranty is valid only if you retain proof of purchase from Oreck or an Oreck Authorized Retail Dealer for this product. If you purchase this product from any other source, your purchase is "AS IS," which means Oreck grants you no warranty, and that you, not Oreck, assume the entire risk of the quality and performance of this product, including the entire cost of any necessary servicing or repairs of any defects.

Oreck's liability for damages to you for any costs whatsoever arising out of this statement of limited warranty shall be limited to the amount paid for this product at the time of original purchase, and Oreck shall not be liable for any direct, indirect, consequential or incidental damages arising out of the use or inability to use this product. Some states do not allow the exclusion or limitation of incidental or consequential damages, so the above limitation or exclusion may not apply to you.

ALL EXPRESS AND IMPLIED WARRANTIES FOR THIS PRODUCT, INCLUDING IMPLIED WARRANTIES OF MERCHANTABILITY AND FITNESS FOR A PARTICULAR PURPOSE, ARE LIMITED IN DURATION TO THE WARRANTY PERIOD, AND NO WARRANTIES, WHETHER EXPRESS OR IMPLIED, WILL APPLY AFTER THIS PERIOD.

Some states do not allow limitations on the duration of implied warranties, so the above limitation may not apply to you.

This warranty gives you specific legal rights, and you may also have other rights which vary from state to state. If appropriate, see additional information for extended warranty.





ORECK®

ORECK®

© 2010 Oreck Holdings, LLC.

All rights reserved. All marks, text, logo's, product configurations and registered trademarks are owned and used under the authority of Oreck Holdings, LLC

53539-01 REV A 09/10 ECN R-10091

Free Manuals Download Website

<http://myh66.com>

<http://usermanuals.us>

<http://www.somanuals.com>

<http://www.4manuals.cc>

<http://www.manual-lib.com>

<http://www.404manual.com>

<http://www.luxmanual.com>

<http://aubethermostatmanual.com>

Golf course search by state

<http://golfingnear.com>

Email search by domain

<http://emailbydomain.com>

Auto manuals search

<http://auto.somanuals.com>

TV manuals search

<http://tv.somanuals.com>