



Oregon
S C I E N T I F I C

MODEL: EB313HG
USER MANUAL

1. SNOOZE / LIGHT button
2. Weather Forecast & Barometric Trend Area
3. Temperature & Humidity Area
4. Clock / Alarm Area
5. Moon Phase
6. ALARM: view alarm status; set alarm
7. MEM: view current, maximum and minimum temperature / humidity readings
8. MODE: change display / settings
9. + and - : increase or decrease setting.
10. Strap hole
11.  : turn alarm off for 24 hours
12.  : Lock button
13. Table stand / Belt clip
14. Battery compartment
15. °C / °F switch
16. RESET hole

PRODUCT OVERVIEW

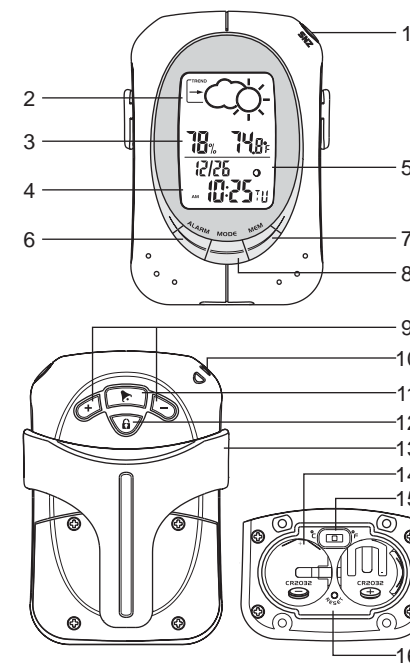



EN

GETTING STARTED

BATTERIES

This unit operates with 2 x CR2032 batteries.

Insert batteries before first use, matching the polarity as shown in the battery compartment.

NOTE  shows the batteries are low.

CHANGE SETTINGS

1. Press and hold MODE for 2 seconds to enter setting mode.
2. Press + or - to change settings.
3. Press MODE to confirm.

TABLE STAND OR BELT CLIP

You can wear the belt clip on your belt or use it as a stand. To use the belt clip as a stand, remove the belt clip from the back of the monitor. Insert the left or right side of the clip into the lower part of the slot then snap the other side of the clip into the other lower slot.

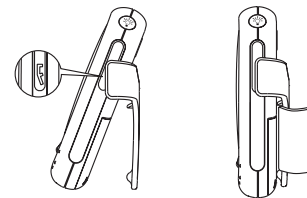

2

CLOCK

This product shows the current time, and day-of-week in English, French, German, Italian, or Spanish.

SET CLOCK

1. Press and hold MODE for 2 seconds. The Clock Area will blink.
2. Select the time zone, hour, minute, year, month, day, and language. Press + or - to change the setting. Press MODE to confirm.

NOTE The language options are (E) English, (F) French, (D) German, (I) Italian, and (S) Spanish.

NOTE The time zone options are (PA) Pacific, (CE) Central, (MO) Mountain, and (EA) Eastern.

SWITCH CLOCK DISPLAY

Press MODE to toggle between Clock with Seconds and Clock with Weekday display.

ALARMS

This product is equipped with a 2-minute alarm.

VIEW ALARM SETTINGS

Press ALARM. The Alarm Time and (()) icon will show in the Clock Area.



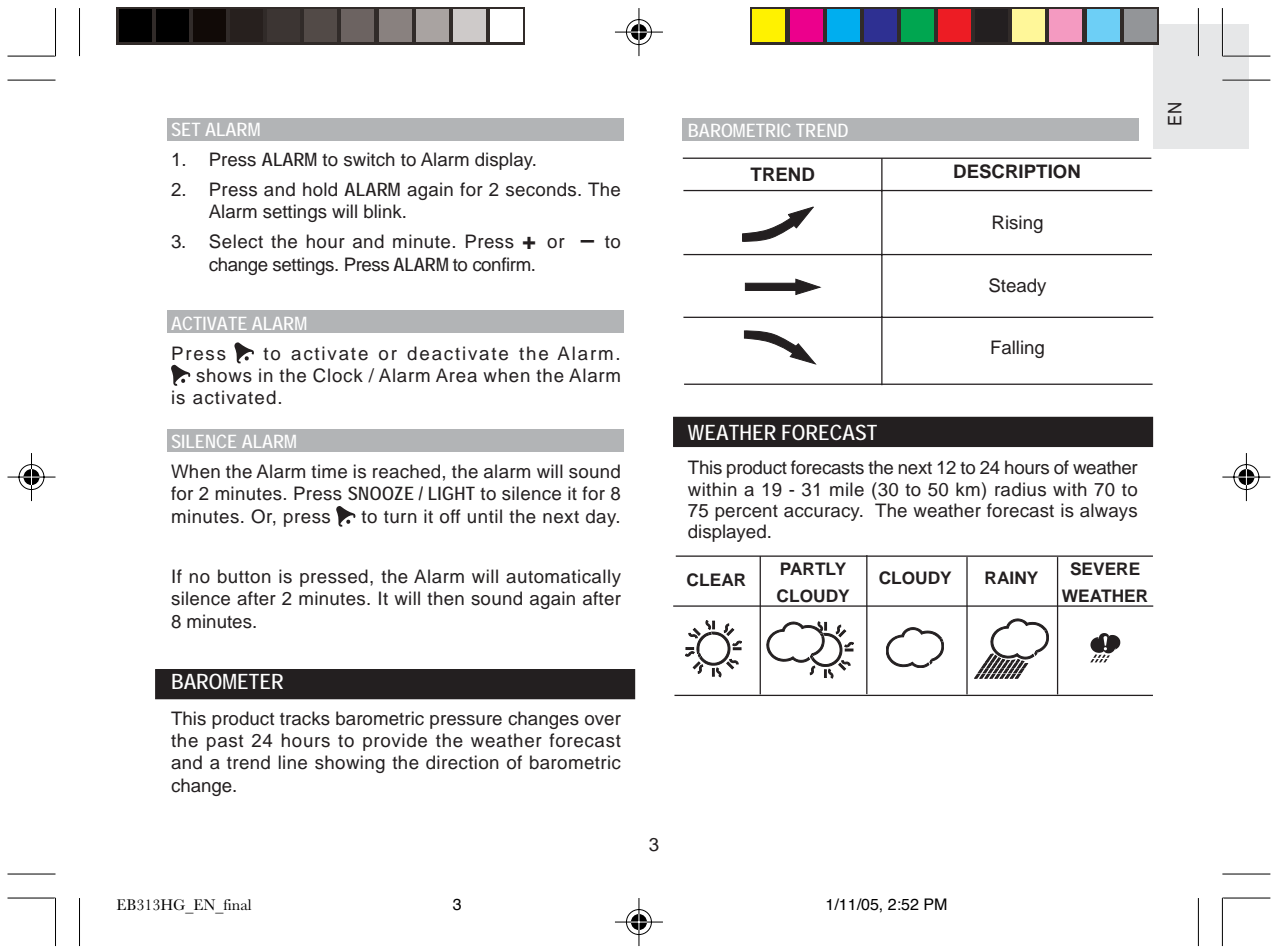

SET ALARM

1. Press ALARM to switch to Alarm display.
2. Press and hold ALARM again for 2 seconds. The Alarm settings will blink.
3. Select the hour and minute. Press + or - to change settings. Press ALARM to confirm.

ACTIVATE ALARM

Press to activate or deactivate the Alarm. shows in the Clock / Alarm Area when the Alarm is activated.

SILENCE ALARM

When the Alarm time is reached, the alarm will sound for 2 minutes. Press SNOOZE / LIGHT to silence it for 8 minutes. Or, press to turn it off until the next day.

If no button is pressed, the Alarm will automatically silence after 2 minutes. It will then sound again after 8 minutes.

BAROMETER

This product tracks barometric pressure changes over the past 24 hours to provide the weather forecast and a trend line showing the direction of barometric change.

BAROMETRIC TREND

TREND	DESCRIPTION
	Rising
	Steady
	Falling

WEATHER FORECAST

This product forecasts the next 12 to 24 hours of weather within a 19 - 31 mile (30 to 50 km) radius with 70 to 75 percent accuracy. The weather forecast is always displayed.

CLEAR	PARTLY CLOUDY	CLOUDY	RAINY	SEVERE WEATHER



EN

TEMPERATURE AND HUMIDITY

This product can display current, minimum, and maximum temperatures and humidity percentage information.

SELECT TEMPERATURE UNIT

Slide the °C / °F switch into the desired location. The switch is located inside battery compartment.

MINIMUM / MAXIMUM RECORDS

Press MEM to toggle between current, maximum (MAX) and minimum (MIN) records. To clear the records, press and hold MEM for 2 seconds. A beep will sound to confirm that the memory has been cleared.

MOON PHASE

The Calendar must be set for this feature to work. Press + or - to view the moon phase for the next or previous day. Press and hold + or - to scan quickly through the years (2001 to 2099).

	New Moon		Full Moon
	Waxing crescent		Waning gibbous
	First quarter		Last quarter
	Waxing gibbous		Waning crescent

4

BACKLIGHT

Press SNOOZE / LIGHT to activate the backlight.

KEY LOCK

The buttons may be locked to avoid accidental changes. To activate lock, press and hold LOCK for two seconds. Repeat the same procedure to unlock buttons.

SPECIFICATIONS

TEMPERATURE

Unit	°C or °F
Temperature Range	-4.0 °F to +14.0 °F- (-20.0 °C to +60.0 °C)
Resolution	0.2° F (0.1 °C)

RELATIVE HUMIDITY

Range	25% to 95%
Resolution	1%

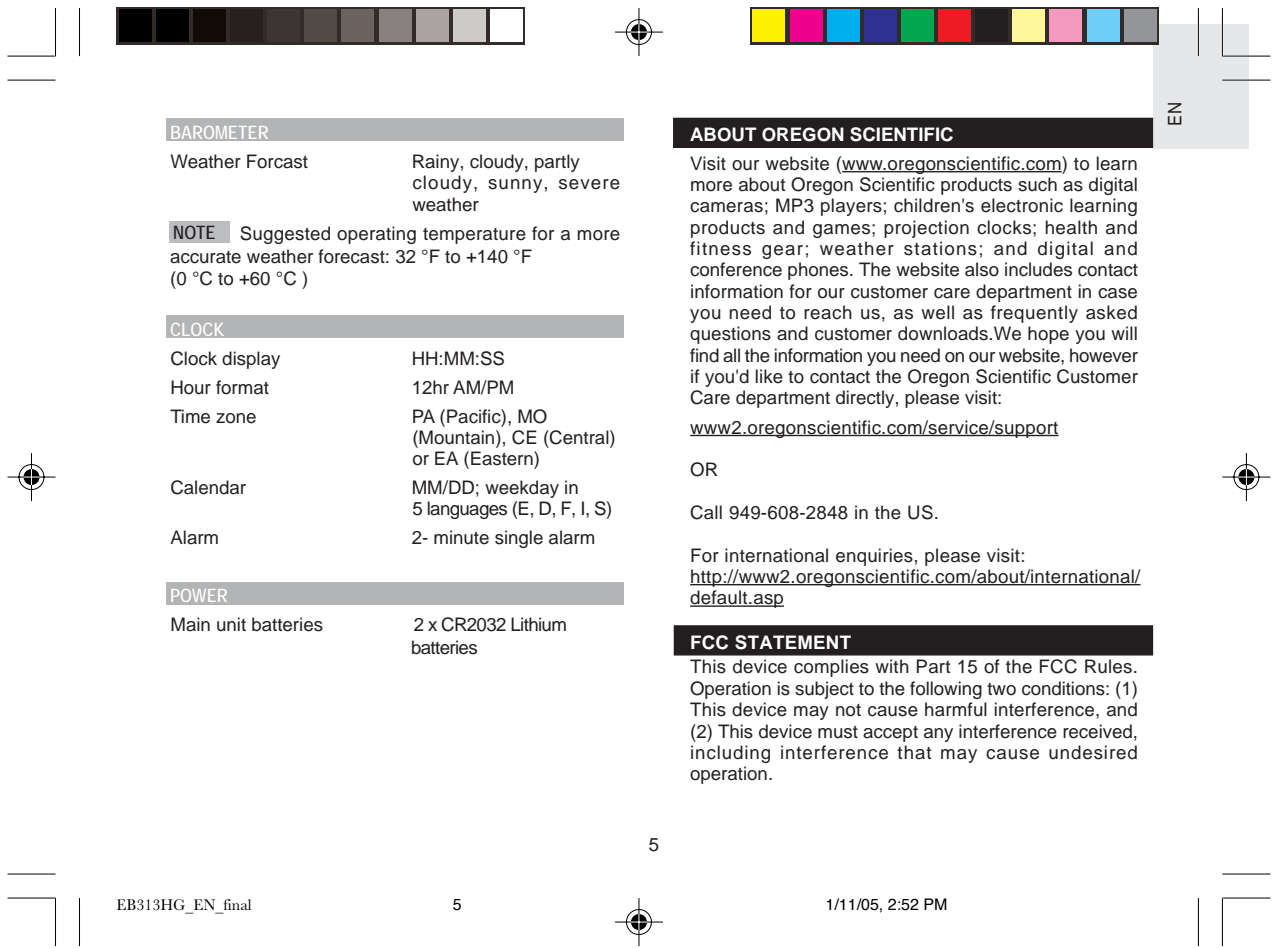

BAROMETER

Weather Forecast Rainy, cloudy, partly cloudy, sunny, severe weather

NOTE Suggested operating temperature for a more accurate weather forecast: 32 °F to +140 °F (0 °C to +60 °C)

CLOCK

Clock display HH:MM:SS
Hour format 12hr AM/PM
Time zone PA (Pacific), MO (Mountain), CE (Central) or EA (Eastern)
Calendar MM/DD; weekday in 5 languages (E, D, F, I, S)
Alarm 2- minute single alarm

POWER

Main unit batteries 2 x CR2032 Lithium batteries

ABOUT OREGON SCIENTIFIC

Visit our website (www.oregonscientific.com) to learn more about Oregon Scientific products such as digital cameras; MP3 players; children's electronic learning products and games; projection clocks; health and fitness gear; weather stations; and digital and conference phones. The website also includes contact information for our customer care department in case you need to reach us, as well as frequently asked questions and customer downloads. We hope you will find all the information you need on our website, however if you'd like to contact the Oregon Scientific Customer Care department directly, please visit:

www2.oregonscientific.com/service/support

OR

Call 949-608-2848 in the US.

For international enquiries, please visit:
<http://www2.oregonscientific.com/about/international/default.asp>

FCC STATEMENT

This device complies with Part 15 of the FCC Rules. Operation is subject to the following two conditions: (1) This device may not cause harmful interference, and (2) This device must accept any interference received, including interference that may cause undesired operation.

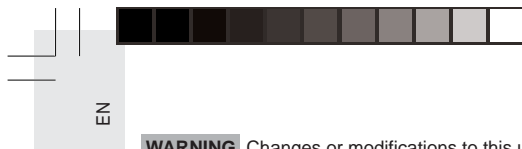

WARNING Changes or modifications to this unit not expressly approved by the party responsible for compliance could void the user's authority to operate the equipment.

NOTE This equipment has been tested and found to comply with the limits for a Class B digital device, pursuant to Part 15 of the FCC Rules. These limits are designed to provide reasonable protection against harmful interference in a residential installation. This equipment generates, uses and can radiate radio frequency energy and, if not installed and used in accordance with the instructions, may cause harmful interference to radio communications. However, there is no guarantee that interference will not occur in a particular installation. If this equipment does cause harmful interference to radio or television reception, which can be determined by turning the equipment off and on, the user is encouraged to try to correct the interference by one or more of the following measures:

- Reorient or relocate the receiving antenna.
- Increase the separation between the equipment and receiver.
- Connect the equipment into an outlet on a circuit different from that to which the receiver is connected.
- Consult the dealer or an experienced radio/TV technician for help.

DECLARATION OF CONFORMITY

The information below is not to be used as contact for support or sales. Please call our customer service number (listed on our website at www.oregonscientific.com, or on the warranty card for this product) for all inquiries instead.

We
 Name: Oregon Scientific, Inc.
 Address: 19861 SW 95th Place,
 Tualatin, Oregon 97062 USA
 Telephone No.: 1-800-853-8883
 Fax No.: 1-503-684-3332

declare that the product
 Product No.: EB313HG
 Product Name: Remote Thermometer
 Manufacturer: IDT Technology Limited
 Address: Block C, 9/F, Kaiser Estate,
 Phase 1, 41 Man Yue St.,
 Hung Hom, Kowloon,
 Hong Kong



is in conformity with Part 15 of the FCC Rules. Operation is subject to the following two conditions:

- 1) This device may not cause harmful interference.
- 2) This device must accept any interference received, including interference that may cause undesired operation.

CAUTION

- The content of this manual is subject to change without further notice.
- Due to printing limitations, the displays shown in this manual may differ from the actual display.
- The contents of this manual may not be reproduced without the permission of the manufacturer.



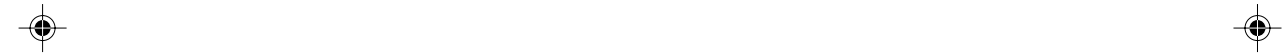

**Handheld Weather Forecaster
Model: EB313HG**

User Manual





© 2005 Oregon Scientific. All Rights Reserved.
086-003462-063

Free Manuals Download Website

<http://myh66.com>

<http://usermanuals.us>

<http://www.somanuals.com>

<http://www.4manuals.cc>

<http://www.manual-lib.com>

<http://www.404manual.com>

<http://www.luxmanual.com>

<http://aubethermostatmanual.com>

Golf course search by state

<http://golfingnear.com>

Email search by domain

<http://emailbydomain.com>

Auto manuals search

<http://auto.somanuals.com>

TV manuals search

<http://tv.somanuals.com>