



Weather Station
Model: BAR626 / BAR626U
User Manual

CONTENTS

Contents	1
Introduction	2
Product Overview	2
Front View	2
Back View	2
LCD Display	3
Remote Sensor (THN122N)	3
Getting Started	4
Batteries	4
Change Settings	4
Table Stand or Wall Mount	4
Remote Sensor (THN122N)	5
Setup Sensor	5
Data Transmission	5
Search for Sensor	5
Clock	6
Turn Clock ON / OFF	6
Set Clock / Calendar	6
Switch Clock Display	6
Alarms	6
View Alarm Settings	6
Set Alarm	6
Activate Alarm	6
Silence Alarm	6
Weather Forecast	7
Temperature	7
Select Temperature Unit	7
Select Channel Number	7
Minimum / Maximum Records	7
Moon Phase	7
Reset System	7
Safety and Care	7
Warnings	8
Troubleshooting	8
Specifications	8
Main Unit Dimensions	8
Remote Sensor Dimensions	8
Temperature	8
Weather Forecast	8
Remote Sensor (THN122N)	8
Clock	9
Power	9
About Oregon Scientific	9
EC-Declaration of Conformity	9

INTRODUCTION

Thank you for selecting the Oregon Scientific® Weather Station (BAR626 / BAR626U). This device bundles precise time keeping, weather forecast, and indoor and outdoor temperature monitoring features into a single tool you can use from the convenience of your home.

In this box, you will find:

- ¥ Main unit
- ¥ Remote sensor (THN122N)
- ¥ Main unit batteries, 3 x UM-3 (AA) 1.5V
- ¥ Remote sensor batteries, 2 x UM-4 (AAA) 1.5V

Keep this manual handy as you use your new product. It contains practical step-by-step instructions, as well as technical specifications and warnings you should know.

PRODUCT OVERVIEW

FRONT VIEW

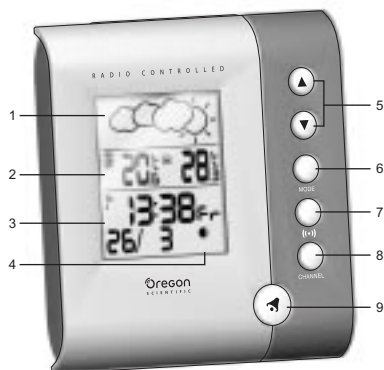

1. Weather Forecast Area
2. Outdoor and Indoor Temperature Area
3. Clock / Alarm / Calendar Area
4. Moon Phase
5. ▲ and ▼ : Increase or decrease setting / activate or deactivate RF Clock
6. **MODE**: Change display / settings
7. ((•)): View alarm status; set alarm
8. **CHANNEL**: Switch remote sensor
9.  : Press to activate or deactivate alarm

BACK VIEW

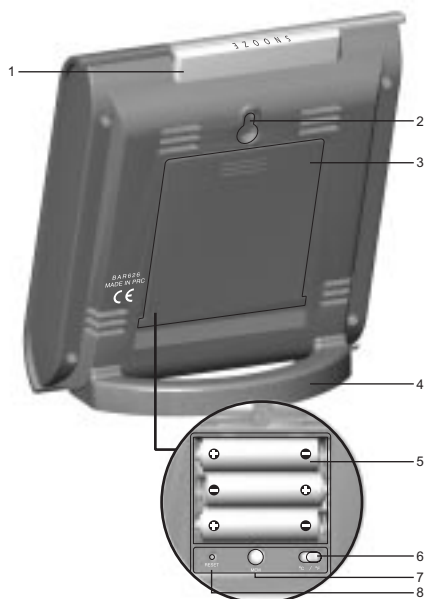

1. **SNOOZE** button
2. Wall mount hole
3. Battery compartment (cover on)
4. Table stand
5. Battery compartment (cover off)
6. °C / °F switch
7. **MEM**: View current, maximum, and minimum temperature readings
8. **RESET** hole

LCD DISPLAY

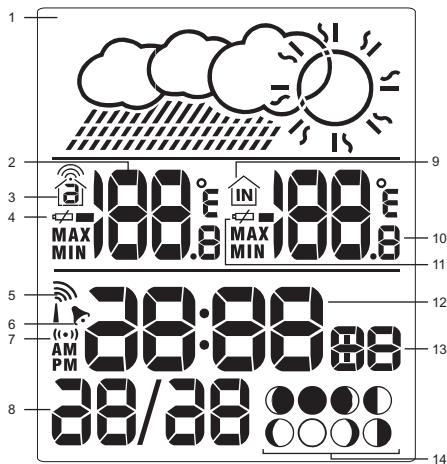

1. Weather display
2. Outdoor temperature
3. Channel icon with sensor signal
4. Low battery icon for sensor
5. Radio Frequency (RF) reception icon
6. Alarm activated
7. Alarm setting
8. Calendar
9. Indoor icon
10. Indoor temperature
11. Low battery icon for main unit
12. Time
13. Day of the week / seconds
14. Moon phase

REMOTE SENSOR (THN122N)

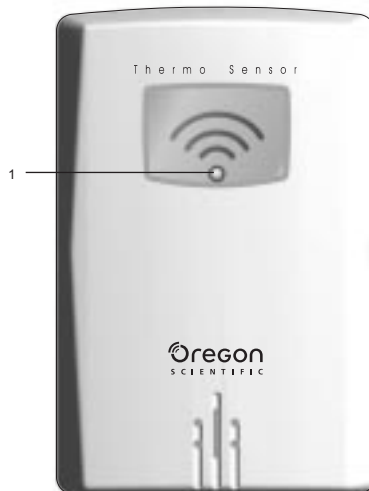

1. LED status indicator

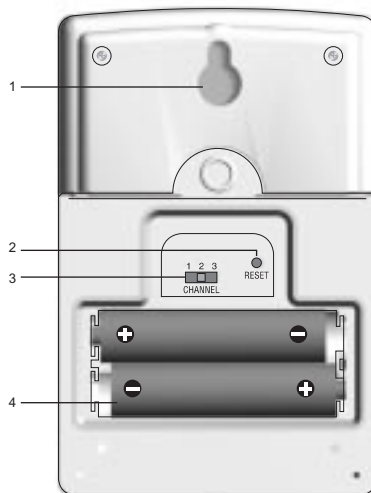

1. Wall mount hole
2. **RESET** hole
3. **CHANNEL** number (1-3)
4. Battery compartment
(Battery compartment cover not shown)

GETTING STARTED

BATTERIES

Batteries are supplied with this product:

Main unit 3 x UM-3 (AA) 1.5V batteries
 Remote unit 2 x UM-4 (AAA) 1.5V batteries

Insert batteries before first use, matching the polarity (+ and -) as shown in the battery compartment. For best results, install batteries in the remote sensor before the main unit. Press **RESET** after each battery change.

NOTE Do not use rechargeable batteries.

 shows when batteries are low.

NOTE It is recommended that you use alkaline batteries with this product for longer performance.

Installing the batteries:

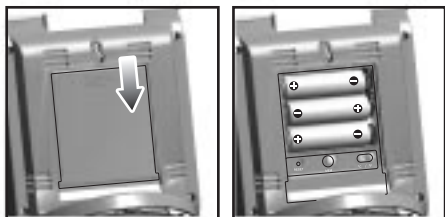

UNIT	LOCATION	
Main	Indoor Temperature Area	
Remote	Outdoor Temperature Area	

CHANGE SETTINGS

To change, time, calendar and language settings:

1. Press and hold **MODE** for 2 seconds to enter setting mode.
2. Press **▲** or **▼** to change settings. (To reach the setting you want quickly, press and hold **▲** or **▼**.)
3. Press **MODE** to confirm.

TABLE STAND OR WALL MOUNT

Use the stand on the back of the main unit / remote sensor, or mount it on a wall with a nail.

Attaching the stand:

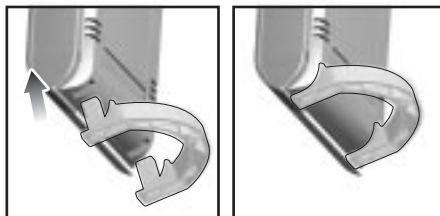

Using the wall mount:

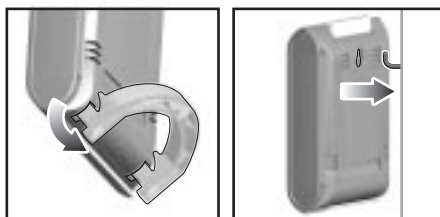

Using the remote sensor stand or wall mount:

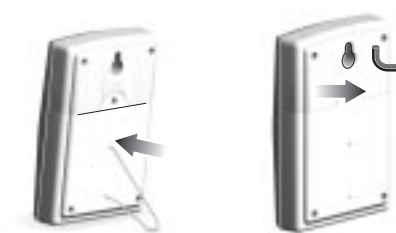

REMOTE SENSOR (THN122N)

This product is shipped with a THN122N Thermometer Sensor that collects Temperature data. Data can be collected from up to 3 sensors. Additional sensors sold separately.

SETUP SENSOR

1. Open the remote sensor battery compartment with a small Phillips screwdriver.
2. Insert the batteries, matching the polarity (+ and -) as shown in the battery compartment.

SWITCH	OPTION
Channel	Channel 1-3. If you are using more than one sensor, select a different channel for each sensor.

3. Set the channel. The switch is located in the battery compartment.
4. Place the sensor near the main unit. Press **RESET** on the sensor. Then, press and hold **MEM** and **CHANNEL** on the main unit to initiate signal sending between the sensor and the main unit. The reception icon on the main unit will blink for approximately 3 minutes while it is searching for the sensor. (Refer to the Data Transmission section for more information.)
5. Close the remote sensor battery compartment.
6. Secure the sensor in the desired location using the wall mount or table stand.

Installing the batteries:

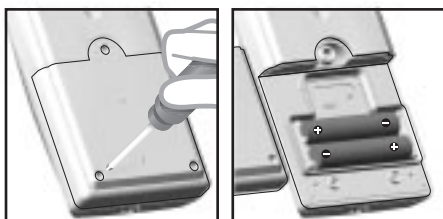

For best results:

- ✘ Insert the batteries and select the channel before you mount the sensor.
- ✘ Place the sensor out of direct sunlight and moisture.
- ✘ Do not place the sensor more than 30 metres (98 feet) from the main (indoor) unit.
- ✘ Position the sensor so that it faces the main (indoor) unit, minimizing obstructions such as doors, walls, and furniture.

- ✘ Place the sensor in a location with a clear view to the sky, away from metallic or electronic objects.
- ✘ Position the sensor close to the main unit during cold winter months as below-freezing temperatures may affect battery performance and signal transmission.

You may need to experiment with various locations to get the best results.

DATA TRANSMISSION

Data is sent from the sensor(s) every 40 seconds. The reception icon shown in the Temperature Area shows the status.

ICON	DESCRIPTION
	Main unit is searching for sensors.
	At least 1 Channel has been found.
	Channel 1 is selected (number will change depending on the sensor you select).
--- shows in Outdoor Temp Area	The selected sensor cannot be found. Search for the sensor or check batteries.

SEARCH FOR SENSOR

To search for a sensor, press and hold **MEM** and **CHANNEL** (on the main unit) for 2 seconds.

NOTE If the sensor is still not found, check the batteries, obstructions, and remote unit location.



NOTE Signals from household devices such as doorbells, electronic garage doors, and home security systems may cause temporary reception failure. This is normal and does not affect general product performance. The reception will resume once the interference ends.

CLOCK

The clock automatically synchronizes the current time and date when it is brought within range of the radio signal DCF77 generated from Frankfurt, Germany for Central Europe (model BAR626) or MSF60 generated from Rugby, England (model BAR626U).

NOTE The signals are collected by the main unit when it is within 1500 km (932 miles) of a signal.

Initial reception takes 2-10 minutes, and is initiated when you first setup the unit, and whenever you press **RESET**. Once complete, the reception icon will stop blinking. The icon is shown in the Clock Area.

STRONG SIGNAL	WEAK SIGNAL	NO SIGNAL
		

To force a manual search for clock signals, press and hold ▲ for 2 seconds. If no signal is found, check the batteries.

TURN CLOCK ON / OFF

Perform this step if you cannot receive clock signals. Press and hold ▼ for 2 seconds. Then, manually set the clock following the "Set Clock" instructions (below).



The signal icon indicates that the clock feature is ON. No icon means that it is OFF.

SET CLOCK / CALENDAR

You only need to do this if you have disabled the clock feature (for example, if you are too far from or cannot receive a signal).

1. Press and hold **MODE** for 2 seconds. The Clock Area will blink.
2. Select the hour, minute, year, month, day, and day of the week language. Press ▲ or ▼ to change the setting.
3. Press **MODE** to confirm.

The language options are (E) English, (F) French, (D) German, (I) Italian, and (S) Spanish.

SWITCH CLOCK DISPLAY

Press **MODE** to toggle between Clock with Seconds and Clock with Weekday display.

ALARMS

This product is equipped with a 2-minute crescendo alarm.

VIEW ALARM SETTINGS

Press ((•)). The alarm time and alarm status will show in the Clock Area.

SET ALARM

1. Press ((•)) to switch to alarm display.
2. Press and hold ((•)) again for 2 seconds. The alarm settings will blink.
3. Select the hour and minute. Press ▲ or ▼ to change settings. Press ((•)) to confirm.

ACTIVATE ALARM

Press 🔔 to activate or deactivate the alarm. 🔔 shows in the Clock / Alarm Area when the alarm is activated.

SILENCE ALARM

When the alarm time is reached, the crescendo alarm will sound for 2 minutes. To silence the alarm:

¥ Press **SNOOZE** to silence it for 8 minutes.





OR

¥ Press any key except **SNOOZE** to mute the alarm and activate it again after 24 hours.

If no button is pressed, the alarm will automatically silence after 2 minutes. It will then sound again after 8 minutes.

WEATHER FORECAST

This product forecasts the next 12 to 24 hours of weather within a 30-50 km (19-31 mile) radius with 70 to 75 percent accuracy. The weather forecast is always displayed.

SUNNY	PARTLY CLOUDY	CLOUDY	RAINY
			

TEMPERATURE

This product can display current, minimum, and maximum temperature information collected by the remote sensors and main (indoor) unit.

Outdoor data is collected and displayed every 40 seconds. Indoor data is collected and displayed every 10 seconds.





SELECT TEMPERATURE UNIT

Slide the °C / °F switch into the desired location. The switch is located in the main unit battery compartment. The setting for the main unit overrides the remote sensor setting.

SELECT CHANNEL NUMBER

Press **CHANNEL** to switch between sensors 1-3.

The icon shows the selected sensor.

KINETIC-WAVE ICON				
Designated Display	Indoor Display	Remote Display Channel 1	Remote Display Channel 2	Remote Display Channel 3

To auto-scan between sensors, press and hold **CHANNEL** for 2 seconds. Each sensor's data will be displayed for 3 seconds. To end auto-scan, press **CHANNEL** or **MEM**.

NOTE For more information on the sensor see "Remote Sensor THN122N" Section.









MINIMUM / MAXIMUM RECORDS

The **MEM** button is located in the main unit battery compartment. Press **MEM** to toggle between current, maximum (MAX) and minimum (MIN) records. To clear the records, press and hold **MEM** for 2 seconds. A beep will sound to confirm that the memory has been cleared.

MOON PHASE

The Calendar must be set for this feature to work, see "Set Clock" section.

- ¥ Press ▲ or ▼ to view the moon phase for the next or previous day.
- ¥ Press and hold ▲ or ▼ to scan quickly through the years (2001 to 2099).

	New Moon
	Waxing Crescent
	First Quarter
	Waxing Gibbous
	Full Moon
	Waning Gibbous
	Last Quarter
	Waning Crescent

RESET SYSTEM

The **RESET** button is located in the main unit battery compartment. Press **RESET** when you change the batteries and whenever performance is not behaving as expected (for example, unable to establish radio frequency link with remote sensor or clock).

SAFETY AND CARE

Clean the product with a slightly damp cloth and alcohol-free, mild detergent. Avoid dropping the product or placing it in a high-traffic location.

WARNINGS

This product is designed to give you years of service if handled properly. Oregon Scientific will not be responsible for any deviations in the usage of the device from those specified in the user instructions or any unapproved alterations or repairs of the product. Observe the following guidelines:

- ⚠ Never immerse the product in water. This can cause electrical shock and damage the product.
- ⚠ Do not subject the main unit to extreme force, shock, or fluctuations in temperature or humidity.
- ⚠ Do not tamper with the internal components.
- ⚠ Do not mix new and old batteries or batteries of different types.
- ⚠ Do not use rechargeable batteries with this product.
- ⚠ Remove the batteries if storing this product for a long period of time.
- ⚠ Do not scratch the LCD display.

NOTE The technical specification of this product and contents of this user guide are subject to change without notice. Images not drawn to scale.

TROUBLESHOOTING

PROBLEM	SYMPTOM	REMEDY
Calendar	Strange date / month	Change language (→6)
Clock	Cannot adjust clock	Disable clock (→6)
	Cannot auto-synchronize the date and time	1. Adjust batteries (→4) 2. Press RESET (→7) 3. Manually activate clock feature (→6)
Temp	Shows "LLL" or "HHH"	Temperature is out-of-range
Remote sensor	Cannot locate remote sensor	Check batteries (→5) Check location (→5)
	Cannot change channel	Check sensors. Only one sensor is working (→5)
	Data does not match main unit	Initiate a manual sensor search (→5)

SPECIFICATIONS

MAIN UNIT DIMENSIONS

L x W x H	116 x 55 x 127 mm (4.6 x 2.2 x 5 inches)
Weight	170 g (5.9 ounces without battery)

REMOTE SENSOR DIMENSIONS

L x W x H	92 x 60 x 20 mm (3.6 x 2.4 x 0.79 inches)
Weight	63 grams (2.22 ounces) without battery

TEMPERATURE

Unit	°C / °F
Indoor range	-5°C to 50°C (23°F to 122°F)
Outdoor range	-20°C to 60°C (-4°F to 140°F)
Resolution	0.1°C (0.2°F)

WEATHER FORECAST

Display	Rainy, cloudy, partly cloudy, sunny
---------	-------------------------------------

REMOTE SENSOR (THN122N)

RF frequency	433 MHz
Range	30 metres (98 feet) with no obstructions
Transmission	Every 40 seconds
Channel No.	1-3

CLOCK

RF Clock	Auto or manual (disabled)
Clock display	HH:MM:SS
Hour format	12hr AM / PM (Model BAR626U) 24hr (Model BAR626)
Calendar	DD / MM; weekday in 5 languages (E, D, F, I, S)
Alarm	Single alarm with 2-minute crescendo and 8-minute Snooze

POWER

Main unit batteries	3 x UM-3 (AA) 1.5V
Sensor batteries	2 x UM-4 (AAA) 1.5V

NOTE It is recommended that you use alkaline batteries with this product for longer performance.

ABOUT OREGON SCIENTIFIC

Visit our website (www.oregonscientific.com) to learn more about Oregon Scientific products such as digital cameras; MP3 players; children's electronic learning products and games; projection clocks; health and fitness gear; weather stations; and digital and conference phones. The website also includes contact information for our customer care department in case you need to reach us, as well as frequently asked questions and customer downloads.

We hope you will find all the information you need on our website, however if you'd like to contact the Oregon Scientific Customer Care department directly, please visit:

www2.oregonscientific.com/service/support

OR

Call 949-608-2848 in the US.

For international enquiries, please visit:

www2.oregonscientific.com/about/international/default.asp

EC-DECLARATION OF CONFORMITY

This product contains the approved transmitter module that complies with the essential requirements of Article 3 of the R&TTE 1999 / 5 / EC Directive, if used as intended and the following standards have been applied:

Safety of information technology equipment
(Article 3.1.a of the R&TTE Directive)

Applied Standard **EN 60950: 2000**

Electromagnetic compatibility
(Article 3.1.b of the R&TTE Directive)

Applied Standards
ETSI EN 301 489-1-3 (Ver.1.4.1): 2002-08

Efficient use of radio frequency spectrum
(Article 3.2 of the R&TTE Directive)

Applied Standards
ETSI EN 300 220-3 (Ver1.1.1): 2000-09

Additional information:



The product herewith complies with the requirements of the Low Voltage Directive 73 / 23 / EC, the EMC Directive 89 / 336 / EC and carries the CE marking accordingly.



Carmelo Cubito
Agrate Brianza (MI) / Italy January 2004
Manufacturer's EU R&TTE Representative



COUNTRIES RTTE APPROVAL COMPLIED

All EC countries, Switzerland 
and Norway 



Easy Weather Station
Model: BAR626/BAR626U
User Manual

Free Manuals Download Website

<http://myh66.com>

<http://usermanuals.us>

<http://www.somanuals.com>

<http://www.4manuals.cc>

<http://www.manual-lib.com>

<http://www.404manual.com>

<http://www.luxmanual.com>

<http://aubethermostatmanual.com>

Golf course search by state

<http://golfingnear.com>

Email search by domain

<http://emailbydomain.com>

Auto manuals search

<http://auto.somanuals.com>

TV manuals search

<http://tv.somanuals.com>