

# TP30

## Amplified Speakerphone



## User Guide

Please keep this user guide for future reference.



General Information .....	2
Installation .....	4
Wall Mounting.....	5
Location of controls .....	6
Basic settings .....	8
Operation.....	9
The Phone Book.....	13
Memory .....	15
Caller ID.....	17

## General Information



**It is very important** that you read the User Guide carefully as it contains detailed information on installation, programming and operational issues which you will need to be aware of to ensure the Phone operates properly. Following is a list of **some** of the important issues and warnings which you need to be aware of.

This is a summary of the important issues you **must still read** the User Guide in full.

- The telephone is designed for indoor use only. Do not install the telephone in areas where there is the risk of an explosion, excessive exposure to smoke, dust, vibrations, chemicals, moisture and heat.
- Do not use your telephone during an electrical thunderstorm as it is possible to get an electric shock. Refer to information contained in Telstra White pages directory.
- The earpiece of the handset may attract small metal objects such as staples and pins. Care should be taken when placing the handset near these items.
- Do not install in damp locations such as a bathroom or laundry, do not expose the unit to direct sunlight.
- This phone is designed for connection to a PSTN telephone line or an analogue extension port of a PBX system. If you connect this device to a digital extension of a PBX, damage may result to the PBX.



The A-Tick symbol indicates that this product complies with all current Australian ACMA standards.

## Notes for operation in New Zealand

The grant of a Telepermit for any item of terminal equipment indicates only that Telecom has accepted that the item complies with the minimum conditions for connection to its network. It indicates no endorsement of the product by Telecom, nor does it provide any sort of warranty. Above all, it provides no assurance that any item will work correctly in all respects with another item of Telepermitted equipment of a different make or model, nor does it imply that any product is compatible with all of Telecom's network services.

This equipment shall not be set to make automatic calls to the Telecom "111" Emergency Service.

This equipment may not provide for the effective hand-over of a call to another device connected to the same line.

This equipment should not be used under any circumstances that may constitute a nuisance to other Telecom Customers.

## REN (RN for New Zealand)

The REN (Ringer Equivalence Number) or (RN) is of significance only if you wish to connect more than 1 telephone to your telephone line. A standard telephone line has a maximum REN capacity of 3 (RN of 5). It is possible to connect 3 devices with a REN of 1 (RN of 1) with no degradation to the product's performance. Exceeding this limit may cause the volume of the ringer in any phone to decrease or not ring at all.

## Installation

### Installing batteries (supplied) in the phone



#### Warnings

**Before opening the battery compartment, make sure the telephone is disconnected from the telephone line.**

**You must install 4 AAA Alkaline batteries (supplied) in the phone base to retain memory and CID information when the telephone is disconnected from the line.**

1. Use a flat-blade screwdriver or tip of a pen to lift and remove the battery compartment door.
2. Insert four AAA batteries into the compartment as indicated by the polarity symbols.
3. Snap the battery compartment door back into place.

When this  symbol appears on the display or the display dims, replace the batteries. **Always use 4 new high quality Alkaline AAA batteries.**

### If you have a Broadband line

If you connect your telephone to a line with a broadband connection, you must connect an in line filter (not supplied) between the telephone socket and your phone base to ensure that your broadband and TP30 will work properly.

If you do not install the filter you will experience interference on the cordless phone and your Broadband may suffer dropouts. Please refer to the user guide of the in line filter for installation.

In a home with broadband, every telephone, fax or answering system must have a in-line filter connected, not just the one at the telephone point that your modem is connected to.

Additional in-line filters can purchase from electronic stores.

### Connecting the telephone

1. Plug one end of the curly cord into the socket on the handset.
2. Plug the other end of the curly cord into the left side of the phone.
3. Plug one end of the telephone line cord into the jack at the back of the base, and the other end into the wall socket.
4. Pick up the handset and listen for dial tone.

## Wall Mounting

### Desk Mounting

Fit the bracket as shown in the illustration. Insert the brackets three tabs into the matching slots on the bottom of the phone and click into place.

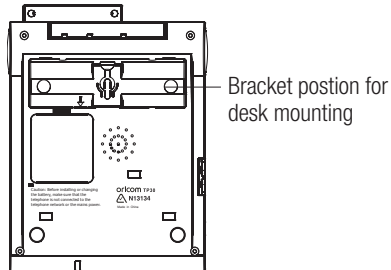

### Wall Mounting

1. Fit the bracket as shown in the illustration. Insert the brackets three tabs into the matching slots on the bottom of the phone and click into place.

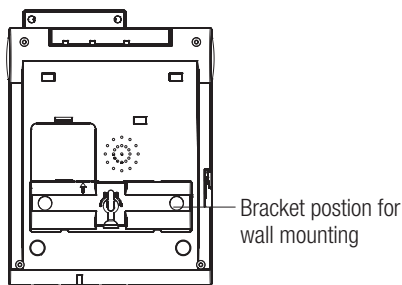

2. Drill two holes vertically, one above the other, 83mm apart, and leave the screws protruding from the wall by 5mm.
3. Turn around the handset hook (located by the hook switch) by 180 degrees, so it will hold the handset in place when the phone is mounted on the wall.
4. Position the mounting holes on the base of the phone over the two protruding screws on the wall plate or on the wall. Gently push the phone flush against the wall plate then slide the phone downwards locking it into place.

# Location of controls

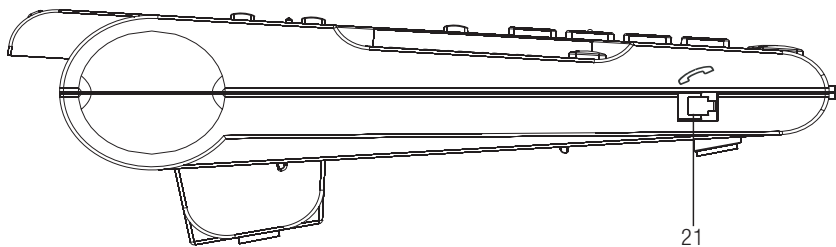
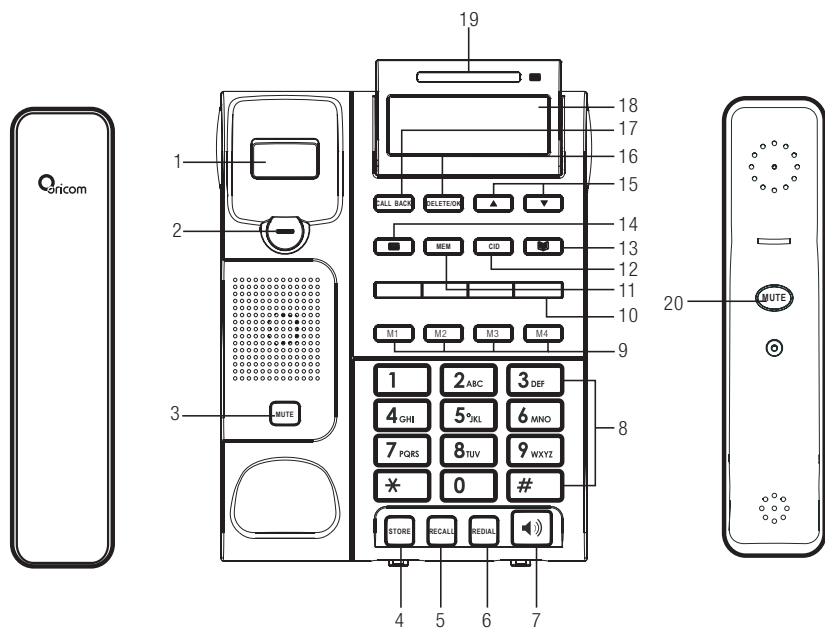



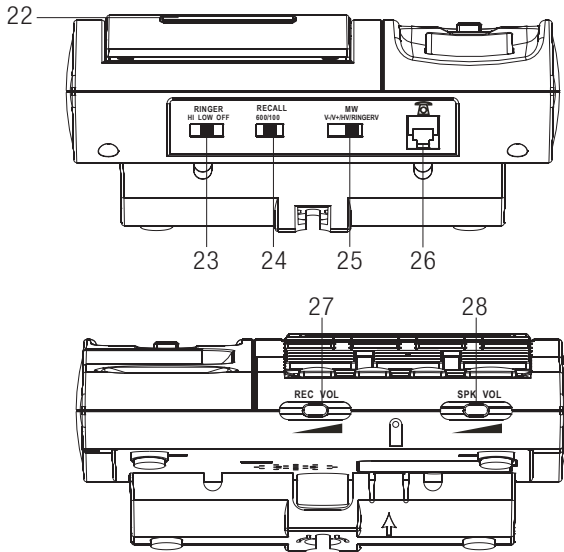

- |                                 |                               |
|---------------------------------|-------------------------------|
| 1. Hook switch                  | 15. ▲/▼ Buttons               |
| 2. Handset hook                 | 16. DELETE/OK button          |
| 3. Mute button                  | 17. Call back button          |
| 4. Store button                 | 18. Display                   |
| 5. Recall button                | 19. Ring LED indicator        |
| 6. Redial button                | 20. Mute button (on handset)  |
| 7. Speakerphone button          | 21. Curly cord socket         |
| 8. Keypad                       | 22. Message Indicator         |
| 9. Memory buttons (M1, 2, 3, 4) | 23. Ringer Hi/Low/Off switch  |
| 10. Memory paper card           | 24. Recall 600/100 switch     |
| 11. MEM button                  | 25. MW V-/V+/HV/Ringer switch |
| 12. Caller ID button            | 26. Telephone line socket     |
| 13. Phonebook button            | 27. Receiver volume           |
| 14. Message button              | 28. Speaker volume            |

### Basic settings

1. After installing the batteries, the display should flash the word ENGLISH.  
If not press and hold ▲ for approximately 4 seconds.
2. Select the desired language using ▲ or ▼. Press **DELETE/OK** button.
3. Select the desired contrast setting (2=Default) using ▲ or ▼.  
Press **DELETE/OK** button.
4. Set the month using ▲ or ▼. Press **DELETE/OK** button.
5. Set the day using ▲ or ▼. Press **DELETE/OK** button.
6. Set the hour (00-23) using ▲ or ▼. Press **DELETE/OK** button.
7. Set the minute using ▲ or ▼. Press **DELETE/OK** button.

### Display(LCD)Contrast/Time Setting

If you wish to change the language, contrast, time settings at a later date, press and hold ▲ button for approximately 4 seconds and repeat steps **2-7** above.

### Select country version

1. For New Zealand Select Recall = 600 on the switch on the rear side of the unit, New Zealand Recall/flash time is 600ms, the unit is now set up to insert 0/00 when receiving CID log in accordance with Telecom NZ requirements. Or for Australia Select Recall = 100.
2. Lift and replace the handset to initialize.



#### **NOTE:**

If the switch is in the incorrect position Caller ID and the recall function will not operate correctly.

## Operation

When the telephone is not in use, the date and time, number of new and total number of calls STORED in the Caller ID MEM will be shown in the display. The display will show the caller number (and name if available).

### Making a call

1. Pick up the handset or press  button (the speaker LED will light) and wait for a dial tone.
2. Dial the number you wish to call. The display will show the number that you are dialling. If you dial a number over 14 digits long, it will show the last 14 digits only.
3. When you have completed your call, hang up the handset or press  button again to release the telephone line.

It is possible to switch from a handset to speakerphone conversation by pressing the  button and picking up or hanging up the handset accordingly.

### Pre Dialing a Call

1. Dial the number you wish to call. To correct a number press the **DELETE/OK** button for each incorrect digit.
2. Pick up the handset or press the  button.

### Receiving a Call



When you receive a call, the telephone rings, the Ringer LED flashes, and the display shows the CALL# and the callers telephone number (with caller id service activated).

This feature allows you to decide to pick up the phone or not depending on who is calling.

## Operation

---

If you want to talk to the caller:

1. Pick up the handset or press  button to answer the call.
2. At the end of the call, return the handset to the cradle or press .

## Redial function

The last number dialled will be saved in the telephone automatically. To use the redial facility, proceed as follows:

1. Lift the handset or press  button .
2. Press the **REDIAL** button. The last saved redial number will now be dialled.

## Pause

If needed for phone banking or behind a PBX system, you can insert a 3.6 second pause while dialing or storing a number into MEM. Press **REDIAL** button at the desired point in number to insert a pause.

## Recall and call waiting

Press the **Recall** button followed by the extension number to transfer calls when connected to a PBX (TBR only).

Access to additional network services can be gained by using the **Recall** button, \* and # keys. Contact your network operator for more information.

The recall button timing can be switched between either 100ms (AUS) / 600ms (NZ), using the **Recall** switch located on the rear side of the handset.

### To Turn on Telstra call waiting (Australia)

You can use the recall button to answer a second call while you are on the phone. However this service will need to be turned on. For example to turn on Telstra's Call Waiting service:

1. Lift the handset and wait for dial tone then Press **\*43#**.
2. You will hear the service message and then hang up.

## Take two different calls at the same time

During a call, you will hear two loud beeps periodically to notify you of another incoming call. If you wish to answer this call

1. Press **Recall** button listen for dial tone then Press **2** to put the current call on hold and talk with the second caller.
2. Subsequent presses of **Recall** button listen for dial tone then Press **2** will toggle you between these 2 callers.

## Ringer Volume Control

The ringer sound level can be adjusted by sliding the **RINGER** switch. Select high (HI) or soft (LOW) sound level. When you do not want to be disturbed, slide the **RINGER** switch to the **OFF** position.

The bright Red light (LED) on the base will flash with all incoming calls.

## Volume Control

### Speaker Volume Control

You can adjust the speaker volume level that suits you by sliding the **SPK VOL** switch.

### Handset Receiver volume control

You can adjust the handset receiver volume level that suits you by sliding the **REC VOL** switch.

### Mute

If you wish to speak privately to someone else in the room without your caller overhearing, press and hold the **MUTE** button on the underside of the handset. you will still be able to hear the callers but they cannot hear you during the mute operation. To resume normal conversation, release the button.

### Message Waiting Indicator

Some PBX systems have a function called Message Waiting. On the back of the telephone is a switch marked (MW/V-/V+/HV/RINGER), this is used to select one of the following options: LED+, LED-, Visual Ring Indicator ( select one of the following options: LED+, LED-, Visual Ring Indicator) and high voltage (HV).

By selecting the appropriate option for your system the telephone will indicate if there are any voice mail messages available.

This function operates differently depending on the PBX system in question therefore please contact your system administrator for more information.

If the unit is not connected through a PBX please select ring indication. please contact your system administrator for more information.

### Hearing Aid Compatibility

This unit is compatible with most inductively coupled hearing aids on the market. However due to the wide range of hearing aids available we cannot guarantee that the TP30 will function error free with every model.

## The Phone Book





The Phone Book will store 32 telephone numbers (22 digits max) and their associated names (16 characters max) with entries arranged alphabetically.

A stored phone number can be dialled using fewer keystrokes than if dialled manually. If you subscribe to a Caller ID service, the name/number of the caller will be shown when you receive an incoming call.

### Storing names/numbers

1. Press .
2. Press **STORE**.
3. Press **STORE** again.
4. Enter the telephone number to be stored (up to 22 digits). Press **STORE**.
5. Enter the name (up to 16 characters). Press the corresponding number button one or more times for the first letter.
6. Press **STORE**.

### Dialling from the Phone Book

1. Press .
2. Scroll to the required memory location using  or . To quick-search in the Phone Book press the corresponding number button one or more times for the first letter.
3. Press **CALL BACK** to dial the displayed number. If you press  the phone will return to standby mode.

### Changing phone numbers/names

1. Press .
2. Scroll to the required memory location using **▲** or **▼**.
3. Press **STORE** EDIT? is displayed. Press **STORE**.
4. Changes to the displayed telephone number can be made using **DELETE/OK**. Press **STORE**.
5. Changes to the displayed name can be made using **DELETE/OK**
6. Press **STORE** to confirm the changes.

### Deleting a phone book entry

1. Press .
2. Scroll to the required memory location using **▲** or **▼**.
3. Press **DELETE/OK**. DELETE will be displayed.
4. Alternatively press and hold **DELETE/OK** button until the display shows **"DELETE ALL"** .
5. Press **DELETE/OK** confirm.



## Memory

The telephone also has 4 one-touch, 10 two-touch memories and a mailbox button for frequently dialled telephone numbers.

When a number is stored into Memory you only press one or two buttons dependent on location to make a call.

The one-touch memories are ☒ (mail box), M1-M4, the two-touch memories are accessed using the telephone keypad digits 0-9.

### Storing One-touch Memories + Mailbox Button

1. Press **STORE** button.
2. Enter the telephone number to be stored (up to 22 digits). Press **STORE** button.
3. Enter the name (up to 16 characters). Press the corresponding number button one or more times for the first letter. Press **STORE** button.
4. "location ?" is display.
5. Press either ☒ (mail box), M1-M4 to store the number.

### Dialling using One-touch Memories

1. Lift the handset or press  button and wait for a dialling tone.
2. Press either ☒ (mail box), M1-M4, the stored telephone number will now be dialled.

### Storing two-touch Memories

1. Press **STORE** button.
2. Enter the telephone number to be stored (up to 22 digits). Press **STORE** button.
3. Enter the name (up to 16 characters). Press the corresponding number button one or more times for the first letter. Press **STORE** button.
4. "location ?" is display.
5. Press either 0-9 to store the number.

### Dialling using Two-touch Memories

1. Lift the handset or press  button and wait for a dialling tone.
2. Press **MEM** button.
3. Select a memory location by pressing the relevant keypad digit 0-9.

## Caller ID



Caller ID allows you to see who is calling before you answer a call and to see who has called in your absence. If the number is stored in the indirect memory, its associated name will be displayed instead. The CID memory will store up to 32 name/telephone numbers stored chronologically. The sequence number is shown in the top right-hand side of the display.

When the memory is full, the oldest number will be deleted automatically as the new call is logged. New calls are indicated in plain text in the display and flashing of the red visual ring indicator light.

### **Please note!**



In order for numbers to be shown, the Caller ID service must be provided by your network operator and a current subscription in place. Contact your telephone service operator for more information.

## Retrieving and dialling CID numbers

1. Press **CID** button to select caller-id mode.
2. Press either ▲ or ▼ to review the numbers stored in the Caller ID memory.
3. To dial a displayed telephone number either press **CALL BACK OR**  button, the displayed telephone number will now be dialled. If you press  button, then the phone will return to standby mode.

## CID Call Types

Besides showing telephone numbers, the display can show a number of messages:

- |   |   |
|---|---|
| <b>OUT OF AREA</b>  | It is an International call or a call from a PBX (no information received). |
| <b>PRIVATE</b>  | Information on the number is blocked. The call could also be from a PBX.    |
| <b>NEW</b>  | Number not previously seen.   |
|  | Several calls have been received from the same caller.                      |
|  | Message waiting   |
| <b>CALL WAITING</b>   | Type II CID   |

## Deleting Numbers

1. Scroll to the telephone number you wish to erase using ▲ or ▼.
2. Press **DELETE/OK** button, "**DELETE/OK**" will be displayed, alternatively press **DELETE/OK** button until the display shows "**DELETE ALL**".
3. Press **DELETE/OK** button confirm.

## Transferring Numbers to the Phone Book

1. Scroll to the telephone number you wish to copy using ▲ or ▼.
2. Press **STORE**. "copy number?" is display.
3. Press **STORE** confirm.

## Warranty Terms and Conditions (Australia)

Oricom makes no other warranties or conditions, express or implied, including as to acceptable quality and fitness for a particular purpose, except as stated in this Warranty. Any implied warranties that may be imposed by law are limited in duration to the Warranty Period. Oricom warrants that the product is free from defects in materials or workmanship during the Warranty Period. This Warranty does not extend to any product from which the serial number has been removed or was purchased outside of Australia.

This warranty in no way affects your statutory warranty rights under the Competition and Consumer Act 2010 or any other similar legislation.

The Warranty Period will be 1 year from the date of purchase of the product evidenced by your dated sales receipt. You are required to provide proof of purchase as a condition of receiving warranty services. You are entitled to a replacement product or repair of the product according to the terms and conditions of this document if your product is found to be faulty within the Warranty Period. This Warranty extends to the original purchaser only and is not transferable.

Batteries or Battery Packs (if supplied) with this product are covered under this warranty for a period of 90 days. Products distributed by Oricom are manufactured using new materials or new and used materials equivalent to new in performance and reliability. Spare parts may be new or equivalent to new. Spare parts are warranted to be free from defects in material or workmanship for thirty (30) days or for the remainder of the Warranty Period of the Oricom branded product in which they are installed, whichever is longer. During the Warranty Period, Oricom will where possible repair and if not replace the faulty product or part thereof. All component parts removed under this Warranty become the property of Oricom. In the unlikely event that your Oricom product has a re curring failure, Oricom may, subject

to the Competition and Consumer Act 2010, at its discretion, elect to provide you with a replacement product of its choosing that is at least equivalent to your product in performance. Oricom does not warrant that the operation of the product will be uninterrupted or error free. Oricom is not responsible for damage that occurs as a result of your failure to follow the instructions that came with the product. These terms and conditions together with any specific terms and conditions contained in the user guide to the product purchased constitute the complete and exclusive agreement between you and Oricom regarding the product. No change to the conditions of this Warranty is valid unless it is made in writing and signed by an authorised representative of Oricom.

Oricom will not be in breach of a warranty expressly set out in this User Guide or under the Competition and Consumer Act 2010 and excludes any liability for damages or any other remedy arising under any other legislation or the common law if the damage occurs as a result of:

- 1 failure by you to adhere to the warnings and follow the instructions set out in this user guide for the proper installation and use of the product;
- 2 negligence on your part or misuse by you of the product;
- 3 an uncontrollable external cause which results in the product not functioning including but not limited to power failure, lightning or over voltage; and
- 4 modification to the product or services carried out on the production by anyone other than Oricom or Oricom's authorised service provider.

Oricom will not be liable for any damages caused by the product or the failure of the product to perform, including any lost profits or savings or special, incidental or consequential damages. Oricom is not liable for any claim made by a third party or made by you on behalf

of a third party. This limitation of liability applies whether damages are sought, or a claim made, under this Warranty or as a tort claim (including negligence and strict product liability), a contract claim or any other claim. However, this limitation of liability will not apply to claims for personal injury. Nothing in this Warranty excludes, restricts or modifies any condition, warranty, right or remedy which pursuant to the Competition and Consumer Act 2010 applies to this Warranty and which may not be so excluded, restricted or modified. For warranties that cannot be excluded, restricted or modified, Oricom limits the remedies available to those specified in the relevant legislation.

## Customer Support

If you have any problems setting up or using this product you will find use-full tips and information in the Troubleshooting section of this user guide as well as “Frequently Asked Questions” on our website [www.oricom.com.au](http://www.oricom.com.au).

If you have further questions about using the product after reviewing the resources above or would like to purchase replacement parts or accessories please call our Customer Support Team. Our dedicated local support team are more likely to be able to help you than the retailer where you made your purchase.

Please retain your purchase receipt and attach to the back page of this user guide as you will need to produce this if warranty service is required.

Take a few moments to register your product online:  
[www.oricom.com.au](http://www.oricom.com.au)

### **Australia**

Oricom International Pty Ltd  
Locked Bag 658  
South Windsor, NSW 2756  
Australia  
Email: [support@oricom.com.au](mailto:support@oricom.com.au)  
Phone: 1300 889 785  
(Monday to Friday 8am to 6pm AEST)  
Web: [www.oricom.com.au](http://www.oricom.com.au)  
Fax: (02) 4574 8898

### **New Zealand**

Email: [support@oricom.co.nz](mailto:support@oricom.co.nz)  
Phone: 0800 674 266  
(Monday to Friday 10am to 7pm  
NZST)  
Web: [www.oricom.co.nz](http://www.oricom.co.nz)





## Free Manuals Download Website

<http://myh66.com>

<http://usermanuals.us>

<http://www.somanuals.com>

<http://www.4manuals.cc>

<http://www.manual-lib.com>

<http://www.404manual.com>

<http://www.luxmanual.com>

<http://aubethermostatmanual.com>

Golf course search by state

<http://golfingnear.com>

Email search by domain

<http://emailbydomain.com>

Auto manuals search

<http://auto.somanuals.com>

TV manuals search

<http://tv.somanuals.com>