

ORION
HIGH PERFORMANCE CAR AUDIO

*subwoofer
owner's manual*

HCCA

10.2 10.4

12.2 12.4

15.2 15.4

POWERED BY HARDCORE ATTITUDE

TABLE OF CONTENTS

Introduction	3
Practice Safe Sound™	3
Installation	3
Tools of the Trade	4
Finding Speaker Mounting Locations	4
Features	4
Re-cone Kit	6
Wiring Configurations	6
Parallel—One Speaker (dual 2 ohm voice coils)	7
Parallel—Two Speakers (dual 4 ohm voice coils)	8
Parallel—One Speaker (dual 4 ohm voice coils)	9
Series-Parallel—Two Speakers (dual 2 ohm voice coils)	10
Series-Parallel—Three Speakers (dual 4 ohm voice coils)	11
Series—One Speaker (dual 2 ohm voice coils)	12
Series-Parallel—Four Speakers (dual 4 ohm voice coils)	13
Series-Parallel—Four Speakers (dual 2 ohm voice coils)	14
2 Amplifiers—One Speaker (dual 2 ohm voice coils)	15
2 Amplifiers—One Speaker (dual 4 ohm voice coils)	16
Enclosure Design	17
HCCA 10.2 & 10.4 Sealed Enclosure Recommendations	18
HCCA 10.2 & 10.4 Vented Enclosure Recommendations	19
HCCA 12.2 & 12.4 Sealed Enclosure Recommendations	20
HCCA 12.2 & 12.4 Vented Enclosure Recommendations	21
HCCA 15.2 & 15.4 Sealed Enclosure Recommendations	22
HCCA 15.2 & 15.4 Vented Enclosure Recommendations	23
Specifications	24
Specifications (Cont'd)	25

INTRODUCTION

Thank you for your purchase of the Orion HCCA SubWoofers. These woofers represent a combination of incredible performance and value. The HCCA series subwoofers feature a massive 4" voice coil and triple stacked magnet assembly to maximize excursion and output. Capable of maintaining their balance at exceptionally high output levels. These high-performance woofers are built with dual 2 or 4 ohm voice coils, to get the most out of your amplifier. They are available in standard 10", 12" and 15" sizes.

We at Orion strive to give you all the latest up to date information about this product. What we can't give you in this manual is personal installation or technical experience. If you have questions concerning the use or application of this product, please refer to the nearest Authorized ORION Dealer for assistance, visit www.orioncaraudio.com, or call the Orion technical support hotline at 1-800-876-0800. As we are always finding new ways to improve our product, the features and specifications are subject to change without notice.

PRACTICE SAFE SOUND™

Continuous exposure to sound pressure levels over 100dB may cause permanent hearing loss. High powered automotive sound systems can generate sound pressure levels in excess of 130dB. When playing your system at high levels, please use hearing protection and prevent long term exposure.

INSTALLATION

The performance of these HCCA subwoofers is directly proportional to the quality of installation. Care taken during the installation process will be rewarded with years of satisfying performance. If you are unsure about your installation capabilities, please refer to your local Authorized Orion Dealer for technical assistance. Orion dealers are trained professionals dedicated to extracting the maximum performance out of your Orion system. If you decide to install this speaker system yourself, please read the entire section on sealed and vented enclosures before starting your installation.

Please Note: Due to the extremely long excursion and high temperature possibilities of this woofer, it is recommended that when the woofer is installed it be positioned so that the cone either faces upward or downward only.

TOOLS OF THE TRADE

Listed are the majority of the tools required to perform the installation. Having the proper tools will make the installation much easier. It is very difficult when you get half way through the installation and discover that you require a specific tool to get yourself through a particular part of the installation. Some of these tools are necessities. Some make the job much easier.

- Marking Pen
- Assorted Drill Bits
- Allen wrenches
- Wire Strippers
- Table saw
- Jig saw
- Electric Drill
- Phillips Screwdriver
- Volt/Ohm Meter (Optional)
- Wire Cutters
- Wire Crimper

FINDING SPEAKER MOUNTING LOCATIONS

Choosing the correct speaker locations will have the greatest effect on the sound quality of the system. There are many different considerations needed when choosing the locations that best suit your needs. The locations must be large enough for the speakers to fit. Care is needed to ensure that the location you have chosen will not affect any of the mechanical or electrical operations of the vehicle.

Determining the best location for the speakers will depend on your cosmetic needs and your vehicle's interior. Usually the woofers are installed in the trunk, rear seat, or rear of the vehicle.

FEATURES

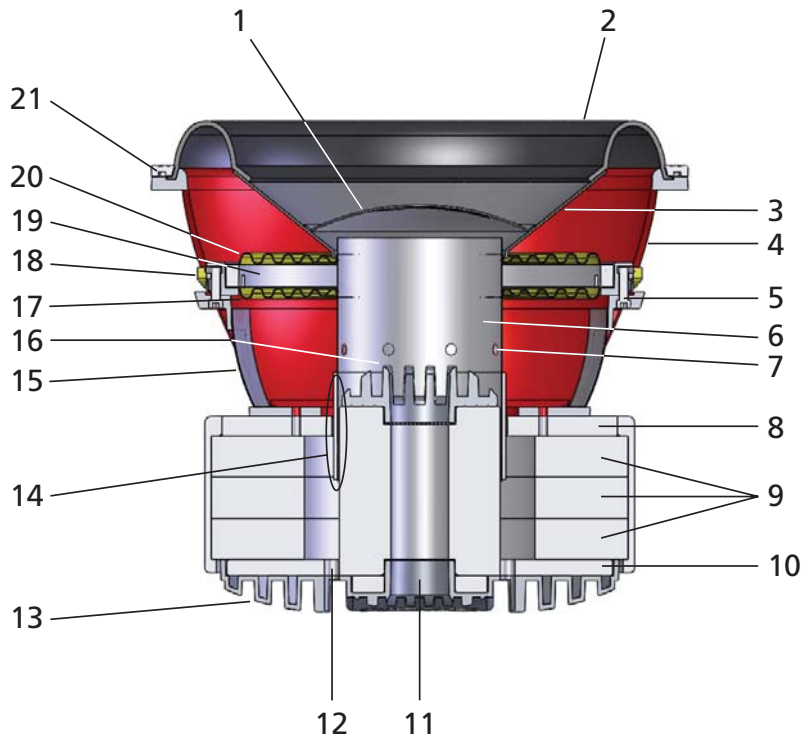

1. Paper dust cap - moisture and UV resistant.	12. Voice coil gap vents. Part of the enhanced voice coil cooling system (forced convection - aluminum heat sinking -shorting rings to reduce inductive heating).
2. Tall, wide, balanced, NBR Foam (high density expanded polyester foam) surround for linear controlled long excursion using a Tri Radius symmetrical edge design optimized on non-linear FEA.	13. Cast aluminum rear pole piece heat sink with fins and vent holes. Part of the enhanced voice coil cooling system (forced convection - aluminum heat sinking).
3. Paper cone - moisture and UV resistant.	14. High temperature (Polyester Amide Amide Resin Coated) Copper clad Aluminum voice coil wound on an aluminum former (10" uses 3" voice coil, 12 & 15 use a 4" voice coil) Dual 2 and 4 ohm voice coils available.
4. Custom Cast Aluminum frame.	15. Screen meshed areas to allow venting below spider to and keep foreign object out of the voice coil gap.
5. Spider ring attachment screws. Part of re-cone feature (8 hex screws).	16. Cast aluminum top pole piece heat sink with fins and vent hole. Part of the enhanced voice coil cooling system (forced convection-aluminum heat sinking-shorting rings to reduce inductive heating).
6. aluminum voice coil former (10" uses 3" voice coil former, 12 & 15 use a 4" voice coil former).	17. Bottom flat interlaced Conex spider with stitched and looped tinsel leads attached.
7. Venting in Voice coil former. Part of the enhanced voice coil cooling system (forced convection).	18. Custom allen head screw terminals. A pair on each side (one pair for each voice coil).
8. 11mm Steel front plate.	19. Spider spacer and spider mounting ring assembly part of field re-cone kit attachment method. (eight allen head screws).
9. Large 3 stack ceramic magnets (10" 264 oz 12/15" 445 oz).	20. Top flat interlaced Conex spider.
10. 11mm Steel back plate / pole piece T yoke assembly.	21. Surround clamp ring, part of field re-cone kit attachment method. (eight allen head screws).
11. 1.25" vent. Part of the enhanced voice coil cooling system (forced convection - aluminum heat sinking - shorting rings to reduce inductive heating).	

RE-CONE KIT

A re-cone kit is available for these speakers and can be obtained from your dealer. The part number for each model is listed below.

Model	Description	Re-cone Kit p/n
HCCA10.2CK	ORION HCCA 10" 2 OHM Re-Cone Kit	27902
HCCA10.4CK	ORION HCCA 10" 4 OHM Re-Cone Kit	27904
HCCA12.2CK	ORION HCCA 12" 2 OHM Re-Cone Kit	27907
HCCA12.4CK	ORION HCCA 12" 4 OHM Re-Cone Kit	27909
HCCA15.2CK	ORION HCCA 15" 2 OHM Re-Cone Kit	27912
HCCA15.4CK	ORION HCCA 15" 4 OHM Re-Cone Kit	27914

WIRING CONFIGURATIONS

The following illustrations provide guidelines on properly connecting your HCCA Orion woofer to an Orion amplifier for maximum power and performance using common parallel, and series/parallel wiring configurations.

Recommended Amplifier Power	
1 woofer	1,200 to 4,000 watts
2 woofers	2,400 to 8,000 watts
3 woofers	3,600 to 12,000 watts
4 woofers	4,800 to 16,000 watts

Parallel—One Speaker (dual 2 ohm voice coils)

One dual 2 ohm voice coil woofer with voice coils in parallel results in a 1 ohm load to the amplifier.

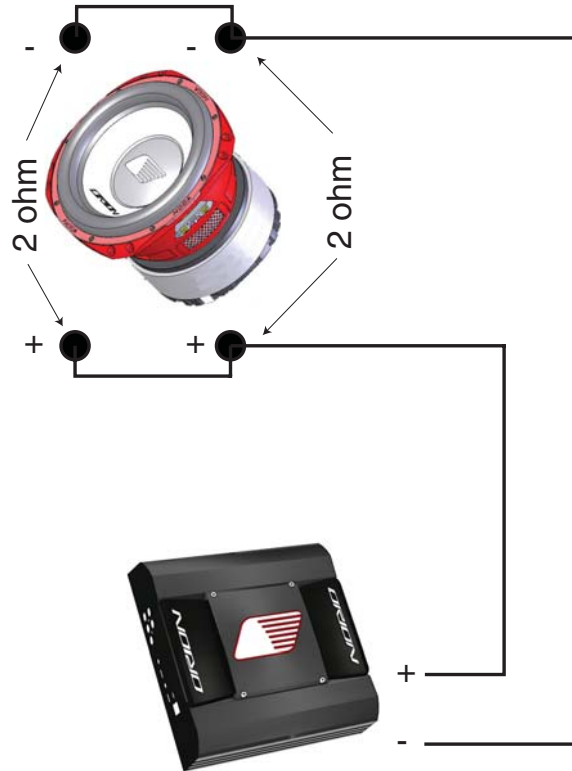

1. Connect the speaker in parallel by connecting the two positive (+) terminals together and the two negative (-) terminals together.
2. Wire the positive (+) terminals of the woofer to the positive (+) terminal on the amplifier. Wire the negative (-) terminals of the woofer to the negative (-) terminal on the amp

Parallel—Two Speakers (dual 4 ohm voice coils)

Two dual 4 ohm voice coil woofers with voice coils in parallel and the two woofers in parallel results in a 1 ohm load to the amplifier.

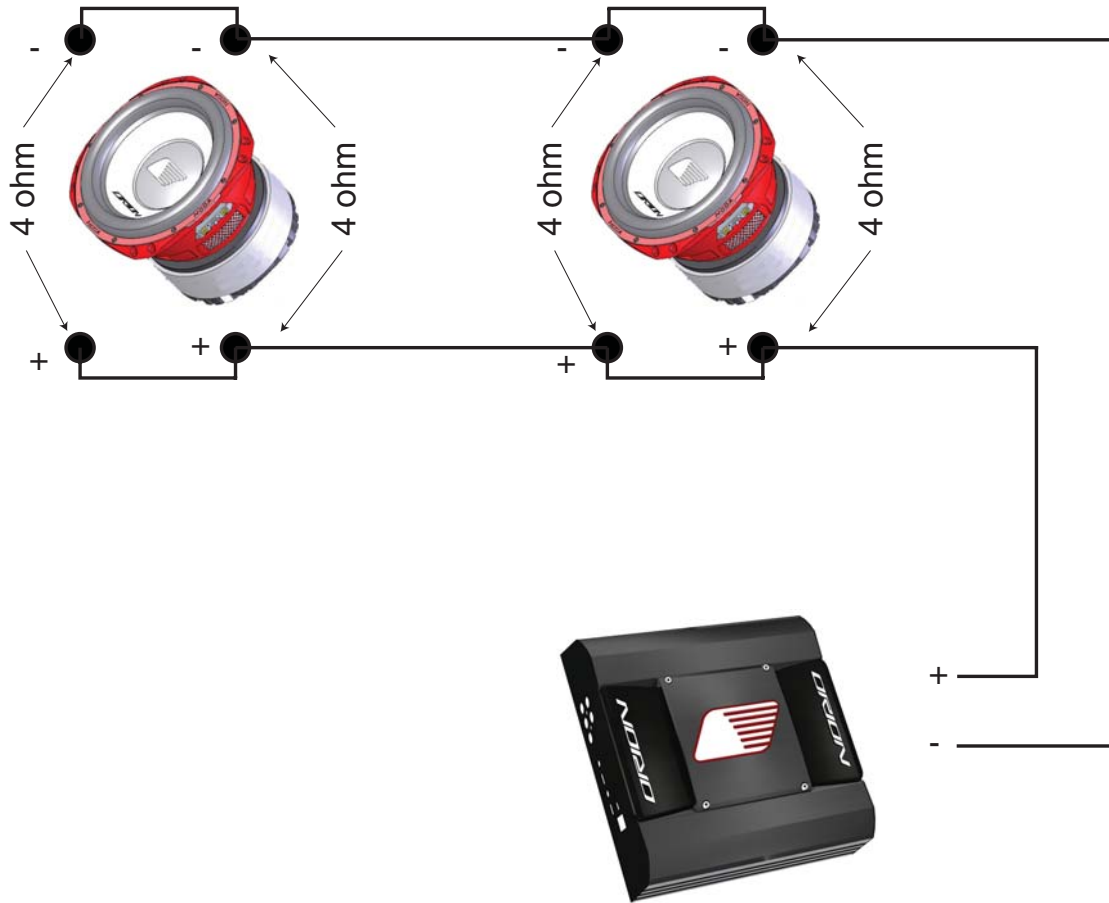

1. Connect the speaker in parallel by connecting the four positive (+) terminals together and the four negative (-) terminals together.
2. Wire the positive (+) terminals of the woofers to the positive (+) terminal on the amplifier. Wire the negative (-) terminals of the woofers to the negative (-) terminal on the amplifier.

Parallel—One Speaker (dual 4 ohm voice coils)

One dual 4 ohm voice coil woofer with voice coils in parallel results in a 2 ohm load to the amplifier.

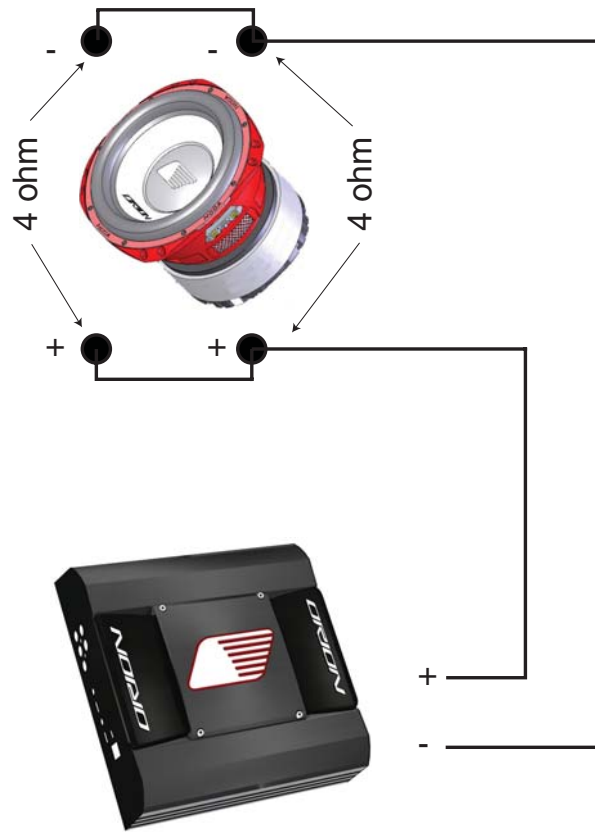

1. Connect the speaker in parallel by connecting the two positive (+) terminals together and the two negative (-) terminals together.
2. Wire both positive (+) terminals of the woofer to the positive (+) terminal on the amplifier. Wire both negative (-) terminals of the woofer to the negative (-) terminal on the amplifier.

Series-Parallel—Two Speakers (dual 2 ohm voice coils)

Note: Verify and ensure that the woofer wiring is connected as shown with the negative connection from the first woofer coil connected to the positive connection of the second woofer coil.

Two dual 2 ohm voice coil woofers with voice coils in series and then parallel the two series woofers results in a 2 ohm load to the amplifier.

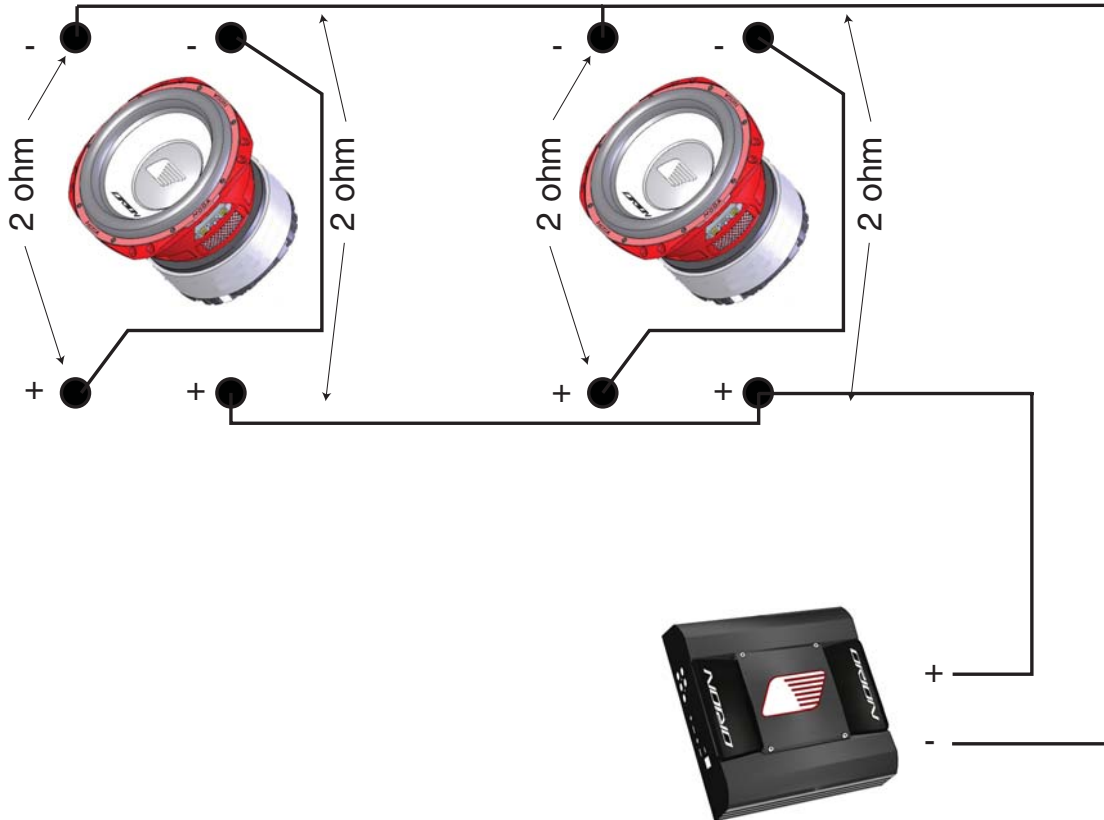

1. Connect each woofer in series by connecting the negative (-) of the first coil to the positive (+) terminal of the second coil.
2. Wire the positive (+) terminal of the first coil on each woofer to the positive (+) terminal on the amplifier. Wire the negative (-) terminal of the second coil on each woofer to the negative (-) terminal on the amplifier.

Series-Parallel—Three Speakers (dual 4 ohm voice coils)

Note: Verify and ensure that the woofer wiring is connected as shown with the negative connection from the first woofer coil connected to the positive connection of the second woofer coil.

Three dual 4 ohm voice coil woofer with voice coils of each woofer wired in series and then parallel the three woofers for a resulting 2.67 ohms load to the amplifier.

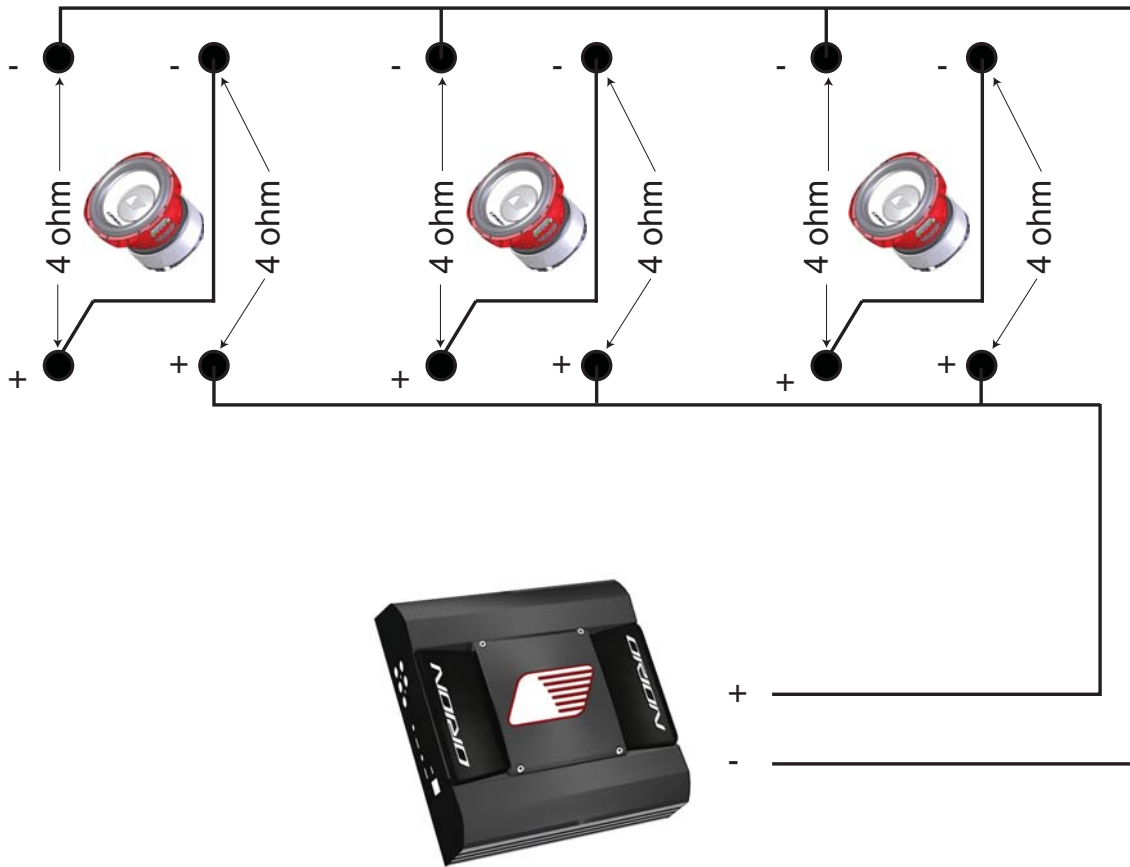

1. Connect each woofer in series by connecting the negative (-) of the first coil to the positive (+) terminal of the second coil.
2. Wire the positive (+) terminal of each woofer's first coil to the positive (+) terminal on the amplifier. Wire the negative (-) terminal of each woofer's second coil to the negative (-) terminal on the amplifier.

Series—One Speaker (dual 2 ohm voice coils)

One dual 2 ohm voice coil woofer with voice coils in connected in series results in a 4 ohm load to the amplifier.

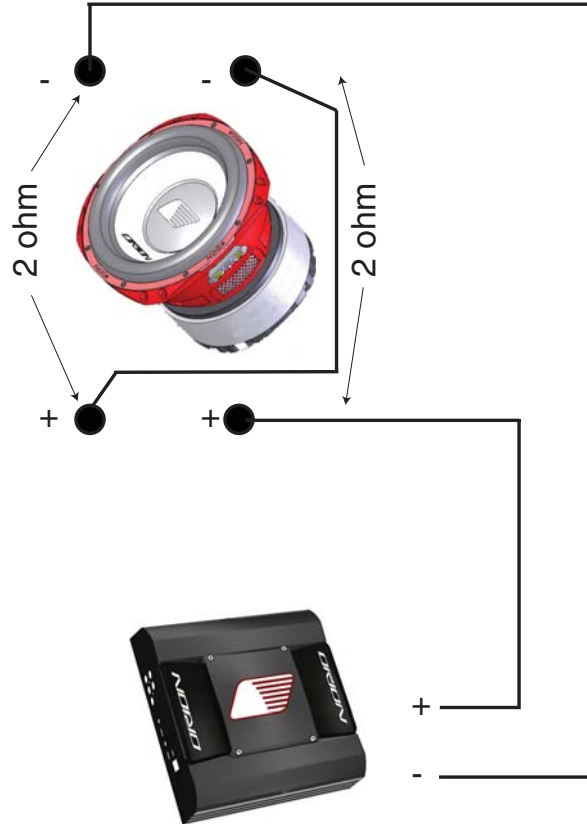

1. Connect the woofer in series by connecting the negative (-) of one terminal to the positive (+) terminal of the other coil.
2. Wire the positive (+) terminal of the first coil to the positive (+) terminal on the amplifier. Wire the negative (-) terminal of the second coil to the negative (-) terminal on the amplifier.

Series-Parallel—Four Speakers (dual 4 ohm voice coils)

Note: Verify and ensure that the woofer wiring is connected as shown with the negative connection from the first woofer coil connected to the positive connection of the second woofer coil.

Four dual 4 ohm voice coil woofers should be wired with the voice coils on each woofer in series and then parallel the four woofers for a resulting 2 ohm load to the amplifier.

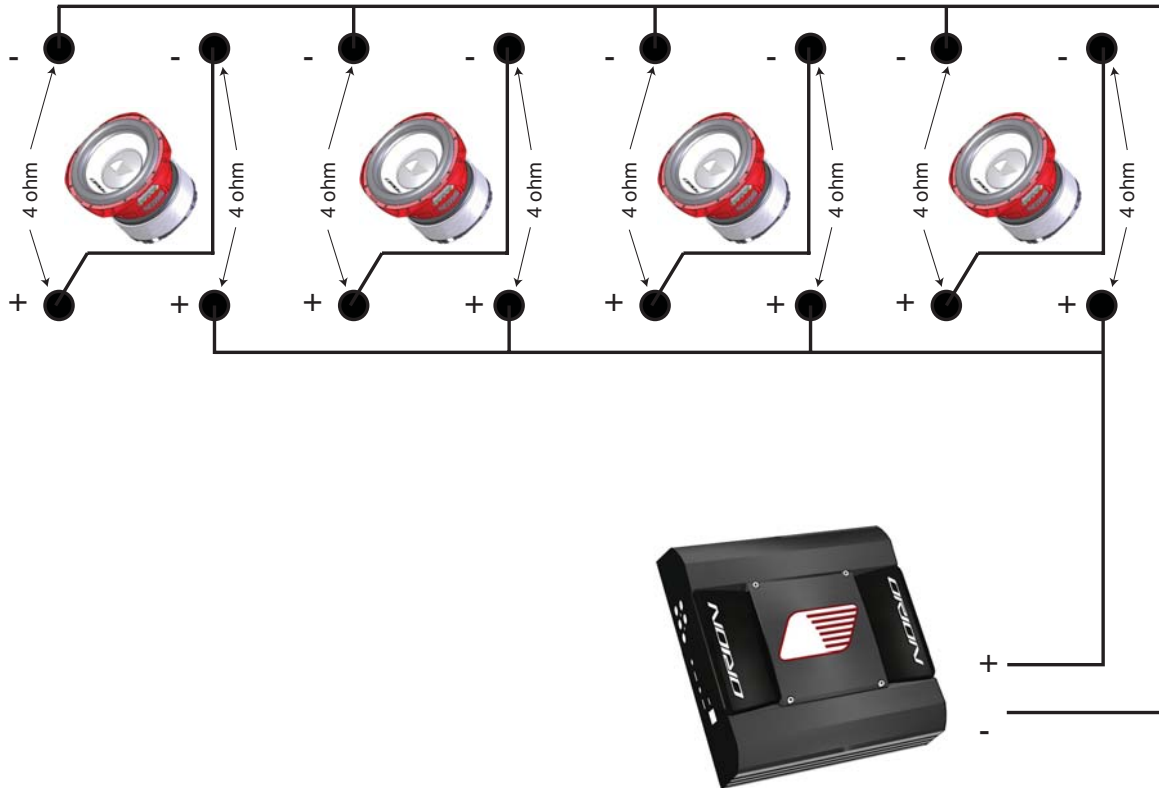

1. Connect each woofer in series by connecting the negative (-) of the first coil to the positive (+) terminal of the second coil.
2. Wire the positive (+) terminals of the first coil of each woofer to the positive (+) terminal on the amplifier. Wire the negative (-) terminal of the second coil of each woofer to the negative (-) terminal on the amplifier.

Series-Parallel—Four Speakers (dual 2 ohm voice coils)

Note: Verify and ensure that the woofer wiring is connected as shown with the negative connection from the first woofer coil connected to the positive connection of the second woofer coil.

Four dual 2 ohm voice coil woofers should be wired with the voice coils on each woofer in series and then parallel the four woofers for a resulting 1 ohm load to the amplifier.

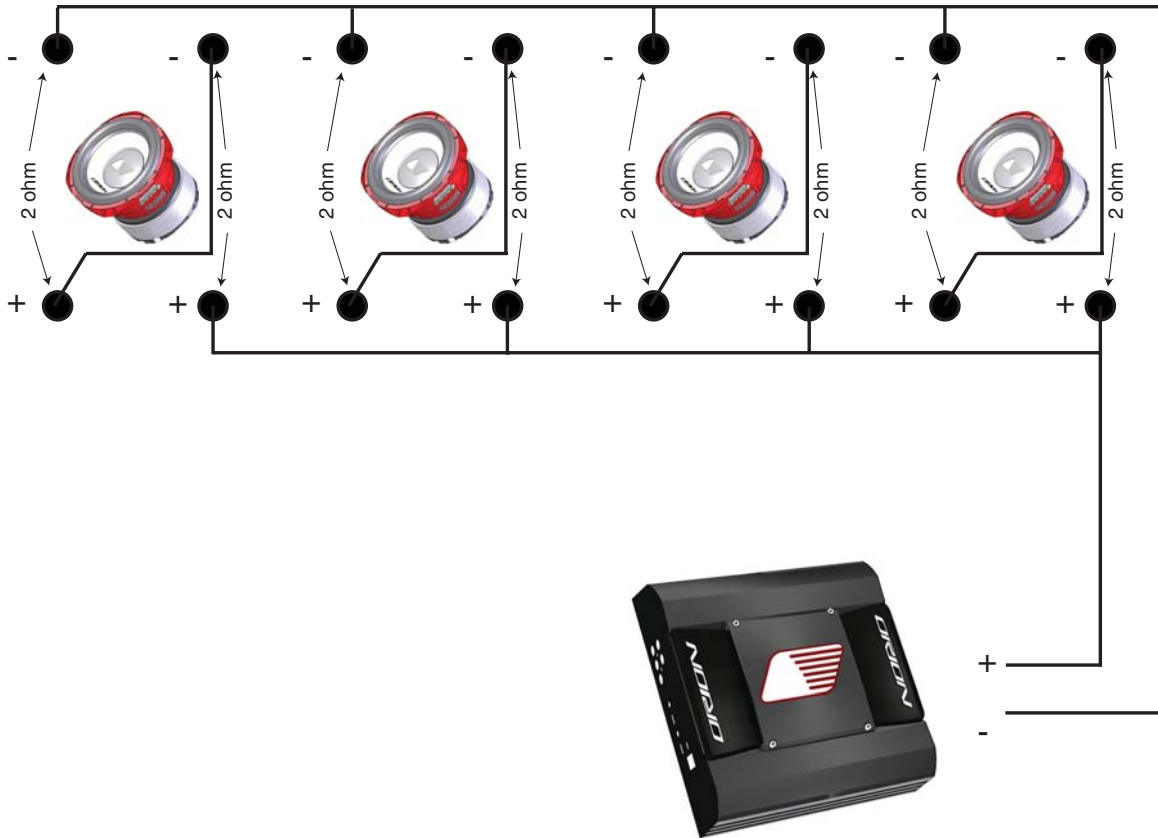

1. Connect each woofer in series by connecting the negative (-) of the first coil to the positive (+) terminal of the second coil.
2. Wire the positive (+) terminals of the first coil of each woofer to the positive (+) terminal on the amplifier. Wire the negative (-) terminal of the second coil of each woofer to the negative (-) terminal on the amplifier.

2 Amplifiers—One Speaker (dual 2 ohm voice coils)

One dual 2 ohm voice coil woofer with each voice coil connected to an individual amplifier, resulting in a 2 ohm load to each amplifier.

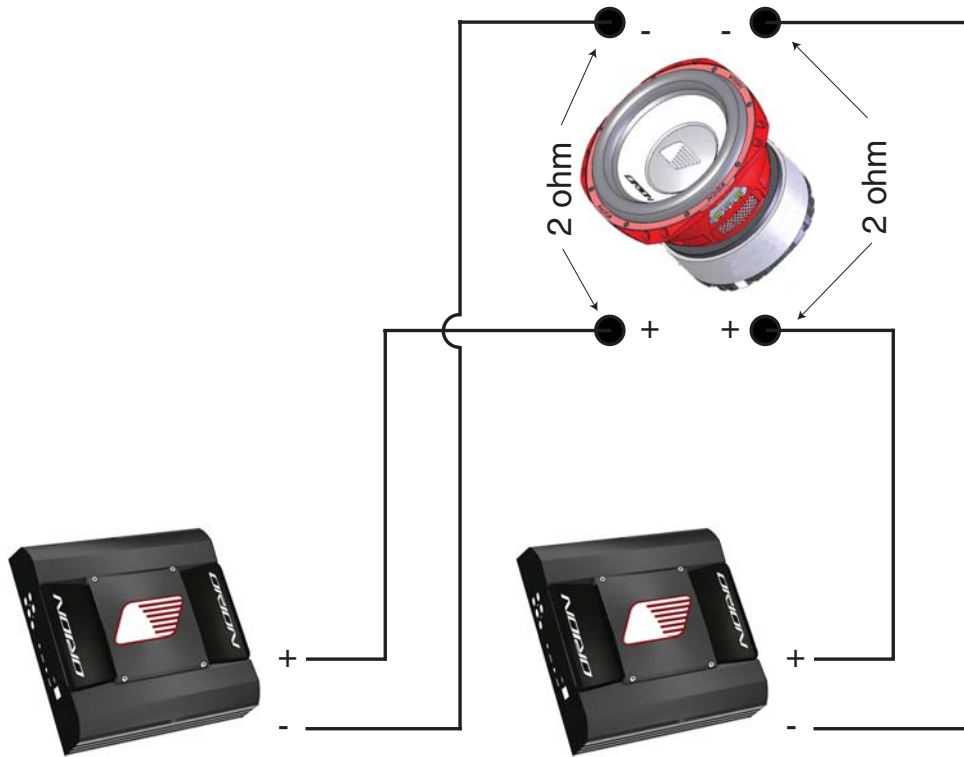

1. Connect one of the speaker's voice coils to the first amplifier by connecting the positive (+) terminal and the negative (-) terminal from the speaker to the respective positive (+) terminal and the negative (-) terminal from the first amplifier.
2. Connect the other of the speaker's voice coils to the second amplifier by connecting the positive (+) terminal and negative (-) terminal from the speaker to the respective positive (+) terminal and the negative (-) terminal from second amplifier.

2 Amplifiers—One Speaker (dual 4 ohm voice coils)

One dual 4 ohm voice coil woofer with each voice coil connected to an individual amplifier, resulting in a 4 ohm load to each amplifier.

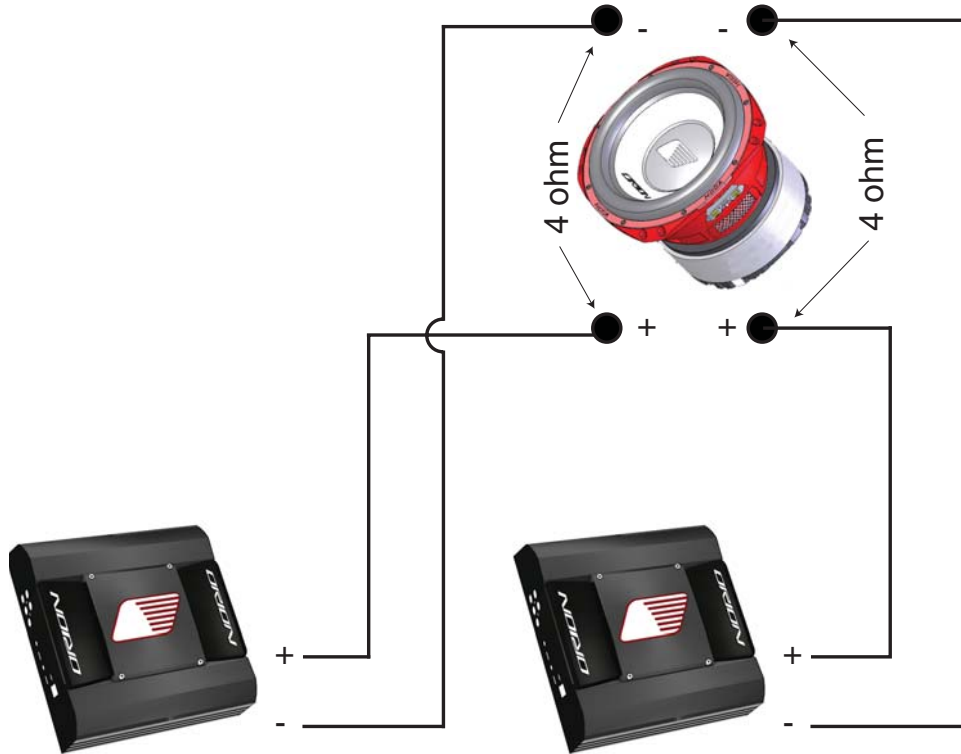

1. Connect one of the speaker's voice coils to the first amplifier by connecting the positive (+) terminal and the negative (-) terminal from the speaker to the respective positive (+) terminal and the negative (-) terminal from the first amplifier.
2. Connect the other of the speaker's voice coils to the second amplifier by connecting the positive (+) terminal and negative (-) terminal from the speaker to the respective positive (+) terminal and the negative (-) terminal from second amplifier.

ENCLOSURE DESIGN

This section gives the basic description for a sealed enclosure. Orion HCCA woofers are designed for sealed enclosures and vented enclosures. Sealed enclosures are generally considered the most versatile for all music types and are the easiest to build. They will also give high power handling with a wider range of frequencies. The enclosure must be absolutely air tight. Use a high quality wood glue for all seams of the enclosure. The enclosure should also be screwed together. The enclosure should be no less than 3/4" on sides. The baffle board (woofer mounting plate) should be no less than 1". If the woofer mounting is to be recessed then a minimum of two 3/4" plates together should be used. As MDF is a porous material it is best to also seal the inside of the enclosure.

NOTE: The woofer must face up or down only, especially in sealed enclosures.

NOTE: Refer to the website www.orioncaraudio.com for updated enclosure data for your woofer application.

HCCA 10.2 & 10.4 Sealed Enclosure Recommendations

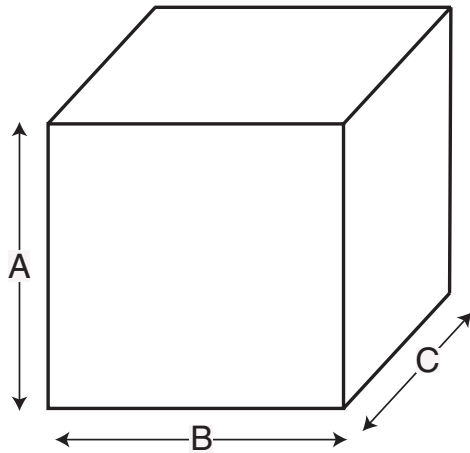

—External Dimensions—

A = 13 in.

B = 13.5 in.

C = 14.5 in.

—Internal Dimensions—

A = 11 in.

B = 11.5 in.

C = 12.5 in.

—Wall Thickness—

All Sides = 1.0 in.

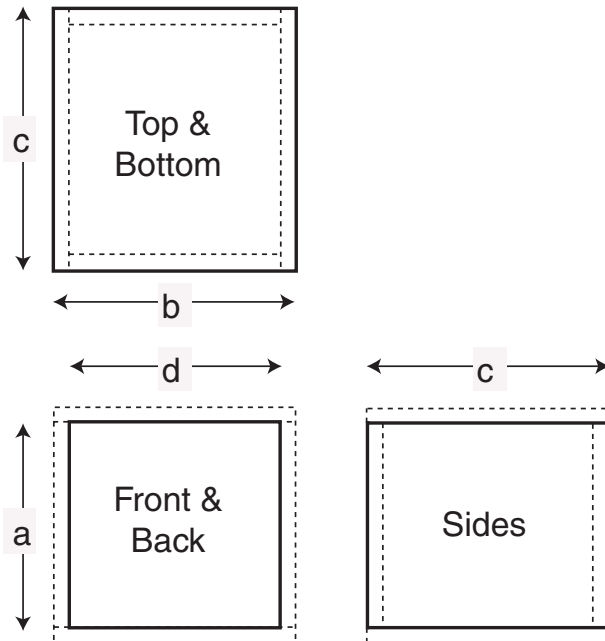

—Box Parts—

Box Shape – Square Prism

1 Top, 1 Bottom

depth (c) = 14.5 in.

width (b) = 13.5 in.

thickness = 1.0 in.

1 Front, 1 Back

height (a) = 11 in.

width (d) = 11.5 in.

thickness = 1.0 in.

2 Sides

height (a) = 11 in.

depth (c) = 14.5 in.

thickness = 1.0 in.

—Driver Mounting—

Front

HCCA 10.2 & 10.4 Vented Enclosure Recommendations

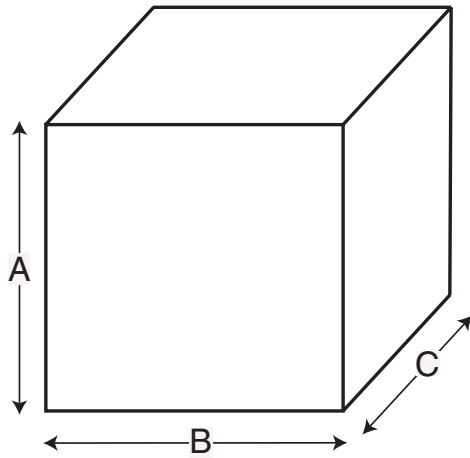

—External Dimensions—

A = 13.5 in.

B = 14.5 in.

C = 15.5 in.

—Internal Dimensions—

A = 11.5 in.

B = 12.5 in.

C = 13.5 in.

—Wall Thickness—

All Sides = 1.0 in.

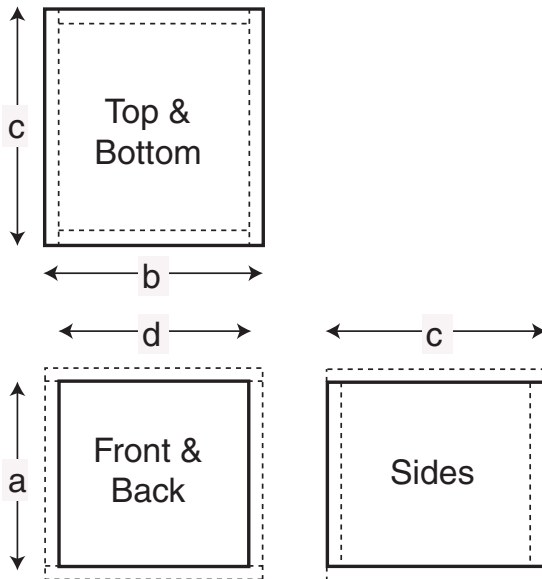

—Box Parts—

Box Shape – Square Prism

1 Top, 1 Bottom

depth (c) = 15.5 in.

width (b) = 14.5 in.

thickness = 1.0 in.

1 Front, 1 Back

height (a) = 11.5 in.

width (d) = 12.5 in.

thickness = 1.0 in.

2 Sides

height (a) = 11.5 in.

depth (c) = 15.5 in.

thickness = 1.0 in.

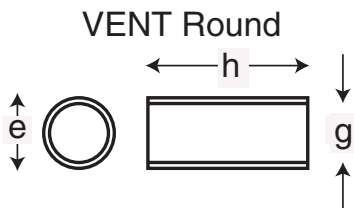

- OR -
VENT Square

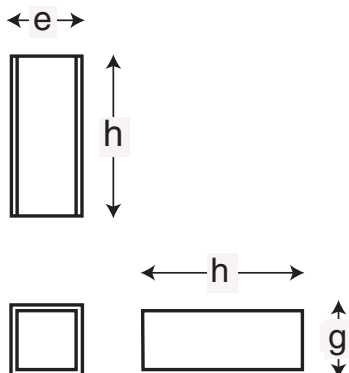

—Driver Mounting—

Front

—Vent Part—Round

outside diameter (e) = 2.75 in.

inside diameter (g) = 2.5 in.

length (h) = 10 in.

—Vent Part—Square

1 Top, 1 Bottom

width (e) = 2.466 in.

length (h) = 10 in.

thickness = 0.125 in.

2 Sides

height (g) = 2.216 in.

length (h) = 10 in.

thickness = 0.125 in.

HCCA 12.2 & 12.4 Sealed Enclosure Recommendations

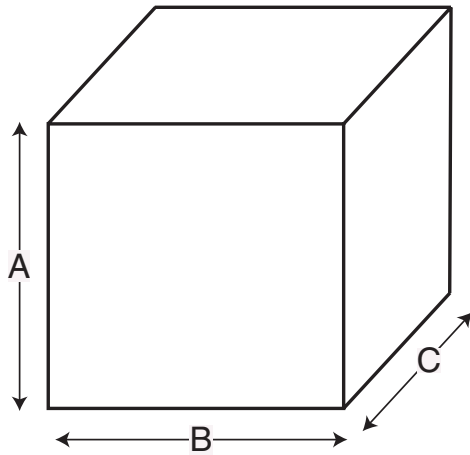

—External Dimensions—

A = 16.5 in.

B = 16 in.

C = 16 in.

—Internal Dimensions—

A = 14 in.

B = 14 in.

C = 14 in.

—Wall Thickness—

All Sides = 1.0 in.

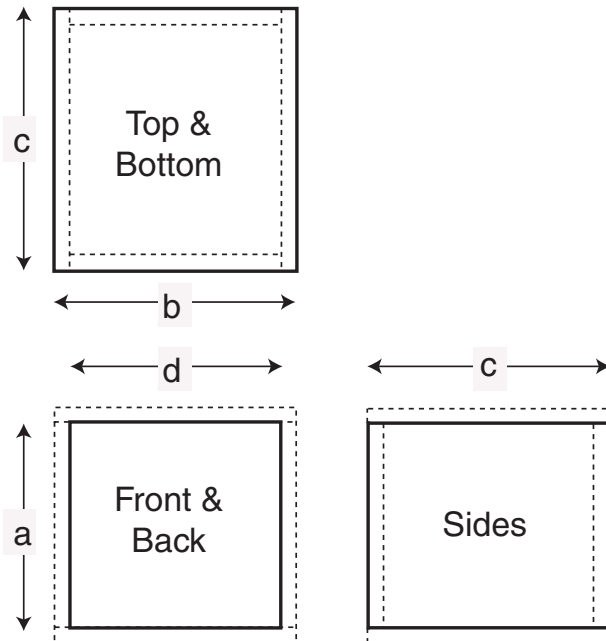

—Box Parts—

Box Shape – Square Prism

1 Top, 1 Bottom

depth (c) = 16 in.

width (b) = 16 in.

thickness = 1.0 in.

1 Front, 1 Back

height (a) = 14.5 in.

width (d) = 14 in.

thickness = 14 in.

2 Sides

height (a) = 14.5 in.

depth (c) = 16 in.

thickness = 1.0 in.

—Driver Mounting—

Front

HCCA 12.2 & 12.4 Vented Enclosure Recommendations

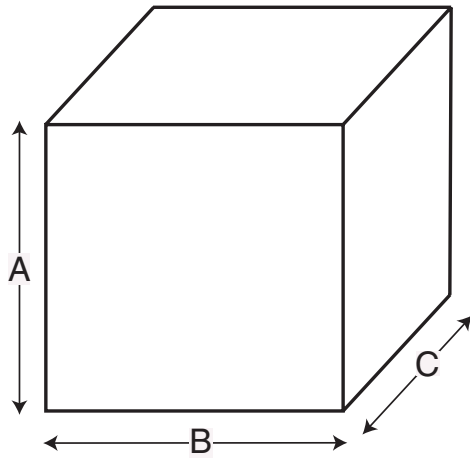

—External Dimensions—

A = 16 in.

B = 15.5 in.

C = 20 in.

—Internal Dimensions—

A = 14 in.

B = 13.5 in.

C = 18 in.

—Wall Thickness—

All Sides = 1.0 in.

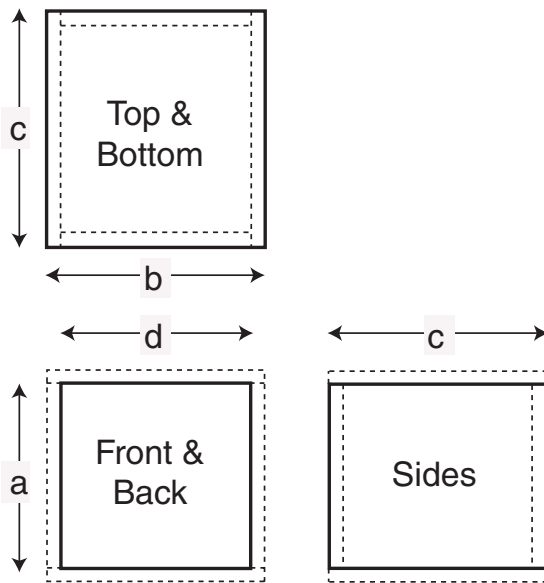

—Box Parts—

Box Shape – Square Prism

1 Top, 1 Bottom

depth (c) = 20 in.

width (b) = 15.5 in.

thickness = 1.0 in.

1 Front, 1 Back

height (a) = 14 in.

width (d) = 13.5 in.

thickness = 1.0 in.

2 Sides

height (a) = 14 in.

depth (c) = 20 in.

thickness = 1.0 in.

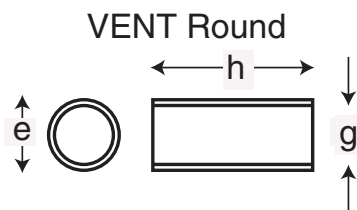

- OR -
VENT Square

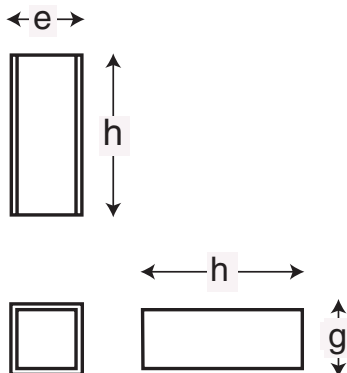

—Driver Mounting— Front

—Vent Part—Round

outside diameter (e) = 4.25 in.

inside diameter (g) = 4 in.

length (h) = 15 in.

—Vent Part—Square

1 Top, 1 Bottom

width (e) = 3.795 in.

length (h) = 15 in.

thickness = 0.125 in.

2 Sides

height (g) = 3.545 in.

length (h) = 15 in.

thickness = 0.125 in.

HCCA 15.2 & 15.4 Sealed Enclosure Recommendations

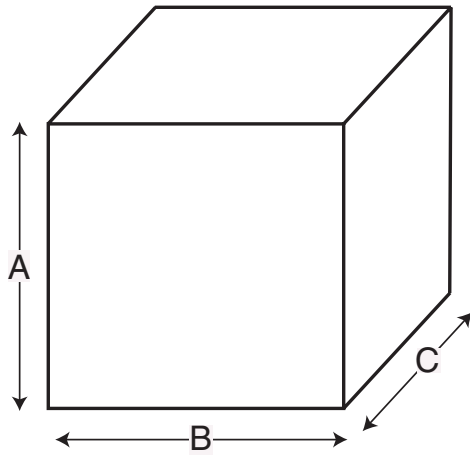

—External Dimensions—

A = 17.5 in.

B = 18 in.

C = 20 in.

—Internal Dimensions—

A = 15.5 in.

B = 16 in.

C = 18 in.

—Wall Thickness—

All Sides = 1.0 in.

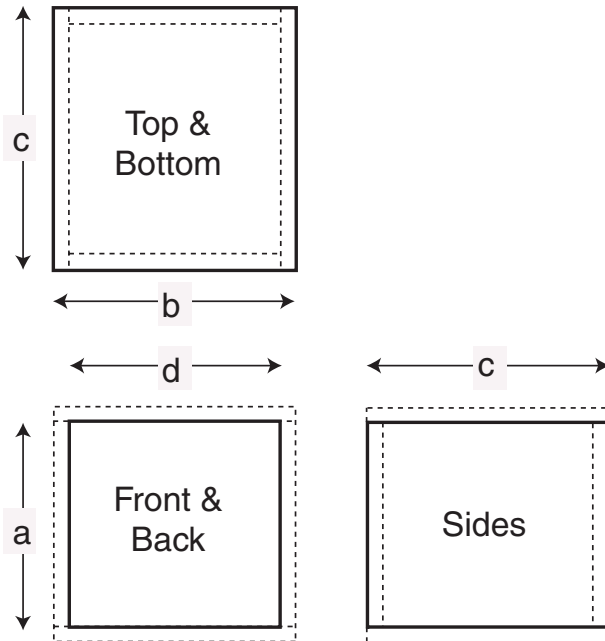

—Box Parts—

Box Shape – Square Prism

1 Top, 1 Bottom

depth (c) = 20 in.

width (b) = 18 in.

thickness = 1.0 in.

1 Front, 1 Back

height (a) = 15.5 in

width (d) = 19 in.

thickness = 1.0 in.

2 Sides

height (a) = 15.5 in

depth (c) = 20 in.

thickness = 1.0 in.

—Driver Mounting—

Front

HCCA 15.2 & 15.4 Vented Enclosure Recommendations

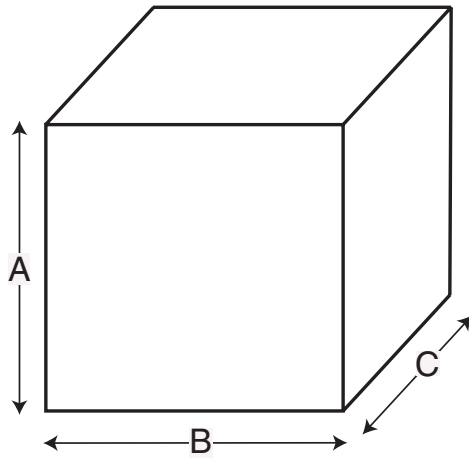

—External Dimensions—

A = 17.5 in.

B = 21 in.

C = 18 in.

—Internal Dimensions—

A = 15.5 in.

B = 19 in.

C = 16 in.

—Wall Thickness—

All Sides = 1.0 in.

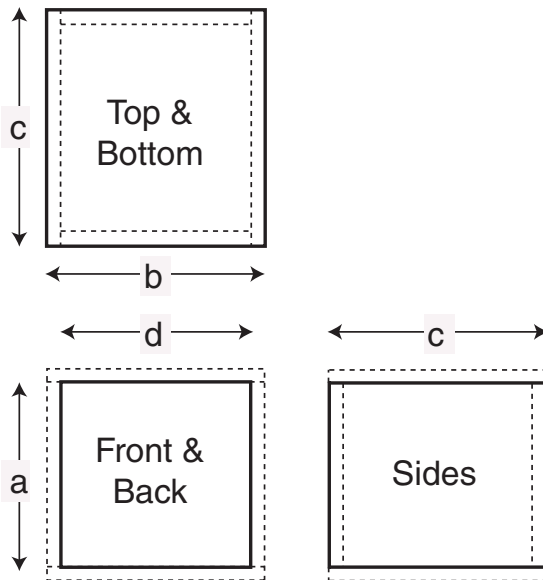

—Box Parts—

Box Shape – Square Prism

1 Top, 1 Bottom

depth (c) = 18 in.

width (b) = 21 in.

thickness = 1.0 in.

1 Front, 1 Back

height (a) = 15.5 in.

width (d) = 19 in.

thickness = 1.0 in.

2 Sides

height (a) = 15.5 in.

depth (c) = 18 in.

thickness = 1.0 in.

VENT Round

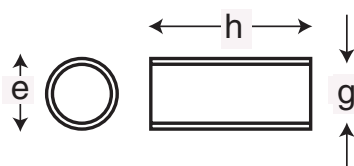

- OR -

VENT Square

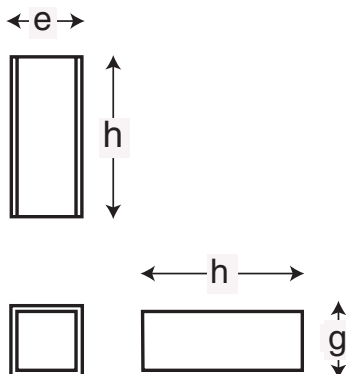

—Driver Mounting—

Front

—Vent Part—Round

outside diameter (e) = 5.25 in.

inside diameter (g) = 5 in.

length (h) = 15 in.

—Vent Part—Square

1 Top, 1 Bottom

width (e) = 4.681 in.

length (h) = 15 in.

thickness = 0.125 in.

2 Sides

height (g) = 4.431 in.

length (h) = 15 in.

thickness = 0.125 in.

SPECIFICATIONS

Directed Part Number	27302	27304	27307
Model Number	10.2	10.4	12.2
Thiele/Small Parameters			
Fs (free-air resonance, Hz)	30.78	32.49	22.56
Vas (equivalent compliance, cu. ft.)	0.564	0.564	1.847
Vas (equivalent compliance, liters)	15.98	15.98	52.33
Qms (Q, mechanical)	3.63	3.63	2.99
Qes (Q, electrical)	0.42	0.46	0.36
Qts (total driver Q)	0.38	0.41	0.32
Re (DC resistance, ohms)	3.93	7.57	4.07
Z (nominal impedance, ohms)	2 x 2	2 x 4	2 x 2
Le (inductance, mh)	1.93	2.93	2.61
Efficiency (1W @ 1M, dB)	83	83	85
Xmax (one way linear excursion, in.)	1.0	1.0	1.2
Xmax (one way linear excursion, mm)	25	25	30
Pe (continuous power handling, watts)	1500	1500	2000
Peak power handling (music, watts)**	3000	3000	4000
Mms (total moving mass, grams)	261.93	235.64	421.18
Cms (mechanical compliance, mm/N)	0.102	0.102	0.118
Bl (motor strength, Tesla-M)	21.81	28.05	25.85
Sd (effective radiating area, sq. cm.)	333.3	333.3	559.9
Sd (effective radiating area, sq. m.)	0.03333	0.03333	0.05599
Sd (effective radiating area, sq. in.)	51.6616	51.6616	86.78467
Frequency range (Hz)	31-250	32-250	23-250
Energy Bandwidth Product (EBP)	74	70	62
Driver Physical Dimension			
Speaker Displacement (cu ft.)	0.1268	0.15382	0.28931
Mounting hole diameter (mm)	238	238	292
Mounting hole diameter (inches)	9.37	9.37	11.496
Mounting depth (mm)	214	214	261
Mounting depth (inches)	8.425	8.425	10.276
Magnet Weight (Oz)	263.7	263.7	445
Basket diameter (inches)			
Recommended Enclosures			
Typical sealed enclosure (cu. ft.)	0.5 to 0.8	0.5 to 0.8	0.9 to 1.35
Vented enclosure (cu. ft.)	1.2	1.2	2
Port tuning frequency (Hz)	38	38	38
Port diameter (inside, in.)	3.4	3.4	5
Equivalent square port (in.)	3x3	3x3	4.5x4.5
Port length (in.)	12	12	15
Enclosure Details			
1. Parameters listed are for conventional applications only, for further help please call Tech Audio Support			
2. 1" MDF is recommended.			
3. Recommended enclosures are NET Box Volumes, speaker and port displacement are calculated into the volume of the enclosure, you will not need to add these volumes to calculate GROSS volume for the enclosure.			
*** Sub-sonic filters should always be used and adjusted specifically for vented box designs.			
NOTE: The woofer must face up or down only, especially in sealed enclosures.			
Specifications subject to change without notice			
© 2007 Directed Electronics, Inc. Vista, CA 92081 All rights reserved.			

SPECIFICATIONS (CONT'D)

Directed Part Number	27309	27312	27314
Model Number	12.4	15.2	15.4
Thiele/Small Parameters			
Fs (free-air resonance, Hz)	23.98	23.72	24.73
Vas (equivalent compliance, cu. ft.)	1.847	4.01	7.23
Vas (equivalent compliance, liters)	52.33	113.68	113.68
Qms (Q, mechanical)	2.99	2.99	2.99
Qes (Q, electrical)	0.42	0.46	0.52
Qts (total driver Q)	0.37	0.40	0.44
Re (DC resistance, ohms)	7.76	4.08	7.23
Z (nominal impedance, ohms)	2 x 4	2 x 2	2 x 4
Le (inductance, mh)	3.67	2.59	3.68
Efficiency (1W @ 1M, dB)	85	88	88
Xmax (one way linear excursion, in.)	1.2	1.2	1.2
Xmax (one way linear excursion, mm)	30	30	30
Pe (continuous power handling, watts)	2000	2000	2000
Peak power handling (music, watts)**	4000	4000	4000
Mms (total moving mass, grams)	372.77	517.86	476.42
Cms (mechanical compliance, mm/N)	0.118	0.087	0.087
Bl (motor strength, Tesla-M)	32.07	26.03	32.15
Sd (effective radiating area, sq. cm.)	559.9	962.1	962.1
Sd (effective radiating area, sq. m.)	0.05599	0.09621	0.09621
Sd (effective radiating area, sq. in.)	86.78467	149.1258	149.1258
Frequency range (Hz)	24-250	24-250	24-250
Energy Bandwidth Product (EBP)	57	51	48
Driver Physical Dimension			
Speaker Displacement (cu. ft.)	0.30361	0.37704	0.33403
Mounting hole diameter (mm)	292	383	383
Mounting hole diameter (inches)	11.496	15.079	15.079
Mounting depth (mm)	261	294	294
Mounting depth (inches)	10.276	11.575	11.575
Magnet Weight (Oz)	445	445	445
Basket diameter (inches)			
Recommended Enclosures			
Typical sealed enclosure (cu. ft.)	0.9 to 1.35	1.9 to 2.5	1.9 to 2.5
Vented enclosure (cu. ft.)	2	3.5	3.5
Port tuning frequency (Hz)	35	35	35
Port diameter (inside, in.)	5	6.25	6.25
Equivalent square port (in.)	4.5x4.5	5.5x5.5	5.5x5.5
Port length (in.)	15	14.5	14.5
NOTE: Due to the high power capabilities and long excursion of these woofers, the Thiele/Small Parameters were calculated and measured using a Klippel analyzer system.			

NO WARRANTY

THIS PRODUCT IS SOLD "AS-IS"

DIRECTED ELECTRONICS (hereinafter "**SELLER**") **MAKES NO WARRANTY** of any kind (express, implied or otherwise) in connection with this Product. **THIS PRODUCT IS SOLD AS-IS, AND YOU THE PURCHASER ASSUME THE ENTIRE RISK AS TO ITS QUALITY AND PERFORMANCE. ANY IMPLIED WARRANTY OF MERCHANTABILITY OR FITNESS FOR A PARTICULAR PURPOSE THAT EXCEEDS THE FOREGOING WARRANTY IS HEREBY EXPRESSLY DISCLAIMED BY SELLER TO THE MAXIMUM EXTENT ALLOWED BY LAW AND IS EXCLUDED FROM ANY AGREEMENT MADE BY ACCEPTING THIS OFFER.** **SELLER** neither assumes nor authorizes any person to assume for it any liability in connection with the sale of this Product. **SELLER** has absolutely no liability for any and all acts of third parties including distributors, authorized dealers or installers. **SELLER** will not be liable for any direct, indirect, special, incidental or consequential damages, loss or expense arising in connection with the use of the Product or the inability to use the Product for any purpose whatsoever. This Product is not eligible for return or exchange. Any return of this Product to **SELLER** will be declined at Shipper's expense.

All exclusions and limitation are made only to the extent permitted by applicable law and shall be of no effect to the extent in conflict with the express requirements of applicable law. Some states do not allow the exclusion or limitation of incidental or consequential damages. In such states, the exclusion or limitations stated herein may not apply to you. You may have specific legal or other rights which vary from state to state.

p/n 920-0034 01-07



Designed and Engineered in the USA by:

Directed
ELECTRONICS

Free Manuals Download Website

<http://myh66.com>

<http://usermanuals.us>

<http://www.somanuals.com>

<http://www.4manuals.cc>

<http://www.manual-lib.com>

<http://www.404manual.com>

<http://www.luxmanual.com>

<http://aubethermostatmanual.com>

Golf course search by state

<http://golfingnear.com>

Email search by domain

<http://emailbydomain.com>

Auto manuals search

<http://auto.somanuals.com>

TV manuals search

<http://tv.somanuals.com>