

Part#8900-2117 REV A

One of the ADST family of companies

Orion Industries, Incorporated
9235 S. Mckemy St., Tempe, Arizona 85284
Phone: 480.705.5600 Fax: 480.705.5788



XTR Amplifiers **Owners Manual**

800.42

 **ORION**TM

TABLE OF CONTENTS

INTRODUCTION	4
WARRANTY	7
SPECIFICATIONS	9
END PANEL LAYOUT	11
INPUT CONIFURATIONS	12
4-CHANNEL INPUT CONFIGURATION	12
RCA INPUT/COPY 1+2	13
INTERNAL CROSSOVER CONFIGURATION	13
INTELLI Q	17
REMOTE GAIN OPERATION	19
INPUT GAIN	19
POWER CONNECTIONS	20
SPEAKER CONNECTIONS	21
INSTALLATION	25
TESTING THE SYSTEM	30
ADJUSTING THE SOUND OF THE SYSTEM	31
TROUBLESHOOTING TIPS	32
AUTOSOUND 2000 TROUBLESHOOTING TIPS	34

INTRODUCTION

Thank you for your purchase of ORION's XTREME amplifier. Each ORION amplifier is designed to be the leader in its class offering the most power, advanced features and ease of use. The ORION XTREME amplifiers are designed as the best car audio amplifier money can buy. Listed below are the features of the XTREME 800.4.

- **XTREME 800.4** – 93.75 watts per channel, 4-channel amplifier with fully variable low-pass crossovers from 45Hz to 5kHz. The high-pass crossover is continuously variable from 10Hz to 10kHz. The XTREME 800.4 has the INTELLiQ subwoofer optimizing circuitry and dual remote gain capability. The XTREME 600.4 is capable of 6, 5, 4, 3, or 2 channel operation.

NOTE: The installation of all ORION XTREME amplifiers will determine the overall performance result. Improper installation will not only limit the performance of your ORION system but also potentially compromise the reliability of this amplifier. To ensure proper sonic results and component reliability, please refer to your Authorized ORION dealer for installation assistance or advice. If you decide to perform the installation yourself, read the entire installation section of this manual before beginning the installation.

page 4



ABOUT THIS MANUAL

This manual is divided into different sections for different needs. Whether you are the owner, salesperson or installer, we have devoted sections of this manual to answer your questions.

We, at ORION, strive to give you the latest up to date information about our products. What we cannot give you is personal installation or technical experience. If you have questions regarding the installation or the setup or tuning of this product, please refer to your nearest Authorized ORION Dealer for assistance. Additionally, you can call ORION's Technical Support Hotline at (480)705-5600 for assistance.

PRACTICE SAFE SOUND™

Continuous exposure to sound pressure levels over 100dB may cause permanent hearing loss. High powered automotive sound systems can generate sound pressure levels in excess of 130dB. When playing your system at high levels, please use hearing protection and avoid long term exposure.

RECORD YOUR SERIAL NUMBER AND DATE:

Model: _____

Serial Number: _____

Date of Purchase: _____

Company Purchased From: _____

page 5

WHAT'S IN THE BOX

- (1) XTREME amplifier
- (1) 4 gauge power and ground connector
- (1) 12 gauge speaker and remote connector
- (4) #8 self-tapping black Phillips pan head screws
- (1) XTREME installation and operation manual

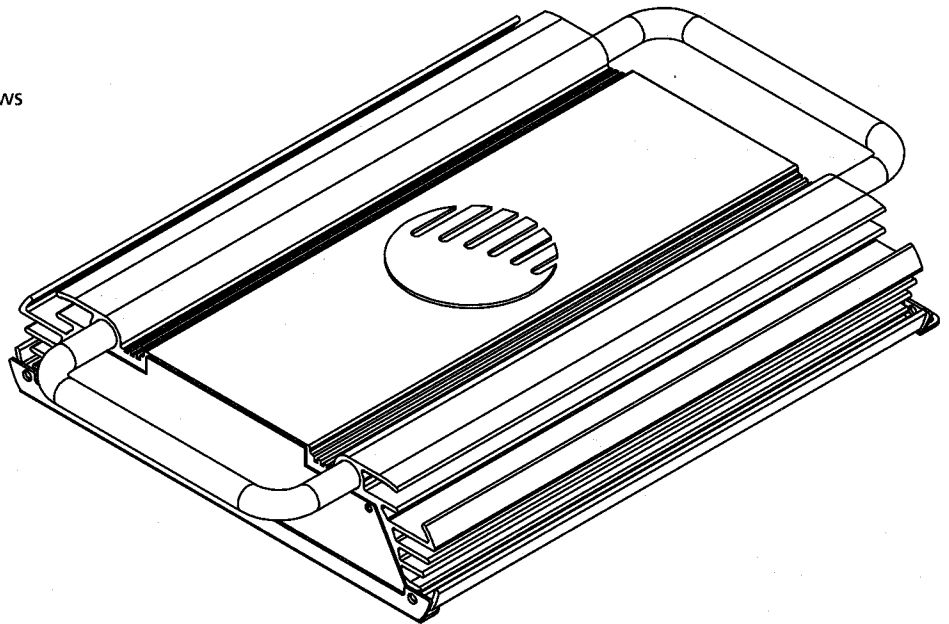

NOTE: The XTR amplifier handles are an optional accessory available at your local authorized ORION dealer.

page 6

WARRANTY

ORION Industries Inc. warrants this product to be free from defects in material and workmanship under the following terms:

Parts and Labor are warranted for a period of 3 years IF:

- a. The product is purchased from an Authorized ORION Dealer
- b. The product is installed by an Authorized ORION Dealer

Parts and Labor are warranted for a period of 1 year IF:

- a. The product is purchased from an Authorized ORION Dealer
- b. The product is NOT installed by an Authorized ORION Dealer

Parts and Labor are warranted for a period of 90 days IF:

- a. The product is NOT purchased from an Authorized ORION Dealer

If you are uncertain as to whether your dealer is authorized, please contact ORION at (480) 705-5600. In countries other than the USA, each distributor warrants the ORION product it sells.

The Following conditions and situations are **NOT** covered by this warranty:

Any product on which the serial number has been defaced, modified or removed

Damage or malfunction resulting from:

- a. Accident, misuse, abuse, unauthorized modification or failure to follow the instructions provided with this product.
- b. Repair by anyone NOT authorized by ORION.
- c. Damage due to shipping (these claims must be presented to the freight carrier)
- d. Removal or installation of this product.
- e. Any failure that has NOT been caused by a defect in material or workmanship.

This warranty is in effect for the original purchaser only. ORION will pay for labor and material expense for covered items. ORION does not cover removal or installation charges, payment of shipping charges to ORION, payment of OUT-OF-WARRANTY shipping charges, or damage to other property caused by any defects in this product.

page 7

For all warranty and non-warranty service issues, please refer to your nearest Authorized ORION Dealer for assistance. If you require additional information or assistance regarding service repair issues, please call (480) 705-5600.

Exclusion

1. This warranty is in lieu of all other warranties expressed of implied
2. In no event will ORION be liable for any consequential damages resulting from the use of this product or any defect of this product.

This Warranty gives you specific legal rights and you may also have other rights which vary from state to state.

SAVE YOUR RECIEPT!

SPECIFICATIONS

Amplifier	XTREME 800.4 Front Channels	XTREME 800.4 Rear Channels
Power output 4 Ω stereo (watts) ¹	100 x 2 100 x 2, 400 x 1	100 x 2 100 x 2, 400 x 1
Power output 2 Ω stereo (watts) ²	200 x 2	200 x 2
Power output 4 Ω mono (watts) ¹	400 x 1	400 x 1
Distortion all channels driven (from 20Hz to 20kHz)	<0.1% THD	<0.1% THD
Frequency Response	20Hz to 20kHz ±0.25dB	20Hz to 20kHz ±0.25dB
Linear Bandwidth	6Hz to 50kHz ±3dB	6Hz to 50kHz ±3dB
Signal-to-noise ratio full bandwidth @ rated output power	>100dB	>100dB
Damping factor @ output connector @ full bandwidth	>400 at output connector	>400 at output connector
Slew Rate	>30V μ s	>30V μ s
Input Sensitivity ³	200 mV to 5 Vrms	200 mV to 5 Vrms
Input Impedance	20 k ohm	20 k ohm
Fuse Type	(3) 20 Amp ATC	(3) 20 Amp ATC

Crossover ³	XTREME 800.4 Front Channels	XTREME 800.4 Rear Channels
Low-Pass Crossover	Continuously variable	Continuously variable
Low-Pass Frequency Range	45Hz to 5kHz	45Hz to 5kHz
High-Pass Crossover	Continuously variable	Continuously variable
High-Pass Frequency Range	10Hz to 10kHz	45Hz to 5kHz
High-Pass INTELLiQ Range	0dB to 10dB of Boost	n/a
General		
Dimensions	18"L x 10.25"W x 2.25"H (457mm x 260mm x 57mm)	18"L x 10.25"W x 2.25"H (457mm x 260mm x 57mm)

- ¹ All channels driven, continuous rated 4Ω load, 20Hz to 20,000Hz, >0.1% THD, per input voltage at 13.8VDC.
- ² All channels driven, continuous rated 2Ω load, 20Hz to 20,000Hz, >0.1% THD, per input voltage at 13.8VDC.
- ³ XTREME amplifiers are designed to accept full 9 Volts RMS input when set to the minimum gain position.
- ⁴ All crossovers are with a slope rate of 12dB/octave and a "Q" of .070.

END PANEL LAYOUT

1. Power LED - lights up when the amplifier is on
2. Low-pass crossover frequency control-adjusts the front channel low-pass crossover frequency (page 14)
3. Low-pass crossover switch-activates the front channel low-pass crossover (page 14)
4. INTELLiQ gain-adjusts the level of INTELLiQ from 0dB to 10dB of boost (page 17)
5. High-pass crossover "x10" switch-changes the high-pass crossover frequency range (page 15)
6. High-pass crossover frequency control-adjusts the front channel high-pass crossover frequency (page 15)
7. High-pass crossover switch-activates the front channel high-pass crossover (page 15)
8. Front Gain Control - continuously adjusts from 200mV to 5Vrms for full power output (page 19)
9. Front Input Configuration Switch - determines the input configuration for the front channels (page 12)
10. Front RCA Inputs- accepts RCA input from a source unit, preamplifier or equalizer for the front channels
11. Rear RCA Inputs- accepts RCA input from a source unit, preamplifier or equalizer for the rear channels
12. 2 RCA IN / 4 RCA IN Switch - configures the amplifier for two or four RCA inputs (page 12)
13. Rear Output Configuration Switch - determines the output configuration for the rear channels (page 12)
14. Rear Crossover Control - adjusts the frequency for the rear channels (page 14)
15. RCA INPUT / COPY 1+2 button configures rear channels for direct input or output of front channel crossover and gain (page 13)
16. Rear Gain Control - continuously adjusts from 200mV to 5Vrms for full power output (page 19)

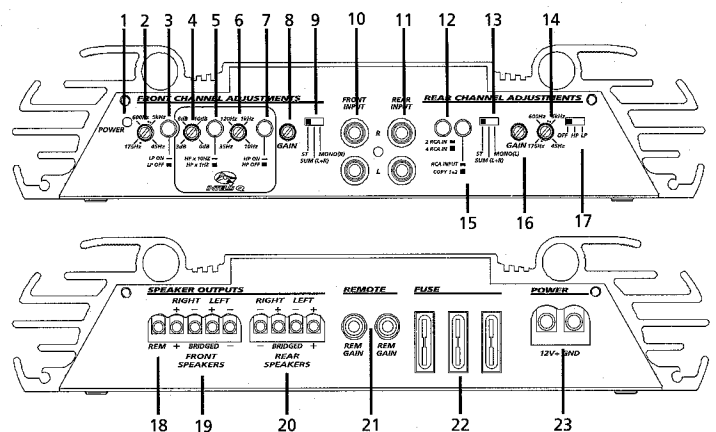

17. Rear Crossover Switch - configures the rear channel for high-pass, low-pass or full range operation (page 13)
18. REM Remote Turn-on Input - turns on the amplifier when fed 12 V+ (page 20)
19. Front speaker output- allows up to 12 gauge speaker wire (page 21)
20. Rear speaker output- allows up to 12 gauge speaker wire (page 21)
21. Remote Gain-allows dashboard control of the amplifier output level (page 19)
22. Fuse - protects the amplifier from over current situations
23. Power Connections - allow up to 4 gauge power and ground cables (page 20)

OUTPUT CONFIGURATIONS

Three position switches determine output configuration for the XTREME amplifiers. Each stereo pair of channels can be configured in either stereo, summed-bridged and bridged-mono. The switch or switches are located on the outermost edge of the amplifier.



When the switch is in the left position, the output channels are configured for stereo operation.



When the switch is in the center position, the output channels are configured for summed mono operation by mixing the left and right input signals together. Use this setting when using a pair of RCA inputs.



When the switch is in the right position, the output channels are configured for a single bridged output using a single RCA input. To determine which RCA to use, refer to the marking in parenthesis. For the front outputs, the Left RCA input is used. For the rear outputs, the Right RCA input is used.

4-CHANNEL AMPLIFIER INPUT CONFIGURATIONS

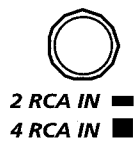

The 2 RCA IN / 4 RCA IN switch routes RCA input from the front RCA inputs to the rear section of the amplifier. This allows the XTREME 4-channel amplifier to utilize a single set of RCAs to feed signal to both the front and rear channels of the amplifier.

When the switch is in disengaged, signal from the front RCA input is routed to the rear RCA inputs.

NOTE: In this configuration, the rear RCA inputs can be routed to another amplifier. The signal leaving the amplifier is a copy of the incoming signal.

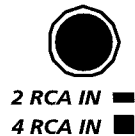

When the switch is engaged, front and rear RCA inputs are independent. This allows a source unit with an internal fader to fade between the front and rear outputs.

page 12

RCA INPUT / COPY 1+2

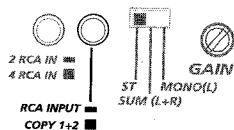

The RCA Input / COPY 1+2 push button switch configures the input for Channels 3 & 4. The feature allows the more advanced crossover features of the front channels to be routed to both the front and rear channels. Configured in this manner, **INTELLIQ** is now available on all channels of the amplifier as well as bandpass crossovers for midbass and midrange speakers.

When the switch is disengaged, the REAR INPUT RCA input feeds channels 3+4.

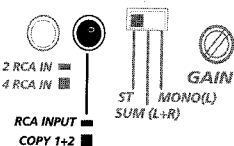

When the switch is engaged, channels 3 & 4 receive input signal from the output of channels 1 & 2 after the crossover output. When the switch is in engaged, signal from the front RCA input is routed to the rear RCA inputs. The front gain control controls the level of the entire amplifier. The rear gain controls are deactivated.

REAR INTERNAL CROSSOVER CONFIGURATION

The XTREME 600.4 use multi-position switches to determine the rear crossover configuration. The multi-position switch is located on the adjustment side of the amplifier. Listed below are the switch positions and their respective crossover configurations.

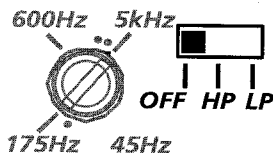

When the switch is in the "OFF" position, the crossover section of the amplifier is bypassed. Amplifier output is full range.

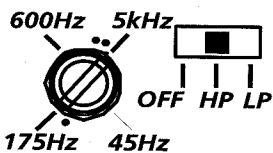

When the switch is in the center position, the crossover is configured for high-pass operation. The rear channels of the XTREME 600.4 are continuously variable from 45Hz to 5kHz.

page 13

REAR INTERNAL CROSSOVER CONFIGURATION

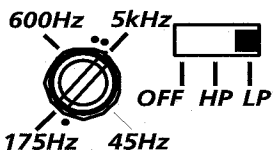

When the switch is in the right position, the crossover is configured for low-pass operation. The rear channels of the XTREME 600.4 are continuously variable from 45Hz to 5kHz.

FRONT INTERNAL CROSSOVER CONFIGURATION

The front channels of the XTREME 600.4 can be configured for either high-pass, low-pass or bandpass operation. **INTELLIQ** is a feature of the amplifier that maximizes the performance of any subwoofer system. **INTELLIQ** is the one feature that separates ORION amplifiers from the competition.

FRONT CHANNEL ADJUSTMENTS

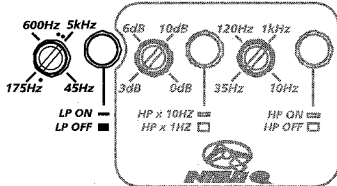

When the push button switch is in the "off" position, the low-pass crossover is bypassed.

FRONT CHANNEL ADJUSTMENTS

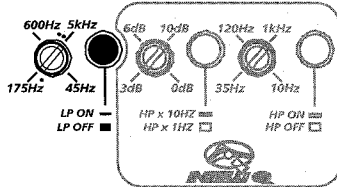

When the push button switch is in the "on" position, the low-pass crossover is activated. The crossover frequency range is from 45Hz to 5kHz. There are additional reference points at 85Hz, 2.5kHz and 3.5kHz respectively.

page 14

FRONT INTERNAL CROSSOVER CONFIGURATION

FRONT CHANNEL ADJUSTMENTS

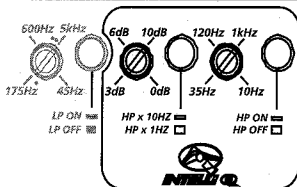

When the push button switch is in the "off" position, the high-pass crossover is bypassed.

FRONT CHANNEL ADJUSTMENTS

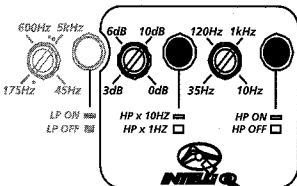

When the push button switch is in the "on" position and the "x10" button is on the on position, the high-pass crossover is activated in the "high" range. The crossover frequency range is from 100Hz to 10kHz. There are four corner frequencies at 100Hz, 350Hz, 1,200Hz and 10kHz. This range is useful when used with smaller diameter midrange and tweeter speakers.

FRONT CHANNEL ADJUSTMENTS

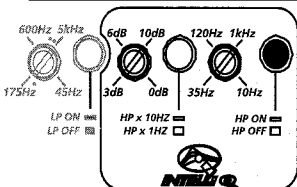

When the push button switch is in the "on" position and the "x10" button is on the off position, the high-pass crossover is activated. The crossover frequency range is from 10Hz to 1kHz. There are four corner frequencies at 10Hz, 35Hz, 120Hz and 1kHz. This range is useful when used with larger diameter midrange and midbass speakers. Additionally, this can also be used as a "subsonic filter" to prevent potentially damaging low-frequency from getting to your subwoofer (See INTELLIQ section on page 16.)

page 15

FINE TUNING INTERNAL CROSSOVER

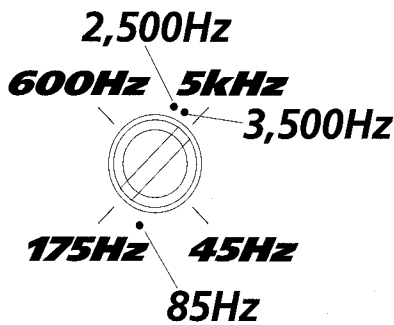

Low Pass Crossover

The low-pass crossover on the front channels and the rear crossover is continuously adjustable from 45Hz to 5kHz. There are three markings surrounding the crossover pot that designate 85Hz, 2,500Hz and 3,500Hz respectively.

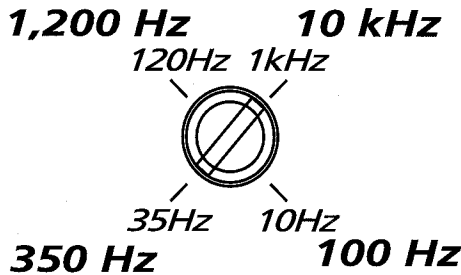

High Pass Crossover

When the high-pass crossover push button switch is in the "on" position and the "x10" button is on the on position, the high-pass crossover is activated in the "high" range. The crossover frequency range is from 100Hz to 10kHz. This range is useful when used with smaller diameter midrange and tweeter speakers.

When the high-pass crossover push button switch is in the "on" position and the "x10" button is on the off position, the high-pass crossover is activated. The crossover frequency range is from 10Hz to 1kHz. This range is useful when used with larger diameter midrange and midbass speakers. Additionally, this can also be used as a "subsonic filter" to prevent potentially damaging low-frequency from getting to your subwoofer.

page 16

INTELLI Q

FRONT CHANNEL ADJUSTMENTS

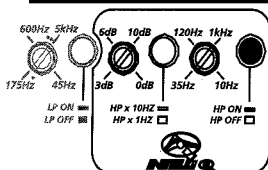

In the world of "me too features," Orion has developed the **INTELLI Q** circuit that makes a real difference in your automotive listening experience.

INTELLI Q (**INTELL**igently **INTEG**rated **Q** adjustment) is actually an infinitely variable "Q" adjustment found on the high-pass crossover of new XTREME and HCCA "Type R" power amplifiers. By changing the "Q" of the high-pass from the industry standard 0.707 to any "Q" value between 0.707 and 3.5 (**Figure 1**), the high-pass filters essentially becomes two filters: a single band parametric equalizer and a subsonic filter.

By increasing the "Q" value from 0.707 to 3.5, the output is boosted up to 10dB at the high-pass crossover frequency. The end-panel display is clearly marked in 3dB boost steps. Unlike other manufacturers "subsonic filters," adjusting the **INTELLI Q**'s high-pass crossover frequency easily performed turning the crossover pot located directly to the right of the "Q" adjustment (**Figure 2**). The high-pass crossover is continuously variable from 10Hz to 1kHz or 100Hz to 10kHz via a x10 frequency selector. By correctly using the **INTELLI Q**, you can increase low frequency output by as much as 10dB!

Boosting the lower bass frequency does not come without trade-offs. As anyone knows, one of the greatest potentials for woofer damage is caused by over excursion. Excursion is the forward and backward movement of a woofer. When the signal to the woofer is incorrectly boosted, the woofer is required to move more than is capable. For reference, a 6dB of boost requires a woofer to quadruple its excursion to match the input signal. Ordinary bass boost equalizers boost without protection. Without any protection, potential for damage is high.

The difference of INTELLI Q

What makes the **INTELLI Q** different from all other equalizers or sub-sonic filters is that it can boost lower frequencies the woofer can produce by 10dB while preventing over excursion that can damage the woofer. The result is your woofer with the loudest low bass it can produce reliably. Here's how to use it.

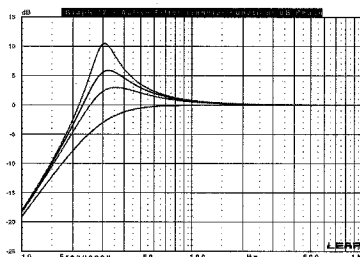
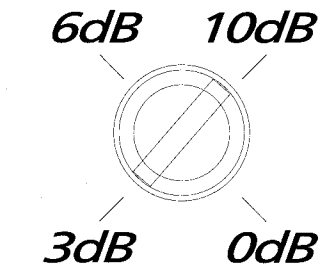

page 17

INTELLI Q

Setting up and using INTELLI Q

1. The first step to using the **INTELLI Q** is to install the amplifier. Seriously, basic installation techniques for new XTREME amplifiers remain unchanged. Set the low-pass crossover as you would in "normal" installations. (Normal Orion of course.)
2. Determine which type of enclosure you are using. Refer to the table below for tuning assistance. For example: for vented enclosures, set the high-pass crossover to the tuning frequency (port frequency) of the enclosure. If you have a woofer such as the new HCCA woofers up to 10dB of boost can be used. For woofers of lesser excursion capability, it is recommended to use up to 6dB of boost only.
3. For RTA tuning, start the **INTELLI Q** boost setting at 0dB. Using pink noise, slowly increase the Q adjustment until the desired frequency response is achieved. In situations where you are require more boost than is recommended, you can lower the crossover frequency to get a similar desired effect.
4. For tuning by ear, start the **INTELLI Q** boost setting at 0dB. Using music the high-energy low frequency content, slowly increase the Q adjustment until the desired sonic performance in achieved. In situations where you are require more boost than is recommended, you can lower the crossover frequency to get a similar desired effect

Boost Levels	0dB	+3dB	+6dB	+10dB
Enclosure Type : Infinite Baffle	Acceptable No Problems Tune above Fs of woofer	High X-Max Drivers Tune above Fs of woofer	Not Recommended	Not Recommended
Sealed	Acceptable No Problems Tune above Fs of woofer	Acceptable No Problems Tune above Fs of woofer	High X-Max Drivers Tune above Fs of woofer	Not Recommended
Vented	Acceptable No Problems Tune to port frequency	Acceptable No Problems Tune to port frequency	Acceptable No Problems Tune to port frequency	High X-Max Drivers Tune to port frequency
Sealed Bandpass	Acceptable No Problems Tune above Fs of woofer	Acceptable No Problems Tune above Fs of woofer	High X-Max Drivers Tune above Fs of woofer	Not Recommended
Vented Bandpass	Acceptable No Problems Tune to port frequency	Acceptable No Problems Tune to port frequency	Acceptable No Problems Tune to port frequency	High X-Max Drivers Tune to port frequency
Aperiodic	Set crossover to Fs of woofer	Set crossover to Fs of woofer	Set crossover to Fs of woofer	Not Recommended

REMOTE GAIN

REMOTE

The remote gain port allows remote, user control over the output of the amplifier. When used on a subwoofer amplifier, the remote gain allows you to change the bass level for different music styles, driving conditions, or sonic preferences. Unlike other designs, Orion allows remote access to the level of the amplifier via a digital micro-controller and electronic volume that does not interfere with the sonic signal chain. The result is a clean clear control of the level of the amplifier that is unaffected by noise.

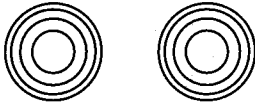

REM
GAIN

REM
GAIN

The XTREME 600.4 has two remote gain ports. This allows for individual control of either the front or rear channels. One RGC-1 can be used to control the level of the front channels and another RGC-1 can be used to control the output level of the rear channels. An example benefit of this is having the front channels in bandpass mode for midbass and the rear channels in low-pass mode for subwoofers. Using two RGC-1 would give the driver the ability to control the level of both the midbass and subwoofers for easy optimal tuning. To utilize this function simply plug-in a RGC-1 into either the front or rear gain ports. The RGC-1 is available from your authorized ORION dealer.

SIGNAL INPUT AND OUTPUT LEVEL CONTROLS

XTREME amplifiers have separate front and rear level adjustments. The input sensitivity of these adjustments range from 200mv up to 5Vrms on the RCA inputs. This allows easy integration from any source unit either with RCA outputs or speaker outputs. Refer to the *Testing the System* and the *Adjusting the Sound of the System* sections for detailed instructions on setting up the level controls.

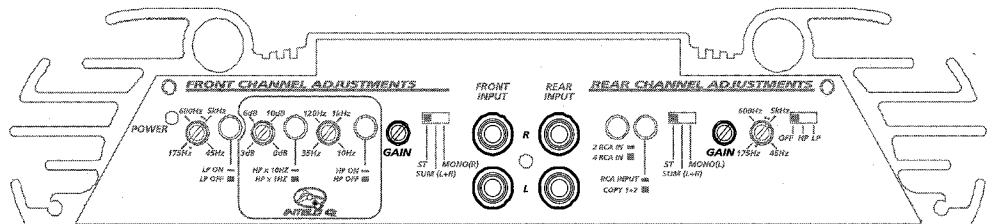

POWER CONNECTIONS

- Minimum 8 gauge power and ground cable is recommended for acceptable performance
- 4 gauge power and ground cable is recommended for optimal performance
- Fuse power wire less than 18" from battery
- Ground amplifier to a good chassis ground as close as possible to the amplifier
- Add extra ground wire between the negative terminal of the battery and the chassis

TUNING NOTE: The addition of a ground wire from the battery to the chassis of the vehicle improves the ability of the battery to supply power to the amplifier. This helps especially in newer vehicles, where the current delivery of the factory electrical system was designed only to accommodate electronics supplied by the auto manufacturer.

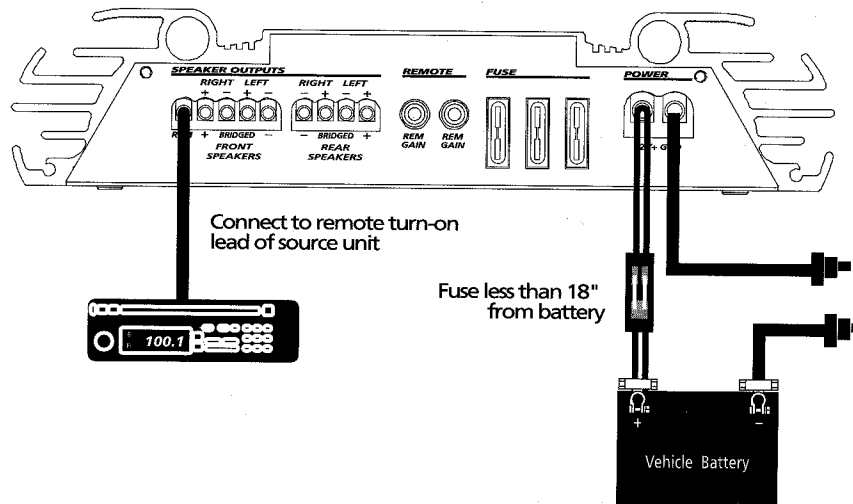

Amplifier	Fuse Size
XTREME 800.4	(3) 20 AMP

page 20

SPEAKER CONNECTIONS

4-CHANNEL STEREO CONFIGURATION

- Front and rear channel lowest recommended impedance is 2 Ohms stereo
- Crossover, output and gain configurations are independently adjustable between the front and rear channels
- 2-channel or 4-channel input can be used for this configuration. For source unit fading, use the 4-channel input mode (page 11)
- Front outputs can be configured for high-pass, low-pass or bandpass operation (page 13)
- Front channels equipped with INTELLiQ subwoofer optimization circuitry (page 16)
- Rear outputs can be configured for high-pass, low-pass or full range operation (page 13)
- Front and rear outputs can be configured for either stereo operation or summed for subwoofer applications (page 11)

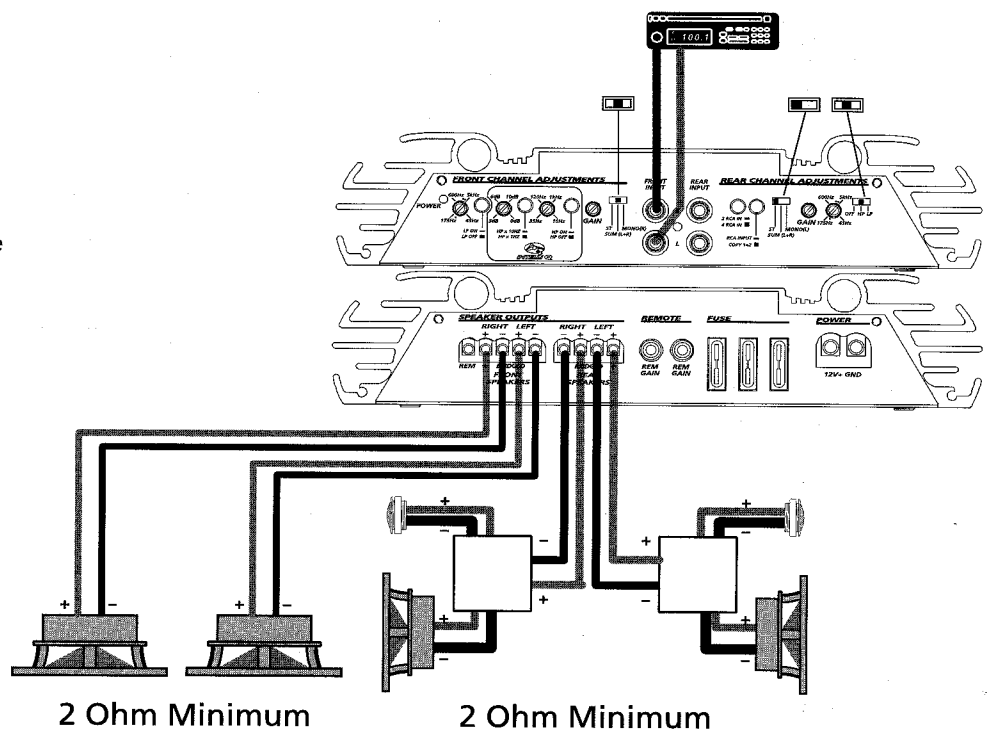

page 21

SPEAKER CONNECTIONS

3-CHANNEL STEREO/BRIDGED CONFIGURATION

- Front channels are configured for 2-channel stereo operation (page 11)
- Front channel lowest recommended impedance is 2 Ohms stereo
- Rear channels are configured for a single channel bridged output (page 11)
- Rear channel lowest recommended impedance is 4 Ohms
- Crossover, output and gain configurations are independently adjustable between the front and rear channels
- 2-channel or 4-channel input can be used for this configuration. For source unit fading, use the 4-channel input mode (page 11)
- Front and rear outputs can be configured for high-pass, low-pass or full range operation (page 12)
- Front outputs can be configured for either stereo or summed stereo operation (page 11)
- Rear outputs can be configured for summed bridged or single channel bridged operation for subwoofer applications (page 11)

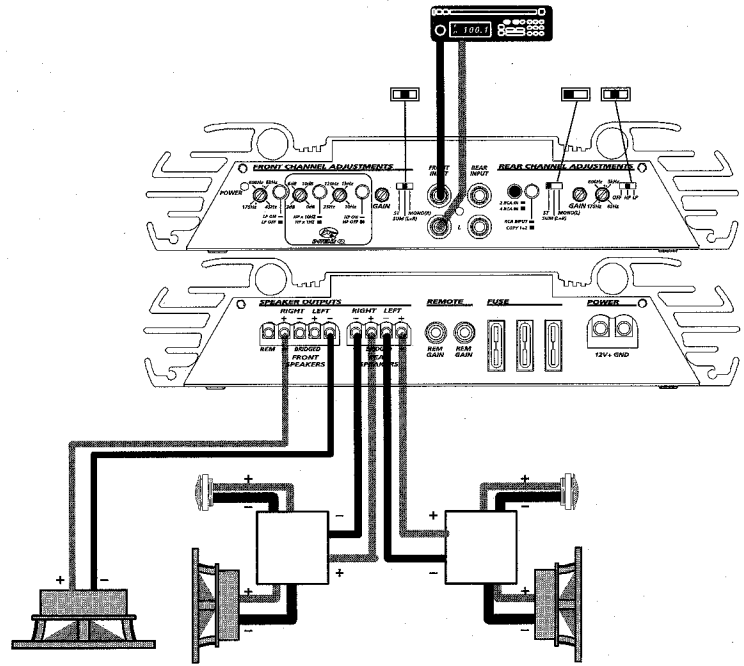

4 Ohm Minimum

2 Ohm Minimum

page 22

SPEAKER CONNECTIONS

TWO-CHANNEL BRIDGED CONFIGURATION

- Front and rear channels are configured for bridged 2-channel operation
- Lowest recommended impedance for both front and rear channels is 4 Ohms
- Crossover and gain configurations are independently adjustable between the front and rear channels
- 2-channel operation is recommended for this operational mode
- Front and rear outputs can be configured for high-pass, low-pass or full range operation (page 12)
- Front and rear outputs can be configured for stereo (front channels will have right output, rear channels will have left output or summed 2-channel operation (page 11)

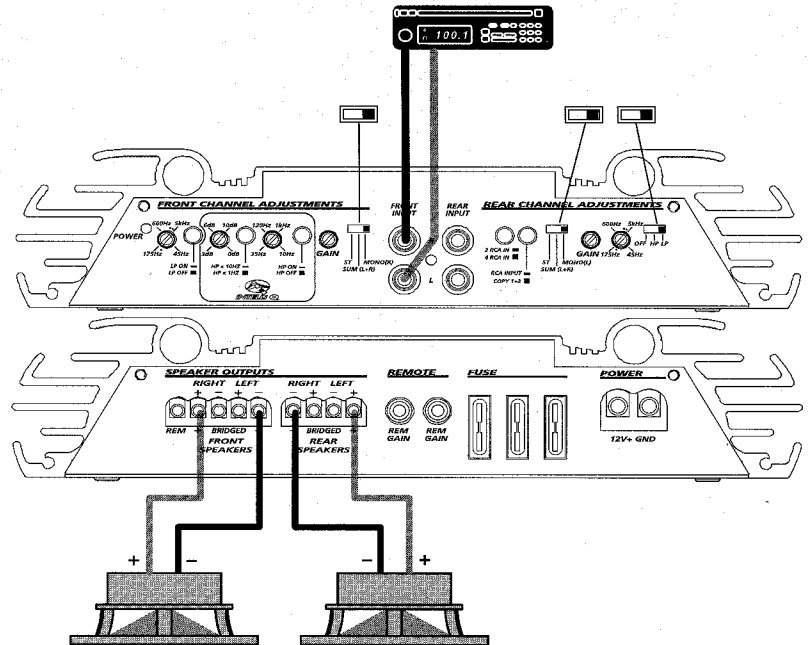

2 Ohm Minimum

2 Ohm Minimum

page 23

- Lowest recommended impedance is 2 Ohm stereo and 4 Ohm bridged mono
- Front and rear outputs must be set for full range operation (page 12)
- Front and rear outputs must be configured for stereo operation (page 11)
- Passive crossover frequencies must not overlap.

WARNING! Failure to do so may result in damage to the amplifier

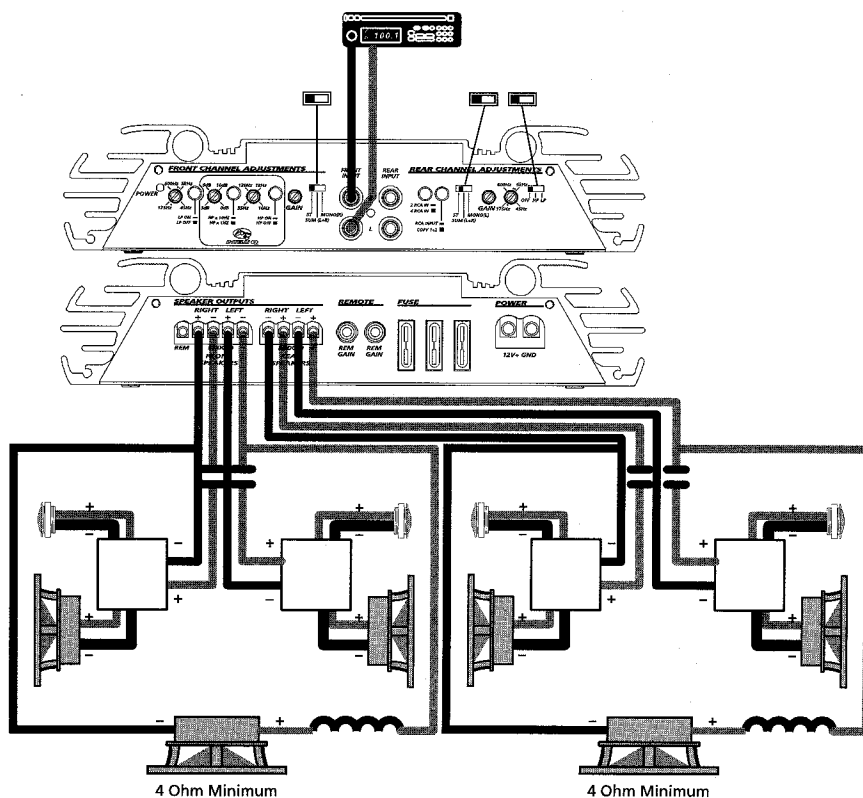

page 24

INSTALLATION TIPS

The installation of all ORION components will determine the overall performance result. Improper installation will not only limit the performance of your ORION system but also potentially compromise the reliability of this amplifier. To ensure proper sonic results and component reliability, please refer to your Authorized ORION dealer for installation assistance or advice. If you decide to perform the installation yourself, read the entire installation section of this manual before beginning installation.

TOOLS OF THE TRADE

Listed are the majority of the tools required to perform the installation. Having the proper tools will make the installation much easier. Some of these tools are necessities. Some make the job much easier.

- | | |
|---|-----------------------------|
| • marking pen | • heat shrink tubing |
| • electric drill with assorted drill bits | • nylon tie straps |
| • utility knife | • volt-ohm meter (optional) |
| • Phillips and flat blade screw drivers | • wire cutters |
| • pliers (standard and needle nose) | • wire crimpers |
| • wire brush or sandpaper for chassis grounding | • wire strippers |
| • solder iron and solder | |

page 25

MOUNTING THE XTR AMPLIFIER

The XTR amplifiers have a unique mounting system that can be configured for different install situations. By placing the removable mounting rails in the "in" or "out" positions the look of the amplifier mounting can be changed to suit personal tastes or installation requirements. In the "in" position, you will not see the amplifier mounting screws and the amp will "float" above the mounting screws. The amp can also be mounted in a "standard" manner using the "out" position.

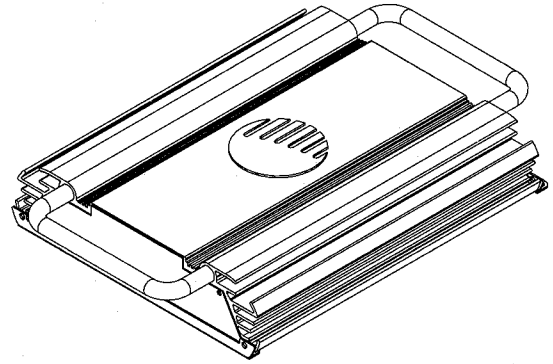

FIGURE A

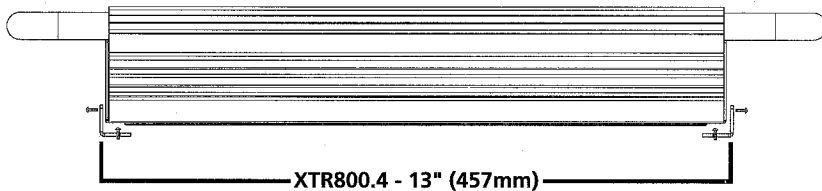

FIGURE A: This figure shows the mounting feet of the amplifier in the "in" position. To mount the amplifier in this manner you must mount just the two feet to the mounting surface before screwing them to the amp. The distance needed between the vertical sides of each foot is noted in the figure to the left. Simply measure the distance, mount the feet, then mount the amplifier to the feet.

FIGURE B

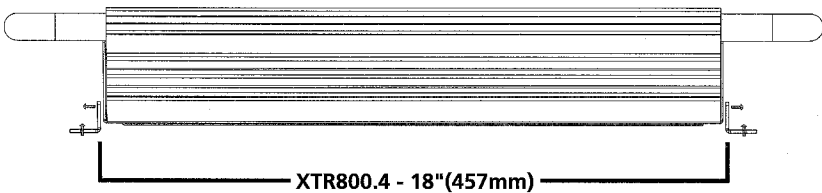
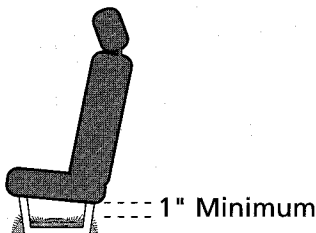

FIGURE B: This figure shows the mounting feet in the "out" position. This method can be accomplished by using the same procedure as above or by simply mounting the feet to the amplifier and mounting the amplifier to the surface as you would a "normal" amp.

page 26

CHOOSING MOUNTING LOCATIONS

The location of your XTREME amplifier will depend on several important issues. Due to the low profile size of the XTREME amplifiers, there are many possible installation locations that will yield satisfactory amplifier performance. Always mount the amplifier in a place that protects the amplifier from the elements. In addition, mount the amplifier on a stable, flat mounting surface. As with any amplifier, there are several possible mounting locations and configurations that can be optimal. We will cover the most obvious of situations.



PASSENGER COMPARTMENT

If you are going to mount the amplifier in the passenger compartment, make sure you have adequate room for ventilation. XTREME amplifiers have been designed to make possible under seat mounting. When mounting your amplifier under a seat or similar area, keep a minimum of 1" of clearance around the amplifier for adequate cooling.

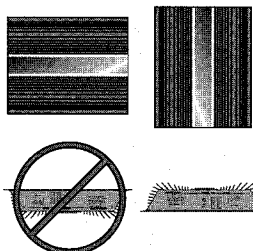

TRUNK COMPARTMENT

Mounting XTREME amplifier in the trunk provides excellent performance as long as you do not mount the amplifier upside down or restrict the airflow around the heatsink of the amplifier. For optimal results, mount the amplifier with the cooling fins in the vertical position. This type of mounting will yield the best cooling due to the convection effect of the amplifier chassis.



ENGINE COMPARTMENT MOUNTING

Do not mount XTREME amplifier in the engine compartment. The amplifier was not designed to endure the harsh environment of the exterior elements.

page 27

GENERAL PRECAUTIONS AND INSTALLATION TIPS

Caution: Be careful not to cut or drill into gas tanks, fuel lines, brake lines, hydraulic lines, vacuum lines, or electrical wiring when working on your vehicle.

Disconnect the vehicle's ground wire at the battery before making or breaking connections to the audio system's power supply terminals.

Do not use the XTREME amplifier unmounted. Failing to securely mount the amplifier can result in damage or injury, particularly in the event of an accident. An unmounted amplifier acts like a heat-seeking missile in the event of a crash. Never mount a XTREME amplifier where it might get wet. Mount the XTREME amplifier so the wire connections will not be pulled. Route the wires where they will not be scraped, pinched or damaged in any fashion.

The +12V power supply wire must be fused as close as possible to the battery terminal, ideally within 18". Use the recommended fuse size or circuit breaker listed in the **Power Connections** section of this manual.

If you need to replace the fuse plugged into the side of the XTREME amplifier, replace the fuse with the same size ATC type fuse that came with the amplifier. If you are not sure as to the correct value, refer to the **Power Connections** section of this manual for details. Using a higher current fuse may result in damage to the XTREME amplifier which is not covered under warranty.

NOTE: Make sure all the equipment in the system is turned off when making or breaking connections to the XTREME input RCAs or speakers terminals. Turn on the system and slowly turn up the volume control only after double checking all wire connections.

Power for systems with a single XTREME amplifier can be supplied by most any automotive electrical system. Systems with multiple amplifiers may require a higher capacity battery, alternator or the use of a storage capacitor. WE strongly recommend the use of both a Transient Storage Capacitor and a MBR70 with an extra battery in larger stereo systems.

XTREME amplifiers generate a certain amount of heat as part of normal operation. Be sure the area around the cooling fins is unobstructed to allow adequate air circulation. Remember, beach blankets, last weeks laundry, school books and homework papers located on top of the amplifier, do not improve air flow.

page 28

STEP BY STEP INSTALLATION

- Step 1 Determine the location for the amplifier. Refer to the **Mounting Locations** section in this manual for detailed information.
- Step 2 Decide on the system configuration for your amplifier. For system suggestions, refer to the **System Planning** section of this manual.
- Step 3 Run all the wires from the amplifier location to the speakers, source unit and battery. Do not connect the battery at this time. Be sure to run RCAs, power and speaker wires away from factory electrical wires and system as they pose a great potential for induced system noise.
- Step 4 Pre-drill amplifier mounting holes. Be sure to "think before you drill". Gas tanks, fuel lines, and other obstructions have a nasty way of hiding themselves. For best results use a marking pen to mark the mounting holes and pre-drill these holes with a standard 1/8" drill bit.
- Step 5 Mount the amplifier. Make sure the amplifier is mounted on a flat surface. If this is not possible, do not over tighten the screws such that the chassis of the amplifier is twisted or bent.
- Step 6 Turn the vehicle's key switch on the off position.
- Step 7 Disconnect the vehicle's battery ground terminal.
- Step 8 Connect the RCA and speaker wires to the amplifier. Check the quality of your speakers and signal connections. This will determine the ultimate performance of your ORION amplifier. Refer to the Input section of this manual for correct wiring instructions.
- Step 9 Connect power wires to the amplifier. At this time do not connect the fuse at the main battery.
- Step 10 Reconnect the ground terminal to the battery.
- Step 11 Set crossovers. Refer to the **Internal Crossover** Sections of this manual for detailed instructions.
- Step 12 Once satisfied that all connections and settings are correct, install the fuse at located near the vehicle's battery and proceed to the testing the system section of this manual.

WARNING! Never exceed the recommended fuse size of this amplifier. Failure to do so will result in the void of your warranty.

page 29

TESTING THE SYSTEM

After you have completed the installation, you need to test the system. This will help ensure years of trouble-free operation. Please refer to the listed steps below when testing the sound of your ORION XTREME system.

- Step 1 Check all the wiring connections to be sure they are correct and secure.
- Step 2 Turn the signal source volume control down all the way. Set any tone controls to their flat or defeated positions. This includes the loudness control.
- Step 3 Turn the level controls of the amplifier to their minimum positions.
- Step 4 Turn the source unit on. Check to see if the remote power LED located on the connection side of the amplifier is on. If not, please refer to the power connections section and the trouble shooting section of this manual for instructions.
- Step 5 If using an aftermarket source unit, turn the level controls of the amplifier about one quarter of a turn. Slowly increase the volume level of the source unit to so that you can hear the output of the system. If no sound is heard or if the output is distorted, turn the system off immediately. Refer to the power connections section and the trouble shooting section of this manual to solve your installation problems.
- Step 6 Check to make sure the output for each channel is correct. If the active crossovers are used, check to make sure that each output is correct from the amplifier. When using active crossovers on midrange and tweeters, do not use crossover frequencies lower than recommended. If the system is not configured properly, refer to the internal crossover section of this manual and take corrective action.
- Step 7 If the output is clear and undistorted, continue to the adjusting the sound of the system section of this manual.

page 30

ADJUSTING THE SOUND OF THE SYSTEM

Once you have checked the system's operation, adjust the sound of the system. Adjusting the sound of the system is accomplished by setting the level controls and adjusting the internal crossovers.

- Step 1 Turn the signal source volume control down all the way. Set any tone controls to their flat or defeated positions. This includes the loudness control.
- Step 2 Turn the level controls of the amplifier to their minimum positions.
- Step 3 Choose music with high dynamic content that you like and that you are familiar with and will be most often used in the system.
- Step 4 Turn the unit up to its highest undistorted output level. If you lack test equipment, this point occurs between 3/4 to full volume depending on the quality of your source unit. Listen for any audible distortion, if any distortion is audible, reduce the volume of the source unit until you have an undistorted output. Leave the volume control at this position during your system tuning.
- Step 5 While listening to your chosen dynamic music, turn up the level control corresponding to the midrange output until you hear slight distortion and turn back the level control slightly for an undistorted output. Depending on your system the midrange and tweeter output may be on the same output channels.
- Step 6 Turn up the level control corresponding to the tweeter output until you hear slight distortion and turn back the level control slightly for an undistorted output. Depending on your system the midrange and tweeter output may be on the same output channels.
- Step 7 Fine tune crossover setting and output level between midrange and tweeters. Refer to the internal crossover configuration section of this manual for detailed instructions.
- Step 8 Repeat Steps 5-7 for the rear speakers. If you do not have rear speakers continue to Step 10.
- Step 9 Set levels between the front and rear midrange and tweeters for optimum front/rear balance.
- Step 10 Turn up the level control corresponding to the woofer output until you hear slight distortion and turn back the level control slightly for an undistorted output.
- Step 11 Fine tune crossover setting and output level between satellite speakers and the woofers. Refer to the internal crossover configuration section of this manual for detailed instructions. If using an RGC-1, adjust the level to match the output of the woofer to the sonic requirements of the system.
- Step 12 Enjoy your awesome ORION sound system.

page 31

TROUBLESHOOTING TIPS

SYMPTOM	PROBABLE CAUSE	ACTION TO TAKE
No output	Low or no remote turn-on input	Check remote turn-on voltage output at amplifier and fix as needed.
	Fuse blown	Check power wire integrity and check for speaker shorts. Fix as needed and replace fuse.
	Power wires not connected	Check power wire and ground connections and fix or replace as needed.
	Audio input not connected	Check RCA connections and fix or replace as needed.
	Speaker wires not connected	Check speaker wires and fix or replace as needed.
	Speakers are blown	Check system with known working speaker and fix or replace speakers as needed.
Audio cycles on and off	Thermal protection engages when amplifier heatsink temperature exceeds 90°C (190°F)	Make sure there is proper ventilation for amplifier and improve ventilation as needed
	Loose or poor audio input	Check RCA connections and fix or replace as needed.
	Loose power connections	Check power wire and ground connections and fix or replace as needed.
Distorted output	Amplifier level sensitivity set too high of amplifier	Readjust gain. Refer to Adjusting the Sound of the System Exceeding maximum capability section of this manual for detailed instructions.
	Impedance load to amplifier too low	Check speaker impedance load, if below 2Ω stereo or 4Ω mono. rewire speakers to achieve a higher impedance.
	Shorted speaker wires	Check speaker wires connections and fix or replace as needed.
	Speaker not connected to amplifier properly	Check speaker wiring and fix or replace as needed. Refer to the Speaker Connections section of this manual for detailed instructions.

page 32

Distorted output section	Internal crossover not set properly	Readjust crossovers. Refer to the Internal Crossover configuration of this manual for detailed instructions.
	Speakers are blown	Check system with know working speakers and fix or replace as needed.
Poor bass response	Speakers wired with wrong polarity causing cancellation at low frequency	Check speaker polarity and fix as needed.
	Crossover set incorrectly	Reset crossovers. Refer to the Internal Crossover Configuration section of this manual for detailed instructions.
	Impedance load at amplifier is too low	Check speaker impedance load, if below 2 Ohm stereo or 4 Ohm mono rewire speakers to achieve a higher impedance.
Battery fuse blowing	Short in power wire or incorrect power connections.	Check power and ground connections and fix or repair as needed.
	Fuse used is smaller than recommended	Replace with proper fuse size.
	Too much current being drawn	Check speaker impedance load, if below 2 Ohm stereo or 4 Ohm mono rewire speakers to achieve a high impedance. Check power and ground connections and fix or repair as needed.
Amplifier fuse blowing	Too much current being drawn	Check speaker impedance load, if below 2Ω stereo or 4Ω mono rewire speakers to achieve a high impedance and replace with recommended size fuse. Check power and ground connections and fix or repair as needed.
	Fuse used is smaller than recommended	Replace with proper fuse size.
	Impedance load at amplifier too low	Check speaker impedance load. If below 2 Ohm stereo or 4 Ohm mono, rewir speakers to achieve a higher impedance.
	Speaker is blown with shorted outputs	Check system with known working speakers and fix or replace as needed

page 33

AUTOSOUND 2000 TROUBLESHOOTING TIPS

QUICK CHECK FOR TROUBLESHOOTING CAR AUDIO SYSTEMS

Preface:

All audio systems exhibit noise; however, if the level of noise is low enough, and the signal level high enough, noise should not be a problem. This means that it is very important that the signal level throughout the system be optimized BEFORE dealing with your noise problem. Using a scope (or a small portable amplifier) and Track 99 (1kHz at all high bits) of Autosound 2000's CD #101, or tracks 24 through 29 of Autosound 200's CD #102, adjust the system so that when the maximum usable signal level of the deck is fed into the system, all the preamp level components clip at the same time. However, we recommend up to as much as a 3:1 voltage overlap with the power amplifiers; i.e. an amplifier with a 2 volt minimum sensitivity can be driven by up to 6 volts of signal.

Noise Overview:

Car audio electrical accessories are notorious for interfering with car audio systems. The interference commonly arises from three areas:

- 1) Power line noise (5%), which can be attenuated with in-line noise filters,
- 2) Inadequate power supply isolation (45%), which can be cured with transformer signal coupling, additional isolated power supplies, or changing out components, or
- 3) Inductive interference (45%) - Including loop area inductive noise picked up by the signal cables - which can be remedied by relocating or rewiring components, rerouting signal cables, or using twisted cable or balanced transmission systems.

AUTOSOUND 2000 1-2-3 METHOD OF LOGICAL TROUBLESHOOTING

- I. **MUTE THE AMP(S).** Insert a muting plug (shorted male RCA connector) into each amplifier channel. Turn up the amp sensitivity. Start the car and turn on the headlights, air conditioning, brake lights, etc. Listen for noise in each speaker. Be very picky here!
 - A. If still noisy, substitute a small test speaker with short leads for the speakers, crossovers, and speaker leads in the car. If still noisy, substitute an isolated power supply (120 VAC to 13.8 VDC bench supply or a small motorcycle battery) for the car's alternator. If the amplifier is noisy with the test speaker, you have a BAD amp. Send it in. It really doesn't matter if it is quiet or noisy while running on the isolated supply because you have a BAD amp. Send it in for repair and if it was quiet on the isolated supply, indicate so on the repair tag.

page 34

- B. If your muted amp is quiet, you've just joined 99.5% of car audio. Amps are usually very clean and do NOT pick up unwanted noise! Continue on to Step II.
- II. **DECK TO AMP.** Using a new set of signal cables, connect one channel from the output of the deck directly into one channel of your clean amp. Run the cables outside the car and as far away as possible from the metal of the car. (For noise purposes, consider a 2" thick cushion of electromagnetic energy emanating from every metal surface in the car.)
 - A. If still noisy, congratulations, in all probability your equalizer, electronic crossover, DSP whatchamacallit, are just fine. This means that you can't get your deck playing quiet with your amp, right? go to Step III.
 - B. If all is quiet, congratulations, in all probability your deck and amplifier(s) are fine - you obviously have a problem with your equalizer, electronic crossover, DSP, etc. Skip on down to "Time for the Processors."
- III. **MOVE THE DECK.** If you're at this step, it is time to turn your system into an "amplified deck" by temporarily relocating the deck right ON TOP of the clean amplifier. Then using very, very short signal cables, connect the output of the deck into the input of the amp and test for noise. Play a zero bit track - silence - and make sure all is completely quiet.
 - A. If still noisy, you're in a heap of trouble, We suggest that you try another deck and give us a call so that we can put your name into the record books. It's a bad car audio day for you.
 - B. If the deck is quiet, then congratulations, you're on your way to a successful installation. It is now time to slowly, methodically, reinstall the deck back into its final position. Test for noise each step of the way. If the noise returns, suspect the signal cables, forget shielding because it will have only a very, minimal effect within the audio band. We highly suggest using twisted pair cables or a balanced transmission system for cable induced noise.

TIME FOR PROCESSORS

By the end of Step III, you should have the deck playing quietly with the amp, with the quiet cables quietly routed. So it's time to add the signal processors - one at a time - back into the system. Simply repeat Steps II and III with the equalizer, then the electronic crossover, etc. However, before **MOVING THE SIGNAL PROCESSORS** to the amplifier, we highly suggest that you supply power to the noisy processor from an isolated power supply rather than the car's +12 volt DC and chassis ground. Make sure to also connect the turn-on lead to the isolated power supply. If the processor is now quiet, then it is highly probable that the component has inadequate isolation. Solutions include, changing components or permanently adding an external isolated power supply (Call Autosound 2000 at 209-465-3450 for info on isolated power supplies).

page 35

SUMMATION

During the design stage of your vehicles, try to avoid using extra batteries and high output alternators. Extra batteries are nothing but loads as soon as the engine is started and high output alternators usually make more noise than stock alternators. Also, extra batteries installed in the trunk of a car will **ALWAYS** force extra ripple current to flow over the car.

Install Transient Storage as close to the power supply input of your amplifier as possible. The big caps will feed the switching power supplies of your amps and minimize the inductive losses in your power wiring. Plus, they will help your peak system response.

In problem cases, we highly recommend the use of twisted pair cable rather than coaxial cable for RCA leads. This practice will greatly minimize cable induced noise - especially in four channel amps!

Don't forget that your system is only as good as its worst component. Do **NOT** use components with inadequate power supply isolation or you will be asking for problems.

The best electrical ground on a car is the **CHASSIS** of the car. Do **NOT** run ground leads up to the case of the alternator or the negative battery post. Keep **ALL** ground leads as short as possible.

With properly isolated components, it does **NOT** matter where the component is grounded. With inadequately isolated components, it matters! With poorly isolated components, different grounds can cause different noises.

The deck is the signal reference ground for the entire sound system. The deck usually has **THREE** connections to the car's chassis: The black ground lead, the base of the antenna, and the metal-to-metal bond between the case of the deck and the chassis of the car. With three grounds, there is usually **NO** cause to worry about the ground of a deck.

Amplifiers are usually designed with adequate power supply isolation. This means that it should not matter where a deck is grounded. (Decks are grounded three times and amps float. This is car audio!)

The more components installed on a signal path, the more chances for noise to enter a system. The more electrical accessories on a car, the more noise will be produced by the alternator.

This information was compiled from more than 20 years of working in car audio. If you would like more information on this topic, or any other technical aspect of car audio, please call 209-465-3450 and ask for a subscription to Autosound 2000 Tech Briefs - the monthly magazine for the technically inclined.

page 36

NOTES:

Free Manuals Download Website

<http://myh66.com>

<http://usermanuals.us>

<http://www.somanuals.com>

<http://www.4manuals.cc>

<http://www.manual-lib.com>

<http://www.404manual.com>

<http://www.luxmanual.com>

<http://aubethermostatmanual.com>

Golf course search by state

<http://golfingnear.com>

Email search by domain

<http://emailbydomain.com>

Auto manuals search

<http://auto.somanuals.com>

TV manuals search

<http://tv.somanuals.com>