

# Packard Bell EasyNote LJ75/LJ77 Service Guide

Service guide files and updates are available on the ACER/CSD web; for more information, please refer to <http://csd.acer.com.tw>

PRINTED IN TAIWAN

---

## Revision History

Please refer to the table below for the updates made to this service guide.

Date	Chapter	Updates

---

## Copyright

Copyright © 2009 by Acer Incorporated. All rights reserved. No part of this publication may be reproduced, transmitted, transcribed, stored in a retrieval system, or translated into any language or computer language, in any form or by any means, electronic, mechanical, magnetic, optical, chemical, manual or otherwise, without the prior written permission of Acer Incorporated.

## Disclaimer

The information in this guide is subject to change without notice.

Acer Incorporated makes no representations or warranties, either expressed or implied, with respect to the contents hereof and specifically disclaims any warranties of merchantability or fitness for any particular purpose. Any Acer Incorporated software described in this manual is sold or licensed "as is". Should the programs prove defective following their purchase, the buyer (and not Acer Incorporated, its distributor, or its dealer) assumes the entire cost of all necessary servicing, repair, and any incidental or consequential damages resulting from any defect in the software.

Acer is a registered trademark of Acer Corporation.

Intel is a registered trademark of Intel Corporation.

Other brand and product names are trademarks and/or registered trademarks of their respective holders.

---

## Conventions

The following conventions are used in this manual:

<b>SCREEN MESSAGES</b>	Denotes actual messages that appear on screen.
<b>NOTE</b>	Gives bits and pieces of additional information related to the current topic.
<b>WARNING</b>	Alerts you to any damage that might result from doing or not doing specific actions.
<b>CAUTION</b>	Gives precautionary measures to avoid possible hardware or software problems.
<b>IMPORTANT</b>	Reminds you to do specific actions relevant to the accomplishment of procedures.

---

## Preface

Before using this information and the product it supports, please read the following general information.

1. This Service Guide provides you with all technical information relating to the BASIC CONFIGURATION decided for Acer's "global" product offering. To better fit local market requirements and enhance product competitiveness, your regional office MAY have decided to extend the functionality of a machine (e.g. add-on card, modem, or extra memory capability). These LOCALIZED FEATURES will NOT be covered in this generic service guide. In such cases, please contact your regional offices or the responsible personnel/channel to provide you with further technical details.
2. Please note WHEN ORDERING FRU PARTS, that you should check the most up-to-date information available on your regional web or channel. If, for whatever reason, a part number change is made, it will not be noted in the printed Service Guide. For ACER-AUTHORIZED SERVICE PROVIDERS, your Acer office may have a DIFFERENT part number code to those given in the FRU list of this printed Service Guide. You MUST use the list provided by your regional Acer office to order FRU parts for repair and service of customer machines.



<b>System Specifications</b>	<b>1</b>
Features .....	1
System Block Diagram .....	5
Your Notebook tour .....	6
Front View .....	6
Left View .....	7
Right View .....	8
Rear View .....	8
Bottom View .....	9
Keyboard Area (selected models) .....	10
LCD Panel .....	11
Status Indicators .....	12
TouchPad Basics .....	13
Using the Keyboard .....	14
Key Types .....	14
Windows Keys .....	15
System Keys .....	16
Hardware Specifications and Configurations .....	17
 <b>System Utilities</b>	 <b>27</b>
BIOS Setup Utility .....	27
Navigating the BIOS Utility .....	27
Information .....	28
Main .....	29
Advanced .....	30
Security .....	32
Power .....	35
Boot .....	37
Exit .....	38
BIOS Flash Utilities .....	39
DOS Flash Utility .....	40
WinFlash Utility .....	42
Remove HDD/BIOS Password Utilities .....	43
 <b>Machine Disassembly and Replacement</b>	 <b>49</b>
Disassembly Requirements .....	49
General Information .....	50
Pre-disassembly Instructions .....	50
Disassembly Process .....	50
External Module Disassembly Process .....	51
External Modules Disassembly Flowchart .....	51
Removing the Battery Pack .....	52
Removing the SD dummy card .....	53
Removing the Lower Covers .....	54
Removing the Optical Drive Module .....	55
Removing the DIMM Modules .....	57
Removing the WLAN Module .....	58
Removing the Primary HDD Module .....	60
Removing the Secondary HDD Module .....	62
Main Unit Disassembly Process .....	64
Main Unit Disassembly Flowchart .....	64
Removing the Switch Cover .....	65
Removing the Media Board .....	68
Removing the Keyboard .....	69

# Table of Contents

Removing the LCD Module . . . . .	71
Removing the Upper Cover . . . . .	76
Removing the TouchPad Bracket . . . . .	80
Removing the Media Board FFC . . . . .	81
Removing the LED Board . . . . .	82
Removing the Speaker Module . . . . .	83
Removing the RTC Battery . . . . .	85
Removing the Modem Board . . . . .	86
Removing the USB Board . . . . .	88
Removing the Mainboard . . . . .	90
Removing the RJ-11 Jack . . . . .	91
Removing the CPU Fan . . . . .	93
Removing the Thermal Module . . . . .	94
Removing the CPU . . . . .	95
LCD Module Disassembly Process . . . . .	96
LCD Module Disassembly Flowchart . . . . .	96
Removing the LCD Bezel . . . . .	97
Removing the Camera Module . . . . .	98
Removing the LCD Panel . . . . .	99
Removing the Power Board . . . . .	100
Removing the LCD Brackets and FPC Cable . . . . .	101
Removing the Microphone Module . . . . .	103
Removing the Antennas . . . . .	104
LCD Module Reassembly Procedure . . . . .	106
Replacing the Antennas, Power Board, and MIC . . . . .	106
Replacing the LCD Panel . . . . .	109
Replacing the Camera Module . . . . .	111
Replacing the LCD Bezel . . . . .	112
Main Module Reassembly Procedure . . . . .	114
Replacing the CPU . . . . .	114
Replacing the Thermal Module . . . . .	114
Replacing the CPU Fan . . . . .	115
Replacing the RJ-11 Jack . . . . .	116
Replacing the Mainboard . . . . .	117
Replacing the USB Board . . . . .	118
Replacing the Modem Board . . . . .	119
Replacing the Speaker Module . . . . .	120
Replacing the LED Board . . . . .	121
Replacing the Media Board FFC . . . . .	121
Replacing the TouchPad Bracket . . . . .	122
Replacing the Upper Cover . . . . .	122
Replacing the LCD Module . . . . .	126
Replacing the Keyboard . . . . .	129
Replacing the Media Board . . . . .	130
Replacing the Switch Cover . . . . .	131
Replacing the Hard Disk Drive Modules . . . . .	133
Replacing the WLAN Module . . . . .	134
Replacing the DIMM Modules . . . . .	134
Replacing the ODD Module . . . . .	135
Replacing the Lower Covers . . . . .	135
Replacing the SD Dummy Card . . . . .	137
Replacing the Battery . . . . .	137

## Troubleshooting

139

Common Problems . . . . .	139
---------------------------	-----



# Table of Contents

Power On Issue	140
No Display Issue	141
Random Loss of BIOS Settings	142
LCD Failure	143
Built-In Keyboard Failure	143
TouchPad Failure	144
Internal Speaker Failure	145
Internal Microphone Failure	147
HDD Not Operating Correctly	148
ODD Failure	149
USB (Right Side) Failure	153
Wireless Function Failure	154
Bluetooth Function Test Failure	155
Easy Button Failure	156
Thermal Unit Failure	157
External Mouse Failure	157
Other Failures	158
Motherboard CMOS Discharge	159
Intermittent Problems	159
Undetermined Problems	159
Post Codes	161
Chipset POST Codes	161
Sec:	161
Memory:	161
BDS & Specific action:	162
Each PEIM entry point used in 80_PORT	164
Each Driver entry point used in 80_PORT	164
Each SmmDriver entry point used in 80_PORT	167
<b>Jumper and Connector Locations</b>	<b>169</b>
Top View	169
Bottom View	170
LS-5022P USB Board	171
LS-5024P Cap Sensor Board	171
LS-5026P LED Board	171
LS-5027P SW Board	172
Clearing Password Check and BIOS Recovery	173
Clearing Password Check	173
BIOS Recovery by Crisis Disk	175
<b>FRU (Field Replaceable Unit) List</b>	<b>177</b>
Packard Bell EasyNote LJ75/LJ77 Exploded Diagrams	178
Main Assembly	178
Base Assembly	179
LCD Assembly	180
Packard Bell EasyNote LJ75/LJ77 FRU List	181
Screw List	188
<b>Model Definition and Configuration</b>	<b>190</b>
Packard Bell EasyNote LJ75 Series	190
Packard Bell EasyNote LJ77 Series	199
<b>Test Compatible Components</b>	<b>201</b>
Microsoft® Windows® 7 Environment Test	202

## ***Table of Contents***

<b>Online Support Information</b>	<b>207</b>
<b>Index</b>	<b>209</b>

# System Specifications

---

## Features

Below is a brief summary of the computer's many features:

**NOTE:** Specifications denoted with an asterisk (\*) vary depending on the model.

## Operating System

- Genuine Windows® 7 Home Premium 64-bit\*
- Genuine Windows® 7 Home Basic 64-bit\*

## Platform

- Intel® Core™ i7-620M processor (4 MB L3 cache, 2.66 GHz with Turbo Boost up to 3.33 GHz, DDR3 1066 MHz, 35 W), supporting Intel® 64 architecture, Intel® Smart Cache\*
- Intel® Core™ i5-430M/i5-520M/i5-540M processor (3 MB L3 cache, 2.26/2.40/2.53 GHz with Turbo Boost up to 2.53/2.93/3.06 GHz, DDR3 1066 MHz, 35 W), supporting Intel® 64 architecture, Intel® Smart Cache\*
- Intel® Core™ i3-330M/i3-350M processor (3 MB L3 cache, 2.13/2.26 GHz, DDR3 1066 MHz, 35 W), supporting Intel® 64 architecture, Intel® Smart Cache\*
- Mobile Intel® HM55 Express Chipset

## System Memory

- Dual-channel DDR3 SDRAM support:
- Up to 4 GB of DDR3 1066 MHz memory, upgradeable to 8 GB using two soDIMM modules\*

## Display

- 15.6" HD 1600 x 900 pixel resolution, high-brightness (220-nit) TFT LCD with Diamond View Technology, supporting simultaneous multi-window viewing
- 16:9 aspect ratio
- 8 ms response time

## Graphics\*

- ATI Mobility Radeon™ HD 56506 with up to 4091 MB of HyperMemory™ (1024 MB of dedicated DDR3 VRAM, up to 3067 MB of shared system memory), supporting Unified Video Decoder (UVD), OpenEXR High Dynamic-Range (HDR) technology, Shader Model 5.0, Microsoft® DirectX® 11, OpenGL® 3.1, OpenCL™ 1.1
- ATI Mobility Radeon™ HD 54706 with up to 3579 MB of HyperMemory™ (512 MB of dedicated DDR3 VRAM, up to 3067 MB of shared system memory), supporting Unified Video Decoder (UVD), OpenEXR High Dynamic-Range (HDR) technology, Shader Model 5.0, Microsoft® DirectX® 11, OpenGL® 3.1, OpenCL™ 1.1
- Intel® Core i7-620M/i5-540M/i5-520M/i5-430M/i3-350M/ i3-330M processor with Intel® Graphics Media Accelerator HD7 (Intel® GMA HD), 128 MB of dedicated system memory, Microsoft® DirectX® 10

- 
- Dual independent display support
  - 16.7 million colors
  - External resolution / refresh rates\*:
    - VGA port up to 2048 x 1536: 85 Hz
    - HDMI™ port up to 1920 x 1200: 60 Hz
  - MPEG-2/DVD decodingVC-1 and H.264 (AVC) decodingMicrosoft® DirectX Video Acceleration (DXVA) application interface (API)
  - HDMI™(High-Definition Multimedia Interface) with HDCP (High-bandwidth Digital Content Protection) support

## Storage subsystem\*

- One or two 160/250/320/500/640 GB or larger hard disk drives
- Multi-in-1 card reader, supporting:
  - Secure Digital™ (SD) Card, MultiMediaCard (MMC), Memory Stick™ (MS), Memory Stick PRO™ (MS PRO), xD-Picture Card™ (xD)

## Optical Drive\*

- 4X Blu-ray Disc™/DVD-Super Multi double-layer drive:
  - Read: 24X CD-ROM, 24X CD-R, 24X CD-RW, 8X DVD-ROM, 8X DVD-R, 8X DVD+R, 8X DVD-ROM DL, 6X DVD-R DL, 6X DVD+R DL, 8X DVD-RW, 8X DVD+RW, 5X DVD-RAM, 4X BD-ROM, 4X BD-R, 2X BD-RE, 4X BD-ROM DL, 4X BD-R DL, 2X BD-RE DL
  - Write: 24X CD-R, 16X CD-RW, 8X DVD-R, 8X DVD+R, 6X DVD-RW, 6X DVD+RW, 5X DVD-RAM, 4X DVD+R DL, 4X DVD-R DL
- 8X DVD Super Multi double-layer drive:
  - Read: 24X CD-ROM, 24X CD-R, 24X CD-RW, 8X DVD-ROM, 8X DVD-R, 8X DVD+R, 6X DVD-ROM DL, 6X DVD-R DL, 6X DVD+R DL, 6X DVD-RW, 6X DVD+RW, 5X DVD-RAM
  - Write: 24X CD-R, 16X CD-RW, 8X DVD-R, 8X DVD+R, 4X DVD-R DL, 4X DVD+R DL, 6X DVD-RW, 8X DVD+RW, 5X DVD-RAM

## Audio

- Two built-in stereo speakers
- High-definition audio support
- S/PDIF (Sony/Philips Digital Interface) support for digital speakers
- Built-in microphone
- MS-Sound compatible

## Dimensions and Weight

- 372 (W) x 259 (D) x 26/37 (H) mm (14.66 x 10.19 x 1.02/1.46 inches)
- 2.65 kg (5.84 lbs.) with 6-cell battery

## Communication

- Video conferencing solution, featuring:
- Webcam with 640 x 480 resolution
- WLAN\*:

- 
- 802.11b/g/n Wi-Fi CERTIFIED™
  - 802.11b/g Wi-Fi CERTIFIED™
  - WPAN\*: Bluetooth® 2.1+EDR
  - LAN: Gigabit Ethernet, Wake-on-LAN ready
  - Modem: 56K ITU V.92 with PTT approval\*

## Privacy control

- BIOS user, supervisor, HDD passwords
- Kensington lock slot

## Power

- ACPI 3.0 CPU power management standard: supports Standby and Hibernation power-saving modes
- 4400 mAh 6-cell Li-ion battery pack with integrated graphics:
  - 3-hour 10-minute battery life\*
  - 3-pin 65 W AC adapter
- 4400 mAh 6-cell Li-ion battery pack with discrete graphics:
  - 2-hour 50-minute battery life\*
  - 3-pin 90 W AC adapter
- ENERGY STAR®

## Special Keys and Controls

- 99-/100-/103-key keyboard
- Multi-gesture touchpad, supporting two-finger scroll, pinch, rotate, flip
- Nine function keys, four cursor keys, Windows® key, international language support
- Capacitive-touch launch keys: programmable, backup, touchpad lock, WLAN, volume up/down/mute

## I/O Ports

- Multi-in-1 card reader
- Four USB 2.0 ports
- HDMI™ port with HDCP support\*
- External display (VGA) port
- Headphone/speaker/line-out jacks with S/PDIF support
- Microphone-in jack
- Ethernet (RJ-45) port
- Modem (RJ-11) port\*
- DC-in jack for AC adapter

## Software\*

- Packard Bell Customer Registration
- Packard Bell Identity Card

- 
- Packard Bell InfoCentre
  - Packard Bell MyBackup Solution
  - Packard Bell Recovery Management
  - Packard Bell Updater
  - Adobe® Flash® Player 9
  - Adobe® Photoshop® Elements 7
  - Adobe® Reader® 9
  - CyberLink® Blu-ray Disc™ / DVD Solution™, featuring PowerDVD™eBay® desktop shortcut
  - Google Toolbar™
  - Metaboli linkMicrosoft® Works with Office Home and Student 2007 Trial
  - Nero® 9 EssentialsNorton Internet Security™ 2009 Trial (60 days)
  - Windows Live™ Essentials

## Optional

- Bluetooth® 2.1 module1 GB / 2 GB / 4 GB DDR3 1066 MHz soDIMM module
- 4400 mAh 6-cell Li-ion battery pack
- 3-pin 90 W AC adapter (discrete)
- 3-pin 65 W AC adapter (integrated)

## Environment

- Temperature:
  - Operating: 5 °C to 35 °C
  - Non-operating: -20 °C to 65 °C
- Humidity (non-condensing):
  - Operating: 20% to 80%
  - Non-operating: 20% to 80%

# System Block Diagram

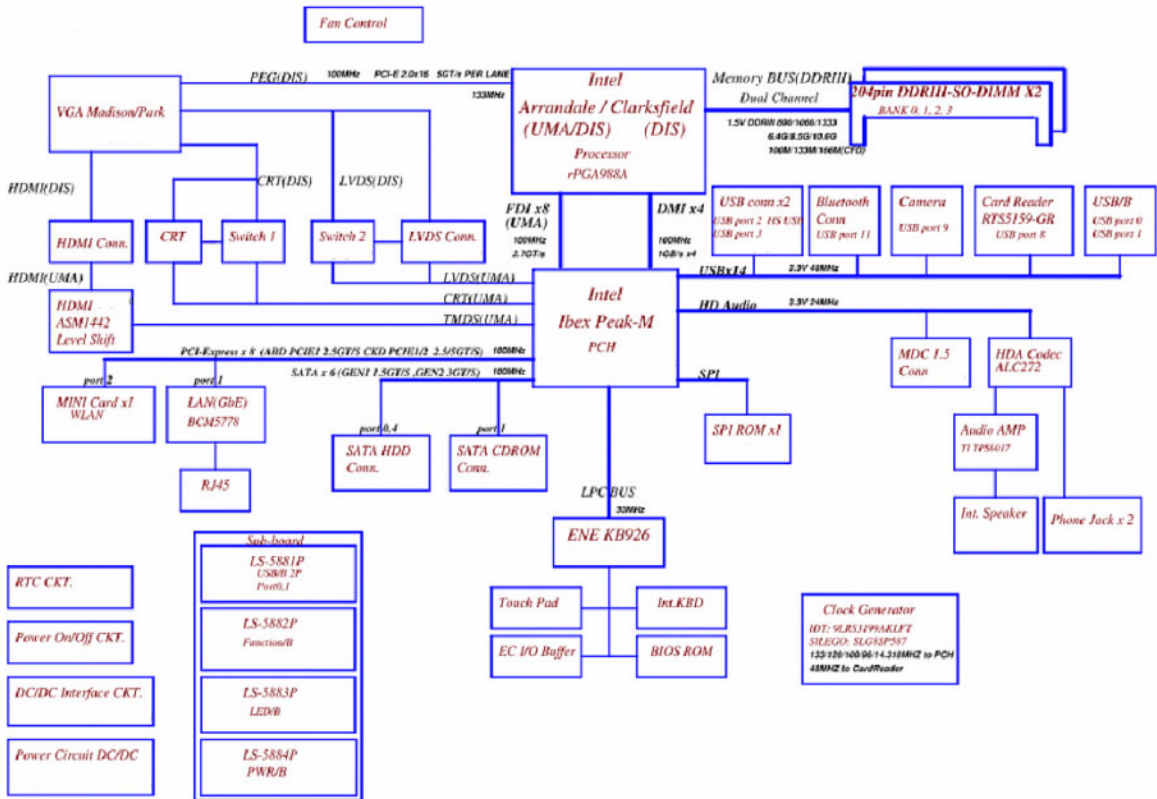

---

# Your Notebook tour

**NOTE:** Port placement may vary depending on the model.

## Front View

Component	Icon	Description



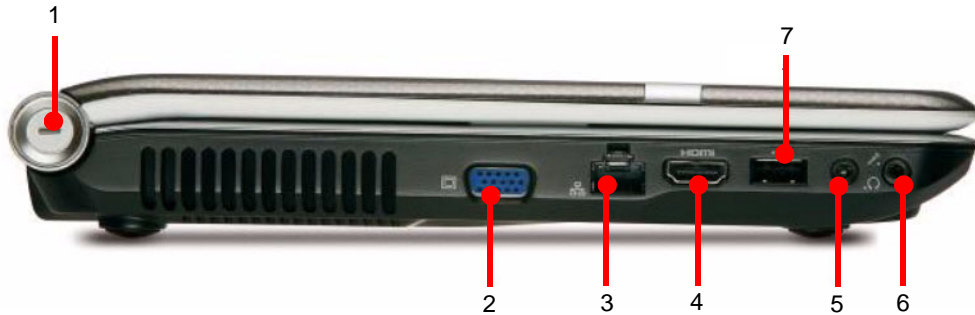

## Left View



No.	Component	Icon	Description
1	Kensington™ lock slot		Secure your notebook to an object by connecting a Kensington cable lock to this slot.
2	Monitor port		Plug an analog VGA monitor or projector into this port.
3	Ethernet jack		Plug an Ethernet network cable into this jack. Plug the other end of the cable into a cable modem, DSL modem, or an Ethernet network jack.
4	HDMI out jack	<b>HDMI</b>	HDMI Plug an HDMI device, such as a high definition television, into this optional jack.
5	Microphone jack		Plug a microphone into this jack.
6	Headphone jack		Plug amplified speakers or headphones into this jack. The built-in speakers are turned off when speakers or headphones are plugged into this jack. <ul style="list-style-type: none"> <li>Headphone with SPDIF support</li> </ul>
7	USB port		Plug USB devices (such as a diskette drive, flash drive, printer, scanner, camera, keyboard, or mouse) into these ports.

## Right View







No.	Component	Icon	Description
1	Blu-Ray Disc Drive		Insert CDs or DVDs into this drive.
2	USB ports (2)		Plug a USB device (such as a diskette drive, flash drive, printer, scanner, camera, keyboard, or mouse) into this port.
3	Power button		Press to turn the power on or off. You can also configure the power button for Sleep/Resume mode.

## Rear View

Component	Icon	Description
Ventilation fan		<p>Helps cool internal components.</p> <p><b>Warning:</b> Do not work with the notebook resting on your lap. If the air vents are blocked, the notebook may become hot enough to harm your skin.</p> <p><b>Caution:</b> Do not block or insert objects into these slots. If these slots are blocked, your notebook may overheat resulting in unexpected shutdown or permanent damage to the notebook.</p> <p><b>Caution:</b> Provide adequate space around your notebook so air vents are not obstructed. Do not use the notebook on a bed, sofa, rug, or other similar surface.</p>

---

## Bottom View

Component	Icon	Description
Battery		Provides power when the notebook is not plugged into AC power.
Battery lock		Slide to unlock the battery.
Battery latch		Slide to release the battery.
Memory bay		Memory modules are located in this bay.
Hard drive bay		The hard drive is located in this bay.
Ventilation slots and cooling fan		<p>Helps cool internal components.</p> <p><b>Warning:</b> Do not work with the notebook resting on your lap. If the air vents are blocked, the notebook may become hot enough to harm your skin.</p> <p><b>Caution:</b> Do not block or insert objects into these slots. If these slots are blocked, your notebook may overheat resulting in unexpected shutdown or permanent damage to the notebook.</p> <p><b>Caution:</b> Provide adequate space around your notebook so air vents are not obstructed. Do not use the notebook on a bed, sofa, rug, or other similar surface.</p>

## Keyboard Area (selected models)

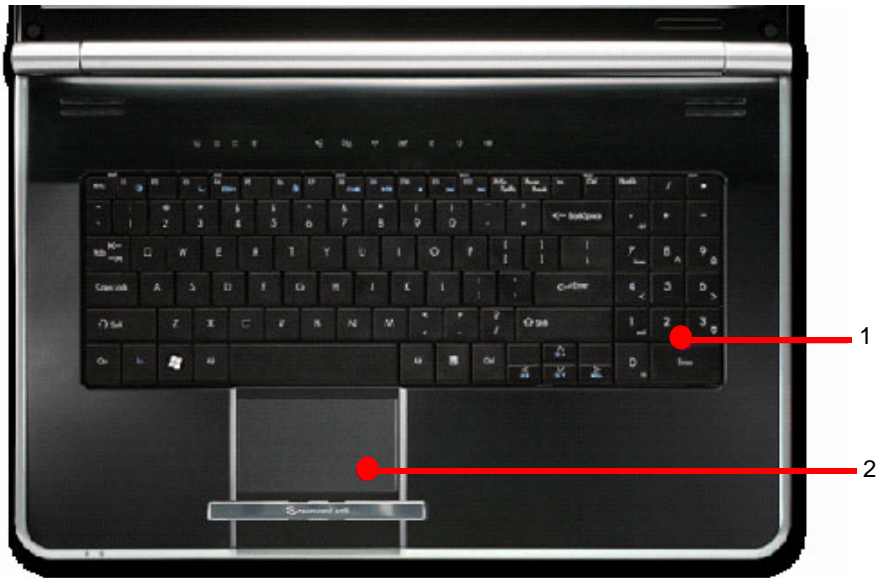

No.	Component	Description
1	Capacitive touch keys	Press to access capacitive touch key function.
2	Touchpad	Provides all the functionality of a mouse.

---

## LCD Panel

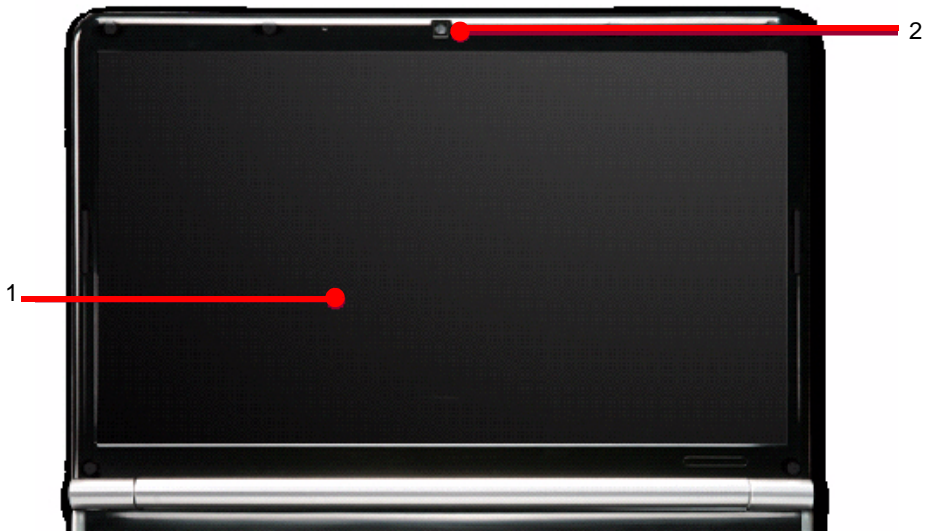





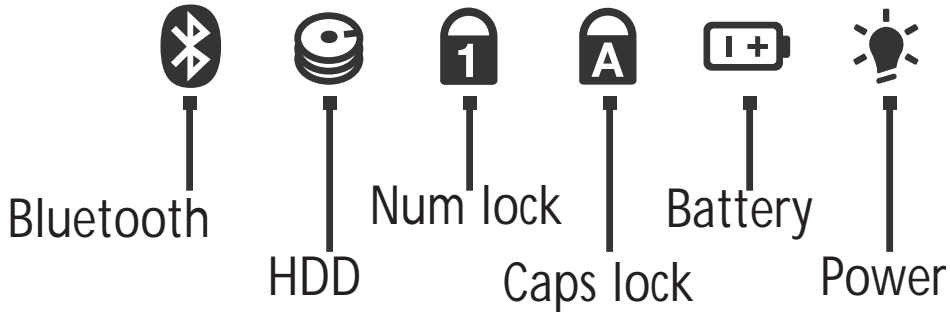

No.	Component	Description
1	Display	15.6" HD 1600 x 900 pixel resolution, high-brightness (220-nit) TFT LCD with Diamond View Technology
2	Webcam	Use to let others see who they are communicating with when making VoIP calls.

## Status Indicators

Status indicators inform you when a drive is being used or when a button has been pressed that affects how the keyboard is used. The status indicators are located below the screen.



Indicator	Icon	Description
Bluetooth		<ul style="list-style-type: none"> <li>LED on - Bluetooth communication is turned on</li> <li>LED off - Bluetooth communication is turned off</li> </ul>
Hard drive or disk drive		<ul style="list-style-type: none"> <li>LED blinking - The drive is being accessed</li> <li>LED off - The drive is not being accessed</li> </ul>
Num lock		<ul style="list-style-type: none"> <li>LED on - Num lock is turned on</li> <li>LED off - Num lock is turned off</li> </ul>
Caps lock		<ul style="list-style-type: none"> <li>LED on - Caps lock is turned on</li> <li>LED off - Caps lock is turned off</li> </ul>
Battery charge indicator		<ul style="list-style-type: none"> <li>LED blue - Battery is fully charged</li> <li>LED red - Battery is charging</li> </ul> <p><b>Important:</b> This LED only lights up when your notebook is connected to AC power.</p>
Power indicator		<ul style="list-style-type: none"> <li>LED on - Notebook is on.</li> <li>LED blinking - Notebook is in Sleep or Hybrid Sleep mode.</li> <li>LED off - Notebook is off.</li> </ul>

---

# TouchPad Basics

The following items show you how to use the TouchPad:

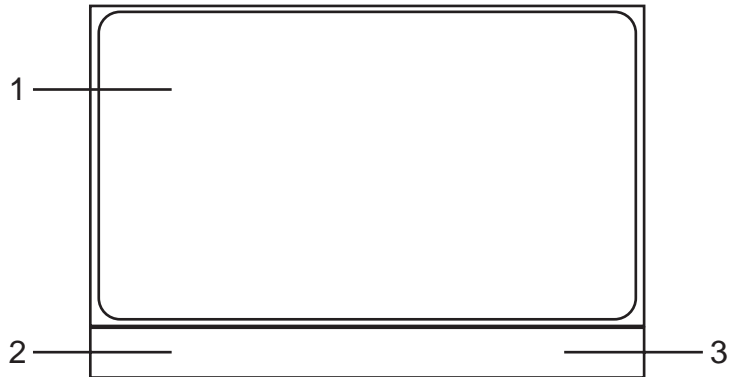

- Move your finger across the TouchPad (1) to move the cursor.
- Press the left (2) and right (3) buttons located beneath the TouchPad to perform selection and execution functions. These two buttons are similar to the left and right buttons on a mouse. Tapping on the TouchPad is the same as clicking the left button.

Function	Left Button (2)	Right Button (3)	Main TouchPad (1)
Execute	Quickly click twice.		Tap twice (at the same speed as double-clicking a mouse button).
Select	Click once.		Tap once.
Drag	Click and hold, then use finger on the TouchPad to drag the cursor.		Tap twice (at the same speed as double-clicking a mouse button); rest your finger on the TouchPad on the second tap and drag the cursor.
Access context menu		Click once.	

**NOTE:** When using the TouchPad, keep it - and your fingers - dry and clean. The TouchPad is sensitive to finger movement; hence, the lighter the touch, the better the response. Tapping too hard will not increase the TouchPad's responsiveness.

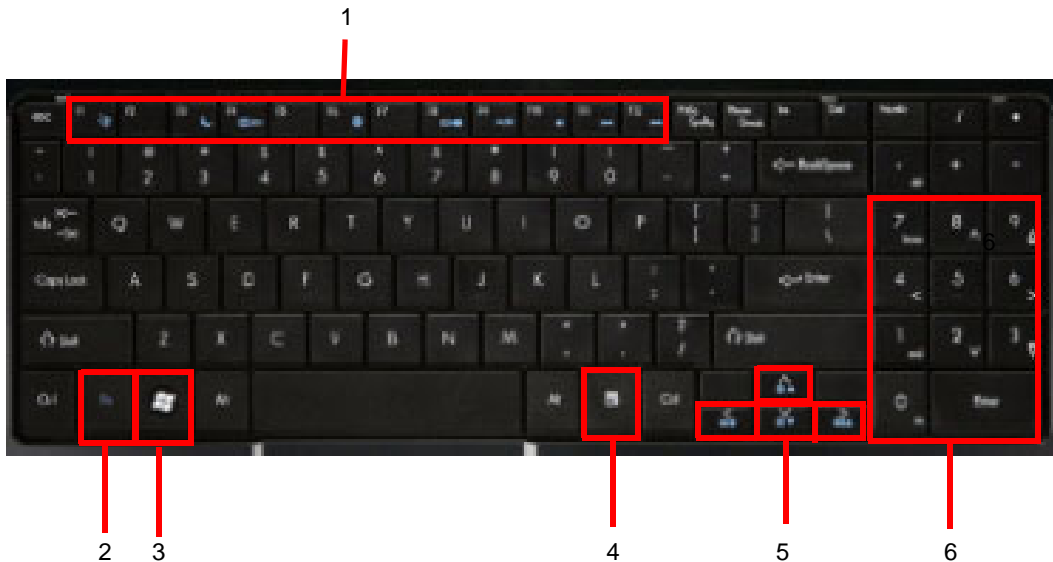

# Using the Keyboard

Your notebook features a full-size keyboard that functions the same as a desktop computer keyboard. Many of the keys have been assigned alternate functions, including shortcut keys for Windows, function keys for specific system operations, and the Num Lock keys for the numeric keypad.



## Key Types



















The keyboard has several different types of keys. Some keys perform specific actions when pressed alone and other actions when pressed in combination with another key.

No.	Icon	Key Type	Description
1		Function keys	Press these keys labeled F1 to F12 to perform actions in programs. For example, pressing F1 may open help. Each program uses different function keys for different purposes. See the program documentation to find out more about the function key actions.
		System keys	Press these colored keys in combination with the Fn key to perform specific actions. See "System Keys" on page 16.
2		Fn key	Press the Fn key in combination with a colored system key to perform a specific action.
3		Windows key	Press this key to open the Windows Start menu. This key can also be used in combination with other keys to open utilities. See "Windows Keys" on page 15.
4		Application key	Press this key for quick access to shortcut menus and help assistants in Windows.
5		Arrow keys	Press these keys to move the cursor up, down, right, or left.
6		Navigation keys	Press these keys to move the cursor to the beginning of a line, to the end of a line, up the page, down the page, to the beginning of a document, or to the end of a document.



# Windows Keys











The keyboard has two keys that perform Windows-specific functions.

Key	Description
 Windows key	<p>Pressed alone, this key has the same effect as clicking on the Windows Start button; it launches the Start menu. It can also be used with other keys to provide a variety of functions:</p> <ul style="list-style-type: none"><li>&lt;&gt;: Open or close the Start menu</li><li>&lt; + &lt;<b>D</b>&gt;: Display the desktop</li><li>&lt; + &lt;<b>E</b>&gt;: Open Windows Explore</li><li>&lt; + &lt;<b>F</b>&gt;: Search for a file or folder</li><li>&lt; + &lt;<b>G</b>&gt;: Cycle through Sidebar gadgets</li><li>&lt; + &lt;<b>L</b>&gt;: Lock your computer (if you are connected to a network domain), or switch users (if you're not connected to a network domain)</li><li>&lt; + &lt;<b>M</b>&gt;: Minimizes all windows</li><li>&lt; + &lt;<b>R</b>&gt;: Open the Run dialog box</li><li>&lt; + &lt;<b>T</b>&gt;: Cycle through programs on the taskbar</li><li>&lt; + &lt;<b>U</b>&gt;: Open Ease of Access Center</li><li>&lt; + &lt;<b>X</b>&gt;: Open Windows Mobility Center</li><li>&lt; + &lt;<b>BREAK</b>&gt;: Display the System Properties dialog box</li><li>&lt; + &lt;<b>SHIFT+M</b>&gt;: Restore minimized windows to the desktop</li><li>&lt; + &lt;<b>TAB</b>&gt;: Cycle through programs on the taskbar by using Windows Flip 3-D</li><li>&lt; + &lt;<b>SPACEBAR</b>&gt;: Bring all gadgets to the front and select Windows Sidebar</li><li>&lt;<b>CTRL</b>&gt; + &lt; + &lt;<b>F</b>&gt;: Search for computers (if you are on a network)</li><li>&lt;<b>CTRL</b>&gt; + &lt; + &lt;<b>TAB</b>&gt;: Use the arrow keys to cycle through programs on the taskbar by using Windows Flip 3-D</li></ul> <p><b>Note:</b> Depending on your edition of Windows 7, some shortcuts may not function as described.</p>

## System Keys

The computer employs hotkeys or key combinations to access most of the computer's controls like screen brightness, Bluetooth and WiFi.

To activate hot keys, press and hold the <Fn> key before pressing the other key in the hotkey combination.

Function Key	Description
	Turn the capacitive touch key LEDs on or off.
	Enter Sleep mode or Hybrid Sleep mode. Press the power button to leave Sleep mode.
	Toggle the notebook display in the following order: The LCD. An external monitor or projector (a monitor or projector must be plugged into the monitor port or HDMI port on your notebook). Both displays at the same time.
	Turn the optional Bluetooth radio on or off. Warning: Radio frequency wireless communication can interfere with equipment on commercial aircraft. Current aviation regulations require wireless devices to be turned off while traveling in an airplane. Bluetooth communication devices are examples of devices that provide wireless communication. Important: The wireless network switch must be in the ON position for this button to work.
	Mute the sound. Press the key combination again to restore the sound.
	Turns the display screen backlight off to save power. Press any key to return.
	Play/ Pause—Plays or pauses the CD or DVD.
	Stop—Stops playing the CD or DVD.
	Previous—Skips back one CD track or DVD chapter.
	Next—Skips ahead one CD track or DVD chapter.

# Hardware Specifications and Configurations

## Processor

Item	Specification
CPU	Intel Mobile Calpella rPGA988A
Core Logic	Intel Ibox Peak-M (HM55)
Power	See table below
On-die Cache	<ul style="list-style-type: none"> <li>A 32-KB instruction and 32-KB data first-level cache (L1) for each core</li> <li>A 256-KB shared instruction/data second-level cache (L2) for each core</li> <li>Up to 4-MB shared instruction/data third-level cache (L3), shared among all cores</li> </ul>
Front Side Bus	See table below

## Processor Specifications

Item	CPU Speed	Cores	Bus Speed	Cache Size	Package	Core Voltage	Acer P/N
Ci3330M	2.13 GHz	2	330 M	3 MB	PGA	35 W	KC.33001.DMP
Ci3350M	2.26 GHz	2	350 M	3 MB	PGA	35 W	KC.35001.DMP
Ci5430M	2.26 GHz	2-4	430 M	3 MB	PGA	35 W	KC.43001.DMP
Ci5520M	2.4 GHz	2-4	520 M	3 MB	PGA	35 W	KC.52001.DMP
Ci5540M	2.53 GHz	2-4	540 M	3 MB	PGA	35 W	KC.54001.DMP
Ci7620M	2.66 GHz	4	620 M	4 MB	PGA	35 W	KC.62001.DMP

## CPU Fan True Value Table)

(DIS)					
CPU Temperature				Fan Speed (RPM)	SPL Spec (dBA)
Core 0	Core 1	Core 2	Core 3		
48	48	48	48	2400	28
60	60	60	60	2900	31
70	70	70	70	3100	34
85	85	85	85	3400	37
99	99	99	99	3700	40
104	104	104	104	3700	40
Throttling 50%: On= 99°C; OFF=88°C					
OS shut down at 104°C; H/W shut down at 92°C					

(UMA)					
CPU Temperature				Fan Speed (RPM)	SPL Spec (dBA)
Core 0	Core 1	Core 2	Core 3		
48	48	48	48	2600	28
60	60	60	60	2800	31
70	70	70	70	3100	34
85	85	85	85	3400	37
99	99	99	99	3800	40
104	104	104	104	3800	40
Throttling 50%: On= 99°C; OFF=88°C					
OS shut down at 104°C; H/W shut down at 92°C					

## Northbridge

Item	Specifications
Chipset	Intel Ibex Peak-M (HM55)
Features	<ul style="list-style-type: none"><li>• Dual-channel DDR3 1066 MHz memory support</li><li>• Serial ATA</li><li>• Hi-Speed USB 2.0 connectivity</li></ul>

## BIOS

Item	Specification
BIOS vendor	Insyde H20
BIOS Version	V0.07
BIOS ROM type	Flash
Features	<ul style="list-style-type: none"><li>• Flash ROM 1MB</li><li>• Support ISIPP</li><li>• Support Acer UI</li><li>• Support multi-boot</li><li>• Suspend to RAM (S3)/Disk (S4)</li><li>• Various hot-keys for system control</li><li>• Support SMBUS 2.0, PCI2.3</li><li>• ACPI 2.0 compliance with Intel Speed Step Support C1, C2, C3, C4,C6 and S3, S4 for mobile CPU</li><li>• DMI utility for BIOS serial number configurable/asset tag</li><li>• Support PXE</li><li>• Support Y2K solution</li><li>• Support Win Flash Wake on LAN from S3</li><li>• Wake on LAN form S4 in AC mode</li><li>• System information</li></ul>

## System Memory

Item	Specification
Memory controller	Intel HM55
Memory size	4 GB
DIMM socket number	2
Supports memory size per socket	4 GB (4 GB for 64-bit OS)
Supports maximum memory size	8 GB (8 GB for 64-bit OS)
Supports DIMM type	DDRIII
Supports DIMM Speed	1066 MHz
Supports DIMM voltage	1.5V
Cache	3-4 MB L3

## Memory Combinations

Slot 1	Slot 2	Total Memory
0MB	512MB	512MB
0MB	1024MB	1024MB
0MB	2048MB	2048MB
512MB	512MB	1024MB
512MB	1024MB	1536MB
512MB	2048MB	2560MB
1024MB	0MB	1024MB
1024MB	512MB	1536MB
1024MB	1024MB	2048MB
1024MB	2048MB	3072MB
2048MB	0MB	2048MB
2048MB	512MB	2560MB
2048MB	1024MB	3072MB
2048MB	2048MB	4096MB
4096MB	4096MB	8192MB

**NOTE:** Above table lists some system memory configurations. You may combine DIMMs with various capacities to form other combinations. On above table, the configuration of slot 1 and slot 2 could be reversed.

## Graphics Controller

Item	Specification		
VGA Chip	ATI Mobility Radeon™ HD 5650	ATI Mobility Radeon™ HD 5470	Intel® Graphics Media Accelerator HD7 (Intel® GMA HD)
Graphics Memory	1024 MB of dedicated DDR3 VRAM, up to 3067 MB of shared system memory	512 MB of dedicated DDR3 VRAM, up to 3067 MB of shared system memory	128 MB of dedicated system memory
Supports	<ul style="list-style-type: none"> <li>Unified Video Decoder (UVD)</li> <li>OpenEXR High Dynamic-Range (HDR) technology</li> <li>Shader Model 5.0</li> <li>Microsoft® DirectX® 11</li> <li>OpenGL® 3.1</li> <li>OpenCL™ 1.1</li> </ul>	<ul style="list-style-type: none"> <li>Unified Video Decoder (UVD)</li> <li>OpenEXR High Dynamic-Range (HDR) technology</li> <li>Shader Model 5.0</li> <li>Microsoft® DirectX® 11</li> <li>OpenGL® 3.1</li> <li>OpenCL™ 1.1</li> </ul>	<ul style="list-style-type: none"> <li>Microsoft® DirectX® 10</li> </ul>
Resolution	External resolution / refresh rates: <ul style="list-style-type: none"> <li>VGA port up to 2048 x 1536: 85 Hz</li> <li>HDMI™ port up to 1920 x 1200: 60 Hz</li> </ul>		
Features	<ul style="list-style-type: none"> <li>Dual independent display support</li> <li>16.7 million colors</li> <li>MPEG-2/DVD decoding</li> <li>VC-1 and H.264 (AVC) decoding</li> <li>Microsoft® DirectX Video Acceleration (DXVA) application interface (API)</li> <li>HDMI™ (High-Definition Multimedia Interface) with HDCP (High-bandwidth Digital Content Protection) support</li> </ul>		

### LAN Interface

Item	Specification
LAN Chipset	Broadcom BCM57780
LAN connector type	RJ45
LAN connector location	Left side
Features	Support for 10/100/1000*

\*Check model number for specifications.

### Wireless Module 802.11b/g

Item	Specification
Manufacturer/Model	<ul style="list-style-type: none"><li>Realtek 8192SE</li><li>Atheros HB93</li></ul>

### Bluetooth

Item	Specification
Model	Foxconn Bluetooth BRM 2046 BT2.1 (T60H928.33) f/w:861

### Hard Disk Drive Interface

Item	Specification
Vendor	Seagate
Capacity (MB)	250   500
Bytes per sector	512
Data heads	2/4
Drive Format	
Disks	2   2
Spindle speed (RPM)	5,400
Performance Specifications	
Buffer size	8 MB
Interface	SATA
Internal transfer rate (Mbits/sec max)	830   1175
I/O data transfer rate (Mbytes/sec max)	300
DC Power Requirements	
Voltage tolerance	5V(DC) +/- 5%

Item	Specifications
Vendor & Model Name	Toshiba
Capacity	250GB
Bytes per sector	512
Data heads	4/2
Drive Format	
Disks	2/1
Spindle speed (RPM)	5400
Performance Specifications	
Buffer size	8MB
Interface	SATA
Internal transfer rate (Mbits/sec, max)	363 ~ 952 typical
I/O data transfer rate	3Gbits/s
DC Power Requirements	
Voltage	+5.0V ± 5%.

Item	Specifications			
Vendor & Model Name	HGST			
Capacity (MB)	500	320	250	160
Bytes per sector	512			
Data heads	4	3	2	2
Drive Format				
Disks	2	2	1	1
Spindle speed (RPM)	5400			
Performance Specifications				
Buffer size	8MB			
Interface	SATA			
Internal transfer rate	875 MB/s			845 MB/s
I/O data transfer rate	3 GB/s			
DC Power Requirements				
Voltage	+5.0V ± 5%			

Item	Specifications		
Vendor & Model Name	WD		
Capacity (MB)	160	320	640
Bytes per sector	512		
Data heads	2	3	4
Drive Format			
Disks	1	2	2
Spindle speed (RPM)	5400		
Performance Specifications			
Buffer size	8 MB		
Interface	SATA		

---

Item	Specifications
Internal transfer rate (Mbits/sec, max)	
I/O data transfer rate	3 GB/s
DC Power Requirements	
Voltage	+5.0V $\pm$ 5%



### Super-Multi Drive Module

Item	Specification	
Vendor & model name	HLDS/GSA-T50, Toshiba Digi/TS-L633A	
Performance Specification	With CD Diskette	With DVD Diskette
Transfer rate (MB/sec)	Sustained: Max 3.5 Mbytes/sec	Sustained: Max 10 Mbytes/sec
Buffer Memory	2MB	
Interface	SATA	
Applicable disc format	<p>Applicable media types:</p> <p><b>Writing:</b> Confirms to DVD+R Version 1.2 and DVD+RW Version 1.3 / DVD+R DL Version 1.0 / DVD-R Version 2.0 / DVD-RW Version 1.2 / DVD-R DL Version 3.0.</p> <p><b>Reading:</b> DVD single/dual layer (PTP, OTP), DVD-R single/dual layer DVD+R single/double layer DVD-RW DVD+RW CD-DA CD-ROM CD-ROM/XA Photo-CD, Multi-session, Video CD CD-I FMV, CD Extra, CD Plus, CD-R, and CD-RW</p>	
Loading mechanism	Drawer (Solenoid Open) Tact SW (Open) Emergency Release (draw open hole)	
Power Requirement		
Input Voltage	DC 5 V +/- 5%	

Item	Specification	
Vendor & model name	SONY AD-7583S	
Performance Specification	With CD Diskette	With DVD Diskette
Transfer rate (MB/sec)	Sustained: 3650 (max.)	Sustained: 10,993 (max.)
Buffer Memory	2 MB	
Interface	SATA	
Applicable disc format	<p><b>Write:</b> DVD Data &amp; Video CD-DA, CD-ROM Mode-1, CD-ROM/XA Mode-2 Form-1 and Mode-2 Form-2, CD-i, Video-CD, CD-Text</p> <p><b>Read:</b> DVD-ROM (DVD-5, DVD-9, DVD-10, DVD-18), DVD-Video, DVD-Audio, SACD (Hybrid), UDF DVD, DVD-R, DVD-R DL, DVD-R 3.95 GB, DVD-R Authoring, DVD-R Multi-Border, DVD-RW, DVD+R, DVD+R DL, DVD+R Multi-Session, DVD+RW, DVD-RAM V1.0, DVDRAM V2.0 &amp; 2.1 &amp; 2.2 CD-DA, CD-ROM Mode-1, CD-ROM/XA Mode-2 Form-1 and Mode-2 Form-2, CD-i, CD-i Bridge, Video-CD (MPEG-1), Karaoke CD, Photo-CD, Enhanced CD, CD Plus, CD Extra, itrax CD, CD-Text, UDF CD, CD-R, and CD-RW</p>	

Item	Specification
Loading mechanism	Drawer (Solenoid Open) Tact SW (Open) Emergency Release (draw open hole)
Power Requirement	
Input Voltage	DC 5 V +/- 5%

#### Blue-Ray Combo Drive Module

Item	Specification
Vendor & model name	Sony BC-5500S
Performance Specification	With CD Diskette      With DVD Diskette
Transfer rate (MB/sec)	Sustained: Max 2.4 Mbytes/sec      Sustained: Max 11 Mbytes/sec
Buffer Memory	4.5 MB
Interface	SATA
Applicable disc format	Applicable media types: BD-ROM (Single and Dual Layer) BD-R (Single and Dual Layer) BD-RE (Single and Dual Layer) DVD-ROM (Single and Dual Layer) DVD+R (Single and Double Layer) DVD-R (Single and Dual Layer) DVD+RW (Single Layer) and DVD-RW (Single Layer) discs DVD-RAM (Ver.2) CD-ROM CD-R CD-RW
Loading mechanism	Drawer (Solenoid Open), Tact SW (Open), Emergency Release (draw open hole)
Power Requirement	
Input Voltage	DC 5 V +/- 5%

Item	Specification
Vendor & model name	PLDS BD Combo DS-4E1S
Performance Specification	With CD Diskette      With DVD Diskette      Bluera y
Transfer rate (KB/sec)	Sustained: 3,500 (min.)      Sustained: 10,000 (min.)      Sustained: 18,000 (min.)
Buffer Memory	2 MB
Interface	SATA
Applicable disc format	CD-DA, CD-TEXT, CD ROM Mode-1, CD-ROM/XA Mode-2 Form-1 and Form-2, CD-I Ready, Video-CD (MPEG-1), Photo-CD, Enhance CD, CD extra, I-Trax CD and UDF DVD-ROM, DVD-Video, DVD-Audio, DVD-R single/multi border(s) DVD+R single/multi session(s) DVD-RW DVD+RW DVD-RAM BD-ROM ver2.0, UDF2.5 BD-R ver1.0 and ver2.0, UDF2.5 BD-RE ver2.0 and ver3.0, UDF2.5 BD-hybrid (only BD part)
Loading mechanism	Drawer (Solenoid Open), Tact SW (Open), Emergency Release (draw open hole)
Power Requirement	
Input Voltage	DC 5 V +/- 5%

## Audio Interface

Item	Specification
Audio Controller	Realtek ALC272 Azalia Codec and Amplifier G1454
<ul style="list-style-type: none"> <li>Features</li> </ul>	<ul style="list-style-type: none"> <li>HD Audio</li> <li>SNR &gt; 85, High-performance DACs with 95dB SNR (A-Weighting), ADCs with 85dB SNR (A-Weighting)</li> <li>Internal Digital Microphone</li> <li>Two speakers, max. 1W output for each</li> <li>Meets performance and function requirements for Microsoft WLP 3.10, and stricter performance requirements for future WLP</li> <li>Two stereo DAC support 16/20/24-bit PCM for two independent playback (multiple streaming)</li> <li>Two stereo ADC supports 16/20/24-bit PCM format for two independent recording</li> <li>All DACs support independent 44.1k/48k/96k/192kHz sample rate</li> <li>All ADCs support independent 44.1k/48k/96k/192kHz sample rate</li> <li>Two independent SPDIF outputs support 16/20/24-bit format and 44.1k/48k/88.2k/96k/192kHz rate</li> <li>All analog jack ports except MONO, BEEP-IN and HP-OUT are stereo input and output re-tasking</li> <li>Supports line level mono output</li> <li>Supports analog PCBEEP input, and features an integrated digital BEEP generator</li> <li>Support two stereo digital microphone input for microphone array AEC/BF application</li> <li>Each stereo digital microphone interface has its own clock output to support independent sample rate</li> <li>Supports legacy analog mixer architecture</li> <li>Built-in five headphone amplifiers on port-A and port-D, port-E, port-F and port-I.</li> <li>Headphone amplifier on port-I (HP-OUT) is designed to drive output without external DC blocking capacitors</li> <li>Software selectable 2.5V and 3.2V reference output for microphone bias</li> <li>Software selectable boost gain (+10/+20/+30dB) for analog microphone input</li> <li>Two jack detection pins; each supports detection of up to 4 jacks</li> <li>Supports two GPIO (General Purpose Input/Output) pins (pin sharing with digital microphone interface)</li> <li>Supports EAPD (External Amplifier Power Down) control for external amplifier</li> <li>Supports anti-pop mode when analog power AVDD is on and digital power is off</li> <li>Supports 1.5V~3.3V scalable I/O for HD Audio link</li> <li>48-pin LQFP 'Green' package</li> </ul>

## Power and Keyboard Controller

Item	Specification
Controller	KB926
Total number of keypads	99-/100-/103
Windows logo key	Yes
Internal & external keyboard work simultaneously	Yes
Features	Support Application keys for Windows XP version

**Battery**

Item	Specification	
	6 Cell	8 Cell
Vendor & model name	PANASONIC AS-2007B SAMSUNG AS-2007B SANYO AS-2007B	SANYO AS-2007B SIMPLO AS-2007B SONY AS-2007B
Battery Type	Li-ion	Li-ion
Pack capacity	4400 mAh	4800 mAh
Normal Voltage	11.1V	14.8
Charge Voltage	12.6V	12.6V
Fast Charge Current	2.94~3.5A	3.1A
Package configuration	3S2P	4S2P

**LCD 15.6"**

Item	Specification
Vendor/model name	CMO/AUO/Samsung/LPL
Display resolution (pixels)	1600x900
Typical White Luminance (cd/m <sup>2</sup> ) (also called Brightness)	220
Aspect Ratio	16:9
Electrical Interface	LVDS

# System Utilities

---

## BIOS Setup Utility

The BIOS Setup Utility is a hardware configuration program built into your computer's BIOS (Basic Input/Output System).

Your computer is already properly configured and optimized, and you do not need to run this utility. However, if you encounter configuration problems, you may need to run Setup. Please also refer to Chapter 4 Troubleshooting when problem arises.

To activate the BIOS Utility, press **F2** during POST (when "Press <F2> to enter Setup" message is prompted on the bottom of screen).

Press **F2** to enter setup. The default parameter of F12 Boot Menu is set to "disabled". If you want to change boot device without entering BIOS Setup Utility, please set the parameter to "enabled".

Press <F12> during POST to enter multi-boot menu. In this menu, user can change boot device without entering BIOS SETUP Utility.

## Navigating the BIOS Utility

There are six menu options: Information, Main, Advanced, Security, Boot, and Exit.

Follow these instructions:

- To choose a menu, use the left and right arrow keys.
- To choose an item, use the up and down arrow keys.
- To change the value of a parameter, press **F5** or **F6**.
- A plus sign (+) indicates the item has sub-items. Press **Enter** to expand this item.
- Press **Esc** while you are in any of the menu options to go to the Exit menu.
- In any menu, you can load default settings by pressing **F9**. You can also press **F10** to save any changes made and exit the BIOS Setup Utility.

**NOTE:** You can change the value of a parameter if it is enclosed in square brackets. Navigation keys for a particular menu are shown on the bottom of the screen. Help for parameters are found in the Item Specific Help part of the screen. Read this carefully when making changes to parameter values. **Please note that system information is subject to different models.**

# Information

The Information screen displays a summary of your computer hardware information.

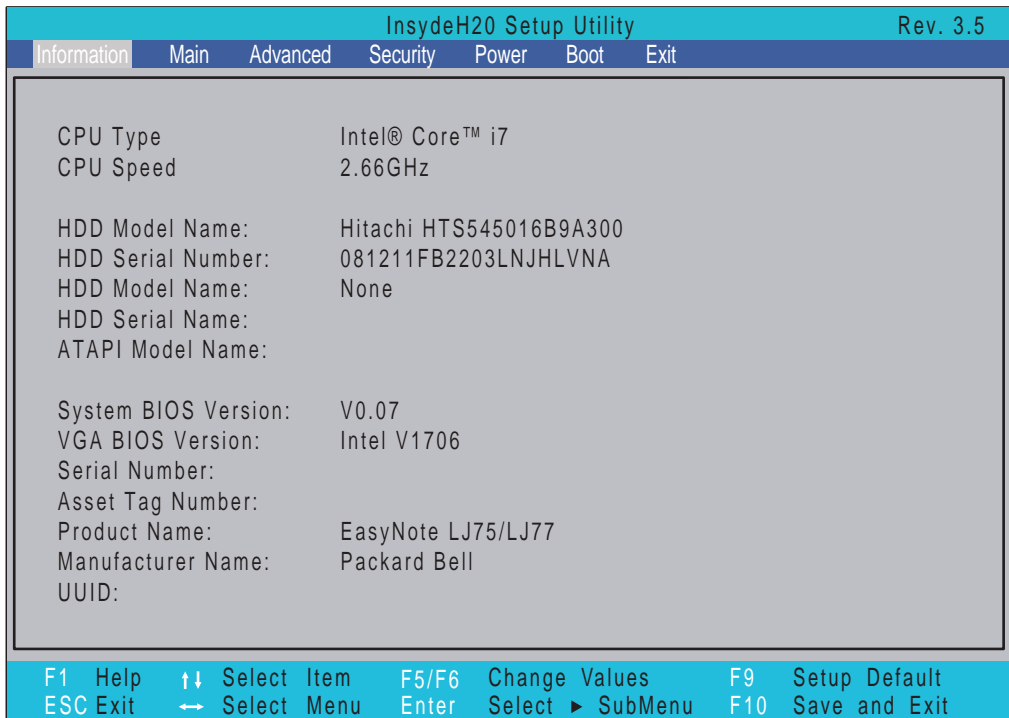

**NOTE:** The screen above is for your reference only. Actual values may differ according to model.

The table below describes the parameters in this screen.

Parameter	Description
CPU Type	This field shows the CPU type and speed of the system.
CPU Speed	This field shows the speed of the CPU.
HDD Model Name	This field shows the model name of HDD installed on primary IDE master.
HDD Serial Number	This field displays the serial number of HDD installed on primary IDE master.
ATAPI Model Name	This field shows the model name of the Optical device installed in the system.
System BIOS Version	Displays system BIOS version.
VGA BIOS Version	This field displays the VGA firmware version of the system.
Serial Number	This field displays the serial number of this unit.
Asset Tag Number	This field displays the asset tag number of the system.
Product Name	This field shows product name of the system.
Manufacturer Name	This field displays the manufacturer of this system.
UUID	Universally Unique Identifier (UUID) is an identifier standard used in software construction, standardized by the Open Software Foundation (OSF) as part of the Distributed Computing Environment (DCE).

# Main

The Main screen allows the user to set the system time and date as well as enable and disable boot option and recovery.

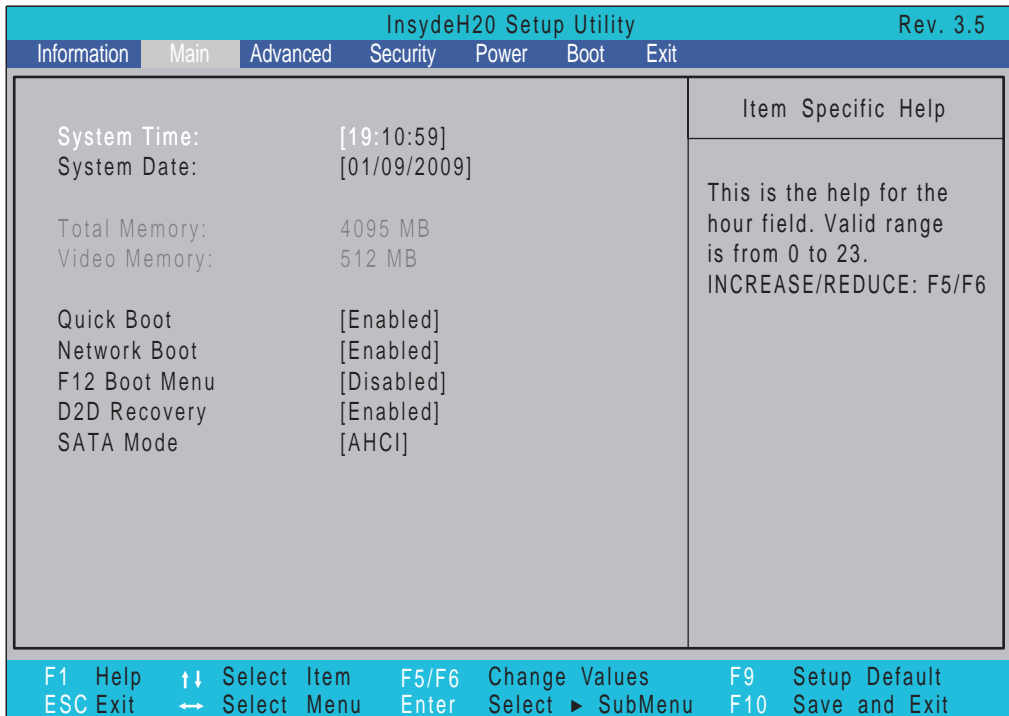

**NOTE:** The screen above is for your reference only. Actual values may differ.

The table below describes the parameters in this screen. Settings in boldface are the default and suggested parameter settings.

Parameter	Description	Format/Option
System Time	Sets the system time. The hours are displayed with 24-hour format.	Format: HH:MM:SS (hour:minute:second)
System Date	Sets the system date.	Format MM/DD/YYYY (month/day/year)
Total Memory	Displays the total memory available.	N/A
Video Memory	Displays the available memory for Video.	N/A
Quick Boot	Allows startup to skip certain tests while booting, decreasing the time needed to boot the system.	Option: <b>Enabled</b> or Disabled
Network Boot	Enables, disables the system boot from LAN (remote server).	Option: <b>Enabled</b> or Disabled
F12 Boot Menu	Enables, disables Boot Menu during POST.	Option: <b>Enabled</b> or Enabled
D2D Recovery	Enables, disables D2D Recovery function. The function allows the user to create a hidden partition on hard disc drive to store operation system and restore the system to factory defaults.	Option: <b>Enabled</b> or Disabled
SATA Mode	Control the mode in which the SATA controller should operate.	Option: <b>AHCI</b> or IDE

# Advanced

The Advanced screen allows the user to configure the various advanced BIOS options.

**IMPORTANT:** Making incorrect settings to items on these pages may cause the system to malfunction. Unless you have experience adjusting these items, we recommend that you leave these settings at the default values. If making settings to items on these pages causes your system to malfunction or prevents the system from booting, open BIOS and choose Load Optimal Defaults in the Exit menu to boot up normally.

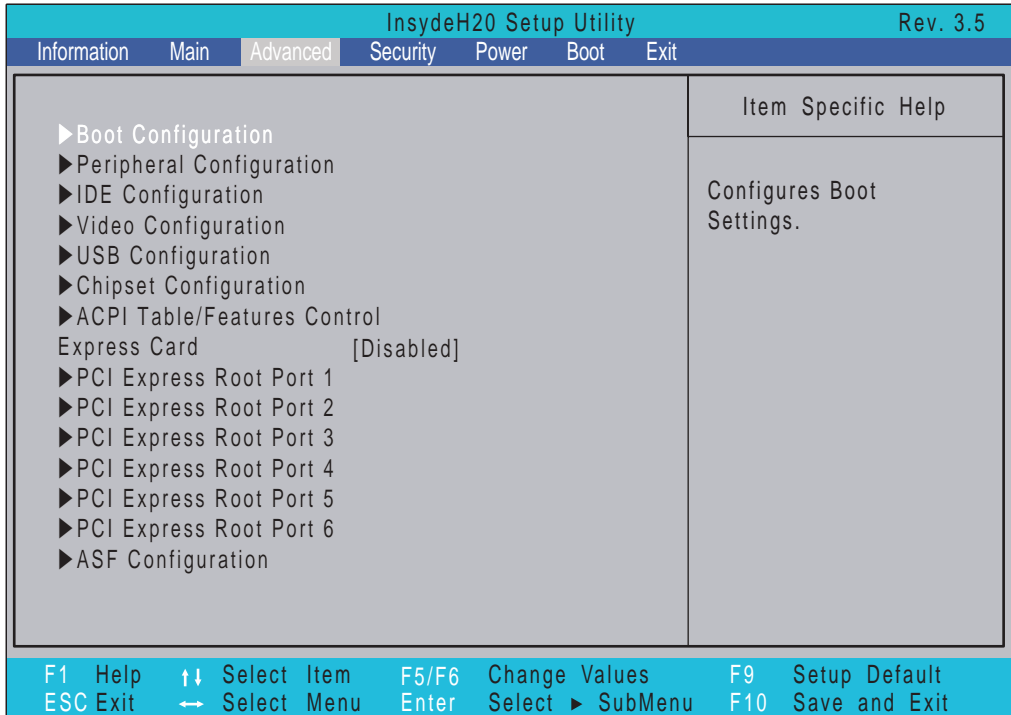

The table below describes the items, menus, and submenus in this screen. Settings in **boldface** are the default and suggested parameter settings.

Parameter	Description	Submenu Items
Boot Configuration	Enter the Boot Configuration menu.	<ul style="list-style-type: none"> <li>Numlock</li> </ul>
Peripheral Configuration	Enter the Peripheral Configuration menu.	<ul style="list-style-type: none"> <li>Serial Port A</li> <li>Infrared Port</li> <li>Azalia</li> <li>Lan</li> </ul>
IDE Configuration	Enter the IDE Configuration menu.	<ul style="list-style-type: none"> <li>IDE Controller</li> <li>HDC Configure as</li> <li>AHCI Option ROM Support</li> <li>SATA Port 0, 1, 4, 5 HotPlug</li> <li>Channel 1 to 4 Master and Slave</li> </ul>



Parameter	Description	Submenu Items
Video Configuration	Enter the Video Configuration menu.	<ul style="list-style-type: none"> <li>• Render Standby</li> <li>• IGD—Device2, Function1</li> <li>• IGD—Pre-allocat Memory</li> <li>• IGD—DVMT Size</li> <li>• Clock Chip Initialize</li> <li>• Enabled CK SSC</li> <li>• IGD—Boot Type</li> <li>• IGD—LCD Panel Type</li> <li>• IGD—TV</li> <li>• IGD—PAVP Mode</li> </ul>
USB Configuration	Enter the USB Configuration menu.	<ul style="list-style-type: none"> <li>• USB Legacy</li> <li>• EHCI 1, 2</li> <li>• UHCI 1 ~ 5</li> <li>• Per-Port Control</li> <li>• USB Port 0~11</li> </ul>
Chipset Configuration	Enter the Chipset Configuration menu.	<ul style="list-style-type: none"> <li>• Port 80h Cycles</li> <li>• DMI Link ASPM Control</li> <li>• Automatic ASPM</li> <li>• PCI Latency Timer</li> <li>• VT-d</li> <li>• iTPM</li> </ul>
ACPI Table/ Features Control	Enter the ACPI Table/Features Control menu.	<ul style="list-style-type: none"> <li>• FACP—C2 Latency Value</li> <li>• FACP—C3 Latency Value</li> <li>• FACP—RTC S4 Wakeup</li> <li>• APIC—IO APIC Mode</li> <li>• HPET—HPET Support <ul style="list-style-type: none"> <li>• Base Address select</li> </ul> </li> </ul>
Express Card	Disabled	<ul style="list-style-type: none"> <li>• N/A</li> </ul>
PCI Express Root Port 1 ~ 6	Enter the PCI Express Root Port Menu	<ul style="list-style-type: none"> <li>• PCI Express Root Port 1 <ul style="list-style-type: none"> <li>• VC1 Enable</li> <li>• ASPM</li> </ul> </li> <li>• Automatic ASPM</li> <li>• ASPML0s</li> <li>• ASPM L1 <ul style="list-style-type: none"> <li>• URR</li> <li>• FER</li> <li>• NFER</li> <li>• CER</li> <li>• CTO</li> <li>• SEFE</li> <li>• SENFE</li> <li>• SECE</li> <li>• PME Interrupt</li> <li>• PMI SCI</li> <li>• Hot Plug SCI</li> </ul> </li> </ul>
ASF Configuration	Enter the ASF Configuration Menu	<ul style="list-style-type: none"> <li>• Mini WatchDog Timeout</li> <li>• BIOS Boot Timeout</li> <li>• OS Boot Timeout</li> <li>• Power-on wait time</li> </ul>

# Security

The Security screen contains parameters that help safeguard and protect your computer from unauthorized use.

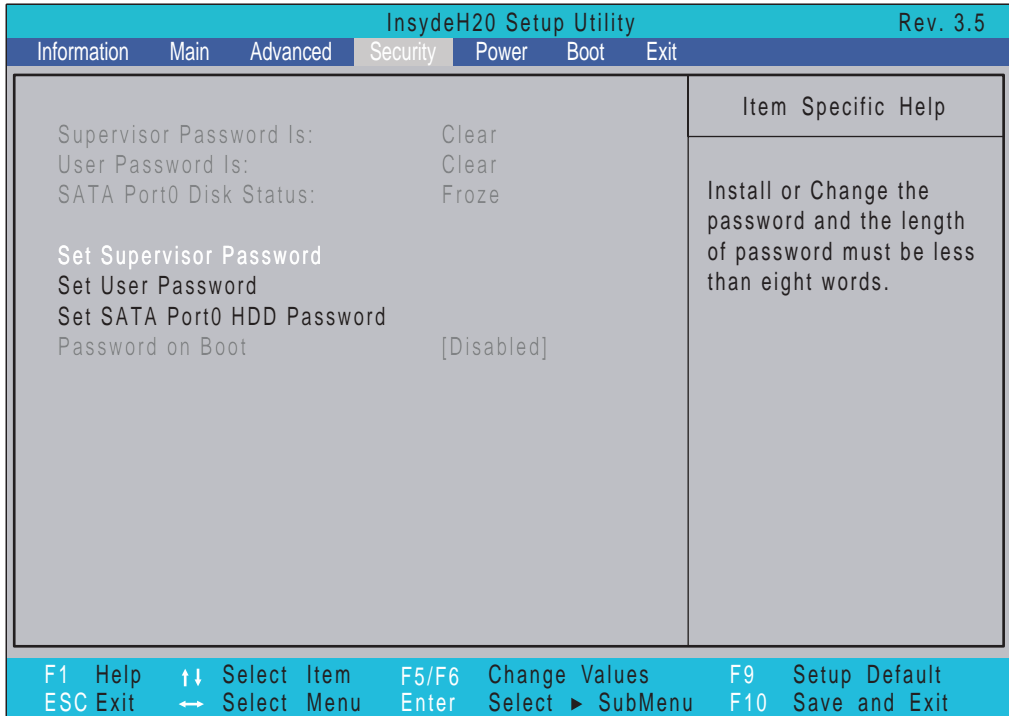

The table below describes the parameters in this screen. Settings in **boldface** are the default and suggested parameter settings.

Parameter	Description	Option
Supervisor Password Is	Shows the setting of the Supervisor password	<b>Clear</b> or Set
User Password Is	Shows the setting of the user password.	<b>Clear</b> or Set
SATA Port0 Disk Status	Shows the status of the SATA Port0 disk.	<b>Froze</b> or ?
Set Supervisor Password	Press Enter to set the supervisor password. When set, this password protects the BIOS Setup Utility from unauthorized access. The user can not either enter the Setup menu nor change the value of parameters.	N/A
Set User Password	Press Enter to set the user password. When user password is set, this password protects the BIOS Setup Utility from unauthorized access. The user can enter Setup menu only and does not have right to change the value of parameters.	N/A
Set SATA Port0 HDD Password	Enter HDD Password.	N/A
Password on Boot	Defines whether a password is required or not while the events defined in this group happened. The following sub-options are all requires the Supervisor password for changes and should be grayed out if the user password was used to enter setup.	<b>Disabled</b> or Enabled

**NOTE:** When you are prompted to enter a password, you have three tries before the system halts. Don't forget your password. If you forget your password, you may have to return your notebook computer to your dealer to reset it.

---

## Setting a Password

Follow these steps as you set the user or the supervisor password:

1. Use the ↑ and ↓ keys to highlight the Set Supervisor Password parameter and press the **Enter** key. The Set Supervisor Password box appears:

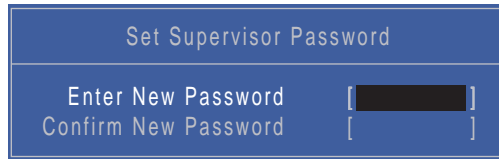

Set Supervisor Password	
Enter New Password	[REDACTED]
Confirm New Password	[REDACTED]

2. Type a password in the “Enter New Password” field. The password length can not exceed 8 alphanumeric characters (A-Z, a-z, 0-9, not case sensitive). Retype the password in the “Confirm New Password” field.

**IMPORTANT:** Be very careful when typing your password because the characters do not appear on the screen.

3. Press **Enter**. After setting the password, the computer sets the User Password parameter to “Set”.
4. If desired, you can opt to enable the Password on boot parameter.
5. When you are done, press F10 to save the changes and exit the BIOS Setup Utility.

## Removing a Password

Follow these steps:

1. Use the ↑ and ↓ keys to highlight the Set Supervisor Password parameter and press the **Enter** key. The Set Password box appears:



Set Supervisor Password	
Enter Current Password	[REDACTED]
Enter New Password	[REDACTED]
Confirm New Password	[REDACTED]

2. Type the current password in the Enter Current Password field and press **Enter**.
3. Press **Enter** twice **without** typing anything in the Enter New Password and Confirm New Password fields. The computer then sets the Supervisor Password parameter to “Clear”.
4. When you have changed the settings, press u to save the changes and exit the BIOS Setup Utility.

---

## Changing a Password

1. Use the ↑ and ↓ keys to highlight the Set Supervisor Password parameter and press the **Enter** key. The Set Password box appears.



The screenshot shows a blue-themed BIOS screen titled "Set Supervisor Password". It contains three input fields: "Enter Current Password", "Enter New Password", and "Confirm New Password". Each field is followed by a pair of square brackets [ ] representing the input area.

2. Type the current password in the Enter Current Password field and press **Enter**.
3. Type a password in the Enter New Password field. Retype the password in the Confirm New Password field.
4. Press **Enter**. After setting the password, the computer sets the User Password parameter to "Set".
5. If desired, you can enable the Password on boot parameter.
6. When you are done, press F10 to save the changes and exit the BIOS Setup Utility.

If the verification is OK, the screen will display as following.

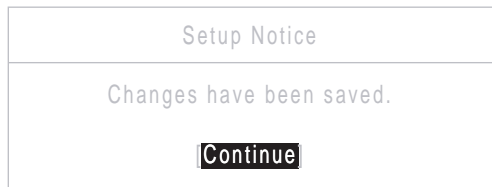

The screenshot shows a white BIOS screen titled "Setup Notice". The text "Changes have been saved." is displayed in the center. Below the text is a black button with the word "Continue" in white.

The password setting is complete after the user presses **Enter**.

If the current password entered does not match the actual current password, the screen will show you the Setup Warning.



The screenshot shows a white BIOS screen titled "Setup Warning" in red text. Below the title, the text "Invalid Password." is displayed in red. At the bottom, there is a black button with the word "Continue" in white.

If the new password and confirm new password strings do not match, the screen will display the following message.



The screenshot shows a white BIOS screen titled "Setup Warning" in red text. Below the title, the text "Passwords do not match. Re-enter password." is displayed in red. At the bottom, there is a black button with the word "Continue" in white.

# Power

The Advanced screen allows the user to configure the various advanced BIOS options.

**IMPORTANT:** Making incorrect settings to items on these pages may cause the system to malfunction. Unless you have experience adjusting these items, we recommend that you leave these settings at the default values. If making settings to items on these pages causes your system to malfunction or prevents the system from booting, open BIOS and choose Load Optimal Defaults in the Exit menu to boot up normally.

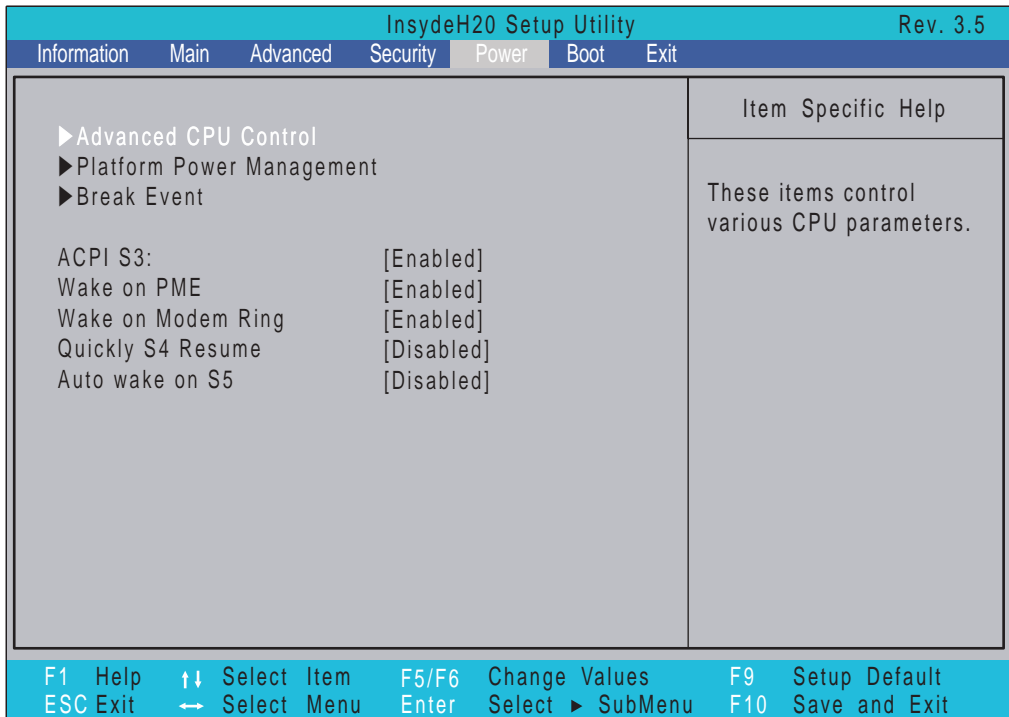

The table below describes the items, menus, and submenus in this screen. Settings in **boldface** are the default and suggested parameter settings.

Parameter	Description	Submenu Items
Advanced CPU Control	Enter the Advanced CPU Control menu.	<ul style="list-style-type: none"> <li>• P-States (IST)</li> <li>• Boot performance mode</li> <li>• Thermal Mode</li> <li>• CMP Support</li> <li>• Use XD capability</li> <li>• VT Support</li> <li>• SMRR Support</li> <li>• C-States</li> <li>• Enhanced C-States</li> <li>• C-State Pop Up Mode</li> <li>• C-State Pop Down Mode</li> <li>• C4 Exit Timing Mode</li> <li>• Deep C4</li> <li>• Hard C4E</li> <li>• Enable C6</li> <li>• EMITM</li> <li>• Bi-directional PROCHOT#</li> <li>• Dynamic FSB Switching</li> <li>• Turbmo Mode</li> <li>• ACPI 3.0 T-States</li> <li>• DTS</li> <li>• DTS Calibration</li> <li>• Thermal Trip Points Setting</li> </ul>
Platform Power Management	Enter the Platform Power Management menu.	<ul style="list-style-type: none"> <li>• PCI Clock Run</li> </ul>
Break Event	Enter the Break Event menu	<ul style="list-style-type: none"> <li>• Storage Break Event</li> <li>• PCIE Break Event</li> <li>• PCI Break Event</li> <li>• EHCI Break Event</li> <li>• UHCI Break Event</li> <li>• HDA Break Event</li> </ul>
ACPI S3	<b>Enable</b> or Disable ACPI S1/S3 Sleep State.	N/A
Wake on PME	<b>Disable</b> or Enable wake up when the system power is off and a PCI Power Management Enable wake up event occurs.	N/A
Wake on Modem Ring	<b>Disable</b> or Enable wake up when the system power is off and a modem attached to the serial port is ringing.	N/A
Quickly S4 Resume	<b>Disable</b> or Enable optional quick boot from S4 Resume.	N/A
Auto wake on S5	<b>Disable</b> or Enable auto wake up by date and time or at a fixed time everyday.	N/A

# Boot

This menu allows the user to decide the order of boot devices to load the operating system. Bootable devices includes the USB diskette drives, the onboard hard disk drive and the DVD drive in the module bay.

Select Boot Devices to select specific devices to support boot.

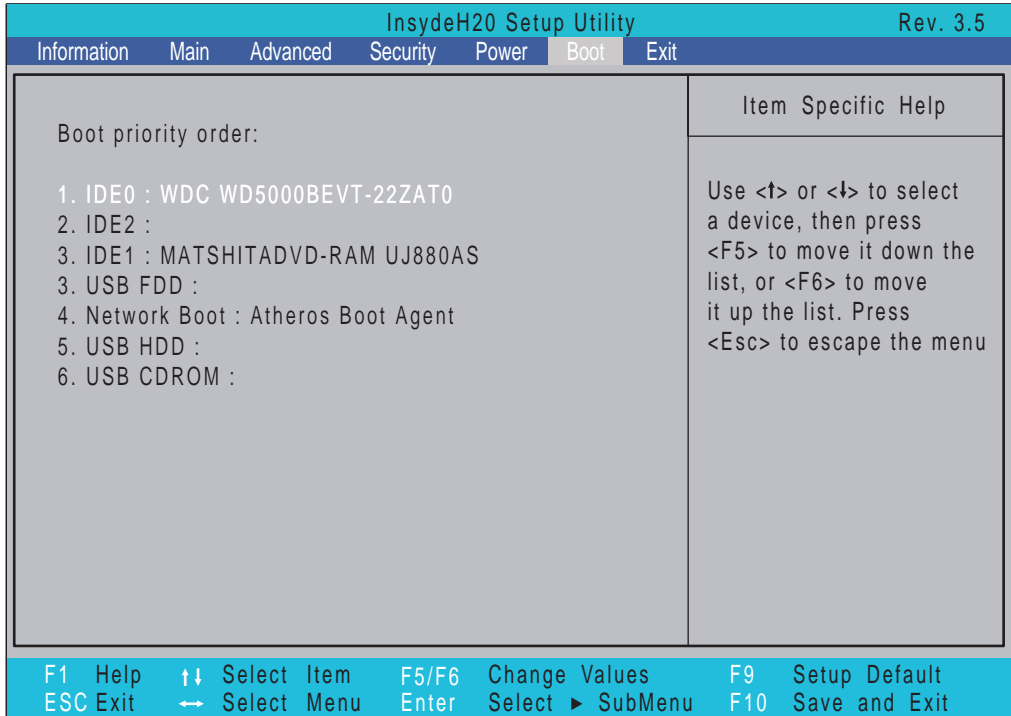

# Exit

The Exit screen allows you to save or discard any changes you made and quit the BIOS Utility.

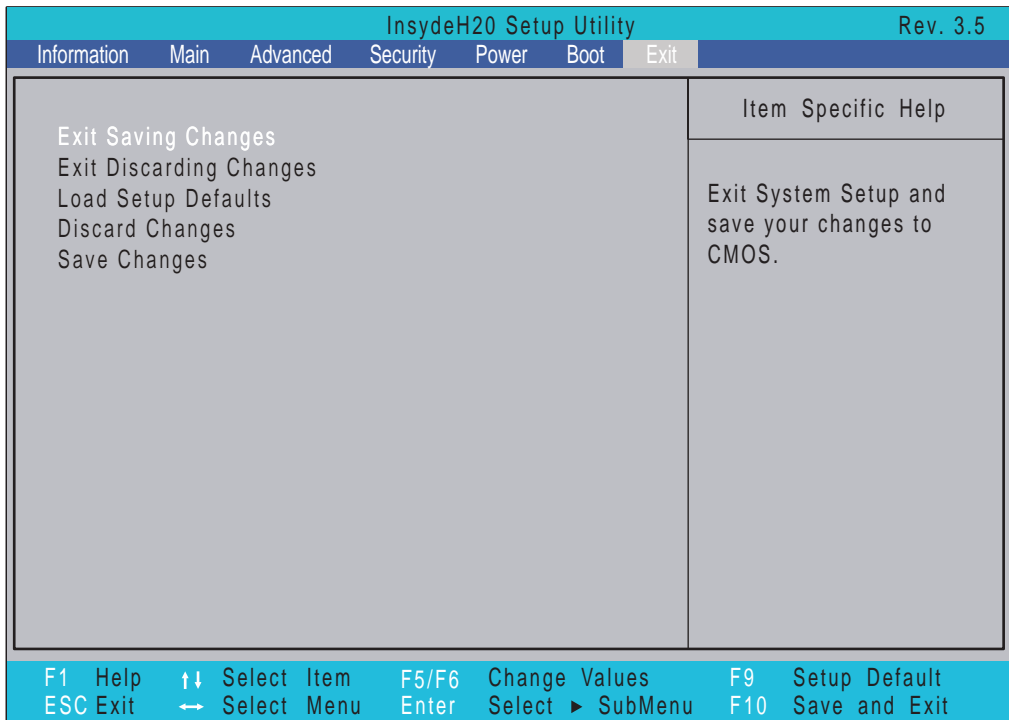

The table below describes the parameters in this screen.

Parameter	Description
Exit Saving Changes	Exit System Setup and save your changes to CMOS.
Exit Discarding Changes	Exit utility without saving setup data to CMOS.
Load Setup Default	Load default values for all SETUP item.
Discard Changes	Load previous values from CMOS for all SETUP items.
Save Changes	Save Setup Data to CMOS.



---

# BIOS Flash Utilities

The BIOS flash memory update is required for the following conditions:

- New versions of system programs
- New features or options
- Restore a BIOS when it becomes corrupted.

Use the Phlash utility to update the system BIOS flash ROM.

**NOTE:** If you do not have a crisis recovery diskette at hand, then you should create a **Crisis Recovery Diskette** before you use the Phlash utility.

**NOTE:** Do not install memory-related drivers (XMS, EMS, DPMI) when you use the Phlash.

**NOTE:** Please use the AC adaptor power supply when you run the Phlash utility. If the battery pack does not contain enough power to finish BIOS flash, you may not boot the system because the BIOS is not completely loaded.

Follow the steps below to run the Phlash.

1. Prepare a bootable diskette.
2. Copy the flash utilities to the bootable diskette.
3. Then boot the system from the bootable diskette. The flash utility has auto-execution function.

# DOS Flash Utility

Perform the following steps to use the DOS Flash Utility:

1. Press F2 during boot to enter the Setup Menu.
2. Select **Boot Menu** to modify the boot priority order, for example, if using USB HDD to Update BIOS, move USB HDD to position 1.

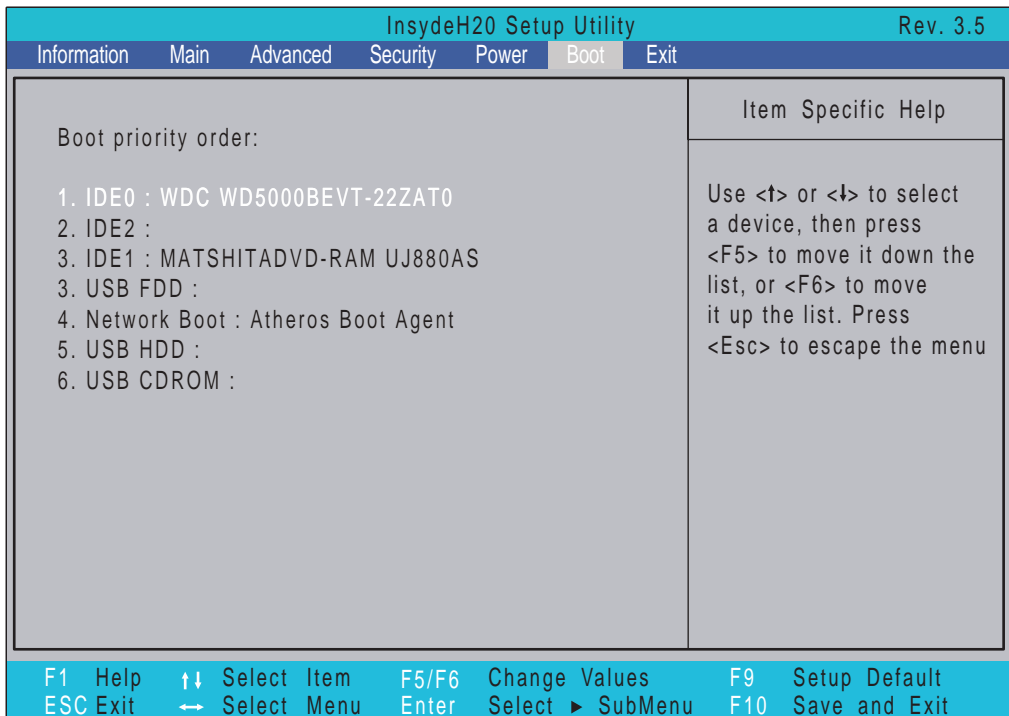

3. Execute the **FLASH.BAT** batch file to update BIOS.

The flash process begins as shown.

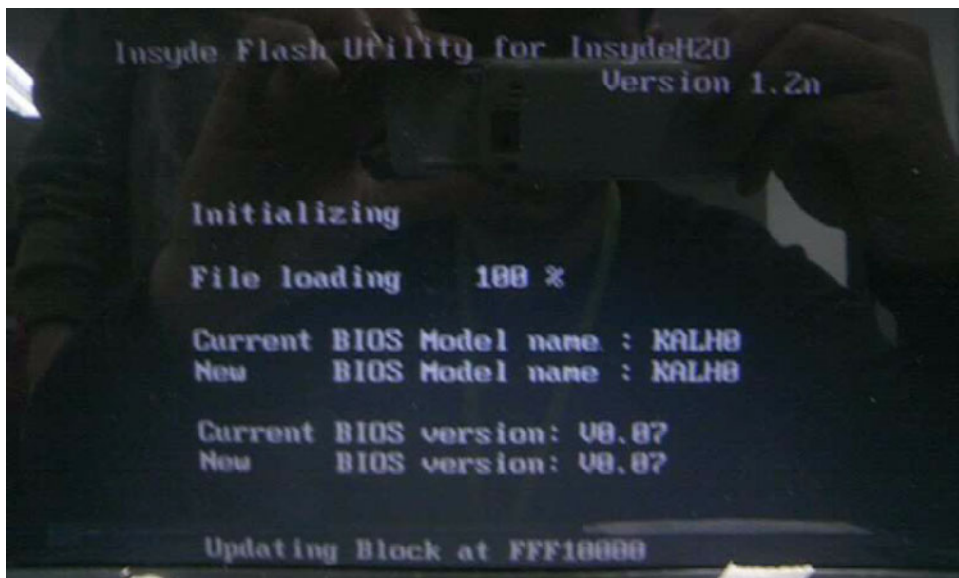

---

4. In flash BIOS, the message **Please do not remove AC Power Source** displays.

**NOTE:** If the AC power is not connected, the following message displays.



Plug in the AC power to continue.

5. Flash is complete when the message Flash programming complete displays.

# WinFlash Utility

Perform the following steps to use the WinFlash Utility:

1. Double-click the WinFlash executable.
2. Click **OK** to begin the update. A progress screen displays.

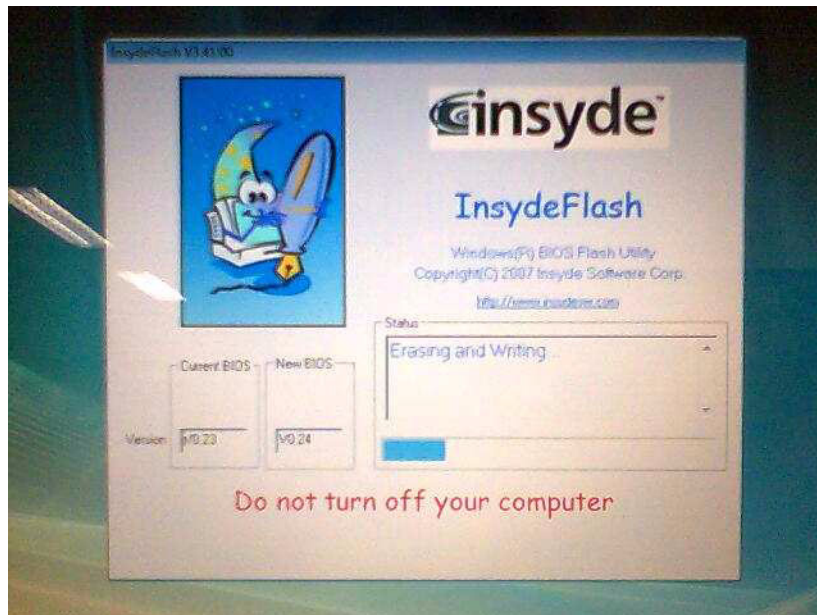

---

# Remove HDD/BIOS Password Utilities

This section provides you with details about removing HDD/BIOS password:

## Remove HDD Password:

If you key in the wrong HDD password three times, an error is generated.



To reset the HDD password, perform the following steps:

1. After the error is displayed, select the **Enter Unlock Password** option on the screen.



2. An Encode key is generated for unlocking utilities. Note down this key.



3. Execute the **UnlockHD.EXE** file to create the unlock code in DOS Mode using the format **UnlockHD [Encode code]** with the code noted in the previous step, as follows:

**UnlockHD 76943488**

4. The command generates a password which can be used for unlocking the HDD.

**Password: 46548274**

5. Key in the password from the previous step to unlock the HDD as shown.

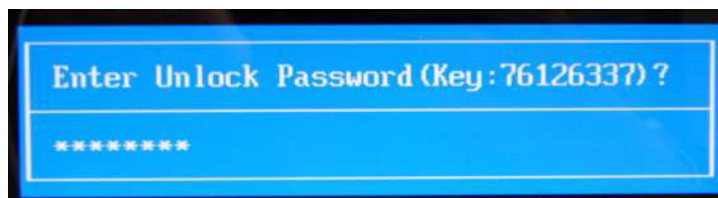

### Removing BIOS Passwords:

To clear the User or Supervisor passwords, open the RAM door and use a metal instrument to short the **RTC\_RST** and **ME\_RST** jumper.

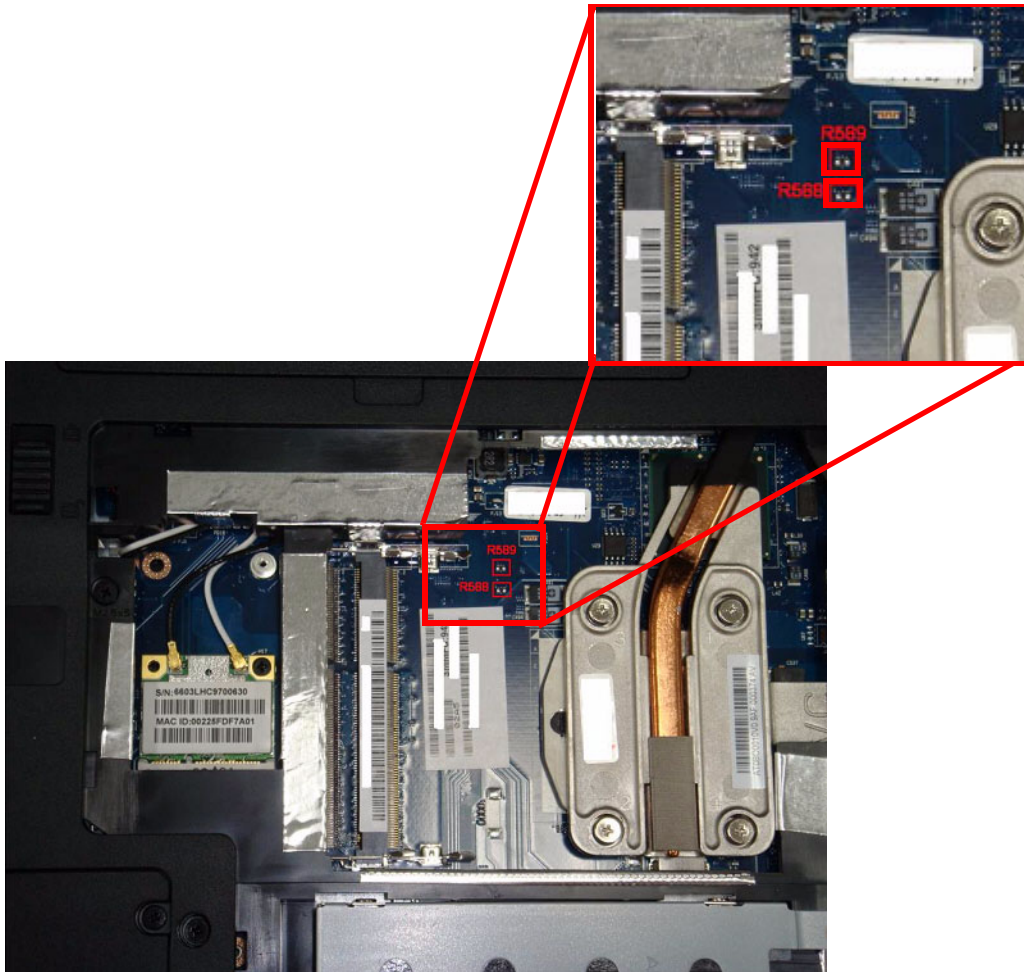

### Cleaning BIOS Passwords

To clean the User or Supervisor passwords, perform the following steps:

1. From a DOS prompt, execute **clnpwd.exe**
2. Press **1** or **2** to clean the desired password shown on the screen.

```
d:\Clnpwd>clnpwd
ACER Clean Password Utility V1.00
Press 1 or 2 to clean any password shown as below
1.User Password
2.Supervisor Password

Clean User Password Successfully!
```

The onscreen message determines whether the function is successful or not.

---

## Using Boot Sequence Selector

The Boot Sequence Selector allows the boot order to be changed without accessing the BIOS. To use Boot Sequence Selector, perform the following steps:

1. Enter into DOS.
2. Execute **BS.exe** to display the usage screen.

```
d:\BOOTSEQ>bs
*** Boot Sequence Selector Version 0.03 ***
Create by Rockwell Chuang 10/01/2005.
Usage:
      BS [ 1 | 2 | 3 | 4 ]
BS 1 : [ Floppy ] => [ HardDisk ] => [ CD-ROM ] => [ LAN ]
BS 2 : [ HardDisk ] => [ CD-ROM ] => [ LAN ] => [ Floppy ]
BS 3 : [ CD-ROM ] => [ HardDisk ] => [ LAN ] => [ Floppy ]
BS 4 : [ LAN ] => [ Floppy ] => [ HardDisk ] => [ CD-ROM ]
d:\BOOTSEQ>
```

3. Select the desired boot sequence by entering the corresponding sequence. For example, enter **BS2** to change the boot sequence to HDD | CD ROM | LAN | Floppy.

---

## Using DMITools

The DMI (Desktop Management Interface) Tool copies BIOS information to EEPROM to be used in the DMI pool for hardware management.

When the BIOS displays **Verifying DMI pool data** it is checking that the table correlates with the hardware before sending to the operating system (Windows, etc.).

To update the DMI Pool, perform the following steps:

1. Boot into DOS.
2. Execute **dmitools**. The following messages report to screen to confirm completion:
  - `dmitools /r ==>` Read dmi string from bios
  - `dmitools /wm xxxx ==>` Write manufacturer name to eeprom (max. 16 characters)
  - `dmitools /wp xxxx ==>` Write product name to eeprom (max. 16 characters)
  - `dmitools /ws xxxx ==>` Write serial number to eeprom (max. 22 characters)
  - `dmitools /wu xxxx ==>` Write uuid to eeprom
  - `dmitools /wa xxxx ==>` Write asset tag to eeprom (max. 32 characters)

The following examples show the commands and the corresponding output information.

### Read DMI Information from Memory

#### Input:

```
dmitools /r
```

#### Output:

```
Manufacturer (Type1, Offset04h): Acer
Product Name (Type1, Offset05h): TravelMate xxxxx
Serial Number (Type1, Offset07h): 01234567890123456789
UUID String (Type1, Offset08h): xxxxxxxx-xxxx-xxxx-xxxx-xxxxxxxxxxxx
Asset Tag (Type3, Offset04h): Acet Asstag
```

### Write Product Name to EEPROM

#### Input:

```
dmitools /wp Acer
```

### Write Serial Number to EEPROM

#### Input:

```
dmitools /ws 01234567890123456789
```

### 4). Write UUID to EEPROM (Create UUID from Intel WFM20.pdf)

#### Input:

```
dmitools /wu
```

### 5). Write Asset Tag to EEPROM

#### Input:

```
dmitools /wa Acet Asstag
```

**NOTE:** When using any of the Write options, restart the system to make the new DMI data effective.



## Using the LAN Utility

Run the LAN utility in DOS mode by performing the following steps:

1. Run the **MAC.BAT** file.
2. Run the **NAYF0.BAT** file.
3. The function is successful when "passed" displays onscreen.

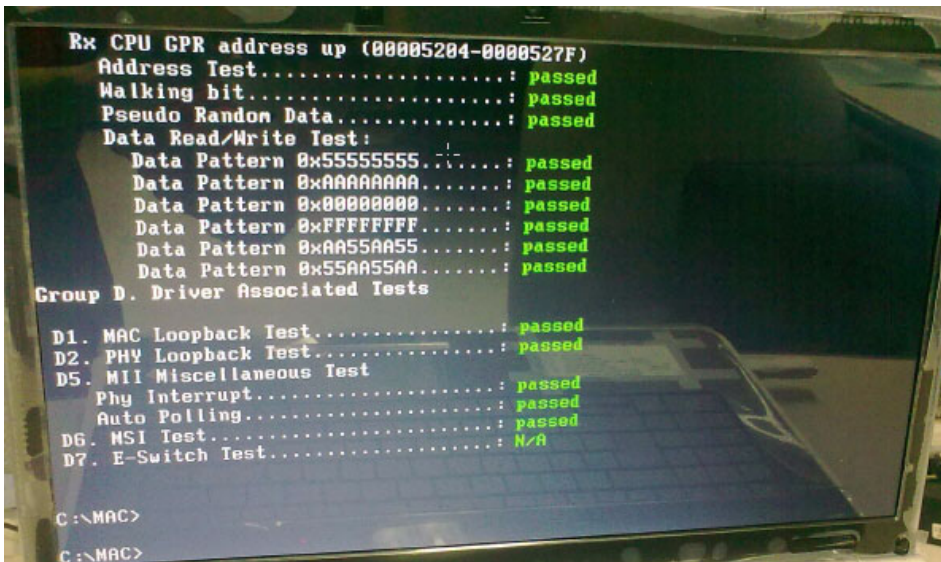
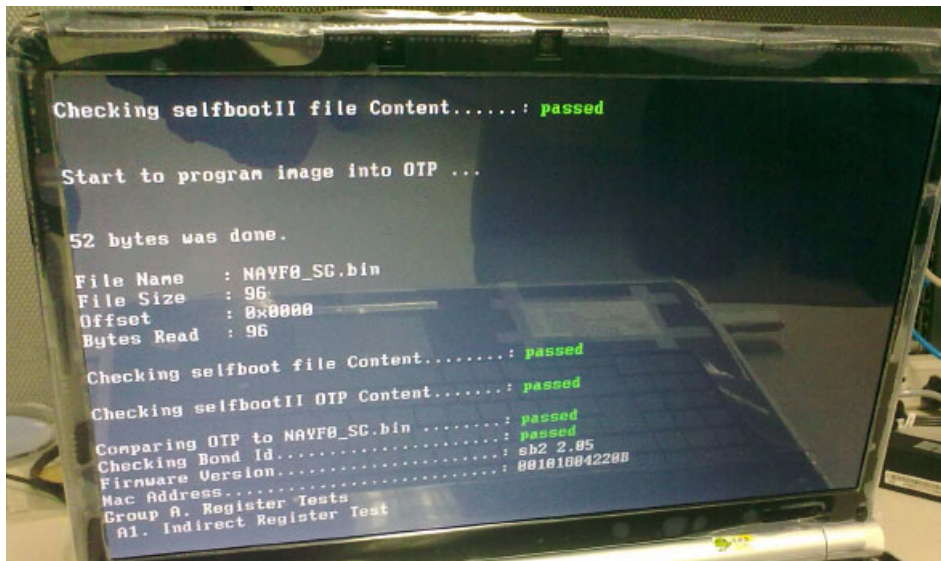



# Machine Disassembly and Replacement

---

**IMPORTANT:** The outside housing and color may vary from the mass produced model.

This chapter contains step-by-step procedures on how to disassemble the notebook computer for maintenance and troubleshooting.

## Disassembly Requirements

To disassemble the computer, you need the following tools:

- Wrist grounding strap and conductive mat for preventing electrostatic discharge
- Flat screwdriver
- Philips screwdriver
- Plastic flat screwdriver
- Plastic tweezers

**NOTE:** The screws for the different components vary in size. During the disassembly process, group the screws with the corresponding components to avoid mismatch when putting back the components.

---

# General Information

## Pre-disassembly Instructions

Before proceeding with the disassembly procedure, make sure that you do the following:

1. Turn off the power to the system and all peripherals.
2. Unplug the AC adapter and all power and signal cables from the system.



3. Place the system on a flat, stable surface.
4. Remove the battery pack.

## Disassembly Process

**IMPORTANT:**The LCD Module cannot be disassembled outside of factory conditions. If any part of the LCD Module is faulty, such as the camera, antenna or LCD panel, the whole module must be replaced.

The disassembly process is divided into the following stages:

- External module disassembly
- Main unit disassembly

The flowcharts provided in the succeeding disassembly sections illustrate the entire disassembly sequence. Observe the order of the sequence to avoid damage to any of the hardware components. For example, if you want to remove the mainboard, you must first remove the keyboard, then disassemble the inside assembly frame in that order.

### Main Screw List

Screw	Quantity	Part Number
M2.45D 8.0L K 5.5D 0.8T ZKNL	14	86.WBF02.001
M2.5D 5L K 5.5D ZK NL + CR3	23	86.WBF02.010
M2.46D 3.0L K 5.5D 0.8T ZKNL	3	86.WBF02.002
M1.98D 3.0L K 4.6D 0.8T ZKNL	20	86.WBF02.003
M3.0D 3.0L K 4.9D NI	8	86.WBF02.005
M2D 4.0L K 4.6D NI NL	2	86.WBF02.007
ASSY THML SPRING	4	86.WBF02.009

# External Module Disassembly Process

**IMPORTANT:**The outside housing and color may vary from the mass produced model.

## External Modules Disassembly Flowchart

The flowchart below gives you a graphic representation on the entire disassembly sequence and instructs you on the components that need to be removed during servicing. For example, if you want to remove the main board, you must first remove the keyboard, then disassemble the inside assembly frame in that order.

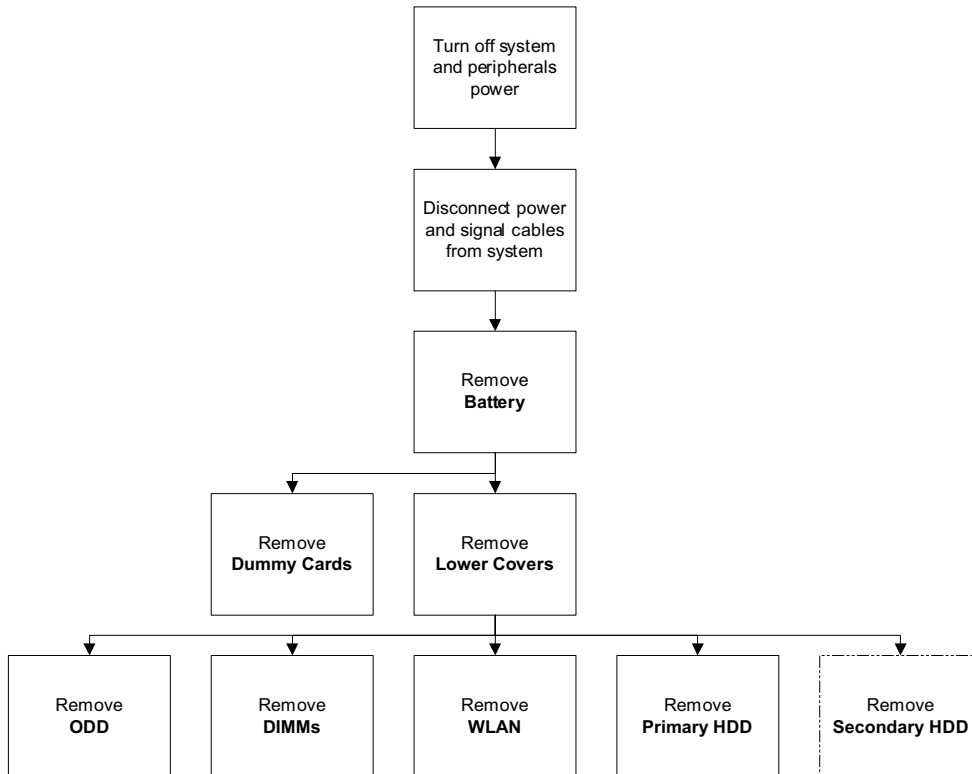

**NOTE:** Items enclosed with broken lines (— - - —) are optional and may not be present.

### Screw List

Step	Screw	Quantity	Part No.
WLAN Module	M2*3	1	86.WBF02.003
ODD Module	M2.5*5	1	86.WBF02.010
ODD Bracket	M2*3	2	86.WBF02.003
Primary HDD Carrier	M3*3	4	86.WBF02.005
Secondary HDD Carrier	M3*3	4	86.WBF02.005

---

## Removing the Battery Pack

1. Turn computer over. Slide the battery lock in the direction shown.

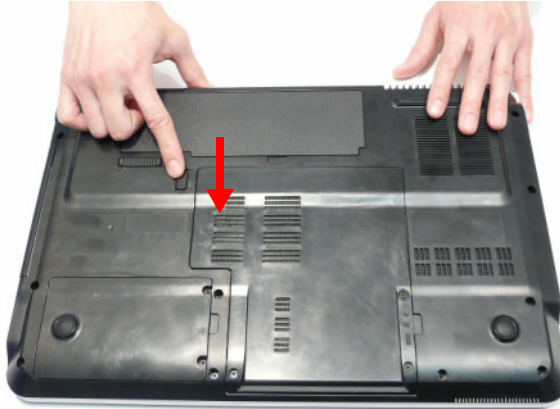

2. Slide and hold the battery release latch to the release position (1), then lift out the battery pack from the main unit (2).

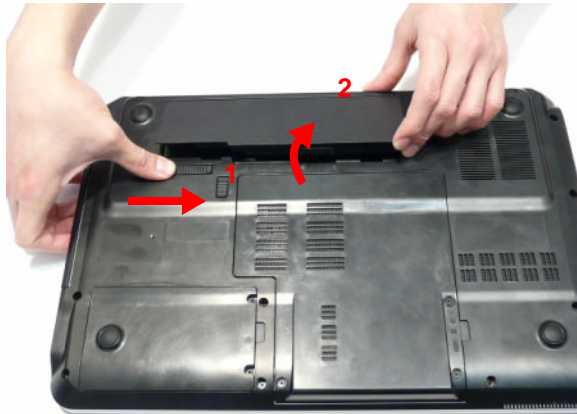

---

## Removing the SD dummy card

1. Push the SD dummy card all the way in to eject it.



2. Pull the card out from the slot.



---

## Removing the Lower Covers

1. See "Removing the Battery Pack" on page 52.
2. Loosen the five captive screws in the memory and HDD covers.

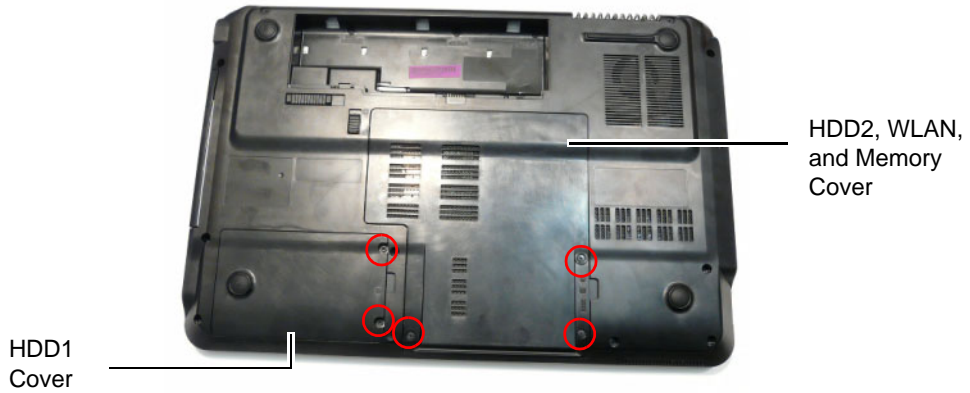

3. Remove the HDD1 Cover.

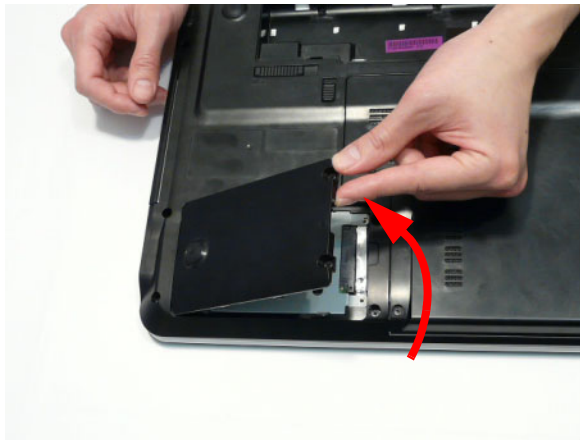

4. Remove the HDD2, WLAN, and Memory Cover as shown.





## Removing the Optical Drive Module

1. See "Removing the Lower Covers" on page 54.
2. Remove the screw securing the ODD module.

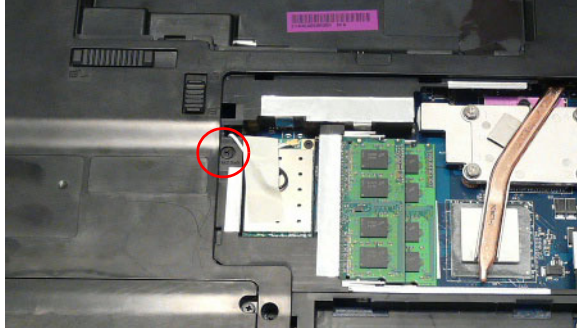

Step	Size	Quantity	Screw Type
ODD Module	M2.5*5	1	

3. Insert a suitable tool into the access slot as shown. Gently lever the ODD module out of the chassis.
4. Pull the optical drive module out from the chassis.

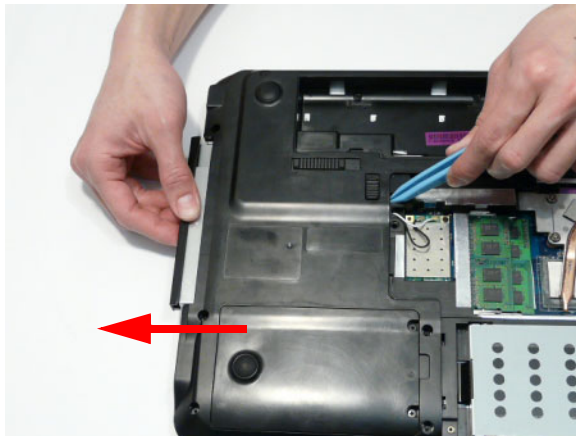

5. Remove the two screws securing the ODD bracket and remove the ODD bracket from the optical disk drive module.



Step	Size	Quantity	Screw Type
ODD Bracket	M2*3	2	

6. Remove the ODD bezel by rotating the top edge downward and pulling it clear of the module.



---

## Removing the DIMM Modules

1. See "Removing the Lower Covers" on page 54.
2. Push out the release latches on both sides of the DIMM socket to release the DIMM module.

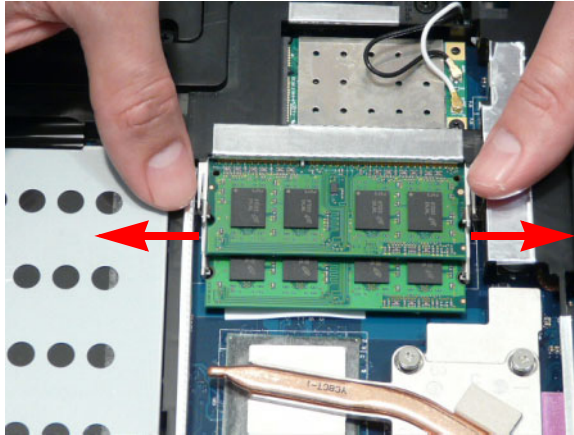

3. Remove the DIMM module.

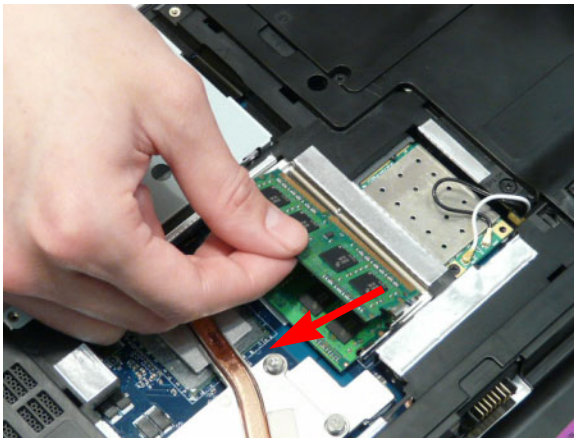

4. Repeat steps for the second DIMM module if present.

---

## Removing the WLAN Module

1. See "Removing the Lower Covers" on page 54.
2. Remove the adhesive tape securing the Antenna cables in place.

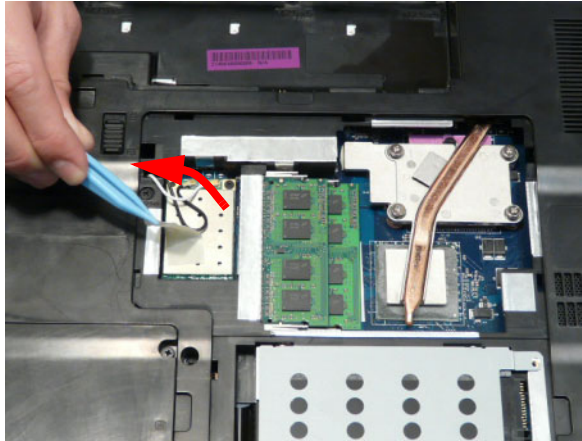

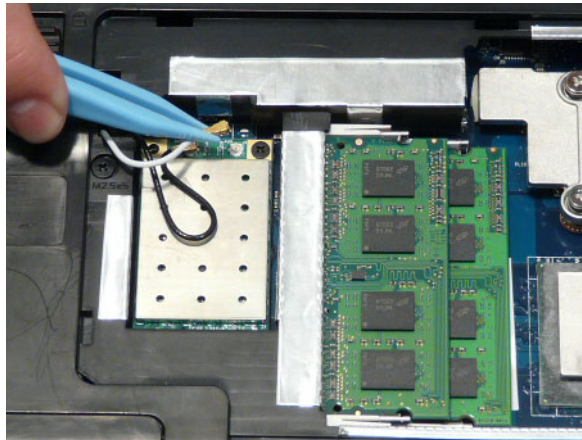

3. Disconnect the antenna cables from the WLAN Module.

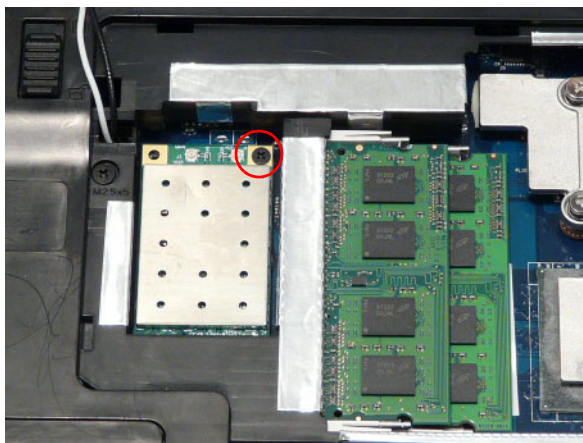

**NOTE:** Cable placement is **Black** to the **MAIN** terminal (left) and **White** to the **AUX** terminal (right).

4. Move the Antennas away and remove the two screws to release the WLAN Module.



Step	Size	Quantity	Screw Type
WLAN Module	M2*3	1	

5. Detach the WLAN Module from the WLAN socket.

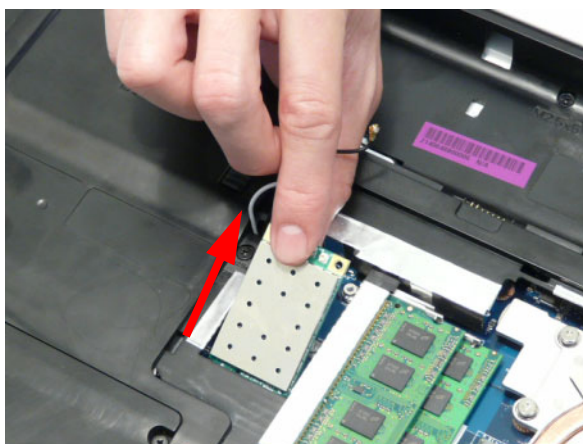

**NOTE:** When reattaching the antennas, ensure the cables are tucked into the chassis to prevent damage.

## Removing the Primary HDD Module

1. See "Removing the Lower Covers" on page 54.
2. Using the pull-tab, slide the HDD Module in the direction of the arrow to disconnect the interface.



3. Lift the HDD Module clear of the HDD bay.  
**NOTE:** To prevent damage to device, avoid pressing down on it or placing heavy objects on top of it.
4. Remove the four screws (two each side) securing the hard disk to the carrier.

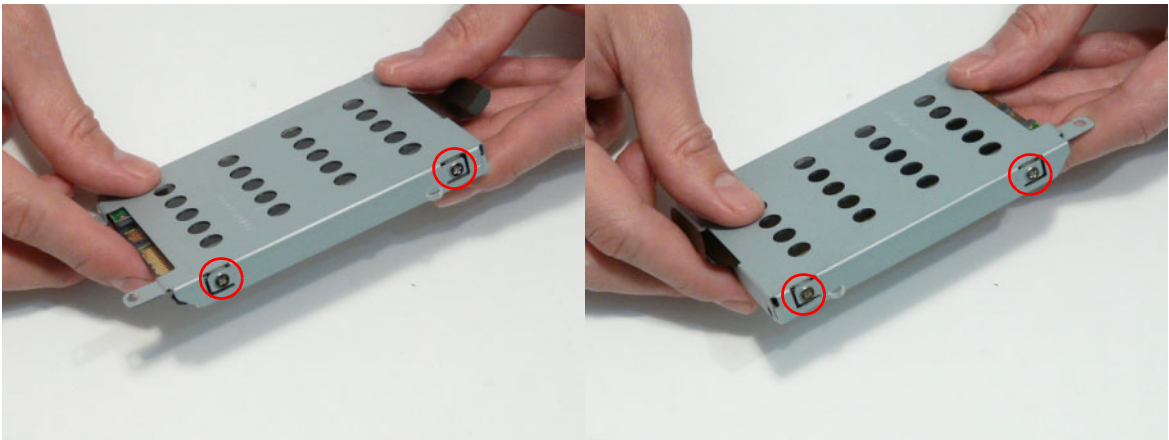

Step	Size	Quantity	Screw Type
HDD Carrier	M3*3	4	

---

5. Remove the HDD from the carrier.

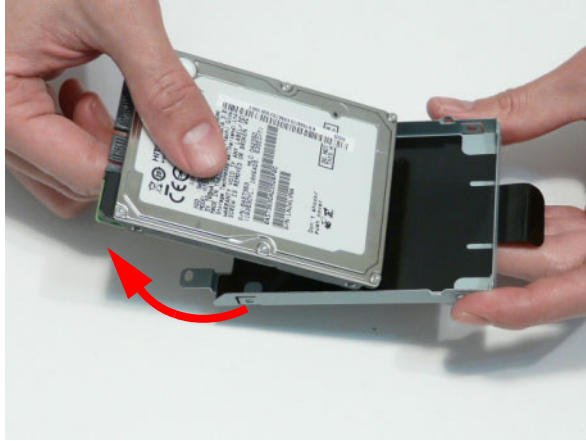

---

## Removing the Secondary HDD Module

**NOTE:** The Secondary HDD is optional and may not be present.

1. See “Removing the Lower Covers” on page 54.
2. Using the pull-tab, slide the HDD Module in the direction of the arrow to disconnect the interface.

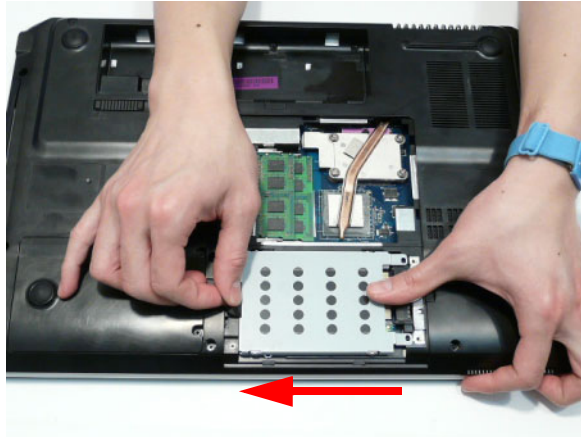

3. Lift the HDD Module clear of the HDD bay.

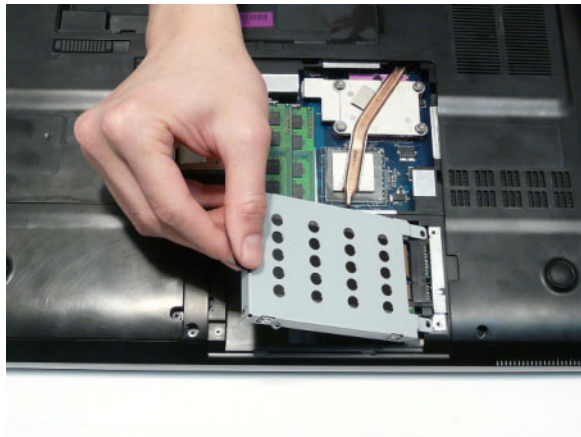

**NOTE:** To prevent damage to device, avoid pressing down on it or placing heavy objects on top of it.



4. Remove the four screws (two each side) securing the hard disk to the carrier.

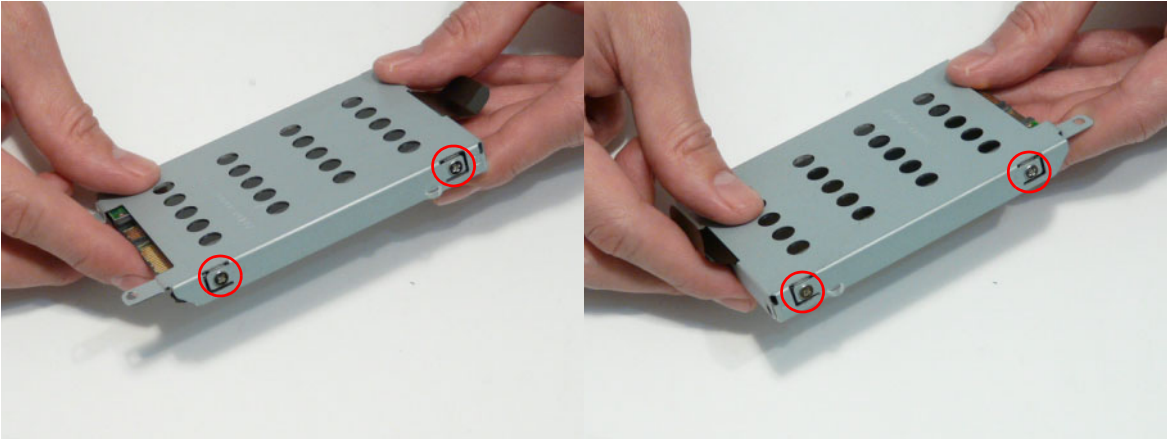

Step	Size	Quantity	Screw Type
HDD Carrier	M3*3	4	

5. Remove the HDD from the carrier.



# Main Unit Disassembly Process

## Main Unit Disassembly Flowchart

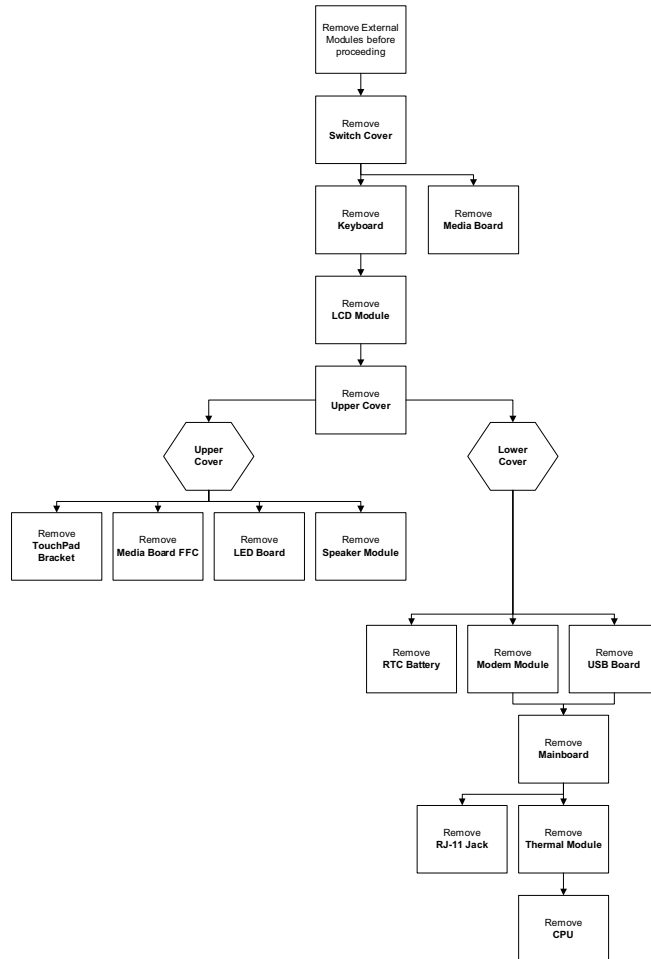

### Screw List

Step	Screw	Quantity	Part No.
Switch Cover	M2.5*5	3	86.WBF02.010
LCD Module	M2.5*8	4	86.WBF02.001
	M2.5*5	2	86.WBF02.010
Upper Cover	M2.5*8	10	86.WBF02.001
	M2.5*5	9	86.WBF02.010
	M2.5*3	3	86.WBF02.002
TouchPad Bracket	M2*3	1	86.WBF02.003
Speaker Module	M2*3	4	86.WBF02.003
Modem Board	M2*3	2	86.WBF02.003
USB Board	M2.5*5	1	86.WBF02.010
Mainboard	M2.5*5	1	86.WBF02.010
CPU Fan	M2*3	3	86.WBF02.003
Thermal Module	M2.5*6.5	4	86.WBF02.009

## Removing the Switch Cover

1. See "Removing the Battery Pack" on page 52.
2. Lift the Media Board FFC cover as shown to expose the FFC connector.

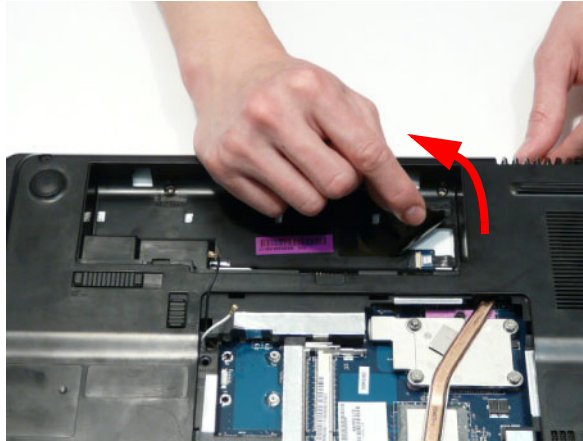

3. Open the FFC locking latch and disconnect the Media Board FFC.



4. Remove the three securing screws from the Lower Cover.

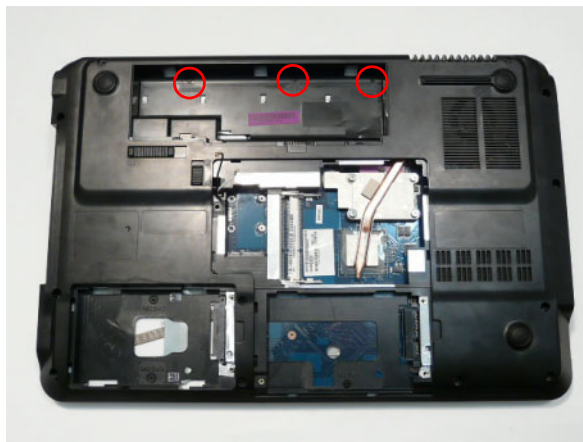

Step	Size	Quantity	Screw Type
Switch Cover	M2.5*5	3	

- 
5. Open the computer lid to approximately 45° and push the Switch Cover from the underside of the computer to release the locking latches securing the cover in place.



6. Turn the computer over and open the lid fully. Lift the left side of the Switch Cover as shown.

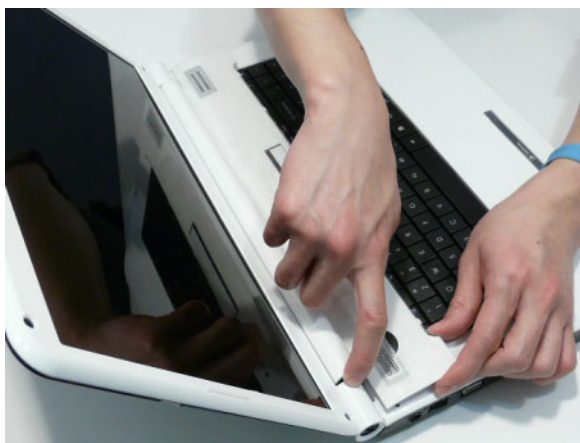

7. Working along the Switch Cover toward the right hinge, gently pry up the cover as shown.



---

8. Rotate the Switch Cover toward the LCD panel and lift it away from the Upper Cover.

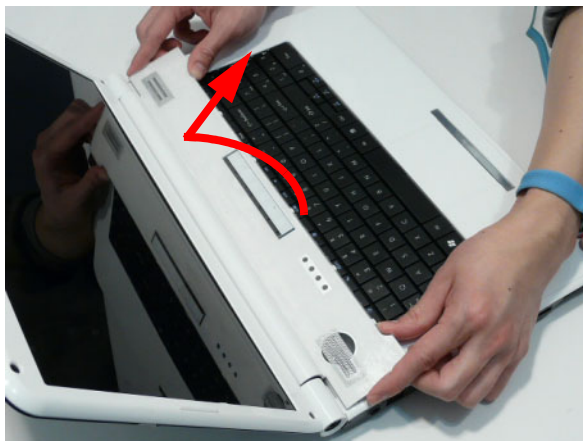

---

## Removing the Media Board

1. See "Removing the Switch Cover" on page 65.
2. Pry the Media Board away from the Switch Cover as shown.  
**NOTE:** A very strong adhesive is used to secure the board in place.



3. Pry the board away from the Upper Cover and remove it completely.

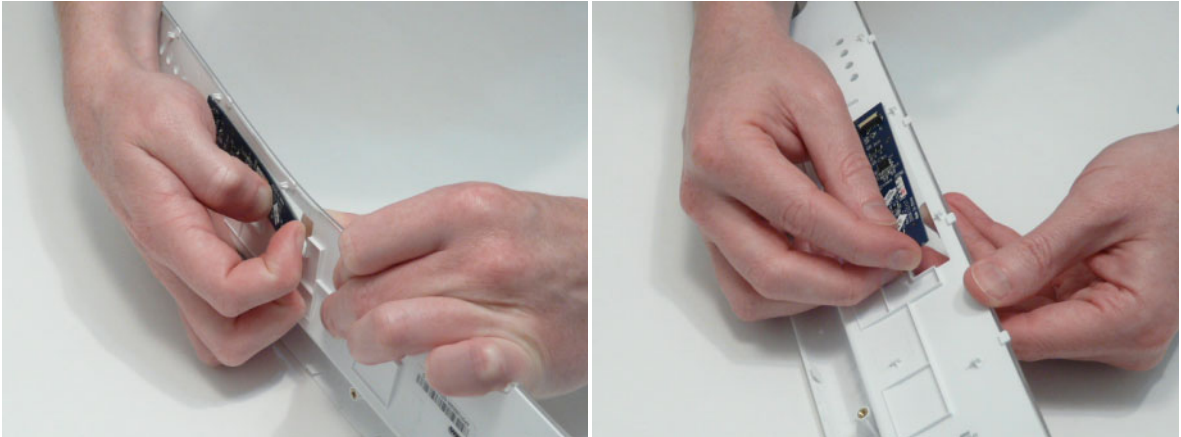

---

## Removing the Keyboard

1. See "Removing the Switch Cover" on page 65.
2. Lift the keyboard from the centre as shown to release the securing clips on each side.



3. Turn the Keyboard over on the TouchPad to expose the FFC cable.

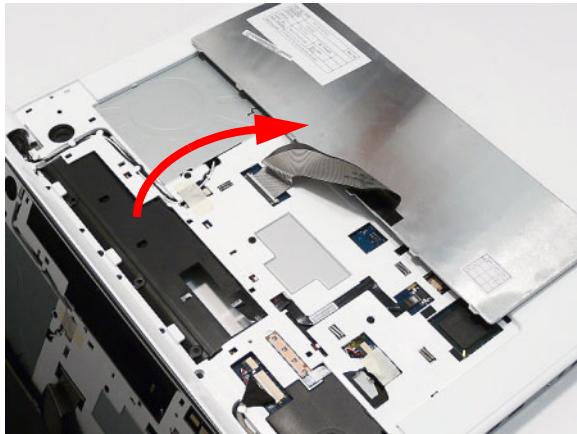

4. Open the locking latch on the FFC as shown.

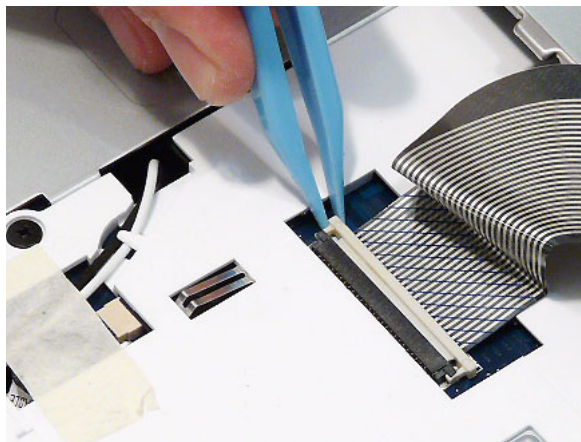

---

5. Disconnect the FFC cable from the mainboard.

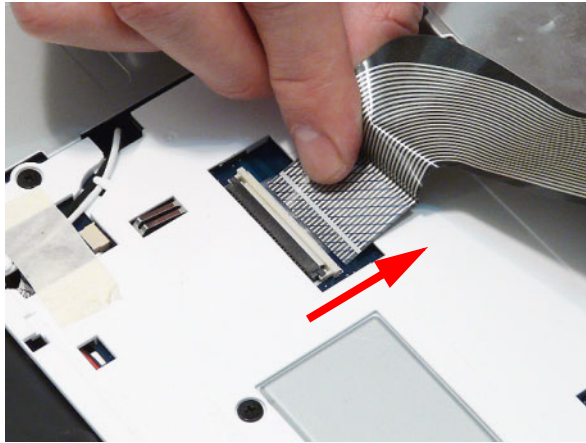



6. Lift the keyboard clear of the chassis.

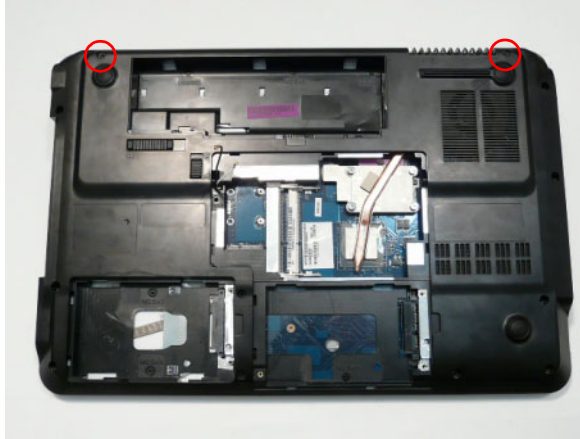

## Removing the LCD Module

1. See "Removing the Keyboard" on page 69.
2. Turn the computer over. Remove the two securing screws from the bottom of the chassis.



Step	Size	Quantity	Screw Type
LCD Module	M2.5*8	2	

3. Open the computer lid and stand the chassis on its edge. Ensure the Antenna Cables are free from obstructions as shown.

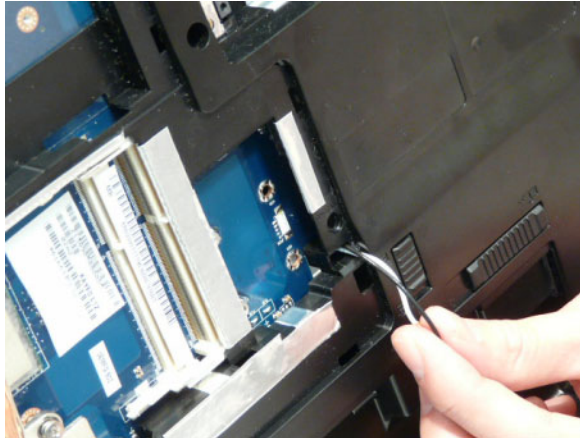

4. Remove the adhesive tape securing the cables in place and pull the Antenna cables through the casing as shown.

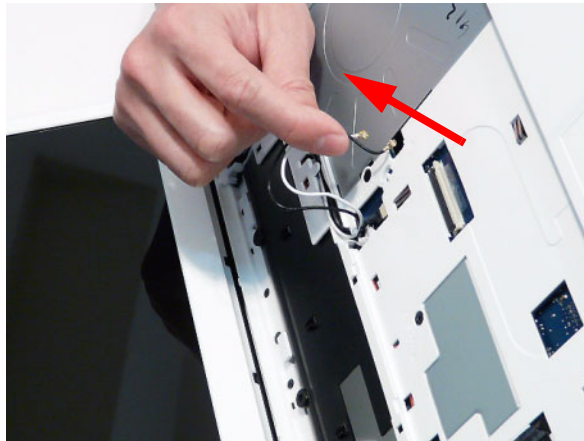
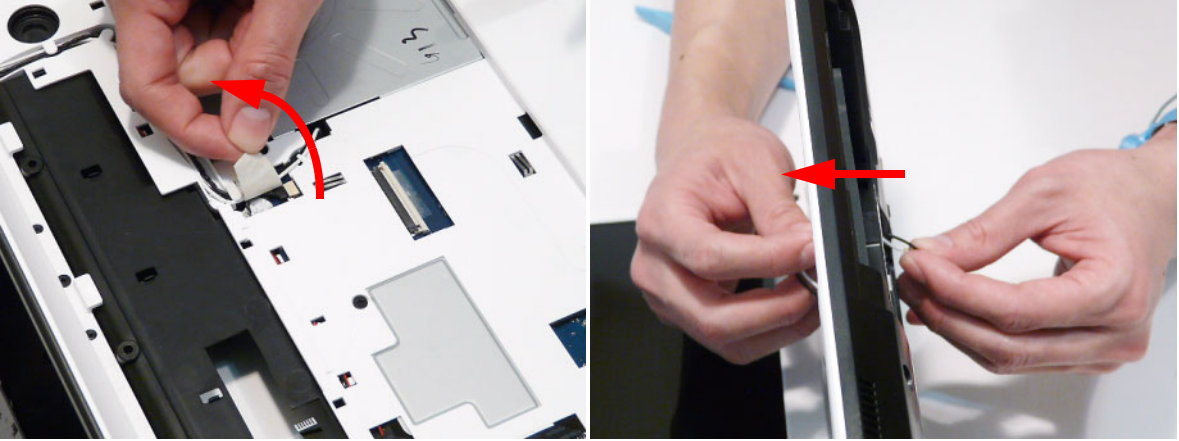

5. Remove the cables from the cable channel as shown. Ensure that the cables are completely free of the retaining clips all the way to the hinge well.

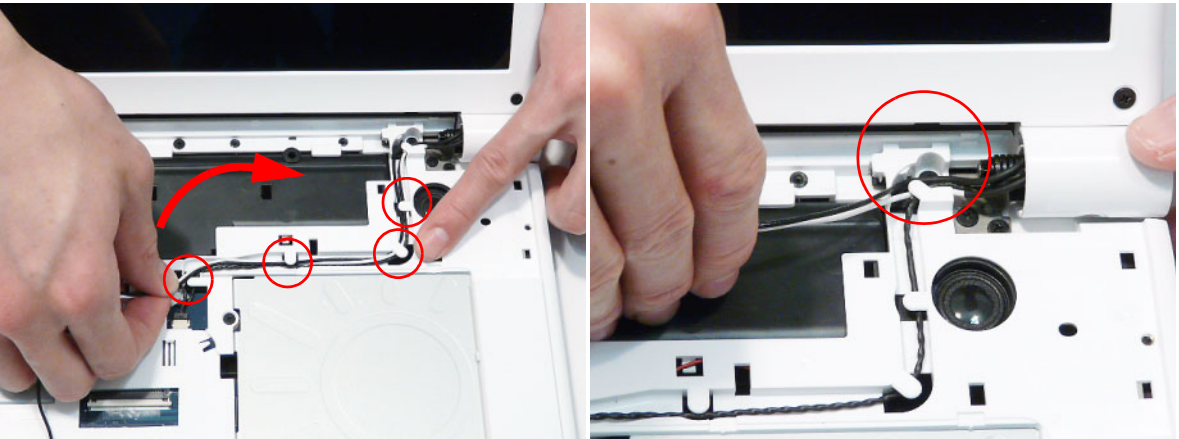

6. Disconnect the Power Board cable from the Mainboard.

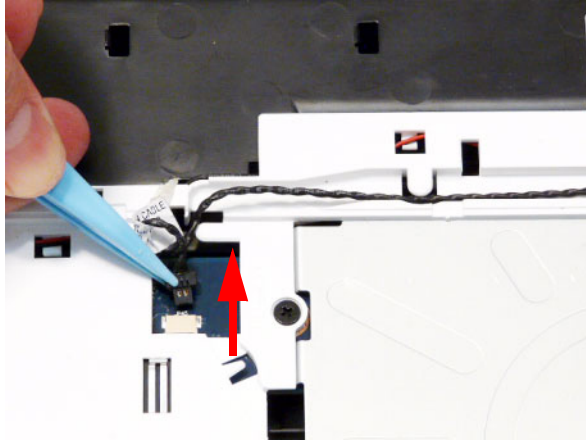

7. Remove the cable from the cable channel as shown. Ensure that the cable is completely free of the retaining clips all the way to the hinge well.

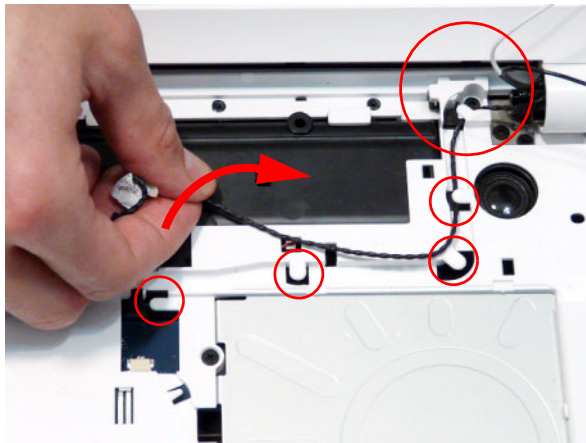

8. Disconnect the power cable from the Mainboard as shown. Ensure that the cable is completely free of the retaining clips all the way to the hinge well.

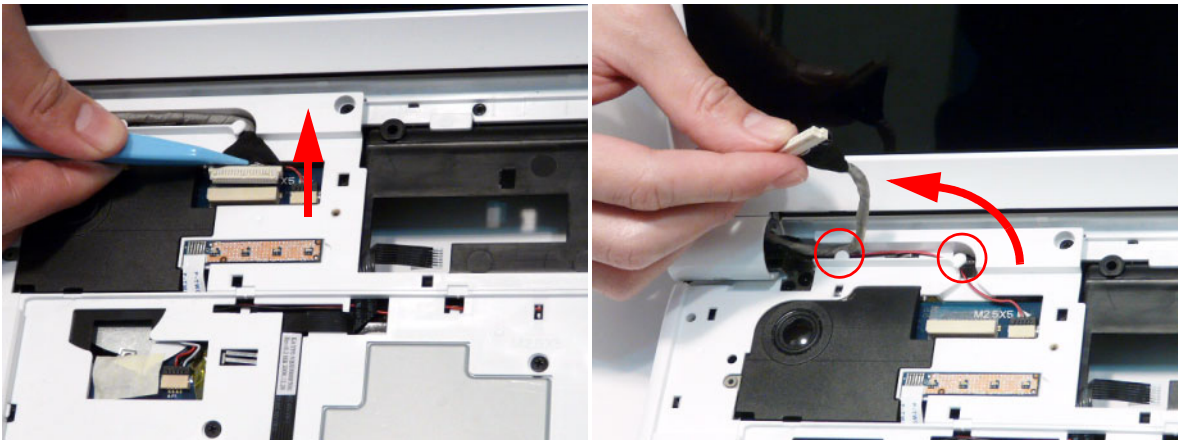

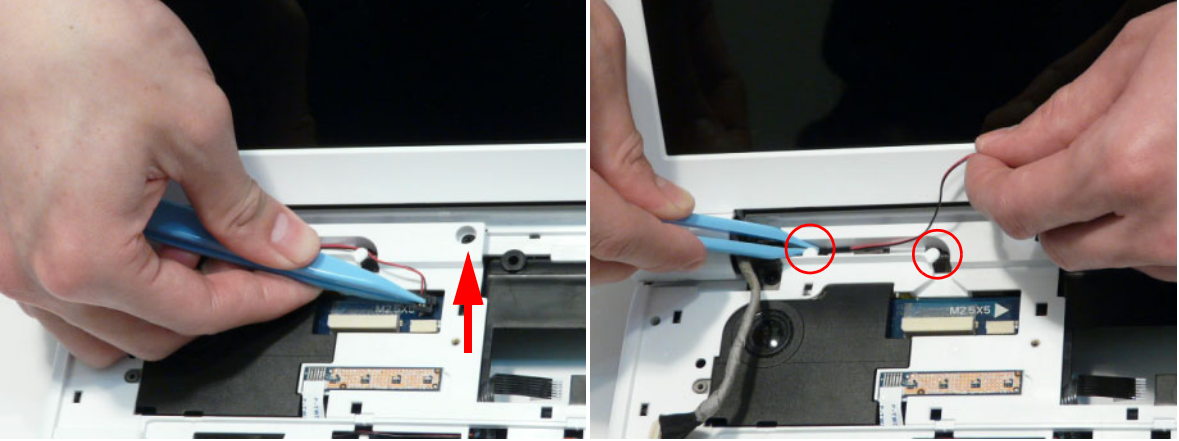

9. Disconnect the MIC cable from the Mainboard as shown. Ensure that the cable is completely free of the retaining clips all the way to the hinge well.

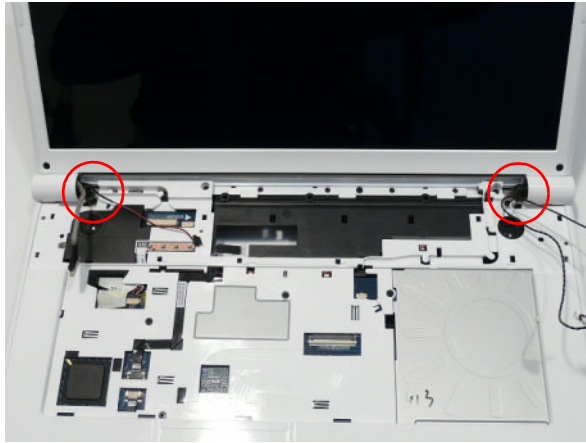

10. Remove the four securing screws (two each side) from the LCD module.



Step	Size	Quantity	Screw Type
LCD Module (red callout)	M2.5*8	2	
LCD Module (green callout)	M2.5*5	2	

---

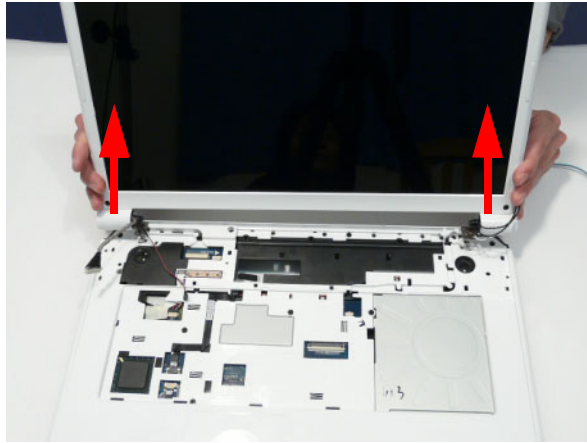

11. Carefully remove the LCD module from the chassis.



## Removing the Upper Cover

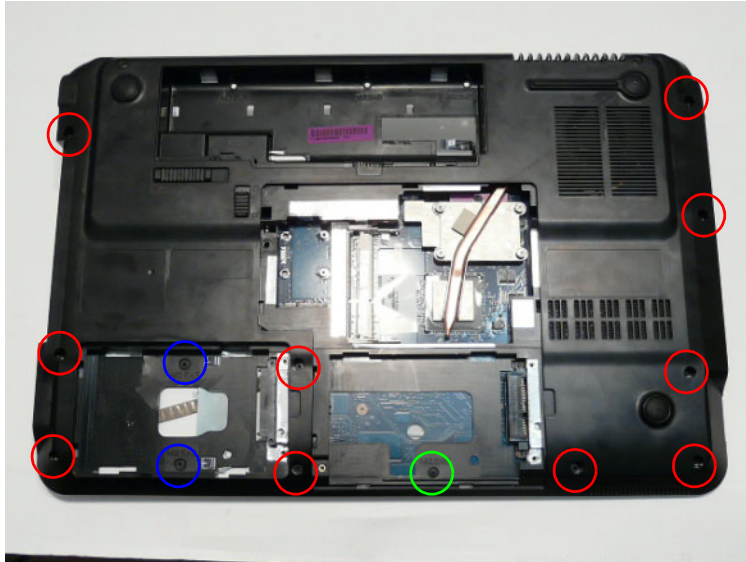

1. See "Removing the LCD Module" on page 71.
2. Turn the computer over. Remove the thirteen screws on the bottom panel.

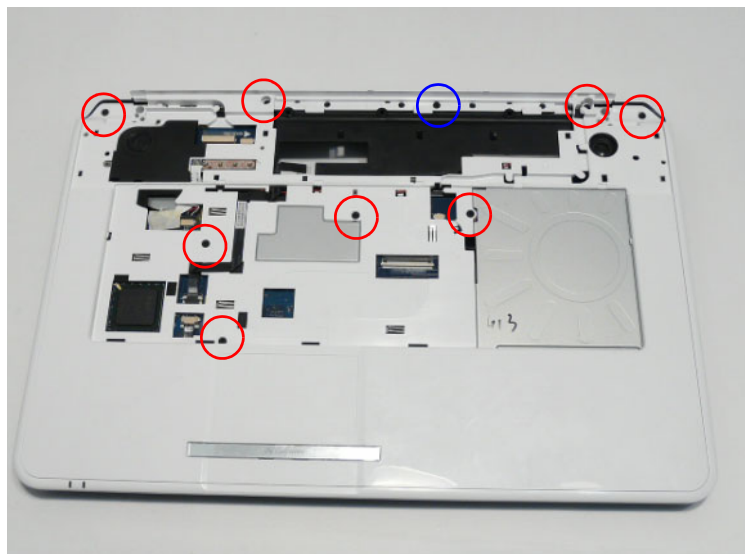

Step	Size	Quantity	Screw Type
Upper Cover (red callout)	M2.5*8	10	
Upper Cover (green callout)	M2.5*5	1	
Upper Cover (blue callout)	M2.5*3	2	

3. Turn the computer over. Remove the nine screws on the top panel.



Step	Size	Quantity	Screw Type
Upper Cover (red callout)	M2.5*5	8	
Upper Cover (blue callout)	M2.5*3	1	

4. Remove the adhesive tape holding the cables in place.

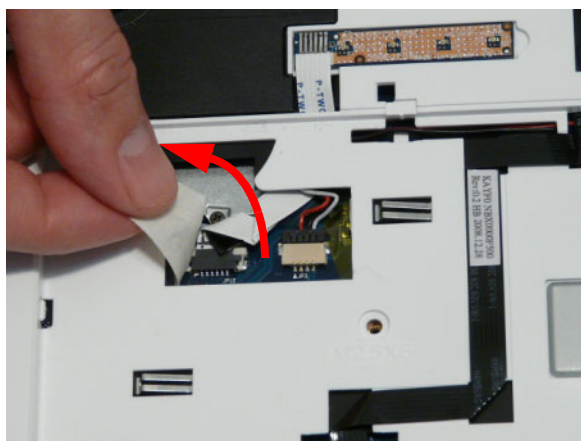

5. Disconnect the following cables from the Mainboard.

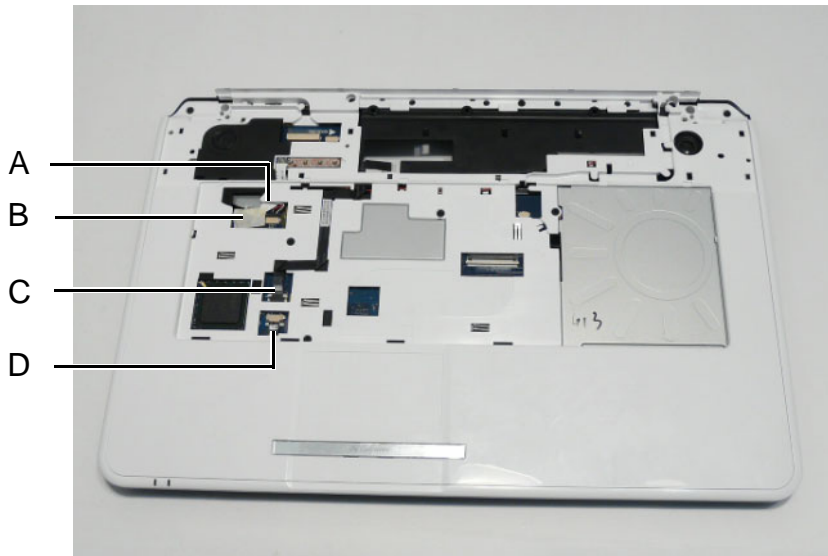

6. Disconnect A as shown.

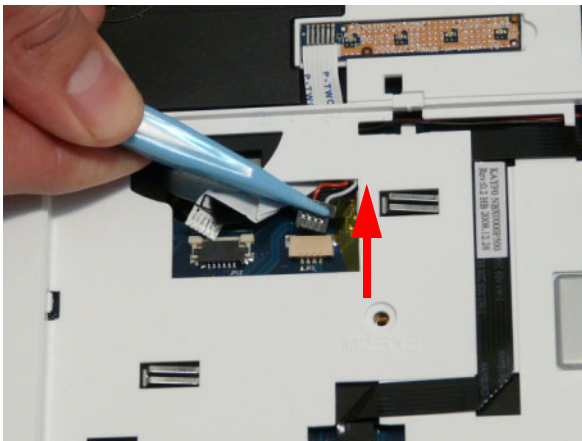

7. Release the locking latch and remove B as shown.

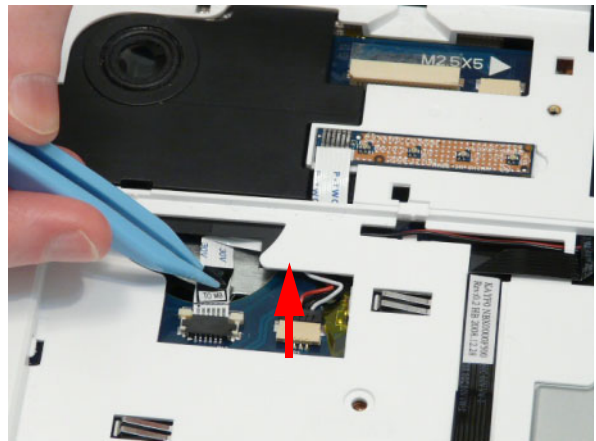

8. Release the locking latch and remove C as shown.

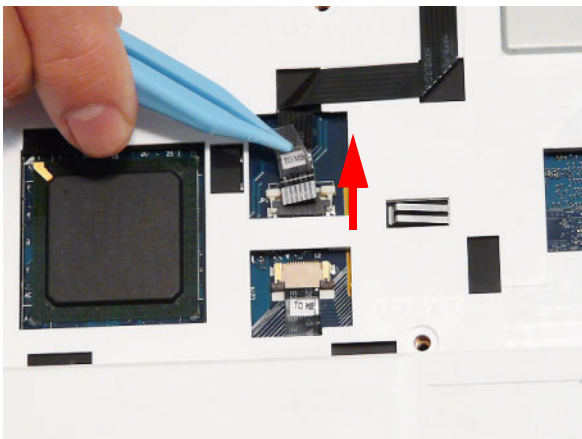

9. Release the locking latch and remove D as shown.

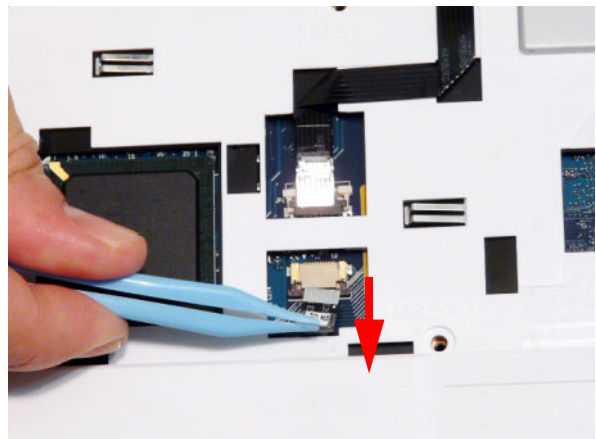

**NOTE:** Avoid pulling on cables directly to prevent damage to the connectors. Use the pull-tabs on FFC cables whenever available to prevent damage.



10. Starting at the top-inside edges of the Upper Cover above the Battery Bay, lift the Upper Cover away from the Lower Cover as shown.

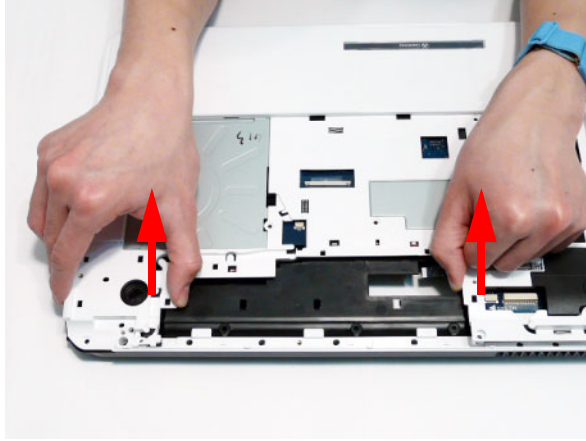

11. Work along the top edge prying the casing apart as shown.

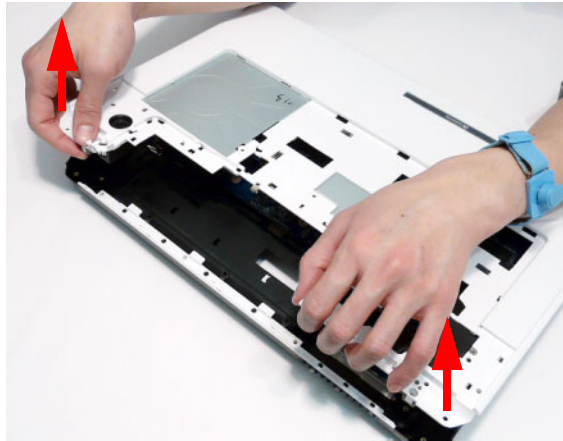

12. Pry apart the left and right sides of the casing and lift the Upper Cover away from the Lower Cover.

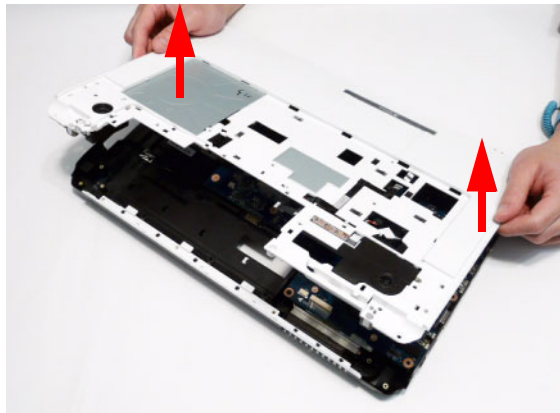

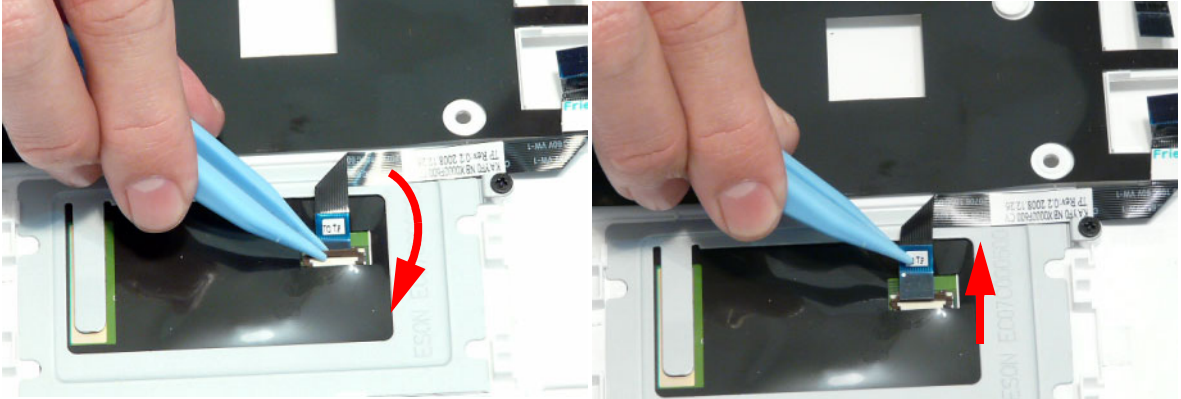

# Removing the TouchPad Bracket

1. See "Removing the Upper Cover" on page 76.
2. Release the FFC locking latch and disconnect the TouchPad FFC from the cover.

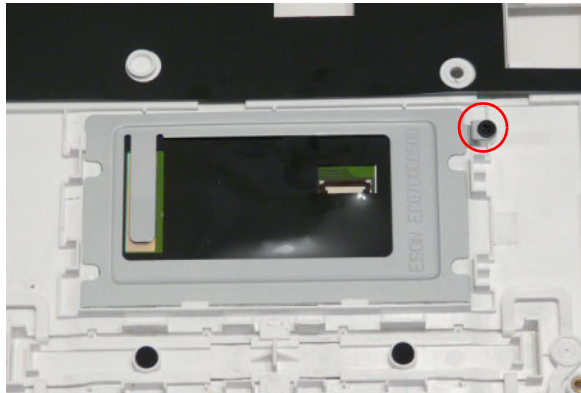

3. Remove the single screw securing the TouchPad Bracket to the Upper Cover.



Step	Size	Quantity	Screw Type
TouchPad Bracket	M2*3	1	

4. Hold down the left side of the bracket as shown. Lift and pivot the right edge in the direction of the arrow to release the locking latches on the front edge.

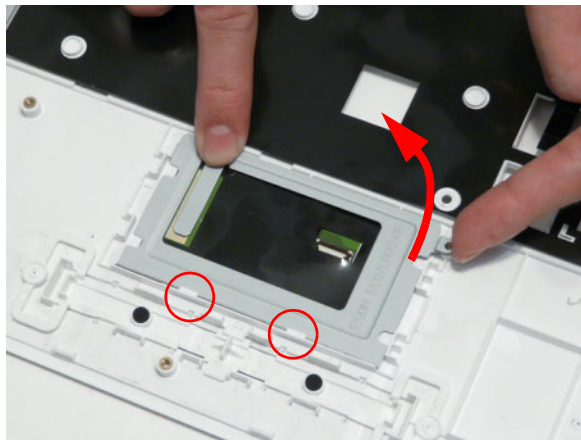

5. Remove the bracket from the Upper Cover.

---

## Removing the Media Board FFC

1. See "Removing the Upper Cover" on page 76.
2. Lift the Media Board FFC as shown to release the adhesive securing it to the Upper Cover.

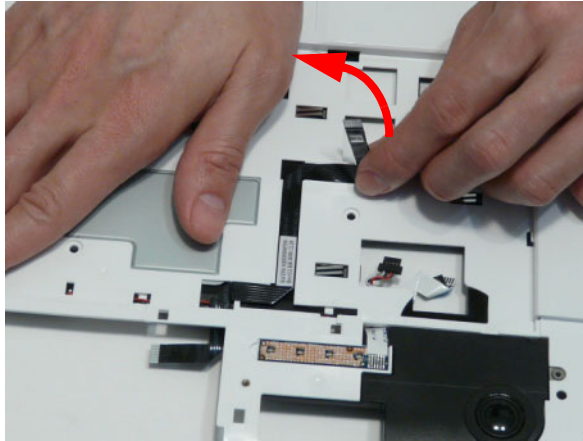

3. Pull the FFC through the Upper Cover as shown. Ensure that the cable passes through the casing completely.

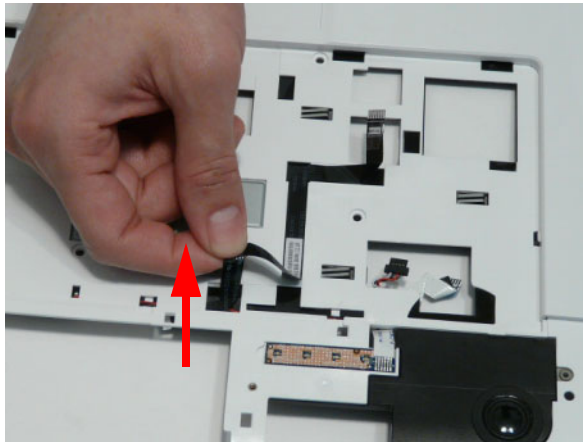

4. Lift the FFC to remove it from the Upper Cover.

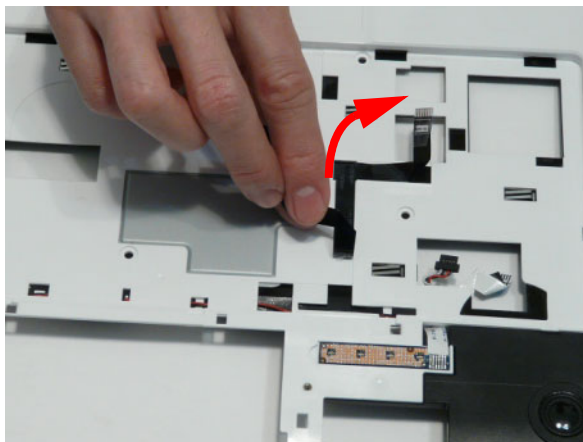

---

## Removing the LED Board

1. See "Removing the Upper Cover" on page 76.
2. Lift the right edge of the LED Board to release the adhesive securing the board to the Upper Cover.

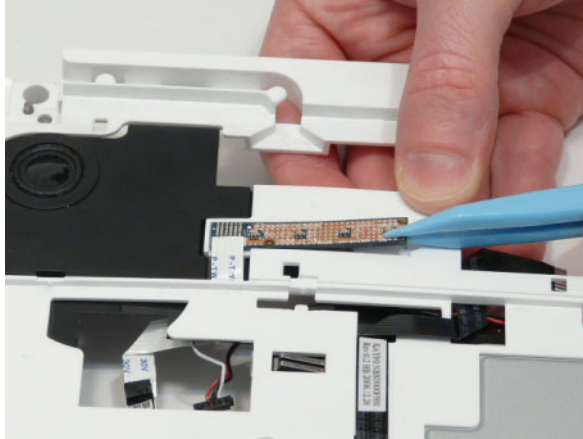

3. Lift the LED Board away from the Upper Cover as shown.

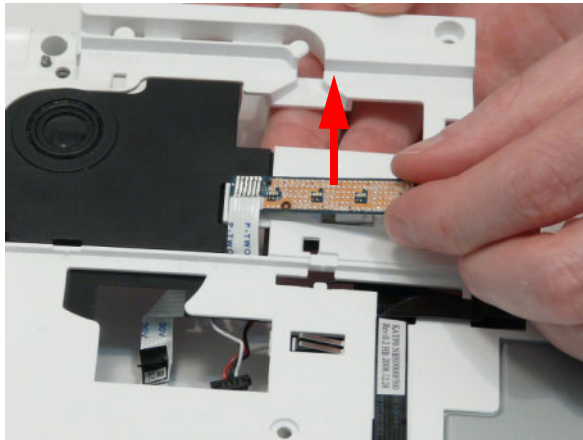

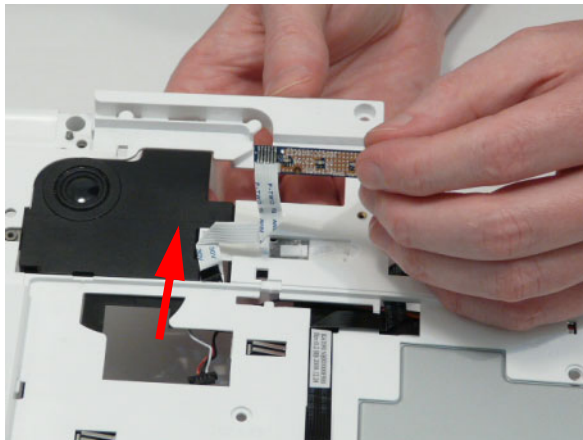

4. Remove the LED Board from the chassis and slide the FFC through the casing as shown.

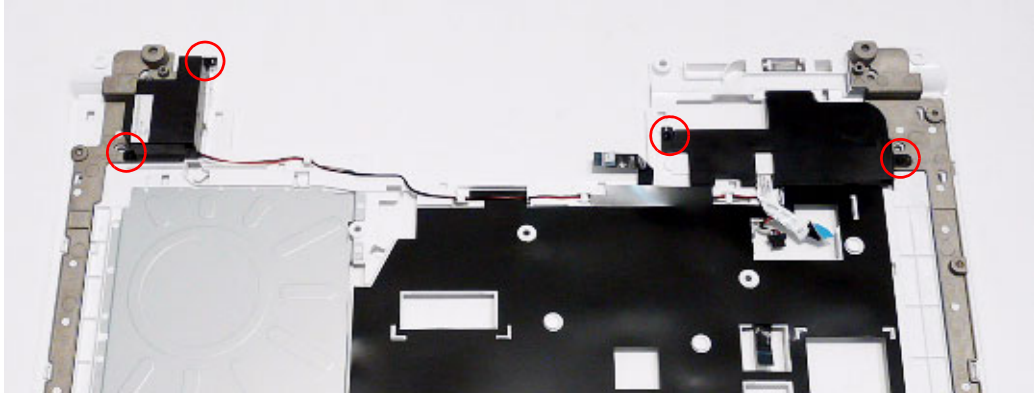

## Removing the Speaker Module

1. See "Removing the Upper Cover" on page 76.
2. Remove the four screws from the speaker modules.



Step	Size	Quantity	Screw Type
Speaker Module	M2*3	4	

3. Remove the right side Speaker cable from the channel as shown.

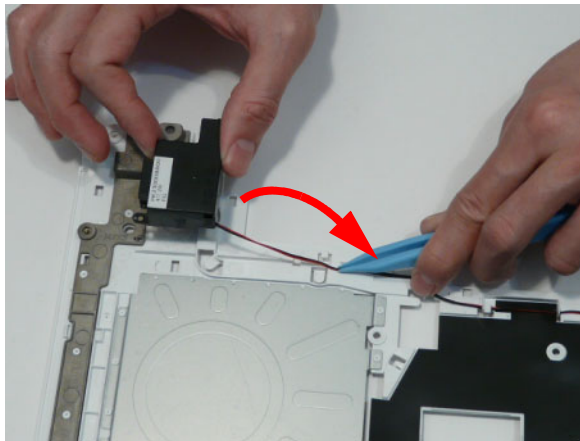

4. Lift the mylar sheet away from the Upper Cover to expose the Speaker cable. Remove the cable from the Upper Cover.

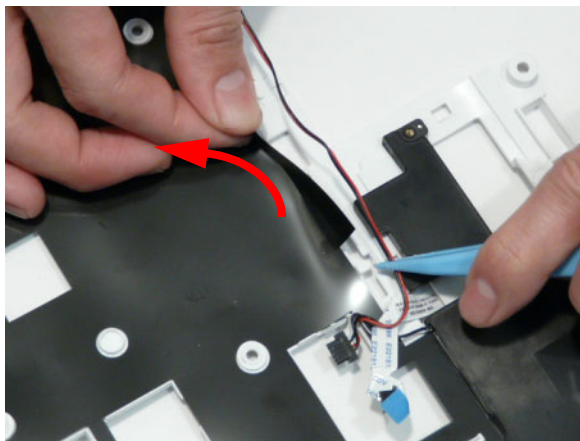

---

5. Lift the entire Speaker assembly clear of the Upper Cover.

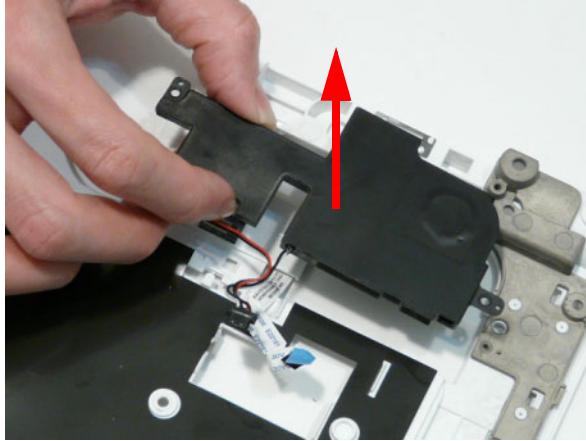

---

## Removing the RTC Battery

**IMPORTANT:** Follow local regulations for disposal of all batteries.

1. See "Removing the Upper Cover" on page 76.
2. The RTC Battery is soldered to the Mainboard. To replace the battery, solder the new battery to the connections shown.

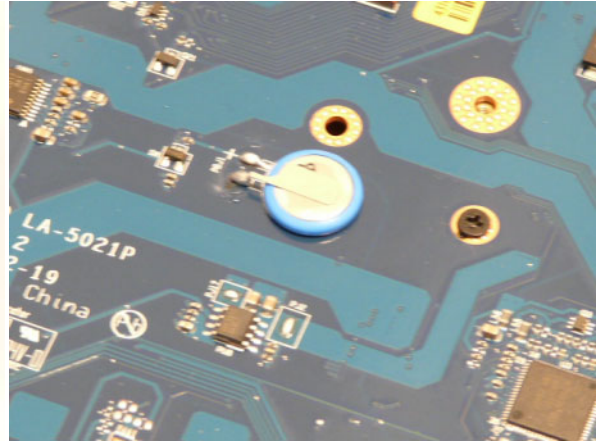
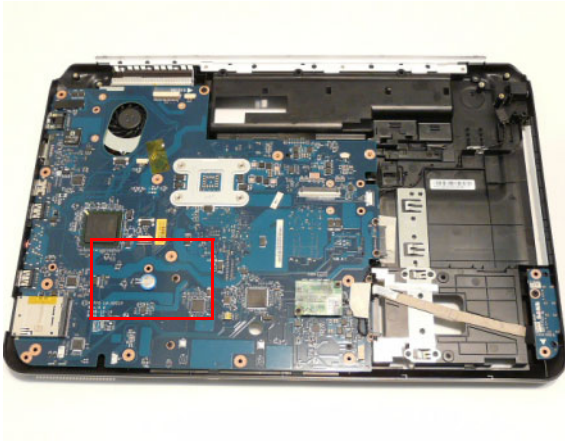

## Removing the Modem Board

1. See "Removing the Upper Cover" on page 76.
2. Remove the two securing screws from the Modem Board.

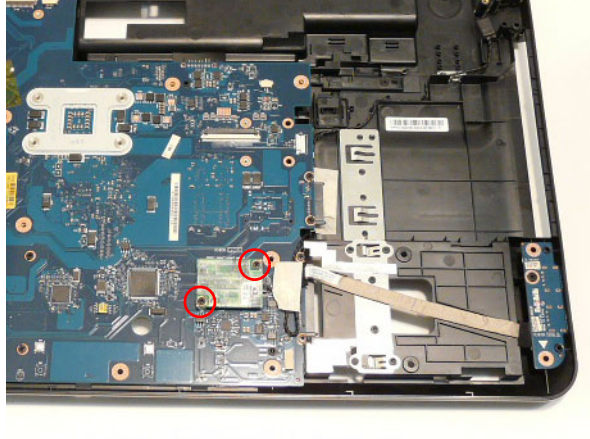

Step	Size	Quantity	Screw Type
Modem Board	M2*3	2	

3. Remove the adhesive tape securing the Modem cable to the Mainboard.

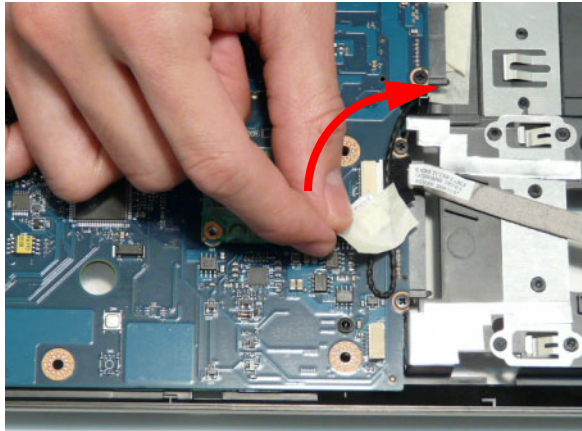



- 
4. Lift the Modem Board away from the Mainboard, taking care not to damage the cable attached to the underside of the board.

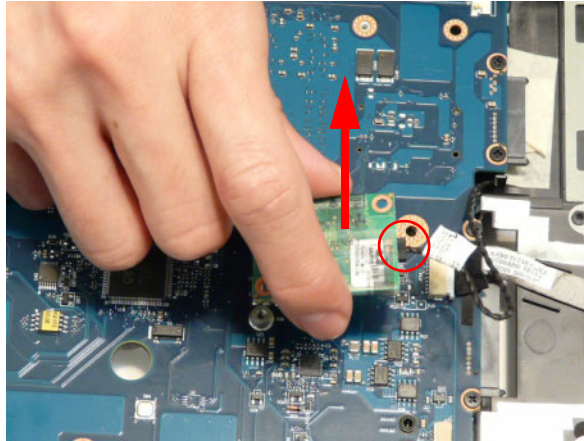

5. Disconnect the cable from the underside of the Modem Board and lift the board clear of the chassis.

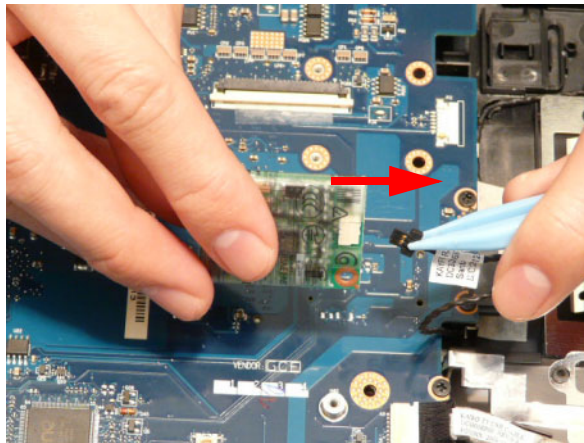

## Removing the USB Board

1. See "Removing the Upper Cover" on page 76.
2. Disconnect the USB Board cable from the Mainboard connector.

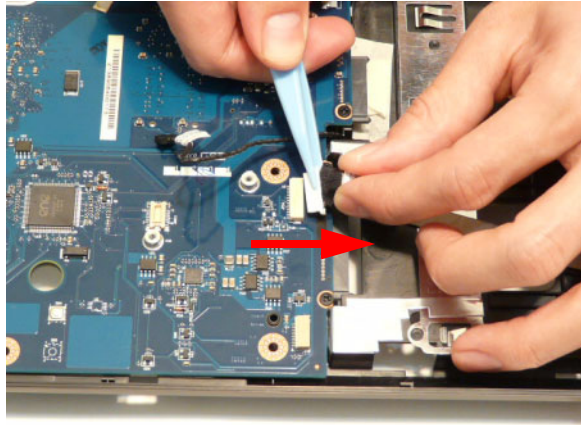

3. Lift the USB cable away from Lower Cover to detach the adhesive.

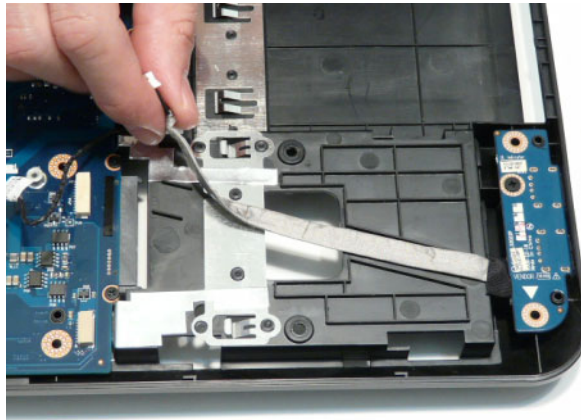

4. Remove the single screw securing the USB Board to the Lower Cover.

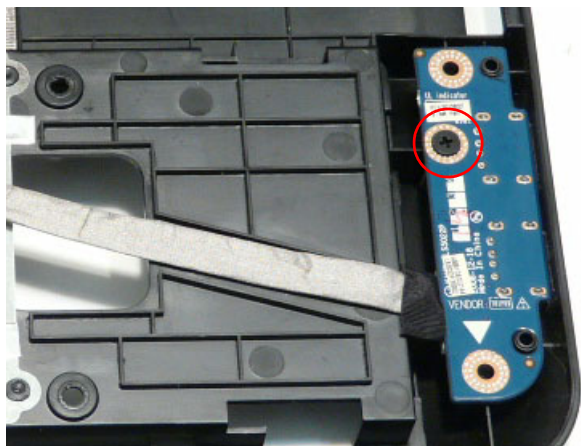

Step	Size	Quantity	Screw Type
USB Board	M2.5*5	1	

5. Lift the USB Board out of the Lower Cover as shown.



6. Remove the USB Board cable from the board connector.

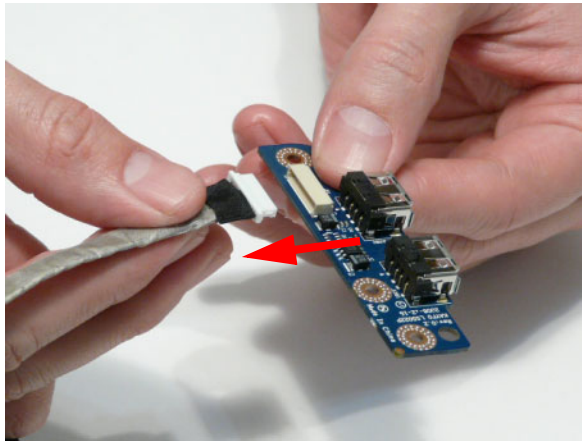

## Removing the Mainboard

1. See "Removing the Modem Board" on page 86.
2. See "Removing the USB Board" on page 88.
3. Remove the single screw securing the Mainboard to the Lower Cover.



Step	Size	Quantity	Screw Type
Mainboard	M2.5*5	1	

4. Lift the Mainboard from the Lower Cover right side first, and place it on a clean, dust-free surface.



---

## Removing the RJ-11 Jack

1. See “Removing the Mainboard” on page 90.
2. Remove the adhesive tape securing the RJ-11 cable to the Lower Cover.

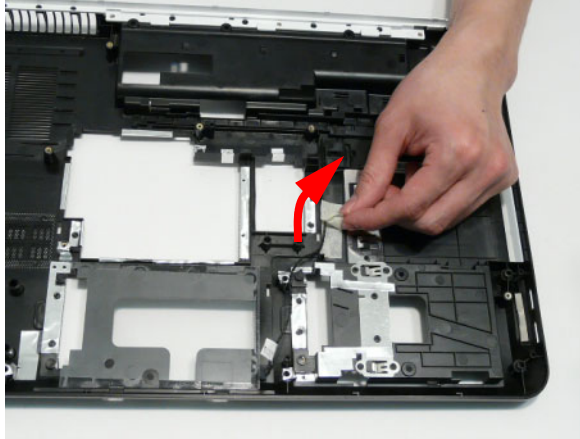

3. Remove the RJ-11 cable from the cable channel. Ensure that the cable is free from all cable clips.

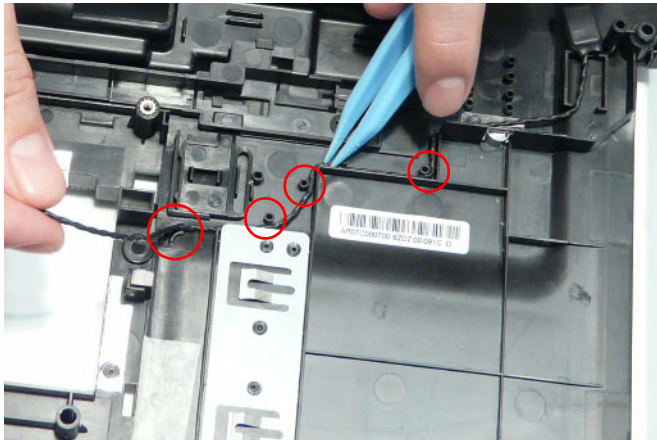

4. Lift the cable bundle away from the Lower Cover to detach the adhesive securing it in place.

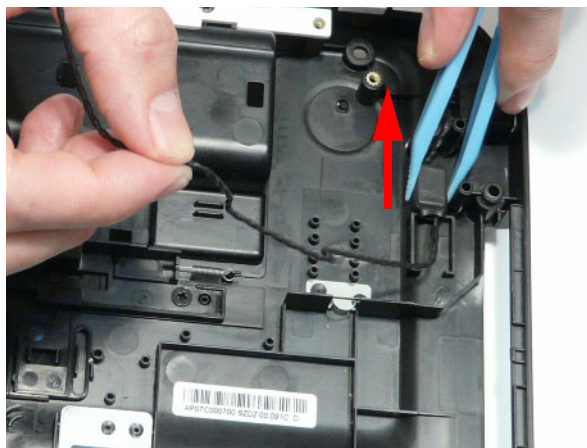

---

5. Lift the RJ-11 Jack away from the Lower Cover to detach the adhesive securing it in place.

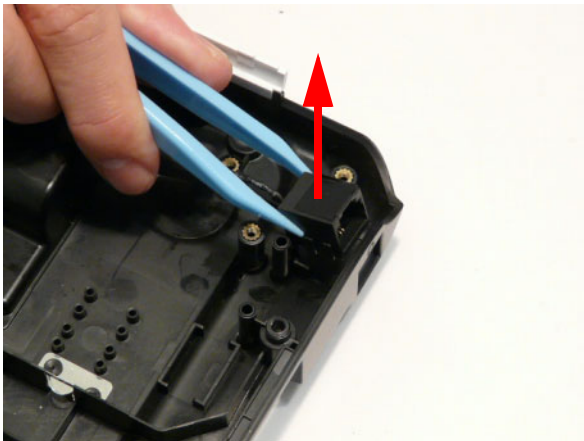

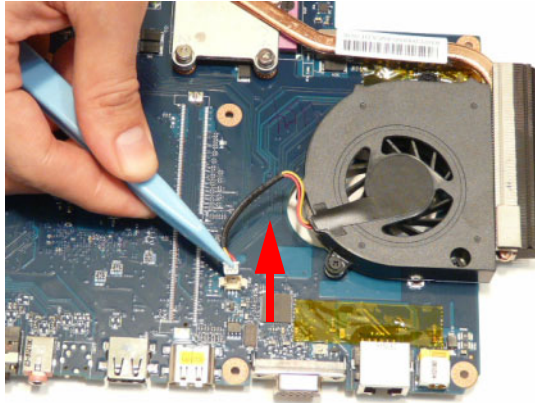

## Removing the CPU Fan

1. See "Removing the Mainboard" on page 90.
2. Disconnect the CPU Fan power cable from the Mainboard.

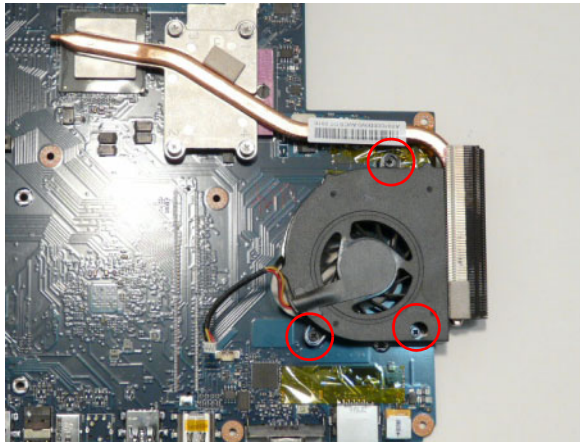

3. Remove the three securing screws from the CPU Fan.



Step	Size	Quantity	Screw Type
CPU Fan	M2*3	3	

4. Remove the CPU Fan from the Mainboard.

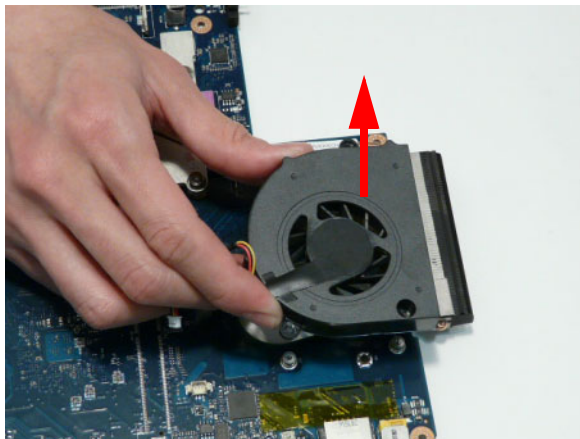

## Removing the Thermal Module

1. See "Removing the Mainboard" on page 90.
2. Remove the four screws securing the Thermal Module to the Mainboard in reverse numerical order from 4 to 1.

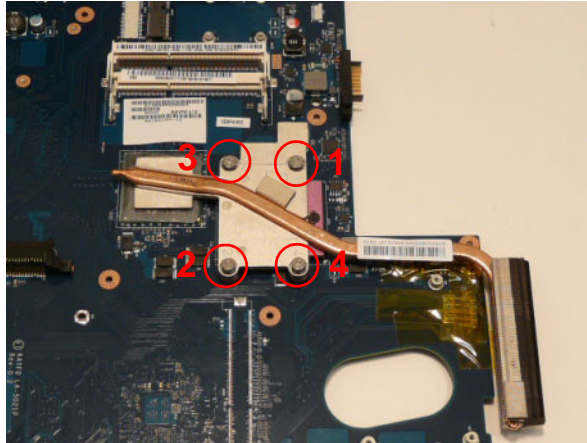

Step	Size	Quantity	Screw Type
Thermal Module	M2.5*6.5	4	

3. Using both hands, lift the Thermal Module clear of the Mainboard.

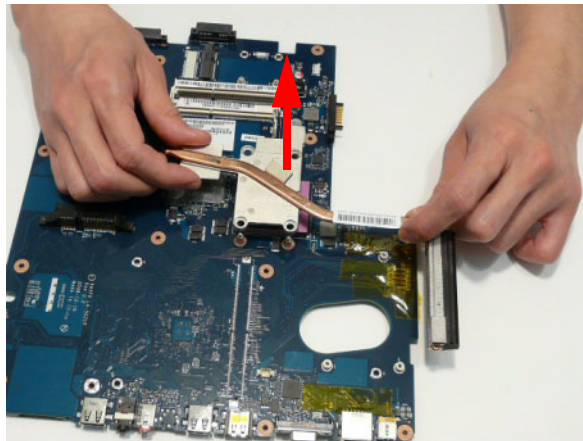



---

## Removing the CPU

1. See “Removing the Thermal Module” on page 94.
2. Using a flat-bladed screw driver, rotate the CPU locking screw 180° counter-clockwise as shown.

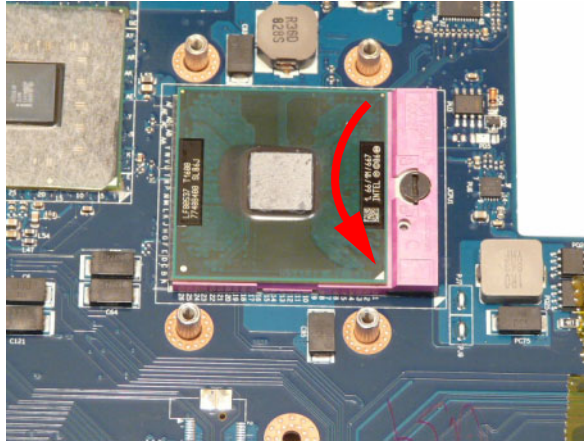

3. Lift the CPU clear of the socket as shown.

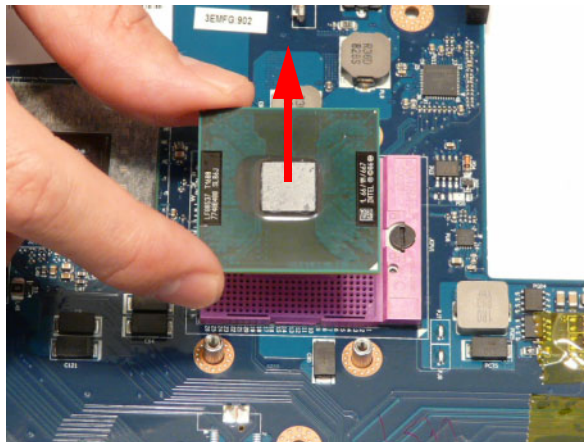

# LCD Module Disassembly Process

## LCD Module Disassembly Flowchart

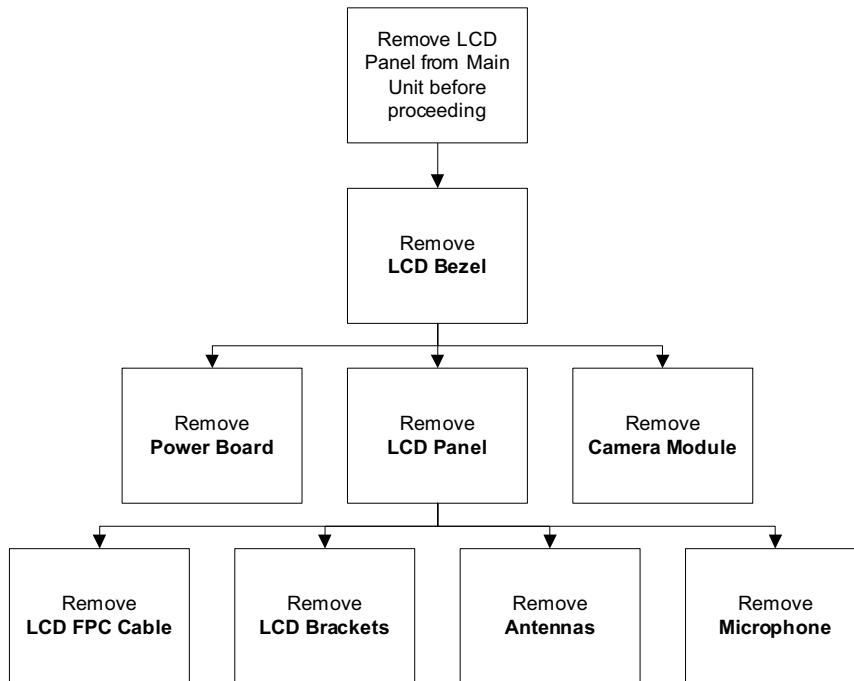



### Screw List

Step	Screw	Quantity	Part No.
LCD Bezel	M2.5*5	4	86.WBF02.010
	M2*4	2	86.WBF02.007
LCD Panel	M2.5*5	2	86.WBF02.010
Power Board	M2*3	1	86.WBF02.003
LCD Brackets	M2*3	6	86.WBF02.003

## Removing the LCD Bezel

1. See "Removing the LCD Module" on page 71.
2. Remove the four screw caps and six screws (four on the Bezel and two on the Hinge Covers).



Step	Size	Quantity	Screw Type
LCD Bezel (red callout)	M2.5*5	4	
LCD Bezel (green callout)	M2*4	2	

3. Starting from the top centre of the bezel, pry the bezel upwards and away from the panel. Move along the top edge and down each side until all sides of the bezel are removed.

**NOTE:** If necessary, use a pry to lift up the outside edges of the bezel.

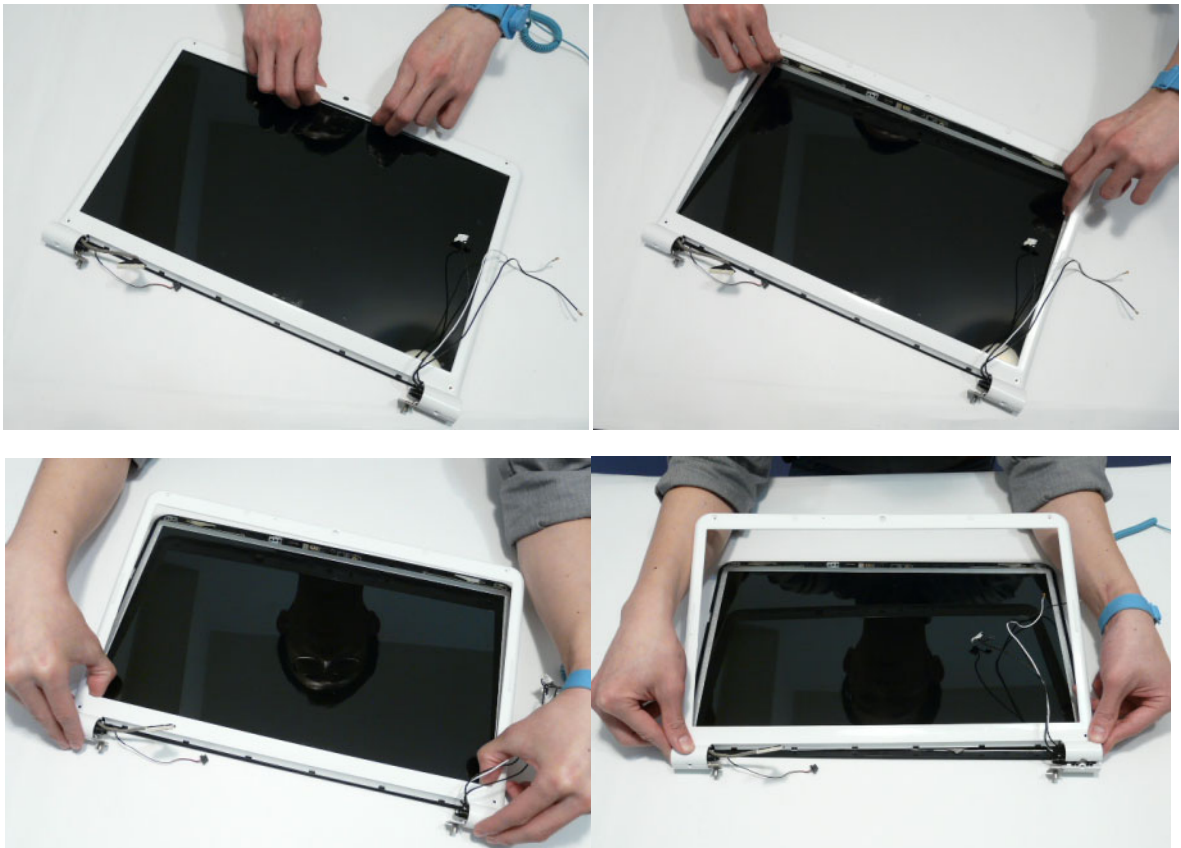

---

## Removing the Camera Module

1. See "Removing the LCD Bezel" on page 97.
2. Disconnect the camera cable.

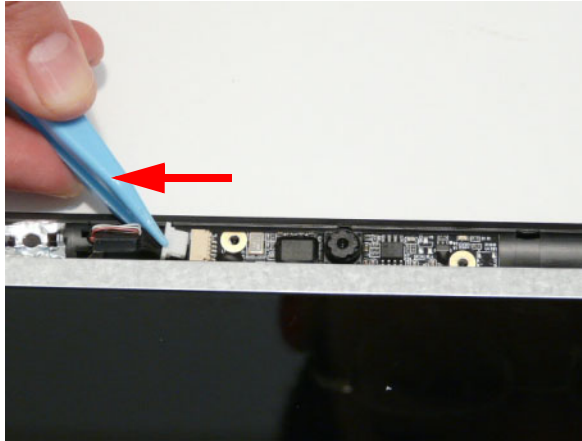

3. Remove the Camera from the module.

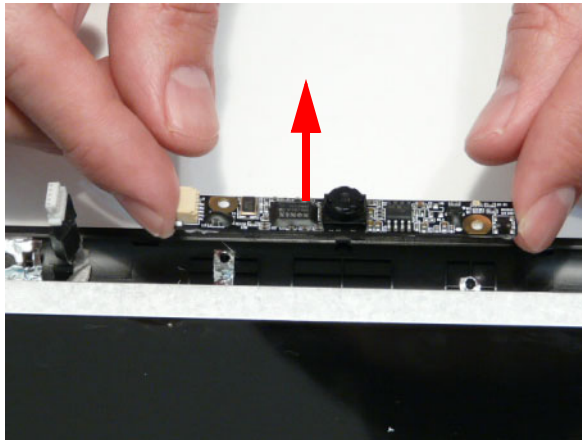

## Removing the LCD Panel

1. See "Removing the Camera Module" on page 98.
2. Remove the two securing screws from the LCD Panel.



Step	Size	Quantity	Screw Type
LCD Panel	M2.5*5	2	

3. Lift the LCD Panel out of the module, rear edge first, as shown.



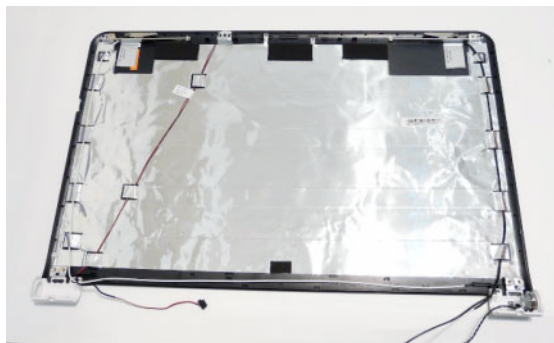

The LCD Module appears as follows when the LCD Panel is removed.

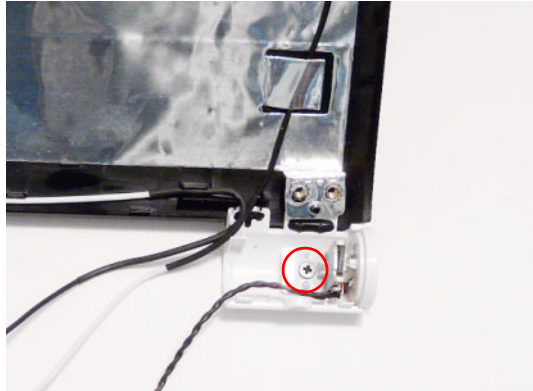

## Removing the Power Board

1. See "Removing the LCD Panel" on page 99.
2. Remove the single screw securing the Power Board Bracket to the LCD Module.



Step	Size	Quantity	Screw Type
Power Board	M2*3	1	

3. Lift the Power Board Bracket from the LCD Panel as shown.

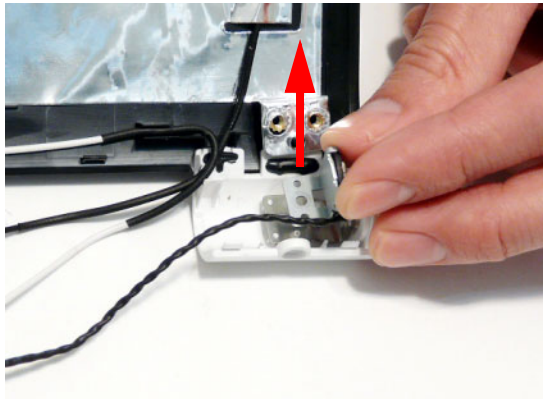

4. Remove the Power Board from the bracket as shown.

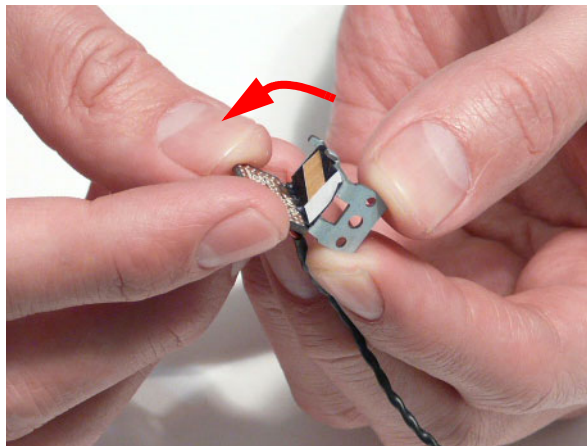

## Removing the LCD Brackets and FPC Cable

1. See "Removing the LCD Panel" on page 99.
2. Turn the LCD panel over to expose the rear. Lift the cable as shown to disengage the adhesive strip securing it in place.

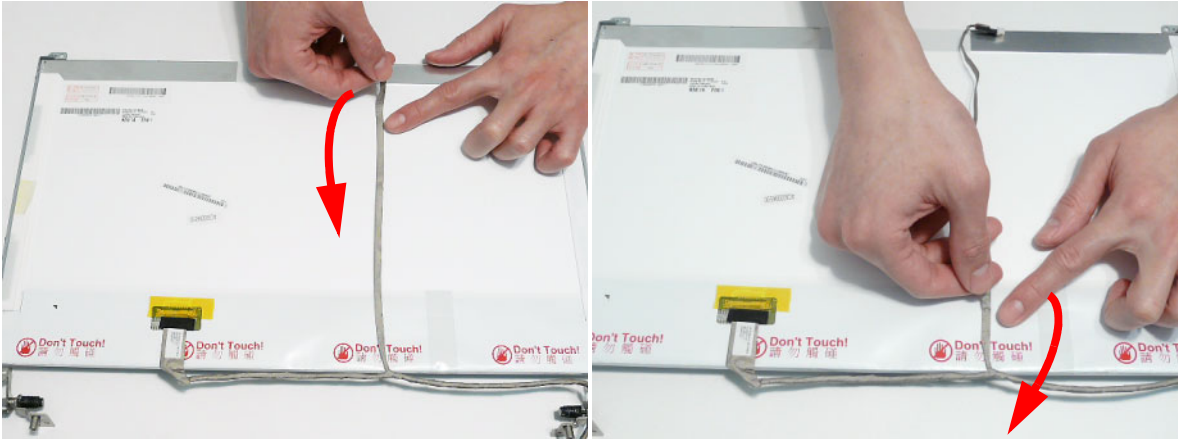

3. Remove the adhesive tape and lift the adhesive protector securing the cable to the LCD Panel.

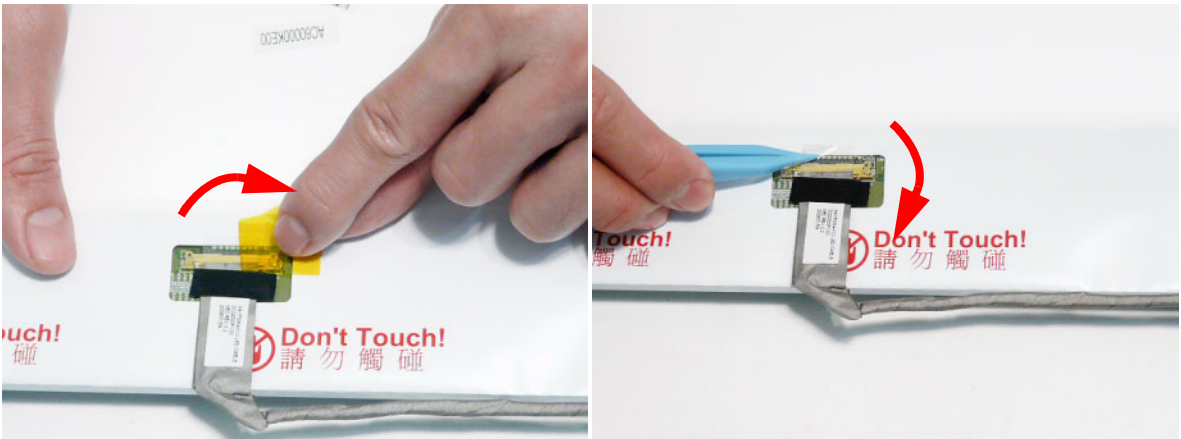

4. Disconnect the cable from the panel connector and lift the FPC cable from the panel.

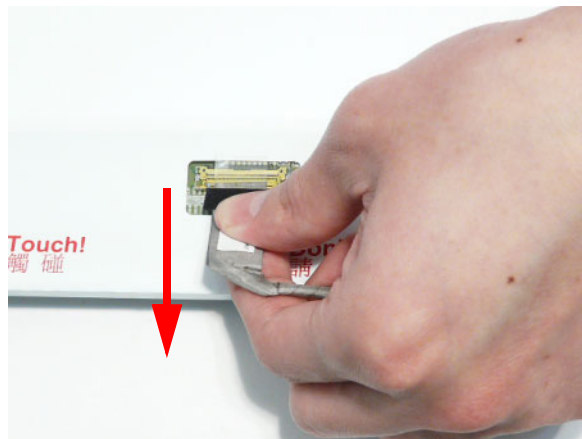

5. Remove the six securing screws (three on each side) from the LCD Panel brackets.

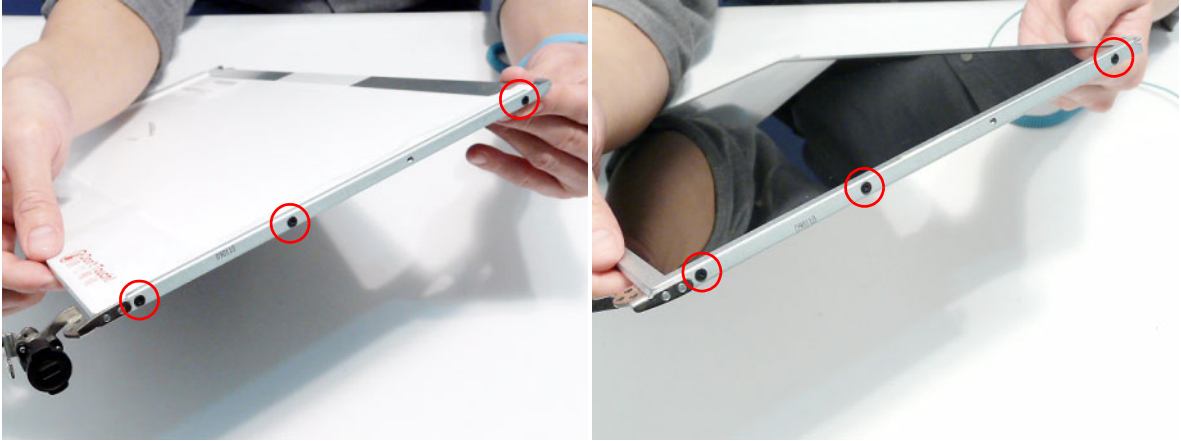

Step	Size	Quantity	Screw Type
LCD Brackets	M2*3	6	

6. Remove the LCD Brackets by pulling away from the LCD Panel.



---

## Removing the Microphone Module

1. See "Removing the LCD Panel" on page 99.
2. Remove the strips holding the microphone cable in place. Ensure the cable is free from obstructions.

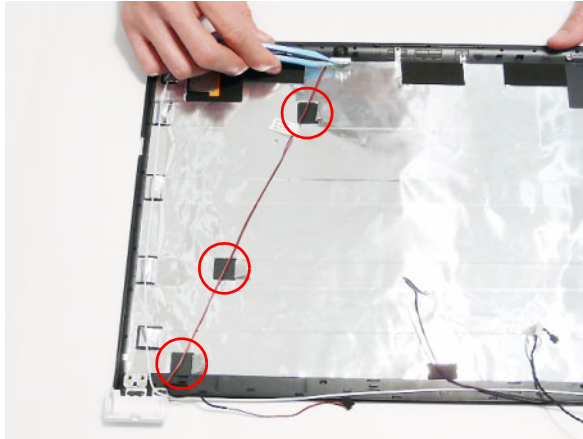

3. Lift the Microphone Module clear of the module.

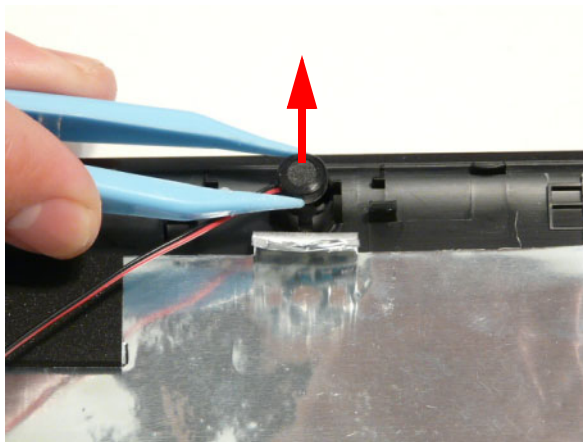

## Removing the Antennas

1. See "Removing the LCD Panel" on page 99.
2. Starting from the right hinge, remove the white Antenna cable from the cable channel running along the bottom edge of the LCD Module.

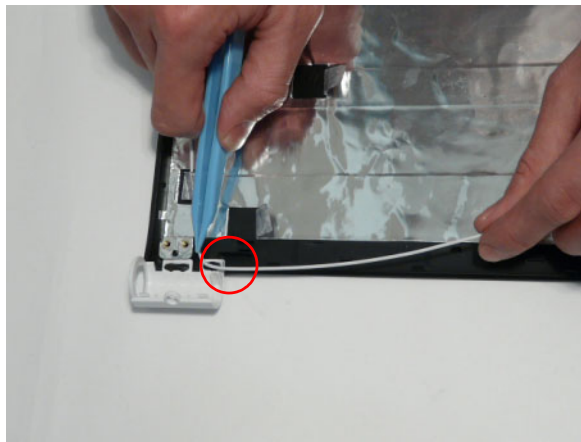
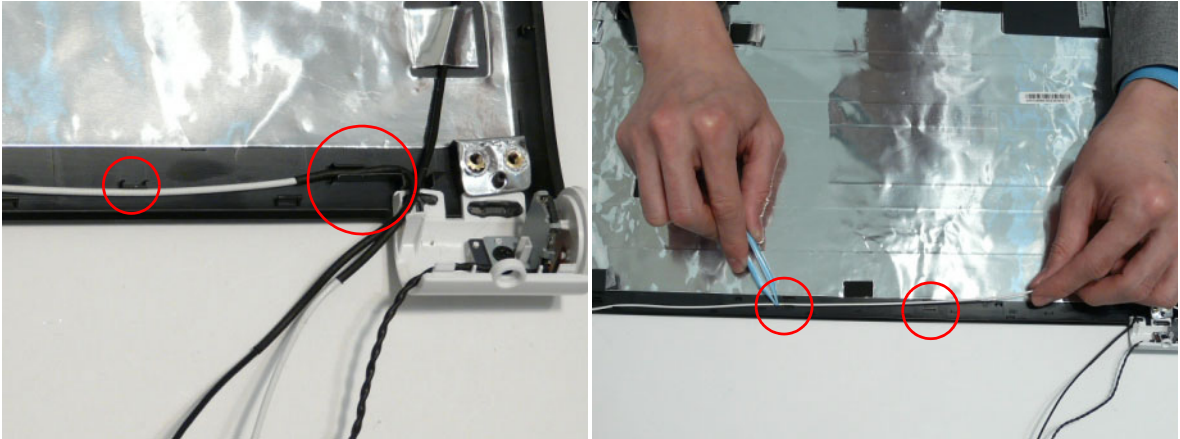

3. Remove the adhesive strips holding the left Antenna cable in place. Ensure the cable is free from obstructions.

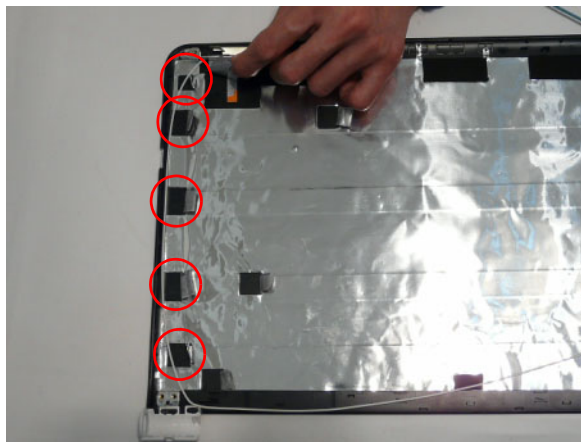

4. Remove the adhesive tape (green callout) and lift the left side Antenna from the LCD module as shown.

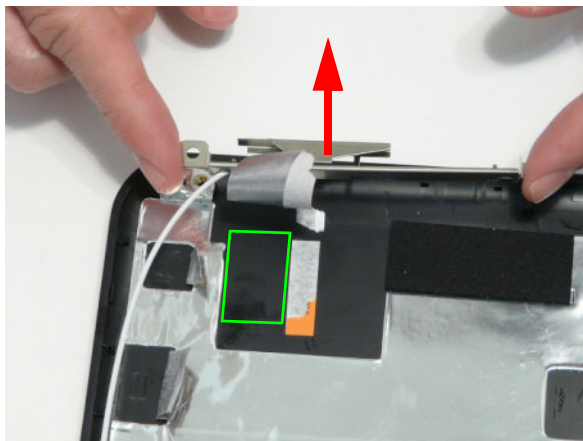

5. Remove the adhesive strips holding the right Antenna cable in place. Ensure the cable is free from obstructions.

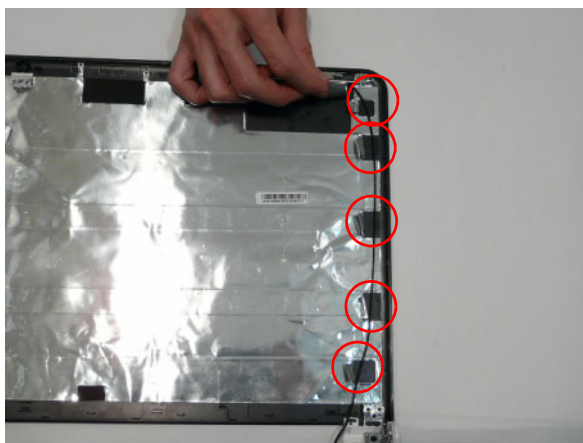

6. Remove the adhesive tape (green callout) and lift the right side Antenna from the LCD module as shown.

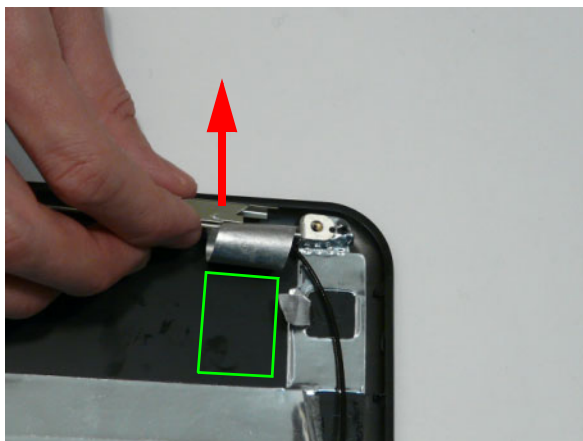

# LCD Module Reassembly Procedure

## Replacing the Antennas, Power Board, and MIC

1. Replace the left and right antennas as shown. Ensure that the locating pin on each antenna is correctly seated. Press down on the adhesive pads (green callout) to secure the antennas in place.

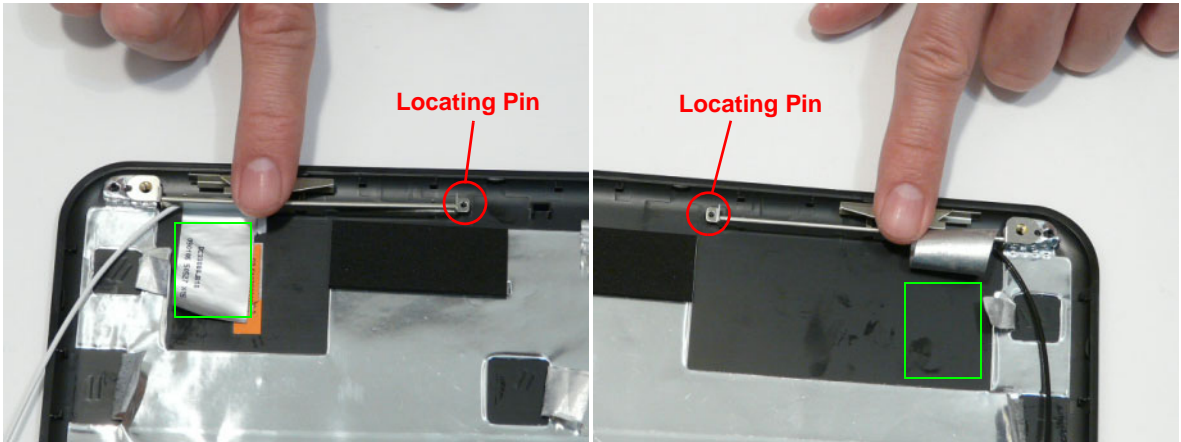

2. Replace the left antenna cable (white) as shown. Ensure that the cable is inserted along the cable channel and secured under each adhesive tab strip.

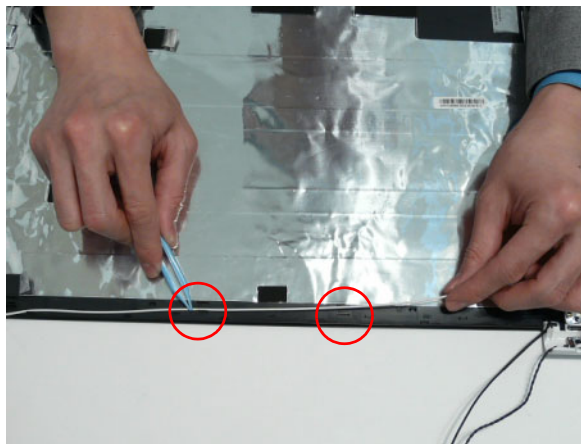
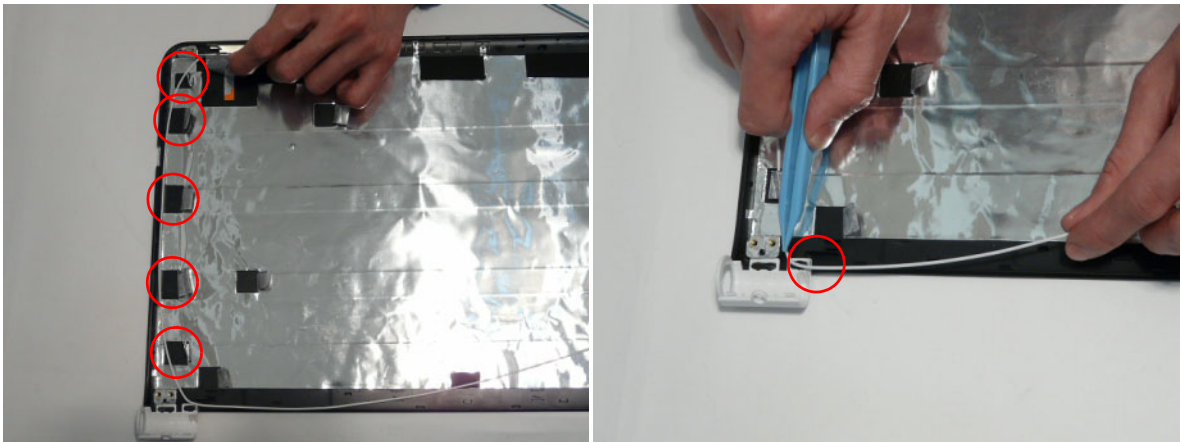

3. Replace the right antenna cable (black) as shown. Ensure that the cable is secured under each adhesive tab strip.
4. Place the Power Board in to the bracket as shown.

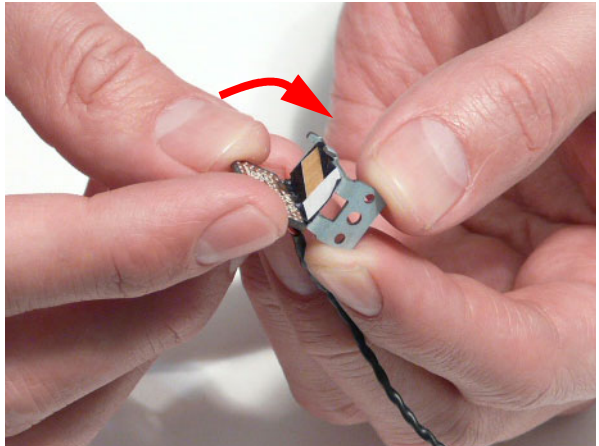
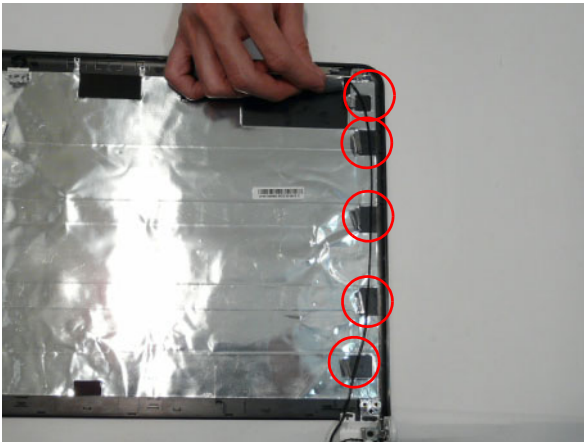

5. Place the Power Board Bracket in the LCD Module as shown.
6. Replace the single screw to secure the bracket in place.

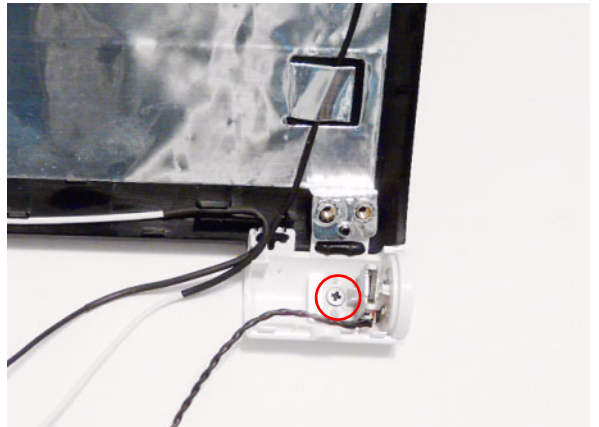
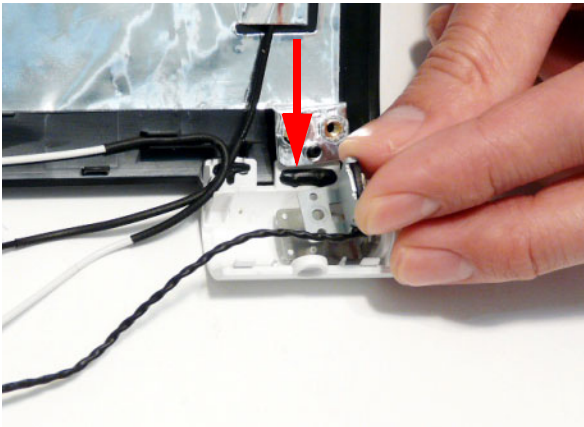

7. Place the Microphone Module in the LCD Module, as shown, and press down to secure it in place.
8. Run the cable as shown and secure it using the adhesive tabs.

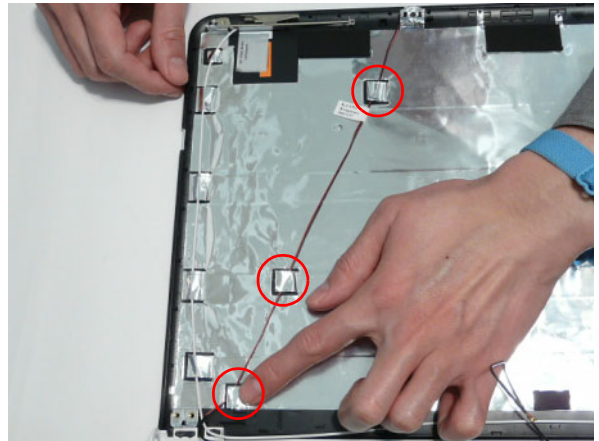
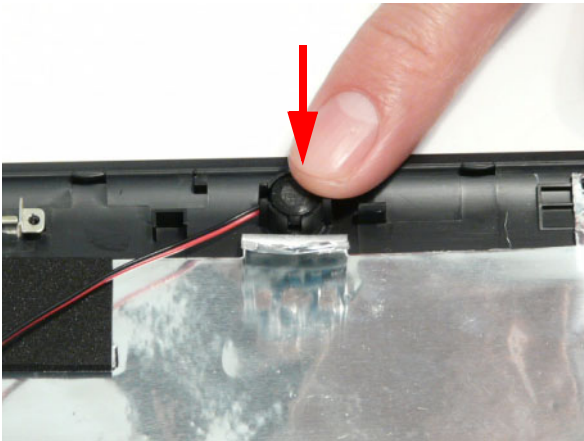

---

**NOTE:** The LCD Module appears as shown when the Antennas, Power Board, and MIC are replaced correctly.

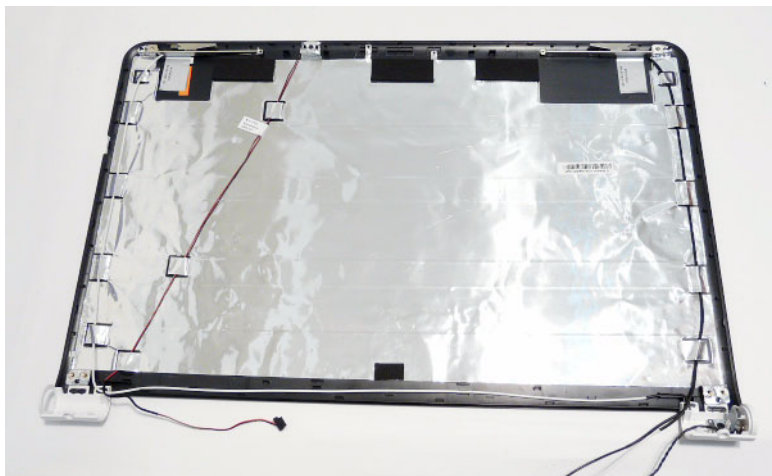

## Replacing the LCD Panel

1. Align the LCD brackets with the screw holes on the panel.
2. Starting with the top most screws (marked with  $\triangle$ ), replace the six screws in the brackets as shown.

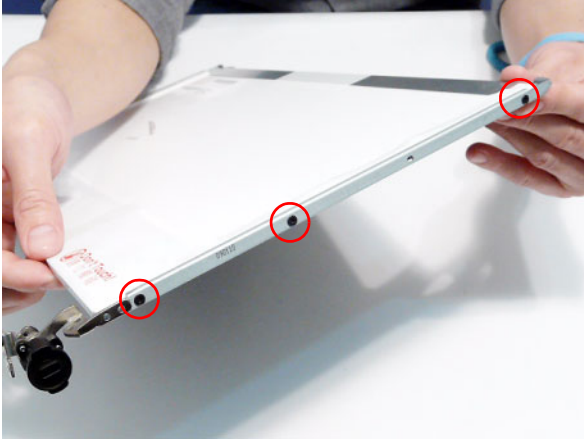

3. Insert the LCD Panel cable into the LCD Panel connector as shown.

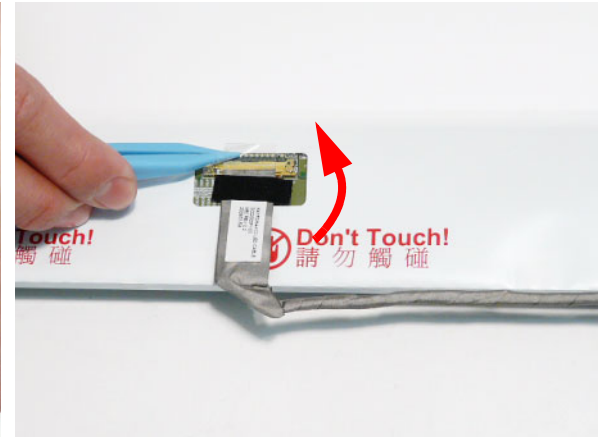
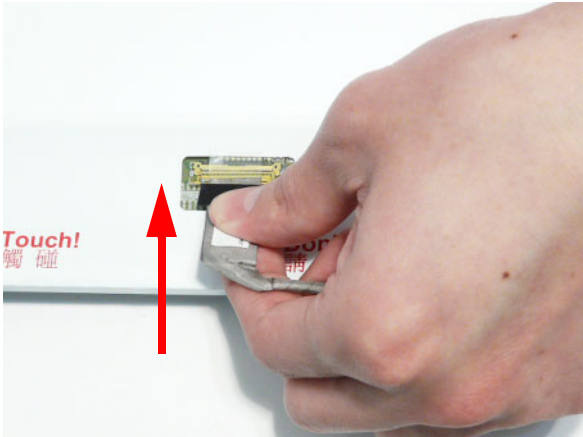

5. Replace the adhesive strip as shown.

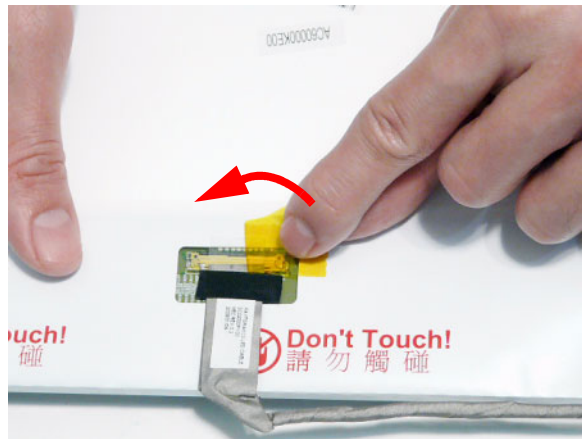

- 
6. Replace the LCD cable as shown and press down along the cable's length to secure the cable to the panel.

**IMPORTANT:** Ensure the cable is placed between the green callouts to avoid trapping when the panel is replaced.

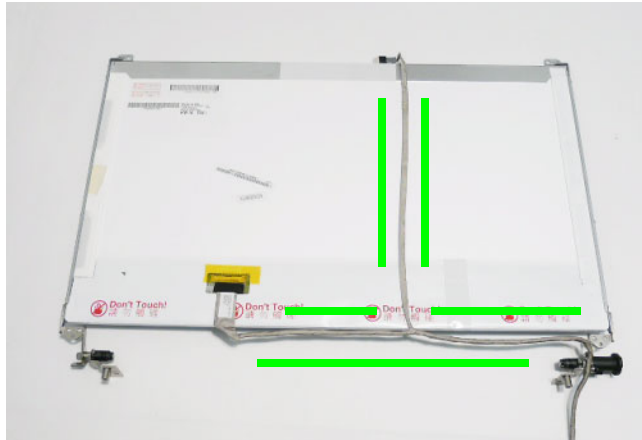

7. Place the LCD Panel in the back cover, bottom edge first, and lower it in to place as indicated.



**IMPORTANT:** Ensure that the LCD cables pass through the hinge wells and are not trapped under the panel.

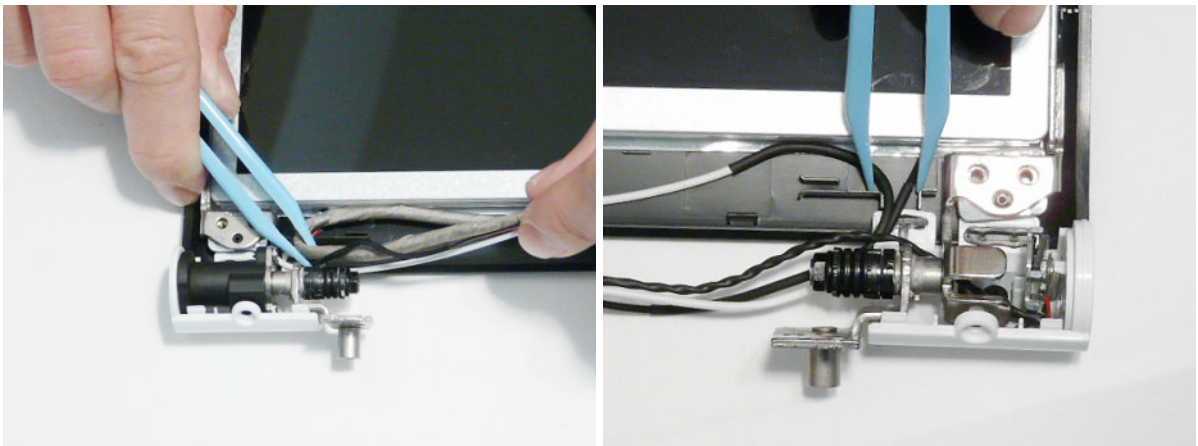



- 
8. Replace the two screws to secure the panel in the LCD Module.



## Replacing the Camera Module

1. Align the Camera Board with the locating pins and place the camera in the LCD Module.
2. Connect the cable to the Camera Board.

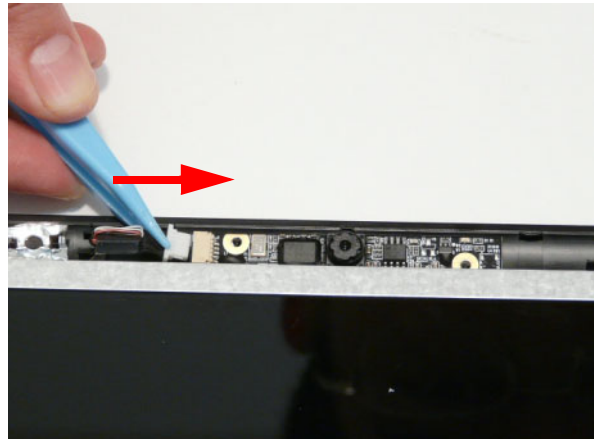
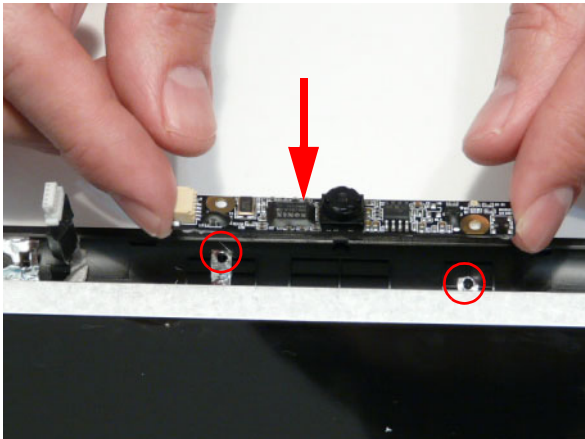

---

## Replacing the LCD Bezel

1. Locate the bezel bottom edge first and press down until there are no gaps between the bezel and the LCD Module.

**IMPORTANT:** Ensure that the LCD cables pass through the hinge wells and are not trapped by the bezel.

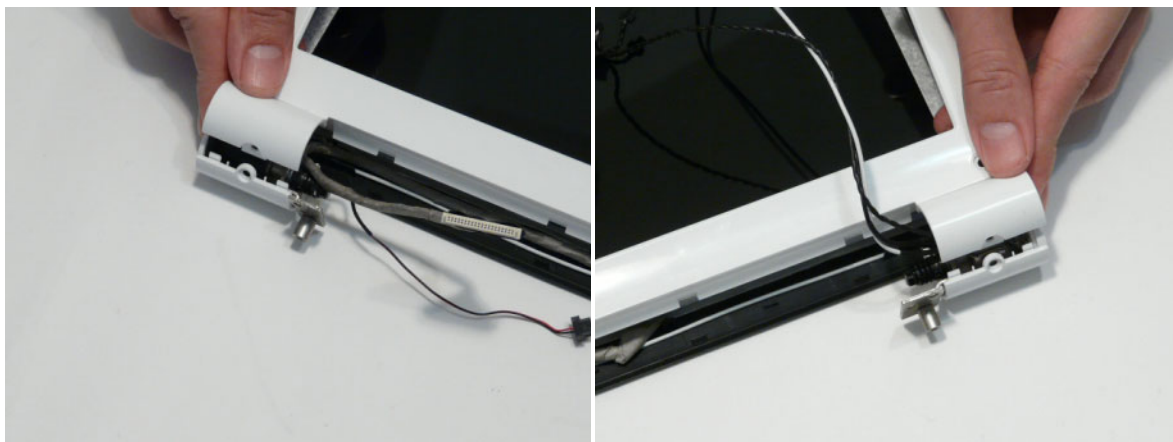

2. Press down around the entire perimeter of the bezel until there are no gaps between the bezel and the LCD Module.

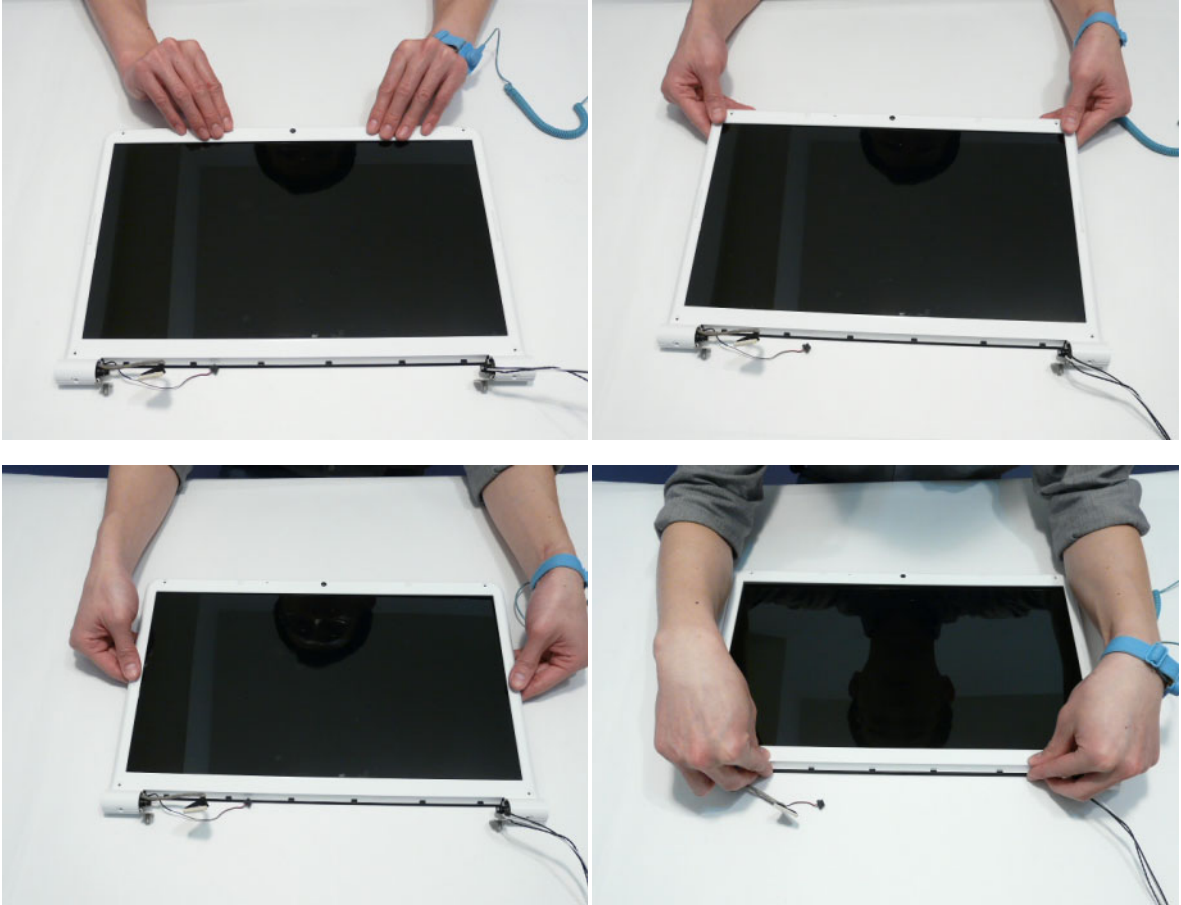

3. Replace the six screws as indicated.

**NOTE:** The Bezel securing screws differ in size: Red callout—M2.5\*5, Green callout—M2\*4.



# Main Module Reassembly Procedure

## Replacing the CPU

**IMPORTANT:** The CPU has a Pin1 locator that must be positioned corresponding to the marker on the CPU socket.

1. Place the CPU into the CPU socket as shown, taking note of the Pin1 locator.

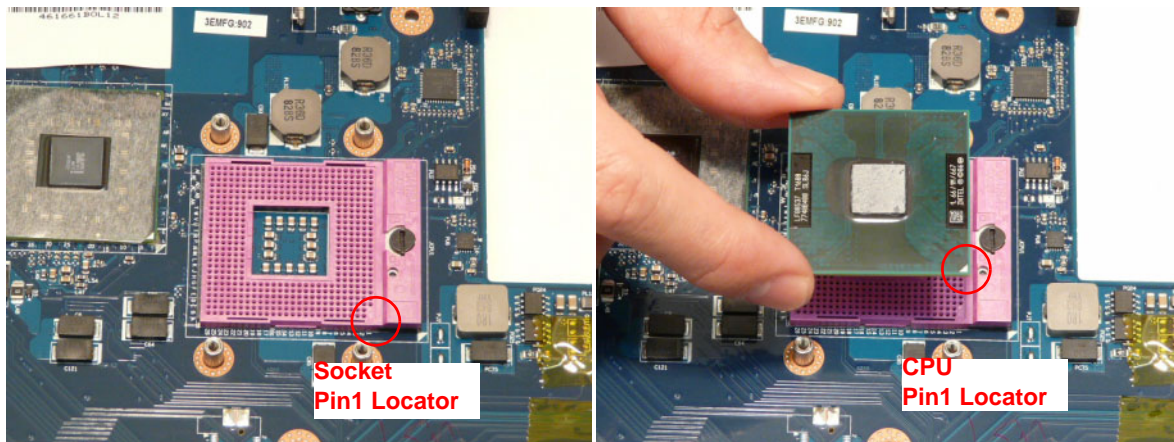

2. Using a flat-bladed screw driver, rotate the CPU locking screw 180° clockwise to secure the CPU in place.

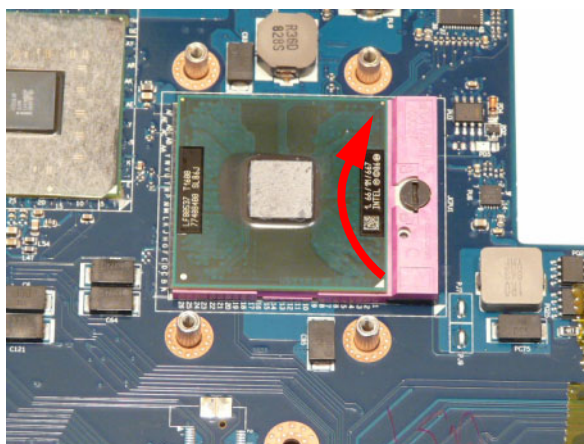

## Replacing the Thermal Module

**IMPORTANT:** Apply a suitable thermal grease and ensure all heat pads are in place before replacing the Thermal Module.

The following thermal grease types are approved for use:

- Silmore GP50
- Honeywell PCM45F-SP
- ShinEtsu 7762

The following thermal pads are approved for use:

Eapus XR-PE

1. Remove all traces of thermal grease from the CPU using a lint-free cloth or cotton swab and Isopropyl Alcohol, Acetone, or other approved cleaning agent.
2. Apply a small amount of thermal grease to the centre of the CPU—there is no need to spread the grease manually, the force used during the installation of the Thermal Module is sufficient.

- Align the four screw holes on the Thermal Module and Mainboard and lower the module into place. Keep the module as level as possible to spread the thermal grease evenly.
- Secure the four screws (in numerical order from screw 1 to screw 4) in the Thermal Module as shown.

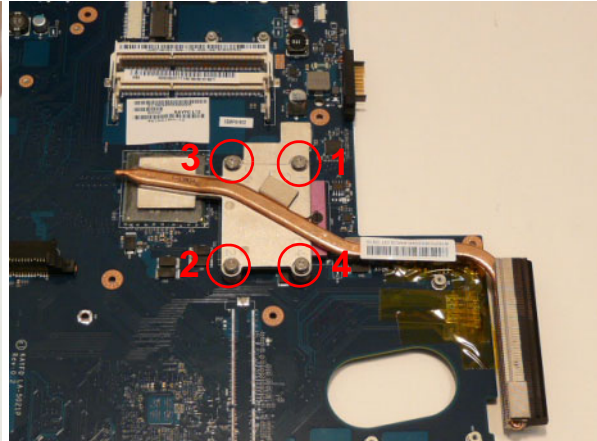
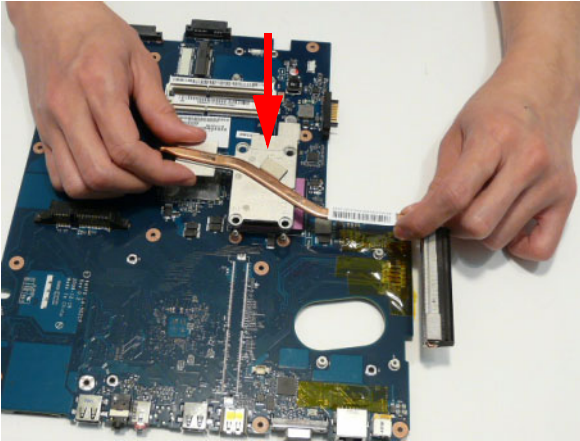

## Replacing the CPU Fan

- Align the three screw holes on the CPU Fan and Mainboard and lower the module into place.
- Secure the three screws in the CPU Fan as shown.

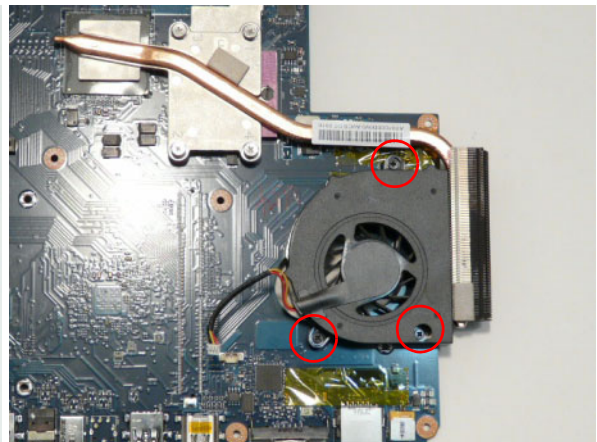
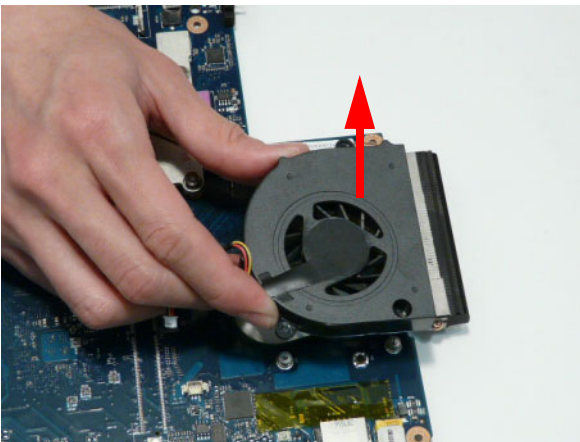

- Connect the CPU Fan power cable to the Mainboard connector as shown.

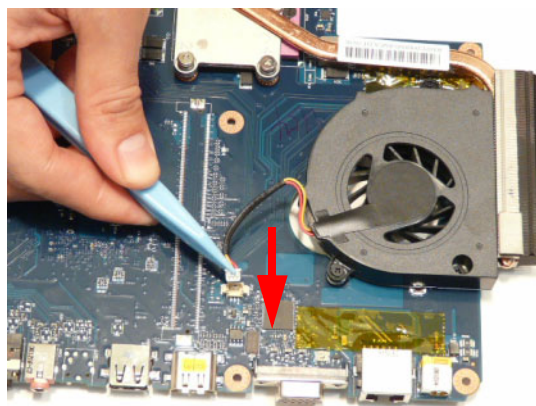

## Replacing the RJ-11 Jack

1. Place the RJ-11 Jack in the Lower Cover as shown.

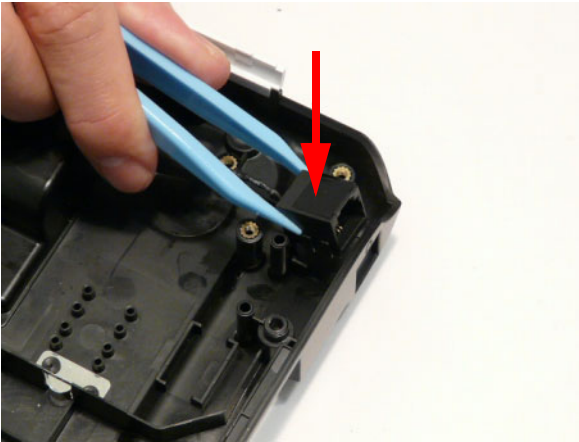

2. Replace the cable bundle and press down to secure the adhesive in place

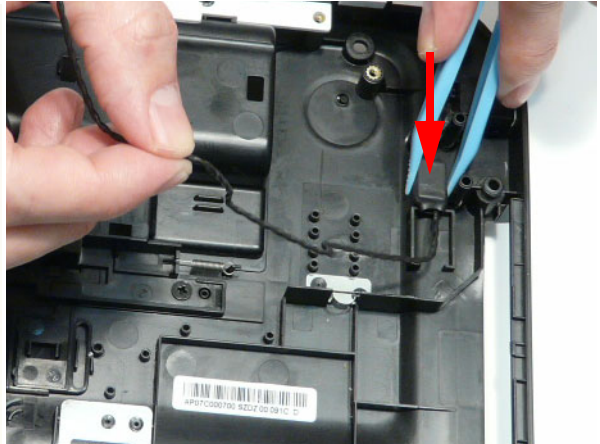

3. Run the cable along the Lower Cover as shown, using all available cable clips.

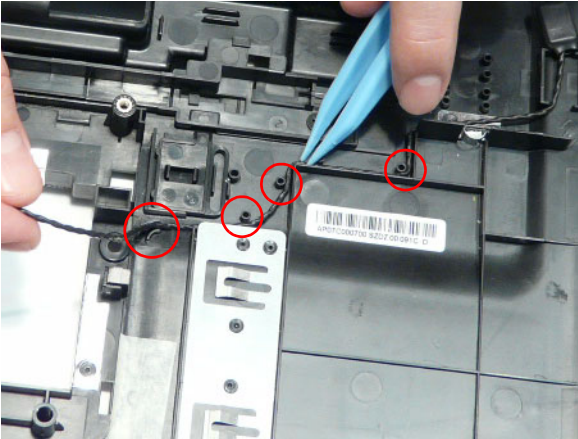

4. Secure the cable in place with an adhesive strip.

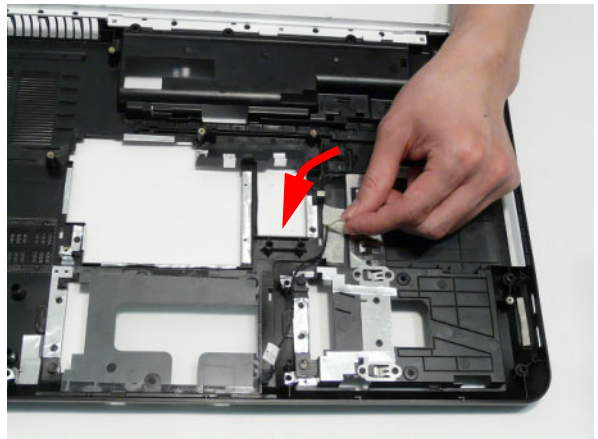

## Replacing the Mainboard

1. Ensure that the Mainboard is face up (the CPU is not visible). Place the Mainboard in the chassis, left side first (1), then rotate it downward into position (2).
2. Ensure that the RJ-11 (Modem) cable is accessible when the Mainboard is replaced as shown.

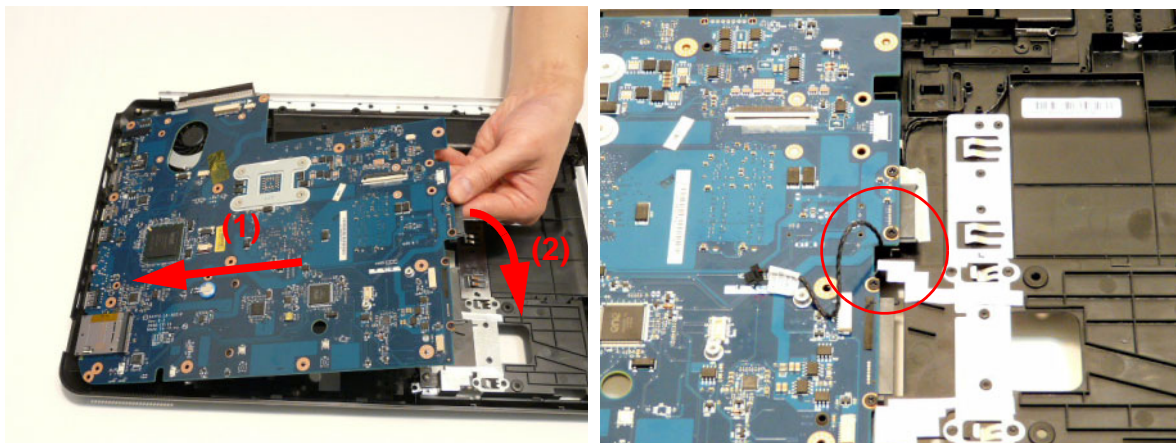

3. Replace the single securing screw in the mainboard.

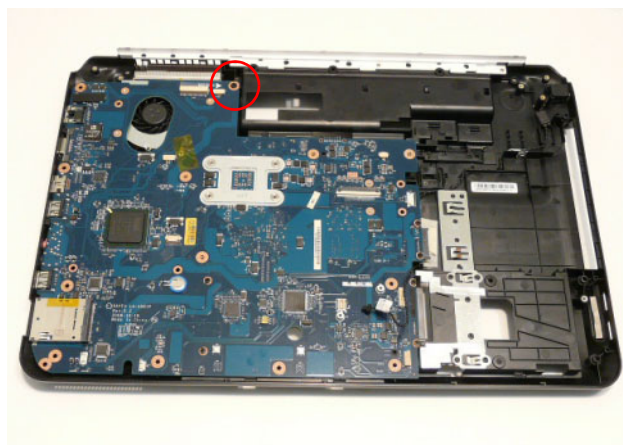

## Replacing the USB Board

1. Reconnect the USB Board cable to the USB Board.
2. Align the locating holes and pins on the Lower Cover and replace the USB Board.

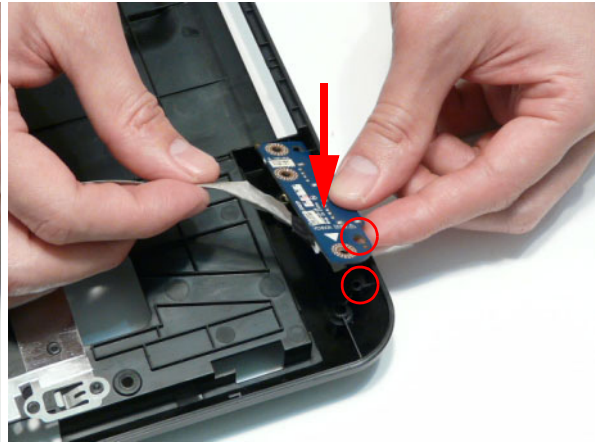
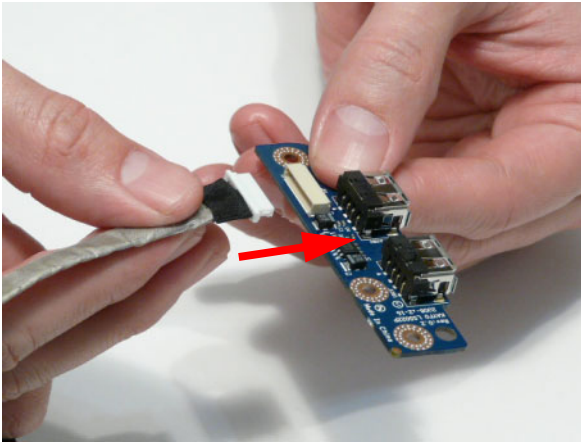

3. Replace the single screw securing the board to the Lower Cover.
4. Replace the cable in the cable channel as shown and press down to secure it in place.

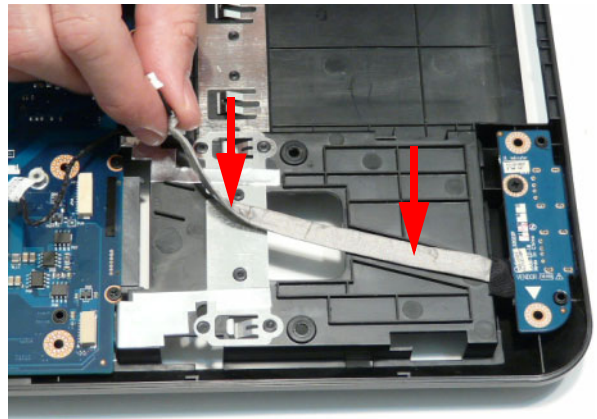
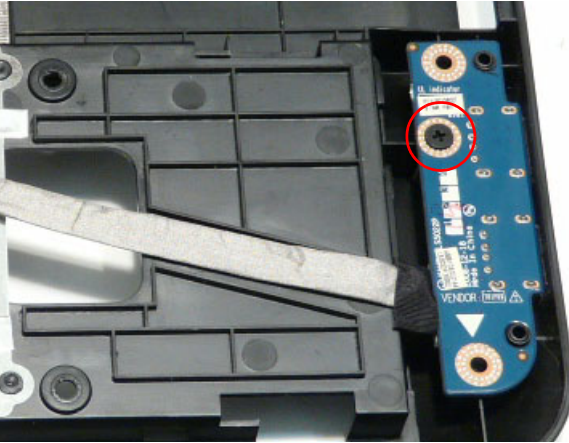

5. Reconnect the USB cable to the USB Board.

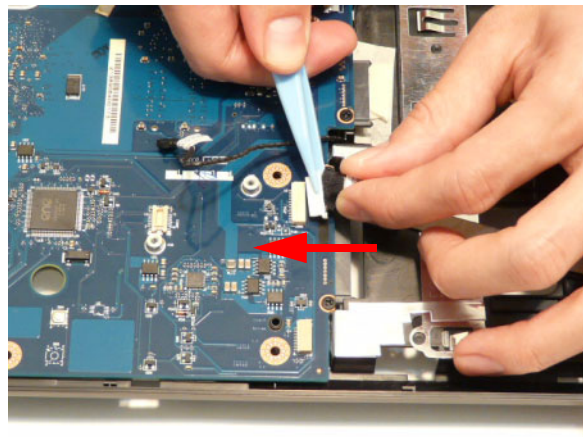



## Replacing the Modem Board

1. Reconnect the RJ-11 cable to the Modem Board.
2. Align the screw holes on the Modem and Lower Cover and replace the board.

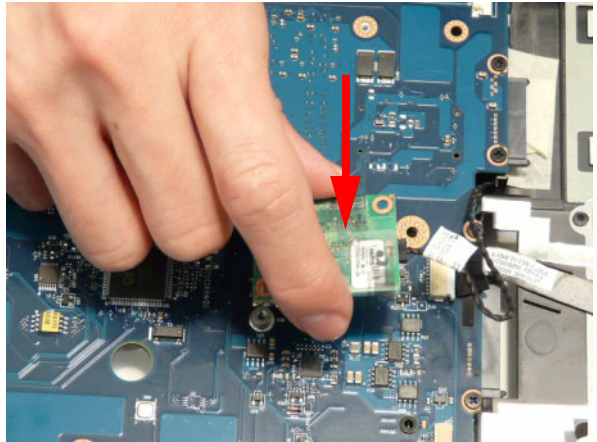
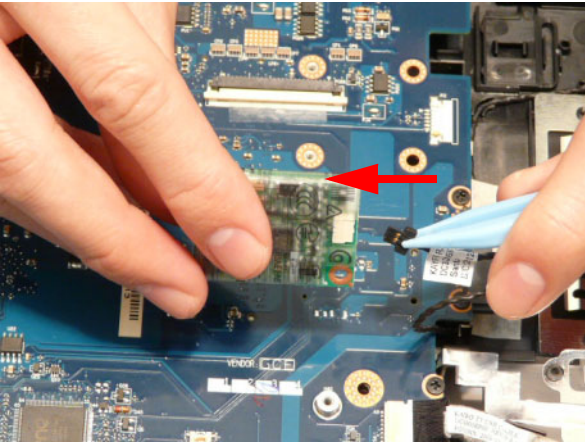

3. Secure the cable in place with adhesive tape.
4. Press down as indicated to connect the board-to-board interface.

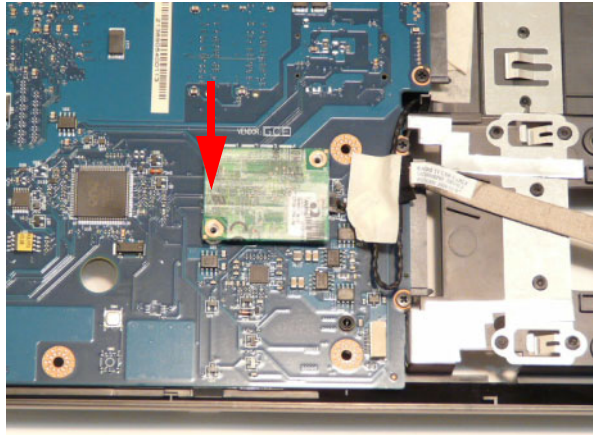
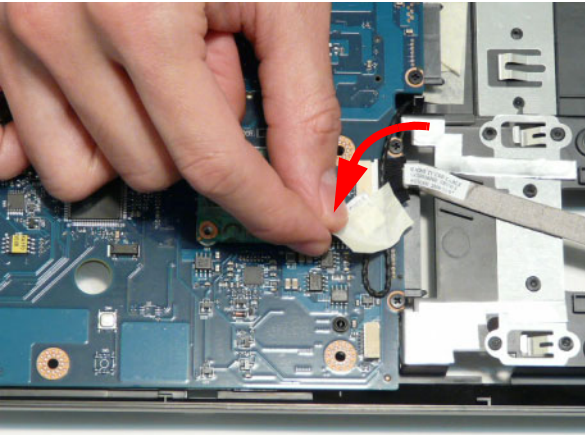

5. Secure the Modem Board to the Mainboard with two screws.

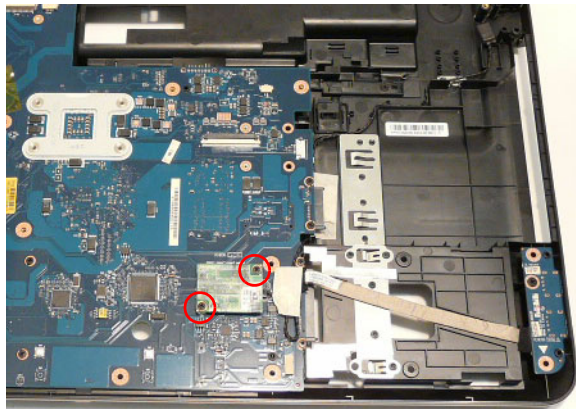

## Replacing the Speaker Module

1. Place the left Speaker Module in the chassis as shown, ensuring that the locating pins are seated correctly.
2. Lift the mylar sheet away from the Upper Cover and run the Speaker cable along the Upper Cover using all available cable clips.

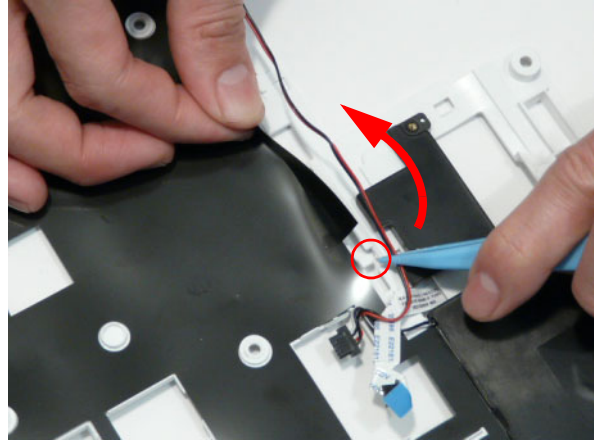
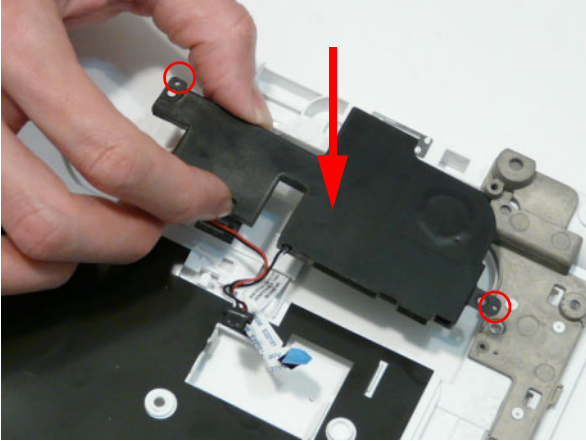

3. Continue running the cable along the Upper Cover using all available cable clips.
4. Place the right Speaker Module in the chassis as shown, ensuring that the locating pins are seated correctly.

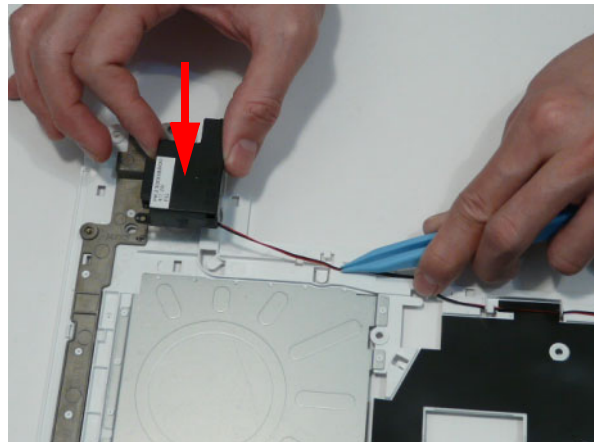
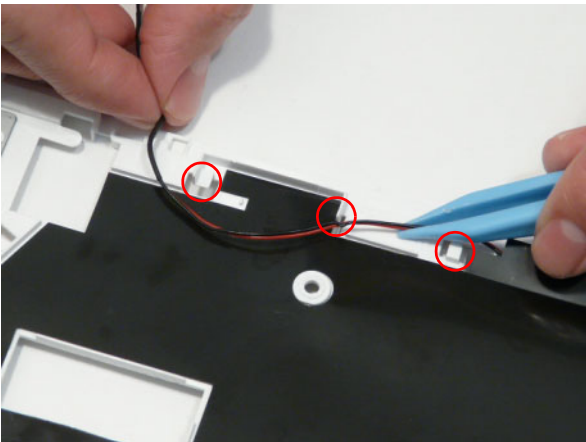

5. Replace the four securing screws.

**NOTE:** Ensure that the Speaker cable runs as shown in the image below to avoid trapping when the Upper Cover is replaced.

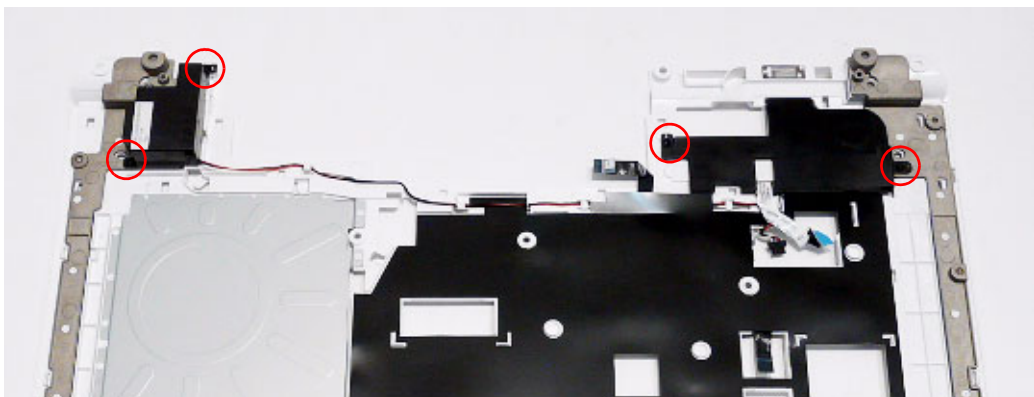

## Replacing the LED Board

1. Pass the LED Board FFC through the Upper Cover as shown.
2. Place the LED Board in the Upper Cover and press down as indicated to secure the board in place.

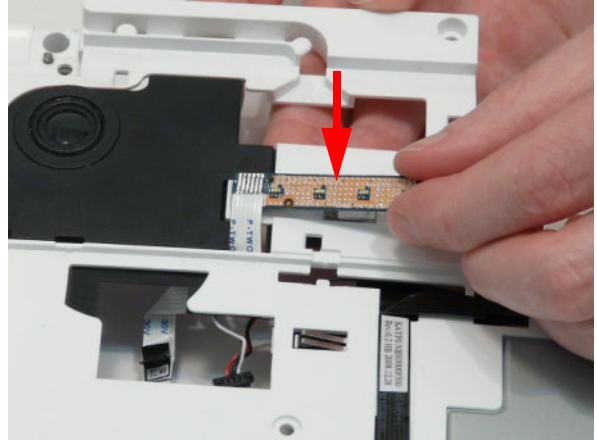
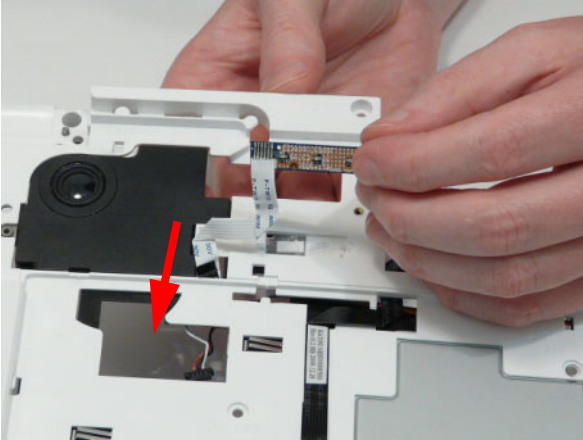

## Replacing the Media Board FFC

1. Place the Media Board FFC on the Upper Cover as shown, and press down to secure the adhesive in place.
2. Pass the upper end of the cable through the Upper Cover as shown.

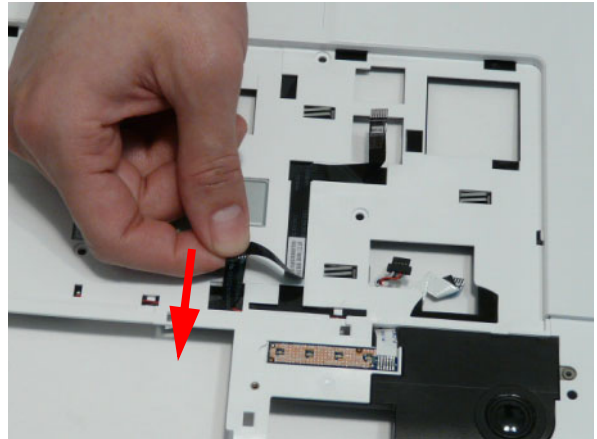
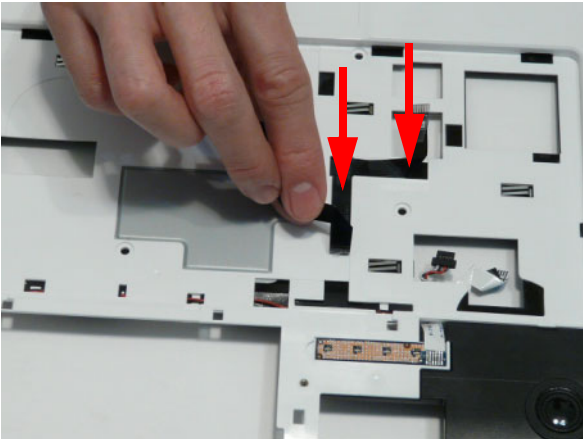

## Replacing the TouchPad Bracket

1. Replace the TouchPad Bracket bottom edge first to engage the securing clips (1). Rotate the bracket on to the Upper Cover and press down as indicated (2).
2. Secure the bracket to the Upper Cover with a single screw.

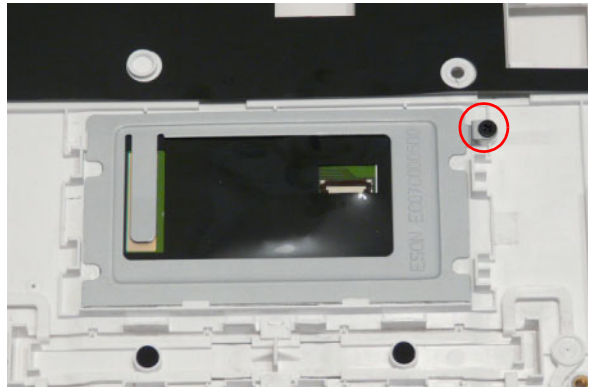
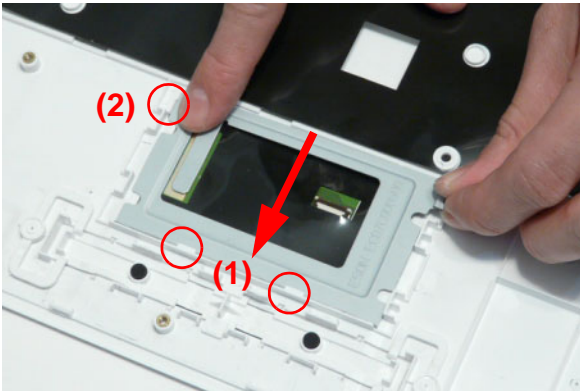

3. Insert the TouchPad FFC in to the connector as shown.
4. Close the FFC locking latch to secure the cable in place.

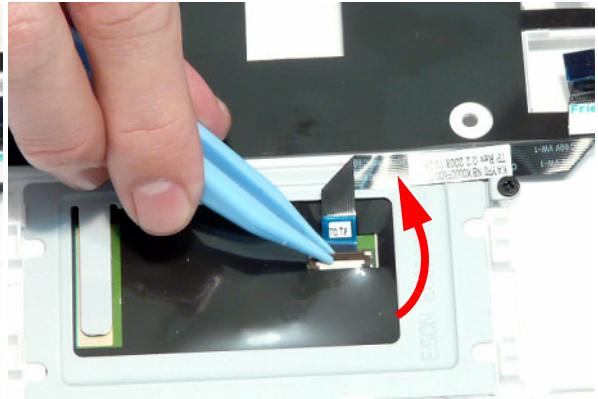
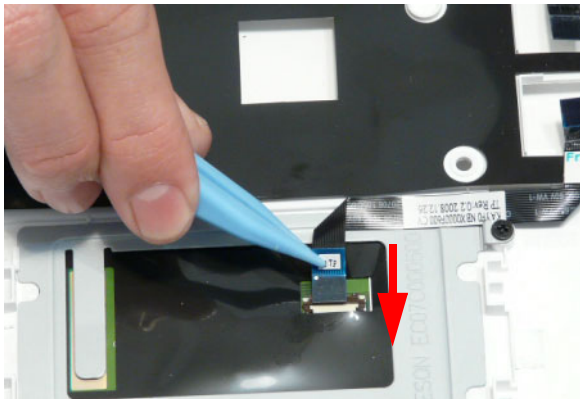

## Replacing the Upper Cover

1. Place the upper cover on the lower cover front edge first and lower the cover into position.

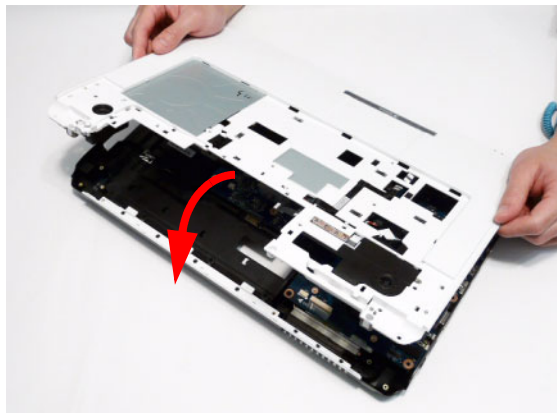

2. Press down around the front and sides to secure the Upper Cover in place.  
**NOTE:** Ensure that there are no gaps between the Upper and Lower Covers.

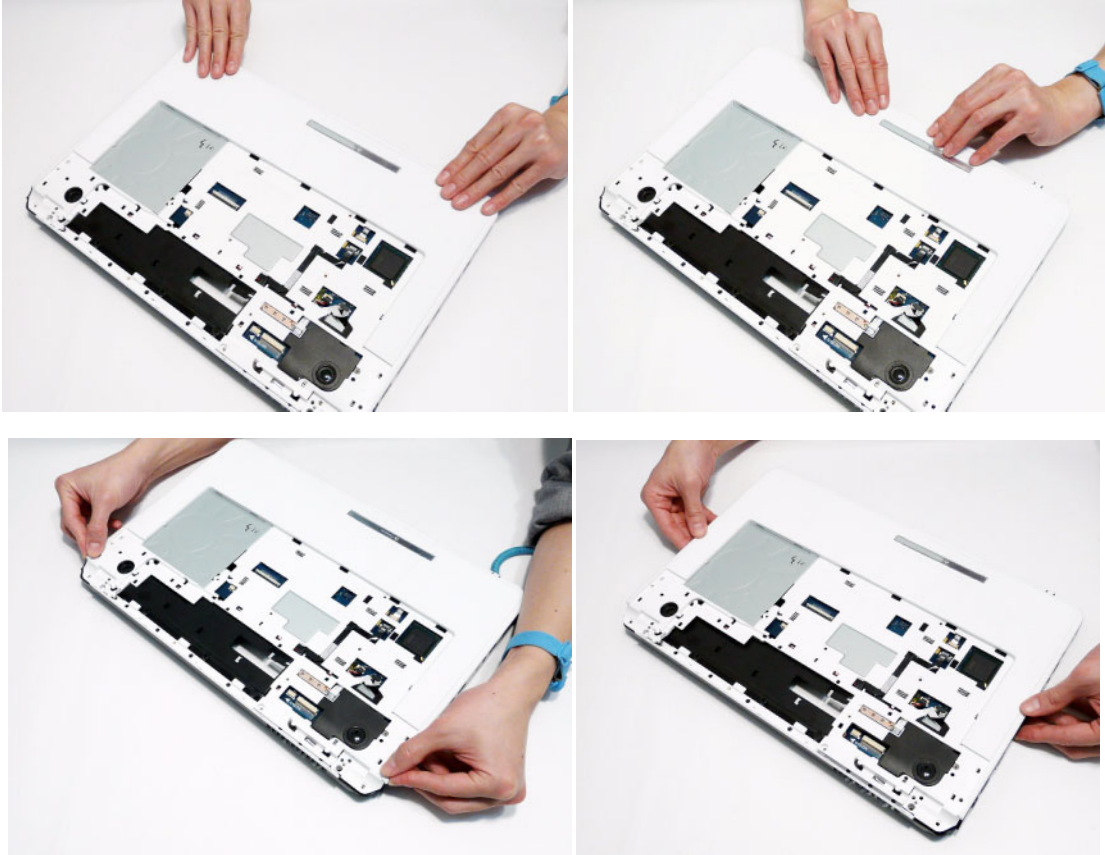

3. Reconnect the following cables as shown.

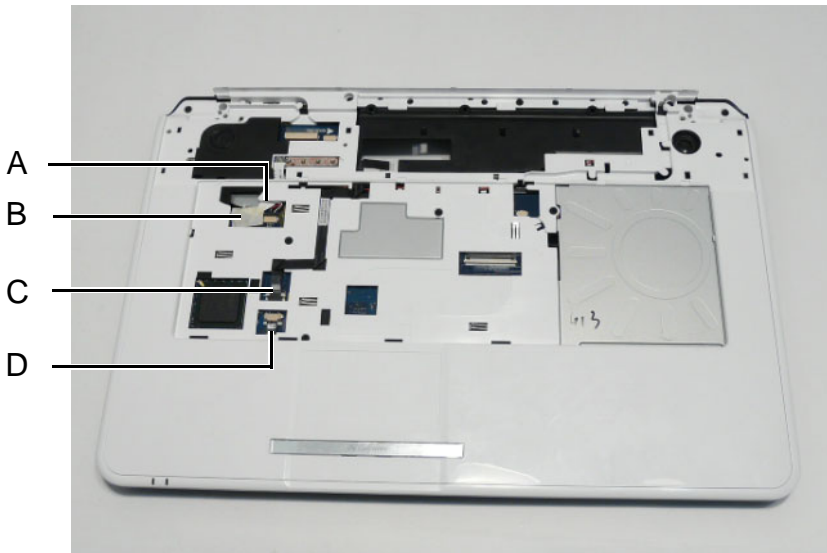

4. Connect A as shown.

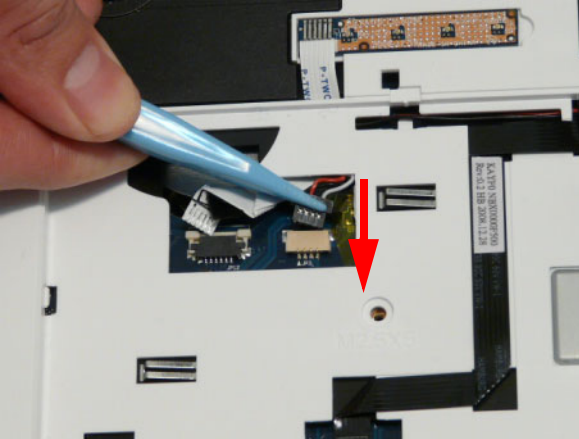

5. Insert B as shown and close the locking latch.

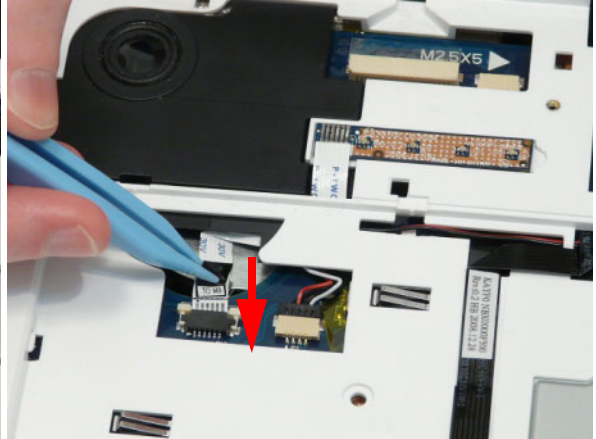

6. Insert C as shown and close the locking latch.

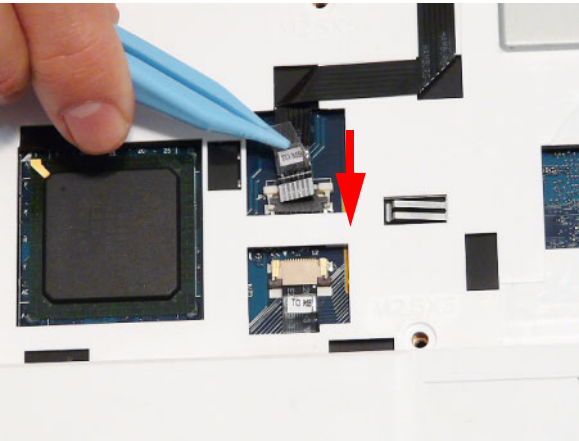

7. Insert D as shown and close the locking latch.

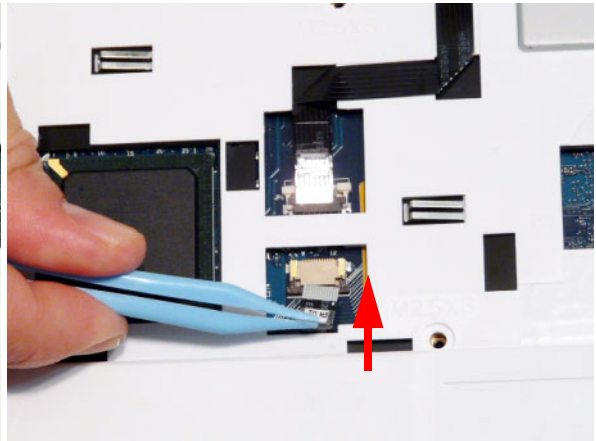

8. Secure cables A and B in place using adhesive tape.

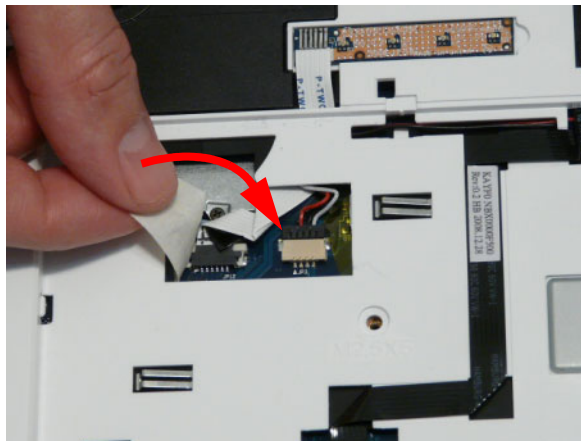

9. Replace the nine screws in the upper cover as shown.

**NOTE:** The securing screws differ in size: Red callout—M2.5\*5, Blue callout—M2.5\*3.

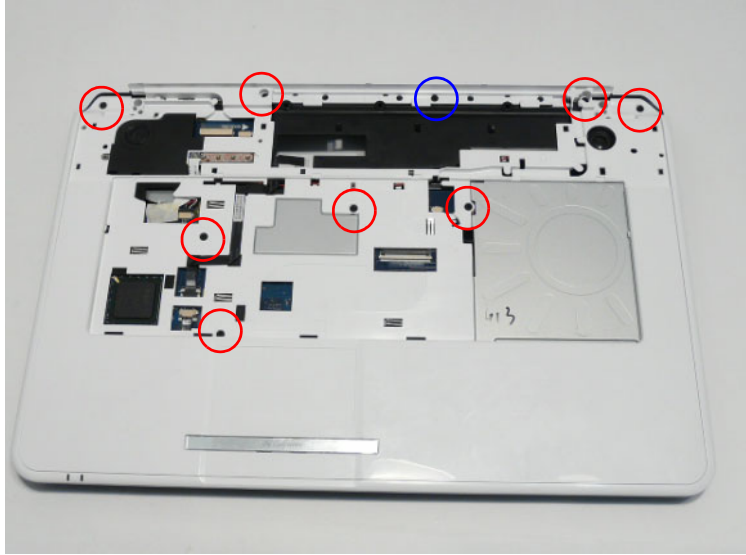

10. Turn the computer over and replace the thirteen screws as shown.

**NOTE:** The securing screws differ in size: Red callout—M2.5\*8, Green callout—M2.5\*5, Blue callout—M2.5\*3.

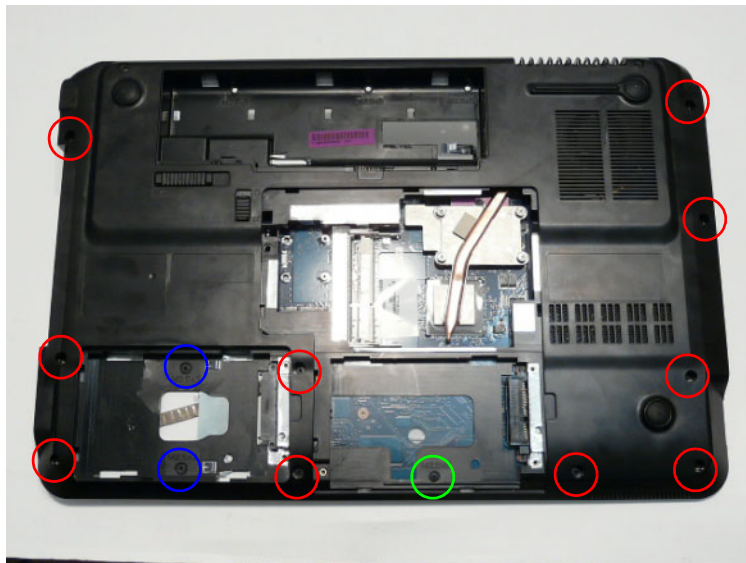

## Replacing the LCD Module

1. Turn the computer over. Align the LCD hinges with the lower cover and replace the LCD module.

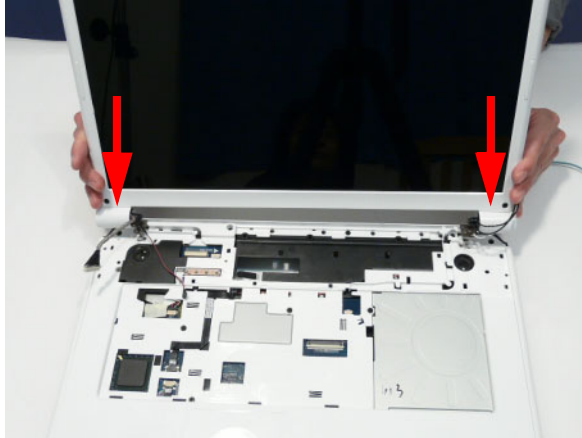

2. Replace the four securing screws (two each side), starting with the left side hinge. Ensure that the LCD cables are not trapped in the hinges.

**NOTE:** The securing screws differ in size: Red callout—M2.5\*8, Green callout—M2.5\*5.

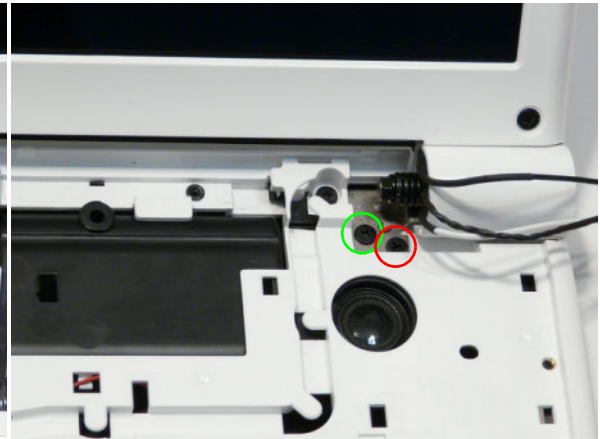
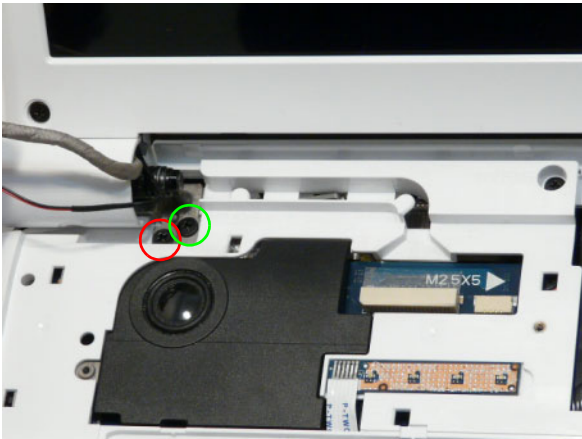

3. Run the MIC cable along the cable channel as shown, using all the available cable clips.

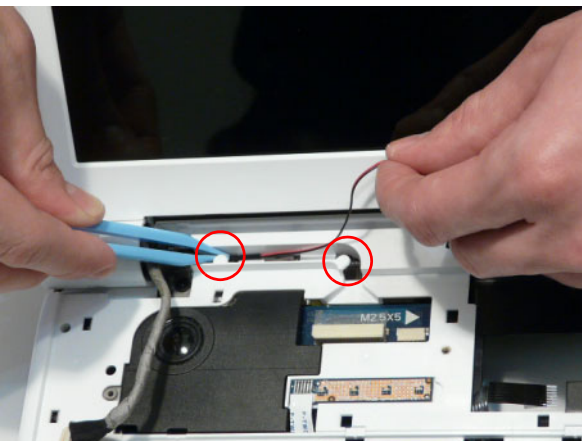

4. Reconnect the MIC cable to the Mainboard as shown.

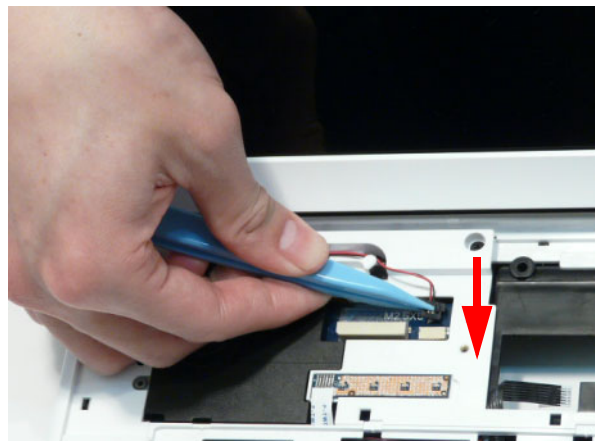



5. Run the LVDS cable along the cable channel as shown, using all the available cable clips.

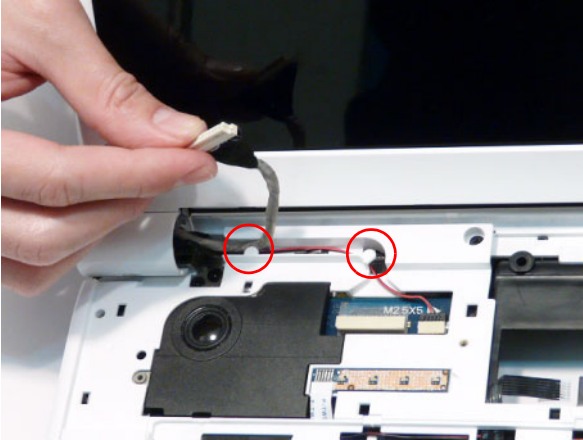

6. Reconnect the LVDS cable to the Mainboard as shown.

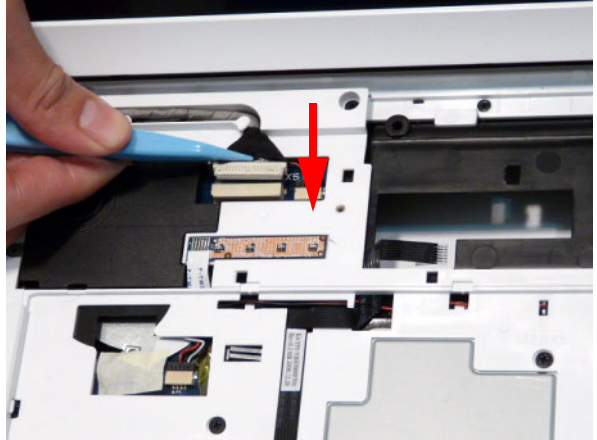

7. Run the Power Board cable along the cable channel using all available cable clips.

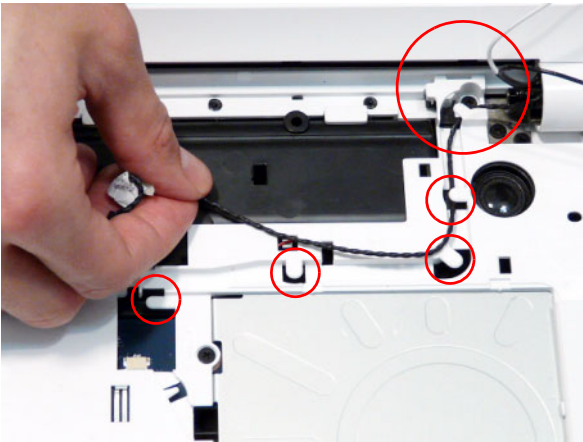

8. Connect the Power Board cable to the Mainboard as shown.

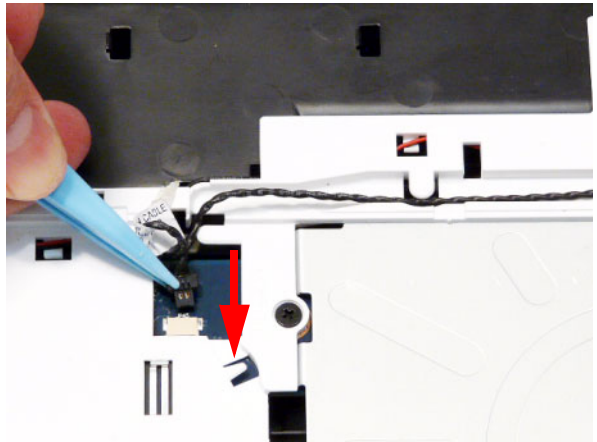

9. Run the Antenna cables along the cable channel using all available cable clips.

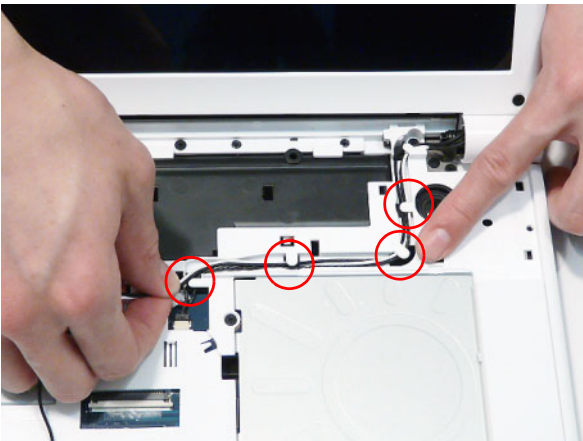

10. Insert the Antenna cables through the chassis as shown.

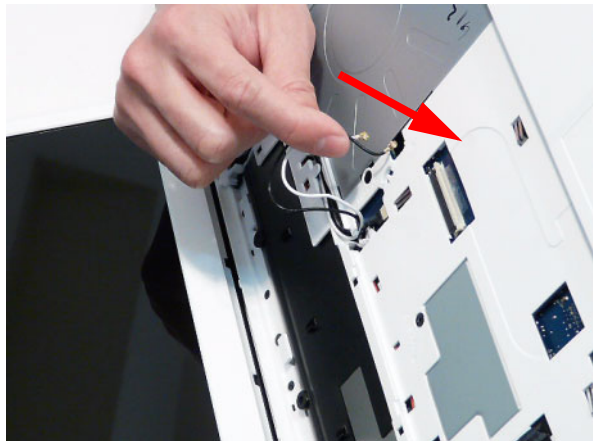

11. Pull the Antennas completely through from the under side of the computer.



12. Secure the cables in place with adhesive tape.

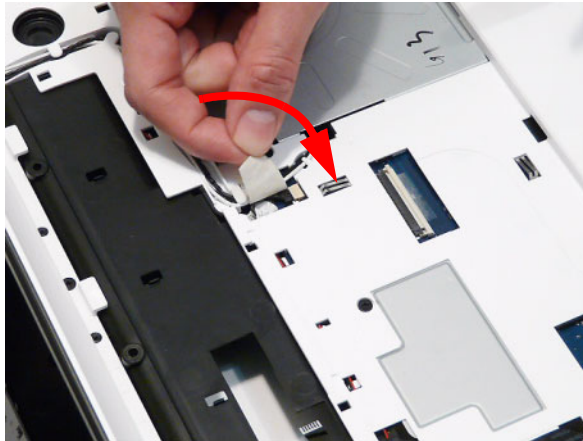

13. Replace the two securing screws.

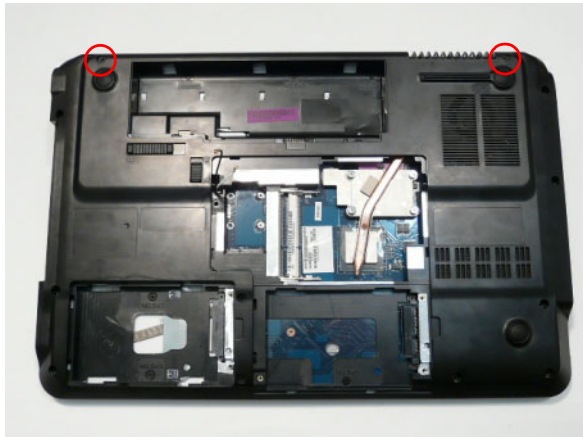

## Replacing the Keyboard

1. Place the Keyboard face down on the TouchPad area. Reconnect the FFC as shown.
2. Close the FFC locking latch to secure the cable in place.

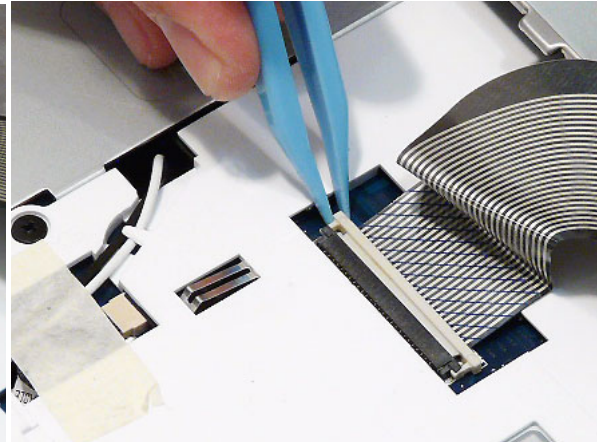
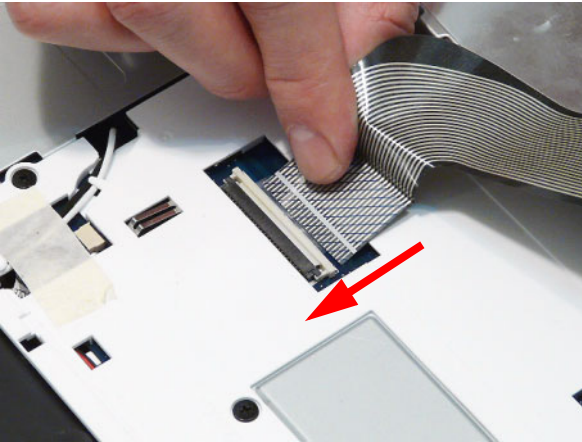

3. Turn the keyboard over and insert it front edge first into the chassis.
4. Press down as indicated to seat the Keyboard.

**NOTE:** Ensure that the six locating tabs are correctly seated.

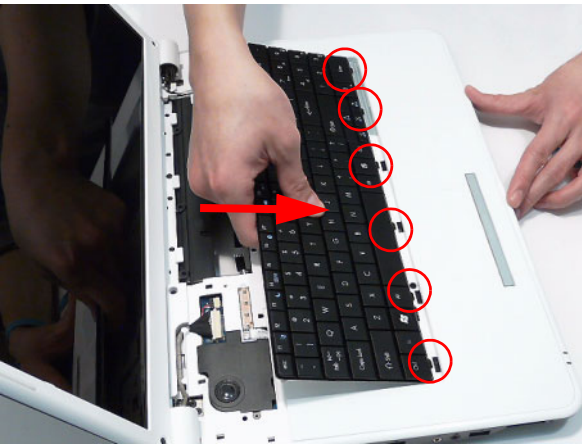

---

## Replacing the Media Board

1. Align the Media Board with the transparent pane on the Switch Cover.
2. Press the Media Board down to secure it in place with adhesive.

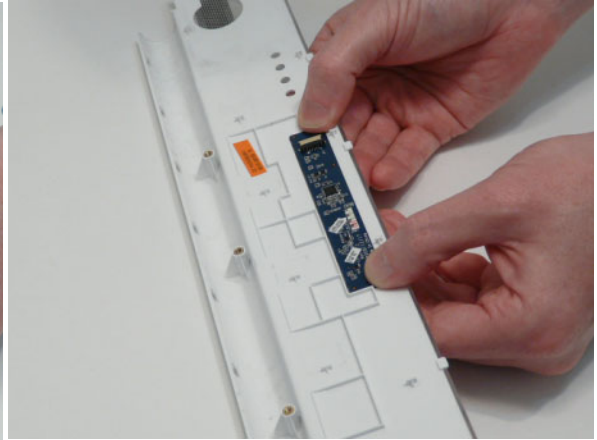
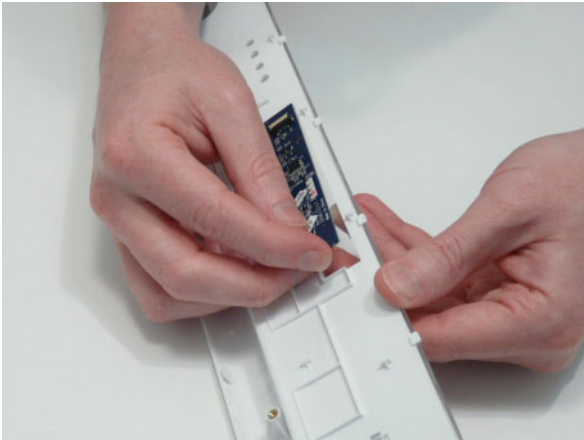

---

## Replacing the Switch Cover

1. Place the Switch Cover rear edge first on to the Upper Cover. Rotate the Switch Cover downward on the Keyboard.



2. Press down the edges of the cover to snap it into place, then press the centre down until it snaps in to place.



3. Turn the computer over and replace the three securing screws as shown.

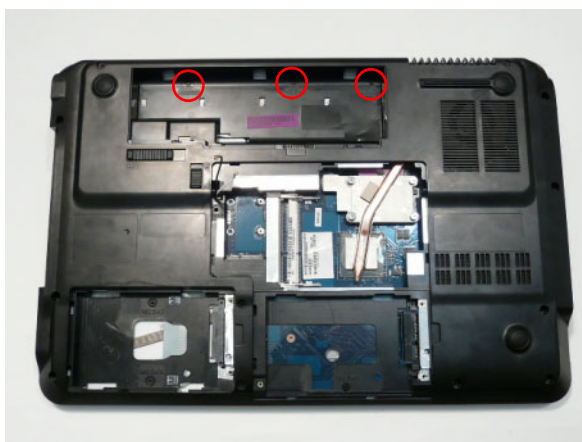

4. Lift the Media Board FFC cover as shown to expose the FFC connector.

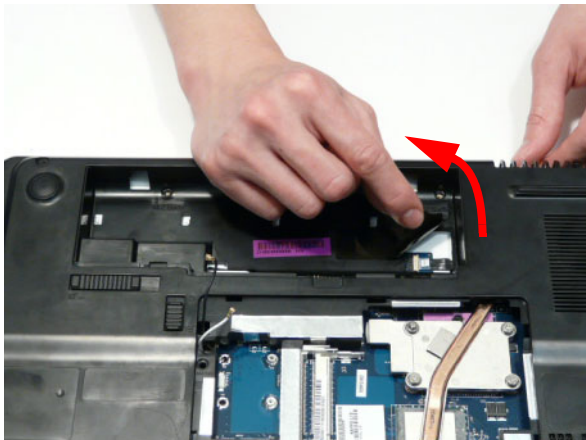

5. Connect the FFC to the Media Board as shown.

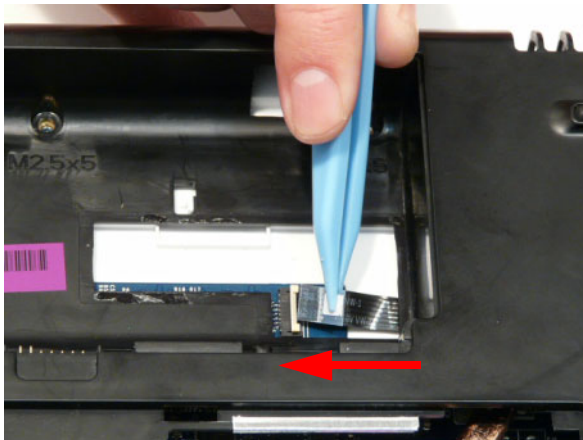

6. Close the FFC locking latch to secure the FFC in place.

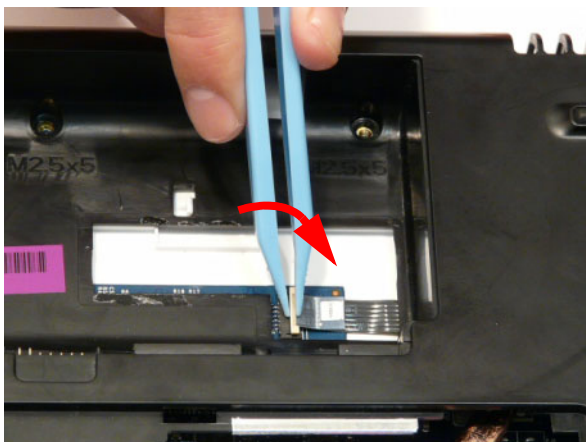

7. Replace the Media Board FFC cover.

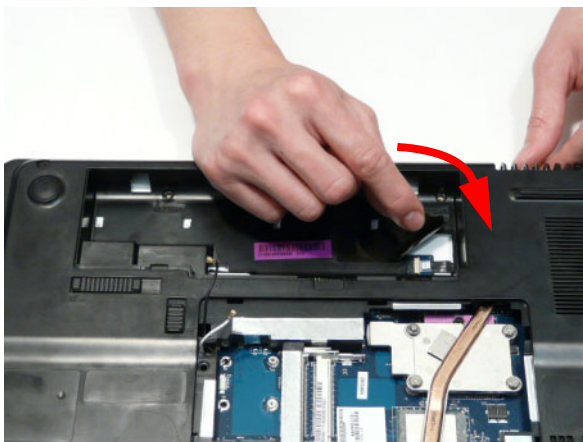

# Replacing the Hard Disk Drive Modules

1. Place the HDD in the HDD carrier.
2. Replace the four screws (two each side) to secure the carrier.

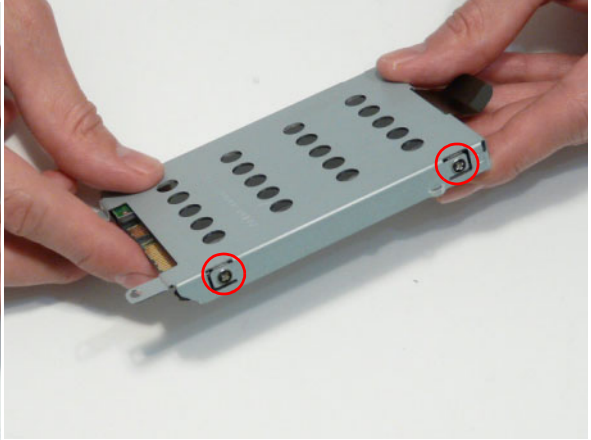
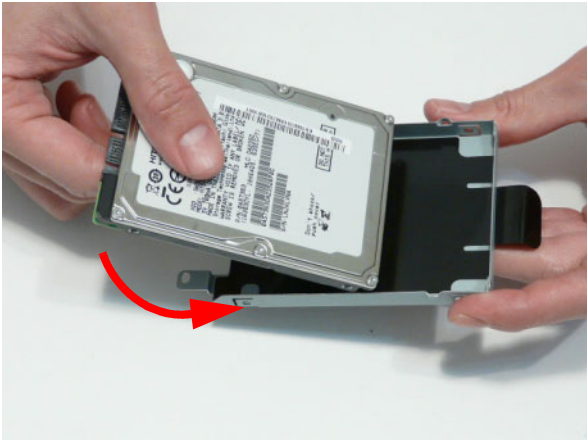

3. Insert the Secondary HDD, right side first, and lower it into place.
4. Slide the Secondary HDD to the right to connect the interface.

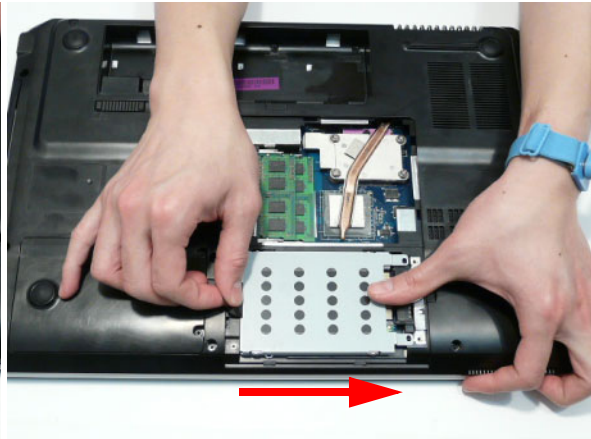
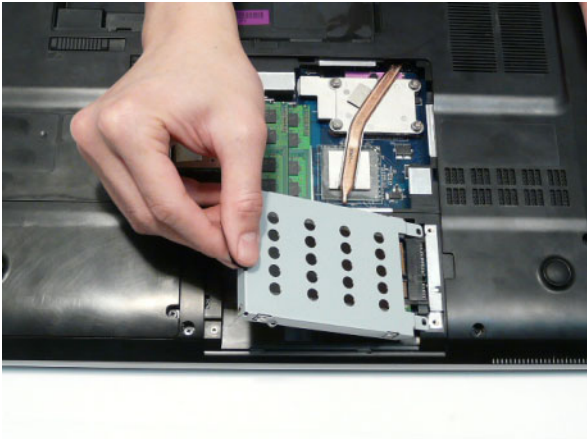

5. Insert the Primary HDD, right side first, and lower it into place. Slide the Primary HDD to the right to connect the interface.



## Replacing the WLAN Module

1. Insert the WLAN Module into the WLAN socket.
2. Replace the single screw to secure the module.

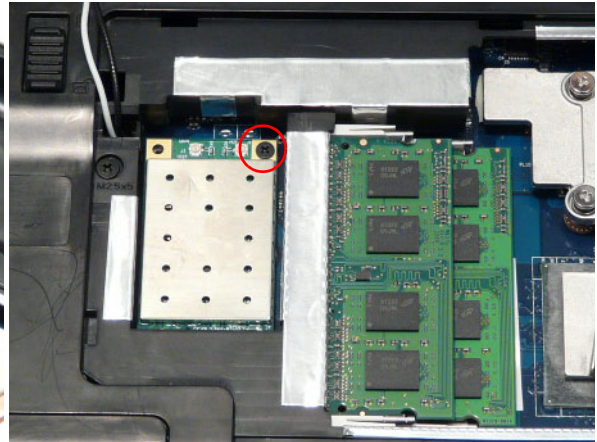
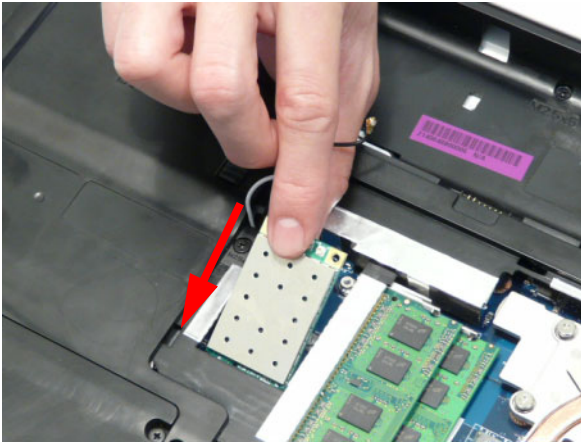

3. Connect the two antenna cables to the module.
4. After connecting the cables to the terminals, secure the cables in place using adhesive tape.

**NOTE:** Cable placement is **Black** to the **MAIN** terminal (left) and **White** to the **AUX** terminal (right).

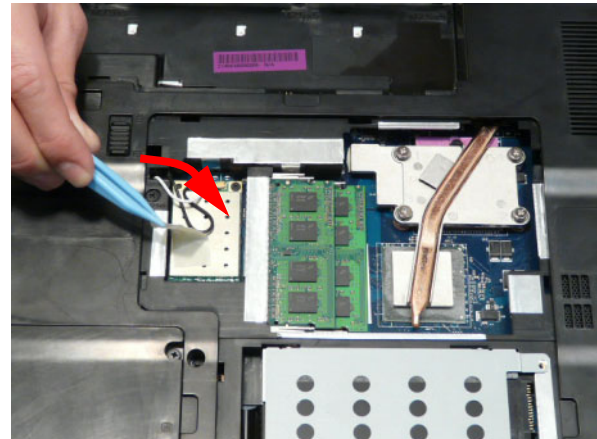
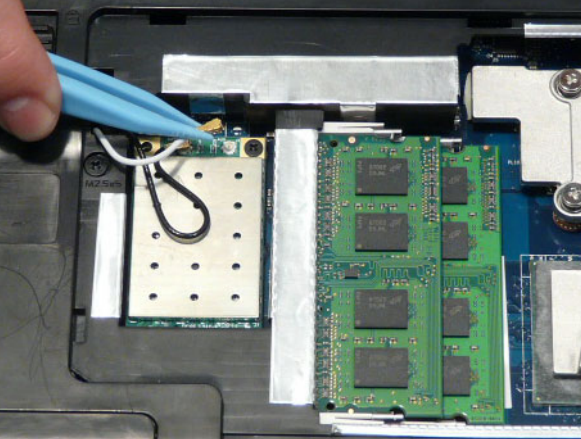

## Replacing the DIMM Modules

1. Insert the DIMM Module in place.
2. Press down to lock the DIMM module in place.

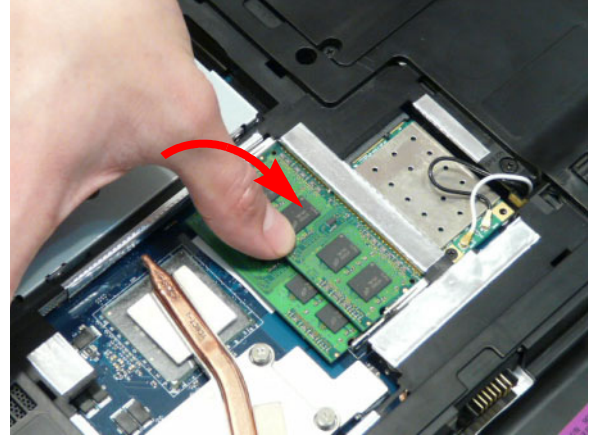
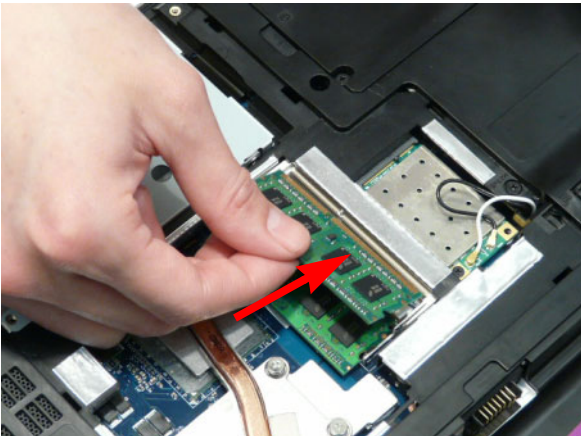



## Replacing the ODD Module

1. Press the bezel into the tray, bottom edge first, to secure it to the ODD Module.
2. Secure the ODD bracket with the two screws.



3. Push the ODD Module into the ODD bay until it is flush with the casing.
4. Replace the single screw to secure the Module.

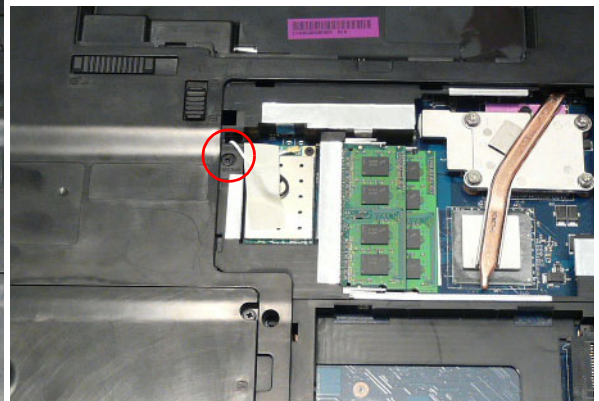
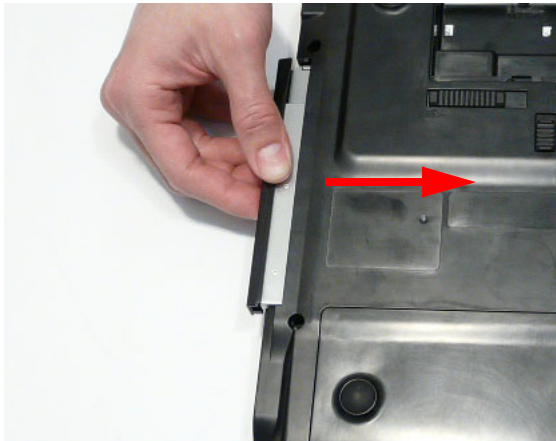

## Replacing the Lower Covers

1. Replace the HDD2, WLAN, and Memory Cover back edge first as shown.



2. Replace the HDD1 Cover as shown.

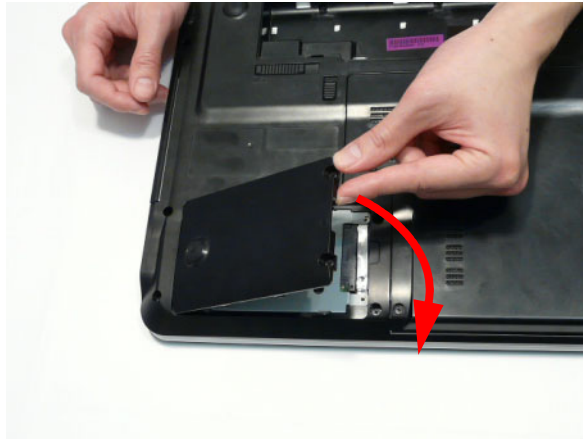

**IMPORTANT:** Press down around the perimeter of the covers to ensure that all the securing tabs are correctly located in the casing.

3. Secure the five captive screws to hold the covers in place.

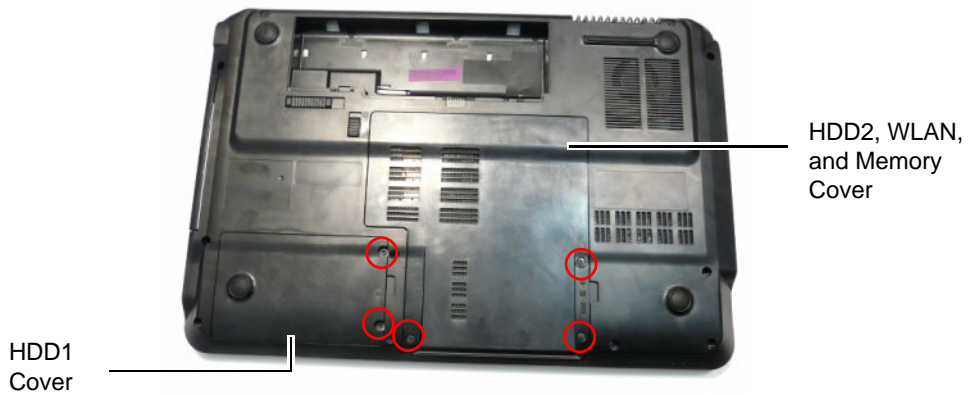

---

## Replacing the SD Dummy Card

1. Insert the SD Dummy Card into the slot and push until the card clicks into place and is flush with the casing.



## Replacing the Battery

1. Slide and hold the battery release latch to the release position (1), insert the battery pack and press down (2).
2. Slide the battery lock in the direction shown to secure the battery in place.





# Troubleshooting

---

## Common Problems

Use the following procedure as a guide for computer problems.

**NOTE:** The diagnostic tests are intended to test only Acer products. Non-Acer products, prototype cards, or modified options can give false errors and invalid system responses.

1. Obtain the failing symptoms in as much detail as possible.
2. Verify the symptoms by attempting to re-create the failure by running the diagnostic test or by repeating the same operation.
3. Use the following table with the verified symptom to determine which page to go to.

Symptoms (Verified)	Go To
Power On Issue	Page 140
No Display Issue	Page 141
Random Loss of BIOS Settings	Page 142
LCD Failure	Page 143
Internal Keyboard Failure	Page 143
TouchPad Failure	Page 144
Internal Speaker Failure	Page 145
Internal Microphone Failure	Page 147
HDD Failure	Page 148
ODD Failure	Page 149
USB (Right side) Failure	Page 153
WLAN Failure	Page 154
Bluetooth Failure	Page 155
Easy Button Failure	Page 156
Thermal Unit Failure	Page 157
External Mouse Failure	Page 157
Other Functions Failure	Page 158
Motherboard CMOS discharge	Page 159
Intermittent Failures	Page 159
Undermined Failures	Page 159

4. If the Issue is still not resolved, see "Online Support Information" on page 207.

---

## Power On Issue

If the system doesn't power on, perform the following actions one at a time to correct the problem. Do not replace non-defective FRUs:

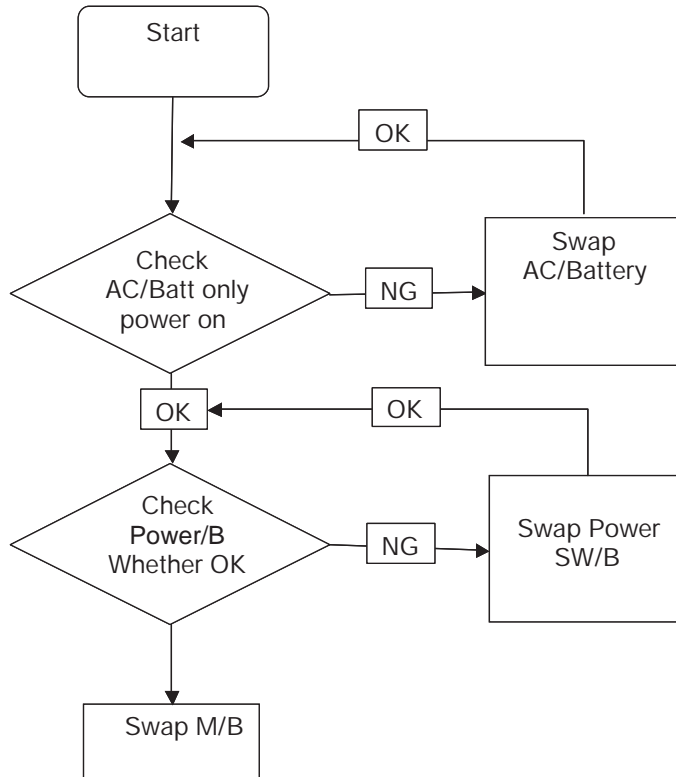

## Computer Shuts down Intermittently

If the system powers off at intervals, perform the following actions one at a time to correct the problem.

1. Check the power cable is properly connected to the computer and the electrical outlet.
2. Remove any extension cables between the computer and the outlet.
3. Remove any surge protectors between the computer and the electrical outlet. Plug the computer directly into a known good electrical outlet.
4. Disconnect the power and open the casing to check the Thermal Unit (see "Thermal Unit Failure" on page 157) and fan airways are free of obstructions.
5. Remove all external and non-essential hardware connected to the computer that are not necessary to boot the computer to the failure point.
6. Remove any recently installed software.
7. If the Issue is still not resolved, see "Online Support Information" on page 207.

# No Display Issue

If the **Display** doesn't work, perform the following actions one at a time to correct the problem. Do not replace non-defective FRUs:

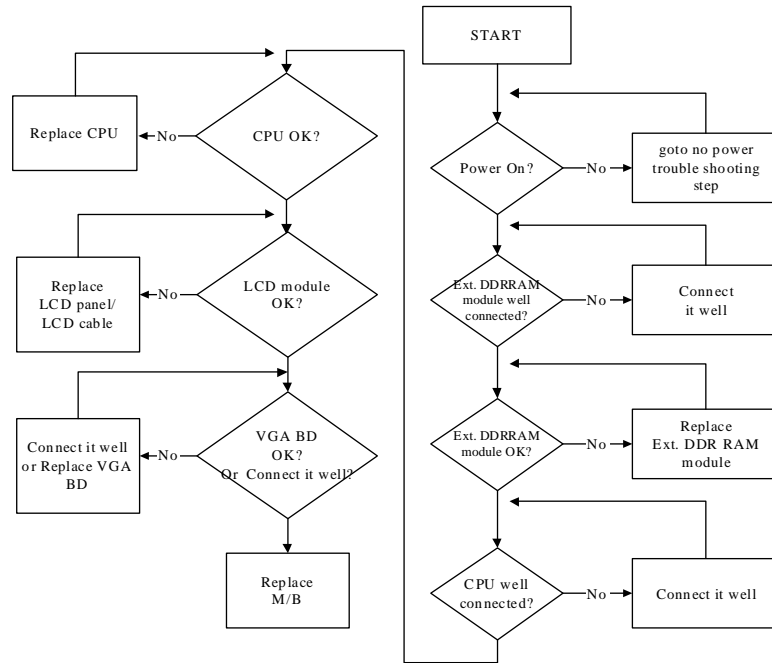

## No POST or Video

If the POST or video doesn't display, perform the following actions one at a time to correct the problem.

1. Make sure that the internal display is selected. On this notebook model, switching between the internal display and the external display is done by pressing **Fn+F5**. Reference Product pages for specific model procedures.
2. Make sure the computer has power by checking at least one of the following occurs:
  - Fans start up
  - Status LEDs light up

If there is no power, see "Power On Issue" on page 140.

3. Drain any stored power by removing the power cable and battery and holding down the power button for 10 seconds. Reconnect the power and reboot the computer.
4. Connect an external monitor to the computer and switch between the internal display and the external display is by pressing **Fn+F5** (on this model).

If the POST or video appears on the external display, see "LCD Failure" on page 143.

5. Disconnect power and all external devices including port replicators or docking stations. Remove any memory cards and CD/DVD discs. Restart the computer.

If the computer boots correctly, add the devices one by one until the failure point is discovered.

6. Reseat the memory modules.
7. Remove the drives (see "Disassembly Process" on page 50).
8. If the Issue is still not resolved, see "Online Support Information" on page 207.

---

## Abnormal Video Display

If video displays abnormally, perform the following actions one at a time to correct the problem.

1. Reboot the computer.
2. If permanent vertical/horizontal lines or dark spots display in the same location, the LCD is faulty and should be replaced. See "Disassembly Process" on page 50.
3. If extensive pixel damage is present (different colored spots in the same locations on the screen), the LCD is faulty and should be replaced. See "Disassembly Process" on page 50.
4. Adjust the brightness to its highest level. See the User Manual for instructions on adjusting settings.  
**NOTE:** Ensure that the computer is not running on battery alone as this may reduce display brightness.  
If the display is too dim at the highest brightness setting, the LCD is faulty and should be replaced. See "Disassembly Process" on page 50.
5. Check the display resolution is correctly configured:
  - a. Minimize or close all Windows.
  - b. If display size is only abnormal in an application, check the view settings and control/mouse wheel zoom feature in the application.
  - c. If desktop display resolution is not normal, right-click on the desktop and select **Personalize**→ **Display Settings**.
  - d. Click and drag the Resolution slider to the desired resolution.
  - e. Click **Apply** and check the display. Readjust if necessary.
6. Roll back the video driver to the previous version if updated.
7. Remove and reinstall the video driver.
8. Check the Device Manager to determine that:
  - The device is properly installed. There are no red Xs or yellow exclamation marks.
  - There are no device conflicts.
  - No hardware is listed under Other Devices.
9. If the Issue is still not resolved, see "Online Support Information" on page 207.
10. Run the Windows Memory Diagnostic from the operating system DVD and follow the onscreen prompts.
11. If the Issue is still not resolved, see "Online Support Information" on page 207.

## Random Loss of BIOS Settings

If the computer is experiencing intermittent loss of BIOS information, perform the following actions one at a time to correct the problem.

1. If the computer is more than one year old, replace the CMOS battery.
2. Run a complete virus scan using up-to-date software to ensure the computer is virus free.
3. If the computer is experiencing HDD or ODD BIOS information loss, disconnect and reconnect the power and data cables between devices.  
If the BIOS settings are still lost, replace the cables.
4. If HDD information is missing from the BIOS, the drive may be defective and should be replaced.
5. Replace the Motherboard.
6. If the Issue is still not resolved, see "Online Support Information" on page 207.



---

## LCD Failure

If the **LCD** fails, perform the following actions one at a time to correct the problem. Do not replace non-defective FRUs:

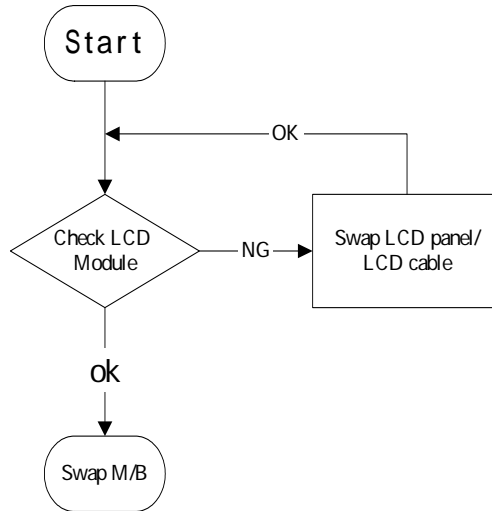

## Built-In Keyboard Failure

If the built-in **Keyboard** fails, perform the following actions one at a time to correct the problem. Do not replace non-defective FRUs:

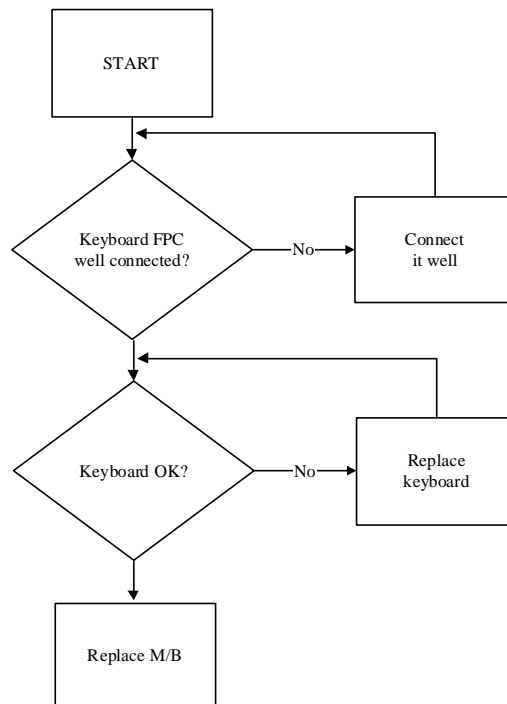

# TouchPad Failure

If the **TouchPad** doesn't work, perform the following actions one at a time to correct the problem. Do not replace non-defective FRUs:

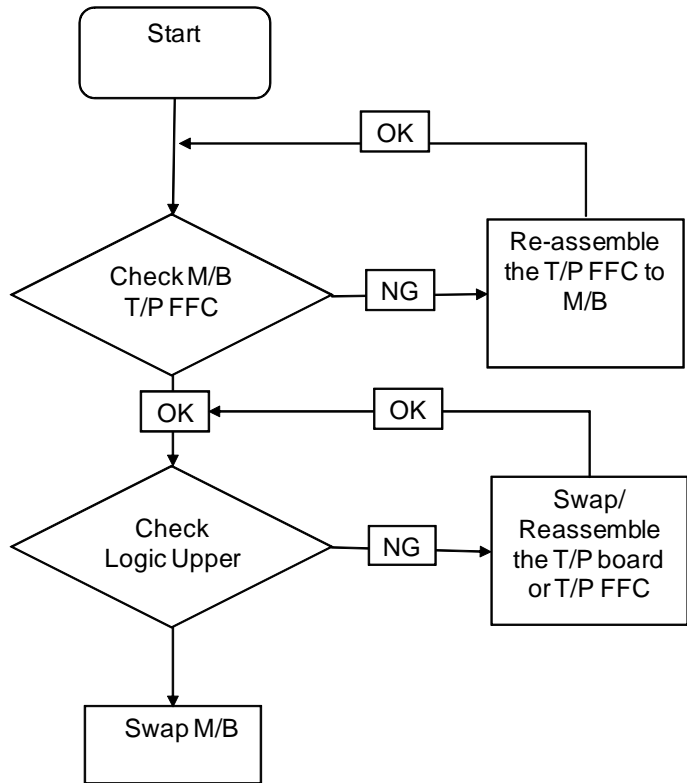

---

# Internal Speaker Failure

If the internal **Speakers** fail, perform the following actions one at a time to correct the problem. Do not replace non-defective FRUs:

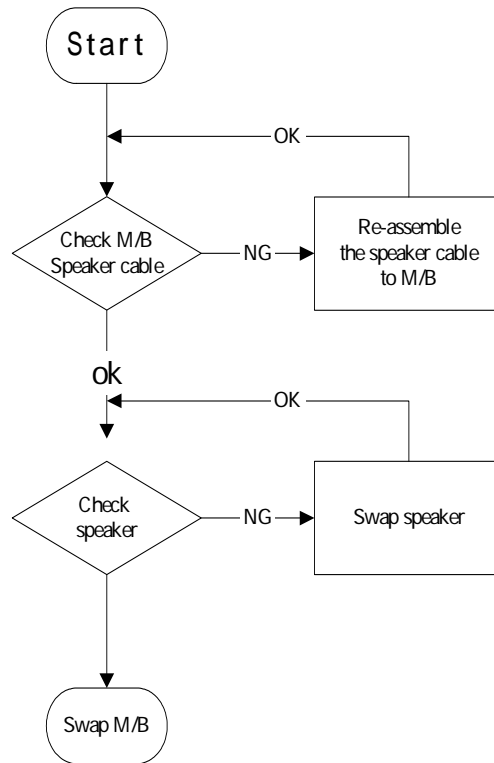

## Sound Problems

If sound problems are experienced, perform the following actions one at a time to correct the problem.

1. Reboot the computer.
2. Navigate to **Start** → **Control Panel** → **System and Maintenance** → **System** → **Device Manager**. Check the Device Manager to determine that:
  - The device is properly installed.
  - There are no red Xs or yellow exclamation marks.
  - There are no device conflicts.
  - No hardware is listed under Other Devices.
3. Roll back the audio driver to the previous version, if updated recently.
4. Remove and reinstall the audio driver.
5. Ensure that all volume controls are set mid range:
  - a. Click the volume icon on the taskbar and drag the slider to 50. Ensure that the volume is not muted.
  - b. Click Mixer to verify that other audio applications are set to 50 and not muted.
6. Navigate to **Start** → **Control Panel** → **Hardware and Sound** → **Sound**. Ensure that Speakers are selected as the default audio device (green check mark).

**NOTE:** If Speakers does not show, right-click on the **Playback** tab and select **Show Disabled Devices** (clear by default).
7. Select Speakers and click **Configure** to start **Speaker Setup**. Follow the onscreen prompts to configure the speakers.

- 
8. Remove and recently installed hardware or software.
  9. Restore system and file settings from a known good date using **System Restore**.  
If the issue is not fixed, repeat the preceding steps and select an earlier time and date.
  10. Reinstall the Operating System.
  11. If the Issue is still not resolved, see “Online Support Information” on page 207.

# Internal Microphone Failure

If the internal **Microphone** fails, perform the following actions one at a time to correct the problem. Do not replace non-defective FRUs:

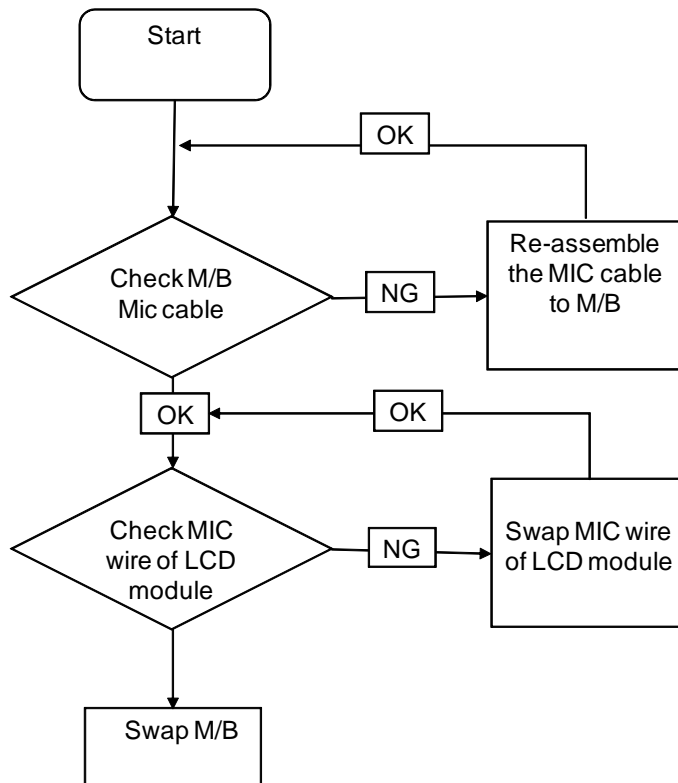

## Microphone Problems

If internal or external **Microphones** do not operate correctly, perform the following actions one at a time to correct the problem.

1. Check that the microphone is enabled. Navigate to **Start** → **Control Panel** → **Hardware and Sound** → **Sound** and select the **Recording** tab.
2. Right-click on the **Recording** tab and select **Show Disabled Devices** (clear by default).
3. The microphone appears on the **Recording** tab.
4. Right-click on the microphone and select **Enable**.
5. Select the microphone then click **Properties**. Select the **Levels** tab.
6. Increase the volume to the maximum setting and click **OK**.
7. Test the microphone hardware:
  - a. Select the microphone and click **Configure**.
  - b. Select **Set up microphone**.
  - c. Select the microphone type from the list and click **Next**.
  - d. Follow the onscreen prompts to complete the test.
8. If the Issue is still not resolved, see "Online Support Information" on page 207.

---

## HDD Not Operating Correctly

If the **HDD** does not operate correctly, perform the following actions one at a time to correct the problem.

1. Disconnect all external devices.
2. Run a complete virus scan using up-to-date software to ensure the computer is virus free.
3. Run the Windows 7 Startup Repair Utility:
  - a. insert the Windows 7 Operating System DVD in the ODD and restart the computer.
  - b. When prompted, press any key to start to the operating system DVD.
  - c. The **Install Windows** screen displays. Click **Next**.
  - d. Select **Repair your computer**.
  - e. The **System Recovery Options** screen displays. Click **Next**.
  - f. Select the appropriate operating system, and click **Next**.

**NOTE:** Click **Load Drivers** if controller drives are required.

- g. Select **Startup Repair**.
- h. Startup Repair attempts to locate and resolve issues with the computer.
- i. When complete, click **Finish**.

If an issue is discovered, follow the onscreen information to resolve the problem.

4. Run the Windows Memory Diagnostic Tool. For more information see Windows Help and Support.
5. Restart the computer and press F2 to enter the BIOS Utility. Check the BIOS settings are correct and that CD/DVD drive is set as the first boot device on the Boot menu.
6. Ensure all cables and jumpers on the HDD and ODD are set correctly.
7. Remove any recently added hardware and associated software.
8. Run the Windows Disk Defragmenter. For more information see Windows Help and Support.
9. Run Windows Check Disk by entering **chkdsk /r** from a command prompt. For more information see Windows Help and Support.
10. Restore system and file settings from a known good date using **System Restore**.

If the issue is not fixed, repeat the preceding steps and select an earlier time and date.
11. Replace the HDD. See "Disassembly Process" on page 50.

---

## ODD Failure

If the **ODD** fails, perform the following actions one at a time to correct the problem. Do not replace non-defective FRUs:

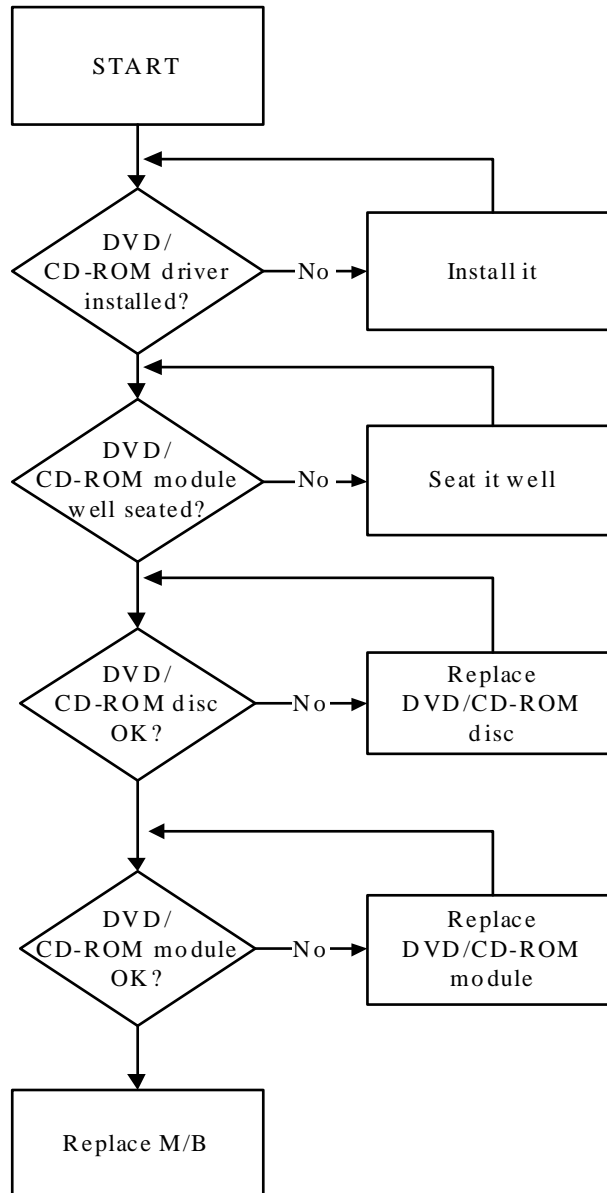

## ODD Not Operating Correctly

If the **ODD** exhibits any of the following symptoms it may be faulty:

- Audio CDs do not play when loaded
- DVDs do not play when loaded
- Blank discs do not burn correctly
- DVD or CD play breaks up or jumps
- Optical drive not found or not active:
  - Not shown in My Computer or the BIOS setup

- LED does not flash when the computer starts up
- The tray does not eject
- Access failure screen displays
- The ODD is noisy

Perform the following general solutions one at a time to correct the problem.

1. Reboot the computer and retry the operation.
2. Try an alternate disc.
3. Navigate to **Start** → **Computer**. Check that the ODD device is displayed in the **Devices with Removable Storage** panel.
4. Navigate to **Start** → **Control Panel** → **System and Maintenance** → **System** → **Device Manager**.
  - a. Double-click **IDE ATA/ATAPI controllers**. If a device displays a down arrow, right-click on the device and click **Enable**.
  - b. Double-click **DVD/CD-ROM drives**. If the device displays a down arrow, right-click on the device and click **Enable**.
  - c. Check that there are no yellow exclamation marks against the items in **IDE ATA/ATAPI controllers**. If a device has an exclamation mark, right-click on the device and uninstall and reinstall the driver.
  - d. Check that there are no yellow exclamation marks against the items in **DVD/CD-ROM drives**. If a device has an exclamation mark, right-click on the device and uninstall and reinstall the driver.
  - e. If the exclamation marker is not removed from the item in the lists, try removing any recently installed software and retrying the operation.

### Discs Do Not Play

If discs do not play when inserted in the drive, perform the following actions one at a time to correct the problem.

1. Check that the disc is correctly seated in the drive tray and that the label on the disc is visible.
2. Check that the media is clean and scratch free.
3. Try an alternate disc in the drive.
4. Ensure that **AutoPlay** is enabled:
  - a. Navigate to **Start** → **Control Panel** → **Hardware and Sound** → **AutoPlay**.
  - b. Select **Use AutoPlay for all media and devices**.
  - c. In the Audio CD and DVD Movie fields, select the desired player from the drop down menu.
5. Check that the Regional Code is correct for the selected media:

**IMPORTANT:** Region can only be changed a limited number of times. After Changes remaining reaches zero, the region cannot be changed even Windows is reinstalled or the drive is moved to another computer.

- a. Navigate to **Start** → **Control Panel** → **System and Maintenance** → **System** → **Device Manager**.
- b. Double-click **DVD/CD-ROM drives**.
- c. Right-click **DVD drive** and click **Properties**, then click the **DVD Region** tab.
- d. Select the region suitable for the media inserted in the drive.

### Discs Do Not Burn Properly

If discs can not be burned, perform the following actions one at a time to correct the problem.

1. Ensure that the default drive is record enabled:
  - a. Navigate to **Start** → **Computer** and right-click the writable ODD icon. Click **Properties**.
  - b. Select the **Recording** tab. In the **Desktop disc recording** panel, select the writable ODD from the drop down list.



- 
- c. Click **OK**.
  2. Ensure that the software used for burning discs is the factory default. If using different software, refer to the software's user manual.

### Playback is Choppy

If playback is choppy or jumps, perform the following actions one at a time to correct the problem.

1. Check that system resources are not running low:
  - a. Try closing some applications.
  - b. Reboot and try the operation again.
2. Check that the ODD controller transfer mode is set to DMA:
  - a. Navigate to **Start** → **Control Panel** → **System and Maintenance** → **System** → **Device Manager**.
  - b. Double-click **IDE ATA/ATAPI controllers**, then right-click ATA Device 0.
  - c. Click **Properties** and select the **Advanced Settings** tab. Ensure that the **Enable DMA** box is checked and click **OK**.
  - d. Repeat for the other ATA Devices shown if applicable.

### Drive Not Detected

If Windows cannot detect the drive, perform the following actions one at a time to correct the problem.

1. Restart the computer and press F2 to enter the BIOS Utility.
2. Check that the drive is detected in the **ATAPI Model Name** field on the Information page.  
**NOTE:** Check that the entry is identical to one of the ODDs specified in “Hardware Specifications and Configurations” on page 17.
3. Turn off the power and remove the cover to inspect the connections to the ODD. See “Disassembly Process” on page 50.
  - a. Check for broken connectors on the drive, motherboard, and cables.
  - b. Check for bent or broken pins on the drive, motherboard, and cable connections.
  - c. Try an alternate cable, if available. If the drive works with the new cable, the original cable should be replaced.
4. Reseat the drive ensuring and all cables are connected correctly.
5. Replace the ODD. See “Disassembly Process” on page 50.

### Drive Read Failure

If discs cannot be read when inserted in the drive, perform the following actions one at a time to correct the problem.

1. Remove and clean the failed disc.
2. Retry reading the CD or DVD.
  - d. Test the drive using other discs.
  - e. Play a DVD movie
  - f. Listen to a music CD

If the ODD works properly with alternate discs, the original disc is probably defective and should be replaced.

3. Turn off the power and remove the cover to inspect the connections to the ODD. See “Disassembly Process” on page 50.
  - a. Check for broken connectors on the drive, motherboard, and cables.
  - b. Check for bent or broken pins on the drive, motherboard, and cable connections.

- 
- c. Try an alternate cable, if available. If the drive works with the new cable, the original cable should be replaced.
  - 4. Replace the ODD. See "Disassembly Process" on page 50.

## USB (Right Side) Failure

If the right-side **USB** fails, perform the following actions one at a time to correct the problem. Do not replace non-defective FRUs:

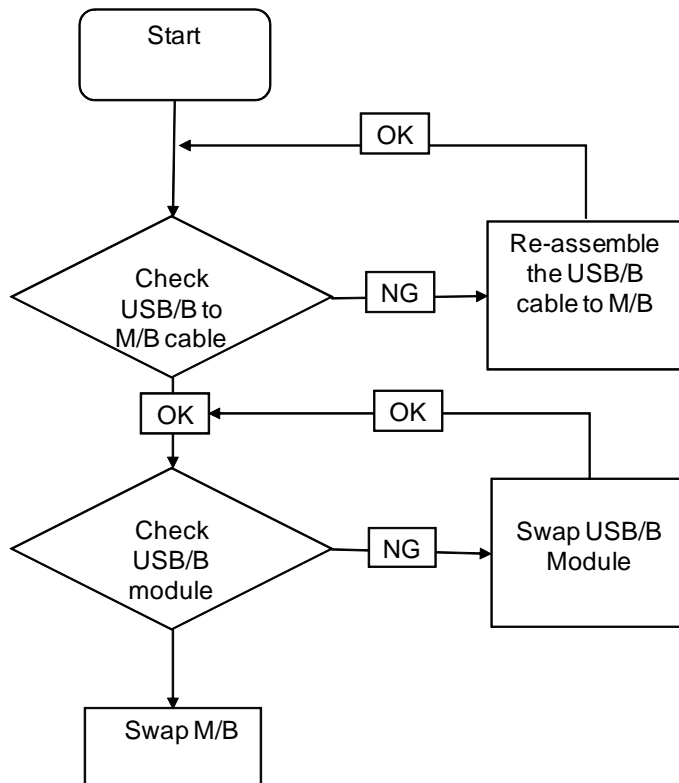

# Wireless Function Failure

If the **WLAN** fails, perform the following actions one at a time to correct the problem. Do not replace non-defective FRUs:

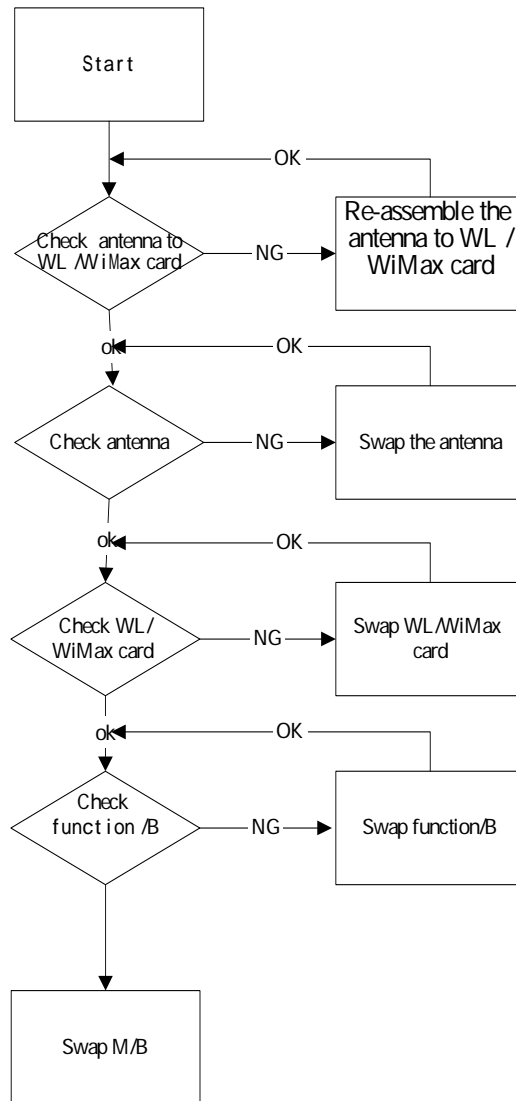

# Bluetooth Function Test Failure

If the **Bluetooth** function test fails, perform the following actions one at a time to correct the problem. Do not replace non-defective FRUs:

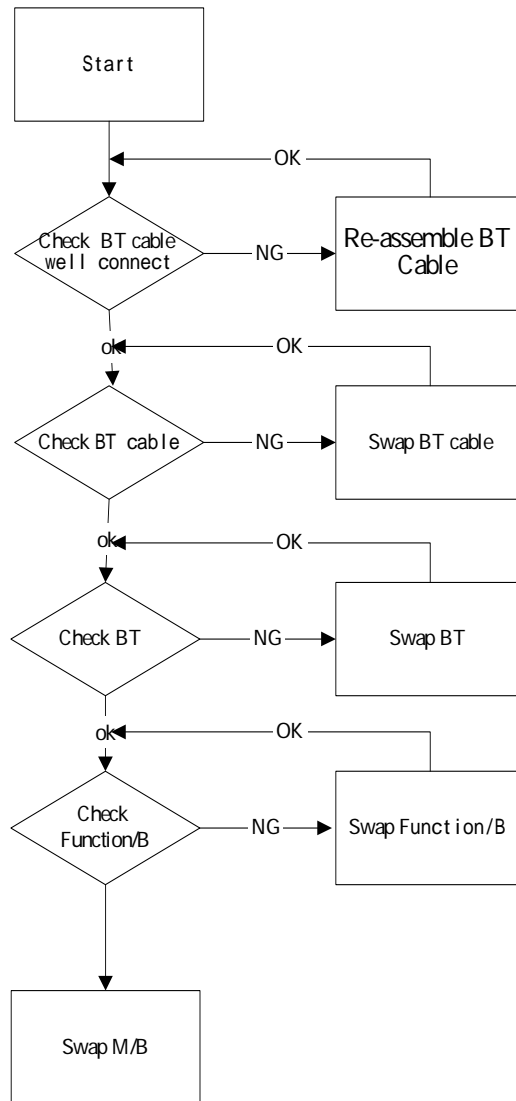

# Easy Button Failure

If the **Easy Button** fails, perform the following actions one at a time to correct the problem. Do not replace non-defective FRUs:

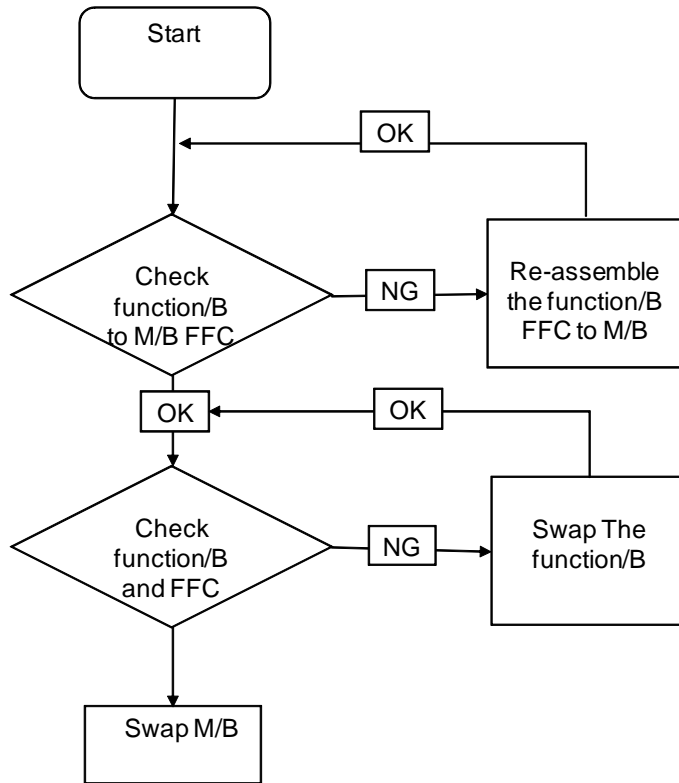

---

## Thermal Unit Failure

If the **Thermal Unit** fails, perform the following actions one at a time to correct the problem. Do not replace non-defective FRUs:

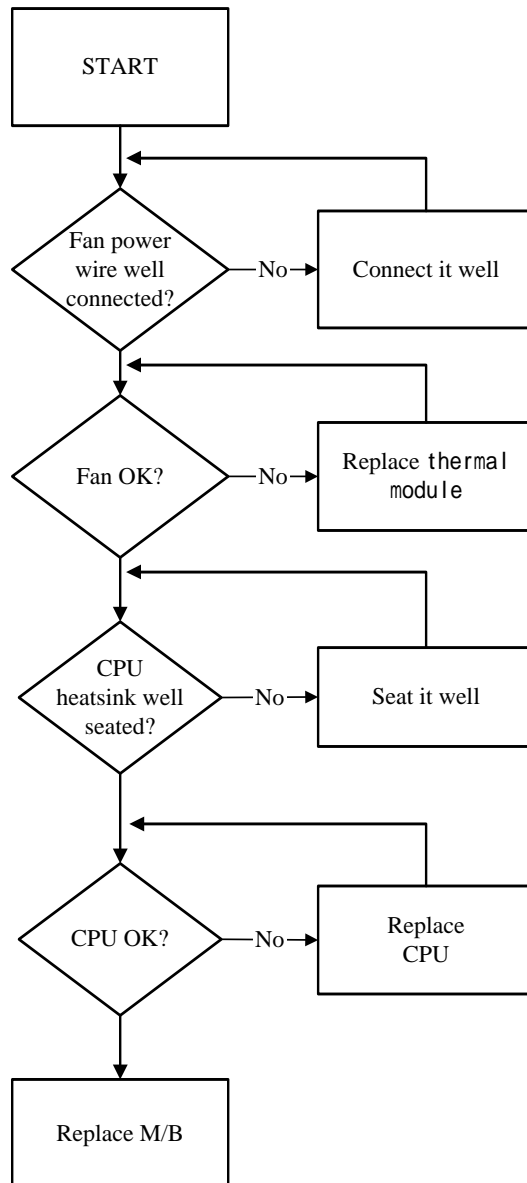

## External Mouse Failure

If an external **Mouse** fails, perform the following actions one at a time to correct the problem.

1. Try an alternative mouse.
2. If the mouse uses a wireless connection, insert new batteries and confirm there is a good connection. See the mouse user manual.
3. If the mouse uses a USB connection, try an alternate USB port.
4. Try an alternative program to verify mouse operation. Reinstall the program experiencing mouse failure.

- 
5. Restart the computer.
  6. Remove any recently added hardware and associated software.
  7. Remove any recently added software and reboot.
  8. Restore system and file settings from a known good date using **System Restore**.  
If the issue is not fixed, repeat the preceding steps and select an earlier time and date.
  9. Run the Event Viewer to check the events log for errors. For more information see Windows Help and Support.
  10. Roll back the mouse driver to the previous version if updated recently.
  11. Remove and reinstall the mouse driver.
  12. Check the Device Manager to determine that:
    - The device is properly installed. There are no red Xs or yellow exclamation marks.
    - There are no device conflicts.
    - No hardware is listed under Other Devices.
  13. If the Issue is still not resolved, see "Online Support Information" on page 207.

## Other Failures

If the CRT Switch, Dock, LAN Port, external MIC or Speakers, PCI Express Card, 5-in-1 Card Reader or Volume Wheel fail, perform the following general steps to correct the problem. Do not replace non-defective FRUs:

1. Check Drive whether is OK.
2. Check Test Fixture is ok.
3. Swap M/B to Try.



---

# Motherboard CMOS Discharge

If any problems such as incorrect CMOS settings, the CMOS data can be cleared by short-circuiting the CMOS CLRP2 jumpers. Open the memory bay door and short-circuit the jumpers near the DDR socket, using a metal conductivity tool.

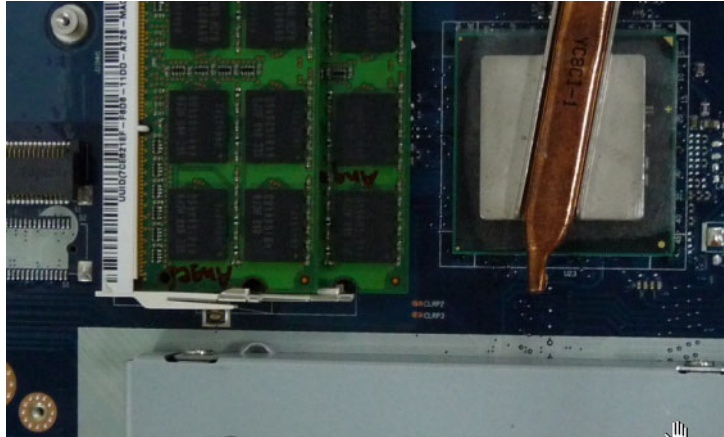

## Intermittent Problems

Intermittent system hang problems can be caused by a variety of reasons that have nothing to do with a hardware defect, such as: cosmic radiation, electrostatic discharge, or software errors. FRU replacement should be considered only when a recurring problem exists.

When analyzing an intermittent problem, do the following:

1. Run the advanced diagnostic test for the system board in loop mode at least 10 times.
2. If no error is detected, do not replace any FRU.
3. If any error is detected, replace the FRU. Rerun the test to verify that there are no more errors.

## Undetermined Problems

The diagnostic problems does not identify which adapter or device failed, which installed devices are incorrect, whether a short circuit is suspected, or whether the system is inoperative.

Follow these procedures to isolate the failing FRU (do not isolate non-defective FRU).

**NOTE:** Verify that all attached devices are supported by the computer.

**NOTE:** Verify that the power supply being used at the time of the failure is operating correctly. (See “Power On Issue” on page 140.):

1. Power-off the computer.
2. Visually check them for damage. If any problems are found, replace the FRU.
3. Remove or disconnect all of the following devices:
  - Non-Acer devices
  - Printer, mouse, and other external devices
  - Battery pack
  - Hard disk drive
  - DIMM
  - CD-ROM/Diskette drive Module
  - PC Cards

- 
4. Power-on the computer.
  5. Determine if the problem has changed.
  6. If the problem does not recur, reconnect the removed devices one at a time until you find the failing FRU.
  7. If the problem remains, replace the following FRU one at a time. Do not replace a non-defective FRU:
    - System board
    - LCD assembly

---

# Post Codes

These tables describe the POST codes and descriptions during the POST.

## Chipset POST Codes

The following table details the chipset POST codes and functions used in the POST.

Sec:

NO\_EVICTION\_MODE\_DEBUG EQU 1 (CommonPlatform\sec\la32\SecCore.inc)

Code	Description
0xC2	MTRR setup
0xC3	Enable cache
0xC4	Establish cache tags
0xC5	Enter NEM, Place the BSP in No Fill mode, set CR0.CD = 1, CR0.NW = 0.
0xCF	Cache Init Finished

Memory:

DEBUG\_BIOS equ 1 (Chipset\Alviso\MemoryInitAsm\IA32\IMEMORY.INC)

Code	Description
0xA0	First memory check point
0x01	Enable MCHBAR
0x02	Check for DRAM initialization interrupt and reset fail
0x03	Verify all DIMMs are DDR or DDR2 and unbuffered
0x04	Detect an improper warm reset and handle
0x05	Detect if ECC SO-DIMMs are present in the system
0x06	Verify all DIMMs are single or double sided and not asymmetric
0x07	Verify all DIMMs are x8 or x16 width
0x08	Find a common CAS latency between the DIMMS and the MCH
0x09	Determine the memory frequency and CAS latency to program
0x10	Determine the smallest common TRAS for all DIMMs
0x11	Determine the smallest common TRP for all DIMMs
0x12	Determine the smallest common TRCD for all DIMMs
0x13	Determine the smallest refresh period for all DIMMs
0x14	Verify burst length of 8 is supported by all DIMMs
0x15	Determine the smallest tWR supported by all DIMMs
0x16	Determine DIMM size parameters
0x17	Program the correct system memory frequency
0x18	Determine and set the mode of operation for the memory channels
0x19	Program clock crossing registers
0x20	Disable Fast Dispatch
0x21	Program the DRAM Row Attributes and DRAM Row Boundary registers
0x22	Program the DRAM Bank Architecture register
0x23	Program the DRAM Timing & and DRAM Control registers

Code	Description
0x24	Program ODT
0x25	Perform steps required before memory init
0x26	Program the receive enable reference timing control register Program the DLL Timing Control Registers, RCOMP settings
0x27	Enable DRAM Channel I/O Buffers
0x28	Enable all clocks on populated rows
0x29	Perform JEDEC memory initialization for all memory rows
0x30	Perform steps required after memory init
0x31	Program DRAM throttling and throttling event registers
0x32	Setup DRAM control register for normal operation and enable
0x33	Enable RCOMP
0x34	Clear DRAM initialization bit in the SB
0x35	Initialization Sequence Completed, program graphic clocks
0x43	Program Thermal Throttling

## BDS & Specific action:

Code	Description
0x00	Report the legacy boot is happening
0x12	Wake up the Aps
0x13	Initialize SMM Private Data and relocate BSP SMBASE
0x21	PC init begin at the stage1
0x27	Report every memory range do the hard ware ECC init
0x28	Report status code of every memory range
0x50	Get the root bridge handle
0x51	Notify pci bus driver starts to program the resource
0x58	Reset the host controller
0x5A	IdeBus begin initialization
0x79	Report that the remote terminal is being disabled
0x7A	Report that the remote terminal is being enabled
0x90	Keyboard reset
0x91	USB Keyboard disable
0x92	Keyboard detection
0x93	Report that the usb keyboard is being enabled
0x94	Clear the keyboard buffer
0x95	Init Keyboard
0x98	Mouse reset
0x99	Mouse disable
0x9A	Detect PS2 mouse
0x9B	Report that the mouse is being enabled
0xB8	Peripheral removable media reset (ex: IsaFloppy, USB device)
0xB9	Peripheral removable media disable
0xBB	Peripheral removable media enable
0xE4	Report Status Code here for DXE_ENTRY_POINT once it is available

---

Code	Description
0xF8	Report that ExitBootServices () has been called
0xF9	Runtime driver set virtual address map

## Each PEIM entry point used in 80\_PORT

Code	Description
0x00	
0x01	PEI_EVENT_LOG
0xA1	PEI_OEM_SERVICE
0xA2	PEI_SIO_INIT
0xA3	PEI_MONO_STATUS_CODE
0xA4	PEI_CPU_IO_PCI_CFG
0x06	PEI_CPU_IO
0x07	PEI_PCI_CFG
0xA5	PEI_CPU_PEIM
0xA6	PEI_PLATFORM_STAGE1
0xA7	PEI_VARIABLE
0xA8	PEI_SB_INIT
0x0C	PEI_CAPSULE
0xAA	PEI_PLATFORM_STAGE2
0xAC	PEI_SB_SMBUS_ARP_DISABLED
0x0F	PEI_HOST_TO_SYSTEM
0x40	PEI_MEMORY_INIT
0x41	PEI_S3_RESUME
0xAD	PEI_CLOCK_GEN
0xAB	PEI_OP_PRESENCE
0xAE	PEI_FIND_FV
0x16	PEI_H2O_DEBUG_IO
0x17	PEI_H2O_DEBUG_COMM
0x16~0x1F	PEI_RESERVED
0x20~0x2E	PEI_OEM_DEFINED
0xAF	PEI_DXE_IPL

## Each Driver entry point used in 80\_PORT

Code	Description
0x30	RESERVED
0xB6	DXE_CRC32_SECTION_EXTRACT
0xB8	SCRIPT_SAVE
0xB9	ACPI_S3_SAVE
0xBA	SMART_TIMER
0xBB	JPEG_DECODER
0xBC	PCX_DECODER
0xBE	HT_CPU / MP_CPU
0xBF	LEGACY_METRONOME
0xC0	FTWLITE
0xC1	RUN_RIME
0xC2	MONOTONIC_COUNTER
0xC3	WATCH_DOG_TIMER

Code	Description
0xC4	SECURITY_STUB
0xC5	DXE_CPU_IO
0xC6	CF9_RESET
0xC7	PC_RTC
0xC8	STATUS_CODE
0xC9	VARIABLE EMU_VARIABLE
0xD9	DXE_CHIPSET_INIT
0x45	DXE_ALERT_FORMAT
0xD6	PCI_HOST_BRIDGE
0xD7	PCI_EXPRESS
0xD5	DXE_SB_INIT
0xDA	IDE_CONTROLLER
0xDB	SATA_CONTROLLER
0xDD	SB_SM_BUS
0xE7	ISA_ACPI_DRIVER
0xE8	ISA_BUS
0xE9	ISA_SERIAL
0xED	BUS_PCI_UNDI
0xEC	PCI_BUS
0xF6	BOOT_PRIORITY
0xF7	FVB_SERVICE
0xF8	ACPI_PLATFORM
0xFB	PCI_HOT_PLUG
0xFC	DXE_PLATFORM
0xFD	PLATFORM_IDE
0x97	SMBIOS
0x98	MEMORY_SUB_CLASS
0x99	MISC_SUB_CLASS
0x82	CON_PLATFORM
0x83	SAVE_MEMORY_CONFIG
0x84	ACPI_SUPPORT
0x85	CON_SPLITTER_UGA_VGA / CON_SPLITTER
0x88	VGA_CLASS
0x89	DATA_HUB
0x60	DISK_IO
0x8B	MEMORY_TEST
0x62	CRISIS_RECOVERY
0x8D	LEGACY_8259
0x8E	LEGACY_REGION
0x8F	LEGACY_INTERRUPT
0x70	BIOS_KEYBOARD
0x71	BIOS_VEDIO

Code	Description
0x72	MONITER_KEY
0x73	LEGACY_BIOS
0x75	LEGACY_BIOS_PLATFORM
0x76	PCI_PLATFORM
0x6C	ISA_FLOOPY
0x6D	PS2_MOUSE
0x6E	USB_BOT
0x6F	USB_CBI0
0x74	USB_MOUSE
0xFA	SETUP_UTILITY
0x90	FW_BLOCK_SERVICE
0x78	SMM_USB_LEGACY
0x86	GRAPHICS_CONSOLE
0x87	TERMINAL
0x8A	DATA_HUB_STD_ERR
0x7C	FAT
0x7D	PARTITION
0x7E	ENGLISH
0x7F	FRENCH
0x9E	HII_DATABASE
0x9F	OEM_SETUP_BROWSER
0x8C	OEM_BADGING_SUPPORT
0xF9	SETUP_MOUSE
0x72	MONITOR_KEY
0xBD	PLATFORM_BDS
0x8D	RESERVED
0x8E	RESERVED
0x8F	RESERVED
0xA0	DXE_H2O_DEBUG_IO
0xB3	DXE_TPM_TCG
0xB4	DXE_TPM_PHYSICAL_PRESENCE
0xB7	DXE_OEM_SERVICE
0x9B	DXE_SECURITY_HDD_PASSWORD_SERVICE
0xA9	DXE_LAN_IDER_CONTROLLER
0x9C	DXE_SECURITY_SYSTEM_PASSWORD_SERVICE
0x9D	DXE_SECURITY_PASSWORD_CONSOLE
0xCB	DXE_DATA_HUB_RECORD_POLICY
0xB5	DXE_TPM_DRIVER
0x11	CHINESE
0xB0	JAPANESE
0xB1	DXE_UNICODE_COLLACTION



---

## Each SmmDriver entry point used in 80\_PORT

Code	Description
0xD4	SMM_ACCESS
0xDE	SMM_CONTROL
0xCC	SMM_BASE
0xD2	SMM_RUNTIME
0xDF	SB_SMM_DISPATCH
0xD0	SMM_THUNK
0xCA	SMM_ACPI_SW_CHILD
0xFE	SMM_PLATFORM
0xD8	SMM_GMCH_MBI
0x90	SMM_FW_BLOCK_SERVICE
0x91	SMM_VARIABLE
0x92	SMM_IHISI
0x93	SMM_INT15_MICROCODE
0x94	SMM_PNP
0x95	SMM_INIT_PPM
0xD3	SMM_OEM_SERVICE



# Jumper and Connector Locations

## Top View

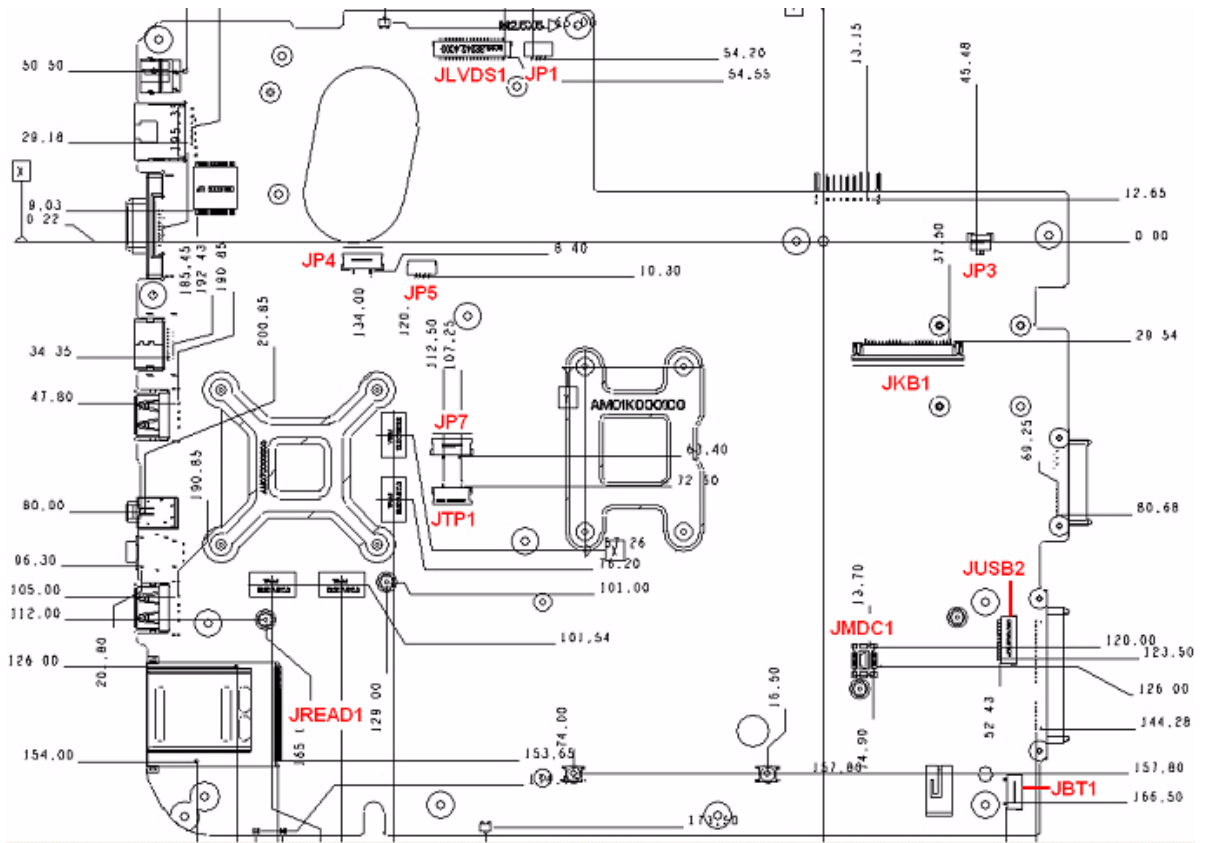

Item	Description
JLVDS1	LCD Connector
JP1	Internal MIC
JP3	Power board Connector
JKB1	Internal Keyboard Connector
JMDC1	Internal MDC Connector
JUSB2	USB Board connector
JBT1	B/T connector
JP7	Cap sensor board CONN
JTP1	T/P Connector
JREAD1	Card Reader Socket
JP5	Speaker CONN
JP4	LED Board CONN

# Bottom View

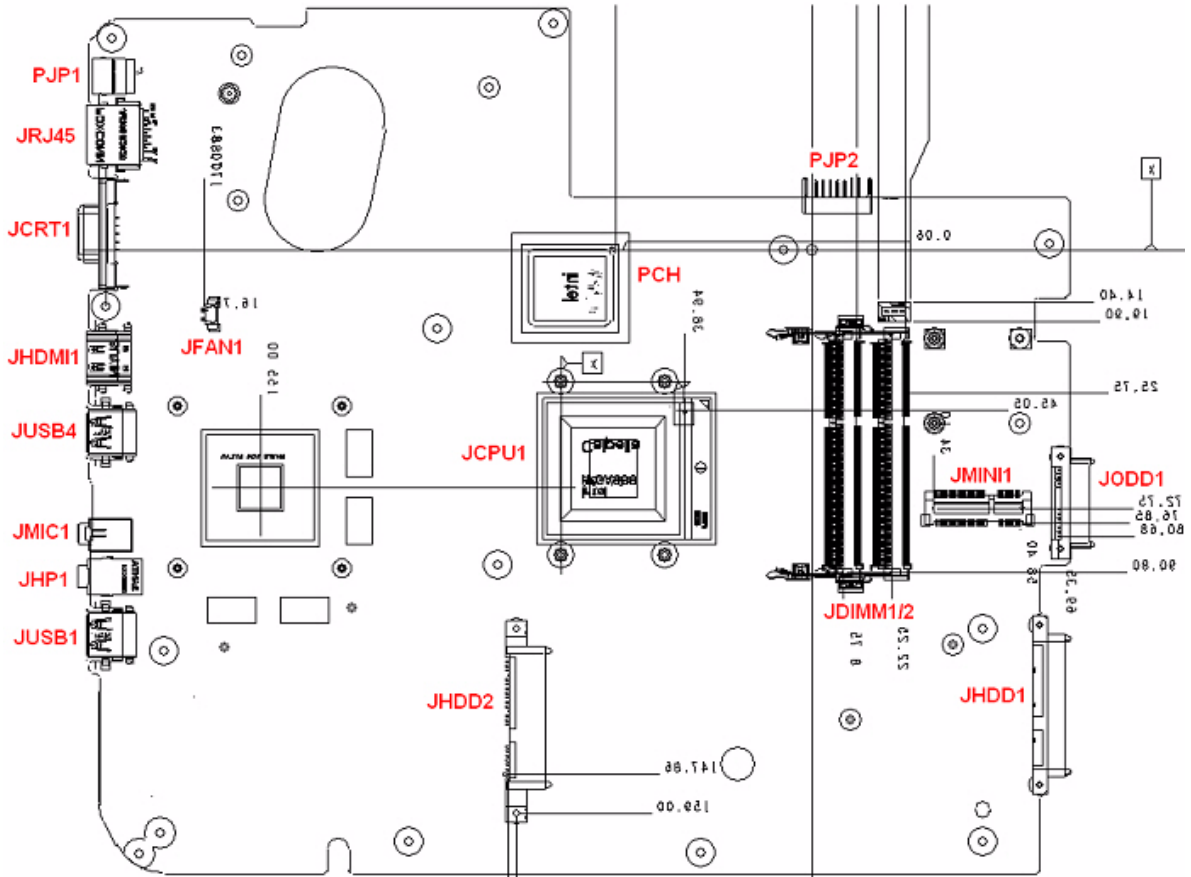

Item	Description
PJP2	Battery Connector
JMINI1	WLAN Connector
JODD1	ODD Connector
JHDD1	HDD Connector
JDIMM1/2	RAM Connector
JCPU1	CPU Socket
JHDD2	2nd HDD Connector
JFAN1	FAN Connector
JUSB1	USB Connector
JHP1	Head-Phone Jack
JMIC1	MIC-In Jack
JUSB4	USB Connector
JHDMI1	HDMI Connector
JCRT1	CRT Connector
JRJ45	RJ45 Connector
JRJ45	RJ45 Connector
PJP1	AC-IN Jack

## LS-5022P USB Board

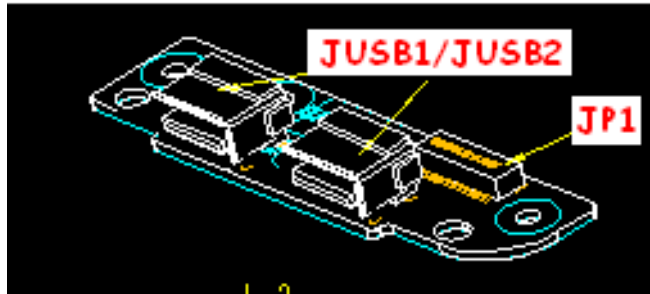

Item	Description
JUSB1/JUSB2	USB Connector
JP1	USB Board CONN

## LS-5024P Cap Sensor Board

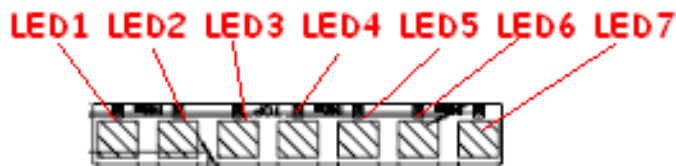

Item	Description
LED1	Power saving
LED2	Backup key
LED3	WLAN
LED4	TP Lock
LED5	Mute
LED6	VOL DOWN
LED7	VOL UP

## LS-5026P LED Board

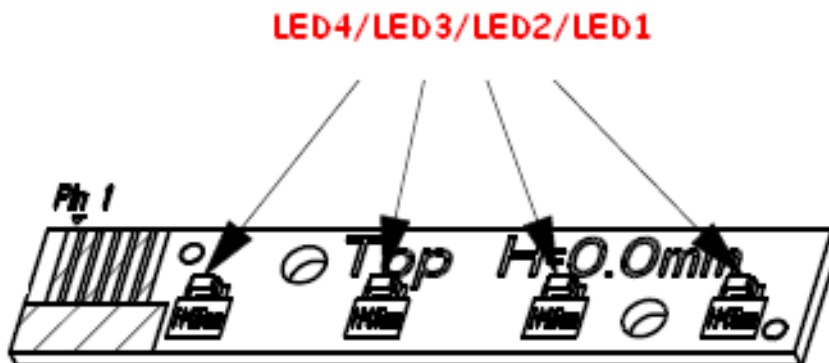

Item	Description
LED1	B/T LED

Item	Description
LED2	Num LED
LED3	Cap LED
LED4	Media LED

## LS-5027P SW Board

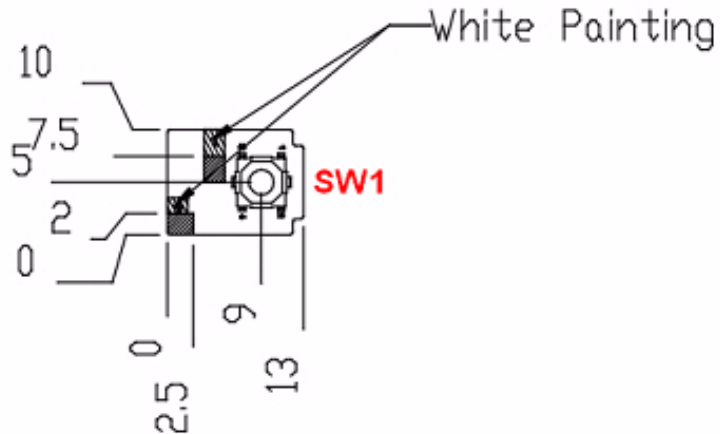

Item	Description
SW1	Power S/W

# Clearing Password Check and BIOS Recovery

This section provide you the standard operating procedures of clearing password and BIOS recovery for Packard Bell EasyNote LJ75/LJ77. Packard Bell EasyNote LJ75/LJ77 provides one Hardware Open Gap on main board for clearing password check, and one Hotkey for enabling BIOS Recovery.

## Clearing Password Check

Hardware Open Gap Description is as follows:

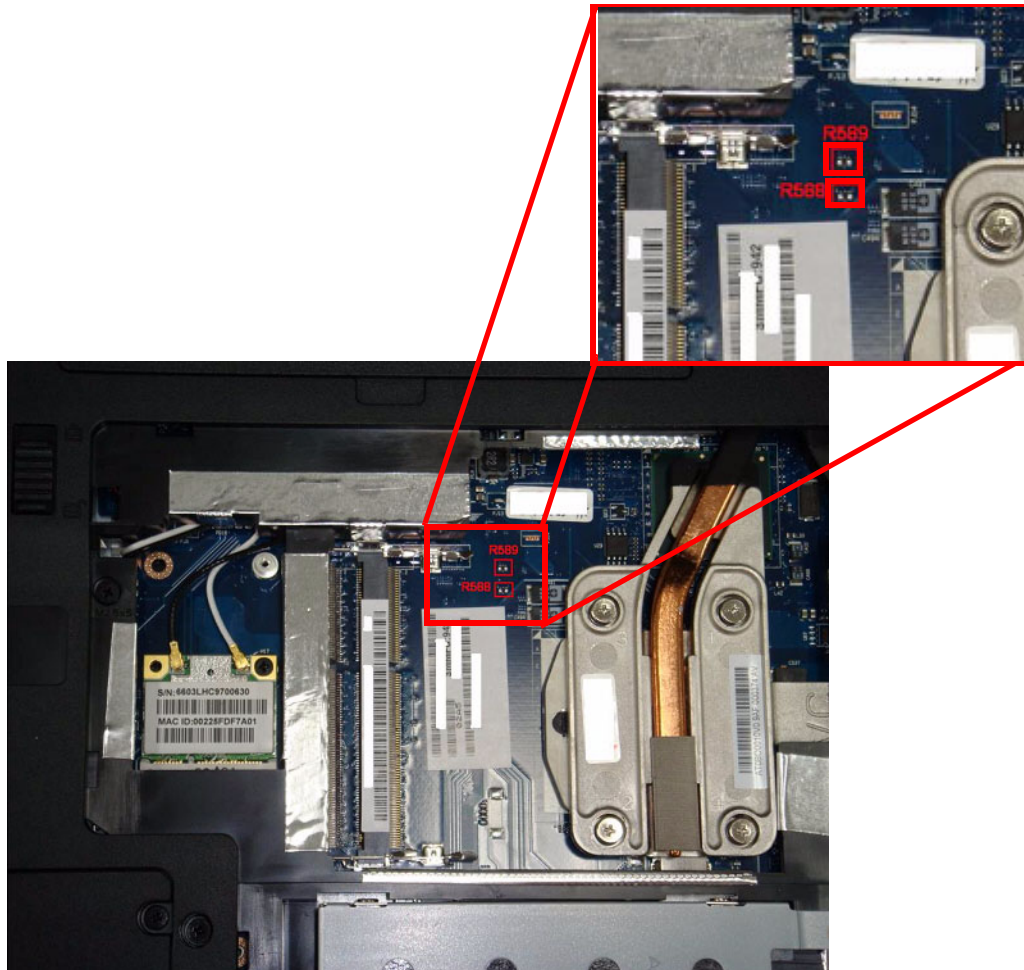

Item	Mark	Description	Location
R588	RTC_RST	Clear CMOS Jumper	Memory bay (near DDR socket)
R589	ME_RST		

## Steps for Clearing BIOS Password Check

If users set BIOS Password (Supervisor Password and/or User Password) for a security reason, BIOS will ask the password during systems POST or when systems enter to BIOS Setup menu. However, once it is necessary to bypass the password check, users need to short the HW Gap to clear the password by the following steps:

1. Power Off the system, and remove HDD, AC and Battery from the machine.
2. Open the back cover of the machine.
3. Disconnect the RTC Battery cable and locate the G1 jumper.

- 
4. Use an electric conductivity tool to short the two points of the HW Gap.
  5. Plug in AC, keep the short condition on the HW Gap, and press Power Button to power on the system till BIOS POST finish. Then remove the tool from the HW Gap.
  6. Restart system. Press **F2** key to enter BIOS Setup menu.
  7. If there is no Password request, BIOS Password is cleared. Otherwise, please follow the steps and try again.

**NOTE:** These steps are only for clearing BIOS Password (Supervisor Password and User Password).



---

# BIOS Recovery by Crisis Disk

## BIOS Recovery Boot Block:

BIOS Recovery Boot Block is a special block of BIOS. It is used to boot up the system with minimum BIOS initialization. Users can enable this feature to restore the BIOS firmware to a successful one once the previous BIOS flashing process failed.

## BIOS Recovery Hotkey:

The system provides a function hotkey: **Fn+Esc**, for enable BIOS Recovery process when system is powered on during BIOS POST. To use this function, it is strongly recommended to have the AC adapter and Battery present. If this function is enabled, the system will force the BIOS to enter a special BIOS block, called Boot Block.

## Steps for BIOS Recovery by USB flash crisis disk:

Before doing this, prepare the Crisis USB key. The Crisis USB key could be made by executing the Crisis Disk program in another system with Windows XP OS.

Follow the steps below:

1. Plug in the USB disk.
2. Launch the **wincris.exe** program to create a USB Crisis Disk. Click **Start** to initiate the process.
3. Select the **Quick Format** option to format the disk and click **Start**. Follow the instructions on the screen to create the disk.
4. Copy the **KAYFOX64.fd** BIOS file into USB flash disk root directory.

**NOTE:** Do not place any other \*.fd file in the USB flash disk root directory.

To use the Crisis USB key, do the following:

1. Plug USB storage into USB port.
2. Press **Fn + ESC** button then plug in AC power.  
The Power button flashes orange once.
3. Press **Power** button to initiate system CRISIS mode.  
When CRISIS is complete, the system auto restarts with a workable BIOS.
4. Update the latest version BIOS for this machine by regular BIOS flashing process.



## FRU (Field Replaceable Unit) List

---

This chapter gives you the FRU (Field Replaceable Unit) listing in global configurations of Packard Bell EasyNote LJ75/LJ77. Refer to this chapter whenever ordering for parts to repair or for RMA (Return Merchandise Authorization).

Please note that WHEN ORDERING FRU PARTS, you should check the most up-to-date information available on your regional web or channel. For whatever reasons a part number change is made, it will not be noted on the printed Service Guide. For ACER AUTHORIZED SERVICE PROVIDERS, your Acer office may have a DIFFERENT part number code from those given in the FRU list of this printed Service Guide. You MUST use the local FRU list provided by your regional Acer office to order FRU parts for repair and service of customer machines.

NOTE: To scrap or to return the defective parts, you should follow the local government ordinance or regulations on how to dispose it properly, or follow the rules set by your regional Acer office on how to return it.

# Packard Bell EasyNote LJ75/LJ77 Exploded Diagrams

## Main Assembly

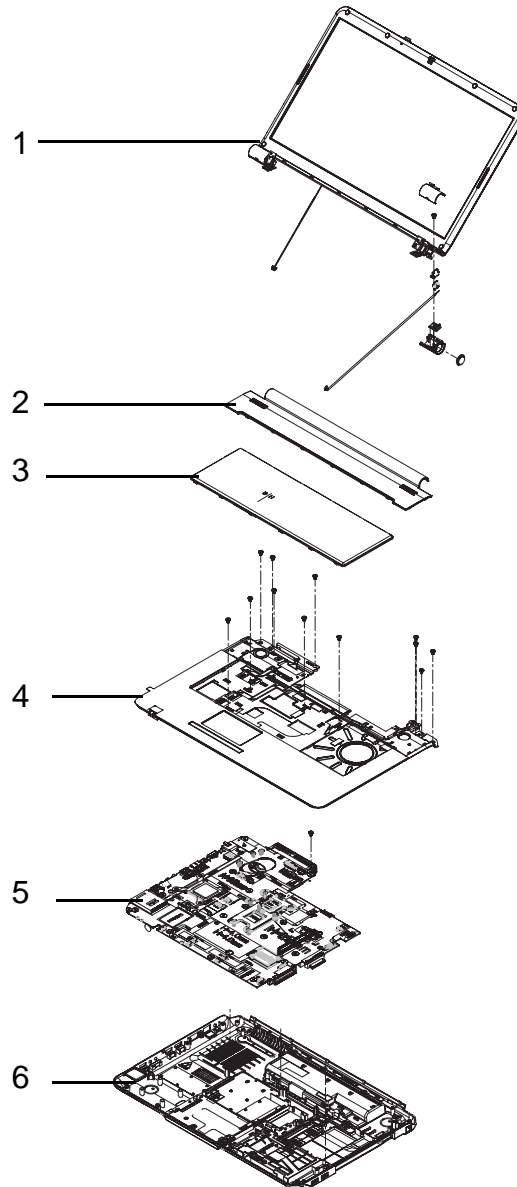

No.	Description	Acer P/N
1	LCD Assy	6M.BGB02.003
2	Middle Cover	60.WBV02.001
3	Keyboard	KB.I170G.111
4	Upper Cover	60.BE202.002
5	Mainboard	MB.WHH02.001
6	Lower Assy	60.WBF02.003

# Base Assembly

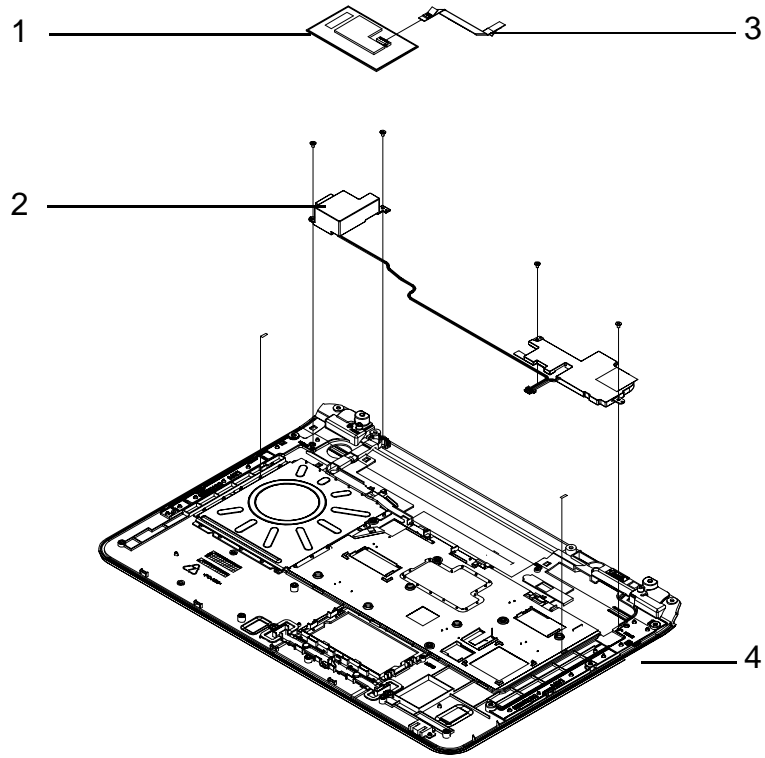

No.	Description	Acer P/N
1	Touchpad Bracket	33.WBF02.002
2	Speaker	23.WBF02.002
3	Touchpad FCC	50.WBF02.002
4	Upper Cover	60.BE202.002

# LCD Assembly

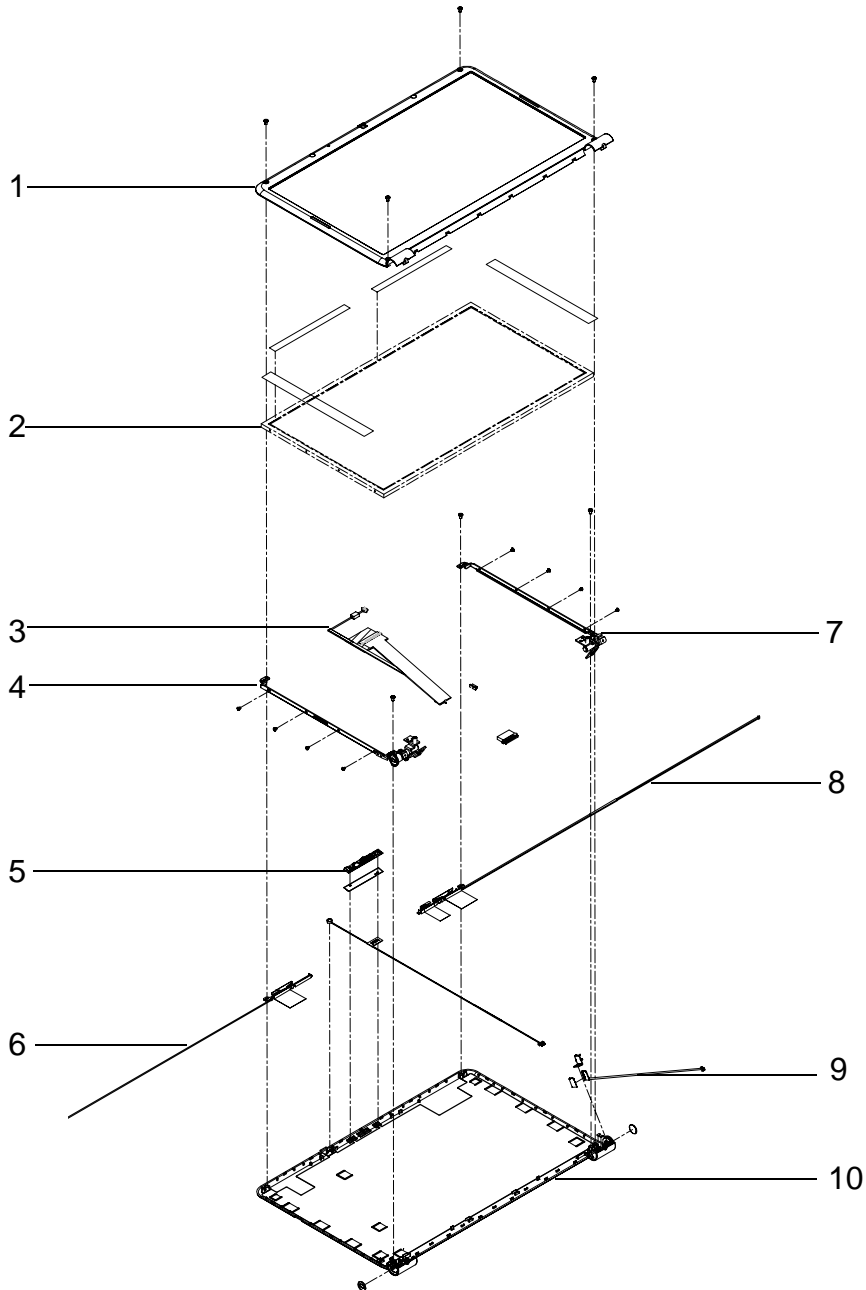







No.	Description	Acer P/N	No.	Description	Acer P/N
1	LCD Bezel	60.WBF02.008	6	Antenna (L)	50.WBF02.007
2	LCD Panel	LK.17305.001	7	Bracket (R)	33.WBF02.004
3	LVDS Cable	50.WBF02.008	8	Antenna (R)	50.WBF02.006
4	Bracket (L)	33.WBF02.004	9	Microphone Set	23.WBF02.001
5	Camera	57.WBF02.001	10	LCD Cover	60.B5602.001

# Packard Bell EasyNote LJ75/LJ77 FRU List



CATEGORY	Description	Part No.
<b>ADAPTER</b>		
	Adapter DELTA 65W 19V 1.7x5.5x11 Yellow ADP-65JH DB A, LV5 LED LF	AP.06501.026
	Adapter LITE-ON 65W 19V 1.7x5.5x11 Yellow PA-1650-22AC LV5 LED LF	AP.06503.024
	Adapter HIPRO 65W 19V 1.7x5.5x11 Yellow HP-A0652R3B 1LF, LV5 LED LF	AP.0650A.012
	Adapter DELTA 90W 19V 1.7x5.5x11 Blue ADP-90CD DB A, LV5 LED LF	AP.09001.027
	Adapter LITE-ON 90W 19V 1.7x5.5x11 Blue PA-1900-34AR, LV5 LED LF	AP.09003.021
<b>BATTERY</b>		
	Battery SANYO AS-2007B Li-Ion 3S2P SANYO 6 cell 4400mAh Main COMMON Normal Type	BT.00603.042
	Battery SONY AS-2007B Li-Ion 3S2P SONY 6 cell 4400mAh Main COMMON Normal Type	BT.00604.025
	Battery PANASONIC AS-2007B Li-Ion 3S2P PANASONIC 6 cell 4400mAh Main COMMON PSS	BT.00605.021
	Battery SIMPLO AS-2007B Li-Ion 3S2P SAMSUNG 6 cell 4400mAh Main COMMON SDI 2.2F	BT.00606.001
	Battery SIMPLO AS-2007B Li-Ion 3S2P PANASONIC 6 cell 4400mAh Main COMMON PSS	BT.00607.016
	Battery SANYO AS-2007B Li-Ion 4S2P SANYO 8 cell 4800mAh Main COMMON	BT.00803.024
	Battery SONY AS-2007B Li-Ion 4S2P SONY 8 cell 4800mAh Main COMMON	BT.00804.020
	Battery SIMPLO AS-2007B Li-Ion 4S2P PANASONIC 8 cell 4800mAh Main COMMON PSS	BT.00807.015
<b>BOARD</b>		
	Foxconn Bluetooth BRM 2046 BT2.1 (T60H928.33) f/w:861	BH.21100.004
	Lite-On Conexant -Unizion 1.5_3.3v AUS RD02-D330	FX.22500.021
	MEDIA BOARD	55.BGB02.001
	LED BOARD W/FFC	55.BGB02.002
	USB BOARD	55.BGB02.003
	POWER BOARD W/CABLE	55.BGB02.004

CATEGORY	Description	Part No.
	Foxconn Wireless LAN Atheros HB93 1x2 BGN (HM)	NI.23600.046
	Liteon Wireless LAN Atheris HB93 1x2 BGN (HM) WN6602AH	NI.23600.051
	Liteon Wireless LAN Realtek 8192SE BGN WN6603LH(2x2)	NI.23600.055
	Lan Intel WLAN 112BN.HMWG MM#903341	KI.CPH01.001
<b>CABLE</b>		
	BLUE TOOTH CABLE	50.WBF02.001
	T/P FFC	50.WBF02.002
	MEDIA BOARD FFC	50.WBF02.003
	USB CABLE	50.WBF02.004
	RJ11 CABLE	50.WBF02.005
	POWER CORD US 3 PIN	27.TAVV5.001
	POWER CORD EU 3 PIN	27.TAVV5.002
	POWER CORD AUS 3 PIN	27.TAVV5.003
	POWER CORD UK 3 PIN	27.TAVV5.004
	POWER CORD CHINA 3 PIN	27.TAVV5.005
	POWER CORD SWISS 3 PIN	27.TAVV5.006
	POWER CORD ITALIAN 3 PIN	27.TAVV5.007
	POWER CORD DENMARK 3 PIN	27.TAVV5.008
	POWER CORD JP 3 PIN	27.TAVV5.009
	POWER CORD SOUTH AFRICA 3 PIN	27.TAVV5.010
	POWER CORD KOERA 3 PIN	27.TAVV5.011
	POWER CORD ISRAEL 3 PIN	27.TAVV5.012
	POWER CORD INDIA 3 PIN	27.TAVV5.013
	POWER CORD TWN 3 PIN	27.TAVV5.014
POWER CORD ARGENTINA 3 PIN	27.APV02.001	
<b>CASE/COVER/BRACKET ASSEMBLY</b>		
	UPPER CASE ASSY-PB For WIN7, INCL. TP/TP MYLAR	60.BE202.002
	LOWER CASE DIS W/RJ11 F	60.WBF02.003
	LOWER CASE DIS W/O RJ11 F	60.WBF02.004
	LOWER CASE UMA W/RJ11 F	60.WBJ02.001
	LOWER CASE UMA W/O RJ11 F	60.WBJ02.002



CATEGORY	Description	Part No.
	MIDDLE COVER - For WIN 7	60.WBV02.001
	POWER BOARD BRACKET	33.WBF02.005
	TP BRACKET	33.WBF02.002
	MAIN HDD DOOR W/ RUBBER FOOT	42.WBF02.001
	HDD CARRIER	33.WBF02.001
	HDD DOOR FOR NB W/ 2 HDD	42.WBF02.002
<b>CPU/PROCESSOR</b>		
	CPU Intel Core i3 330M PGA 2.13G 35W Arrandale, TJ90, VT, 3M L3	KC.33001.DMP
	CPU Intel Core i5 430M PGA 2.26G ARD, up to SC 2.53G, 3M L3	KC.43001.DMP
	CPU Intel Core i5 520M 2.4G 3M	KC.52001.DMP
	CPU Intel Core i5 540M 2.53G 3M	KC.54001.DMP
<b>HDD/HARD DISK DRIVER</b>		
	HDD SEAGATE 2.5" 5400rpm 160GB ST9160314AS Wyatt SATA LF F/W:0001SDM1	KH.16001.042
	HDD HGST 2.5" 5400rpm 160GB HTS545016B9A300 Panther B SATA LF F/W:C60F	KH.16007.024
	HDD TOSHIBA 2.5" 5400rpm 160GB MK1655GSX Libra SATA LF F/W: FG011J	KH.16004.006
	HDD WD 2.5" 5400rpm 160GB WD1600BEVT-22ZCTO ML160 SATA LF F/W:11.01A11	KH.16008.022
	HDD SEAGATE 2.5" 5400rpm 250GB ST9250315AS Wyatt SATA LF F/W:0001SDM1	KH.25001.016
	HDD HGST 2.5" 5400rpm 250GB HTS545025B9A300 Panther B SATA LF F/W:C60F Disk imbalance criteria = 0.014g-cm	KH.25007.016
	HDD TOSHIBA 2.5" 5400rpm 250GB MK2555GSX Libra SATA LF F/W:FG001J	KH.25004.003
	HDD HGST 2.5" 5400rpm 250GB HTS545025B9A300 Panther B SATA LF F/W:C60F	KH.25007.015

CATEGORY	Description	Part No.
	HDD WD 2.5" 5400rpm 250GB WD2500BEVT-22ZCT0 ML160 SATA LF F/W:11.01A11	KH.25008.021
	HDD SEAGATE 2.5" 5400rpm 320GB ST9320325AS Wyatt SATA LF F/W:0001SDM1	KH.32001.017
	HDD HGST 2.5" 5400rpm 320GB HTS545032B9A300 Panther B SATA LF F/W: C60F	KH.32007.007
	HDD WD 2.5" 5400rpm 320GB WD3200BEVT-22ZCT0 ML160 SATA LF F/W:11.01A11	KH.32008.013
	HDD SEAGATE 2.5" 5400rpm 500GB ST9500325AS Wyatt SATA LF F/W:0001SDM1	KH.50001.011
	HDD TOSHIBA 2.5" 5400rpm 500GB MK5055GSX Libra SATA LF F/W:FG001J	KH.50004.001
	HDD HGST 2.5" 5400rpm 500GB HTS545050B9A300 Panther B SATA LF F/W:C60F	KH.50007.009
	HDD WD 2.5" 5400rpm 500GB WD5000BEVT-22ZAT0 ML250 SATA LF F/W:01.01A01	KH.50008.013
<b>MEMORY</b>		
	Memory SAMSUNG SO-DIMM DDRIII 1066 1GB M471B2873EH1-CF8 LF 64*16 0.055um	KN.1GB0B.028
	Memory MICRON SO-DIMM DDRIII 1066 1GB MT8JSF12864HZ-1G1F1 LF 128*8 0.065um	KN.1GB04.015
	Memory NANYA SO-DIMM DDRIII 1066 1GB NT1GC64BH8A1PS-BE LF 64*16 0.07um	KN.1GB03.031
	Memory ELPIDA SO-DIMM DDRIII 1066 1GB EBJ10UE8BDS0-AE-F LF 128*8 0.065um	KN.1GB09.012
	Memory HYNIX SO-DIMM DDRIII 1066 1GB HMT112S6BFR6C-G7 N0 LF 64*16 0.055um	KN.1GB0G.025
	Memory SAMSUNG SO-DIMM DDRIII 1066 2GB M471B5673EH1-CF8 LF 128*8 0.055um	KN.2GB0B.012
	Memory ELPIDA SO-DIMM DDRIII 1066 2GB EBJ21UE8BDS0-AE-F LF 128*8 0.065um	KN.2GB09.006
	Memory HYNIX SO-DIMM DDRIII 1066 2GB HMT125S6BFR8C-G7 N0 LF 128*8 0.055um	KN.2GB0G.014
<b>KEYBOARD</b>		
	Keyboard GATEWAY GP-7T Black SJV70 Internal 17 Standard 103KS Black US International	KB.1170G.111
	Keyboard GATEWAY GP-7T Black SJV70 Internal 17 Standard 103KS Black Greek	KB.1170G.096
	Keyboard GATEWAY GP-7T Black SJV70 Internal 17 Standard 103KS Black Arabic	KB.1170G.087
	Keyboard GATEWAY GP-7T Black SJV70 Internal 17 Standard 103KS Black Russian	KB.1170G.103
	Keyboard GATEWAY GP-7T Black SJV70 Internal 17 Standard 103KS Black Thailand	KB.1170G.108
	Keyboard GATEWAY GP-7T Black SJV70 Internal 17 Standard 103KS Black UK	KB.1170G.110
	Keyboard GATEWAY GP-7T Black SJV70 Internal 17 Standard 103KS Black German	KB.1170G.095

CATEGORY	Description	Part No.
	Keyboard GATEWAY GP-7T Black SJV70 Internal 17 Standard 103KS Black Swiss/G	KB.I170G.107
	Keyboard GATEWAY GP-7T Black SJV70 Internal 17 Standard 103KS Black CZ/SK	KB.I170G.090
	Keyboard GATEWAY GP-7T Black SJV70 Internal 17 Standard 103KS Black Belgium	KB.I170G.088
	Keyboard GATEWAY GP-7T Black SJV70 Internal 17 Standard 103KS Black Danish	KB.I170G.092
	Keyboard GATEWAY GP-7T Black SJV70 Internal 17 Standard 103KS Black Italian	KB.I170G.098
	Keyboard GATEWAY GP-7T Black SJV70 Internal 17 Standard 103KS Black French	KB.I170G.094
	Keyboard GATEWAY GP-7T Black SJV70 Internal 17 Standard 103KS Black Hungarian	KB.I170G.097
	Keyboard GATEWAY GP-7T Black SJV70 Internal 17 Standard 103KS Black Norwegian	KB.I170G.101
	Keyboard GATEWAY GP-7T Black SJV70 Internal 17 Standard 103KS Black Portuguese	KB.I170G.102
	Keyboard GATEWAY GP-7T Black SJV70 Internal 17 Standard 103KS Black Spanish	KB.I170G.105
	Keyboard GATEWAY GP-7T Black SJV70 Internal 17 Standard 103KS Black Turkish	KB.I170G.109
	Keyboard GATEWAY GP-7T Black SJV70 Internal 17 Standard 103KS Black Sweden	KB.I170G.106
	Keyboard GATEWAY GP-7T Black SJV70 Internal 17 Standard 103KS Black SLO/CRO	KB.I170G.104
	Keyboard GATEWAY GP-7T Black SJV70 Internal 17 Standard 103KS Black Nordic	KB.I170G.100
	Keyboard GATEWAY GP-7T Black SJV70 Internal 17 Standard 103KS Black Japanese	KB.I170G.099
<b>DVD-RW DRIVE</b>		
	ODD SUPER-MULTI DRIVE MODULE	6M.BGB02.001
	ODD TOSHIBA Super-Multi DRIVE 12.7mm Tray DL 8X TS-L633C LF W/O bezel SATA (HF + Windows 7)	KU.00801.035
	ODD PANASONIC Super-Multi DRIVE 12.7mm Tray DL 8X UJ890A LF W/O bezel SATA (HF + Windows 7)	KU.00807.070
	ODD HLDS Super-Multi DRIVE 12.7mm Tray DL 8X GT30N LF W/O bezel SATA (HF + Windows 7)	KU.0080D.048
	ODD SONY Super-Multi DRIVE 12.7mm Tray DL 8X AD-7585H LF W/O bezel SATA (HF + Windows 7)	KU.0080E.027
	ODD BEZEL-SUPER MULTI	42.WBF02.004
	ODD BRACKET	33.WBF02.003

CATEGORY	Description	Part No.
<b>BD COMBO MODULE</b>		
	ODD BD COMBO MODULE	6M.BGB02.002
	ODD PLDS BD COMBO 12.7mm Tray DL 4X DS-4E1S LF W/O bezel SATA (Windows 7)	KO.0040F.003
	ODD BEZEL-BD COMBO	42.WBF02.005
	ODD BRACKET	33.WBF02.003
<b>LCD</b>		
	ASSY LEC LCD MODULE 17.3" WXGA GLARE W/ ANTENNA *2, CAMERA, IMR, BLACK - PB	6M.BGB02.003
	ASSY LEC LCD MODULE 17.3" WXGA GLARE W/ ANTENNA *2, CAMERA, IMR, RED - PB	6M.BGC02.001
	ASSY LEC LCD MODULE 17.3" WXGA GLARE W/ ANTENNA *3, CAMERA, IMR, BLACK - PB	6M.BH302.001
	ASSY LEC LCD MODULE 17.3" WXGA GLARE W/ ANTENNA *3, CAMERA, IMR, RED - PB	6M.BH402.001
	ASSY LEC LCD MODULE 17.3" WXGA GLARE W/ ANTENNA *2, IMR, W/O CCD, BLACK - PB	6M.BGB02.004
	ASSY LEC LCD MODULE 17.3" WXGA GLARE W/ ANTENNA *2, IMR, W/O CCD, RED - PB	6M.BGC02.002
	ASSY LEC LCD MODULE 17.3" WXGA GLARE W/ ANTENNA *3, IMR, W/O CCD, BLACK - PB	6M.BH302.002
	ASSY LEC LCD MODULE 17.3" WXGA GLARE W/ ANTENNA *3, IMR, W/O CCD, RED - PB	6M.BH402.002
	LED LCD AUO 17.3" WXGA+ Glare B173RW01-V0 LF 220nit 8ms 600:1	LK.17305.001
	LED LCD SAMSUNG 17.3" WXGA+ Glare LTN173KT01-A01 LF 220nit 8ms 600:1	LK.17306.001
	LED LCD LPL 17.3" WXGA+ Glare LP173WD1-TLA1 LF 220nit 8ms 600:1	LK.17308.001
	LED LCD CMO 17.3" WXGA+ Glare N173O6-L02 LF 220nit 8ms 600:1	LK.1730D.001
	LED LCD AUO 17.3" WXGA+ Glare B173RW01-V3 LF 220nit 8ms 500:1	LK.17305.002
	LCD COVER IMR-PB BLACK	60.B5602.001
	LCD COVER IMR-PB RED	60.BE202.001
	LCD COVER IMR-PB BLACK	60.B5602.001
	ANTENNA MAIN (R -1X2)	50.WBF02.006

CATEGORY	Description	Part No.
	ANTENNA AUX (L)	50.WBF02.007
	LCD BEZEL	60.WBF02.008
	LVDS CABLE	50.WBF02.008
	LCD BRACKET R+L	33.WBF02.004
	CAMERA 0.3M	57.WBF02.001
<b>MAINBOARD</b>		
	Mainboard NV79/ENLJ75/ENLJ77 UMA Intel HM55 LF	MB.WHH02.001
	Mainboard NV79/ENLJ75/ENLJ77 Park XT 512MB VRAM Intel HM55 LF	MB.WHH02.003
	Mainboard NV79/ENLJ75/ENLJ77 Madison Pro 1GB VRAM Intel HM55 LF	MB.WHH02.002
<b>HEATSINK</b>		
	VGA THERMAL MODULE-PARK	60.BH302.001
	VGA THERMAL MODULE-MADISON	60.BG902.001
	CPU THERMAL MODULE	60.BGB02.001
	FAN-UMA	23.BGB02.001
<b>SPEAKER</b>		
	MIC SET	23.WBF02.001
	SPEAKER	23.WBF02.002
<b>MISCELLANEOUS</b>		
	BATTERY MYLAR	42.WBF02.003
	RUBBER FOOT	47.WBF02.002
	NAME PLATE-ENLJ77	40.BGC02.001

CATEGORY	Description	Part No.
	NAME PLATE-ENLJ75	40.BH302.001
	LCD SCREW RUBBER	47.WBF02.001
	PVC MYLAR FOR LCD COVER-LEFT	47.WBU02.001

## Screw List

CATEGORY	Description	Part No.
<b>SCREW</b>		
	SCREW M2.45D 8.0L K 5.5D 0.8T ZKNL	86.WBF02.001
	SCREW M2.5D 5L K 5.5D ZK NL + CR3	86.WBF02.010
	SCREW M2.46D 3.0L K 5.5D 0.8T ZKNL	86.WBF02.002
	SCREW M1.98D 3.0L K 4.6D 0.8T ZKNL	86.WBF02.003
	SCREW M2.5D 4.15L K 5.5D ZK NL CR3	86.WBF02.004
	SCREW M3.0D 3.0L K 4.9D NI	86.WBF02.005
	SCREW M2.5D 3.2L K 6D NI	86.WBF02.006
	SCREW M2D 4.0L K 4.6D NI NL	86.WBF02.007
	SCREW M2.0D 3L K 5D NI	86.WBF02.008
	SCREW ASSY THML SPRING	86.WBF02.009



# Model Definition and Configuration

## Packard Bell EasyNote LJ75 Series

Model	Acer Part No	RO	Country	Description
ENLJ75-334G64Mn	LX.BG902.005	EMEA	Spain	ENLJ75-334G64Mn W7HP64BTES1 MADISON_PRO1GBCck_V3 2*2G/640/6L2.2/ 5R/CB_GN_0.3D_GEk_ESA2 EASYNOTE_LJ75-JN-332SP
ENLJ75-434G50Mn	LX.BG902.004	EMEA	Spain	ENLJ75-434G50Mn W7HP64BTES1 MADISON_PRO1GBCck_V3 2*2G/500_L/ 6L2.2/5R/CB_GN_0.3D_GEk_ESA2 EASYNOTE_LJ75-JO-431SP
ENLJ75-436G50Bn	LX.BG902.014	EMEA	Germany	ENLJ75-436G50Bn W7HP64BTDE1 MADISON_PRO1GBCck_V3 2G+4G/500_L/ 6L2.2/5R/CB_bgn_0.3D_GEk_DE43 EASYNOTE_LJ75-JO-075GE
ENLJ75-434G1TMn	LX.BG902.001	EMEA	France	ENLJ75-434G1TMn W7HP64BTFR1 MADISON_PRO1GBCck_V3 2*2G/ 500_L+500_L/6L2.2/5R/ CB_GN_0.3D_GEk_FR51 EASYNOTE_LJ75- JO-230FR
ENLJ75-434G1TBn	LX.BG902.008	EMEA	France	ENLJ75-434G1TBn W7HP64BTFR1 MADISON_PRO1GBCck_V3 2*2G/ 500_L+500_L/6L2.2/5R/ CB_GN_0.3D_GEk_FR51 EASYNOTE_LJ75- JO-257FR
ENLJ75-436G64Mn	LX.BG902.013	EMEA	Greece	ENLJ75-436G64Mn W7HP64BTGR1 MADISON_PRO1GBCck_V3 2G+4G/640/BT/ 6L2.2/5R/CB_GN_0.3D_GEk_EL43 EASYNOTE_LJ75-JO-201GR
ENLJ75-434G50Mn	LX.BG902.012	EMEA	Greece	ENLJ75-434G50Mn W7HP64BTGR1 MADISON_PRO1GBCck_V3 2*2G/500_L/BT/ 6L2.2/5R/CB_GN_0.3D_GEk_EL43 EASYNOTE_LJ75-JO-110GR
ENLJ75-544G50Mn	S2.BG902.001	WW	WW	ENLJ75-544G50Mn W7HP64BWW2 MADISON_PRO1GBCck_V3 2*2G/500_L/BT/ 6L2.2/5R/CB_GN_0.3D_GEk_EN11
ENLJ75-434G64Mn	LX.BG902.011	EMEA	Nordic	ENLJ75-434G64Mn W7HP64BTND1 MADISON_PRO1GBCck_V3 2*2G/640/6L2.2/ 5R/CB_GN_0.3D_GEk_ENU3 EASYNOTE_LJ75-JO-250NC
ENLJ75-334G64Mn	LX.BG902.010	EMEA	France	ENLJ75-334G64Mn W7HP64BTFR1 MADISON_PRO1GBCck_V3 2*2G/640/6L2.2/ 5R/CB_GN_0.3D_GEk_FR51 EASYNOTE_LJ75-JN-255FR
ENLJ75-334G50Mn	LX.BG902.002	EMEA	Portugal	ENLJ75-334G50Mn W7HP64BTPT1 MADISON_PRO1GBCck_V3 2*2G/500_L/ 6L2.2/5R/CB_GN_0.3D_GEk_PT43 EASYNOTE_LJ75-JN-332PT



Model	Acer Part No	RO	Country	Description
ENLJ75-434G32Mn	LX.BG902.009	EMEA	Italy	ENLJ75-434G32Mn W7HP64BTIT1 MADISON_PRO1GBCkk_V3 2*2G/320/6L2.2/ 5R/CB_GN_0.3D_GEk_IT71 EASYNOTE_LJ75-JO-110IT
ENLJ75-434G50Mn	LX.BG902.007	EMEA	France	ENLJ75-434G50Mn W7HP64BTFR1 MADISON_PRO1GBCkk_V3 2*2G/500_L/ 6L2.2/5R/CB_GN_0.3D_GEk_FR51 EASYNOTE_LJ75-JO-256FR
ENLJ75-624G50Mn	LX.BG902.006	EMEA	France	ENLJ75-624G50Mn W7HP64BTFR1 MADISON_PRO1GBCkk_V3 2*2G/500_L/ 6L2.2/5R/CB_GN_0.3D_GEk_FR51 EASYNOTE_LJ75-JP-258FR
ENLJ75-434G64Mn	LX.BG902.003	EMEA	Spain	ENLJ75-434G64Mn W7HP64BTES1 MADISON_PRO1GBCkk_V3 2*2G/640/6L2.2/ 5R/CB_GN_0.3D_GEk_ESA2 EASYNOTE_LJ75-JO-432SP
ENLJ75-524G50Mi	S2.BG902.002	WW	WW	ENLJ75-524G50Mi W7HP64BWW2 MADISON_PRO1GBCkk_V3 2*2G/500_L/BT/ 8L2.4/5R/CB_abgn_0.3D_GEk_EN11
ENLJ75-434G82Mn	LX.BH302.010	EMEA	France	ENLJ75-434G82Mn W7HP64BTFR1 PARK_XT512Ckk_V3 2*2G/500_L+320/6L2.2/ 5R/CB_bgn_0.3D_GEk_FR51 EASYNOTE_LJ75-JO-264FR
ENLJ75-338G50Mn	LX.BH302.005	EMEA	Switzerland	ENLJ75-338G50Mn W7HP64BTCH1 PARK_XT512Ckk_V3 2*4G/500_L/6L2.2/5R/ CB_bgn_0.3D_GEk_SW23 EASYNOTE_LJ75-JN-335CH
ENLJ75-436G50Mn	LX.BH302.009	EMEA	Italy	ENLJ75-436G50Mn W7HP64BTIT1 PARK_XT512Ckk_V3 2G+4G/500_L/6L2.2/ 5R/CB_bgn_0.3D_GEk_IT71 EASYNOTE_LJ75-JO-111IT
ENLJ75-434G64Mn	LX.BH302.008	EMEA	Spain	ENLJ75-434G64Mn W7HP64BTES1 PARK_XT512Ckk_V3 2*2G/640/6L2.2/5R/ CB_bgn_0.3D_GEk_ESA2 EASYNOTE_LJ75- JO-433SP
ENLJ75-434G50Mn	LX.BH302.004	EMEA	Switzerland	ENLJ75-434G50Mn W7HP64BTCH1 PARK_XT512Ckk_V3 2*2G/500_L/6L2.2/5R/ CB_GN_0.3D_GEk_SW23 EASYNOTE_LJ75- JO-545CH
ENLJ75-333G32Mi	LX.BH302.007	EMEA	Russia	ENLJ75-333G32Mi W7HP64RUBTRU2 PARK_XT512Ckk_V3 1G+2G/320/BT/6L2.2/ 5R/CB_bg_0.3D_GEk_RU41 EASYNOTE_LJ75-JN-101RU
ENLJ75-434G32Bn	LX.BH302.006	EMEA	Germany	ENLJ75-434G32Bn W7HP64BTDE1 PARK_XT512Ckk_V3 2*2G/320/6L2.2/5R/ CB_bgn_0.3D_GEk_DE43 EASYNOTE_LJ75- JO-076GE
ENLJ75-434G50Mn	LX.BH302.003	EMEA	UK	ENLJ75-434G50Mn W7HP64BTGB1 PARK_XT512Ckk_V3 2*2G/500_L/6L2.2/5R/ CB_GN_0.3D_GEk_EN13 EASYNOTE_LJ75- JO-080UK

Model	Acer Part No	RO	Country	Description
ENLJ75-334G50Mn	LX.BH302.002	EMEA	France	ENLJ75-334G50Mn W7HP64BTFR1 PARK_XT512Ckk_V3 2*2G/500_L/6L2.2/5R/ CB_GN_0.3D_GEk_FR51 EASYNOTE_LJ75- JN-253FR
ENLJ75-434G32Mn	LX.BH302.001	EMEA	Germany	ENLJ75-434G32Mn W7HP64BTDE1 PARK_XT512Ckk_V3 2*2G/320/BT/6L2.2/5R/ CB_GN_0.3D_GEk_DE43 EASYNOTE_LJ75- JO-070GE
ENLJ75-544G32Mi	S2.BH302.001	WW	WW	ENLJ75-544G32Mi W7HP64BWW2 PARK_XT512Ckk_V3 2*2G/320/BT/6L2.2/5R/ CB_abgn_0.3D_GEk_EN11
ENLJ75-334G32Mn	LX.BGB02.005	EMEA	UK	ENLJ75-334G32Mn W7HP64BTGB1 UMACKk 2*2G/320/6L2.2/5R/CB_bgn_0.3D_GEk_EN13 EASYNOTE_LJ75-GN-020UK
ENLJ75-334G32Mn	LX.BGB02.004	EMEA	Germany	ENLJ75-334G32Mn W7HP64BTDE1 UMACKk 2*2G/320/6L2.2/5R/CB_GN_0.3D_GEk_DE43 EASYNOTE_LJ75-GN-071GE
ENLJ75-334G50Mn	LX.BGB02.001	EMEA	UK	ENLJ75-334G50Mn W7HP64BTGB1 UMACKk 2*2G/500_L/6L2.2/5R/ CB_GN_0.3D_GEk_EN13
ENLJ75-334G50Mn	LX.BGB02.002	EMEA	France	ENLJ75-334G50Mn W7HP64BTFR1 UMACKk 2*2G/500_L/6L2.2/5R/ CB_GN_0.3D_GEk_FR51 EASYNOTE_LJ75- GN-250FR
ENLJ75-334G32Mn	LX.BGB02.003	EMEA	Spain	ENLJ75-334G32Mn W7HP64BTES1 UMACKk 2*2G/320/6L2.2/5R/CB_GN_0.3D_GEk_ESA2 EASYNOTE_LJ75-GN-330SP
ENLJ75-544G32Bi	S2.BGB02.001	WW	WW	ENLJ75-544G32Bi W7HP64BWW2 UMACKk 2*2G/320/BT/6L2.2/5R/ CB_abgn_0.3D_GEk_EN11

Model	Acer Part No	CPU	LCD	VGA Chip	VRAM 1
ENLJ75-334G64Mn	LX.BG902.005	Ci3330M	NLED17.3W XGA+G	MADISON_PRO	1G-DDR3 (64*16*8)
ENLJ75-434G50Mn	LX.BG902.004	Ci5430M	NLED17.3W XGA+G	MADISON_PRO	1G-DDR3 (64*16*8)
ENLJ75-436G50Bn	LX.BG902.014	Ci5430M	NLED17.3W XGA+G	MADISON_PRO	1G-DDR3 (64*16*8)
ENLJ75-434G1TMn	LX.BG902.001	Ci5430M	NLED17.3W XGA+G	MADISON_PRO	1G-DDR3 (64*16*8)
ENLJ75-434G1TBn	LX.BG902.008	Ci5430M	NLED17.3W XGA+G	MADISON_PRO	1G-DDR3 (64*16*8)
ENLJ75-436G64Mn	LX.BG902.013	Ci5430M	NLED17.3W XGA+G	MADISON_PRO	1G-DDR3 (64*16*8)
ENLJ75-434G50Mn	LX.BG902.012	Ci5430M	NLED17.3W XGA+G	MADISON_PRO	1G-DDR3 (64*16*8)
ENLJ75-544G50Mn	S2.BG902.001	Ci5540M	NLED17.3W XGA+G	MADISON_PRO	1G-DDR3 (64*16*8)
ENLJ75-434G64Mn	LX.BG902.011	Ci5430M	NLED17.3W XGA+G	MADISON_PRO	1G-DDR3 (64*16*8)

Model	Acer Part No	CPU	LCD	VGA Chip	VRAM 1
ENLJ75-334G64Mn	LX.BG902.010	Ci3330M	NLED17.3W XGA+G	MADISON_PRO	1G-DDR3 (64*16*8)
ENLJ75-334G50Mn	LX.BG902.002	Ci3330M	NLED17.3W XGA+G	MADISON_PRO	1G-DDR3 (64*16*8)
ENLJ75-434G32Mn	LX.BG902.009	Ci5430M	NLED17.3W XGA+G	MADISON_PRO	1G-DDR3 (64*16*8)
ENLJ75-434G50Mn	LX.BG902.007	Ci5430M	NLED17.3W XGA+G	MADISON_PRO	1G-DDR3 (64*16*8)
ENLJ75-624G50Mn	LX.BG902.006	Ci7620M	NLED17.3W XGA+G	MADISON_PRO	1G-DDR3 (64*16*8)
ENLJ75-434G64Mn	LX.BG902.003	Ci5430M	NLED17.3W XGA+G	MADISON_PRO	1G-DDR3 (64*16*8)
ENLJ75-524G50Mi	S2.BG902.002	Ci5520M	NLED17.3W XGA+G	MADISON_PRO	1G-DDR3 (64*16*8)
ENLJ75-434G82Mn	LX.BH302.010	Ci5430M	NLED17.3W XGA+G	PARK_XT	512M-DDR3 (64*16*4)
ENLJ75-338G50Mn	LX.BH302.005	Ci3330M	NLED17.3W XGA+G	PARK_XT	512M-DDR3 (64*16*4)
ENLJ75-436G50Mn	LX.BH302.009	Ci5430M	NLED17.3W XGA+G	PARK_XT	512M-DDR3 (64*16*4)
ENLJ75-434G64Mn	LX.BH302.008	Ci5430M	NLED17.3W XGA+G	PARK_XT	512M-DDR3 (64*16*4)
ENLJ75-434G50Mn	LX.BH302.004	Ci5430M	NLED17.3W XGA+G	PARK_XT	512M-DDR3 (64*16*4)
ENLJ75-333G32Mi	LX.BH302.007	Ci3330M	NLED17.3W XGA+G	PARK_XT	512M-DDR3 (64*16*4)
ENLJ75-434G32Bn	LX.BH302.006	Ci5430M	NLED17.3W XGA+G	PARK_XT	512M-DDR3 (64*16*4)
ENLJ75-434G50Mn	LX.BH302.003	Ci5430M	NLED17.3W XGA+G	PARK_XT	512M-DDR3 (64*16*4)
ENLJ75-334G50Mn	LX.BH302.002	Ci3330M	NLED17.3W XGA+G	PARK_XT	512M-DDR3 (64*16*4)
ENLJ75-434G32Mn	LX.BH302.001	Ci5430M	NLED17.3W XGA+G	PARK_XT	512M-DDR3 (64*16*4)
ENLJ75-544G32Mi	S2.BH302.001	Ci5540M	NLED17.3W XGA+G	PARK_XT	512M-DDR3 (64*16*4)
ENLJ75-334G32Mn	LX.BGB02.005	Ci3330M	NLED17.3W XGA+G	UMA	N
ENLJ75-334G32Mn	LX.BGB02.004	Ci3330M	NLED17.3W XGA+G	UMA	N
ENLJ75-334G50Mn	LX.BGB02.001	Ci3330M	NLED17.3W XGA+G	UMA	N
ENLJ75-334G50Mn	LX.BGB02.002	Ci3330M	NLED17.3W XGA+G	UMA	N
ENLJ75-334G32Mn	LX.BGB02.003	Ci3330M	NLED17.3W XGA+G	UMA	N
ENLJ75-544G32Bi	S2.BGB02.001	Ci5540M	NLED17.3W XGA+G	UMA	N

Model	Acer Part No	Memory 1	Memory 2	Memory 3	Memory 4	HDD 1(GB)
ENLJ75-334G64Mn	LX.BG902.005	SO2GBIII10	SO2GBIII10	N	N	N640GB5.4KS
ENLJ75-434G50Mn	LX.BG902.004	SO2GBIII10	SO2GBIII10	N	N	N500GB5.4KS
ENLJ75-436G50Bn	LX.BG902.014	SO2GBIII10	SO4GBIII10	N	N	N500GB5.4KS
ENLJ75-434G1TMn	LX.BG902.001	SO2GBIII10	SO2GBIII10	N	N	N500GB5.4KS
ENLJ75-434G1TBn	LX.BG902.008	SO2GBIII10	SO2GBIII10	N	N	N500GB5.4KS
ENLJ75-436G64Mn	LX.BG902.013	SO2GBIII10	SO4GBIII10	N	N	N640GB5.4KS
ENLJ75-434G50Mn	LX.BG902.012	SO2GBIII10	SO2GBIII10	N	N	N500GB5.4KS
ENLJ75-544G50Mn	S2.BG902.001	SO2GBIII10	SO2GBIII10	N	N	N500GB5.4KS
ENLJ75-434G64Mn	LX.BG902.011	SO2GBIII10	SO2GBIII10	N	N	N640GB5.4KS
ENLJ75-334G64Mn	LX.BG902.010	SO2GBIII10	SO2GBIII10	N	N	N640GB5.4KS
ENLJ75-334G50Mn	LX.BG902.002	SO2GBIII10	SO2GBIII10	N	N	N500GB5.4KS
ENLJ75-434G32Mn	LX.BG902.009	SO2GBIII10	SO2GBIII10	N	N	N320GB5.4KS
ENLJ75-434G50Mn	LX.BG902.007	SO2GBIII10	SO2GBIII10	N	N	N500GB5.4KS
ENLJ75-624G50Mn	LX.BG902.006	SO2GBIII10	SO2GBIII10	N	N	N500GB5.4KS
ENLJ75-434G64Mn	LX.BG902.003	SO2GBIII10	SO2GBIII10	N	N	N640GB5.4KS
ENLJ75-524G50Mi	S2.BG902.002	SO2GBIII10	SO2GBIII10	N	N	N500GB5.4KS
ENLJ75-434G82Mn	LX.BH302.010	SO2GBIII10	SO2GBIII10	N	N	N500GB5.4KS
ENLJ75-338G50Mn	LX.BH302.005	SO4GBIII10	SO4GBIII10	N	N	N500GB5.4KS
ENLJ75-436G50Mn	LX.BH302.009	SO2GBIII10	SO4GBIII10	N	N	N500GB5.4KS
ENLJ75-434G64Mn	LX.BH302.008	SO2GBIII10	SO2GBIII10	N	N	N640GB5.4KS
ENLJ75-434G50Mn	LX.BH302.004	SO2GBIII10	SO2GBIII10	N	N	N500GB5.4KS
ENLJ75-333G32Mi	LX.BH302.007	SO1GBIII10	SO2GBIII10	N	N	N320GB5.4KS
ENLJ75-434G32Bn	LX.BH302.006	SO2GBIII10	SO2GBIII10	N	N	N320GB5.4KS
ENLJ75-434G50Mn	LX.BH302.003	SO2GBIII10	SO2GBIII10	N	N	N500GB5.4KS

Model	Acer Part No	Memory 1	Memory 2	Memory 3	Memory 4	HDD 1(GB)
ENLJ75-334G50Mn	LX.BH302.002	SO2GBIII10	SO2GBIII10	N	N	N500GB5.4KS
ENLJ75-434G32Mn	LX.BH302.001	SO2GBIII10	SO2GBIII10	N	N	N320GB5.4KS
ENLJ75-544G32Mi	S2.BH302.001	SO2GBIII10	SO2GBIII10	N	N	N320GB5.4KS
ENLJ75-334G32Mn	LX.BGB02.005	SO2GBIII10	SO2GBIII10	N	N	N320GB5.4KS
ENLJ75-334G32Mn	LX.BGB02.004	SO2GBIII10	SO2GBIII10	N	N	N320GB5.4KS
ENLJ75-334G50Mn	LX.BGB02.001	SO2GBIII10	SO2GBIII10	N	N	N500GB5.4KS
ENLJ75-334G50Mn	LX.BGB02.002	SO2GBIII10	SO2GBIII10	N	N	N500GB5.4KS
ENLJ75-334G32Mn	LX.BGB02.003	SO2GBIII10	SO2GBIII10	N	N	N320GB5.4KS
ENLJ75-544G32Bi	S2.BGB02.001	SO2GBIII10	SO2GBIII10	N	N	N320GB5.4KS

Model	Acer Part No	HDD 2(GB)	ODD	Media Processor	Extra SW1	Card Reader
ENLJ75-334G64Mn	LX.BG902.005	N	NSM8XS	N	NIS	5 in 1-Build in
ENLJ75-434G50Mn	LX.BG902.004	N	NSM8XS	N	NIS	5 in 1-Build in
ENLJ75-436G50Bn	LX.BG902.014	N	NBDCB4XS	N	NIS	5 in 1-Build in
ENLJ75-434G1TMn	LX.BG902.001	N500GB5.4KS	NSM8XS	N	NIS	5 in 1-Build in
ENLJ75-434G1TBn	LX.BG902.008	N500GB5.4KS	NBDCB4XS	N	NIS	5 in 1-Build in
ENLJ75-436G64Mn	LX.BG902.013	N	NSM8XS	N	NIS	5 in 1-Build in
ENLJ75-434G50Mn	LX.BG902.012	N	NSM8XS	N	NIS	5 in 1-Build in
ENLJ75-544G50Mn	S2.BG902.001	N	NSM8XS	N	NIS	5 in 1-Build in
ENLJ75-434G64Mn	LX.BG902.011	N	NSM8XS	N	NIS	5 in 1-Build in
ENLJ75-334G64Mn	LX.BG902.010	N	NSM8XS	N	NIS	5 in 1-Build in
ENLJ75-334G50Mn	LX.BG902.002	N	NSM8XS	N	NIS	5 in 1-Build in
ENLJ75-434G32Mn	LX.BG902.009	N	NSM8XS	N	NIS	5 in 1-Build in
ENLJ75-434G50Mn	LX.BG902.007	N	NSM8XS	N	NIS	5 in 1-Build in

Model	Acer Part No	HDD 2(GB)	ODD	Media Processor	Extra SW1	Card Reader
ENLJ75-624G50Mn	LX.BG902.006	N	NSM8XS	N	NIS	5 in 1-Build in
ENLJ75-434G64Mn	LX.BG902.003	N	NSM8XS	N	NIS	5 in 1-Build in
ENLJ75-524G50Mi	S2.BG902.002	N	NSM8XS	N	NIS	5 in 1-Build in
ENLJ75-434G82Mn	LX.BH302.010	N320GB5.4KS	NSM8XS	N	NIS	5 in 1-Build in
ENLJ75-338G50Mn	LX.BH302.005	N	NSM8XS	N	NIS	5 in 1-Build in
ENLJ75-436G50Mn	LX.BH302.009	N	NSM8XS	N	NIS	5 in 1-Build in
ENLJ75-434G64Mn	LX.BH302.008	N	NSM8XS	N	NIS	5 in 1-Build in
ENLJ75-434G50Mn	LX.BH302.004	N	NSM8XS	N	NIS	5 in 1-Build in
ENLJ75-333G32Mi	LX.BH302.007	N	NSM8XS	N	NIS	5 in 1-Build in
ENLJ75-434G32Bn	LX.BH302.006	N	NBDCB4XS	N	NIS	5 in 1-Build in
ENLJ75-434G50Mn	LX.BH302.003	N	NSM8XS	N	NIS	5 in 1-Build in
ENLJ75-334G50Mn	LX.BH302.002	N	NSM8XS	N	NIS	5 in 1-Build in
ENLJ75-434G32Mn	LX.BH302.001	N	NSM8XS	N	NIS	5 in 1-Build in
ENLJ75-544G32Mi	S2.BH302.001	N	NSM8XS	N	NIS	5 in 1-Build in
ENLJ75-334G32Mn	LX.BGB02.005	N	NSM8XS	N	NIS	5 in 1-Build in
ENLJ75-334G32Mn	LX.BGB02.004	N	NSM8XS	N	NIS	5 in 1-Build in
ENLJ75-334G50Mn	LX.BGB02.001	N	NSM8XS	N	NIS	5 in 1-Build in
ENLJ75-334G50Mn	LX.BGB02.002	N	NSM8XS	N	NIS	5 in 1-Build in
ENLJ75-334G32Mn	LX.BGB02.003	N	NSM8XS	N	NIS	5 in 1-Build in
ENLJ75-544G32Bi	S2.BGB02.001	N	NBDCB4XS	N	NIS	5 in 1-Build in

Model	Acer Part No	Wireless LAN1	Bluetooth	VOIP Phone	Finger Print	NB Chipset
ENLJ75-334G64Mn	LX.BG902.005	3rd WiFi 2x2 BGN	N	N	N	HM55
ENLJ75-434G50Mn	LX.BG902.004	3rd WiFi 2x2 BGN	N	N	N	HM55

Model	Acer Part No	Wireless LAN1	Bluetooth	VOIP Phone	Finger Print	NB Chipset
ENLJ75-436G50Bn	LX.BG902.014	3rd WiFi 2x2 BGN	N	N	N	HM55
ENLJ75-434G1TMn	LX.BG902.001	3rd WiFi 2x2 BGN	N	N	N	HM55
ENLJ75-434G1TBn	LX.BG902.008	3rd WiFi 2x2 BGN	N	N	N	HM55
ENLJ75-436G64Mn	LX.BG902.013	3rd WiFi 2x2 BGN	BT 2.1	N	N	HM55
ENLJ75-434G50Mn	LX.BG902.012	3rd WiFi 2x2 BGN	BT 2.1	N	N	HM55
ENLJ75-544G50Mn	S2.BG902.001	3rd WiFi 2x2 BGN	BT 2.1	N	N	HM55
ENLJ75-434G64Mn	LX.BG902.011	3rd WiFi 2x2 BGN	N	N	N	HM55
ENLJ75-334G64Mn	LX.BG902.010	3rd WiFi 2x2 BGN	N	N	N	HM55
ENLJ75-334G50Mn	LX.BG902.002	3rd WiFi 2x2 BGN	N	N	N	HM55
ENLJ75-434G32Mn	LX.BG902.009	3rd WiFi 2x2 BGN	N	N	N	HM55
ENLJ75-434G50Mn	LX.BG902.007	3rd WiFi 2x2 BGN	N	N	N	HM55
ENLJ75-624G50Mn	LX.BG902.006	3rd WiFi 2x2 BGN	N	N	N	HM55
ENLJ75-434G64Mn	LX.BG902.003	3rd WiFi 2x2 BGN	N	N	N	HM55
ENLJ75-524G50Mi	S2.BG902.002	INT6200H	BT 2.1	N	N	HM55
ENLJ75-434G82Mn	LX.BH302.010	3rd WiFi 2x2 BGN	N	N	N	HM55
ENLJ75-338G50Mn	LX.BH302.005	3rd WiFi 2x2 BGN	N	N	N	HM55
ENLJ75-436G50Mn	LX.BH302.009	3rd WiFi 2x2 BGN	N	N	N	HM55
ENLJ75-434G64Mn	LX.BH302.008	3rd WiFi 2x2 BGN	N	N	N	HM55
ENLJ75-434G50Mn	LX.BH302.004	3rd WiFi 2x2 BGN	N	N	N	HM55
ENLJ75-333G32Mi	LX.BH302.007	3rd WiFi BG	BT 2.1	N	N	HM55
ENLJ75-434G32Bn	LX.BH302.006	3rd WiFi 2x2 BGN	N	N	N	HM55
ENLJ75-434G50Mn	LX.BH302.003	3rd WiFi 2x2 BGN	N	N	N	HM55
ENLJ75-334G50Mn	LX.BH302.002	3rd WiFi 2x2 BGN	N	N	N	HM55
ENLJ75-434G32Mn	LX.BH302.001	3rd WiFi 2x2 BGN	BT 2.1	N	N	HM55

Model	Acer Part No	Wireless LAN1	Bluetooth	VOIP Phone	Finger Print	NB Chipset
ENLJ75-544G32Mi	S2.BH302.001	INT6200H	BT 2.1	N	N	HM55
ENLJ75-334G32Mn	LX.BGB02.005	3rd WiFi 2x2 BGN	N	N	N	HM55
ENLJ75-334G32Mn	LX.BGB02.004	3rd WiFi 2x2 BGN	N	N	N	HM55
ENLJ75-334G50Mn	LX.BGB02.001	3rd WiFi 2x2 BGN	N	N	N	HM55
ENLJ75-334G50Mn	LX.BGB02.002	3rd WiFi 2x2 BGN	N	N	N	HM55
ENLJ75-334G32Mn	LX.BGB02.003	3rd WiFi 2x2 BGN	N	N	N	HM55
ENLJ75-544G32Bi	S2.BGB02.001	INT6300H	BT 2.1	N	N	HM55



# Packard Bell EasyNote LJ77 Series

Model	Acer Part No	RO	Country	Description
ENLJ77-543G50Mn	S2.BGA02.001	WW	WW	ENLJ77-543G50Mn W7HP64BWW2 MADISON_PRO1GBCrk_V3 2G+1G/500_L/BT/ 6L2.2/5R/CB_GN_0.3D_GEr_EN11
ENLJ77-544G50Mi	S2.BH402.001	WW	WW	ENLJ77-544G50Mi W7HP64BWW2 PARK_XT512Crk_V3 2*2G/500_L/BT/6L2.2/5R/ CB_abgn_0.3D_GEk_EN11
ENLJ77-543G32Bn	S2.BGC02.001	WW	WW	ENLJ77-543G32Bn W7HP64BWW2 UMACrk 2G+1G/320/BT/6L2.2/5R/ CB_GN_0.3D_GEr_EN11
ENLJ77-334G50Mn	LX.BGC02.001	EMEA	France	ENLJ77-334G50Mn W7HP64BTFR1 UMACrk 2*2G/500_L/6L2.2/5R/CB_GN_0.3D_GEr_FR51 EASYNOTE_LJ77-GN-251FR

Model	Acer Part No	CPU	LCD	VGA Chip	VRAM 1	Memory 1
ENLJ77-543G50Mn	S2.BGA02.001	Ci5540M	NLED17.3 WXGA+G	MADISON_PRO	1G-DDR3 (64*16*8)	SO2GBIII10
ENLJ77-544G50Mi	S2.BH402.001	Ci5540M	NLED17.3 WXGA+G	PARK_XT	512M-DDR3 (64*16*4)	SO2GBIII10
ENLJ77-543G32Bn	S2.BGC02.001	Ci5540M	NLED17.3 WXGA+G	UMA	N	SO2GBIII10
ENLJ77-334G50Mn	LX.BGC02.001	Ci3330M	NLED17.3 WXGA+G	UMA	N	SO2GBIII10

Model	Acer Part No	Memory 2	Memory 3	Memory 4	HDD 1(GB)	HDD 2(GB)
ENLJ77-543G50Mn	S2.BGA02.001	SO1GBIII10	N	N	N500GB5.4KS	N
ENLJ77-544G50Mi	S2.BH402.001	SO2GBIII10	N	N	N500GB5.4KS	N
ENLJ77-543G32Bn	S2.BGC02.001	SO1GBIII10	N	N	N320GB5.4KS	N
ENLJ77-334G50Mn	LX.BGC02.001	SO2GBIII10	N	N	N500GB5.4KS	N

Model	Acer Part No	ODD	Media Processor	Extra SW1	Card Reader
ENLJ77-543G50Mn	S2.BGA02.001	NSM8XS	N	NIS	5 in 1-Build in
ENLJ77-544G50Mi	S2.BH402.001	NSM8XS	N	NIS	5 in 1-Build in
ENLJ77-543G32Bn	S2.BGC02.001	NBDCB4XS	N	NIS	5 in 1-Build in
ENLJ77-334G50Mn	LX.BGC02.001	NSM8XS	N	NIS	5 in 1-Build in

Model	Acer Part No	Wireless LAN1	Bluetooth	VOIP Phone	Finger Print	NB Chipset
ENLJ77-543G50 Mn	S2.BGA02.001	3rd WiFi 2x2 BGN	BT 2.1	N	N	HM55
ENLJ77-544G50 Mi	S2.BH402.001	INT6200H	BT 2.1	N	N	HM55
ENLJ77-543G32B n	S2.BGC02.001	3rd WiFi 2x2 BGN	BT 2.1	N	N	HM55
ENLJ77-334G50 Mn	LX.BGC02.001	3rd WiFi 2x2 BGN	N	N	N	HM55

# Test Compatible Components

---

This computer's compatibility is tested and verified by Acer's internal testing department. All of its system functions are tested under Windows® 7 environment.

Refer to the following lists for components, adapter cards, and peripherals which have passed these tests. Regarding configuration, combination and test procedures, please refer to the Packard Bell EasyNote LJ75/ LJ77 Compatibility Test Report released by the Acer Mobile System Testing Department.

# Microsoft® Windows® 7 Environment Test

Vendor	Type	Description
<b>2nd HDD</b>		
HGST	N160GB5.4KS	HDD HGST 2.5" 5400rpm 160GB HTS545016B9A300 Panther B SATA LF F/W:C60F
HGST	N250GB5.4KS	HDD HGST 2.5" 5400rpm 250GB HTS545025B9A300 Panther B SATA LF F/W:C60F
HGST	N320GB5.4KS	HDD HGST 2.5" 5400rpm 320GB HTS545032B9A300 Panther B SATA LF F/W: C60F
HGST	N500GB5.4KS	HDD HGST 2.5" 5400rpm 500GB HTS545050B9A300 Panther B SATA LF F/W:C60F
SEAGATE	N250GB5.4KS	HDD SEAGATE 2.5" 5400rpm 250GB ST9250315AS Wyatt SATA LF F/W:0001SDM1
SEAGATE	N500GB5.4KS	HDD SEAGATE 2.5" 5400rpm 500GB ST9500325AS Wyatt SATA LF F/W:0001SDM1
TOSHIBA	N250GB5.4KS	HDD TOSHIBA 2.5" 5400rpm 250GB MK2555GSX Libra SATA LF F/W:FG001J
WD	N160GB5.4KS	HDD WD 2.5" 5400rpm 160GB WD1600BEVT-22ZCT0 ML160 SATA LF F/W:11.01A11
WD	N320GB5.4KS	HDD WD 2.5" 5400rpm 320GB WD3200BEVT-22ZCT0 ML160 SATA LF F/W:11.01A11
WD	N640GB5.4KS	HDD WD 2.5" 5400rpm 640GB WD6400BEVT-22A0RT0, ML320 SATA 8MB LF F/W:01.01A01
<b>Adapter</b>		
HIPRO	65W	Adapter HIPRO 65W 19V 1.7x5.5x11 Yellow HP-A0652R3B 1LF, LV5 LED LF
LITE-ON	65W	Adapter LITE-ON 65W 19V 1.7x5.5x11 Yellow PA-1650-22AC LV5 LED LF
LITE-ON	90W	Adapter LITE-ON 90W 19V 1.7x5.5x11 Blue PA-1900-34AR, LV5 LED LF
<b>Audio Codec</b>		
Realtek	ALC272X	Realtek Audio Codec ALC272X
<b>Battery</b>		
PANASONIC	6CELL2.2	Battery PANASONIC AS-2007B Li-Ion 3S2P PANASONIC 6 cell 4400mAh Main COMMON PSS
SAMSUNG	6CELL2.2	Battery SAMSUNG AS-2007B Li-Ion 3S2P SAMSUNG 6 cell 4400mAh Main COMMON SDI 2.2F
SANYO	6CELL2.2	Battery SANYO AS-2007B Li-Ion 3S2P SANYO 6 cell 4400mAh Main COMMON Normal Type
SANYO	8CELL2.4	Battery SANYO AS-2007B Li-Ion 4S2P SANYO 8 cell 4800mAh Main COMMON
SIMPLO	6CELL2.2	Battery SIMPLO AS-2007B Li-Ion 3S2P PANASONIC 6 cell 4400mAh Main COMMON PSS
SIMPLO	8CELL2.4	Battery SIMPLO AS-2007B Li-Ion 4S2P PANASONIC 8 cell 4800mAh Main COMMON PSS
SONY	6CELL2.2	Battery SONY AS-2007B Li-Ion 3S2P SONY 6 cell 4400mAh Main COMMON Normal Type

Vendor	Type	Description
SONY	8CELL2.4	Battery SONY AS-2007B Li-Ion 4S2P SONY 8 cell 4800mAh Main COMMON
<b>Bluetooth</b>		
Foxconn	BT 2.1	Foxconn Bluetooth BRM 2046 BT2.1 (T60H928.33) f/w:861
<b>Camera</b>		
Chicony	0.3M DV	Chicony 0.3M DV Calla_2G
Suyin	0.3M DV	Suyin 0.3M DV Camellia_2G
<b>Card Reader</b>		
	5 in 1-Build in	5 in 1-Build in MS, MS Pro, SD, SC, XD
<b>CPU</b>		
INTEL	Ci3330M	CPU Intel Core i3 330M PGA 2.13G 35W Arrandale, TJ90, VT, 3M L3
INTEL	Ci3350M	CPU Intel Core i3 350M PGA 2.26G 35W Arrandale, TJ90, VT, 3M L3
INTEL	Ci5430M	CPU Intel Core i5 430M PGA 2.26G ARD, up to SC 2.53G, 3M L3
INTEL	Ci5520M	CPU Intel Core i5 520M 2.4G 3M
INTEL	Ci5540M	CPU Intel Core i5 540M 2.53G 3M
INTEL	Ci7620M	CPU Intel Core i7 620M PGA 2.66G 4M
<b>HDD</b>		
HGST	N160GB5.4KS	HDD HGST 2.5" 5400rpm 160GB HTS545016B9A300 Panther B SATA LF F/W:C60F
HGST	N250GB5.4KS	HDD HGST 2.5" 5400rpm 250GB HTS545025B9A300 Panther B SATA LF F/W:C60F
HGST	N320GB5.4KS	HDD HGST 2.5" 5400rpm 320GB HTS545032B9A300 Panther B SATA LF F/W: C60F
HGST	N500GB5.4KS	HDD HGST 2.5" 5400rpm 500GB HTS545050B9A300 Panther B SATA LF F/W:C60F
SEAGATE	N250GB5.4KS	HDD SEAGATE 2.5" 5400rpm 250GB ST9250315AS Wyatt SATA LF F/W:0001SDM1
SEAGATE	N500GB5.4KS	HDD SEAGATE 2.5" 5400rpm 500GB ST9500325AS Wyatt SATA LF F/W:0001SDM1
TOSHIBA	N250GB5.4KS	HDD TOSHIBA 2.5" 5400rpm 250GB MK2555GSX Libra SATA LF F/W:FG001J
WD	N160GB5.4KS	HDD WD 2.5" 5400rpm 160GB WD1600BEVT-22ZCT0 ML160 SATA LF F/W:11.01A11
WD	N320GB5.4KS	HDD WD 2.5" 5400rpm 320GB WD3200BEVT-22ZCT0 ML160 SATA LF F/W:11.01A11
WD	N640GB5.4KS	HDD WD 2.5" 5400rpm 640GB WD6400BEVT-22A0RT0, ML320 SATA 8MB LF F/W:01.01A01
<b>LAN</b>		
Broadcom	BCM57780	Broadcom BCM57780
<b>LCD</b>		
AUO	NLED17.3WXGA+G	LED LCD AUO 17.3" WXGA+ Glare B173RW01-V0 LF 220nit 8ms 600:1
AUO	NLED17.3WXGA+G	LED LCD AUO 17.3" WXGA+ Glare B173RW01-V0 LF 220nit 8ms 600:1

Vendor	Type	Description
CMO	NLED17.3WXGA+G	LED LCD CMO 17.3" WXGA+ Glare N173O6-L02 LF 220nit 8ms 600:1
LPL	NLED17.3WXGA+G	LED LCD LPL 17.3" WXGA+ Glare LP173WD1-TLA1 LF 220nit 8ms 600:1
SAMSUNG	NLED17.3WXGA+G	LED LCD SAMSUNG 17.3" WXGA+ Glare LTN173KT01-A01 LF 220nit 8ms 600:1
<b>MEM</b>		
A-DATA	SO2GBIII10	Memory A-DATA SO-DIMM DDRIII 1066 2GB HY7YG1B1674ZM LF 128*8 0.065um
ELPIDA	SO1GBIII10	Memory ELPIDA SO-DIMM DDRIII 1066 1GB EBJ10UE8BDS0-AE-F LF 128*8 0.065um
ELPIDA	SO2GBIII10	Memory ELPIDA SO-DIMM DDRIII 1066 2GB EBJ21UE8BDS0-AE-F LF 128*8 0.065um
HYNIX	SO1GBIII10	Memory HYNIX SO-DIMM DDRIII 1066 1GB HMT112S6BFR6C-G7 N0 LF 64*16 0.055um
HYNIX	SO2GBIII10	Memory HYNIX SO-DIMM DDRIII 1066 2GB HMT125S6BFR8C-G7 N0 LF 128*8 0.055um
MICRON	SO1GBIII10	Memory MICRON SO-DIMM DDRIII 1066 1GB MT8JSF12864HZ-1G1F1 LF 128*8 0.065um
MICRON	SO2GBIII10	Memory MICRON SO-DIMM DDRIII 1066 2GB MT16JSF25664HZ-1G1F1 LF 128*8 0.065um
NONE	SO4GBIII10	Memory NONE SO-DIMM DDRIII 1066 4GB dummy P/ N LF
SAMSUNG	SO1GBIII10	Memory SAMSUNG SO-DIMM DDRIII 1066 1GB M471B2873EH1-CF8 LF 64*16 0.055um
SAMSUNG	SO2GBIII10	Memory SAMSUNG SO-DIMM DDRIII 1066 2GB M471B5673EH1-CF8 LF 128*8 0.055um
<b>Modem</b>		
Lite-On	Lite+Con MC4Z 1.5_3.3V Aus	Lite-On Conexant -Unizion 1.5_3.3v AUS RD02-D330
<b>NB Chipset</b>		
INTEL	HM55	NB Chipset Intel CS BD82HM55
<b>ODD</b>		
HLDS	NBDCB4XS	ODD HLDS BD COMBO 12.7mm Tray DL 4X CT21N LF W/O bezel 1.00 SATA (HF + Windows 7)
HLDS	NSM8XS	ODD HLDS Super-Multi DRIVE 12.7mm Tray DL 8X GT30N LF W/O bezel SATA (HF + Windows 7)
PANASONIC	NSM8XS	ODD PANASONIC Super-Multi DRIVE 12.7mm Tray DL 8X UJ890A LF W/O bezel SATA (HF + Windows 7)
PLDS	NBDCB4XS	ODD PLDS BD COMBO 12.7mm Tray DL 4X DS-4E1S LF W/O bezel SATA (Windows 7)
PLDS	NSM8XS	ODD PLDS Super-Multi DRIVE 12.7mm Tray DL 8X DS-8A4SH LF W/O bezel SATA (HF + Windows 7)
SONY	NBDCB4XS	ODD SONY BD COMBO 12.7mm Tray DL 4X BC-5500H LF W/O bezel SATA (HF + Windows 7)
SONY	NSM8XS	ODD SONY Super-Multi DRIVE 12.7mm Tray DL 8X AD-7585H LF W/O bezel SATA (HF + Windows 7)
TOSHIBA	NSM8XS	ODD TOSHIBA Super-Multi DRIVE 12.7mm Tray DL 8X TS-L633C LF W/O bezel SATA (HF + Windows 7)

Vendor	Type	Description
<b>VGA Chip</b>		
AMD	MADISON_PRO	AMD MADISON_PRO 40nm 29mm*29mm M2 package
AMD	PARK_XT	AMD PARK_XT 40nm 29mm*29mm M2 package
None	UMA	UMA (Intel)
<b>VRAM</b>		
	1G-DDR3 (64*16*8)	1G-DDR3 64*16*8
	512M-DDR3 (64*16*4)	512M-DDR3 64*16*4
<b>WiFi Antenna</b>		
WNC	PIFA	PIFA
<b>Wireless LAN</b>		
Foxconn	3rd WiFi 2x2 BGN	Foxconn Wireless LAN Atheros HB93 2x2 BGN (HM)
INTEL	INT1000H	Lan Intel WLAN 112BN.HMWG MM#903341
INTEL	INT6200H	Lan Intel WLAN 622AN.HMWG
Liteon	3rd WiFi 2x2 BGN	Liteon Wireless LAN Atheros HB93 2x2 BGN (HM) WN6602AH
Liteon	3rd WiFi 2x2 BGN	Liteon Wireless LAN Atheros HB93 2x2 BGN (HM) WN6602AH





# Online Support Information

---

This section describes online technical support services available to help you repair your Acer Systems.

If you are a distributor, dealer, ASP or TPM, please refer your technical queries to your local Acer branch office. Acer Branch Offices and Regional Business Units may access our website. However some information sources will require a user i.d. and password. These can be obtained directly from Acer CSD Taiwan.

Acer's Website offers you convenient and valuable support resources whenever you need them.

In the Technical Information section you can download information on all of Acer's Notebook, Desktop and Server models including:

- Service guides for all models
- User's manuals
- Bios updates
- Software utilities
- Spare parts lists
- TABs (Technical Announcement Bulletin)

For these purposes, we have included an Acrobat File to facilitate the problem-free downloading of our technical material.

Also contained on this website are:

- Detailed information on Acer's International Traveler's Warranty (ITW)
- Returned material authorization procedures
- An overview of all the support services we offer, accompanied by a list of telephone, fax and email contacts for all your technical queries.

We are always looking for ways to optimize and improve our services, so if you have any suggestions or comments, please do not hesitate to communicate these to us.



**A**

- AFLASH Utility 39
- Antennas
  - Removing 104

**B**

- Battery Pack
  - Removing 52
  - Replacing 137
- BIOS
  - ROM type 18
  - vendor 18
  - Version 18
- BIOS Utility 27–39
  - Advanced 30
  - Boot 37
  - Exit 38
  - Navigating 27
  - Onboard Device Configuration 33
  - Power 35
  - Save and Exit 38
  - Security 32
  - System Security 38
- Board Layout
  - Top View 169

**C**

- Camera Module
  - Removing 98
  - Replacing 111
- Common Problems 140
- CPU
  - Removing 95
  - Replacing 114
- CPU Fan
  - Removing 93
  - Replacing 115

**D**

- DIMM Modules
  - Removing 57
  - Replacing 134
- Display 5

**E**

- EasyTouch Failure 157
- External Module Disassembly
  - Flowchart 51

**F**

- Features 1
- Flash Utility 39
- FPC Cable
  - Removing 101
  - Replacing 109
- FRU (Field Replaceable Unit) List 177

**H**

- Hard Disk Drive Modules
  - Replacing 133
- HDD1
  - Removing 60
  - Replacing 133
- HDD2
  - Removing 62
  - Replacing 133
- HDTV Switch Failure 157
- Hot Keys 14

**I**

- Indicators 12
- Intermittent Problems 159
- Internal Microphone Failure 147
- Internal Speaker Failure 145

**J**

- Jumper and Connector Locations 169

**K**

- Keyboard
  - Removing 69
  - Replacing 129
- Keyboard Failure 143

**L**

- LCD Bezel
  - Removing 97

---

- Replacing 112
- LCD Brackets
  - Removing 101
  - Replacing 109
- LCD Failure 143
- LCD Module
  - Removing 71
  - Replacing 126
- LCD Module Disassembly
  - Flowchart 96
- LCD Module Reassembly Procedure 106
- LCD Panel
  - Removing 99
  - Replacing 109
- LED Board
  - Removing 82
  - Replacing 121
- Lower Covers
  - Removing 54
  - Replacing 135

## **M**

- Main Module Reassembly Procedure 114
- Main Unit Disassembly
  - Flowchart 64
- Mainboard
  - Removing 90
  - Replacing 117
- Media Board
  - Removing 68
  - Replacing 130
- Media Board FFC
  - Removing 81
  - Replacing 121
- Memory Check 140
- MIC Board
  - Replacing 106
- Microphone Module
  - Removing 103
- Model Definition 190
- Modem Board
  - Removing 86
  - Replacing 119
- Modem Cable
  - Removing 91
  - Replacing 116

## **N**

- No Display Issue 141

## **O**

- ODD Failure 149
- ODD Module
  - Removing 55
  - Replacing 135
- Online Support Information 207

## **P**

- Panel 6
  - Bottom 9
  - left 6
- PC Card 12
- Power Board
  - Removing 100
  - Replacing 106
- Power On Failure 140
- Primary HDD
  - Removing 60
  - Replacing 133

## **R**

- RJ-11 Jack
  - Removing 91
  - Replacing 116
- RTC Battery
  - Removing 85

## **S**

- SD Dummy Card
  - Removing 53
  - Replacing 137
- Secondary HDD
  - Removing 62
  - Replacing 133
- Speaker Module
  - Removing 83
  - Replacing 120
- Switch Cover
  - Removing 65
  - Replacing 131
- System
  - Block Diagram 5

---

## T

Test Compatible Components 201

Thermal Grease 114

Thermal Module

Removing 94

Replacing 114

Thermal Unit Failure 157

TouchPad Bracket

Removing 80

Replacing 122

TouchPad Failure 144

Troubleshooting

Built-in KB Failure 143

EasyTouch Buttons 157

HDTV Switch 157

Internal Microphone 147

Internal Speakers 145

LCD Failure 143

No Display 141

ODD 149

Other Failures 158

Power On 140

Thermal Unit 157

TouchPad 144

WLAN 154

## U

Undetermined Problems 159

Upper Cover

Removing 76

Replacing 122

USB Board

Removing 88

Replacing 118

utility

BIOS 27–39

## W

Windows 2000 Environment Test 202

Wireless Function Failure 154

WLAN Module

Removing 58

Replacing 134



## Free Manuals Download Website

<http://myh66.com>

<http://usermanuals.us>

<http://www.somanuals.com>

<http://www.4manuals.cc>

<http://www.manual-lib.com>

<http://www.404manual.com>

<http://www.luxmanual.com>

<http://aubethermostatmanual.com>

Golf course search by state

<http://golfingnear.com>

Email search by domain

<http://emailbydomain.com>

Auto manuals search

<http://auto.somanuals.com>

TV manuals search

<http://tv.somanuals.com>