



Handbook for Palm™ Zire™ Handheld

Copyright

Copyright © 2002 Palm, Inc. All rights reserved. Graffiti, HotSync, and Palm OS are registered trademarks of Palm, Inc. The HotSync logo, Palm, Palm Powered, the Palm logo, and Zire are trademarks of Palm, Inc. Other product and brand names may be trademarks or registered trademarks of their respective owners.

Disclaimer and Limitation of Liability

Palm, Inc. assumes no responsibility for any damage or loss resulting from the use of this guide.

Palm, Inc. assumes no responsibility for any loss or claims by third parties which may arise through the use of this software. Palm, Inc. assumes no responsibility for any damage or loss caused by deletion of data as a result of malfunction, dead battery, or repairs. Be sure to make backup copies of all important data on other media to protect against data loss.

IMPORTANT Please read the End User Software License Agreement with this product before using the accompanying software program(s). Using any part of the software indicates that you accept the terms of the End User Software License Agreement.

Software Download Available

Palm™ Desktop software is supplied on a CD-ROM disc. Check www.palm.com for updates and new versions of the software.

PN: 406-4455A-US

Contents

About This Book	1
Chapter 1: Setting Up Your Handheld	3
Step 1: Charge your handheld	3
Step 2: Set up your handheld	4
Step 3: Connect the HotSync cable	4
Step 4: Install Palm Desktop software and perform a HotSync operation	5
System requirements	5
Upgrading from another Palm OS handheld	6
Congratulations!	7
Chapter 2: Exploring Your Handheld	9
Zire handheld components	10
Locating front panel controls	10
Locating back panel components	11
Locating top components	12
Using the protective flip cover	12
Using your handheld with a PIM	13
Elements of the handheld interface	13
Displaying online tips	15
Tapping and typing	15
Entering data	16
Onscreen keyboard	16
Graffiti writing	17
Note Pad	18
Using Palm Desktop software	18
Importing data	19
Customizing your handheld	19
Chapter 3: Entering Data in Your Handheld	23
Using the onscreen keyboard	23
Using Graffiti writing to enter data	24
Writing Graffiti characters	24
Graffiti tips	25

The Graffiti® alphabet	26
Writing capital letters	27
Writing numbers	27
Graffiti numbers	28
Writing punctuation marks	28
Additional Graffiti punctuation	29
Writing symbols and extended characters	29
Writing accented characters	29
Accent strokes	30
Additional non-English characters	30
Navigation strokes	30
Graffiti ShortCuts	30
Using Note Pad	31
Beaming data	32
Using your computer keyboard	34
Importing data	34
Importing data from a Windows computer	34
Importing data from a Mac	35
Chapter 4: Working with Applications	37
Opening applications	37
Switching between applications	38
Categorizing applications	38
Changing the Applications Launcher display	39
Using menus	40
Choosing application preferences	42
Common tasks	43
Creating records	43
Editing records	43
Deleting records	45
Purging records	45
Categorizing records	46
Finding information	49
Sorting lists of records	53
Attaching notes	54
Choosing fonts	55
Reviewing Reminders	56
Hiding or masking private records	57

Installing and removing applications	57
Installing add-on applications	57
Removing applications	60
Removing Palm Desktop software	61
Chapter 5: Using Address Book	63
Creating an Address Book entry	64
Selecting types of phone numbers	65
Changing address entry details	66
Address Book menus	67
Record menus	67
Options menus	67
Chapter 6: Using Calculator	69
Performing Calculations	69
Recent Calculations	70
Calculator menu	71
Options menus	71
Chapter 7: Using Clock	73
Viewing the time	73
Setting an alarm	74
Clock menus	75
Options menu	75
Chapter 8: Using Date Book	77
Scheduling an event	78
Rescheduling an event	81
Setting an alarm for an event	82
Setting an alarm for an untimed event	83
Scheduling repeating or continuous events	83
Changing repeating or continuous events	84
Considerations for repeating or continuous events	84
Changing the Date Book view	85
Working in Week View	85
Working in Month View	87
Working in Agenda View	88
Spotting event conflicts	89
Date Book menus, preferences, and display options	89

Chapter 9: Using Expense	91
Adding expense items	92
Changing the date of an Expense item	93
Entering receipt details	93
Customizing the Currency pick list	94
Defining a custom currency symbol	95
Show Options	96
Working with Expense data on your computer	96
Displaying the euro on your computer	97
Printing the euro	97
Expense menus	97
Record menu	97
Options menu	98
Chapter 10: Using Memo Pad	99
Creating memos	99
Reviewing memos	100
Memo Pad menus	101
Record menus	101
Options menus	101
Chapter 11: Using Note Pad	103
Creating a note	103
Reviewing notes	104
Clearing a note	105
Setting an alarm for a note	105
Note Pad menus	106
Record menus	107
Options menus	107
Chapter 12: Using Security	109
Assigning a password	109
Changing or deleting a password	110
Locking your handheld	111
Recovering from a forgotten password	113
Making records private	114
Hiding or masking private records	114

Chapter 13: Using To Do List	117
Creating list items	117
Setting priority	118
Checking off a To Do List item	119
Changing To Do List item details	119
Setting a due date	120
To Do Show Options	120
To Do List menus	121
Record menu	121
Options menu	122
Chapter 14: Performing HotSync® Operations	123
Selecting HotSync setup options	123
Customizing HotSync application settings	125
Performing cable HotSync operations	127
IR HotSync operations	132
Preparing your computer for infrared communication	132
Configuring HotSync Manager for infrared communication	133
Performing an IR HotSync operation	134
Remote HotSync operations	135
Preparing your computer	135
Preparing your handheld	137
Selecting the conduits for a remote HotSync operation	138
Performing a remote HotSync operation	138
Returning to cable HotSync operations	139
Using File Link	139
Creating a user profile	140
Performing the first HotSync operation with a user profile	141
Chapter 15: Setting Preferences for Your Handheld	143
Buttons preferences	144
Pen preferences	144
Connection preferences	145
Configuring an IR to phone connection	146
Date and Time preferences	147
Digitizer preferences	147
Formats preferences	147
Country default	147
Time, date, week start, and numbers formats	148

General preferences	148
Auto-off delay	149
On while charging settings	149
System, alarm, and game sounds	150
Beam Receive	150
Network preferences and TCP/IP software	150
Selecting a service	151
Entering a username	151
Entering a password	152
Selecting a connection	152
Adding telephone settings	153
Connecting to your service	155
Creating additional service templates	156
Adding detailed information to a service template	157
Login scripts	159
Creating a login script on your handheld	160
Deleting a service template	161
Network preferences menu commands	162
TCP/IP troubleshooting	162
Owner preferences	163
ShortCuts preferences	164
Creating a ShortCut	164
Editing a ShortCut	165
Deleting a ShortCut	165
Appendix A: Maintaining Your Handheld	167
Caring for your handheld	167
Battery considerations	168
Resetting your handheld	168
Performing a soft reset	168
Performing a hard reset	169
Appendix B: Frequently Asked Questions	173
Software installation problems	174
Operating problems	175
Tapping and writing problems	176
Application problems	177
HotSync problems	178
Beaming problems	182

Password problems	182
Technical support	183
Appendix C: Non-ASCII Characters for Login Scripts	185
Use of ^char	185
Carriage return and line feed	185
Literal characters	186
Product Regulatory and Safety Information	187
Index	189

About This Book

Welcome to the Palm™ Zire™ handheld. This handbook is designed to help you get up and running quickly on your handheld. It describes all you need to know about how to use your handheld and the applications that come with it.

It walks you through:

- Identifying your handheld's features
- Viewing and entering data
- Using your handheld with your computer
- Personalizing your handheld with your own preference settings

After you become familiar with the basic functionality of your handheld, you can use the rest of this handbook as a reference for less common tasks, for maintaining your handheld, and also as a source of information if you have problems operating your handheld.

Setting Up Your Handheld

This chapter explains how to charge and set up your handheld, install Palm™ Desktop software on your desktop computer, and perform a HotSync® operation. It also lists system requirements.

If you are upgrading from another Palm OS® handheld, see [“Upgrading from another Palm OS handheld”](#) later in this chapter.

Step 1: Charge your handheld

Plug the power adapter into an electric outlet, and connect the adapter to your handheld. Charge the handheld for three hours. Then connect it to the power adapter for a few minutes each day to recharge the battery to full capacity. See [“Battery considerations”](#) in [Appendix A](#) for more information.

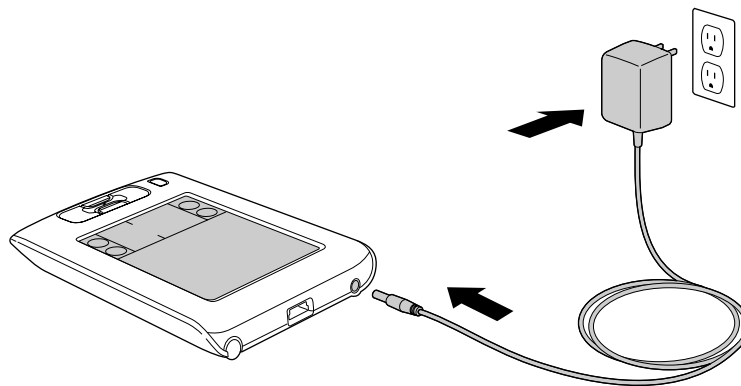

Step 2: Set up your handheld

Detach the power adapter from the handheld. Press the power button. Remove the stylus and use it to complete Setup on your handheld.

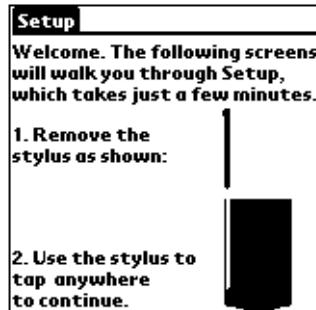

Step 3: Connect the HotSync cable

Connect the HotSync cable to your handheld and your computer.

To connect the HotSync cable:

1. Plug the USB connector on the cable into a USB port on your computer.
2. Plug the other end into the connector on the handheld.

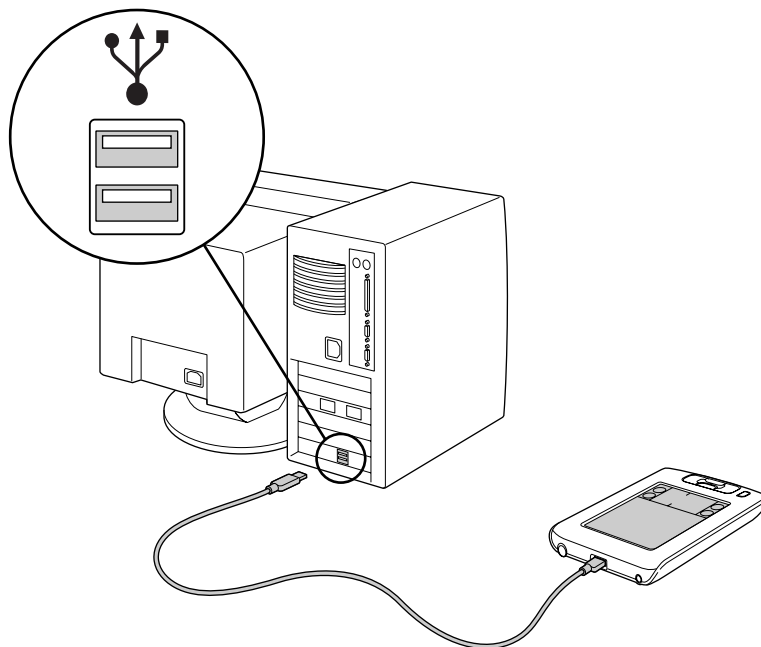

Step 4: Install Palm Desktop software and perform a HotSync operation

To install software:

- Put the Palm Desktop CD into your computer's CD-ROM or DVD drive and follow the onscreen installation instructions.

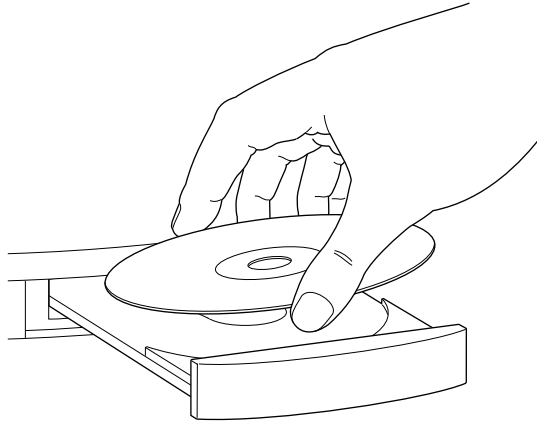

Windows: If the CD does not start automatically, double-click the autorun.exe file found on the CD. Some systems may require administrator rights to install software.

Mac: Double-click the CD-ROM icon that appears on the desktop. Then double-click the Palm Desktop Installer.

To perform a HotSync operation:

- Tap the Favorite icon when prompted by the Install program.

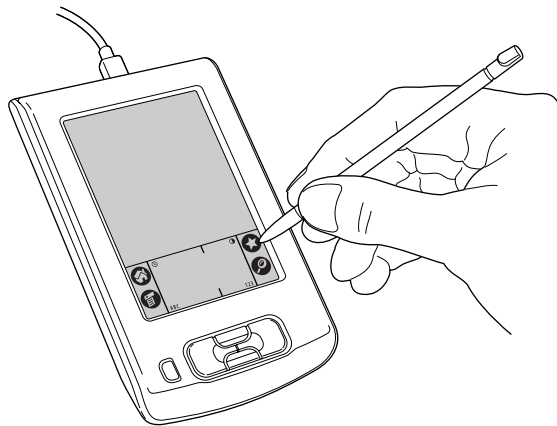

System requirements

To install and operate Palm Desktop software on the enclosed CD-ROM, your computer system must meet the following requirements:

Minimum requirements: Windows

- Windows 98/Me/2000 Professional/XP Home/XP Professional
- 50MB available hard disk space
- VGA monitor or better (the *Quick Tour* requires video resolution of 800x600 and 256-color video display; for best results, use High Color:16 bit)

- CD-ROM or DVD drive (Palm Desktop software is supplied on a CD-ROM disc. Check www.palm.com for updates and new versions of the software.)
- One available USB port
- Mouse or equivalent

Minimum requirements: Mac

- Apple Macintosh or compatible with a PowerPC processor
- Mac OS version 9.0 or higher with 12MB RAM or Mac OS X, version 10.1.2 or higher
- 25MB available hard disk space
- CD-ROM or DVD drive (you can also download the Palm Desktop software from www.palm.com)
- One available USB port
- Mouse or equivalent

Upgrading from another Palm OS handheld

If you already own a Palm OS handheld:

1. Perform a HotSync operation using your old handheld and cradle/cable. This ensures all data on your handheld is on your desktop computer.
2. (Optional) You may want to create a copy of your old Palm Desktop software folder and its contents before installing your new Palm Desktop software. For information on how to do this, see www.palm.com/support.
3. Follow the directions earlier in this chapter to set up your new handheld. You must install the version of Palm Desktop software that comes with your new handheld.
4. After you perform a HotSync operation using your new handheld, rename your old handheld. To prevent unexpected results during HotSync operations, each handheld must have a unique name. We recommend that you perform a hard reset on your old handheld and then rename it. See “Performing a hard reset” in [Appendix A](#) for details.

Congratulations!



You've set up your handheld and installed Palm Desktop software. For comprehensive information about using your handheld, continue reading this electronic *Handbook*.

For more information about using Palm Desktop software, see the following:

- The Windows tutorial for Palm Desktop software, *Quick Tour*. To access this tutorial, go to the Help menu in Palm Desktop software and choose Quick Tour.
- The online help for Palm Desktop software. To access the online help, go to the Help menu in Palm Desktop software.
- The electronic *Palm Desktop software for the Macintosh User's Guide*. To access this guide, open the Palm folder, and then open the Documentation folder. Double-click the file Handbook.pdf.

For more information about using your handheld, see the Basic Skills tutorial.

To open the Basic Skills tutorial:

1. Tap the Home icon .
2. Tap the Welcome icon .
3. Follow the onscreen instructions to complete Setup.
4. Tap Basic Skills.

Exploring Your Handheld

Palm™ Zire™ handhelds will help you stay organized and on time, and keep up with daily tasks while you are away from your desk. Use your new handheld to do the following:

- Enter your schedule in Date Book
- Keep all your contact names, addresses, and phone numbers in Address Book
- Prioritize and assign your tasks a due date in To Do List
- Jot quick notes directly on the screen in Note Pad
- Keep track of expenses using Expense
- Set alarms from Clock, Date Book, and Note Pad, to keep yourself on schedule and remind yourself of appointments and notes
- Synchronize your data with Palm™ Desktop software on your Windows or Mac computer to keep your data safe
- Beam information to another device that has an IR (infrared) port.

Zire handheld components

Take a few minutes to familiarize yourself with the features of your handheld.

Locating front panel controls

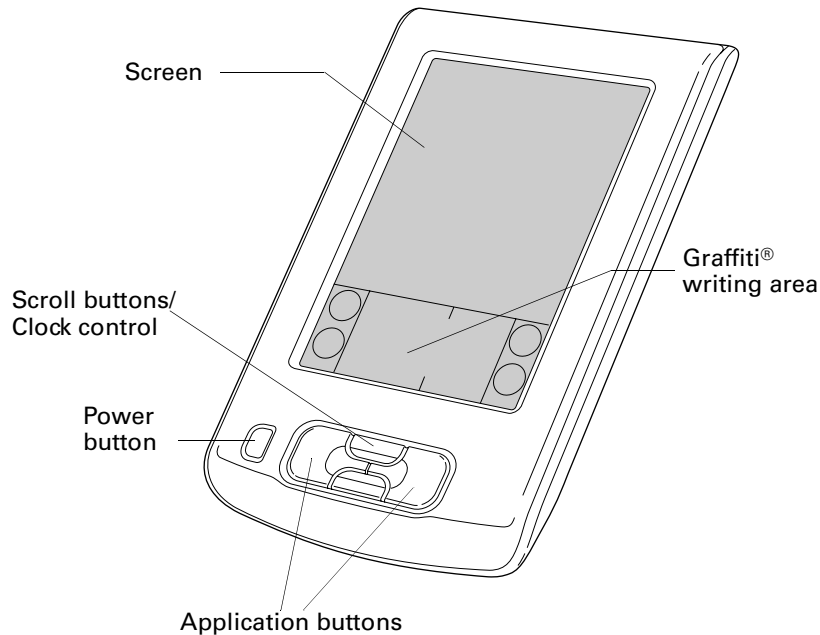

Screen	Displays the applications and information stored in your handheld. It is touch-sensitive and responds to the stylus.
Scroll buttons/ Clock control	Displays text and other information that extends beyond the handheld screen area. When your handheld is on, pressing the lower button scrolls down to view information below the viewing area, and pressing the upper button scrolls up to view information above the viewing area. When your handheld is off, pressing the upper button displays the time.
Graffiti® writing area	The area where you write letters and numbers using the Graffiti® alphabet. See Chapter 3 to learn how to write Graffiti characters.
Power button	Turns your handheld on or off. If your handheld is turned off, pressing the power button turns the handheld on and returns you to the last screen you viewed. If your handheld is turned on, pressing the power button turns the handheld off.

Application buttons Activates the individual handheld applications that correspond to the icons on the buttons: Date Book and Address Book. If your handheld is turned off, pressing either application button activates the handheld and opens the corresponding application. This is the fastest way to open an application.

TIP See “Buttons preferences” in [Chapter 15](#) for details on reassigning these buttons to activate any application on your handheld.

Locating back panel components

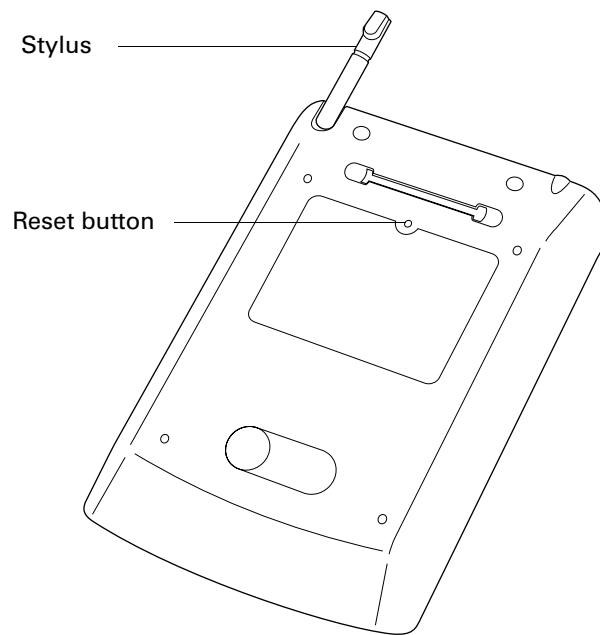

Stylus Serves as a pointing and writing device for navigating through applications and entering data on your handheld. To use the stylus, slide it out of the storage slot and hold it as you would a pen or pencil.

Reset button Under normal use, you should not have to use the reset button. See “Resetting your handheld” in [Appendix A](#) for information about when and how to use the reset button.

Locating top components

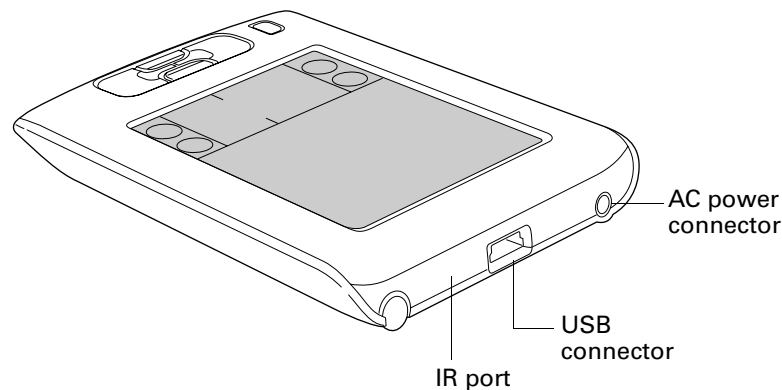

- | | |
|---------------------------|--|
| IR port | Uses infrared technology to transmit data to and receive data from other Palm OS® handhelds, and to perform HotSync® operations. See “Beaming data” in Chapter 3 and see “IR HotSync operations” in Chapter 14 for more information. |
| USB connector | Connects your handheld to the cable which connects to the USB port of your computer. This allows you to update the information between your handheld and computer using HotSync technology. |
| AC power connector | Connects your handheld to an electric outlet so you can charge your handheld. |

Using the protective flip cover

The flip cover protects your handheld screen when it is not in use. You can open the cover so that it rests on the back of your handheld, or remove it altogether.

To attach the cover:

- Align the rail with the groove on the back of your handheld, and slide the cover into place.

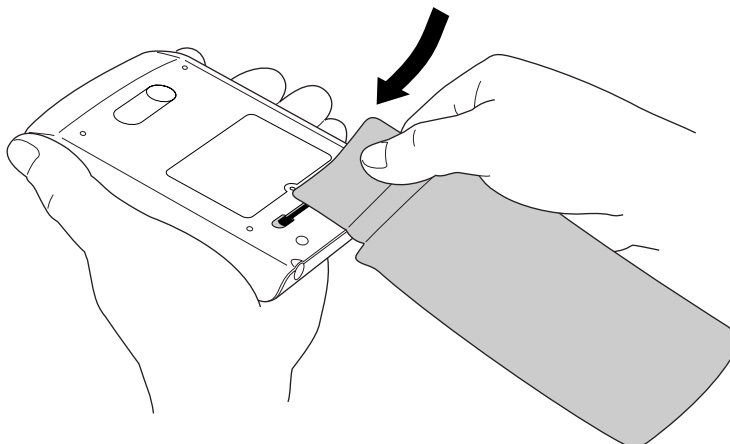

To remove the cover:

1. Open the cover and grasp the back flap.
2. Gently slide the cover to one side until the rail slides out from the groove on the back of your handheld. Do not pull the rail out of the groove.

Using your handheld with a PIM

Your handheld comes with a personal information manager (PIM), Palm Desktop software. If you prefer to use another personal information manager (PIM), such as Microsoft Outlook, you still need to install Palm Desktop software in order to add HotSync Manager, connection software, and other features of Palm Desktop software to your computer. The connection software, called a conduit, lets you synchronize the data between your handheld and your PIM. The conduit for Microsoft Outlook is included on the Palm Desktop software CD-ROM (Windows only). For information on the availability of conduit software for the PIM you use, contact the vendor of your PIM or visit the web site www.palm.com.

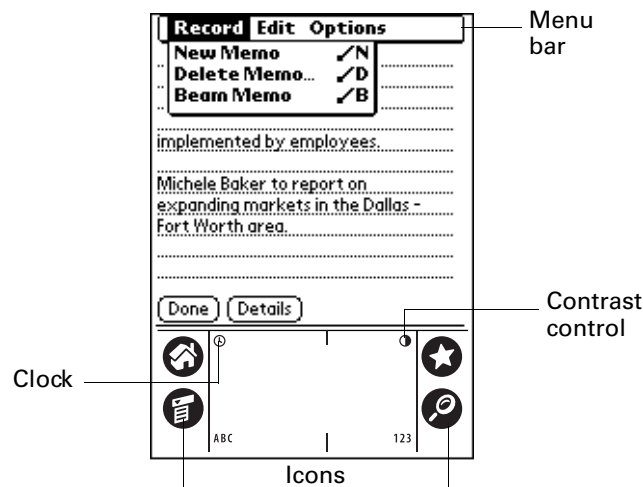

Elements of the handheld interface



Menu bar A set of commands that are specific to the application. Not all applications have a menu bar.

Icons Tap the icons to do the following:

- Open applications 🏠
- Open menus 📄
- Perform a HotSync operation ★
- Find text anywhere in your data 🔍

- Contrast control** Tap the Contrast icon  to open the Adjust Contrast dialog box. Tap to the left or right of the slider to adjust the contrast in small increments or drag the slider to change the contrast in large increments. You can also press the up and down scroll buttons to adjust the contrast.
- Clock** Tap the Clock icon  to briefly display the time and date.
- ABC** With the cursor in an input field, tap "ABC" to activate the alphabetic keyboard.
- 123** With the cursor in an input field, tap "123" to activate the numeric keyboard.

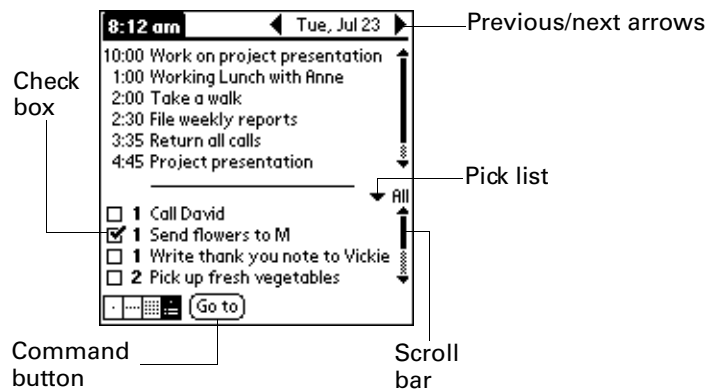

- Check box** When a check mark appears in a check box, the corresponding option is active. If a check box is empty, tapping it inserts a check mark. If a check box is checked, tapping it removes the check mark.
- Command buttons** Tap a button to perform a command. Command buttons appear in dialog boxes and at the bottom of application screens.
- Next/previous arrows** Tap the left and right arrows to display the previous and next record; tap the up and down arrows to display the previous and next page of information.
- Pick list** Tap the arrow to display a list of choices, and then tap an item in the list to select it.
- Scroll bar** Drag the slider, or tap the top or bottom arrow, to scroll the display one line at a time. To scroll to the previous page, tap the scroll bar just above the slider. To scroll to the next page, tap the scroll bar just below the slider.

You can also scroll to the previous and next pages by pressing the upper and lower scroll buttons on the front panel of your handheld.

Displaying online tips

Many of the dialog boxes that appear on your handheld contain an online Tips icon ⓘ in the upper-right corner. Online tips anticipate questions you have in a dialog box, provide shortcuts for using the dialog box, or give you other useful information.

To display an online tip:

1. Tap the Tips icon ⓘ.
2. After you review the tip, tap Done.

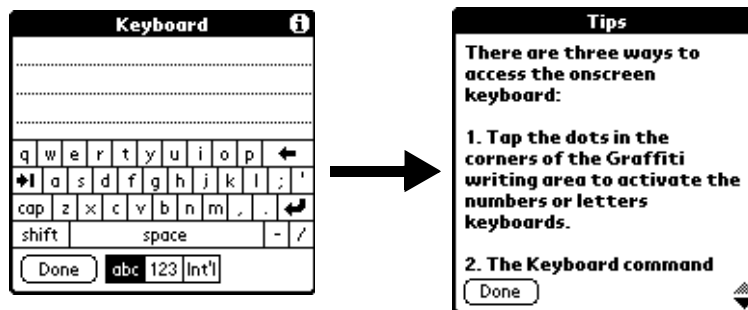

Tapping and typing

Like using a mouse to click elements on a computer screen, using the stylus to tap elements on your handheld screen is the basic action that gets things done.

The first time you start your handheld, setup instructions appear on the screen. These instructions include a calibration screen. Calibration aligns the internal circuitry of your handheld with its touch-sensitive screen so that when you tap an element on the screen, the handheld can detect exactly which task you want to perform.

IMPORTANT Always use the point of the stylus for tapping or making strokes on the handheld screen. Never use an actual pen, pencil, or other sharp object to write on the handheld screen.

With your handheld turned on, you can tap the handheld screen to do many operations, such as the following:

- Open applications
- Choose menu commands
- Initiate a Find operation to search through applications installed on your handheld for specific text

- Select options in dialog boxes
- Open the onscreen keyboards

Just as you can drag the mouse to select text or move objects on your computer, you can also drag the stylus to select text. You can also use the stylus to drag the slider of any scroll bar.

Entering data

There are several ways to enter data into your handheld:

- Using the onscreen keyboard.
- Using Graffiti writing.
- Using Note Pad.
- Entering or importing data in Palm Desktop software and then synchronizing with your handheld.
- Beaming data from another device that has an infrared port. See [“Beaming data”](#) in [Chapter 3](#) for details.

Onscreen keyboard

When you create or edit a record in an application such as Address Book, you can open the onscreen keyboards to enter data.

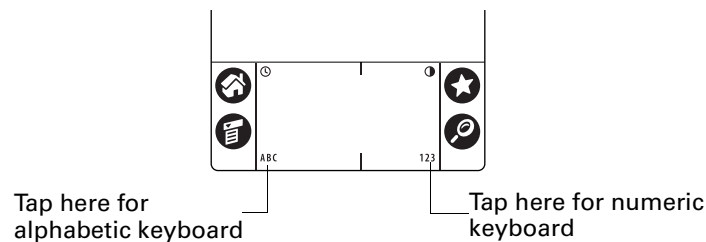

After a keyboard is open, you can tap to open any of the other keyboards, including the international keyboard. See [“Using the onscreen keyboard”](#) in [Chapter 3](#) for more information.

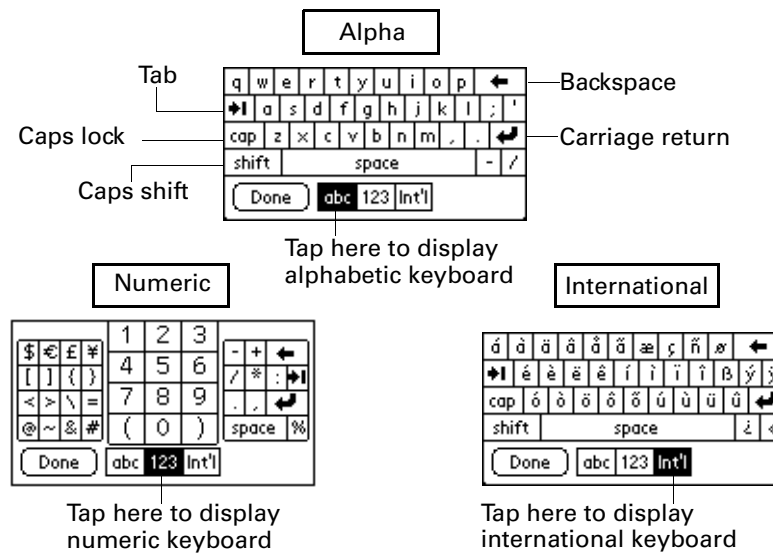

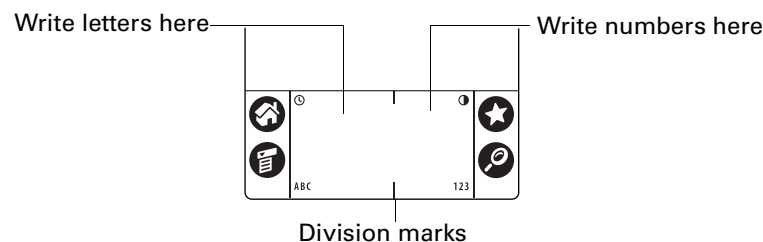

Graffiti writing

Your handheld includes Graffiti writing software as the primary system for entering text and numbers. With Graffiti writing, you write simple strokes with the stylus and they are instantly recognized as letters or numbers.



The Palm Desktop software CD-ROM includes Giraffe, a game you can use to practice Graffiti writing. See [“Installing and removing applications”](#) in [Chapter 4](#) for installation instructions. The Memo Pad application is ideal for practicing Graffiti writing. This section explains how to open Memo Pad and use it to practice Graffiti writing.

To open Memo Pad:

1. Tap the Home icon .
2. Tap the Memo Pad icon .
3. Tap New.

NOTE A blinking cursor appears on the first line of the new memo to indicate where the new text will appear.

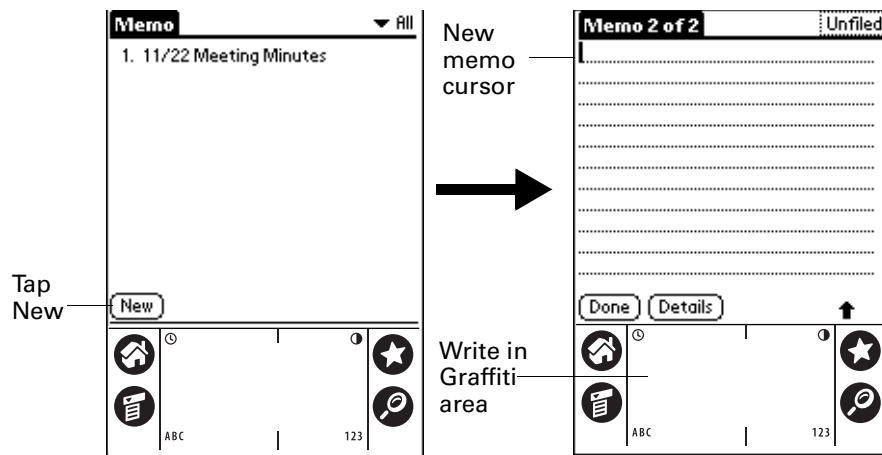

See “Using Graffiti writing to enter data” in [Chapter 3](#) for details.

Note Pad

The Note Pad application provides a place where you can write a quick note in your own handwriting directly on your handheld screen. Think of Note Pad as a virtual “sticky pad” for short notes. Later, you can transfer your “sticky” notes to a more permanent place by entering the information in the appropriate application, or throw them away by deleting them. See “Using Note Pad” in [Chapter 11](#) for more information.

Using Palm Desktop software

If you have new records you want to add to your handheld and prefer to use the computer keyboard rather than Graffiti writing or the onscreen keyboard, enter the data in Palm Desktop software or the PIM you have installed to use with your handheld. For details on entering information in Palm Desktop software, refer to the online Help in Palm Desktop software, the *Quick Tour* in Palm Desktop software (for Windows users), and the *Palm Desktop Software for the Macintosh User's Guide* located in the Documentation folder in the Palm folder.

After the information is in Palm Desktop software, perform a HotSync operation to synchronize your handheld with your computer. See [“Performing cable HotSync operations”](#) in [Chapter 14](#) for more information.

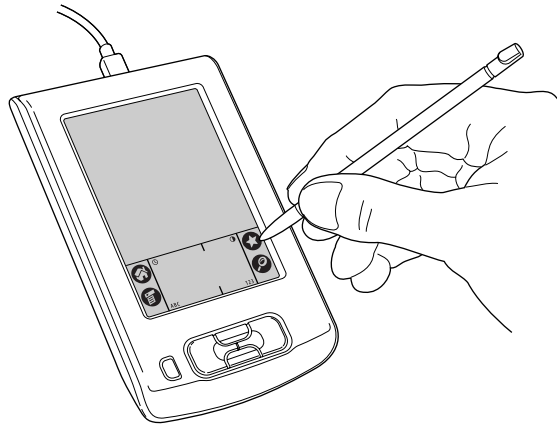



Importing data

If you already have data in a database on your computer, you can import it into Palm Desktop software. You can import data stored in computer applications such as spreadsheets and databases, or from another Palm OS handheld. When you import data, you transfer the records to your handheld without having to enter them manually. See [“Importing data”](#) in [Chapter 3](#) for more information.

Customizing your handheld

You can customize your handheld by using the Preferences application. You can enter personal information such as your name and address; change the time, date, and time zone; view different date and time formats when you travel; turn off sounds; and configure your handheld to work with a modem. See [Chapter 15](#) for details.

To open the Preferences screens:

1. Tap the Home icon .
2. Tap the Preferences icon .
3. Tap the category pick list in the upper-right corner of the screen.
4. Tap the Preferences category you want to view.

The following procedures for setting the date give you an example of how to customize your handheld.

You make changes to the date and time in Date and Time preferences.

To set the date:

1. Tap the Set Date box.
2. Tap the arrows to select the current year.

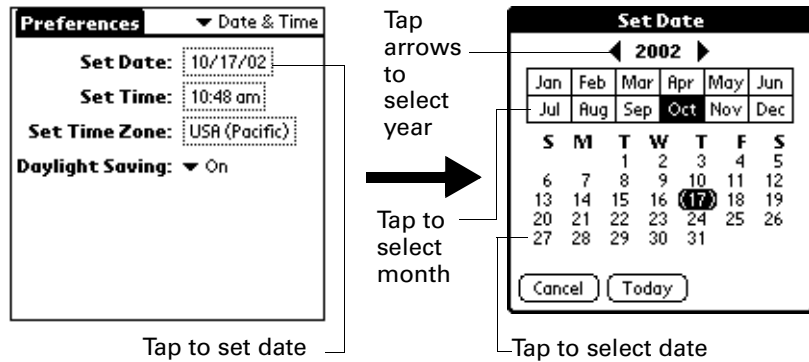

3. Tap a month.
4. Tap the current date.

To set the time:

1. Tap the Set Time box.

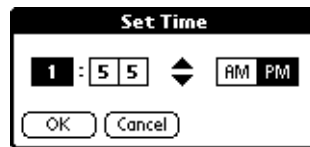

2. Tap the up or down arrows to change the hour.
3. Tap each number of the minute, and then tap the arrows to change them.
4. Tap OK.

To set the time zone:

1. Tap the Set Time Zone box.



2. Tap a time zone.

TIP When you travel, changing the time zone setting to a new time zone automatically resets the date and time on your handheld, but it does not change the time of appointments set in Date Book.

3. Tap OK.

To set the daylight saving switch:

- Tap the Daylight Saving pick list, and then tap Off or On.

If you live in a place where Daylight Saving time applies, set this option to On in the Spring, and Off in the Fall.

Entering Data in Your Handheld

This chapter explains how to enter data into your handheld. There are several ways to enter data into your handheld:

- Using the onscreen keyboard
- Using Graffiti® writing
- Using Note Pad
- Beaming data from a device that has an infrared (IR) port
- Entering or importing data in Palm™ Desktop software and then synchronizing with your handheld

Using the onscreen keyboard

You can open the onscreen keyboard anytime you need to enter text or numbers on your handheld.

To use the onscreen keyboard:

1. Open any application (such as Address Book).
2. Tap any record, or tap New.
3. Tap “ABC” to open the alphabetic keyboard, or tap “123” to open the numeric keyboard.

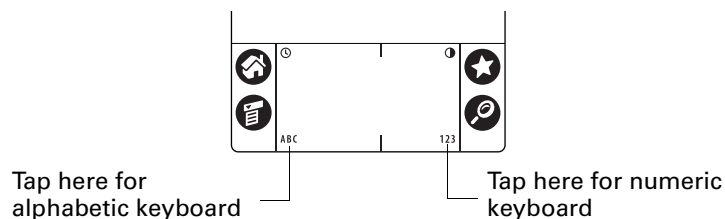

4. Tap the characters to enter text and numbers.

NOTE The onscreen keyboard also includes a dialog box for international characters. You can switch among the three dialog boxes at any time to enter the exact text you need.

5. After you finish, tap Done to close the onscreen keyboard and place the text in the record.

Using Graffiti writing to enter data

Chapter 2 introduced Graffiti writing and briefly described how to use it to enter text in your applications. In this section, you learn the procedures for creating letters, numbers, punctuation, and symbols, as well as some Graffiti tips and tricks.

Writing Graffiti characters

Most people find they can enter text quickly and accurately with only minutes of practice. Graffiti writing includes any character you can type on a standard keyboard. The Graffiti strokes closely resemble the uppercase letters of the regular alphabet, which makes Graffiti writing easy to learn.

There are four basic concepts for success with Graffiti writing:

- If you draw the character shape exactly as shown in the tables later in this chapter (like the shapes shown in the following diagram), you achieve 100% accuracy.



- The heavy dot on each shape shows where to begin the stroke. Certain characters have similar shapes, but different beginning and end points. Always begin the stroke at the heavy dot (you should not create the heavy dot; it is only there to show you where to begin the stroke).
- Most characters require only a single stroke. When you lift the stylus from the Graffiti writing area, your handheld recognizes and displays the text character immediately. To accomplish single strokes, some Graffiti strokes are portions of the regular alphabet equivalents.
- The Graffiti writing area is divided into two parts: one for writing the letters of the alphabet and one for writing numbers. The small marks at the top and bottom of the Graffiti writing area indicate the two areas.

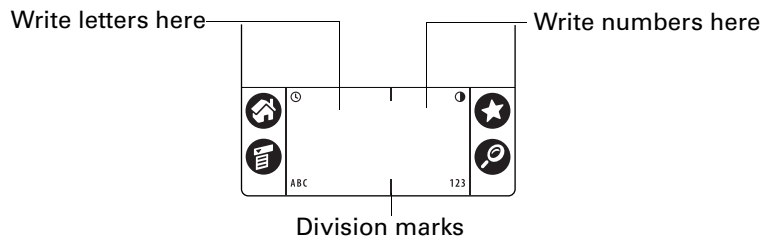

To write Graffiti letters:

1. Tap the screen where you want your text to go.

NOTE You need to tap above the Graffiti writing area, and must see a blinking cursor before you write the text.

2. Use the tables on the following pages to find the stroke shape for the letter you want to create. For example, the stroke shown below creates the letter “n.”

NOTE There are two different stroke shapes available for some letters. For these letters, choose the one that’s easiest for you.

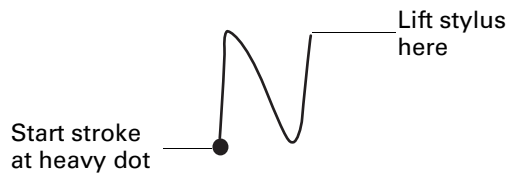

As you’ll see later, you use the same shape to create both the uppercase and lowercase version of a letter.

3. Position the stylus in the left-hand side of the Graffiti writing area.
4. Start your stroke at the heavy dot and draw the stroke shape as it appears in the tables.
5. Lift the stylus from the screen at the end of the stroke shape.

That’s all there is to it! When you lift the stylus from the screen, your handheld recognizes your stroke immediately and prints the letter at the insertion point on the screen.

As soon as you lift the stylus from the screen, you can begin the stroke for the next character you want to write.

IMPORTANT You must begin the character strokes in the Graffiti writing area. If you do not make Graffiti strokes in the Graffiti writing area, your handheld does not recognize them as text characters.





























Graffiti tips

When using Graffiti writing, keep these tips in mind:

- Accuracy improves when you write large characters. You should draw strokes that nearly fill the Graffiti writing area.
- To delete characters, simply set the insertion point to the right of the character you want to delete and make the backspace stroke (a line from right to left) in the Graffiti writing area.

- Write at natural speed. Writing too slowly can generate recognition errors.
- Do not write on a slant. Vertical strokes should be parallel to the sides of the Graffiti writing area.
- Press firmly.

The Graffiti® alphabet

Letter	Strokes	Letter	Strokes
A		N	
B		O	
C		P	
D		Q	
E		R	
F		S	
G		T	
H		U	
I		V	
J		W	
K		X	
L		Y	
M		Z	
Space		Back Space	
Carriage Return		Period	tap twice

Writing capital letters

You make capital letters with the same stroke shapes as the basic alphabet characters. To make capital letters, you must first “shift” to caps—just as you press the Shift key on a keyboard—and then write the character strokes.

NOTE Graffiti writing includes a feature that automatically capitalizes the first letter when you create a new sentence or a new record (by tapping New or a blank line).

To draw the first letter of a word as a capital letter:

- Use the Caps Shift stroke:



TIP When Caps Shift is active, an “up arrow” symbol appears in the lower-right corner of the handheld screen. If you accidentally activate Caps Shift, backspace will cancel it.

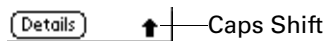

To enter only capital letters (Caps Lock):

- Use the Caps Lock stroke:

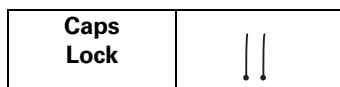

TIP When Caps Lock is active, an underlined “up arrow” symbol appears in the lower-right corner of the handheld screen. To return to lowercase, make the Caps Shift stroke.

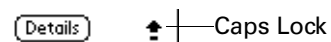

Writing numbers

Writing numbers with Graffiti writing is similar to writing letters of the alphabet, except that you make the character strokes on the right-hand side (numbers side) of the Graffiti writing area.

Graffiti numbers

Number	Strokes	Number	Strokes
0		5	
1		6	
2		7	
3		8	
4		9	

Writing punctuation marks

Graffiti writing can create any punctuation symbol that you can enter from a standard keyboard. All punctuation marks begin with a single tap on the Graffiti writing area. When you make this tap, you activate Punctuation Shift and a dot appears to show it is active. The next stroke you make with the stylus creates a punctuation mark.

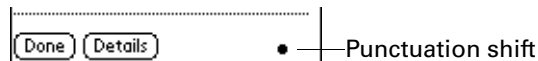

NOTE When Punctuation Shift is active, you can make a symbol stroke anywhere in the Graffiti writing area (the letters *or* numbers side).

Symbol	Stroke	Symbol	Stroke
Period .		Dash —	
Comma ,		Left Paren (
Apostrophe '		Right Paren)	
Question ?		Slash /	
Exclamation !		Dollar \$	

Additional Graffiti punctuation

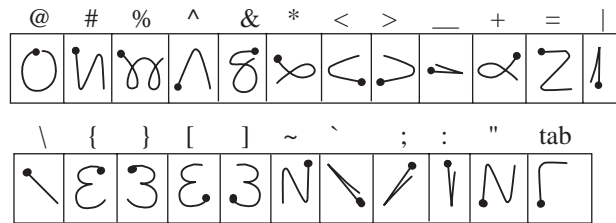

Writing symbols and extended characters

All symbols and extended characters begin with the Symbol Shift stroke in the Graffiti writing area of your handheld:

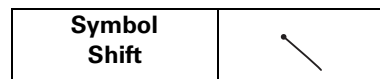

When the Symbol Shift is active, a slanted shift symbol appears in the lower-right corner of the screen. The next stroke that you make creates the symbol or extended character.

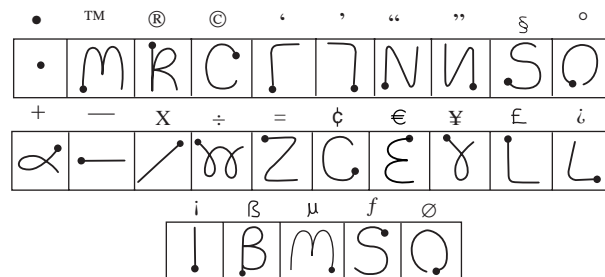
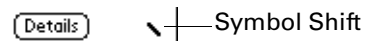

Writing accented characters

To create accented characters, draw the stroke normally used to create the letter, followed by an accent stroke. Graffiti writing then adds the accent to the letter.

For example, the following diagram shows the strokes required to draw an accented “e.”

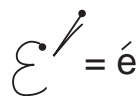

Accent strokes

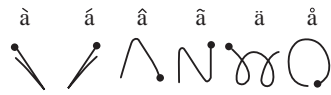

Using these accent strokes, you can write the following accented letters:

à á â ã ä å è é ê ë ì í î ï ò ó ô õ ö ù ú û ü ÿ ñ

Additional non-English characters

You can write the following characters without any special punctuation or shifting:

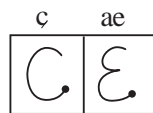

NOTE You must write these non-English characters in the left side of the Graffiti writing area.

Navigation strokes

In addition to character symbols, Graffiti writing includes special strokes that you can use to navigate within text or fields in your applications.

Command	Stroke
Move cursor right	
Move cursor left	
Previous field (Address Book only)	
Next Field (Address Book only)	
Open Address Record (Address Book only)	

Graffiti ShortCuts

Graffiti ShortCuts make entering commonly used words or phrases quick and easy. ShortCuts are similar to the Glossary or Autotext features of some word processors.

Graffiti writing comes with several predefined ShortCuts, and you can also create your own. Each ShortCut can represent up to 45 characters. For example, you

might create a ShortCut for your name, or for the header of a memo. See [“ShortCuts preferences”](#) in [Chapter 15](#) to learn about creating your own ShortCuts.

To use a ShortCut, draw the ShortCut stroke followed by the ShortCut characters. When you draw the ShortCut stroke, the ShortCut symbol appears at the insertion point to show that you are in ShortCut mode.

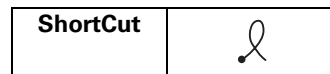



Your handheld includes the following predefined Graffiti ShortCuts:

Entry	ShortCut
Date stamp	ds
Time stamp	ts
Date/time stamp	dts
Meeting	me
Breakfast	br
Lunch	lu
Dinner	di

Using Note Pad

In addition to using the onscreen keyboard and Graffiti characters, you can enter data on your handheld using the Note Pad application. When you use Note Pad, you write quick notes directly on the handheld screen in your own handwriting. Later, you can enter this information into another application, or delete it. See [“Using Note Pad”](#) in [Chapter 11](#) for more information and instructions.

To use Note Pad:

1. Tap the Home icon .
2. Tap the Note Pad icon .
3. Write the information directly on the handheld screen.
4. Tap Done.

Beaming data

Your handheld is equipped with an IR port that is located at the top of the handheld, behind the dark shield. The IR port supports the IrCOMM implementation of the standards for infrared communication established by the Infrared Data Association (IrDA). This means that not only can you beam data to another Palm OS® handheld that is close by and equipped with an IR port, but you can also beam data to a mobile phone or any other device that supports the IrCOMM implementation of the IrDA standards and can read the type of data you're beaming.

You can beam the following information between devices with an IR port:

- The record currently displayed in Date Book, Address Book, To Do List, Note Pad, or Memo Pad
- All records of the category currently displayed in Address Book, To Do List, Note Pad, or Memo Pad
- A special Address Book record that you designate as your business card, containing information you want to exchange with business contacts
- An application installed in memory

NOTE You can also perform HotSync® operations using the IR port. See [“IR HotSync operations”](#) in [Chapter 14](#) for more details.

To select a business card:

1. Create an Address Book record that contains the information you want on your business card.
2. Tap the Menu icon .
3. Tap Select Business Card on the Record menu.
4. Tap Yes.

To beam a record, business card, or category of records:

1. Locate the record, business card, or category you want to beam.
2. Tap the Menu icon .
3. Tap one of the following on the Record menu:
 - The Beam command for an individual record
 - In Address Book only: Beam Business Card
 - Beam Category

TIP You can also beam a business card by holding down the Address Book application button  until the Beam Status dialog box appears.



4. When the Beam Status dialog box appears, point the IR port directly at the IR port of the receiving device.

TIP For best results, Palm handhelds should be between 10 centimeters (approximately 4 inches) and 1 meter (approximately 39 inches) apart, and the path between the two handhelds must be clear of obstacles. Beaming distance to other devices may be different.



5. Wait for the Beam Status dialog box to indicate that the transfer is complete before you continue working on your handheld.

To beam an application:

1. Tap the Home icon .
2. Tap the Menu icon .
3. Tap Beam on the App menu.
4. Tap the application you want to transfer.

NOTE Some applications are copy-protected and cannot be beamed. These are listed with a lock icon next to them.

5. Tap Beam.
6. When the Beam Status dialog box appears, point the IR port directly at the IR port of the receiving device.
7. Wait for the Beam Status dialog box to indicate that the transfer is complete before you continue working on your handheld.

To receive beamed information:

1. Turn on your handheld.
2. Point the IR port directly at the IR port of the transmitting device to open the Beam dialog box.
3. Once you have received the file, select a category for the incoming information, create a new category, or leave the information unfiled.



4. Tap Yes.

Tips on beaming information

- You can set the full-screen pen stroke to beam the current entry. See “[Pen preferences](#)” in [Chapter 15](#) for more information.
- You can draw the Graffiti Command stroke to activate the Command toolbar, and then tap the beam icon.
- You can use the Graffiti Command stroke “/ B” to beam the current entry.

Using your computer keyboard

If you have a lot of data to enter, or prefer to use the computer keyboard, you can use Palm Desktop software or any supported PIM to enter information. You can then perform a HotSync operation to synchronize the information on your computer with the information on your handheld. For more information on entering data on your computer, refer to the online Help in Palm Desktop software, the *Quick Tour* in Palm Desktop software (for Windows users), and the *Palm Desktop Software for the Macintosh User's Guide* on the Palm Desktop software CD-ROM.

Importing data

If you have data stored in computer applications such as spreadsheets and databases, or if you want to import data from another handheld, you can transfer the data to your handheld without having to key it in manually. Save the data in one of the file formats listed below, import it into Palm Desktop software, and then perform a HotSync operation to transfer the data to your handheld.

Importing data from a Windows computer

Palm Desktop software can import data in the following file formats:

- Comma delimited (.csv, .txt): Address Book and Memo Pad only
- Tab delimited (.tab, .tsv, .txt): Address Book and Memo Pad only
- CSV (Lotus Organizer 2.x/97 Mapping): Address Book only
- vCal (.vcs): Date Book only
- vCard (.vcf): Address Book only
- Date Book archive (.dba)
- Address Book archive (.aba)
- To Do List archive (.tda)
- Memo Pad archive (.mpa)

Archive formats can only be used with Palm Desktop software. Use the archive file formats to share information with other people who use a Palm OS handheld or to create a copy of your important Palm Desktop information.

To import data from a Windows computer:

1. Open Palm Desktop software.
2. Click the application into which you want to import data.
3. If you are importing records that contain a field with category names, do the following:
 - Select All in the Category box.
 - Be sure that the same categories that appear in the imported file also exist in the application. If the categories do not exist, create them now; otherwise, the records are imported into the Unfiled category.
4. From the File menu, select Import.
5. Select the file you want to import.
6. Click Open.

NOTE If you are importing a vCal or vCard file, skip to step 10. You do not have to specify which fields correspond to the imported data.

7. To import data into the correct Palm Desktop fields, drag fields in the left-hand column so that they are opposite the corresponding imported field on the right.
8. If you do not want to import a field, deselect the check box for that field.
9. Click OK.

The imported data is highlighted in the application.

10. To add the imported data to your handheld, perform a HotSync operation.

See Palm Desktop online Help for more information on importing and exporting data.

Importing data from a Mac

Palm Desktop software can import data from any of the following applications when you export the data in the appropriate file format:

- Address Book Plus (text file)
- Claris Organizer (Palm Desktop software can open these files directly)
- ClarisWorks (save under new name as ASCII text file)
- DateBook Pro (text file)
- DayMaker (text file)
- Dynodex (text file)
- FileMaker Pro (tab separated text file)
- Meeting Maker (text file)

- Newton running OS 1.0 with Newton Connection Kit: Names; Date Book Calendar; and Notepad (text file)
- Now Contact (text file)
- Now Up-to-Date (text file)
- QuickDex (text file)
- TouchBase Pro (text file)

Palm Desktop software can also import data in the following file formats:

- Tab delimited (.tab, .tsv, .txt)
- vCal (.vcs): Date Book only
- vCard (.vcf): Address Book only

To import data from a Mac:

1. Open Palm Desktop software.
2. From the File menu, select Import.
3. Select the file you want to import.
4. Click Import.
5. If you want to change the order of the fields you're importing, point to a field, wait for the cursor to change to a double arrow, and then drag the field to a new location.
6. If you do not want to import a field, click the arrow between the field names.
7. From the Fields pop-up menu, select the appropriate field.
8. From the Delimiters pop-up menu, select the appropriate delimiter.
9. Click OK.
10. To add the imported data to your handheld, perform a HotSync operation.

See Palm Desktop online Help for more information on importing and exporting data.

Working with Applications

This chapter explains how to open and switch between applications on your handheld, how to change application settings so they are personalized to your work methods, and how to categorize applications so you view them in related groups.

Opening applications

Tapping the Home icon opens the Applications Launcher, which allows you to open any application installed on your handheld. You can also open Date Book and Address Book with the application buttons on the front panel of your handheld.

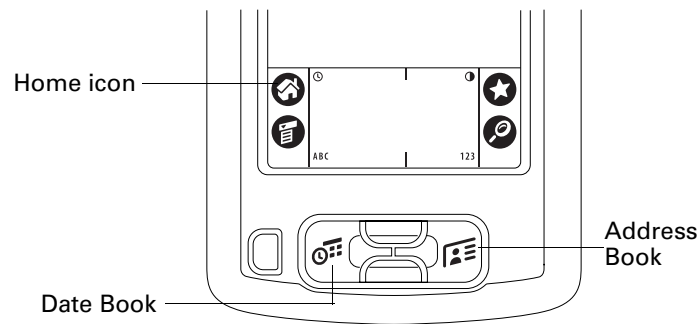

In addition to providing a way for you to open applications, the Applications Launcher displays the current time, battery level, and application category.

To open an application on your handheld:

1. Tap the Home icon .



2. Tap the icon of the application that you want to open. If you have many applications installed on your handheld, tap the scroll bar to see all of your applications.

TIP To find an application quickly, you can write the Graffiti® character for the first letter of its name. The Applications Launcher scrolls to the first application with a name that begins with that letter.



Switching between applications

When working in any application, tap the Home icon  or press an application button on the front panel of your handheld to switch to another application. Your handheld automatically saves your work in the current application and displays it when you return to that application.

Categorizing applications

The category feature enables you to manage the number of application icons that appear onscreen in the Applications Launcher. You can assign an application to a category and then display a single category or all your applications.

To categorize an application:

1. Tap the Home icon .
2. Tap the Menu icon .
3. Tap Category on the App menu.

4. Tap the pick list next to each application to select a category.

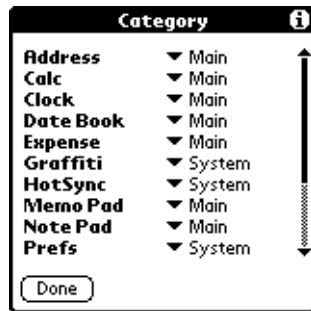

TIP To create a new category, tap Edit Categories from the pick list. Tap New, enter the category name, and then tap OK to add the category. Tap OK.

5. Tap Done.



To display applications by category:

1. Tap the Home icon .
2. Do one of the following:
 - Tap the Home icon repeatedly to cycle through all your categories.
 - Tap the pick list in the upper-right corner of the screen and select the category you want to display.

Changing the Applications Launcher display

By default, the Applications Launcher displays each application as an icon. As an alternative, you can choose to show a list of applications. You can also choose to view the same category of applications each time you open the Applications Launcher.



To change the Applications Launcher display:

1. Tap the Home icon .
2. Tap the Menu icon .
3. Tap Options, and then tap Preferences.

4. Tap the View By pick list and select List.
5. Tap OK.



To open the Applications Launcher to the last opened category:

1. Tap the Home icon .
2. Tap the Menu icon .
3. Tap Options, and then tap Preferences.
4. Tap the Remember Last Category check box to select it.
5. Tap OK.

Using menus

Menus on your handheld are easy to use. Once you have mastered them in one application, you can use them the same way in all other applications.

The menus of each application are illustrated in the chapter on that application.

To open the menu bar:

1. Open an application (such as Memo Pad).
2. Do one of the following:
 - Tap the Menu icon .
 - Tap the inverted title area at the top of the screen.

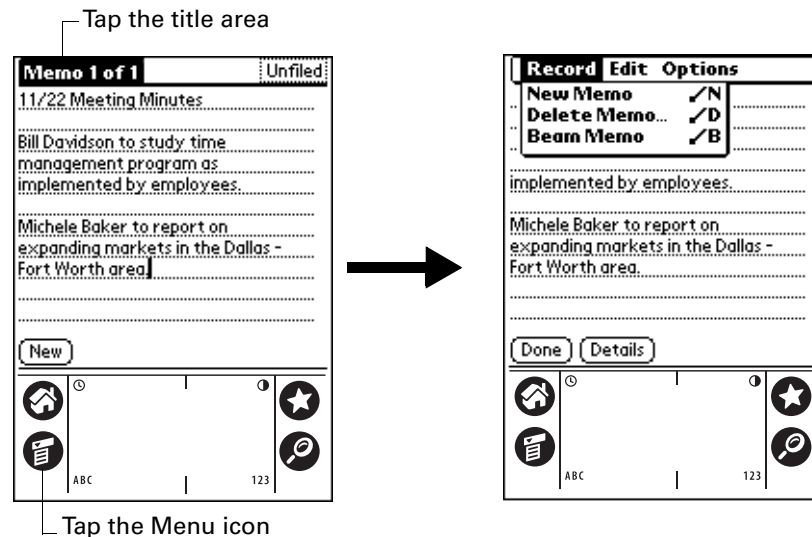

In this example, three menus are available: Record, Edit, and Options. The Record menu is selected and contains the commands New Memo, Delete Memo, and Beam Memo.

Choosing a menu

After you open the menu bar for an application, tap the menu that contains the command you want to use.

The menu and menu commands that are available depend on the application that is currently open. Also, the menus and menu commands vary depending on *which part* of the application you're currently using. For example, in Memo Pad, the menus are different for the Memo list screen and the Memo screen.

Graffiti menu commands

Most menu commands have an equivalent Graffiti Command stroke, which is similar to the keyboard shortcuts used to execute commands on computers. The command letters appear to the right of the command names.

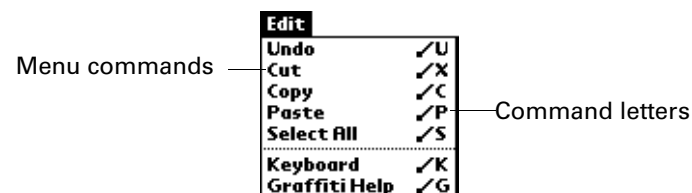

Draw the Command stroke anywhere in the Graffiti area. When you draw the Command stroke, the Command toolbar appears just above the Graffiti writing area to indicate that you are in Command mode.

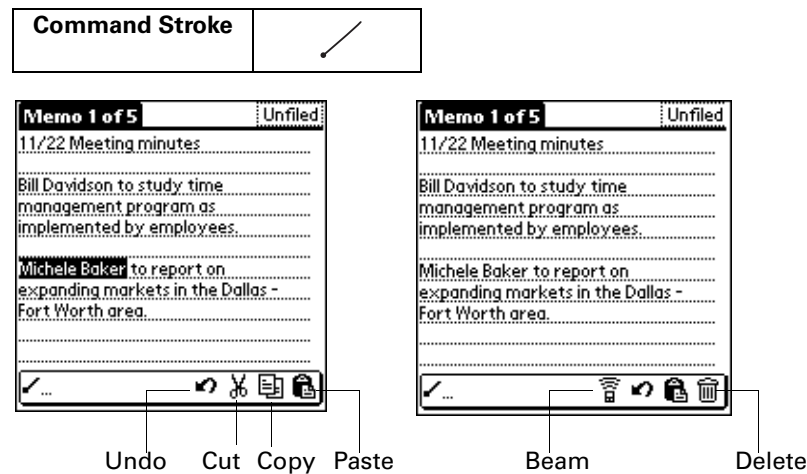

The command toolbar displays context-sensitive menu commands for the current screen. For example, if text is selected the menu icons displayed may be undo, cut, copy, and paste. Tap an icon to select the command, or immediately write the corresponding command letter for an appropriate command in the Graffiti writing area.

For example, to choose Select All in the Edit menu, draw the Command stroke, followed by the letter “s.”

NOTE Command mode is only active for a short time, so you must tap an icon or write the command letter immediately to choose the menu command.

Choosing application preferences

You can set options that affect an entire application in the application’s Preferences dialog box.

To change preferences for an application:

1. Open an application.
2. Tap the Menu icon .
3. Tap Options, and then tap Preferences.

NOTE Not all applications have a Preferences command.

4. Make changes to the settings.
5. Tap OK.

Common tasks

The tasks described in this section use the term “records” to refer to an individual item in any of the applications: a single Date Book event, Address Book entry, To Do List item, Note Pad note, Memo Pad memo, or Expense item.

Creating records

You can use the following procedure to create a new record in Date Book, Address Book, To Do List, Note Pad, Memo Pad, and Expense.

To create a record:

1. Select the application in which you want to create a record.
2. Tap New.
3. In Date Book only: Select start and end times for your appointment and tap OK.
4. Enter text for the record.
5. (Optional) To select attributes for the record:
 - In Date Book, Address Book, To Do List, and Memo Pad, tap Details.
 - In Note Pad, tap the Menu icon , and then tap Options and Details.
6. In Address Book, Note Pad, and Memo Pad only: Tap Done.

There's no need to save the record because your handheld saves it automatically.

Editing records

After you create a record, you can change, delete, or enter new text at any time. Two screen features tell you when your handheld is in editing mode:

- A blinking cursor
- One or more dotted edit lines

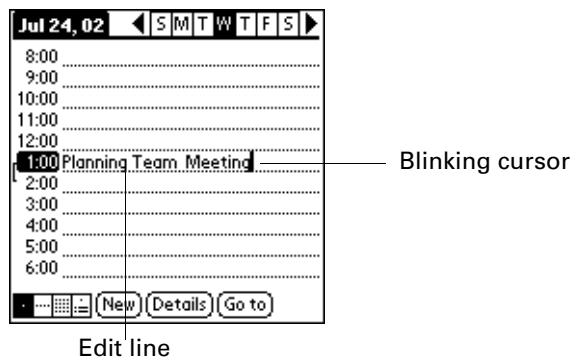

NOTE In Note Pad you can write anywhere on the screen. So, you will not see an edit line or blinking cursor.

Entering text

For information on how to enter text using Graffiti writing, the onscreen keyboard, or the keyboard attached to your computer, see [Chapter 3](#). For information on entering text in Note Pad, see [Chapter 11](#).

Edit menu

The Edit menu is available with any screen where you enter or edit text. In general, commands available in the Edit menu apply to text that you *select* in an application.

To select text in an application:

1. Tap the beginning of the text that you want to select.
2. Drag the stylus over the text to highlight it (in black).

NOTE You can double-tap to select a word, or triple-tap to select a line of text. You can also drag *across* the text to select additional words, or drag *down* to select a group of lines.

The following commands may appear in an Edit menu:

Undo	Reverses the action of the <i>last edit</i> command. For example, if you used Cut to remove text, Undo restores the text you removed. Undo also reverses deletions done by using backspace. When the drawing area is selected in Note Pad, Undo erases the last line drawn.
Clear Note	Erases the drawing from a note in Note Pad. Clear Note appears in the Edit menu only when the drawing area is selected.
Cut	Removes the selected text and stores it temporarily in the memory of your handheld. You can paste the text you cut into another area of the current application or into a different application.
Copy	Copies the selected text and stores it temporarily in the memory of your handheld. You can paste the text that you copy into another area of the current application or into a different application.
Paste	Inserts the text that you cut or copied at the selected point in a record. The text you paste replaces any selected text. If you did not previously cut or copy text, Paste does nothing.
Select All	Selects all of the text in the current record or screen. This enables you to cut or copy all of the text and paste it elsewhere.
Keyboard	Opens the onscreen keyboard. When you finish with the onscreen keyboard, tap Done.
Graffiti Help	Opens screens that show all the Graffiti character strokes. Use this command anytime you forget a stroke for a character.

Deleting records

To delete a record:

1. Select the record you want to delete.
2. Tap the Menu icon .
3. Tap Record, and then tap the Delete command:

Date Book: Delete Event

Address Book: Delete Address

To Do List: Delete Item

Note Pad: Delete Note

Memo Pad: Delete Memo

Expense: Delete Item

A confirmation dialog box appears. If you want to save a copy of the deleted item to an archive file in Palm™ Desktop software, be sure that the check box is selected. If you don't want to save a copy, tap the check box to deselect it. (The archive check box does not appear in Note Pad because you can't archive Note Pad notes.)

4. Tap OK.

If you choose to save a copy of the selected item, your handheld transfers it to the archive file on your desktop the next time you perform a HotSync® operation.

Other ways to delete records

You can also delete records in the following ways:

- In Date Book, Address Book, To Do List, and Memo Pad, open the Details dialog box for the record, tap Delete, and then tap OK.
- In Note Pad, open the note you want to delete, and then tap Delete.
- Delete the text of the record.

NOTE In Date Book, you can choose to delete the text of the current repeating event, current and future events, or all instances of that event.

Purging records

Over time, as you use Date Book, To Do List, and Expense, you'll accumulate records in these applications that have outlived their usefulness. For example, events that occurred months ago remain in Date Book, and To Do List items that you marked as completed remain in the list, as do Expense items.

All these outdated records take up memory on your handheld, so it's a good idea to remove them by using Purge. If you think Date Book or To Do List records might

prove useful later, you can purge them from your handheld and save them in an archive file on your computer.

Purging is not available in Address Book, Note Pad, or Memo Pad; you must delete outdated records manually from these applications.

To purge records:

1. Open the application.
2. Tap the Menu icon .
3. Tap Record, and then tap Purge.

A confirmation dialog box appears.

Date Book: Tap the pick list and select how old a record must be to be purged. Purge deletes repeating events if the last of the series ends before the date that you purge records.

Date Book, To Do List: If you want to save a copy of the purged records to an archive file on your desktop, be sure that the check box is selected. If you don't want to save a copy, tap the check box to deselect it.

4. Tap OK.

If you chose to save a copy of the purged records, your handheld transfers them to an archive file on your desktop the next time you perform a HotSync operation.

NOTE Purging does not happen automatically. You must tap the command to make it happen.

Categorizing records

Categorize records in Address Book, To Do List, Note Pad, Memo Pad, and Expense so that they are grouped logically and are easy to review. (You can also categorize applications. See [“Categorizing applications”](#) in [Chapter 4](#) for more information.)

When you create a record, your handheld automatically places it in the category that is currently displayed. If the category is All, your handheld assigns it to the Unfiled category. You can leave an entry as Unfiled or assign it to a category at any time.

System-defined and user-defined categories

By default, your handheld includes system-defined categories, such as All and Unfiled, and user-defined categories, such as Business and Personal.

You cannot modify the system-defined categories, but you can rename and delete the user-defined categories. In addition, you can create your own user-defined categories. You can have a maximum of 15 user-defined categories in each application.

Address Book contains the QuickList user-defined category, in which you can store the names, addresses, and phone numbers you might need in emergencies (doctor, fire department, lawyer, etc.).

Expense contains two user-defined categories, New York and Paris, to show how you might sort your expenses according to different business trips.

NOTE The illustrations in this section come from Address Book, but you can use these procedures in all the applications in which categories are available.

To move a record into a category:

1. Select the record you want to categorize.
2. In Address Book only: Tap Edit.
In Note Pad only: Tap the Menu icon , and then tap Options.
3. Tap Details.
4. Tap the Category pick list to display the list of available categories.



5. Select the category for the record.
6. Tap OK.

NOTE In Address Book, Note Pad, and Memo Pad you can tap the category name in the upper-right corner of the screen and select a new category for the item.

To display a category of records:

1. Tap the category pick list in the upper-right corner of the list screen.

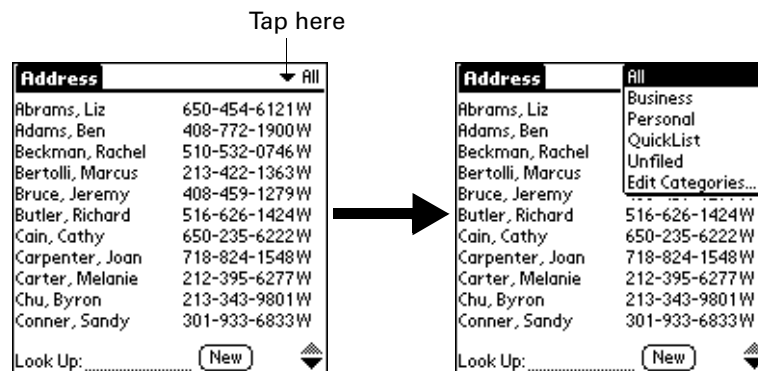

NOTE In the Date Book Agenda view, the pick list is in the upper-right corner of the To Do list.

2. Select the category you want to view.

The list screen now displays only the records assigned to that category.

TIP Pressing an application button on the front panel of the handheld toggles through all the categories of that application.

To define a new category:

1. Tap the category pick list in the upper-right corner of the list screen.

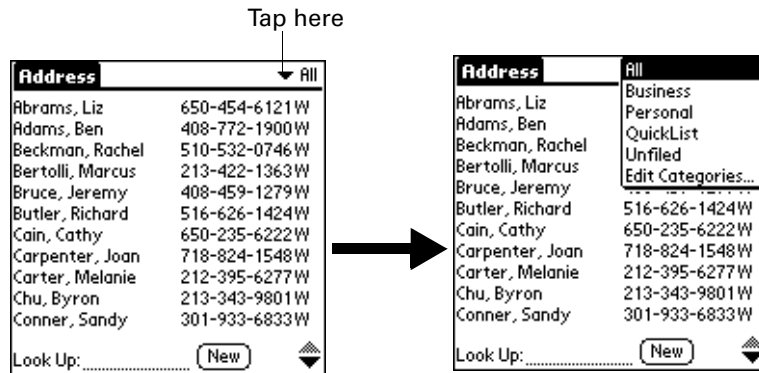

2. Tap Edit Categories.
3. Tap New.



4. Enter the name of the new category, and then tap OK.



5. Tap OK.

You can assign any of your records to the new category.

To rename a category:

1. Tap the category pick list in the upper-right corner of the list screen.
2. Tap Edit Categories.
3. Select the category that you want to rename, and then tap Rename.



4. Enter the new name for the category, and then tap OK.



5. Tap OK.

TIP You can group the records in two or more categories into one category by giving the categories the same name. For example, if you change the name of the Personal category to Business, all records formerly in the Personal category appear in the Business category.

Finding information

Your handheld offers several ways to find information quickly:

- **All applications that reside on your handheld:** Find locates any text that you specify, always starting with the current application.
- **Date Book, To Do List, Memo Pad:** Phone Lookup displays the Address list screen and lets you add the information that appears in this list to a record.
- **Address Book:** The Look Up line lets you enter the first letters of a name to scroll immediately to that name.
- **Expense:** Lookup displays the names in your Address Book that have data in the Company field. You can add these names to a list of attendees associated with an Expense record.

Using Find

You can use Find to locate any text that you specify, in any application that resides on your handheld.

To use Find:

1. Tap the Find icon .

TIP If you select text in an application before you tap Find, the selected text automatically appears in the Find dialog box.

2. Enter the text that you want to find.

Find is *not* case-sensitive. For example, searching for the name “davidson” also finds “Davidson.”

Find locates any words that begin with the text you enter. For example, searching for “plane” finds “planet,” but not “airplane.”

3. Tap OK.

Find searches for the text in all records and all notes.

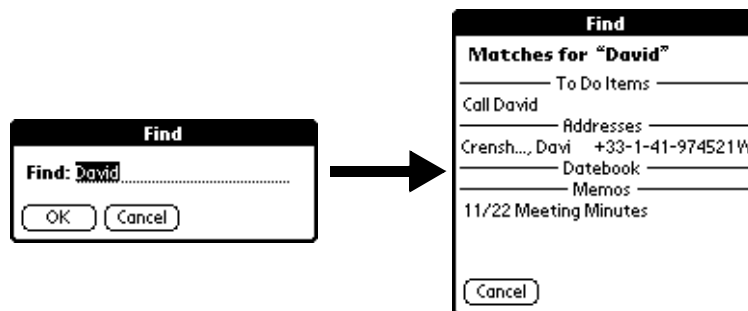

As your handheld searches for the text, you can tap Stop at any time. You may want to do this if the entry you want appears before your handheld finishes the search. To continue the search after you tap Stop, tap Find More.

4. Tap the text that you want to review.

Using Phone Lookup

Phone Lookup displays the Address list screen and lets you add the information that appears in this list to a record.

To use Phone Lookup:

1. Display the record in which you want to insert a phone number. The record can be in Date Book, To Do List, or Memo Pad.
2. Tap the Menu icon .
3. Tap Options, and then tap Phone Lookup.
4. Begin to spell the last name of the name you want to find.

The list scrolls to the first record in the list that starts with the first letter you enter. Continue to spell the name you're looking for, or when you see the name, tap it.

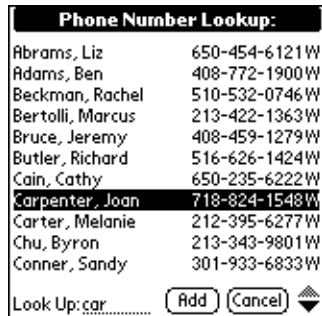

5. Tap Add.

The name you selected, along with the other information associated with it, is pasted into the record you selected in step 1.

Phone Lookup tips

Write the Graffiti Command stroke “/L” to activate the Phone Lookup feature. You can also activate it in the following circumstances:

- **While entering text:** For example, to insert the full name and phone number for someone with the last name “Williams,” write the Graffiti characters for “Wi” and then the Phone Lookup Command stroke “/L.” Assuming you have only one Address Book record that begins with “Wi,” your handheld inserts the full name “Fred Williams” (and its associated information). If you have more than one name that begins with “Wi,” the Phone Lookup screen appears and highlights the first record that begins with “Wi.”
- **For selected text:** Drag to highlight the text, and then write the Phone Lookup Command stroke “/L.” Your handheld replaces the selected text and adds the name and its associated information.

Looking up Address Book records

When working with Address Book, the scroll button on the front panel of the handheld makes it easy to navigate among your address entries.

- In the Address list screen, the scroll button moves up or down an entire screen of records. If you hold down the scroll button, you accelerate the scrolling and display every third screen.
- In the Address view screen, the scroll button moves to the previous or next address record.

You can also use the Address list Look Up feature to quickly scroll to any of your Address Book entries.

To look up an Address Book record:

1. Display the Address list screen.
2. Enter the first letter of the name you want to find.

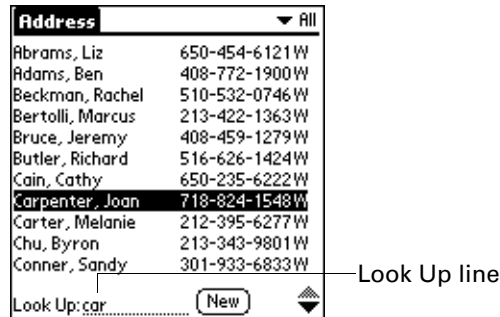

The list scrolls to the first entry that begins with that letter. If you write another letter, the list scrolls to the first entry that starts with those *two* letters. For example, writing an “s” scrolls to “Sands,” and writing “sm” scrolls further to “Smith.” If you sort the list by company name, the Look Up feature scrolls to the first letter of the company name.

3. Tap the record to view its contents.

Looking up names to add to Expense records

In Expense, Lookup displays the names in your Address Book that have data in the Company field. You can add these names to a list of attendees associated with an Expense record.

To add names to an Expense record:

1. Tap the Expense record to which you want to add names.
2. Tap Details.



3. Tap Who.

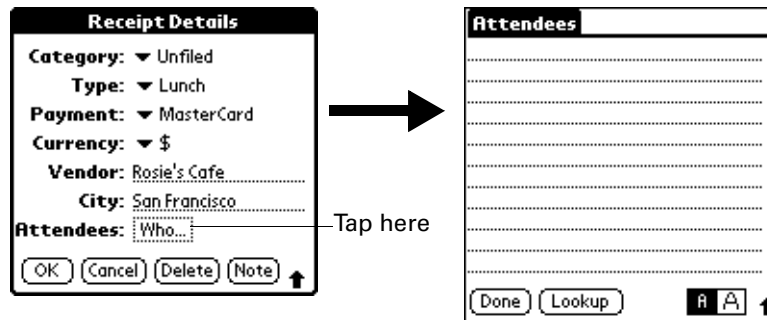

4. Tap Lookup.

The Attendees Lookup screen displays all the names in your Address Book that have data in the Company field.

5. Select the name you want to add, and then tap Add.

The name appears in the Attendees screen.

6. Repeat steps 4 and 5 to add more names.
7. Tap Done.
8. Tap OK.

Sorting lists of records

You can sort lists of records in various ways, depending on the application. Sorting is available in applications that have list screens: Address Book, To Do List, Memo Pad, and Expense.

NOTE You can also assign records to categories. See [“Categorizing records”](#) earlier in this chapter.

To sort records in To Do List and Expense:

1. Open the application to display the list screen.
2. Tap Show.
3. Tap the Sort by pick list and select an option.
4. Tap OK.

To sort records in Address Book, Note Pad, and Memo Pad:

1. Open the application.
2. In Note Pad only: Tap Done to display the list screen.
3. Tap the Menu icon .
4. Tap Options, and then tap Preferences.

Address Book:

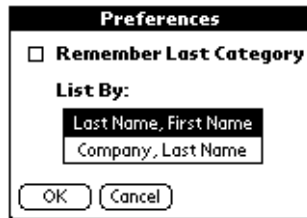

Note Pad:

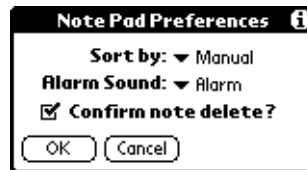

Memo Pad:

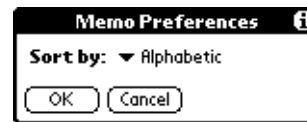

5. Do one of the following:

Address Book: Tap the setting you want.

Note Pad: Tap the Sort by pick list and select Alphabetic, Date, or Manual.

Memo Pad: Tap the Sort by pick list and select Alphabetic or Manual.

6. Tap OK.

To sort the Note Pad or Memo list manually, tap and drag a memo or note to a new location in the list.

NOTE To make the list of your memos appear in Palm Desktop software as you manually sorted it on your handheld, open Memo Pad in Palm Desktop software and click List by. Then select Order on handheld.

Attaching notes

In applications except Memo Pad and Note Pad, you can attach a note to a record. A note can be up to several thousand characters long. For example, for an appointment in Date Book, you can attach a note with directions to the location.

To attach a note to a record:

1. Display the entry to which you want to add a note.
2. In Address Book only: Tap Edit.

3. Tap Details.
4. Tap Note.
5. Enter your note.
6. Tap Done.

A small note icon appears at the right side of any item that has a note.

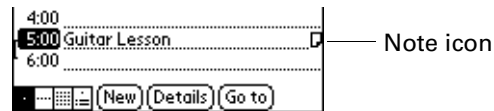

To review or edit a note:

- Tap the Note icon .

To delete a note:

1. Tap the Note icon .
2. Tap Delete.
3. Tap Yes.

Choosing fonts

In many applications, you can change the font style to make text easier to read. You can choose a different font style for each application.

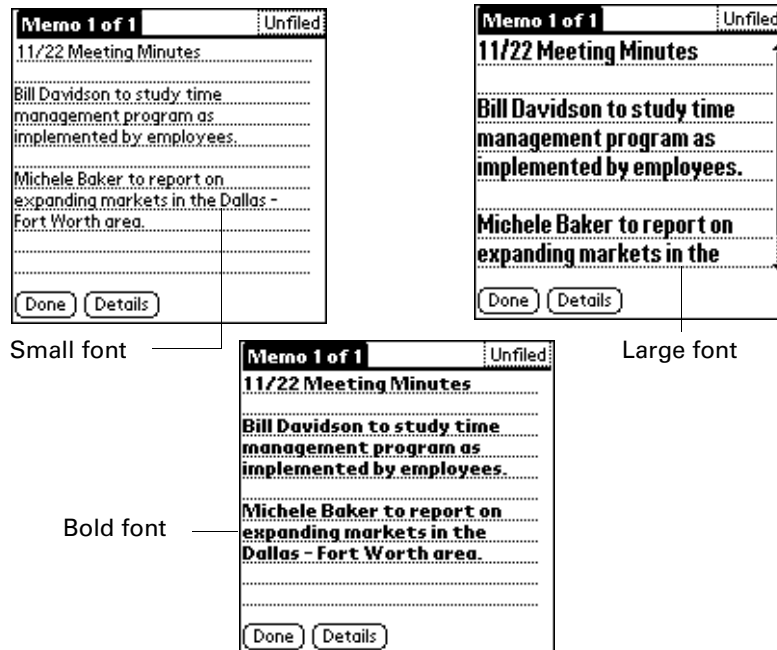

To change the font style:

1. Open an application.
2. Tap the Menu icon .
3. Tap Options, and then tap Font.
4. Tap the font style you want to use.

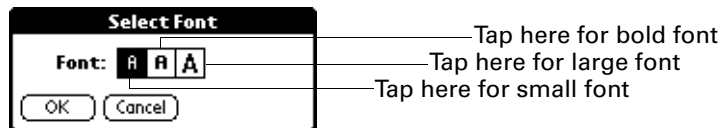

5. Tap OK.

Reviewing Reminders

You can set alarms to notify you of appointments, notes, and alarms in Date Book, Note Pad, and Clock. When an alarm occurs, your handheld displays a reminder message. If you tap Snooze in response to an alarm message, your handheld reminds you of the alarm again in five minutes. The Reminder screen displays alarms that await attention.

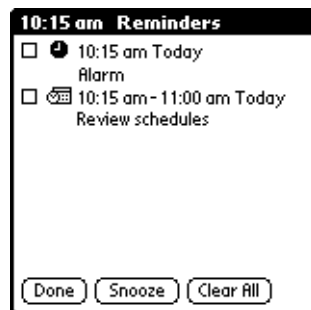
**To respond to reminders, do one of the following:**

- Select an item's check box to clear the item.
- Tap an item (either the icon or the text description) to open the application where the alarm was set. The application opens to the entry associated with the alarm.
- Tap Done to close the reminder list and return to the current screen. An attention indicator will blink in the upper-left corner of the screen; tap it to view the reminder list again.
- Tap Snooze to see the list again in five minutes.
- Tap Clear All to dismiss all reminders in the list.

NOTE If you tap Done or Snooze and view the reminder list later, the current time displays in the Reminder bar and the original alarm time displays with each list item.

Receiving reminders from Palm Desktop software

You can also set an option to receive Date Book event alerts from Palm Desktop software. The feature is disabled by default, so you must enable it within Palm Desktop software.

To enable an event alert from Palm Desktop software:

1. Double-click the Palm Desktop icon.
2. From the Tools menu, select Options, and then select Alarms.
3. Set Alarm Configuration options, either Always Available or Available only when the Palm Desktop is running.
4. (Optional) To hear an alert sound as well as receiving an alert message, select the check box to Play audible notification with alarm dialog.
5. Click OK.

Hiding or masking private records

You can use the Security application to set a password and select whether to mask your private records or hide them completely. See [Chapter 12](#) for details.

Installing and removing applications

This section explains how to install and remove applications on your handheld, and how to remove Palm Desktop software from your computer.

Installing add-on applications

Your handheld comes with the Date Book, Address Book, To Do List, Note Pad, Memo Pad, Calculator, and Expense applications installed and ready to use.

You can also install additional applications on your handheld such as games and other software. The Install Tool makes it easy to install software during a HotSync operation. There are a variety of third-party applications available for your handheld. To learn more about these applications, visit the web site www.palm.com.

Any game or application that you install on your handheld resides in memory; you can delete them at any time.

NOTE Some add-on applications may not be compatible with the two-button handheld model.

To install add-on software on your handheld using a Windows computer:

1. On your computer, copy or download the application you want to install into the Add-on folder in your Palm Desktop directory on your computer.

NOTE If the software you download is compressed, you need to decompress it into this folder. If you prefer to place the application into another folder, you need to navigate to that folder before you complete step 5.

2. Double-click the Palm Desktop icon on your desktop.
3. Click Install.

TIP You can also access the Install Tool dialog box by selecting Install Tool from the Palm Desktop program group or by double-clicking any file with a PRC, PDB, POA, PNC, or SCP file extension.

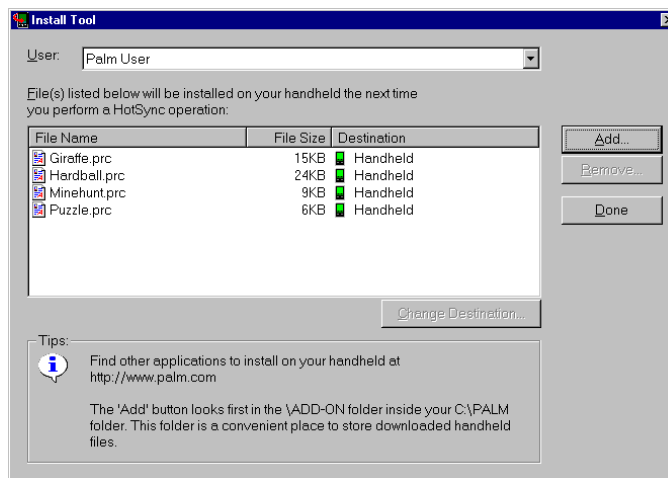

4. In the User selector, select the name that corresponds to your handheld.
5. Click Add.

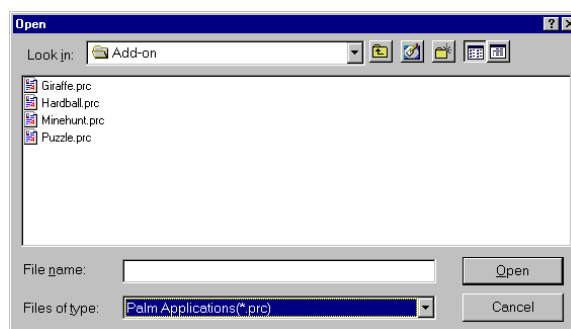

6. Select the application(s) that you want to install on your handheld.
7. Click Open.

NOTE Review the list of applications you selected in the Install Tool dialog box. If you do not want to install an application, select it, and then click Remove. (This does not remove the application from your computer; it simply removes it from the list of applications to install.)

8. Click Done to close the Install Tool window.
9. Perform a HotSync operation to install the selected application(s). See “Performing HotSync® Operations” in Chapter 14 for details.

NOTE Files that remain in the list after you perform a HotSync operation did not install. This can happen if the file type was not recognized during the HotSync operation.

To install add-on software on your handheld using a Mac:

1. On your computer, copy or download the application you want to install into the Add-on folder in your Palm folder.

NOTE If the software you download is compressed, you need to decompress it into this folder.

2. Double-click the HotSync Manager icon in the Palm folder.
3. From the HotSync menu, choose Install Handheld Files.

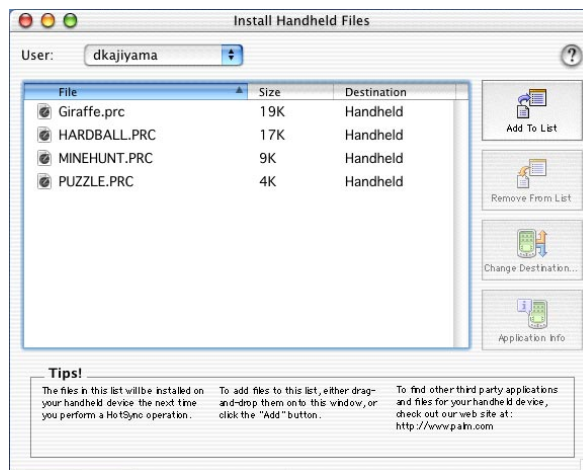

4. From the User pop-up menu, select the name that corresponds to your handheld.
5. Click Add to List.

6. Select the Add-on folder from the pop-up menu.

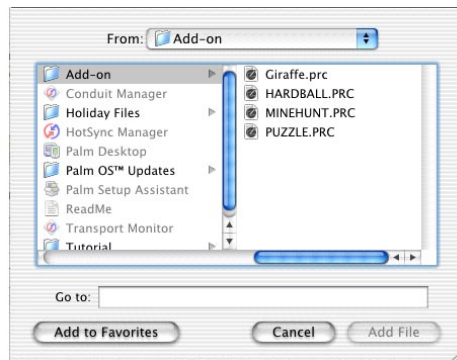

7. Select the application you want to install.

If the file you want to install is not listed in the dialog box, go to the folder where you copied the file. Most Palm™ application files have the extension PRC, PDB, PQA, or SCP.

8. Click Add File to add the selected application to the Install Handheld Files list.

TIP You can also drag files or folders to the list in the Install Handheld Files dialog box. The files are copied to the Files To Install folder.



9. Close the Install Handheld Files window.
10. Perform a HotSync operation to install the selected application(s) on your handheld. See [“Performing HotSync® Operations”](#) in [Chapter 14](#) for details.

NOTE Files that remain in the list after you perform a HotSync operation did not install. This can happen if the file type was not recognized during the HotSync operation.

Removing applications

In the event that you run out of memory or decide that you no longer need an application you installed, you can remove applications from your handheld. You can remove only add-on applications, patches, and extensions that you install; you cannot remove the applications that were pre-installed on your handheld.

To remove an add-on application:

1. Tap the Home icon .
2. Tap the Menu icon .
3. Tap Delete on the App menu.

4. Tap the application that you want to remove.



5. Tap Delete.
6. Tap Yes.
7. Tap Done.

Removing Palm Desktop software

If you no longer want to use Palm Desktop software, you can remove it from your computer.

To remove Palm Desktop software from a Windows computer:

1. From the Windows Start menu, select Settings, and then select Control Panel.
2. Double-click the Add/Remove Programs icon.
3. Select Palm Desktop.
4. Click Add/Remove.

NOTE This process removes only the application files. The data in your Users folder remains untouched.

5. Follow the onscreen prompts. Be sure to select the option to remove Palm Desktop software.

NOTE You need to install HotSync Manager from the installation CD if you want to synchronize data with another PIM.

To remove Palm Desktop software from a Mac:

1. Insert the Palm Desktop CD into your computer's CD-ROM drive.
2. Locate the Palm Desktop Installer icon and double-click this icon.
3. From the Easy Install screen, select Uninstall from the pop-up menu.
4. Select the software you want to remove.
5. Click Uninstall.

6. Select the folder that contains your Palm Desktop software files.
7. Click Remove.

NOTE This process removes only the application files. The data in your Users folder remains untouched.

8. Restart your computer.

Using Address Book

 Address Book enables you to keep names, addresses, phone numbers, and other information about your personal or business contacts. Use Address Book to do the following:

- Quickly look up or enter names, addresses, phone numbers, and other information.
- Enter up to five phone numbers (home, work, fax, mobile, etc.) or e-mail addresses for each name.
- Define which phone number appears in the Address list for each Address Book entry.
- Attach a note to each Address Book entry, in which you can enter additional information about the entry.
- Assign Address Book entries to categories so that you can organize and view them in logical groups.
- Create your own digital business card that you can beam to other devices with an IR (infrared) port.

To open Address Book:

- Press the Address Book application button on the front panel of your handheld. Address Book opens to display the list of all your records.

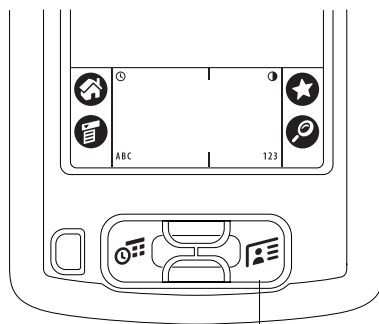

Address Book button

NOTE Press the Address Book application button repeatedly to cycle through the categories in which you have records. Press and hold the Address Book application button to instantly beam your business card to another device with an IR port.

Creating an Address Book entry

A record in Address Book is called an “entry.” You can create entries on your handheld, or you can use Palm™ Desktop software to create entries on your computer and then download the entries to your handheld with your next HotSync® operation.

Palm Desktop software also has data import capabilities that enable you to load database files into Address Book on your handheld.

See “Importing data” in Chapter 3 and Palm Desktop online Help for more information.

To create a new Address Book entry:

1. Press the Address Book application button  on the front of your handheld to display the Address list.
2. Tap New.

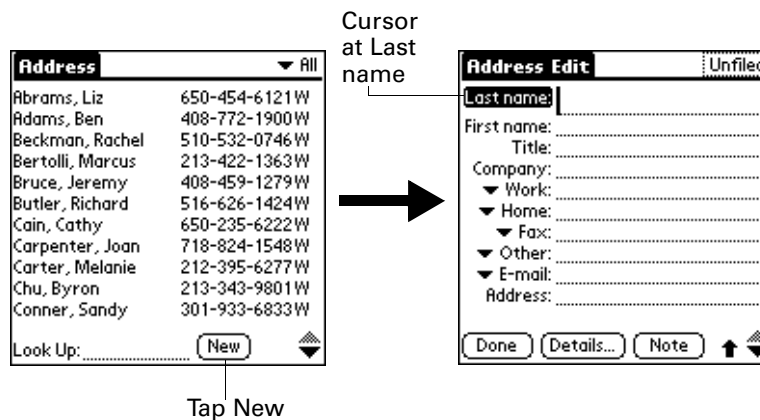

3. Enter the last name of the person you want to add to your Address Book.

NOTE The handheld automatically capitalizes the first letter of each field (except numeric and e-mail fields). You do not have to use the Graffiti® capital stroke to capitalize the first letter of the name.

4. Use the Next Field Graffiti stroke to move to the First Name field.



TIP You can also move to any field by tapping it directly.

5. Enter the person’s first name in the First Name field.
6. Enter the other information that you want to include in this entry.

NOTE As you enter letters in the Title, Company, City, and State fields, text appears for the first logical match that exists in your Address Book. As you enter more letters, a closer match appears. For example, you may already have Sacramento and San Francisco in your Address Book. As you enter "S" Sacramento appears, and as you continue entering "a" and "n" San Francisco replaces Sacramento. As soon as the word you want appears, tap in the next field to accept the word.

7. Tap the scroll arrows \blacktriangle to move to the next page of information.
8. After you finish entering information, tap Done.

Tap Done

TIP To create an entry that always appears at the top of the Address list, begin the Last name or Company field with a symbol, as in *If Found Call*. This entry can contain contact information in case you lose your handheld.

Selecting types of phone numbers

You can select the types of phone numbers or e-mail addresses that you associate with an Address Book entry. Any changes you make apply only to the current entry.

To select other types of phone numbers in an entry:

1. Tap the entry that you want to change.
2. Tap Edit.

3. Tap the pick list next to the label you want to change.

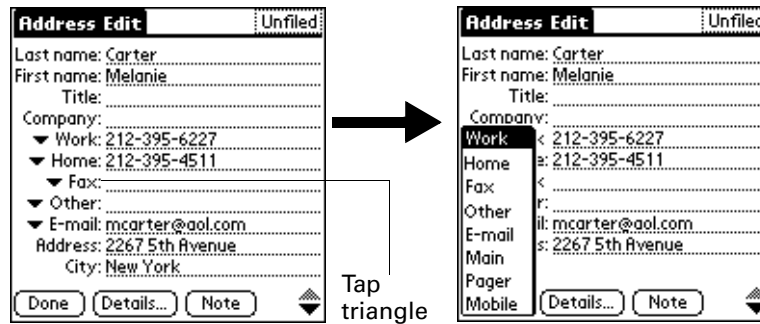

4. Select a new label.

Changing address entry details

The address entry details dialog box provides a variety of options that you can associate with an entry.

To open the address entry details dialog box:

1. Tap the entry whose details you want to change.
2. Tap Edit.
3. Tap Details.



4. Select any of the following settings:

Show in List Select which type of phone or other information appears in the Address list screen. Your options are Work, Home, Fax, Other, E-mail, Main, Pager, and Mobile. The identifying letters W, H, F, O, M, or P appear next to the record in the Address list, depending on which information is displayed. If you select E-mail, no identifying letter is displayed.

Category Assign the entry to a category.

Private Hide this entry when Security is turned on.

Address Book menus

Address Book menus are shown here for your reference, and Address Book features that are not explained elsewhere in this book are described here.

See “Using menus” in [Chapter 4](#) for information about choosing menu commands.

The Record and Options menus differ depending on whether you’re displaying the Address list screen or the Address view screen.

Record menus

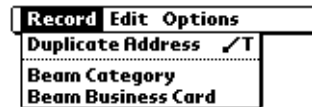

Address list

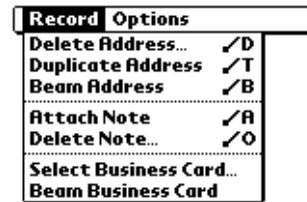

Address view

Duplicate Address

Makes a copy of the current record and displays the copy in Address Edit so you can make changes to the copied record. The copy has the same category and attached notes as the original record.

Options menus



Address list



Address view

Preferences

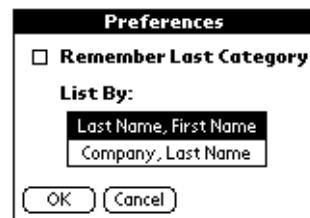

Remember Last Category

Determines how Address Book appears when you return to it from another application. If you select this check box, Address Book shows the last category you selected. If you deselect it, Address Book displays the All category.

Rename Custom Fields These custom fields appear at the end of the Address Edit screen. Rename them to identify the kind of information you enter in them. The names you give the custom fields appear in all entries.





About Address Book Shows version information for Address Book.

Using Calculator

 Calculator enables you to perform addition, subtraction, multiplication, division, and square root operations. Use Calculator to do the following:

- Perform basic calculations.
- Store and retrieve values.
- Display the last series of calculations, which is useful for confirming a series of “chain” calculations.



To open Calculator:

1. Tap the Home icon .
2. Tap the Calculator icon .

Performing Calculations

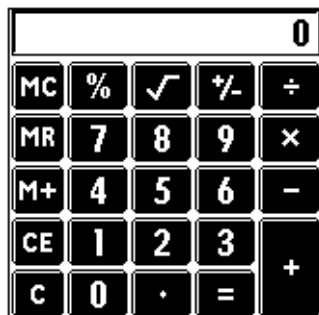
The Calculator includes several buttons to help you perform calculations.



-  Clears the entire calculation and enables you to begin a fresh calculation.
-  Clears the last number you entered. Use this button if you make a mistake while entering a number in the middle of a calculation. This button enables you to re-enter the number without starting the calculation over.
-  Toggles the current number between a negative and positive value. If you want to enter a negative number, enter the number first *and then tap* the +/- button.



Places the current number in memory. Each new number you enter with the M+ button is *added to the total* already stored in memory. The number that you add can be either a calculated value or any number you enter by tapping the number buttons. Tapping this button has no effect on the current calculation (or series of calculations); it merely places the value into memory until it is recalled.



Recalls the stored value from memory and inserts it in the current calculation.



Clears any value that is stored in the Calculator memory.



Calculates the square root of a number. Enter the number, then tap the square root button.

Recent Calculations

The Recent Calculations command enables you to review the last series of calculations and is particularly useful for confirming a series of “chain” calculations.

To display recent calculations:

1. Tap the Menu icon .
2. Tap Options, and then tap Recent Calculations.

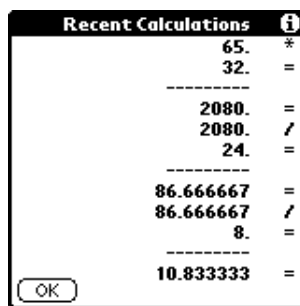

3. After you finish reviewing the calculations, tap OK.

Calculator menu

Calculator menus are shown here for your reference, and Calculator features that are not explained elsewhere in this book are described here.

See “Using menus” in [Chapter 4](#) for information about choosing menu commands.

Options menus

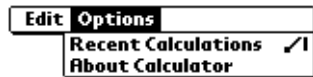

About Calculator Shows version information for Calculator.

Using Clock

 Clock enables you to view the current time and date and to set an alarm. Use Clock to do the following:

- View the current time and date.
- Open a preferences screen where you can set the time and date for all the applications on your handheld.
- Set an alarm.

To open Clock:



1. Tap the Home icon .
2. Tap the Clock icon .

Clock makes it easy for you to check the time and date, and provides a convenient travel alarm feature. See [“Date and Time preferences”](#) in [Chapter 15](#) for details on setting the current date and time for all the applications on your handheld.

In addition to setting the date and time, you can set an alarm to sound during the next 24-hour period.

Viewing the time



To view the time, do one of the following:

- When your handheld is on, tap the Clock icon  in the upper-left corner of the Graffiti writing area, or tap the Home icon , and then tap the Clock icon .
- When your handheld is off, press the up scroll button.

Setting an alarm

You can set an alarm to alert you at a particular time.

To set an alarm:

1. Tap the Home icon .
2. Tap the Clock icon .
3. Tap the Alarm box to open the Set Alarm dialog box.

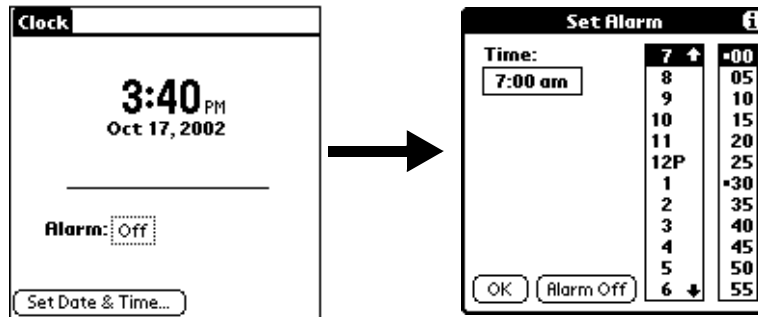

4. Tap the time columns to set the hour and minute.
5. When the alarm reminder message appears, do one of the following:
 - Tap OK to permanently dismiss the reminder and return to the current screen.
 - Tap Snooze to dismiss the reminder and return to the current screen. The reminder message appears again in five minutes, and an attention indicator blinks in the upper-left corner of the screen to remind you of the pending alarm. When the reminder message reappears, the current time displays in the Reminder bar and the alarm time displays on the screen.
6. Tap Go To to open Clock.



Clock menus

Clock menus are shown here for your reference, and Clock features that are not explained elsewhere in this book are described here.

See “Using menus” in [Chapter 4](#) for information about choosing menu commands.

Options menu

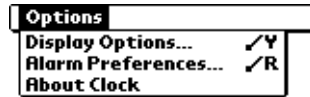

- | | |
|--------------------------|---|
| Display Options | Allows you to choose which information appears on the Clock screen. |
| | <ul style="list-style-type: none"> ■ Day. Activates the day of the week display. When it is on, the day appears above the time. ■ Date. Activates the date display. When it is on, the date appears below the time. |
| Alarm Preferences | <ul style="list-style-type: none"> ■ Sound. Sets the sound of the alarm. The choices are Alarm, Bumble Bee, Reveille, Sonata, Wake Up, and Warbler. ■ Volume. Defines how loud the alarm sounds. The choices are Low, Medium, and High. |
| About Clock | Shows version information for Clock. |

Using Date Book

 Date Book lets you quickly and easily schedule appointments or any kind of activity associated with a time and date. Use Date Book to do the following:

- Enter a description of your appointment and assign it to a specific time and date.
- Display a chart of your appointments for an entire week. The Week View makes it easy to spot available times and any potential scheduling overlaps or conflicts.
- Display a monthly calendar to quickly spot days where you have morning, lunch, or afternoon appointments.
- Display an agenda showing appointments, untimed events, and your To Do items for the day.
- Set an alarm to notify you of the scheduled activity.
- Create reminders for events that are based on a particular date, rather than time of day. Birthdays and anniversaries are easy to track with your handheld.
- Attach notes to individual events for a description or clarification of the entry in your Date Book.

To open Date Book:

- Press the Date Book application button on the front panel of your handheld. Date Book opens to today's schedule.

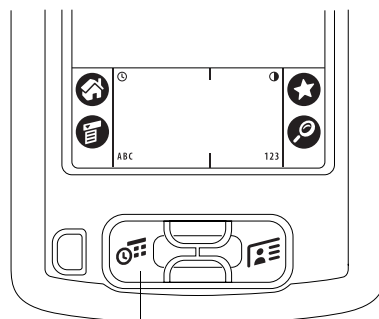

Date Book button

NOTE Press the Date Book application button repeatedly to cycle through the Day, Week, Month, and Agenda views.

When you open Date Book, the screen shows the current date and a list of times for a normal business day.

Scheduling an event

A record in Date Book is called an “event.” An event can be any kind of activity that you associate with a day. You can enter a new event on any of the available time lines.

When you schedule an event, its description appears on the time line, and its duration is automatically set to one hour. You can easily change the start time and duration for any event.

NOTE It’s possible to schedule events that overlap, but Date Book makes it easy to find such conflicts. See “[Spotting event conflicts](#)” later in this chapter.

You can also schedule events in your Date Book that occur on a particular date but have no specific start or end times, such as birthdays, holidays, and anniversaries. These are referred to as “untimed events.” Untimed events appear at the top of the list of times, marked with a diamond. You can have more than one untimed event on a particular date.

You can also schedule a repeating event, such as a weekly meeting, and continuous events, such as a three-day conference or a vacation.

To schedule an event for the current day:

1. Tap the time line that corresponds to the beginning of the event.

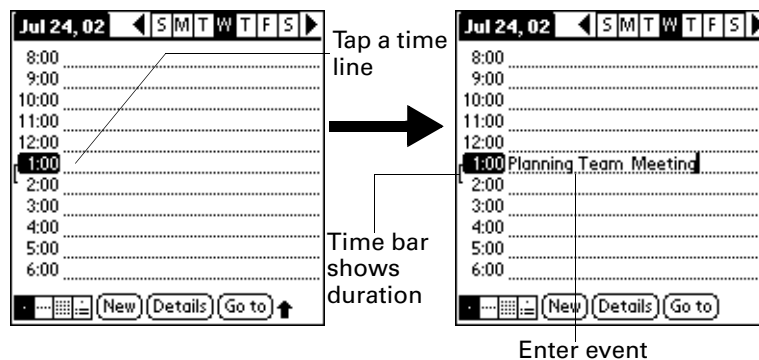

2. Enter a description of the event. You can enter up to 255 characters.

- If the event is one hour long, skip to step 5. If the event is longer or shorter than an hour, tap the time of the event to open the Set Time dialog box.

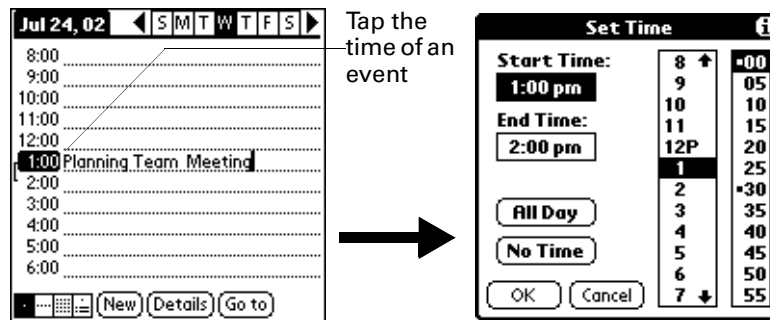

TIP You can also open the Set Time dialog box (to select a start time) by making sure no event is selected, and then writing a number on the number side of the Graffiti® writing area.

- Do one of the following:
 - Tap the time columns on the right side of the Set Time dialog box to set the Start Time, then tap the End Time box and tap the time columns to set the End Time.
 - Tap All Day to automatically insert the start and end time of the event as defined in your Date Book preferences.

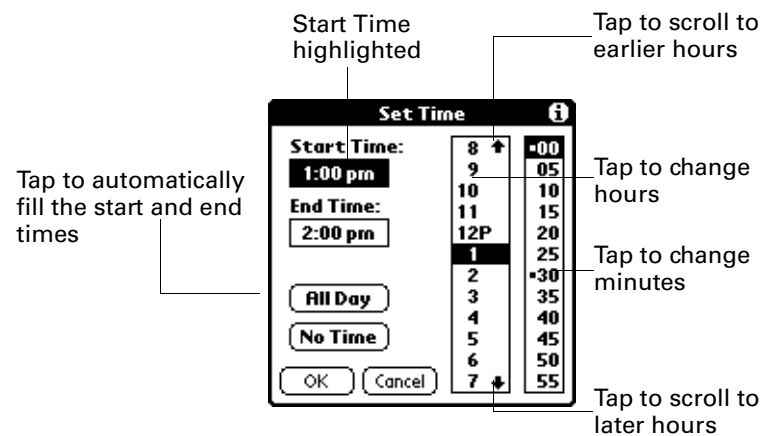

- Tap OK.
- Tap a blank area of the screen to deselect the event. A vertical line appears next to the time, indicating the duration of the event.

NOTE If an event has the same start and end time, the time is only displayed once.

To schedule an event for another day:

1. Select the date you want for the event by doing one of the following:
 - Tap the day of the week that you want in the date bar at the top of the screen. If necessary, tap the Previous week or Next week scroll arrows to move to another week.

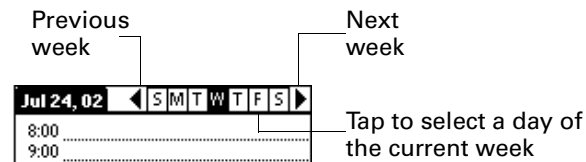

TIP You can also use the scroll button on the front panel of your handheld to move forward or backward one day at a time.

- Tap Go To at the bottom of the screen to open the Go to Date dialog box. Select a date by tapping a year, month, and day in the calendar.

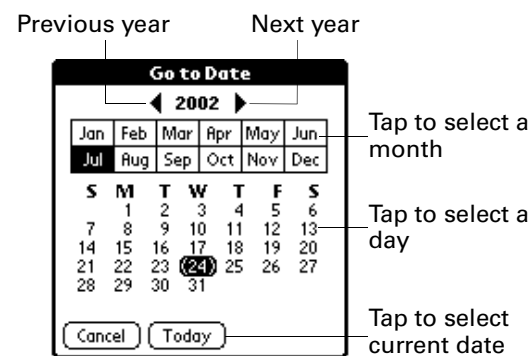

TIP In the Go to Date dialog box, you can also use the scroll button on the front panel of the handheld to move forward or backward one month at a time.

2. After you locate the date, follow the steps for scheduling an event for the current day.

To schedule an untimed event:

1. Select the date that you want for the event as described in the procedure for rescheduling an event earlier in this chapter.
2. Tap New.

- Tap No Time, so that no start or end times are defined for the new event.

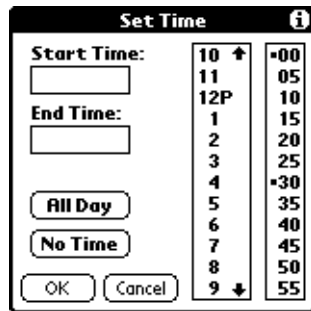

TIP You can also create a new untimed event by making sure no event is selected and then writing letters in the Graffiti writing area.

- Enter a description of the event.

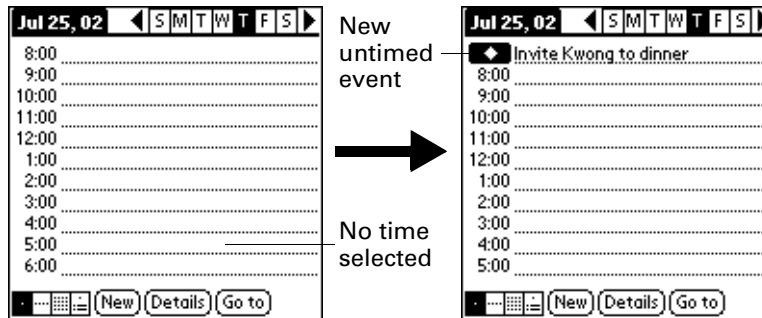

- Tap a blank area on the screen to deselect the untimed event.

NOTE If you create an event and decide later that there is no particular start or end time, you can easily change it to an untimed event. Tap the time of the event in the Date Book screen, tap No Time, and then tap OK.

Rescheduling an event

You can easily make changes to your schedule with your handheld.

To reschedule an event:

- Tap the event you want to reschedule.
- Tap Details.
- To change the time, tap the Time box and select a new time.
- To change the date, tap the Date box and select a new date.
- Tap OK.

Setting an alarm for an event

The Alarm setting enables you to set an alarm for events in your Date Book. You can set an alarm to notify you minutes, hours, or days before an event. The default Alarm setting is 5 minutes before the time of the event, but you can change this to any number of minutes, hours, or days.

When you set an alarm, the alarm icon  appears to the far right of the event with the alarm. When the alarm occurs, a reminder message also appears onscreen.

To set an alarm for an event:

1. Tap the event to which you want to assign an alarm.
2. Tap Details.
3. Tap the Alarm check box to select it.
4. Tap the pick list to select Minutes, Hours, or Days.
5. Select the 5 and enter any number from 0 to 99 (inclusive) as the number of time units.

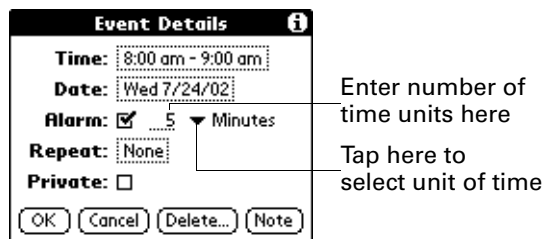

6. Tap OK.
7. When the reminder message appears on screen, do one of the following:
 - Tap OK to permanently dismiss the reminder and return to the current screen.
 - Tap Snooze to dismiss the reminder and return to the current screen. The reminder message appears again five minutes after you tap Snooze, and an attention indicator blinks in the upper-left corner of the screen to remind you of the pending alarm.
 - Tap Go To to open Date Book. Date Book will open and display the event associated with the alarm.

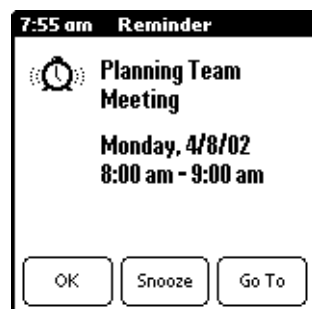

Setting an alarm for an untimed event

You can set a silent alarm for an untimed event. In this case, the alarm triggers at the specified period of minutes, hours, or days before midnight (beginning) of the day of the untimed event. When the alarm triggers, the reminder list displays the alarm message until you clear it.

For example, you set an alarm for an untimed event that occurs on February 4th. If the alarm is set for 5 minutes, the reminder message appears at 11:55 PM on the night of February 3rd. The reminder remains in the reminder list until you turn on your handheld and dismiss it.

Scheduling repeating or continuous events

The Repeat function lets you schedule events that recur at regular intervals or extend over a period of consecutive days.

A birthday is a good example of an event that repeats annually. Another example is a weekly guitar lesson that falls on the same day of the week and the same time of day.

A business trip or a vacation is an example of a continuous event.

To schedule a repeating or continuous event:

1. Tap the event.
2. Tap Details.
3. Tap the Repeat box to open the Change Repeat dialog box.

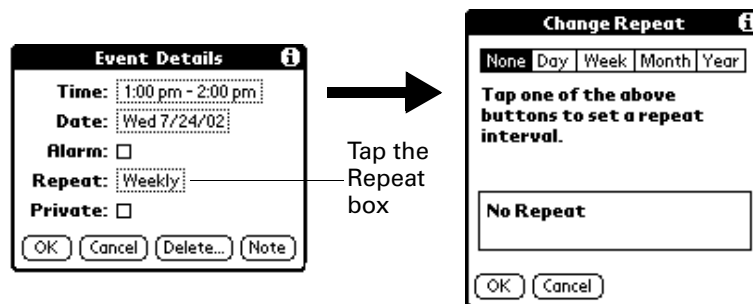

4. Tap Day, Week, Month, or Year to set how often event repeats.

For a continuous event, tap Day.

5. Enter a number that corresponds to how often you want the event to repeat on the Every line.

For example, if you select Month and enter the number 2, the event repeats every other month.

6. To specify an end date for the repeating or continuous event, tap the End on pick list and tap Choose Date. Use the date picker to select an end date.
7. Tap OK.

After you schedule a repeating or continuous event, this icon  appears to the far right of the event.

Changing repeating or continuous events

When you make changes to a repeating or continuous event, such as deleting or adding notes, or changing the time of an event, you can decide which of the events you want to change; all events in the series, just the current event, or the current and future events.

To delete repeating events:

1. Select the record you want to delete.
2. Tap the Menu icon .
3. Tap Record, and then tap Delete Event.
4. Do one of the following:
 - Tap Current to delete only the current event item.
 - Tap Future to delete the current and all future event items and reset the end date of the repeating event to the last shown date.
 - Tap All to delete all occurrences of the repeating event.

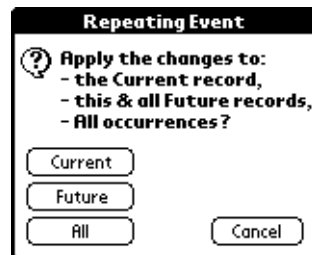

5. Tap OK.

Considerations for repeating or continuous events

Keep the following points in mind:

- If you change the start date of a repeating event, your handheld calculates the number of days you moved the event. Your handheld then automatically changes the end date to maintain the duration of the repeating event.
- If you change the repeat interval (e.g., daily to weekly) of a repeating event, past occurrences (prior to the day on which you change the setting) are not changed, and your handheld creates a new repeating event.

- If you change the date of an occurrence of a repeating event (e.g., from January 14th to January 15th) and apply the change to all occurrences, the new date becomes the start date of the repeating event. Your handheld adjusts the end date to maintain the duration of the event. If you apply the change to current and future occurrences, past occurrences are not changed.
- If you change other repeat settings (e.g., time, alarm, private) of a repeating event and apply the change to all occurrences, your handheld creates a new event. The start date of this new event is the day on which the setting is changed.
- If you apply a change to a single occurrence of a repeating event (e.g., time), that occurrence no longer shows the Repeat icon .

Changing the Date Book view

In addition to displaying the time list for a specific day, you can also display a whole week, a month, or an agenda. You can also display the current time.

To cycle through Day, Week, Month, and Agenda views:

- Press the Date Book application button repeatedly to display the next view.
- Tap the appropriate view icon in the lower-left corner of Date Book.

To display the current time:

1. Tap and hold the stylus on the date bar to display the current time.

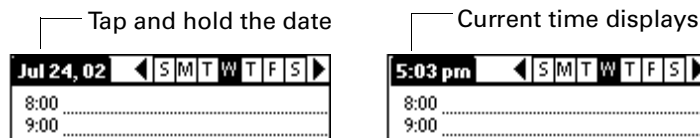

2. Drag the stylus below the title area and then lift it to redisplay the date.

NOTE You can also tap the Clock icon  in the upper-left corner of the Graffiti writing area to display the time for a few seconds.

Working in Week View

Week View shows the calendar of your events for an entire week. This view lets you quickly review your appointments and available time slots. In addition, the graphical display helps you spot overlaps and conflicts in your schedule.

To display the Week View:

1. Tap the Week View button.

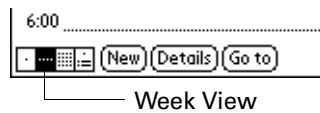

2. Tap the navigation controls to move forward or backward a week at a time, or tap on a column to display details of an event.

NOTE The Week View also shows untimed events and events that are before and after the range of times shown.

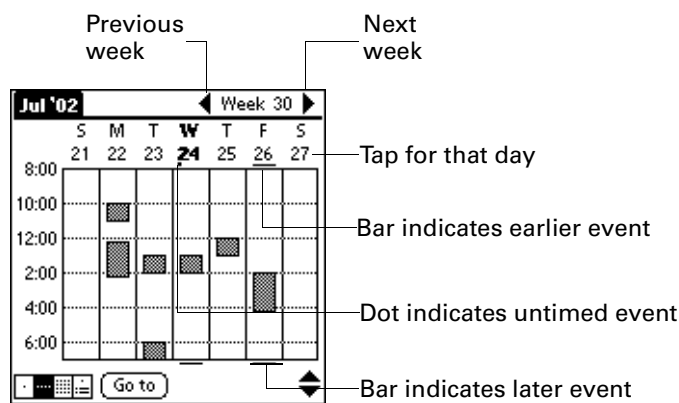

3. Tap an event to show a description of the event.

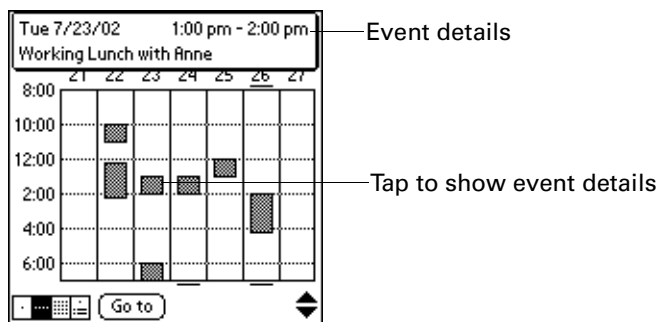

Tips for using Week View

Keep the following points in mind:

- To reschedule an event, tap and drag the event to a different time or day.
- Tap a blank time on any day to move to that day and have the time selected for a new event.

- Tap any day or date that appears at the top of the Week View to move directly to that day without selecting an event.
- The Week View shows the time span defined by the Start Time and End Time in the Date Book Preferences settings. If you have an event before or after this time span, a bar appears at the top or bottom of that day's column. Use the onscreen scroll arrows \blacktriangleup to scroll to the event.

Working in Month View

The Month View screen shows which days have events scheduled. Dots and lines in the Month View indicate events, repeating events, and untimed events.

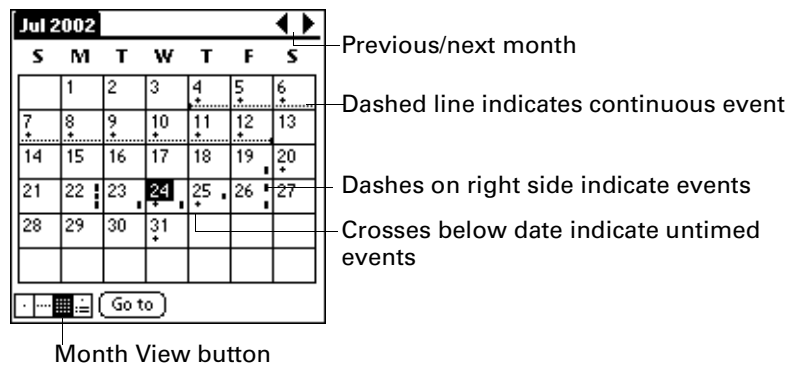

You can control the dots and lines that appear in the Month View. See [“Options menu”](#) later in this chapter.

Tips for using Month View

Keep the following points in mind:

- Tap a day in the Month View to display that day in the Day View.
- Tap the scroll arrows in the upper-right corner to move forward or backward a month.
- Tap Go to open the date selector and select a different month.
- Use the scroll button on the front panel of your handheld to move between months. Press the upper button to display the previous month, the lower button to display the next month.

Working in Agenda View

The Agenda view shows you your untimed events, appointments, and To Do items in one screen. When you tap an untimed event or appointment in the Agenda view, the Day view appears so you can see more detailed information about the event. You can tap the check box next to a To Do item to mark it as completed. When you tap a To Do item, your To Do list appears.

NOTE The To Do items that appear and how you can change them depends on the settings in your To Do preferences.

To display the Agenda View:

1. Tap the Agenda View button.

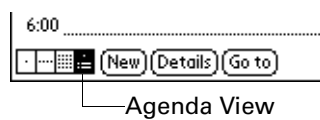

2. Tap the navigation controls to move forward or backward a day at a time, or to display more events and To Do items.

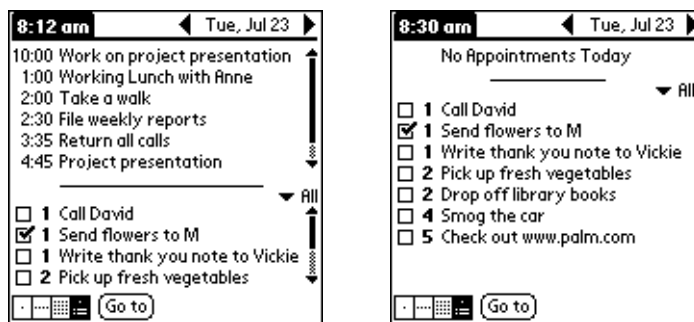

NOTE You can also change the category of To Do items shown. Click the pick list to choose another category.

Spotting event conflicts

With the ability to define specific start and end times for any event, it's possible to schedule events that overlap (an event that starts before a previous event finishes).

An event conflict (time overlap) appears in the Week View as overlapping bars. The Day View displays overlapping brackets to the left of the conflicting times.

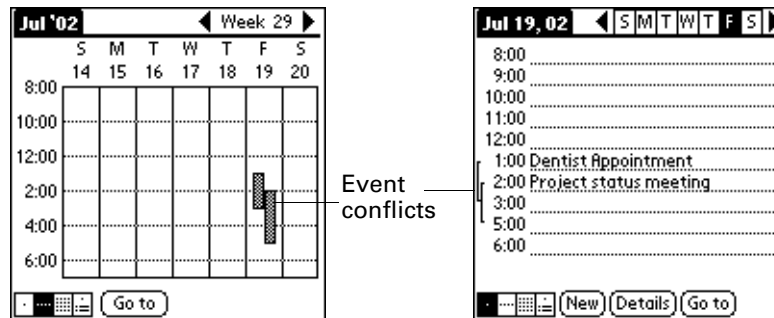

Date Book menus, preferences, and display options

Date Book menus are shown here for your reference, and Date Book features that are not explained elsewhere in this book are described here.

See "Using menus" in [Chapter 4](#) for information about choosing menu commands.

Record menu

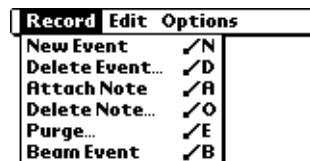

Options menu

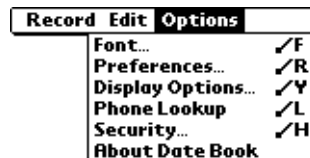

Display Options Allows you to change Date Book's appearance and which events display.



- **Show Time Bars.** Activates the time bars that appear in the Day View. The time bars show the duration of an event and illustrate event conflicts.
- **Compress Day View.** Controls how times appear in the Day View. When Compress Day View is off, all time slots display. When it is on, start and end times display for each event, but blank time slots toward the bottom of the screen disappear to minimize scrolling.
- **Month View settings.** These check boxes apply to the Month View of the Date Book. You can activate any or all of these settings to show that you have Timed, Untimed, or Daily Repeating events in the Month View *only*.

Preferences

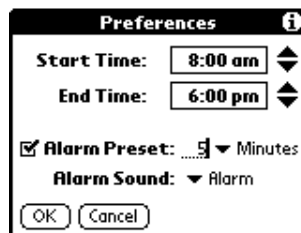

- **Start/End Time.** Defines the start and end times for Date Book screens. If the time slots you select do not fit on one screen, you can tap the scroll arrows \blacklozenge to scroll up and down.
- **Alarm Preset.** Automatically sets an alarm for each new event. The silent alarm for untimed events is defined by minutes, days, or hours before midnight of the date of the event.
- **Alarm Sound.** Sets the tone of the alarm.



About Date Book Shows version information for Date Book.

Using Expense

 Expense lets you keep track of your expenses and then transfer the information to a spreadsheet on your computer. Use Expense to do the following:

- Record dates, types of expenses, amount spent, payment method, and other details associated with any money that you spend.
- Assign expense items to categories so that you can organize and view them in logical groups.
- Keep track of vendors (companies) and people involved with each expense.
- Log miles traveled for a particular date or expense category.
- Sort your expenses by date or expense type.
- Send or export your expense information to popular computer applications, such as Microsoft Excel or Microsoft Word, using Palm™ Desktop software and HotSync® technology on a Windows computer.

To open Expense:

1. Tap the Home icon .
2. Tap the Expense icon .

Expense		▼ All
4/4	Breakfast	\$ 23.00
4/4	Dinner	\$ 65.00
4/4	Hotel	\$ 88.33
4/4	Mileage	mi 366
4/4	Taxi	\$ 23.00
4/5	Business Meals	\$ 269.00

Adding expense items

A record in Expense is called an “item.” You can sort your Expense items into categories or add other information that you want to associate with the item.

1. Tap New.

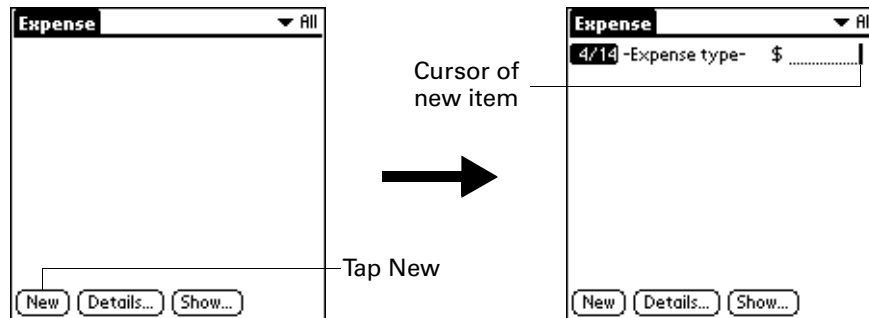

TIP You can also create a new Expense item by writing on the number side of the Graffiti writing area while in the Expense list screen. The first number you write begins the amount of your new Expense item.

2. Enter the amount of the expense.
3. Tap the Expense type pick list and select a type from the list.

As soon as you select an expense type, your handheld saves your entry. If you do not select an expense type, it does not save the entry.

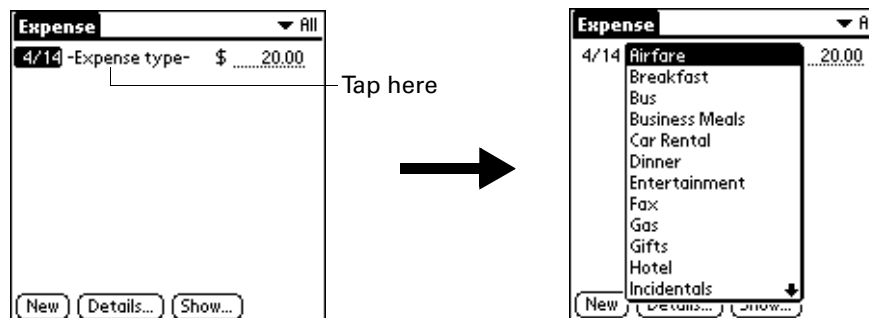

TIP Another quick way to create a new Expense item is to make sure that no Expense item is selected in the Expense list, write the first letter(s) of the expense type, and then write the numerical amount of the Expense item. This technique takes advantage of the automatic fill feature. See “[Options menu](#)” later in this chapter for details.

Changing the date of an Expense item

Initially, Expense items appear with the date you enter them. You can change the date associated with any Expense item.

To change the date of an Expense item:

1. Tap the Expense item you want to change.
2. Tap the date of the selected item.

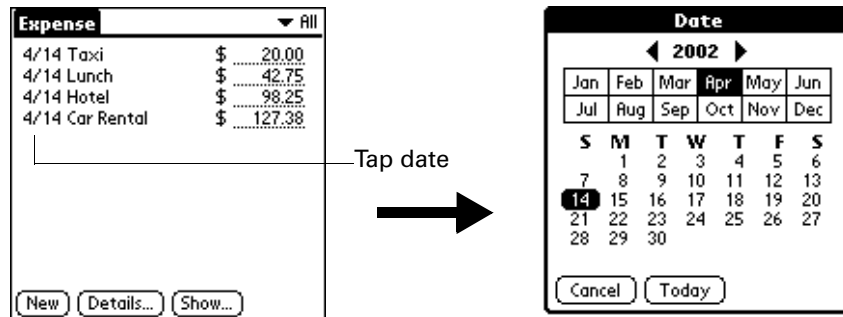

3. Tap the new date.

Entering receipt details

Expense provides a variety of options that you can associate with an item. These options appear in the Receipt Details dialog box.

To open the Receipt Details dialog box:

1. Tap the Expense item to which you want to assign details.
2. Tap Details.

The screenshot shows the Receipt Details dialog box with the following fields:

- Category:** Unfiled
- Type:** Lunch
- Payment:** Unfiled
- Currency:** \$
- Vendor:** [Text field]
- City:** [Text field]
- Attendees:** Who... [Text field]

Buttons at the bottom: OK, Cancel, Delete, Note, and an upward arrow.

3. Select any of the following options:

Category See ["Categorizing records"](#) in [Chapter 4](#) for more information.

Type Opens a pick list of expense types.

- Payment** Lets you choose the payment method used to pay the Expense item. If the item is prepaid (such as airline tickets supplied by your company), you can choose Prepaid to place your expense in the appropriate company-paid cell of your printed expense report.
- Currency** Enables you to choose the type of currency used to pay the Expense item. The default currency unit is defined in the Preferences dialog box. You can also display up to four other common types of currency. See [“Customizing the Currency pick list”](#) later in this chapter for more information.
- Vendor and City** Lets you record the name of the vendor (usually a company) associated with the expense and the city where the expense was incurred. For example, a business lunch might be at Rosie's Cafe (Vendor) in San Francisco (City).
- Attendees** See [“Looking up names to add to Expense records”](#) in Chapter 4 for more information.

4. Tap OK.

Customizing the Currency pick list

You can select the currencies and symbols that appear in the Currency pick list.

To customize the Currency pick list:

1. Tap the Currency pick list in the Receipt Details dialog box, and then select Edit currencies.

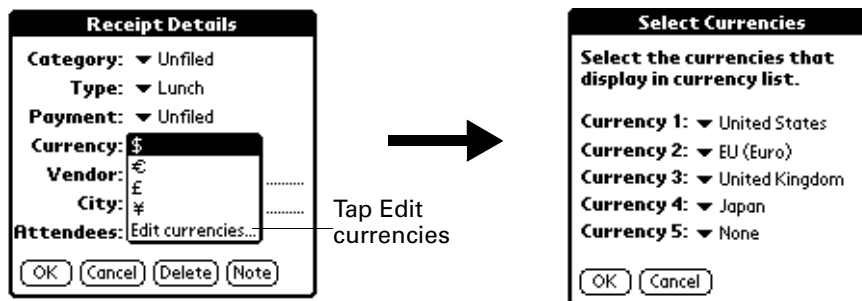

2. Tap each Currency pick list and select the country whose currency you want to display on that line.
3. Tap OK to close the Select Currencies dialog box.
4. Tap OK.

To change your default currency:

1. Open Expense.
2. Tap the Menu icon .
3. Select Options, and then select Preferences.
4. Tap the Default Currency pick list.
5. Tap the currency symbol you want to appear in Expense.

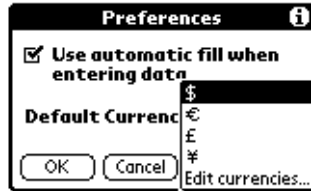

6. Tap OK.

Defining a custom currency symbol

If the currency you want to use is not in the list of countries, you can create your own custom country and currency symbol.

To define a custom currency symbol:

1. Tap the Menu icon .
2. Tap Options, and then tap Custom Currencies.
3. Tap one of the four Country boxes.

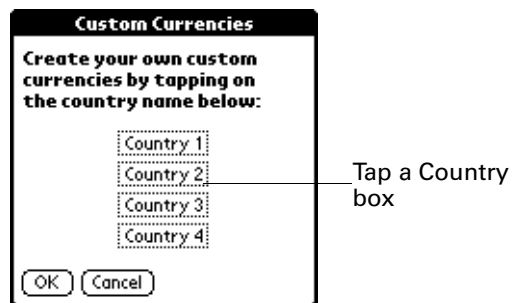

4. Enter the name of the country and the symbol that you want to appear in Expense.



5. Tap OK to close the Currency Properties dialog box.
6. Tap OK.

NOTE If you want to use your custom currency symbol as the default for all Expense items, select the symbol in the Preferences dialog box. If you want to use your custom currency symbol only for a particular Expense item, select the symbol in the Receipt Details dialog box associated with that item.

Show Options

Show Options define the sort order and other settings that relate to your Expense items.

To open the Show Options dialog box:

1. In the Expense list, tap Show.
2. Select any of the options.

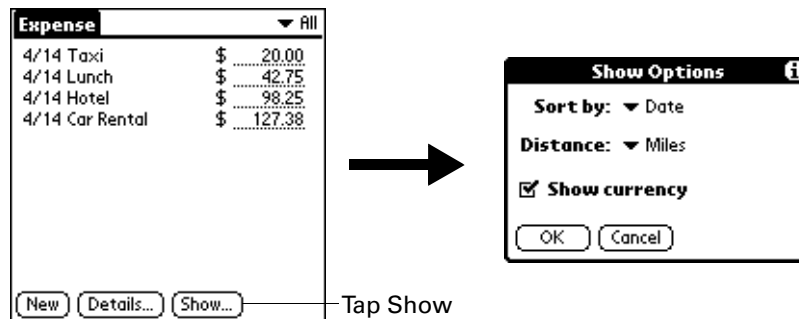

- Sort by** Enables you to sort expense items by date or type.
- Distance** Enables you to display Mileage entries in miles or kilometers.
- Show currency** Shows or hides the currency symbol in the Expense list.

3. Tap OK.

Working with Expense data on your computer

After you enter your expenses into the Expense application on your handheld and perform a HotSync operation, Palm Desktop software enables you to do any of the following on your computer. See the Palm Desktop software online help for details.

- Add, modify, and delete your Expense data
- Organize your Expense data by category, amount, date, type, or notes
- View Expense data in different formats: List, large Icons, or Small Icons
- Record individual expenses in different currencies and display the total in one selected currency type

- Print Expense reports
- Transfer Expense data to other applications such as Microsoft Excel using the Send command or Export command, and import data in popular file formats

For more information on using Expense on your computer, see:

- The online help for Palm Desktop software. To access the online help, go to the Help menu in Palm Desktop software.

Displaying the euro on your computer

When you perform a HotSync operation, the euro symbol is transferred to your Desktop application like any other piece of data on your handheld. The symbol appears in your Desktop application, however, only if you are using fonts that support the euro symbol.

These fonts are part of the operating system on your computer. They do not reside with your Desktop application, and they are not produced by Palm, Inc. Refer to the documentation that accompanies your desktop computer's operating system for more information.

Printing the euro

Even with operating system support, problems may arise while printing documents that contain the euro. When a font is present on both the printer and the computer, the printer font is used by default to increase printing speed. If the printer font does not include the euro, a box prints instead of the euro symbol.

You can work around this problem by sending a bitmap image of the euro to the printer or by not using the printer's built-in fonts (if allowed).

Expense menus

Expense menus are shown here for your reference, and Expense features that are not explained elsewhere in this book are described here.

See "Using menus" in [Chapter 4](#) for information about choosing menu commands.

Record menu

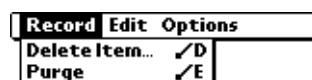

Options menu



Preferences

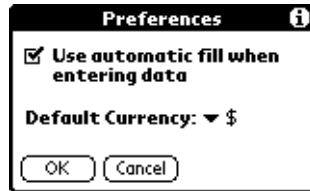

Use automatic fill. Lets you select an expense type by writing the first letter of an expense type in the Graffiti writing area. For example, if you write the letter "T," it enters the "Taxi" expense type. Writing "T" and then "E" enters "Telephone" which is the first expense type beginning with the letters "TE."



About Expense Shows version information for Expense.

Using Memo Pad

 Memo Pad provides a place to take notes that are not associated with records in Date Book, Address Book, or To Do List. Use Memo Pad to do the following:

- Use Graffiti® characters to store memos, lists, or any other text message on your handheld.
- Send memos to popular computer applications like Microsoft Word when you synchronize using Palm™ Desktop software and HotSync® technology.
- Assign memos to categories so that you can organize and view them in logical groups.
- Write down phone numbers and other types of information. Later, you can copy and paste this information to other applications.



To open Memo Pad:

1. Tap the Home icon .
2. Tap the Memo Pad icon .

Creating memos

A memo can contain up to 4,000 characters. The number of memos you can store is dependent only on the memory available on your handheld. A record in Memo Pad is called a “memo.”

To create a new memo:

1. Tap the Home icon .
2. Tap the Memo Pad icon  to display the Memo list.

3. Tap New.

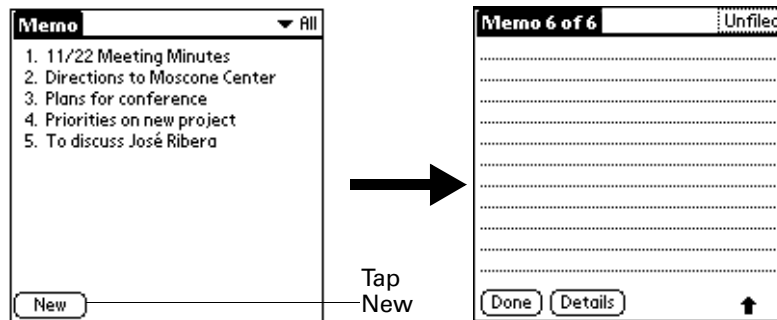

TIP In the Memo list screen, you can also begin writing in the Graffiti writing area to create a new memo. The first letter is automatically capitalized and begins your new memo.

4. Enter the text you want to appear in the memo. Use the carriage return stroke to move down to new lines in the memo.
5. Tap Done.

Reviewing memos

The first line of a memo appears in the Memo list. This makes it easy to locate and review your memos.

To review a memo:

1. In the Memo list, tap the text of the memo.

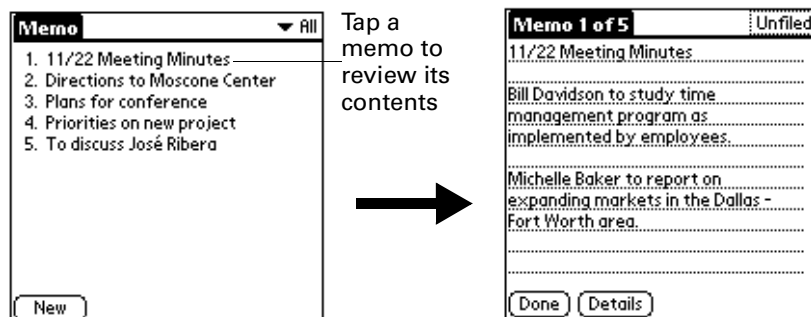

2. Review or edit the text in the memo.
3. Tap Done.

Memo Pad menus

Memo Pad menus are shown here for your reference, and Memo Pad features that are not explained elsewhere in this book are described here.

See “Using menus” in [Chapter 4](#) for information about choosing menu commands.

The Record and Options menus differ depending on whether you’re displaying the Memo list or an individual memo.

Record menus

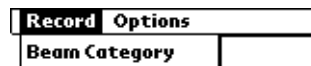

Memo list

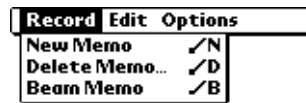

Memo screen

Options menus



Memo list



Memo screen

Preferences Displays the Memo Preferences dialog box, where you define the sort order for memos.



About Memo Pad Shows version information for Memo Pad.

Using Note Pad

 Note Pad provides a place to take notes in your own handwriting. You can use Note Pad to do everything you might do with a piece of paper and a pencil. Use Note Pad to do the following:

- Take notes, draw a sketch, or write any kind of message directly on your handheld screen. Later, you can enter this information into other applications.
- Set an alarm to use your notes as reminder messages.
- Assign notes to categories so that you can organize and view them in logical groups.
- Copy and paste notes into popular computer applications like Microsoft Word using Palm™ Desktop software and HotSync® technology.



To open Note Pad:

1. Tap the Home icon .
2. Tap the Note Pad icon .

Creating a note

A record in Note Pad is called a “note.” You can assign each note a title and store as many notes as permitted by the memory available on your handheld.

To create a new note:

1. Tap the Home icon .
2. Tap the Note Pad icon .

NOTE If Note Pad is already running, tap New.

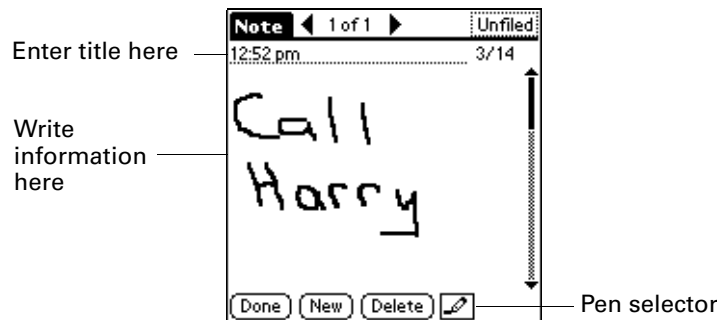

3. Write the information directly on the handheld screen.

TIP Tap the pen selector to choose a different pen width, or choose the eraser to remove unwanted strokes.

4. (Optional) Select the time at the top of the screen and enter a title using Graffiti® writing.
5. Tap Done.

Reviewing notes

The note title and the date you created the note appear in the Note Pad list. If you did not assign a title to your note, the time you created the note appears as the note title. This makes it easy to locate and review your notes.

To review a note:

1. In the Note Pad list, tap the note title.

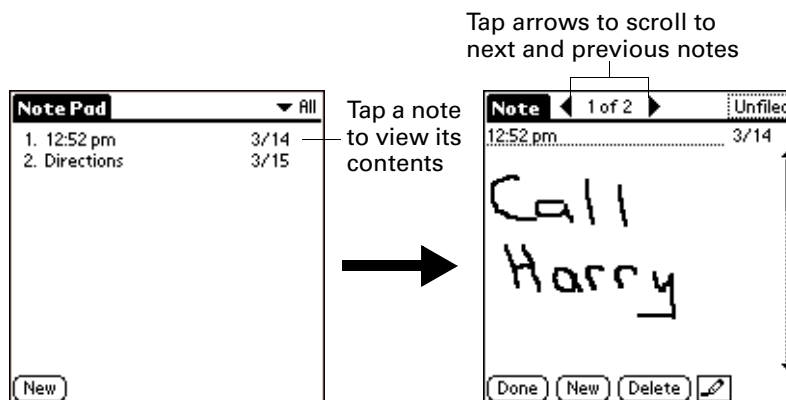

2. Review or edit the contents of the note.
3. Tap Done.

Clearing a note

You can erase the drawing area in a note while retaining the note title.

To clear a note:

1. In the Note Pad list, tap the note title.
2. Tap the Menu icon .
3. Tap Edit, and then tap Clear Note.

Setting an alarm for a note

You can set an alarm for a specific time and date to remind you to follow-up on a note.

To set an alarm for a note:

1. Tap the note to which you want to assign an alarm.
2. Tap the Menu icon .
3. Tap Options, and then tap Alarm.
4. Tap the Time box.
5. Tap the hour and minute columns to select the time you want the alarm to occur.

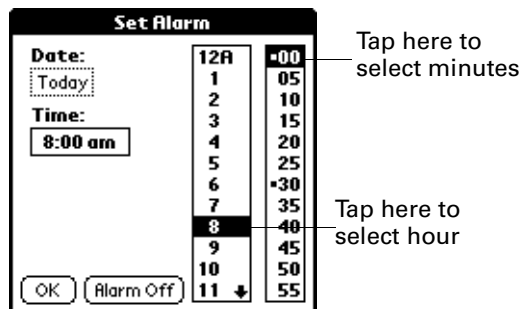

6. Tap the Date box.

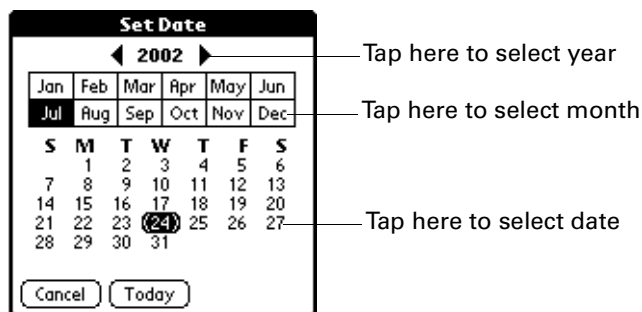

7. Tap the year, month, and date you want the alarm to sound.
After you tap the date, the Set Alarm dialog box reappears.
 8. Tap OK.
 9. When the alarm goes off and the reminder message appears, do one of the following:
 - Tap OK to permanently dismiss the reminder and return to the current screen.
 - Tap Snooze to dismiss the reminder and return to the current screen. The reminder message appears again in five minutes, and an attention indicator blinks in the upper-left corner of the screen to remind you of the pending alarm. When the reminder message reappears, the current time displays in the Reminder bar and the note title displays on the screen.
- NOTE** If you did not title the note, the time the note was created displays on the screen.
- Tap Go To to open Note Pad. Note Pad will open and display the note associated with the alarm.



Note Pad menus

Note Pad menus are shown here for your reference, and Note Pad features that are not explained elsewhere in this book are described here.

See “Using menus” in [Chapter 4](#) for information about choosing menu commands.

The Record and Options menus differ depending on whether you’re displaying the Note Pad list or an individual note.

Record menus



Note Pad list

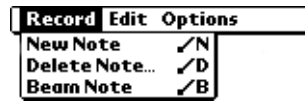

Note screen

Options menus

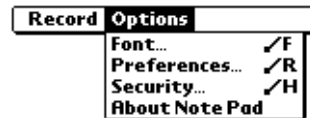

Note Pad list



Note screen

- Preferences** Displays the Note Pad Preferences dialog box, where you define the sort order for notes and the alarm sound.
- About Note Pad** Shows version information for Note Pad.

Using Security

 Your handheld comes with a Security application so that unauthorized users cannot view the entries you wish to protect. Use Security to do the following:

- Lock and turn off your handheld so that it does not operate until you enter the correct password.
- Mask all records that you mark as private so the information appears greyed out.
- Hide all records that you mark as private so they do not appear on any screen.

You can mask and hide private records with or without a password. Without a password, private records are hidden or masked until you set the Security application to show them. With a password, you must enter the password to view the private entries.



To open Security:

1. Tap the Home icon .
2. Tap the Security icon .

Assigning a password

You can assign a password to protect your private records and to lock your handheld.

To assign a password:

1. Tap the Home icon .
2. Tap the Security icon .
3. Tap the Password box.
4. Enter a password.

- (Optional) Enter a hint to help your remember your password if you forget it.

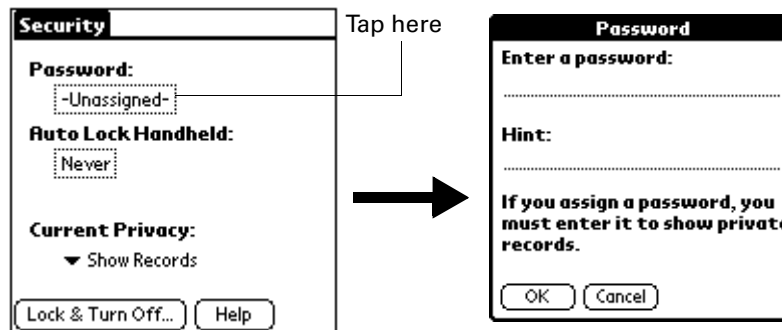

- Tap OK.
- Enter the *same* password a second time, and tap OK.

Changing or deleting a password

Once you define a password for your handheld, you can change or delete it at any time. You must enter the current password before you can change or delete it.

To change or delete your password:

- Tap the Password box.
- Enter the current password.

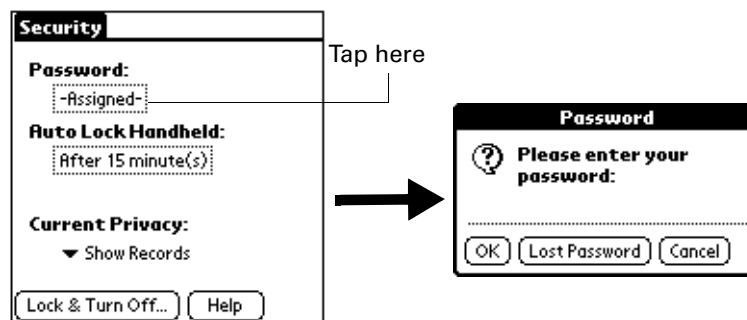

- Tap OK.

4. Do one of the following:
 - To change the password and hint, enter the new password and hint, and tap OK.
 - To remove the password, tap Unassign.



Locking your handheld



You can lock your handheld so that it cannot be operated until your password is entered. In the event that your handheld is lost or stolen, this helps protect your data from unauthorized use. You can set your handheld to lock automatically, or you can lock it manually.

Locking your handheld automatically

You can set your handheld to lock automatically when any one of the following occur:

- When you turn off the power
- At a time you specify
- After a period of inactivity you specify



To set your handheld to lock when you turn it off:

1. Tap the Home icon .
2. Tap the Security icon .
3. Tap the Auto Lock Handheld box, and then enter your password.



4. Tap On power off.
5. Tap OK.

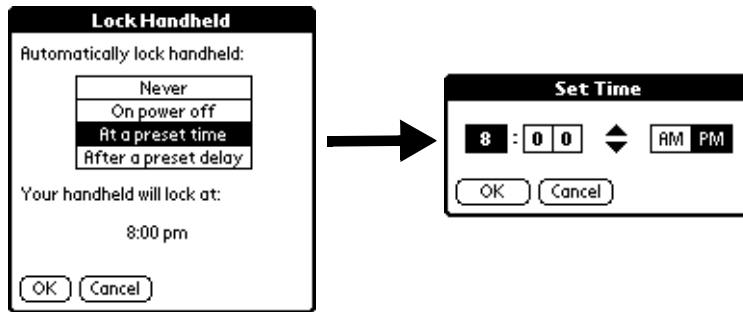

To set your handheld to lock at a preset time:

1. Tap the Home icon .
2. Tap the Security icon .
3. Tap the Auto Lock Handheld box, and then enter your password.
4. Tap At a preset time, and then use the arrows to set the time.



5. Tap OK.

To set your handheld to lock after a period of inactivity:

1. Tap the Home icon .
2. Tap the Security icon .
3. Tap the Auto Lock Handheld box, and then enter your password.
4. Tap After a preset delay.

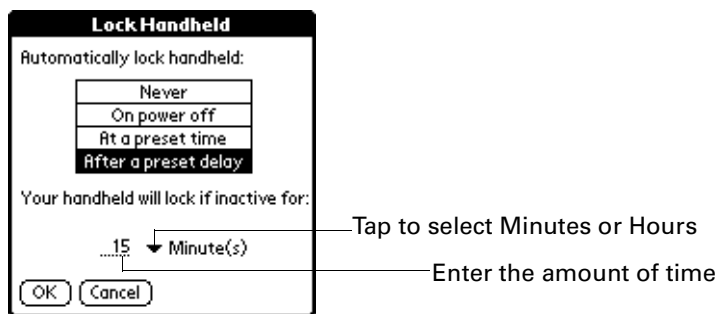



5. Enter the inactive period, then select Minute(s) or Hour(s) from the pick list.
6. Tap OK.

IMPORTANT If you lock your handheld, you must enter the exact password to re-activate your handheld. If you forget the password, your handheld will present the hint you have entered to help you remember the password. If you still cannot remember the password, you must perform a hard reset to resume using your handheld. Performing a hard reset deletes all the records in your handheld; however, you can restore all synchronized data at the next HotSync® operation. See [“Resetting your handheld”](#) in [Appendix A](#) for more information.

Locking your handheld manually

You can turn off and lock your handheld manually.

To lock and turn off your handheld:

1. Tap the Home icon .
2. Tap the Security icon .
3. Tap Lock & Turn Off.

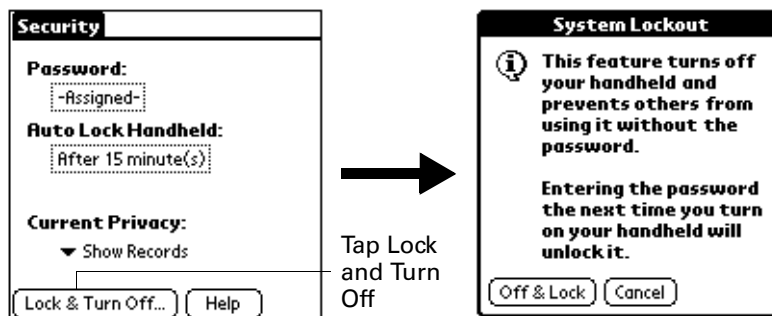

4. Tap Off & Lock.
5. To start your handheld, turn it on and then enter the password.

Recovering from a forgotten password

If you forget your password, your handheld will display the password hint, if you entered one, to help you remember the password. If you are still unable to remember the password, you can delete it from your handheld. Deleting a forgotten password also deletes all entries and files marked as Private.

If you synchronize with your computer before deleting a forgotten password, your handheld restores your private entries the next time you perform a HotSync operation, but it does not restore the password.

To delete a forgotten password:

1. Tap Lost Password.
2. Tap Yes.

Making records private

You can make individual records private. Private records remain visible and accessible, however, until you select the Security setting to hide or mask all private records.

Hiding or masking private records

You can hide or mask all records that you mark as private. Masked records appear as grey placeholders in the same position they would appear if they were not masked, and are marked with a lock icon. Hidden records disappear completely from the screen. If you define a password for your handheld, you must enter it to display private records.

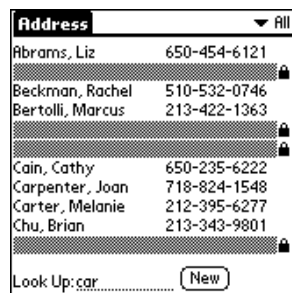

To hide all private records:

1. Tap the Home icon .
2. Tap the Security icon .
3. Tap the Current Privacy pick list and select Hide Records.

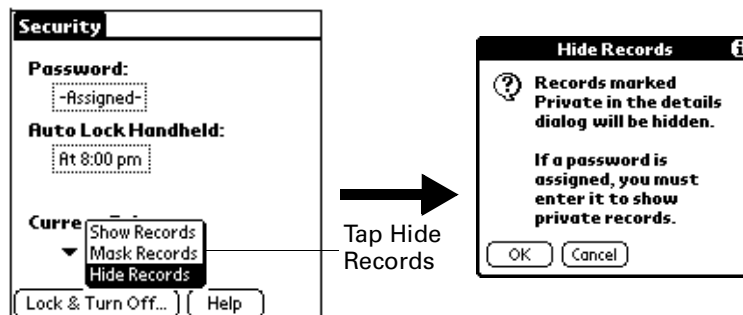

4. Tap OK to confirm that you want to hide private records.

To mask all private records:

1. Tap the Home icon .
2. Tap the Security icon .

3. Tap the Current Privacy pick list and select Mask Records.

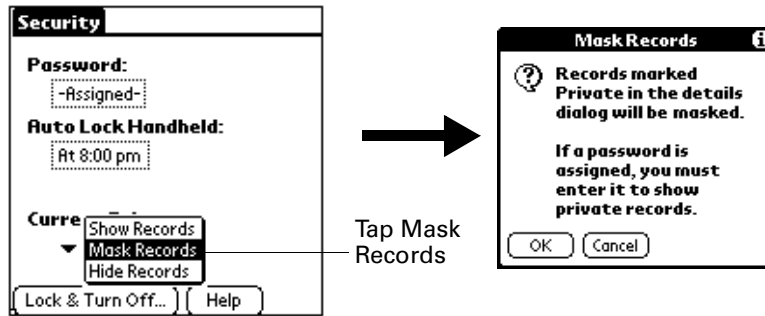

4. Tap OK to confirm that you want to mask private records.

To display all private records:

1. Tap the Home icon .
2. Tap the Security icon .
3. Tap the Current Privacy pick list and select Show Records.

If you do not have a password, hidden and masked records become visible.

If you have a password, the Show Private Records dialog box appears. Go to step 4.

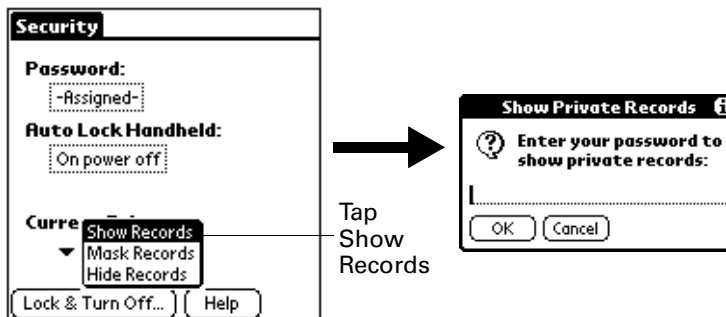

4. Enter your password, and then tap OK.

To unmask individual records:

1. Tap a masked record.

If you do not have a password, a masked record becomes visible.

If you have a password, the Show Private Records dialog box appears. Go to step 2.

2. Enter your password, and then tap OK.

To make a record private:



1. Display the entry that you want to make private.
2. In Note Pad only: Tap the Menu icon , and then tap Options.
3. Tap Details.
4. Tap the Private check box to select it.
5. Tap OK.

Using To Do List

 To Do List is a convenient place to create reminders and prioritize the things that you have to do. Use To Do List to do the following:

- Make a quick and convenient list of things to do.
- Assign a priority level to each task.
- Assign a due date for any or all of your To Do List items.
- Assign To Do List items to categories so that you can organize and view them in logical groups.
- Sort your To Do List items either by due date, priority level, or category.
- Attach notes to individual To Do List items for a description or clarification of the task.

To open To Do List:

1. Tap the Home icon .
2. Tap the To Do List icon .

To Do List opens to display the category of items you last viewed.

Creating list items

A To Do List item is a reminder of some task that you have to complete. A record in To Do List is called an “item.”

To create a To Do List item:

1. Tap the Home icon .
2. Tap the To Do List icon .

3. Tap New.

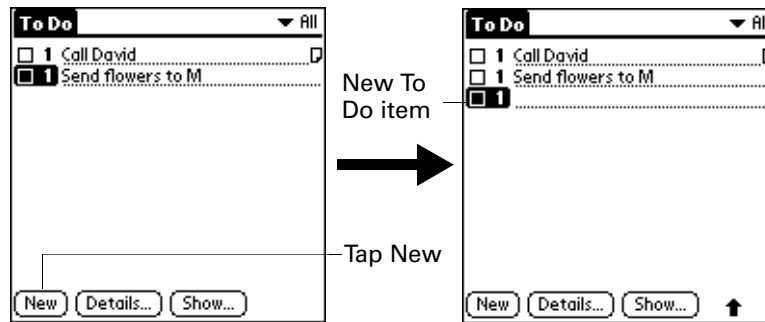

4. Enter the text of the To Do List item. The text can be longer than one line.

5. Tap anywhere onscreen to deselect the To Do List item.

TIP If no To Do List item is currently selected, writing in the Graffiti® writing area automatically creates a new item.

Setting priority

The priority setting for items lets you arrange the tasks in your To Do List according to their importance or urgency. The default setting for the To Do List is to arrange items by priority and due date, with priority 1 items at the top. If you have a number of items in your list, changing an item's priority setting may move its position in the list.

When you create a new To Do List item, its priority is automatically set to 1, the highest (most important) level. If you select another item first, however, the item you create appears beneath the selected item and is given the same priority as the selected item.

To set the priority of a To Do List item:

1. Tap the Priority number on the left side of the To Do List item.

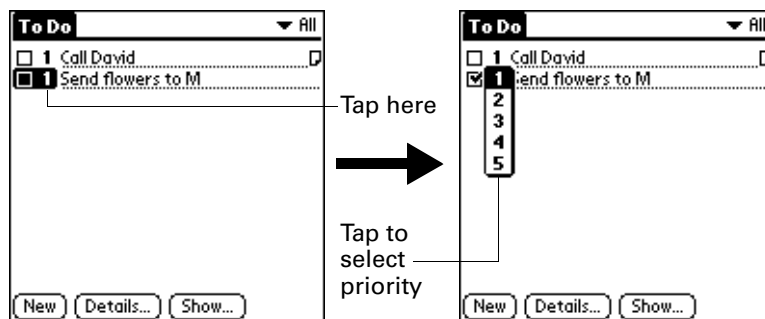

2. Tap the Priority number that you want to set (1 is most important).

Checking off a To Do List item

You can check off a To Do List item to indicate that you've completed it. You can set the To Do List to record the date that you complete the To Do item, and you can choose to show or hide completed items. See ["To Do Show Options"](#) later in this chapter.

To check off a To Do List item:

- Tap the check box on the left side of the item.

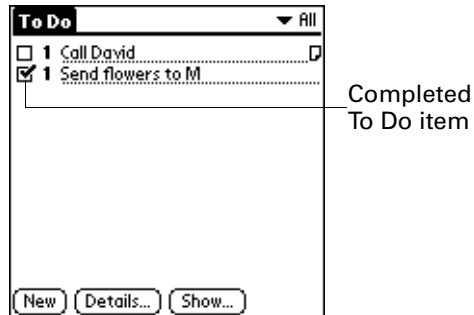

Changing To Do List item details

The To Do Item Details dialog box enables you to change settings for individual items.

To display the To Do Item Details dialog box:

1. Tap the text of the item whose details you want to change.
2. Tap Details.



Setting a due date

You can associate a due date with any To Do List item. You can also sort the items that appear in the list based on their due date.

To set a due date for a To Do List item:

1. In the Details dialog box, tap “No Date” to open the Due Date pick list.

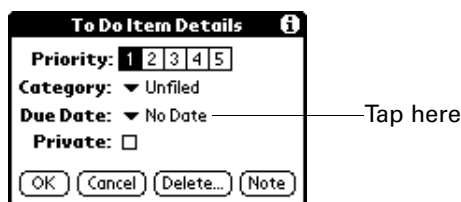

2. Tap the date that you want to assign the item:

Today	Assigns the current date.
Tomorrow	Assigns tomorrow's date.
One week later	Assigns the date exactly one week from the current date.
No Date	Removes the due date from the item.
Choose date	Opens the date selector, where you can choose any date that you want for the item.

3. Tap OK.

To Do Show Options

The Show Options dialog box enables you to control the appearance of To Do List and To Do items in Date Book Agenda view.

To change the Show Options settings:

1. In To Do List, tap Show.



2. Select any of the following settings:

- Show Completed Items** Displays your completed items in the To Do List. If you turn off this setting, your To Do items disappear from the list when you complete (check) them.
- Items that no longer appear on the list because you turn off this setting have not been deleted. They are still in the memory of your handheld. Purge completed items to remove them from memory.
- Show Only Due Items** Shows only the items that are currently due, past due, or have no due date specified. When this setting is active, items that are not yet due do not appear in the list until their due date.
- Record Completion Date** Replaces the due date with the actual date when you complete (check) the item. If you do not assign a due date to an item, the completion date still records when you complete the item.
- Show Due Dates** Displays the due dates associated with items in the To Do List and displays an exclamation mark next to items that remain incomplete after the due date passes.
- Show Priorities** Shows the priority setting for each item.
- Show Categories** Shows the category for each item.

3. Tap OK.

To Do List menus

To Do List menus are shown here for your reference, and To Do List features that are not explained elsewhere in this book are described here.

See “Using menus” in [Chapter 4](#) for information about choosing menu commands.

Record menu

Record	Edit	Options
Delete Item...	✓	D
Attach Note	✓	A
Delete Note...	✓	O
Purge...	✓	E
Beam Item	✓	B
Beam Category		

Options menu



About To Do List Shows version information for To Do List.

Performing HotSync® Operations

HotSync® technology enables you to synchronize data between one or more Palm OS® handhelds and Palm™ Desktop software or another PIM such as Microsoft Outlook. To synchronize your data, connect the HotSync cable to your computer and your handheld or use infrared (IR) communications.

This chapter describes how to select HotSync options and how to perform a HotSync operation via infrared communications. It also provides information about performing your first and subsequent local HotSync operations.

Selecting HotSync setup options

You can choose when you want HotSync Manager to run. If necessary, you can adjust the local and modem HotSync settings as well.

To set the HotSync options on a Windows computer:

1. Click the HotSync icon ™ in the Windows system tray (bottom-right corner of the taskbar).
2. Select Setup.

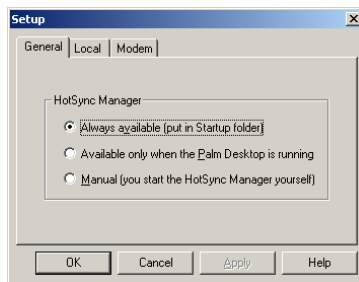

3. Click the General tab and select one of the following options:

Always available Adds HotSync Manager to the Startup folder and constantly monitors the communication port for synchronization requests from your handheld. With this option, the HotSync Manager synchronizes data even when Palm Desktop software is not running.

Available only when Palm Desktop software is running Starts HotSync Manager and monitors requests automatically when you open Palm Desktop software.

Manual Monitors requests only when you select HotSync Manager from the Start menu.

TIP If you're not sure which option to use, keep the default setting: Always available.

4. Click OK.

To set the HotSync options on a Mac:

1. Double-click the HotSync Manager icon in the Palm folder.
2. Click the HotSync Controls tab and select any of the following options.

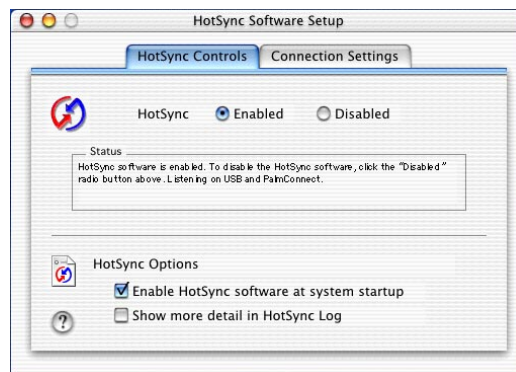

HotSync Enabled/ Disabled Activates the HotSync software and prepares your computer to synchronize with your handheld. The default setting is Enabled; whenever you start your computer, HotSync operations are enabled.

Enable HotSync software at system startup Activates the transport monitor automatically each time you start your computer. If this option is not checked, you must open HotSync Manager and select the Enabled option before you can perform a HotSync operation.

Show more detail in HotSync Log Includes more troubleshooting information in the log that is generated when you perform a HotSync operation.

3. Close the HotSync Software Setup window.

Customizing HotSync application settings

For each application, you can define a set of options that determines how records are handled during synchronization. These options are called a “conduit.” By default, a HotSync operation synchronizes all files between the handheld and Palm Desktop software.

In general, you should leave the settings to synchronize all files. The only reason you might want to change these settings is to overwrite data on either your handheld or Palm Desktop software, or to avoid synchronizing a particular type of file because you don’t use it.

In addition to the conduits for Date Book, Address Book, To Do List, Note Pad, Expense and Memo Pad, Palm Desktop software includes System and Install conduits. The System conduit backs up the system information stored on your handheld, including Graffiti® ShortCuts. The Install conduit installs add-on applications on your handheld.

To customize HotSync application settings on a Windows computer:

1. Click the HotSync icon  in the Windows system tray (bottom-right corner of the taskbar).

TIP You can also click the HotSync command on the Palm Desktop software menu bar.

2. From the HotSync Manager menu, select Custom.

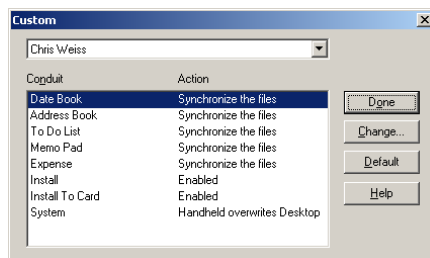

3. Select the appropriate username from the list.
4. Select an application in the Conduit list.

NOTE Some options shown may not be available on your handheld.

5. Click Change.

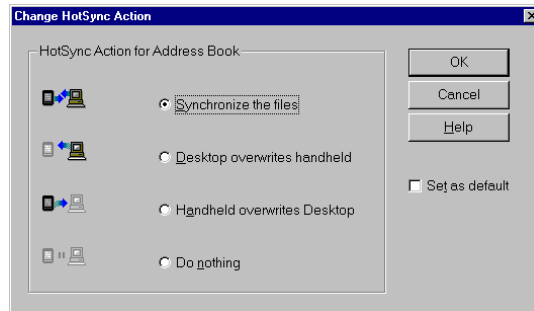

6. Click the direction in which you want to write data, or click Do Nothing to skip data transfer for an application.

NOTE Changing the HotSync setting from the default affects only the *next* HotSync operation. Thereafter, the HotSync Actions revert to their default settings. To use a new setting on an ongoing basis, select the Set As Default box. Thereafter, whatever you selected as the default setting is used when you click the Default button in the Custom dialog.

7. Click OK.

8. Repeat steps 4 through 7 to change conduit settings for other applications.

9. Click Done to activate your settings.

NOTE If you want to save your new settings as the default, click Default in the Custom window after you set them for each application.

To customize HotSync application settings on a Mac:

1. Double-click the Palm Desktop icon in the Palm folder.
2. From the HotSync menu, select Conduit Settings.

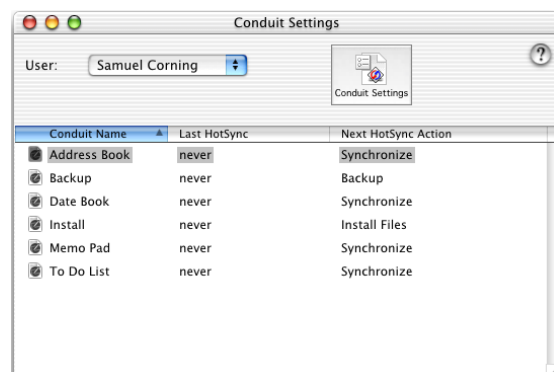

3. From the User pop-up menu, select the appropriate username.

4. Select an application in the Conduit list.

5. Click Conduit Settings.

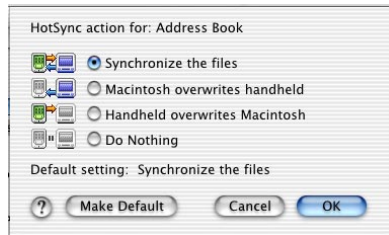

6. Click the direction in which you want to write data, or click Do Nothing to skip data transfer for an application.

NOTE Changing the HotSync setting from the default affects only the *next* HotSync operation. Thereafter, the HotSync Actions revert to their default settings. To use a new setting on an ongoing basis, click Make Default. Thereafter, whatever you selected as the default setting is used for HotSync operations.

7. Click OK.
8. Repeat steps 4 through 7 to change conduit settings for other applications.
9. Close the Conduit Settings window.

Performing cable HotSync operations

The simplest way to synchronize data is to perform a direct HotSync operation by connecting your handheld to the cable, turning on your handheld, and tapping the Favorite icon .

IMPORTANT You must perform your *first* HotSync operation with a local, direct connection.

Performing a HotSync operation for the first time: Windows

When you installed Palm Desktop software, you entered a username. This username is the connection between your handheld and your computer. The first time you synchronize your data, you are prompted to enter your username in Palm Desktop software. After you enter this information and synchronize, the HotSync Manager recognizes your handheld and doesn't ask for this information again.

If you are a System Administrator preparing several handhelds for a group of users, you may want to create a user profile. See [“Creating a user profile”](#) later in this chapter before performing the following steps.

The following steps assume that you have already installed Palm Desktop software. If you have not installed this software, see [“Step 4: Install Palm Desktop software and perform a HotSync operation”](#) in [Chapter 1](#) for instructions.

To perform a local HotSync operation on a Windows computer:

1. Connect your handheld to your computer using the HotSync cable.

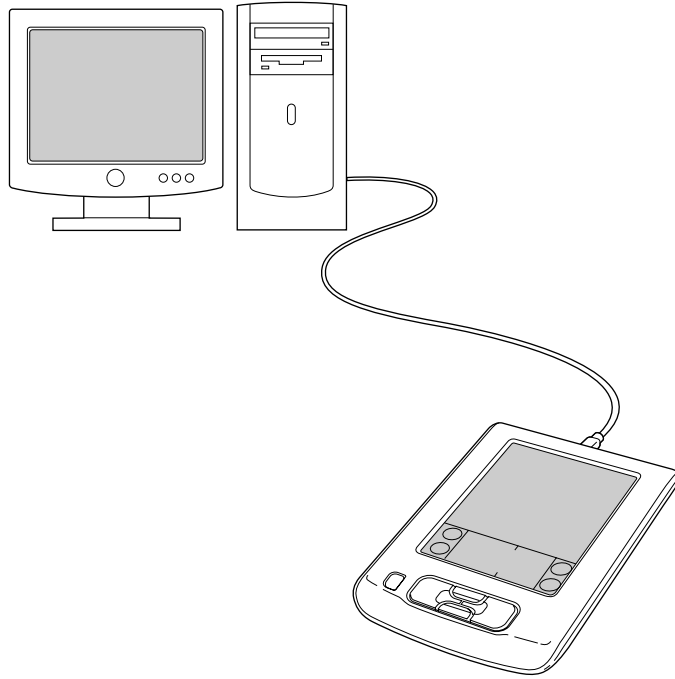

2. If the HotSync Manager is not running, start it. You can do this by starting Palm Desktop software which automatically opens the HotSync Manager. Alternatively, you can click Start on the Windows desktop, and then choose Programs. Navigate to the Palm Desktop software program group and choose HotSync Manager.

NOTE You can check the Windows system tray to see if HotSync Manager is running. If it is running, the HotSync icon is displayed.

3. Turn on your handheld and tap the Favorite icon .

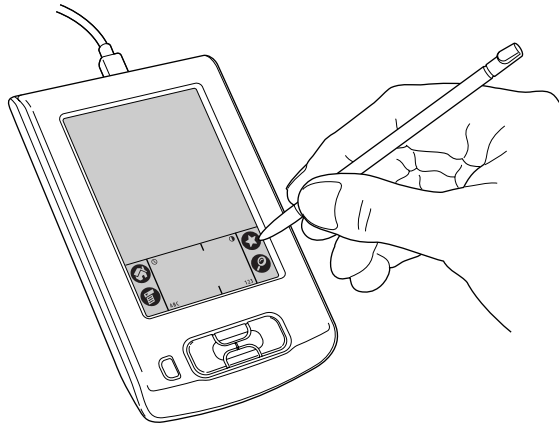

IMPORTANT The first time you perform a HotSync operation, you must enter a username in the New User dialog box and click OK. Every handheld should have a unique name. To prevent loss of a user's records, never try to synchronize more than one handheld to the same username.

The HotSync Progress dialog box appears and synchronization begins.

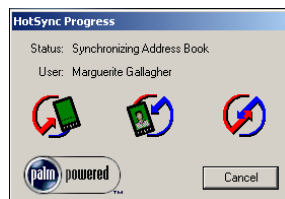

4. Wait for a message on your handheld indicating that the process is complete.
After the HotSync process is complete, you can disconnect your handheld from the cable.

Performing a HotSync operation for the first time: Mac

When you installed Palm Desktop software, you entered a username. This username is the connection between your handheld and your computer.

The first time you perform a HotSync operation, the Palm Desktop software:

- Adds a username to your handheld.
- Creates a folder for the username in the Users folder inside the Palm folder. For example, if you entered Jane Garcia as your username, a folder called Jane Garcia is created in the Users folder.

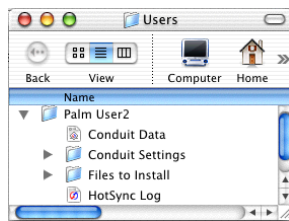

- Creates a file named User Data in your username folder.

NOTE Usernames appear in the User pop-up menu in the Palm Desktop toolbar. You can change users by selecting a new name in the pop-up menu.

Each subsequent time you perform a HotSync operation, HotSync Manager reads the username from your handheld and synchronizes the data in the folder of the same name.

NOTE Be sure you select the correct username from the User pop-up menu before entering data on Palm Desktop or performing a HotSync operation.

If you are a System Administrator preparing several handhelds for a group of users, you may want to create a user profile. See [“Creating a user profile”](#) in [Chapter 14](#) before performing the following steps.

The following steps assume that you have already installed Palm Desktop software. See [“Step 4: Install Palm Desktop software and perform a HotSync operation”](#) in [Chapter 1](#) if you have not installed this software.

To perform a local HotSync operation on a Mac:

1. Connect your handheld to your computer using the HotSync cable.

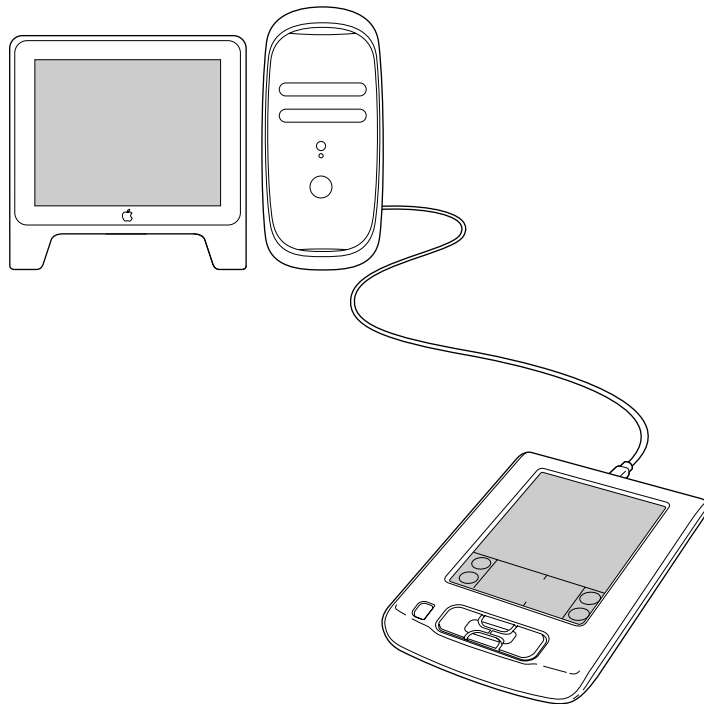

2. Make sure HotSync Manager is enabled: Double-click the HotSync Manager icon in the Palm folder. Click the HotSync Controls tab and make sure the Enabled option is selected.
3. Turn on your handheld and tap the Favorite icon .

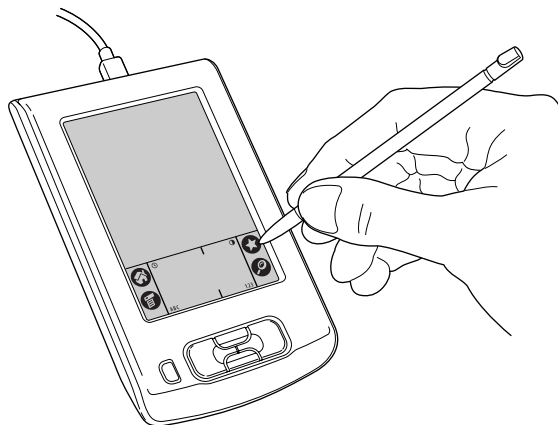

The HotSync Progress dialog box appears followed by the Select User dialog box.

4. In the Select User dialog box, select the username you entered when you installed the Palm Desktop software, and click OK.

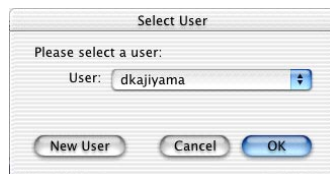

The HotSync Progress dialog box reappears and synchronization begins.

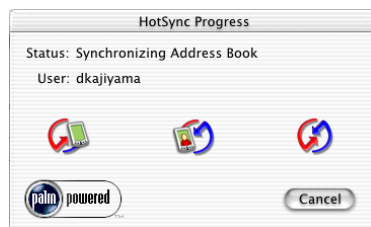

5. Wait for a message on your handheld indicating that the process is complete.

After the HotSync process is complete, you can disconnect your handheld from the cable.

IR HotSync operations

You can use the IR port on your handheld to perform HotSync operations. When you perform an IR HotSync operation, you don't need your cable. However, you must have a computer that is equipped with an IR port and supports the IrCOMM implementation of the Infrared Data Association (IrDA). This is especially useful if you travel with an infrared-enabled laptop. You simply enable infrared communication on your laptop and handheld and follow the steps in [“Performing an IR HotSync operation”](#) later in this section.

Preparing your computer for infrared communication

Before you can perform a HotSync operation using the IR port, the computer with which you want to synchronize must fulfill these requirements:

- Your computer must support the IrCOMM implementation of the IrDA standards.
- Your computer must have an enabled infrared port that is built into the computer, or an enabled infrared device attached to the computer.
- Some desktop computers may require an infrared device attached to a physical COM port. Laptops are likely to have a built-in IR port, so no external device is necessary.

- Your computer must have an installed infrared driver.

If you have an external infrared device attached to your computer, a driver is probably included with the device. Consult the documentation included with the device for information on installing the required driver.

Check your computer's documentation to learn if the computer supports infrared communication.

Configuring HotSync Manager for infrared communication

Next, you need to configure HotSync Manager for infrared communication.

To configure HotSync Manager for infrared communication on a Windows computer:

1. Click the HotSync Manager icon  in the Windows system tray, and make sure Infrared is checked. If you do not have an Infrared option on the HotSync Manager menu, complete the following steps.
2. Make sure Local Serial is checked on the menu.
3. Select Setup.
4. Click the Local tab.
5. In the Serial Port selector, select the simulated port that your computer uses for infrared communication.

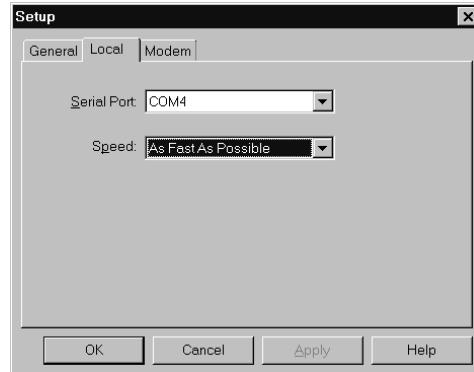

NOTE See the documentation for your operating system for instructions on finding the simulated port. This information is usually located in the Control Panel.

6. Click OK.

NOTE You can continue to use your cable while HotSync Manager is configured for infrared communication.

To configure HotSync Manager for infrared communication on a Mac:

1. Double-click the HotSync Manager icon in the Palm folder.
2. In the HotSync Controls tab, select Enabled.

3. Click the Connection Settings tab.
4. Select the On check box next to IR Port.

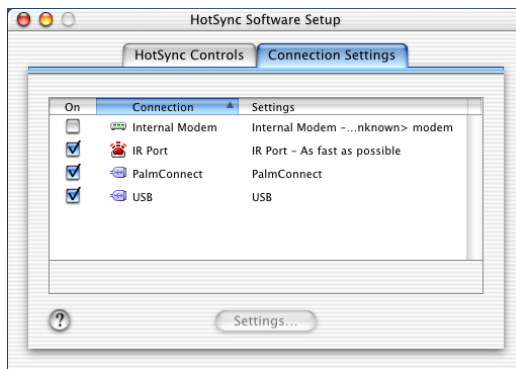



5. Close the HotSync Software Setup window.

Performing an IR HotSync operation

After you complete the steps to prepare for performing an IR HotSync operation, it is easy to perform the actual operation.

To perform an IR HotSync operation:

1. Tap the Home icon .
2. Tap the HotSync icon .
3. Tap Local.
4. Tap the pick list below the HotSync icon and select IR to PC/Handheld.
5. Position the IR port of your handheld within a couple of inches of the infrared port of your computer.
6. Tap the HotSync icon to start the IR HotSync operation.

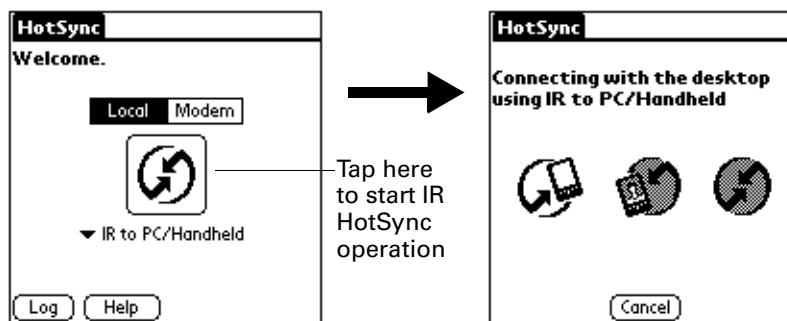

Remote HotSync operations

You can use a modem and an infrared-enabled phone to synchronize your handheld when you are away from your computer.

NOTE The first HotSync operation must be local, using the cable. After that, you can perform a remote HotSync operation.

To perform a remote HotSync operation you need the following:

- A modem connected to your computer.
- Palm Desktop software configured for use with the modem.
- An infrared-enabled phone.
- A configuration for the kind of modem connection you want to make. See [“Connection preferences”](#) in [Chapter 15](#) for more information.

Preparing your computer

There are a few steps you must perform to prepare your computer for a remote HotSync operation. Be sure to perform these steps before you leave your office so that your computer is ready to receive a call from your handheld.

To prepare your Windows computer for a remote HotSync operation:

1. Confirm that the computer modem is connected and turned on, and that no communications applications, such as fax or telephony software, are running on a COM port.

NOTE Make sure the computer is disconnected from all online services, such as America Online (AOL). This helps to avoid conflicts with the COM port. You should also make sure that your computer does not go into sleep mode.

2. Start HotSync Manager if it is not already running, and from the HotSync Manager menu, select Modem.

- Adjust the following options as needed.

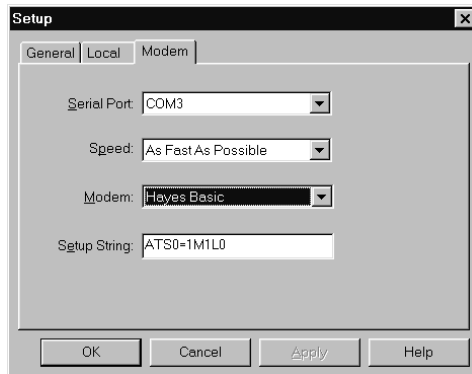

- | | |
|---------------------|---|
| Serial Port | Identifies the port for the modem. If you are unsure of the port assignment, look at the Modem Properties in the Windows Control Panel. |
| Speed | Determines the speed at which data is transferred. Try the As Fast As Possible rate first, and adjust downward if you experience problems. This setting allows Palm Desktop software and your handheld to find and use the fastest speed. |
| Modem | Identifies the modem type or manufacturer. Refer to your modem manual or face plate for its type or settings. If you're not sure of your modem type or your modem doesn't match any that appear in the list, select Hayes Basic. |
| Setup String | Identifies the setup string for your particular modem. Not all modems require a setup string. Refer to your modem manual and enter the setup string if recommended by the manufacturer. |

- Click OK.

To prepare a Mac for a remote HotSync operation:

- Confirm that the computer modem is connected and turned on, and that no communications applications, such as fax or telephony software, or AppleTalk networking are running on that serial port.

NOTE Make sure your computer is disconnected from all online services, such as CompuServe and America Online (AOL). This helps to avoid conflicts with the serial port. In addition, your computer must be on, and it should not be in sleep mode when receiving a call from a remote handheld.



- Double-click the HotSync Manager icon in the Palm folder.
- Click the HotSync Controls tab and enable the Transport Monitor, if it is not already enabled.
- Click the Connection Settings tab.

5. Select the On check box of the modem connection you're using, and then click Settings.
6. In the Settings dialog box, select Modem as the connection type, if it is not already selected.
7. Select the appropriate modem type. Click OK.
8. Close the HotSync Software Setup window.

Preparing your handheld

There are a few steps you must perform to prepare your handheld for a remote HotSync operation.

To prepare your handheld for a remote HotSync operation:

1. Tap the Home icon .
2. Tap the HotSync icon .
3. Tap Modem.

NOTE To change the speed setting of the connection between your handheld and phone, see [“Configuring an IR to phone connection”](#) in [Chapter 15](#).

4. Tap the Enter phone # field.

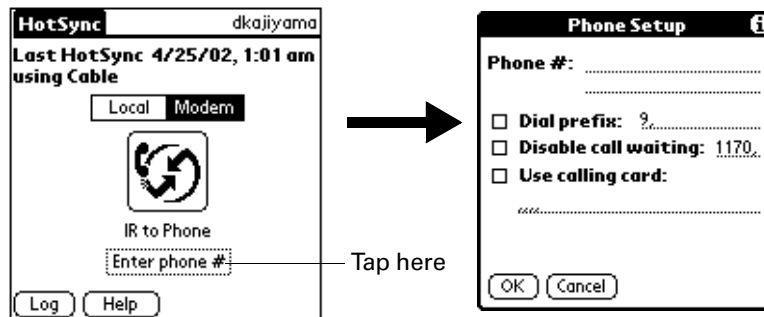

5. Enter the telephone number to access the modem connected to your computer.

TIP You can enter a comma in the field to introduce a “pause” in the dialing sequence. Each comma equals a two-second pause.

NOTE If the phone line you're using for the handheld has call waiting, disable call waiting to avoid an interruption during the remote HotSync operation. Contact your phone service provider to find out how to disable call waiting.



6. Tap OK.

Selecting the conduits for a remote HotSync operation

The Conduit Setup dialog box on your handheld enables you to define which files and/or applications synchronize during a remote HotSync operation. You can use these settings to minimize the time required to synchronize data with a modem.

NOTE These settings only apply when you perform a remote HotSync operation. During a local HotSync operation using your cable, everything is synchronized.

To change the Conduit Setup for a remote HotSync operation:

1. Tap the Home icon .
2. Tap the HotSync icon .
3. Tap the Menu icon .
4. Tap Options, and then tap Conduit Setup.
5. Tap the check boxes to deselect the files and applications that you do *not* want to synchronize during a remote HotSync operation. The default setting is to synchronize all files.

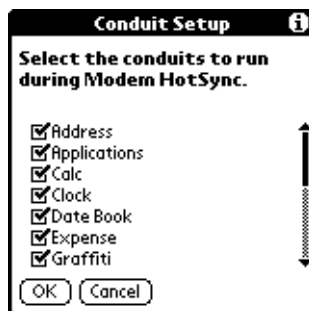



NOTE Applications that do not have a database (such as games) do not synchronize—even if you select the item in the Conduit Setup dialog box.

6. Tap OK.

Performing a remote HotSync operation

After you prepare your computer and your handheld, and select your Conduit Setup options, you are ready to perform a remote HotSync operation.

To perform a remote HotSync operation:

1. Tap the Home icon .
2. Tap the HotSync icon .
3. Tap the Modem icon  to dial the Palm Desktop modem and synchronize the applications.

4. Wait for the HotSync operation to complete. If you have any problems conducting a successful HotSync operation, see [“HotSync problems”](#) in [Appendix B](#).

Returning to cable HotSync operations

It's easy to return to using the cable for HotSync operations. You can even leave your handheld set to perform IR HotSync operations and still use the cable. This is useful if you perform HotSync operations with both your desktop computer and a laptop that you travel with. When you travel, you don't have to carry the cable because your handheld is set to perform IR HotSync operations.

To return to cable HotSync operations on a Windows computer:

1. Connect the cable to the USB port of your computer you use for HotSync operations.
2. Click the HotSync Manager icon  in the Windows system tray, and select Local USB if it is not already checked.

To return to cable HotSync operations on a Mac:

- Simply connect the cable to the USB port of your computer you use for HotSync operations.

Using File Link

The File Link feature enables you to import Address Book and Memo Pad information onto your handheld from a separate external file such as a company phone list. HotSync Manager stores the data in a separate category on your Palm Desktop software and your handheld. You can configure the File Link feature to check for changes to the external file when you perform a HotSync operation.

With File Link, you can import data stored in any of the following formats:

- Comma-separated (*.csv)
- Memo Pad archive (*.mpa)
- Address Book archive (*.aba)
- Text (*.txt)

For information on how to set up a file link, see the Palm Desktop online Help.

NOTE The File Link feature is not available in Palm Desktop software for the Mac.

Creating a user profile

A user profile enables you to install the same set of data onto multiple Palm OS handhelds before each handheld is individualized with a specific username and data file.

A handheld that is preconfigured with a user profile can be given to anyone because the handheld is not yet identified by a unique username. The handheld acquires a unique username when the new user performs his or her first local HotSync operation.

For example, suppose a sales organization wants to distribute two dozen handhelds that all have a common company phone list, a set of memos, and several key applications. A user profile can be created to install the common data before the handhelds are distributed to the employees who will use them. Then when the employees perform their first HotSync operation, the common data becomes part of their individual data file.

NOTE The handhelds that are synchronized with a user profile must either be new ones that have never been synchronized or handhelds that have had their username and data removed by a hard reset.

To create a user profile on a Windows computer:

1. Open Palm Desktop software.
2. From the Tools menu, select Users.
3. Click Profiles.
4. Click New.

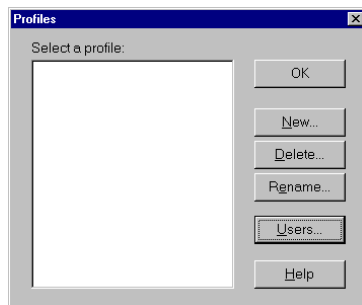

5. Enter a unique name for the profile and click OK.

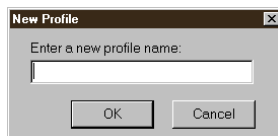

6. Repeat steps 3 and 4 for each profile that you want to create, and then click OK to return to Palm Desktop software.
7. Select the profile from the User list and create the data for the profile (e.g., company phone list).

To create a user profile on a Mac:

1. Open Palm Desktop software.
2. From the User pop-up menu, select Edit Users.
3. Click New Profile.

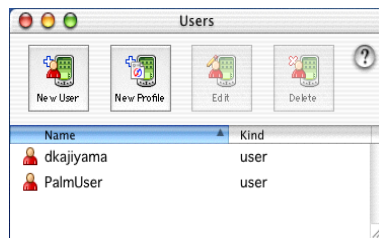

4. Enter a unique name for the profile and click OK.

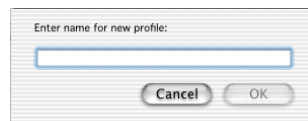

5. Close the Users window.
6. From the User pop-up menu, select the new profile.
7. Create the data for the profile (such as a company phone list).
8. From the HotSync menu, select Conduit Settings.
9. Select the conduit settings for the profile. See [“Customizing HotSync application settings”](#) earlier in this chapter for details.

Performing the first HotSync operation with a user profile

After you create a user profile, you must perform a HotSync operation to transfer the profile data to the handheld.

To use a profile for the first-time HotSync operation on a Windows computer:

1. Connect the new handheld to the cable.
2. Tap the Favorite icon
3. Click Profiles.

4. Select the profile you want to load on the handheld, and click OK.

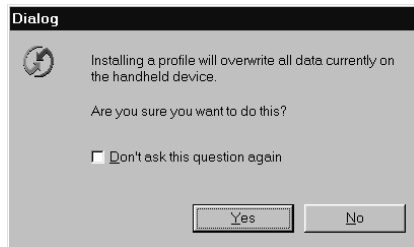

5. Click Yes to transfer all the profile data to the handheld.

The next time you perform a HotSync operation, Palm Desktop software prompts you to assign a username to the handheld.

To use a profile for the first-time HotSync operation on a Mac:

1. Connect the new handheld to the cable.
2. Tap the Favorite icon .
3. Select the profile you want to load on the handheld, and click OK to transfer all the profile data to the handheld.

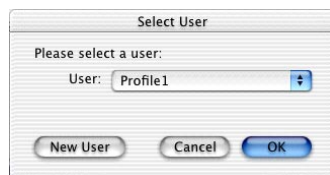



The next time you perform a HotSync operation with this handheld, Palm Desktop software prompts you to assign a username to the handheld.

Setting Preferences for Your Handheld

The Preferences screens enable you to customize the configuration options on your handheld, including the following:

Buttons	Assign different applications to the buttons on the front panel of your handheld, the Favorite icon in the Graffiti® writing area, and reassign the full-screen pen stroke command.
Pen	Change the assignment of the full-screen pen stroke.
Connection	Configure cable, IR to phone, and IR to PC/handheld communication settings.
Date and Time	Set the date, time, time zone, and Daylight Saving switch.
Digitizer	Calibrate the screen on your handheld.
Formats	Set the country default and the formats for dates, times, calendar, and numbers.
General	Set the auto shut-off interval, on while charging option, system, alarm, and game sounds, and the Beam Receive feature.
Network	Configure the TCP/IP software that is included in the handheld operating system.
Owner	Assign your name, phone number, and other owner information to your handheld.
ShortCuts	Define a list of Graffiti abbreviations.

To open the Preferences screens:

1. Tap the Home icon .
2. Tap the Preferences icon .
3. Tap the pick list in the upper-right corner of the screen.
4. Select the Preferences screen you want to view.

Buttons preferences

The Buttons Preferences screen enables you to associate different applications with the buttons on the front of the handheld.

For example, if you find that you seldom use Address Book and often use Memo Pad, you can assign the Address Book button to start Memo Pad.

Any changes you make in the Buttons Preferences screen become effective immediately; you do not have to change to a different screen or application.

If you assign a different application to a button, you can still access the original application using the Applications Launcher.

To change the Buttons preferences:

1. Tap the pick list next to the button you want to reassign.

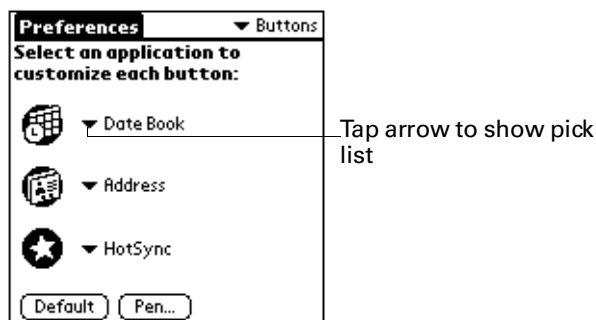

2. Tap the application that you want to assign to the button.

TIP To restore all buttons to their factory settings, tap Default.

Pen preferences

The Buttons Preferences screen enables you to change the assignment of the full-screen pen stroke. By default, the full-screen pen stroke activates Graffiti Help.

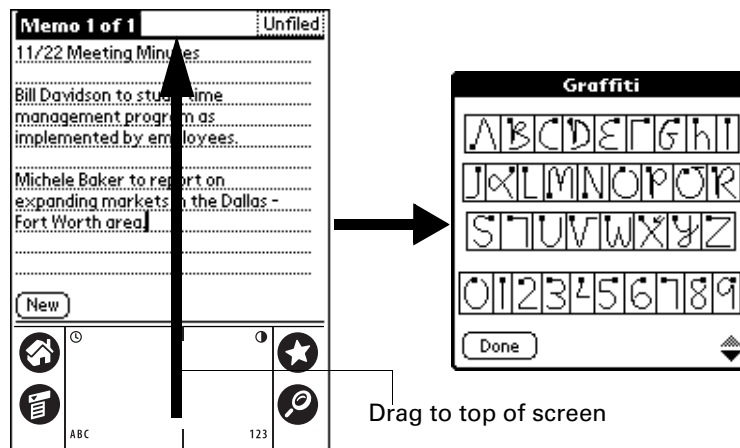

To change the Pen preferences:

1. Tap Pen.



2. Tap the pick list and select one of the following settings for the full-screen pen stroke:

Keyboard	Opens the onscreen keyboard for entering text characters.
Graffiti Help	Opens a series of screens that show the complete Graffiti character set.
Turn Off & Lock	Turns off and locks the handheld. You must assign a password to lock the handheld. When locked, you need to enter the password to use your handheld.
Beam Data	Beams the current record to another device with an IR port.

3. Tap OK.

Connection preferences

The Connection Preferences screen enables you to define the settings used to connect your handheld to other devices. The screen displays a list of available configurations that are ready to be further defined; the list varies depending on the kind of software you've added to your handheld.

For example, an IR to phone connection appears on the list. If you want to set up this connection, you only need to specify the phone setup to complete the configuration.

You can also create custom configurations, which include the following:

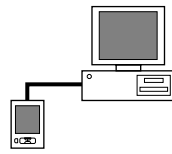

PC via Cable: A local HotSync® connection: the direct connection between your handheld and your desktop computer. Your handheld is connected to the cable, and the cable is attached to the USB port of your desktop computer.



PC via Infrared: A connection between the IR port of your handheld and the infrared device of your computer or laptop.

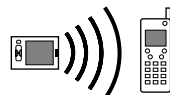

Modem via Infrared: A connection between the IR port of your handheld and a modem. The modem can be attached to or within a mobile phone or some other device containing an IR port. (Some IR phones contain modems.)

Configuring an IR to phone connection

The following example shows you how to edit the IR to Phone connection to adjust the communication speed between your handheld and phone; you can similarly edit other connections or settings. You can use the IR to Phone connection to perform a remote IR HotSync operation. To accomplish the HotSync operation, your handheld sends data through its IR port to a modem attached to or within a mobile phone, which then dials a modem attached to or within your desktop computer, to synchronize with your Desktop application.

To edit the IR to Phone connection:

1. Select the IR to Phone connection and tap Edit.



2. Tap Details.

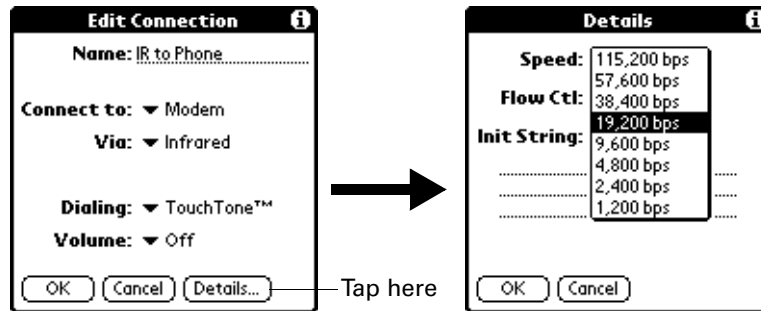

3. Tap the Speed pick list and select the appropriate speed.
4. Enter the initialization string supplied by the documentation for the modem attached to your mobile phone, if necessary.
5. Tap OK, and then tap OK again to save the configuration.

After you create the configuration, you need to set up HotSync Manager and the HotSync application on your handheld to perform a modem HotSync operation.

Date and Time preferences

The Date and Time Preferences screen enables you to set the date, time, time zone, and Daylight Saving option on your handheld. See [“Customizing your handheld”](#) in [Chapter 2](#) for information about using this screen.

Digitizer preferences

The Digitizer Preferences screen opens the digitizer calibration screen. This is the same screen that appears when you start your handheld for the first time.

You can recalibrate your screen after a hard reset, or if your digitizer drifts.

Formats preferences

Use the Formats Preferences screen to set the country default and the display format of the dates, times, and numbers on your handheld.

Country default

The country default sets date, time, week start day, and number conventions based on geographic regions where you might use your handheld. For example, in the United Kingdom, time often is expressed using a 24-hour clock. In the United States, on the other hand, time is expressed using a 12-hour clock with an am or pm suffix.

All your handheld applications use the Country default settings. You can, however, customize your own preferences as described in “[Time, date, week start, and numbers formats](#)” later in this chapter.

To set the country default:

1. Tap the country name pick list.

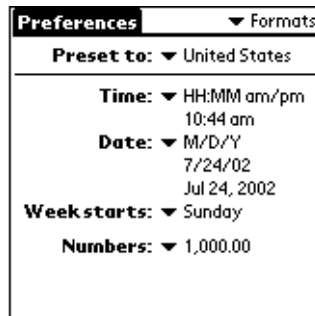

2. Tap the setting you want to use.

Time, date, week start, and numbers formats

The Time setting defines the format for the time of day. The time format that you select appears in all applications on your handheld.

To select the time, date, week start, and numbers format:

1. Tap the Time pick list and select a format.
2. Tap the Date pick list and select a format.
3. Tap the Week starts pick list, and select whether you want the first day of the week to be Sunday or Monday.

NOTE This setting controls the Day, Week, and Month views in Date Book and all other aspects of your handheld that display a calendar.

4. Tap the Numbers pick list, and select formats for the decimal point and thousands separator.

General preferences

The General Preferences screen enables you to set the auto shutoff interval, on while charging option, alarm options, sounds for your handheld, and the Beam Receive feature.

Auto-off delay

Your handheld has an automatic shutoff feature that turns off the power after a period of inactivity. This feature helps conserve battery power in case you forget to turn off your handheld.

If you find that your handheld shuts itself off before you finish reviewing the information on the screen, you should increase the time setting of the automatic shutoff feature.

To set the Auto-off delay:

1. Tap the Auto-off pick list.
2. Tap the setting you want to use for the automatic shutoff feature: 30 seconds, 1 minute, 2 minutes, or 3 minutes.

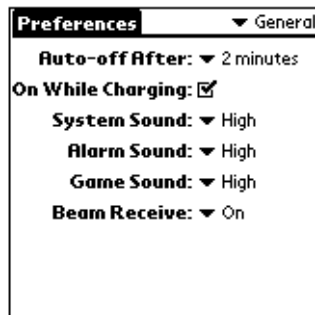

On while charging settings

You can choose to leave your handheld on when it is connected to the HotSync cable, or when you are recharging the battery, so you can continue to view your data.

To change the on while charging settings:

- Tap the On While Charging check box to leave your handheld on when it is attached to the cable or power adapter.

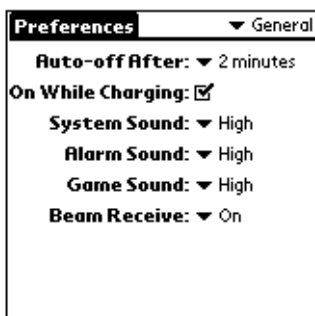

System, alarm, and game sounds

Your handheld uses a variety of sounds. The System, Alarm, and Game Sound settings enable you to turn the sounds on or off, and to adjust the volume level.

To set the system and alarm sounds:

1. Tap the System Sound pick list and select the sound level.

NOTE When you turn off the System Sounds, you also turn off the “chime” tones associated with the HotSync operation.

2. Tap the Alarm Sound pick list and select the sound level.
3. Tap the Game Sound pick list and select the sound level.

NOTE The Game Sound setting works only with games that are programmed to respond to this setting. Older games typically do not respond to this setting.

Beam Receive

You can choose to turn off the Beam Receive feature. This prohibits anyone from beaming information to your handheld. It also results in a slight saving of battery power.

To change the Beam Receive setting:

- Tap the Beam Receive pick list and select On or Off.

Network preferences and TCP/IP software

The Network Preferences settings enable you to use the TCP/IP software that is included in the handheld operating system. You can use the TCP/IP software to connect with Internet Service Providers (ISPs) or dial-in (remote access) servers. Because the TCP/IP software is a feature of the operating system, you configure all parameters relating to it from the Preferences application.

To use TCP/IP, you must create a configuration in Connection Preferences and then create Network Preferences settings.

NOTE The Connection Preferences screen enables you to define several ways that your handheld can use a modem to communicate with remote devices. For example, you can communicate with your ISP server, or with your computer if you are traveling. See “[Connection preferences](#)” earlier in this chapter for information on how to create modem configurations.

After you configure both the Connection and Network Preferences, you can establish a PPP (Point-to-Point Protocol), SLIP (Serial Line Internet Protocol), or CSLIP (Compressed Serial Line Internet Protocol) connection with your ISP or dial-in server. You can do this either by using menu commands from the Network Preferences screen or by using a third-party application.

NOTE TCP/IP provides the ability to connect to your ISP or dial-in server with applications that allow you to view the transmitted data. Visit the web site www.palm.com for information on third-party applications that take advantage of TCP/IP.

Selecting a service

Use the Service setting to select the service template for your ISP or dial-in server. Service templates are a set of ISP and dial-in server configuration settings that you can create, save, and reuse.

To select a service:

1. Tap the Service pick list.

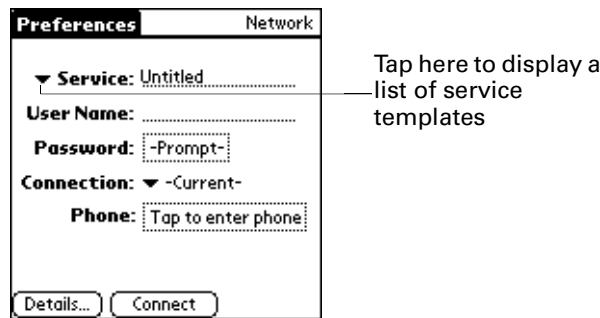

2. Tap the predefined service template you want to use.

Entering a username

The User Name setting identifies the name you use when you log into your ISP or dial-in server. Although this field can contain multiple lines of text, only two lines appear onscreen.

To enter a username:

1. Tap the User Name field.
2. Enter your username.

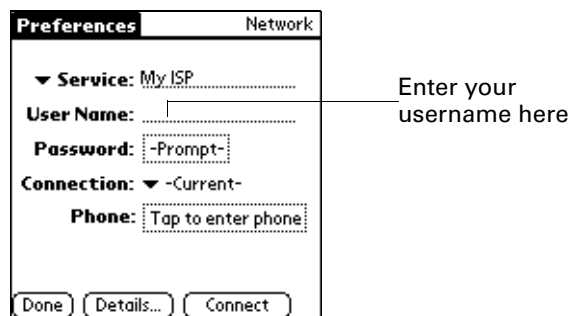

NOTE Most dial-in servers do not accept spaces in the username.

Entering a password

The Password box identifies the password you use to log into your ISP or dial-in server. Your entry in this field determines whether your handheld prompts you to enter a password each time you log into your network:

- If you do not enter a password, your handheld displays the word “Prompt” in this field and asks you to enter a password during the login procedure.
- If you enter a password, your handheld displays the word “Assigned” in this field and does not prompt you to enter a password during the login procedure.

NOTE If you are concerned about security, select the Prompt option and do not enter a password.

To enter a password:

1. Tap the Password field.
2. Enter the password you use to log into your ISP or dial-in server.

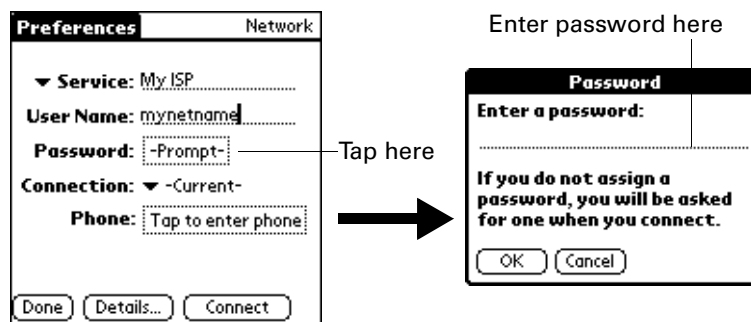

3. Tap OK.

NOTE The Password field updates to display the word “Assigned.”

Selecting a connection

Use the Connection setting to select the method you want to use to connect to your ISP or dial-in server. See [“Connection preferences”](#) earlier in this chapter for information about creating and configuring connection settings.

To select a connection:

1. Tap the Connection pick list.

Tap here to display a list of available connections

2. Tap the connection you want to use.

Adding telephone settings

When you select the Phone field, your handheld opens a dialog box in which you define the telephone number you use to connect with your ISP or dial-in server. In addition, you can also define a prefix, disable call waiting, and give special instructions for using a calling card.

NOTE The Phone Setup dialog box works correctly for AT&T and Sprint long-distance services. However, because MCI works differently, MCI customers need to put the calling card number in the Phone # field and the phone number in the Use calling card field.

To enter your server phone number:

1. Tap the Phone field.
2. Enter the phone number for your ISP or dial-in server.

Enter your ISP phone number here

3. If you need to enter a prefix or disable call waiting, skip to those procedures. Otherwise, tap OK.

Entering a prefix

A prefix is a number that you dial before the telephone number to access an outside line. For example, many offices require that you dial “9” to dial a number outside the building.

To enter a prefix:

1. Tap the Dial Prefix check box to select it.



2. Enter the prefix.
3. Tap OK.

Disabling call waiting

Call waiting can cause your session to terminate if you receive a call while you are connected. If your telephone has call waiting, you need to disable this feature before logging into your ISP or dial-in server.

To disable call waiting:

1. Tap the Disable call waiting check box to select it.

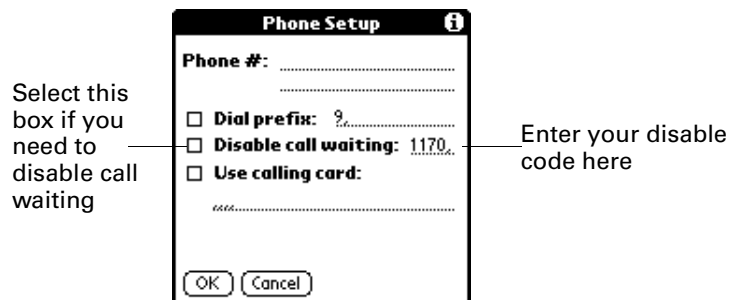

2. Enter the code to disable call waiting on the Disable call waiting line.

NOTE Each telephone company assigns a code to disable call waiting. Contact your local telephone company for the code that is appropriate for you.

3. Tap OK.

Using a calling card

The Use calling card field enables you to use your calling card when dialing your ISP or dial-in server. Keep in mind that there is usually a delay before you enter your calling card number. When you define your calling card number, you need to add commas at the beginning to compensate for this delay. Each comma delays transmission of your calling card number for two seconds.

To use a calling card:

1. Tap the Use calling card check box to select it.



2. Enter your calling card number on the Use calling card line.

NOTE It's a good idea to add at least three commas before your calling card number to compensate for the cue delay.

3. Tap OK.

Connecting to your service

After you set your Connection and Network Preferences, establishing a connection to your ISP or dial-in server is easy.

NOTE If you are connecting to an ISP, you need a third-party application, such as a web browser or news reader, to take advantage of this connection. For information about third-party applications that support TCP/IP, check the web site www.palm.com.

To establish a connection:

- Tap Connect to dial the current service and display the Service Connection Progress messages.

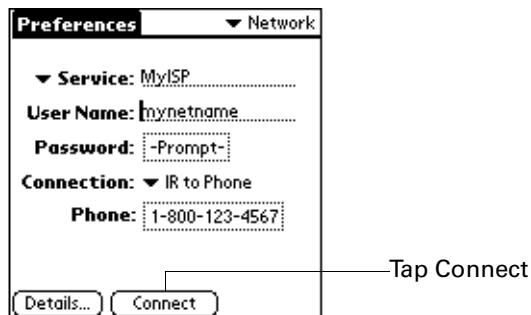

TIP To see expanded Service Connection Progress messages, press the lower Scroll button.

To close a connection:

- Tap Disconnect to terminate the connection between your handheld and your service.

Creating additional service templates

If your service is not in the list of templates, you can create additional service templates from scratch or by duplicating existing templates and editing information. After you create a new or duplicate template, you can add and edit settings.

To add a new service template:

1. Tap the Menu icon .
2. Tap Service, and then tap New.

An Untitled service template is added to the Service pick list.

To duplicate an existing service template:

1. Tap the Service pick list.
2. Tap the predefined service template you want to duplicate.
3. Tap the Menu icon .
4. Tap Service, and then tap Duplicate.

A copy of the service template is added to the Service pick list.

Adding detailed information to a service template

If you are using one of the predefined service templates, you probably only need to enter your username and telephone number. If you are creating a new service template, you may need to provide additional information to your ISP or dial-in server. You use the Details dialog box to add additional information to a selected service template.

To select a connection type:

1. Tap the service field.
2. Tap Details.

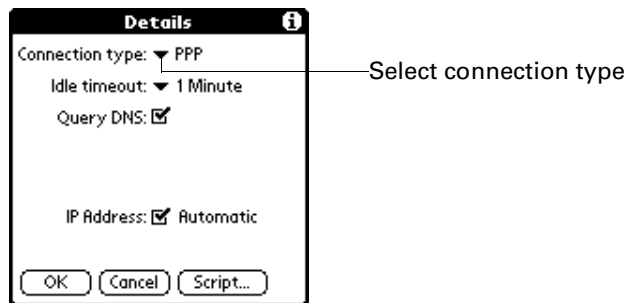

3. Tap the Connection type pick list and select one of the following connection types:

PPP	Point-to-Point protocol
SLIP	Serial Line Internet Protocol
CSLIP	Compressed Serial Line Internet Protocol

NOTE If you are not sure, try PPP; if that doesn't work, ask your Internet Service Provider or your System Administrator for the correct connection type.

Idle timeout

The Idle timeout setting defines how long your handheld waits before dropping the connection with your ISP or dial-in server when you switch out of a TCP/IP application.

To set the Idle timeout:

1. Tap the Idle timeout pick list and select one of the following options:

- | | |
|------------------|--|
| 1 minute | Waits one minute for you to open another application before it drops the connection. |
| 2 minutes | Waits two minutes. |
| 3 minutes | Waits three minutes. |
| Never | Keeps your PPP or SLIP connection until you turn off your handheld (or until it times out). This option works best with the PalmModem accessory. |

2. Tap OK.

Defining primary and secondary DNS

The Domain Naming System (DNS) is a mechanism in the Internet for translating the names of host computers into IP addresses. When you enter a DNS number (or IP address), you are identifying a specific server that handles the translation services.

Each IP address has four sections, separated by periods. In the Details dialog box, you enter each section separately. Each section of an IP address is made up of a number from 0 to 255; numbers are the only allowable characters in this field.

Ask your Internet Service Provider or System Administrator for the correct Primary or Secondary DNS IP numbers.

TIP Many systems do not require that you enter a DNS. If you are not sure, leave the DNS field blank.

To enter a primary and secondary DNS:

1. Tap the Query DNS check box to deselect it.

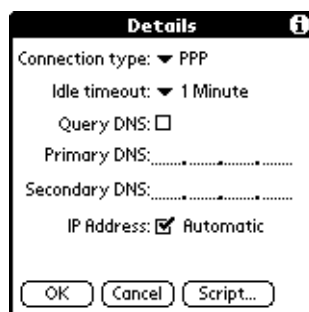

2. Tap the space to the left of the first period in the Primary DNS field, and then enter the first section of the IP address.

NOTE Each section must be a number from 0 to 255.

3. Repeat step 2 for the second, third, and last sections of the Primary DNS field.

4. Repeat steps 2 and 3 for the Secondary DNS number.
5. Tap OK.

IP address

Everyone who logs on to the Internet needs to have a unique identifier (an IP address), whether permanent or temporary. Some networks dynamically assign a temporary IP address when clients log in. The IP Address field lets you identify whether your network provides automatic (dynamic) temporary IP addressing.

NOTE If your IP address is permanently assigned, you need to get that information from your System Administrator. If you are not sure, select Automatic.

To identify dynamic IP addressing:

- Tap the IP Address check box to select it.

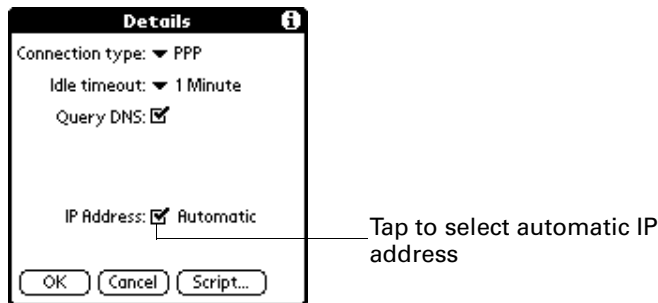

To enter a permanent IP address:

1. Tap the IP Address check box to deselect it and display a permanent IP address field below the check box.
2. Tap the space to the left of the first period then enter the first section of the IP address.

NOTE Each section must be a number from 0 to 255.

3. Tap and enter the remaining sections of the IP address.
4. Tap OK.

Login scripts

A login script is a series of commands that automates logging into a network server, for example, your corporate network or your ISP. A login script is associated with a specific service template created in Network Preferences.

A login script is something that you are likely to receive from your IS System Administrator if your company has a system in which you log into the corporate servers from your handheld using a modem or network connection. The script is generally prepared by the System Administrator and distributed to users who

need it. It automates the events that must take place in order to establish a connection between your handheld and the corporate servers.

You can create login scripts in two ways:

- In a text editor on your desktop computer, in which you create a file with the extension PNC, which you then install on your handheld using the Install Tool (this method is not available to Mac users)
- In the Login Script dialog box on your handheld, accessed from the Details dialog box in Network Preferences

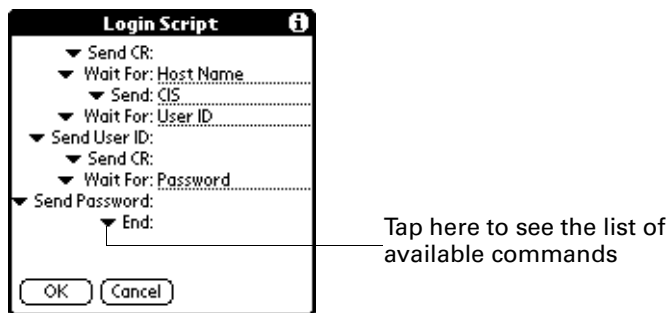

NOTE You can also use non-ASCII and literal characters in your login script. See [Appendix C](#) for more information.

Creating a login script on your handheld

You can create login scripts by selecting commands from the Command pick list in the Login Script dialog. Some commands, such as Send, require you to supply additional information. Those commands have a parameter field so that you can add the necessary data. See [Appendix C](#) for more information on login scripts.

To create a login script:

1. Tap Script.
2. Tap the End pick list.

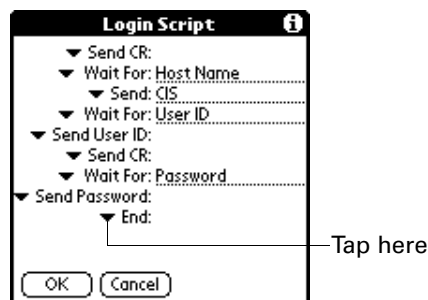

3. Tap the command you want from the Command list. If the command requires additional information, a field appears to the right of it for you to enter the information. The following commands are available:

Wait For	Tells your handheld to wait for specific characters from the TCP/IP server before executing the next command.
Wait For Prompt	Detects a challenge-response prompt coming from the server and then displays the dynamically generated challenge value. You then enter the challenge value into your token card, which in turn generates a response value for you to enter on your handheld. This command takes two arguments, separated by a vertical bar () on the input line.
Send	Transmits specific characters to the TCP/IP server to which you are connecting.
Send CR	Transmits a carriage return or LF character to the TCP/IP server to which you are connecting.
Send User ID	Transmits the User ID information entered in the User ID field of the Network Preferences screen.
Send Password	Transmits the password entered in the Password field of the Network Preferences screen. If you did not enter a password, this command prompts you to enter one. The Password command is usually followed by a Send CR command.
Delay	Tells your handheld to wait a specific number of seconds before executing the next command in the login script.
Get IP	Reads an IP address and uses it as the IP address for your handheld. This command is used with SLIP connections.
Prompt	Opens a dialog box and prompts you to enter text of some kind (for example, a password or a security code).
End	Identifies the last line in the login script.

4. Repeat steps 2 and 3 until the login script is complete.
5. Tap OK.

Deleting a service template

There is only one way to delete a service template: use the Delete command from the Service menu.

To delete a service template:

1. Tap the Service pick list.
2. Tap the service template you want to delete.
3. Tap the Menu icon .
4. Tap Service, and then tap Delete.
5. Tap OK.

Network preferences menu commands

The Network Preferences screen includes menu commands to make it fast and easy to create and edit service templates. TCP/IP application menus are shown here for your reference. See “Using menus” in Chapter 4 for more information about choosing menu commands.

Service menu

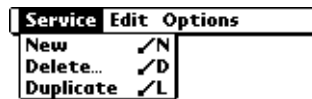

Options menu



TCP/IP troubleshooting

If you are having a problem establishing a network connection using TCP/IP, try the suggestions listed.

Displaying expanded Service Connection Progress messages

It's helpful to identify at what point in the login procedure the connection fails. An easy way to do this is to display the expanded Service Connection Progress messages. Expanded Service Connection Progress messages describe the current stage of the login procedure. Press the lower half of the scroll button at any point during login to display these messages.

Viewing the Network Log

If viewing the expanded Service Connection Progress messages does not give you enough information to find out why you cannot connect to your ISP or dial-in server, take a look at the Network Log. The Network Log lists all of the communication that occurs between your modem and your dial-in server during the login procedure. The information in the Network Log can help your ISP or your System Administrator pinpoint where the login procedure communication fails and why.

To view the Network Log:

1. Tap the Menu icon .
2. Tap Options, and then tap View Log.
3. Tap the up and down arrows of the scroll bar to see the entire Network Log.
4. Tap Done.

Adding a DNS number

If your ISP or dial-in server requires a DNS number and you did not enter that information in the Network Preferences screen, it will appear that you successfully logged into your network. When you try to use an application or look up information, however, the connection fails. If this occurs, try adding a DNS number. Ask your ISP or your System Administrator for the correct Primary and Secondary DNS IP numbers.

Owner preferences

The Owner Preferences screen enables you to record a name, company name, phone number, or any other information that you want to associate with your handheld.

If you use the Security application to turn off and lock your handheld with a password, information that you put in the Owner Preferences displays the next time you turn on your handheld. See [“Locking your handheld”](#) in [Chapter 12](#) for more information on setting a password for your handheld.

To enter the Owner preferences:

- Enter the text that you want to associate with your handheld in the Owner Preferences screen. If you enter more text than can fit on one screen, a scroll bar automatically appears on the right side of the screen.



If you assign a password with the Security application, the information in the Owner Preferences screen cannot be changed. In this case, an Unlock button appears at the bottom of the screen.

To unlock the Owner Preferences screen:

1. Tap Unlock.
2. Enter the password that you defined in the Security application.
3. Tap OK.

ShortCuts preferences

The ShortCuts Preferences screen enables you to define abbreviations for entering text with Graffiti strokes. This section describes how to create, edit, and delete a ShortCut. See “Graffiti ShortCuts” in [Chapter 3](#) for more information on the use of ShortCuts.

Creating a ShortCut

You can create a ShortCut for any words, letters, or numbers. All ShortCuts you create appear on the list in the ShortCut Preferences screen. All the ShortCuts are available in any of your handheld applications and are backed up on your computer when you perform a HotSync operation.

To create a ShortCut:

1. Tap New.
2. On the ShortCut name line, enter the letters you want to use to activate the ShortCut.

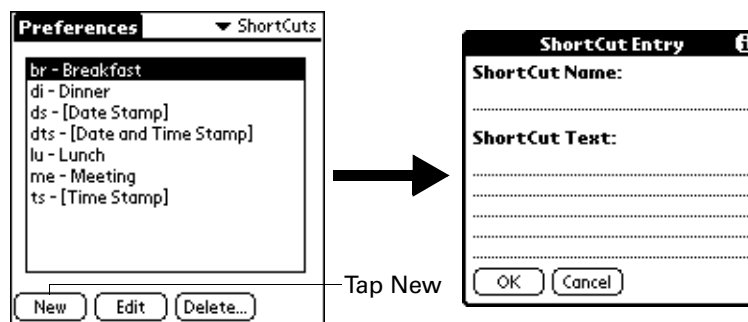

3. Tap the ShortCut Text area and enter the text that you want to appear when you write the ShortCut characters.

TIP You may want to add a space (space character) after the last word in your ShortCut text. This way, a space automatically follows the ShortCut text.

4. Tap OK.

TIP To use a ShortCut, draw the ShortCut stroke followed by the ShortCut characters. When you draw the ShortCut stroke, the ShortCut symbol appears at the insertion point to show that you are in ShortCut mode.

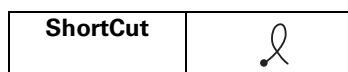

Editing a ShortCut

After you create a ShortCut, you can modify it at any time.

To edit a ShortCut:

1. Tap the ShortCut you want to edit.
2. Tap Edit.
3. Make the changes you want and tap OK.

Deleting a ShortCut

If you no longer need a ShortCut, you can delete it from the list of ShortCuts.

To delete a ShortCut:

1. Tap the ShortCut you want to delete.
2. Tap Delete.
3. Tap Yes.

Maintaining Your Handheld

This chapter provides information on the following:

- Proper care of your handheld
- Prolonging battery life
- Resetting your handheld

Caring for your handheld

Your handheld is designed to be rugged and reliable and to provide years of trouble-free service. Please observe the following general tips when using your handheld:

- Take care not to scratch the screen of your handheld. Keep the screen clean. When working with your handheld, use the supplied stylus or plastic-tipped pens intended for use with a touch-sensitive screen. Never use an actual pen or pencil or other sharp object on the surface of the handheld screen.
- Your handheld is not waterproof and should not be exposed to rain or moisture. Under extreme conditions, water may enter the circuitry through the front panel buttons. In general, treat your handheld as you would a pocket calculator or other small electronic instrument.
- Take care not to drop your handheld or subject it to any strong impact. Do not carry your handheld in your back pocket: if you sit on it, you may damage it.
- Protect your handheld from temperature extremes. For example, do not leave your handheld on the dashboard of a car on a hot day or on a day when temperatures are below freezing, and keep it away from heaters and other heat sources.
- Do not store or use your handheld in any location that is extremely dusty, damp, or wet.
- Use a soft, damp cloth to clean your handheld. If the surface of the handheld screen becomes soiled, clean it with a soft cloth moistened with a diluted window-cleaning solution.

Battery considerations

Your handheld comes with a Lithium-ion battery which is recharged each time you connect the handheld to the power adapter. On some computers, your handheld may recharge at a slower rate when it is connected to your computer with its USB cable.

Please note the following considerations about the batteries in your handheld:

- Under normal conditions, your handheld battery should remain charged by connecting it to the power adapter for just a few minutes each day. You can conserve battery life by changing the Auto-off setting that automatically turns the handheld off after a period of inactivity. See “[General preferences](#)” in [Chapter 15](#) for more information.
- If the battery becomes low in the course of normal use, an alert appears on the handheld screen describing the low battery condition. If this alert appears, perform a HotSync® operation to back up your data; then recharge the unit. This helps prevent accidental data loss.
- If the battery drains to the point where your handheld does not operate, it stores your data safely for about a week. In this case, there is enough residual energy in the battery to store the data, but not enough to turn on your handheld. If your handheld does not turn on when you press the power button, you should recharge the unit immediately.
- If your battery drains and you have the unit in an uncharged state for an extended period of time, you can lose all of the stored data. If you backed up your data using Palm™ Desktop software, you can restore your data using a HotSync operation.
- There are no serviceable parts inside your handheld, so do not attempt to open the unit.
- If you ever dispose of your handheld, please dispose of it without damaging the environment. Take your handheld to your nearest environmental recycling center.

Resetting your handheld

Under normal circumstances, you will not have to use the reset button. On rare occasions, however, your handheld may no longer respond to buttons or the screen. In this case, you need to perform a reset to get your handheld running again.

Performing a soft reset

A soft reset tells your handheld to stop what it's doing and start over again. All records and entries stored in your handheld are retained with a soft reset. After a soft reset, the Date and Time Preferences screen appears (to set date and time).

To perform a soft reset:

- Use the tip of an unfolded paper clip (or similar object *without* a sharp tip), to gently press the reset button inside the hole on the back panel of your handheld.

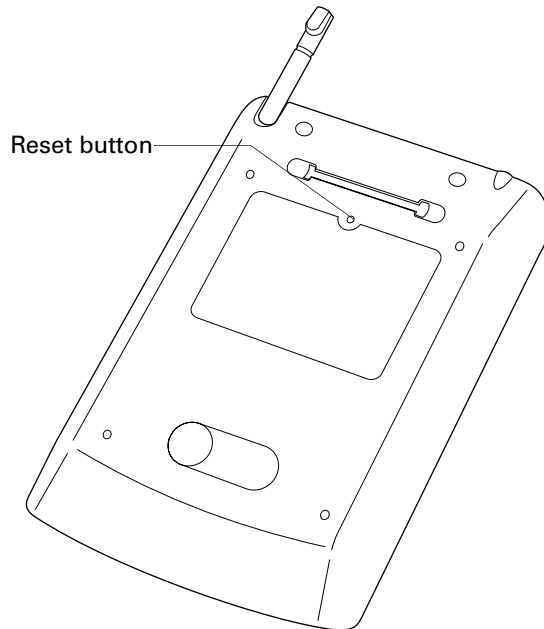

Performing a hard reset

With a hard reset, all records and entries stored in your handheld are erased. Never perform a hard reset unless a soft reset does not solve your problem.

NOTE You can restore any data previously synchronized with your computer during the next HotSync operation.

To perform a hard reset:

1. Hold down the power button on the front panel of the handheld.
2. While holding down the power button, use the tip of an unfolded paper clip (or similar object *without* a sharp tip) to gently press and release the reset button.
3. Wait for the Palm Powered™ logo to appear; then release the power button.
4. When a message appears on the handheld screen warning that you are about to erase all the data stored on your handheld, do one of the following:

Press the upper scroll button on the front panel of the handheld to complete the hard reset and display the Digitizer screen.

Press any other button to perform a soft reset.

NOTE With a hard reset, the current date and time are retained. Formats Preferences and other settings are restored to their factory default settings.

To restore your data from a Windows computer after a hard reset:

1. Click the HotSync icon ™ in the Windows system tray (bottom-right corner of the taskbar).

TIP You can also click the HotSync command on the Palm Desktop software menu bar.

2. From the HotSync Manager menu, select Custom.

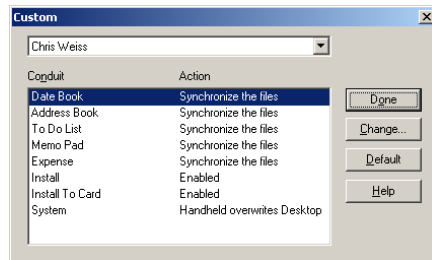

3. Select the appropriate username from the list.
4. Select an application in the Conduit list.
5. Click Change.

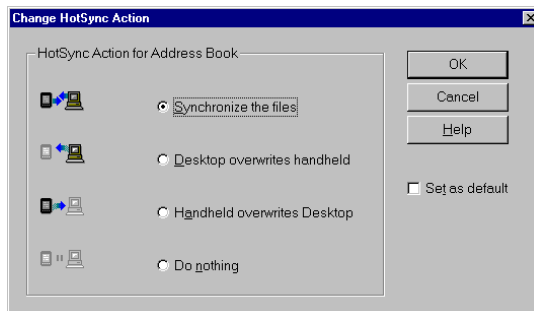

6. Select Desktop overwrites handheld.

NOTE Changing the HotSync setting from the default affects only the *next* HotSync operation. Thereafter, the HotSync Actions revert to their default settings. To use a new setting on an ongoing basis, select the Set As Default box. Thereafter, whatever you selected as the default setting is used when you click the Default button in the Custom dialog.

7. Click OK.
8. Repeat steps 4 through 7 to change conduit settings for other applications.
9. Click Done to activate your settings.
10. Perform a HotSync operation.

To restore your data from a Mac after a hard reset:

1. Double-click the HotSync Manager in the Palm folder.
2. From the HotSync menu, choose Conduit Settings.

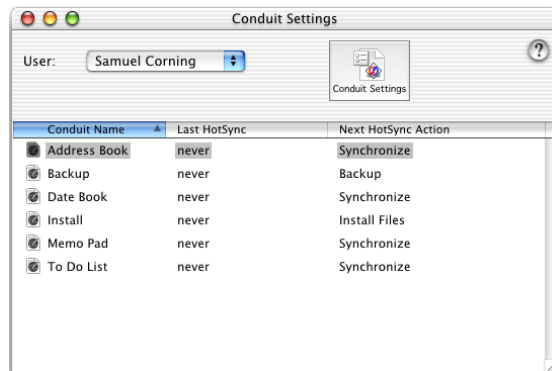

3. From the Users pop-up menu, select the appropriate username.
4. Select an application from the list.
5. Click Conduit Settings.

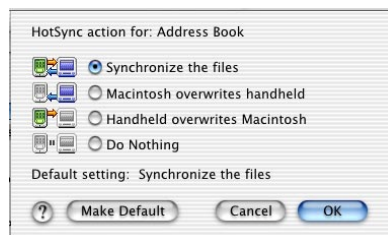

6. Click Macintosh overwrites handheld.

NOTE Changing the HotSync setting from the default affects only the *next* HotSync operation. Thereafter, the HotSync Actions revert to their default settings. To use a new setting on an ongoing basis, click Make Default. Thereafter, whatever you selected as the default setting is used for HotSync operations.

7. Click OK.
8. Repeat steps 4 through 7 to change conduit settings for other applications.
9. Close the Conduit Settings window.
10. Perform a HotSync operation.

Frequently Asked Questions

If you encounter a problem with your handheld, do not call Technical Support until you have reviewed the following list of frequently asked questions, and you have also reviewed the following:

- The README file located in the folder where you installed the Palm™ Desktop software on your computer
- The Palm Desktop online Help
- The *Palm Desktop software for the Macintosh User's Guide* located in the Documentation folder in the Palm Desktop software folder
- The "Palm Support Assistant" knowledgebase, accessible at www.palm.com under the Support section
- The most recent Palm™ Zire™ handheld HelpNotes on your regional web site

If you are still having problems, contact Technical Support. For US and International telephone numbers, go to www.palm.com/support.

NOTE Thousands of third-party add-on applications have been written for Palm OS® handhelds. Unfortunately, we are not able to support such a large number of third-party applications. *If you are having a problem with a third-party application, please contact the developer or publisher of that software.*

Software installation problems

Problem

Solution

The Palm Desktop Installer Menu did not appear when I inserted the CD-ROM into my Windows computer.

1. Click the Start button.
2. Select Run from the Start menu.
3. Click Browse.
4. Locate your CD-ROM or DVD drive and double-click the autorun.exe file.

I cannot install Palm Desktop software on my Windows computer.

1. Disable any virus scanning software on your computer.
2. Press CTRL-ALT-DELETE and end all tasks except Systray and Explorer.

NOTE If a dialog box with buttons appears instead of a list of tasks, click the Task List button and then end all tasks except Systray and Explorer.

3. Make sure your computer has at least 50MB of disk space available.
4. Delete all temporary files.
5. Run ScanDisk on your computer.
6. Reinstall Palm Desktop software.

I cannot install Palm Desktop software on a Mac.

1. Disable any virus scanning software on your computer.
2. Quit any open applications.
3. Make sure your computer has at least 25MB of disk space available.
4. Reinstall Palm Desktop software.

Operating problems

Problem

I don't see anything on my handheld's screen.

Solution

- Press an application button to ensure your handheld is turned on.
- Tap the Contrast icon  in the upper-right corner of the Graffiti® writing area. If the Contrast dialog box appears, adjust the contrast by holding down the up scroll button for a few seconds. If this doesn't work, hold the down scroll button for a few seconds.
- If your handheld was exposed to cold, make sure it is at room temperature.
- Make sure the batteries are charged. Check the electric outlet you used to charge your handheld to make sure it is working.
- Perform a soft reset. If your handheld still doesn't turn on, perform a hard reset. See ["Resetting your handheld"](#) in [Appendix A](#) for information on how to perform both a soft and hard reset.

IMPORTANT With a hard reset, all records and entries stored in your handheld are erased. Never perform a hard reset unless a soft reset does not solve your problem. You can restore any data previously synchronized with your computer during the next HotSync® operation. See ["Performing a hard reset"](#) in [Appendix A](#) for instructions on restoring your data.

I get a warning message telling me my handheld memory is full.

- Purge records from Date Book and To Do List. This deletes To Do List items and past Date Book events from the memory of your handheld. See ["Purging records"](#) in [Chapter 4](#). You may need to perform a HotSync operation to recover the memory.
- Delete unused memos and records. If necessary, you can save these records. See ["Purging records"](#) in [Chapter 4](#).
- If you have installed additional applications on your handheld, remove them to recover memory. See ["Removing applications"](#) in [Chapter 4](#).

My handheld keeps turning itself off.

Your handheld is designed to turn itself off after a period of inactivity. This period can be set at one, two, or three minutes. Check the Auto-off setting. See ["General preferences"](#) in [Chapter 15](#).

- | | |
|---------------------------------------|--|
| My handheld is not making any sounds. | Check the System, Alarm and Game Sound settings. See “General preferences” in Chapter 15 . |
| My handheld has frozen. | Perform a soft reset. See “Resetting your handheld” in Appendix A . |

Tapping and writing problems

Problem	Solution
When I tap the buttons or screen icons, my handheld activates the wrong feature.	Calibrate the screen. See “Digitizer preferences” in Chapter 15 .
When I tap the Menu icon  , nothing happens.	Not all applications or screens have menus. Try changing to a different application.
I can't get my handheld to recognize my handwriting.	<ul style="list-style-type: none">■ For your handheld to recognize handwriting input with the stylus, you need to use Graffiti writing. See “Using Graffiti writing to enter data” in Chapter 3.■ Make the Graffiti character strokes in the Graffiti writing area, not on the display part of the screen.■ Write Graffiti strokes for letters in the left-hand side, and the strokes for numbers in the right-hand side of the Graffiti writing area.■ Make sure that Graffiti is not shifted into extended or punctuation modes. See “Using Graffiti writing to enter data” in Chapter 3.■ See “Graffiti tips” in Chapter 3 for tips on increasing your accuracy when you write Graffiti characters.

Application problems

Problem	Solution
I tapped the Today button, but it does not show the correct date.	Your handheld is not set to the current date. Make sure the Set Date box in the Date and Time Preferences screen displays the current date. See “ Customizing your handheld ” in Chapter 2 for more information.
I know I entered some records, but they do not appear in the application.	<ul style="list-style-type: none"> ■ Check the Categories pick list (upper-right corner). Choose All to display all of the records for the application. ■ Check Security and confirm that Private Records is set to Show private records. ■ In To Do List, tap Show and see if Show Only Due Items is selected.
I am having problems listing memos the way I want to see them.	<ul style="list-style-type: none"> ■ If you cannot manually arrange the order of the memos in the list screen, check the Memo Preferences setting. Make sure that Sort by is set to Manual. ■ If you choose to view your memos alphabetically on Palm Desktop software and then perform a HotSync operation, the memos on your handheld still appear in the order defined in the Memo Preferences setting. In other words, the sort settings you use with Palm Desktop software <i>are not</i> transferred to your handheld.
I created an event in Date Book, but it doesn't appear in the Week View.	In the Week View, you cannot select overlapping events that have the same start time. If you have two or more events with the same start time, choose the Day View to see the overlapping events.
I entered the euro symbol, but after a HotSync operation it doesn't appear in my Palm Desktop software.	<p>You must have fonts that include the euro symbol on your desktop computer. Check these web sites for additional information:</p> <p>http://www.microsoft.com/windows/euro.asp</p> <p>http://til.info.apple.com/techinfo.nsf/artnum/n22222</p>

HotSync problems

Problem

I cannot perform a HotSync operation; what should I check to make sure I am doing it correctly?

Solution

- Make sure the USB cable is connected securely.

On a Windows computer, try the following:

- Check the Windows system tray to make sure the HotSync Manager is running. If it is not, open Palm Desktop software.
- Make sure you selected Local USB from the HotSync Manager menu.

On a Mac, try the following:

- Make sure HotSync Manager is enabled. If it is not, double-click the HotSync Manager icon in the Palm folder and enable HotSync Manager on the HotSync Controls tab.

I performed a HotSync operation, but one of my applications did not synchronize.

- On a Windows computer, click the HotSync Manager and select Custom. Check that the correct conduit is active.
- On a Mac, double-click the HotSync Manager icon. From the HotSync menu, select Conduit Settings. Select your username from the User pop-up menu, and check that the correct conduit is active.

I am using Outlook as my PIM, but I cannot perform a HotSync operation.

- Click the HotSync Manager and select Custom. Check that the correct conduit is active.
- Check that the correct conduit is installed. Reinstall the HotSync Manager and make sure the correct conduit is selected.

I cannot launch the HotSync Manager.

- Backup the Palm Desktop software, uninstall it, then reinstall it.

I tried to do a local HotSync operation, but it did not complete successfully.

- Make sure the USB cable is connected securely to your handheld.
- Check the connection between the cable and the USB port on your computer.
- Make sure the username you selected in Palm Desktop software matches the username assigned to your handheld.
- Make sure the date on your computer matches the date on your handheld.
- Read the HotSync Log for the user account for which you are performing a HotSync operation.

I tried to do a local HotSync operation, but it did not complete successfully.
(continued)

On a Windows computer, try the following:

- Make sure HotSync Manager is running. If it is running, close it, and restart it.
- Make sure you selected Local USB from the HotSync Manager menu.

On a Mac, try the following:

- Make sure HotSync Manager is enabled on the HotSync Controls tab in the HotSync Software Setup window.

I tried to do a remote (IR to phone) HotSync operation, but it did not complete successfully.

Check the following on your computer:

- Make sure your computer is turned on and that it does not shut down automatically as part of an energy-saving feature.
- Make sure the modem connected to your computer is turned on and is connected to the outgoing phone line.
- Make sure the modem is connected properly to your computer and is connected to the incoming phone line.

On a Windows computer, check the following:

- Make sure Modem is checked in the HotSync Manager menu.
- Confirm that the Setup String in the Setup dialog box configures your modem correctly. You may need to select a different Modem Type or enter a custom Setup String. Most modems have a Setup String that causes them to send initial connection sounds to a speaker. You can use these sounds to check the modem connection.
- Confirm that the Speed setting in the Setup dialog box works for your modem. If you have problems using the As Fast As Possible option or a specific speed, try using a slower speed.
- Make sure you are not running another program, such as WinFax, CompuServe, or America Online that uses the serial port you selected in the Setup dialog box.
- Make sure your modem resets before you try again. (Turn off your modem, wait a minute, then turn it back on.)

I tried to do a remote (IR to phone) HotSync operation, but it did not complete successfully. (continued)

On a Mac, check the following:

- Make sure Modem is selected on the Connection Settings tab in the HotSync Software Setup window.
- You may need to select a different Modem type on the Connection Settings tab. Most modems have a setup string that causes them to send initial connection sounds to a speaker. You can turn on the Modem Speaker option and use these sounds to check the modem connection.
- Make sure your modem resets before you try again. (Turn off your modem, wait a minute, then turn it back on.)
- Make sure the computer is not in sleep mode when you attempt a HotSync operation.

Check the following on your handheld:

- Make sure the dialing instruction dials the correct phone number.
- If the telephone line you are using has Call Waiting, make sure you selected the Disable call waiting option under Modem Sync Phone Setup on your handheld and entered the correct code.
- Make sure the telephone line you are using is not noisy, which can interrupt communications.
- Check the batteries in your modem and replace them if necessary.

I can't perform an IR HotSync operation.

- On a Windows computer, be sure the HotSync Manager is running and the Serial Port for local operations is set to the simulated port for infrared communication. See ["IR HotSync operations"](#) in [Chapter 14](#) for details.
- On a Mac, open the HotSync Software Setup window and be sure HotSync Manager is enabled and that the IR Port Connection Setting is set to On. See ["IR HotSync operations"](#) in [Chapter 14](#) for more information.
- On your handheld, be sure the HotSync application is set to Local, with the option IR to PC/Handheld.
- Be sure the IR port of your handheld is aligned directly opposite to, and within a few inches of, the infrared device of your computer.
- IR HotSync operations do not work after you receive a low battery warning. Check the battery power of your handheld. Recharge the internal battery.

-
- My handheld appears to freeze when I place it near my computer.
- Move your handheld away from the computer's infrared port.
- When I tap the Favorite icon, nothing happens on the Palm Desktop software, and my handheld times out.
- Make a copy of your Palm folder. Uninstall, then reinstall Palm Desktop software.
 - Turn on your handheld and tap the Home icon . Tap the HotSync icon, then tap Local.
- When I perform a HotSync operation, my information does not transfer to Palm Desktop software.
- If you have performed a HotSync operation successfully, but you cannot find the data from your handheld on Palm Desktop software, check to see that you have the correct username selected for viewing data.
 - On a Windows computer, click the HotSync Manager and choose Custom. Check that all conduits are set to synchronize files.
 - On a Mac, double-click the HotSync Manager icon. From the HotSync menu, select Conduit Settings. Select your username from the User pop-up menu, and check that the correct conduit is active.
- My handheld displays the message "Waiting for sender" when it's near my computer's infrared port.
- Your computer's infrared port may be set to search automatically for the presence of other infrared devices. Consult the documentation for your operating system for information about turning off this option.
 - In some cases, simply moving your handheld away from the computer's infrared port solves the problem.
- I want to synchronize my computer with more than one handheld.
- If the computer running Palm Desktop software synchronizes with more than one handheld, each handheld must have a unique name. Assign a username to your handheld the first time you perform a HotSync operation.
 - Please be aware that synchronizing more than one handheld with the same username causes unpredictable results and, potentially, loss of your personal information.

Beaming problems

Problem

I cannot beam data to another device with an IR port.

Solution

- If you are beaming to another Palm handheld, confirm that your handheld and the other Palm OS handheld are between ten centimeters (approximately 4") and one meter (approximately 39") apart, and that the path between the two handhelds is clear of obstacles. Beaming distance to other devices with an IR port may be different.
- Move your handheld closer to the receiving device.

I cannot receive data from another device with an IR port.

- Make sure your handheld's Beam Receive feature is set to On. See "[Beam Receive](#)" in [Chapter 15](#) for more information.

When someone beams data to my handheld, I get a message telling me it is out of memory.

- Your handheld requires at least twice the amount of memory available as the data you are receiving. For example, if you are receiving a 30K application, you must have at least 60K free.
- Perform a soft reset. See "[Performing a soft reset](#)" in [Appendix A](#) for more information.

Password problems

Problem

I forgot the password, and my handheld is not locked.

Solution

- First, use the password hint to try and remember the password. If this does not help, or if you do not have a password hint, you can use Security to delete the password, but your handheld deletes all entries marked as private. However, if you perform a HotSync operation *before* you delete the password the HotSync process backs up all entries, whether or not they are marked private. Then, you can follow these steps to restore your private entries:
 1. Use the Palm Desktop software and cable or infrared communication to synchronize your data.
 2. Tap Forgotten Password in Security to remove the password and delete all private records.
 3. Perform a HotSync operation to synchronize your data and restore the private records by transferring them from your computer to your handheld.

I forgot the password and my handheld is locked.

- First, use the password hint to try and remember the password. If this does not help, or if you do not have a password hint, you must perform a hard reset to continue using your handheld. See [“Performing a hard reset”](#) in [Appendix A](#) for more information.



Technical support

If, after reviewing the sources listed at the beginning of this appendix, you cannot solve your problem, contact your regional technical support office by e-mail, phone, or fax.

Before requesting support, please experiment a bit to reproduce and isolate the problem. When you do contact support, please be ready to provide the following information:

- The version of the operating system you are using: Palm OS 4.1
- The actual error message or state you are experiencing
- The steps you take to reproduce the problem
- The version of handheld software you are using and available memory

To find version and memory information:

1. Tap the Home icon .
2. Tap the Menu icon .
3. Tap App, and then tap Info.
4. Tap Version to see version numbers, and tap Size to see the amount of free memory in kilobytes.

Non-ASCII Characters for Login Scripts

The following information enables you to create custom login scripts that require non-ASCII characters. It is provided for advanced users who understand the use and requirements of such characters in a custom login script.

Use of ^char

You may use the caret (^) to transmit ASCII command characters. If you send ^*char*, and the ASCII value of *char* is between @ and _, then the character is automatically translated to a single-byte value between 0 and 31.

For example, ^M is converted to a carriage return. If *char* is a value between a and z, then the character sequence is translated to a single-byte value between 1 and 26. If *char* is any other value, then the character sequence is not subject to any special processing.

For example, the string "Joe^M" transmits Joe, followed by a carriage return.

Carriage return and line feed

You may include carriage return and line feed commands as part of the login script, when entered in the following format:

- <cr> Sends or receives a carriage return
- <lf> Sends or receives a line feed

For example, the string "waitfor Joe<cr><lf>" waits to receive Joe followed by a carriage return and line feed from the remote computer before executing the next command in the script.

Literal characters

The backslash (\) character defines that the *next character* is transmitted as a literal character, and is not subject to any special processing ordinarily associated with that character.

Examples:

- \^Includes a caret as part of the string
- \<Includes a < as part of the string
- \\Includes a backslash as part of the string

Product Regulatory and Safety Information

FCC Statement

This device complies with part 15 of the FCC rules. Operation is subject to the following two conditions: (1) This device may not cause harmful interference, and (2) this device must accept any interference received, including interference that may cause undesired operation.

NOTE This equipment has been tested and found to comply with the limits for a Class B digital device, pursuant to Part 15 of the FCC rules. These limits are designed to provide reasonable protection against harmful interference in a residential installation. This equipment generates, uses, and can radiate radio frequency energy and, if not installed and used in accordance with the instructions, may cause harmful interference to radio communications. However, there is no guarantee that interference will not occur in a particular installation. If this equipment does cause harmful interference to radio or television reception, which can be determined by turning the equipment off and on, the user is encouraged to try to correct the interference by one or more of the following measures:

- Reorient or relocate the receiving antenna.
- Increase the separation between the equipment and receiver.
- Connect the equipment into an outlet on a circuit different from that to which the receiver is connected.
- Consult the dealer or an experienced radio/TV technician for help.

The use of shielded I/O cables is required when connecting this equipment to any and all optional peripheral or host devices. Failure to do so may violate FCC rules.

CAUTION Changes or modifications not covered in this manual must be approved in writing by the manufacturer's Regulatory Engineering Department. Changes or modifications made without written approval may void the user's authority to operate this equipment.

Responsible Party:

Palm, Inc.
400 N. McCarthy Boulevard
Milpitas, California 95035
United States of America
(408) 878-9000

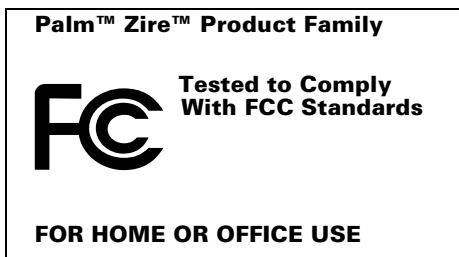

Canadian ICES-003 Statement

This Class B digital apparatus meets all requirements of the Canadian Interference-Causing Equipment Regulations.

Cet appareil numérique de la classe B respecte toutes les exigences du Règlement sur le matériel brouilleur du Canada.



CE Compliance Statement

This product was tested by Palm, Inc. and found to comply with all the requirements of the EMC Directive 89/336/EEC as amended.

Battery Warning

Do not mutilate, puncture, or dispose of batteries in fire. The batteries can burst or explode, releasing hazardous chemicals. Discard used batteries according to the manufacturer's instructions and in accordance with your local regulations.

Varning

Eksplotionsfara vid felaktigt batteribyte. Använd samma batterityp eller en ekvivalent typ som rekommenderas av apparattillverkaren. Kassera använt batteri enligt fabrikantens instruktion.

Advarsel!

Lithiumbatteri—Eksplotionsfare ved fejlagtig håndtering. Udskiftning må kun ske med batteri af samme fabrikat og type. Levér det brugte batteri tilbage tilleverandøren.

Varoitus

Paristo voi räjähtää, jos se on virheellisesti asennettu. Vaihda paristo ainoastaan valmistajan suosittelemaan tyyppiin. Hävitä käytetty paristo valmistajan ohjeiden mukaisesti.

Advarsel

Ekspløsjonsfare ved feilaktig skifte av batteri. Benytt samme batteritype eller en tilsvarende type anbefalt av apparatfabrikanten. Brukte batterier kasseres i henhold til fabrikantens instruksjoner.

Waarschuwing!

Bij dit produkt zijn batterijen geleverd. Wanneer deze leeg zijn, moet u ze niet weggooien maar inleveren als KCA.

Uwaga

Nie kroić lub przekłuwać baterii, ani nie wrzucać ich do ognia. Mogą się rozerwać lub wybuchnąć wydzielając trujące środki chemiczne. Zużytych baterii należy pozbywać się w sposób opisany przez producenta i zgodnie z miejscowymi przepisami.

אזהרה

יש סכנת התפוצצות אם מחליפים את הסוללה בצורה לא נכונה.
יש להחליף את הסוללה בסוללה זהה או דומה, בהתאם להמלצת היצרן.
יש להשליך סוללות משומשות בהתאם להוראות היצרן

A

- ABA (Address Book archive file) 34
- Accented characters
 - Graffiti writing 29
 - onscreen keyboard 23
- Add-on applications 57–61
- Address Book
 - *If Found Call* entry 65
 - adding custom fields 68
 - archive files (.aba) 34
 - business card for beaming 32
 - categorizing records 47
 - conduit for synchronizing 125
 - creating records 43, 64–65
 - deleting records 45
 - displaying category 67
 - displaying data in the Address list 66
 - e-mail addresses 66
 - finding records 51–52
 - fonts 55
 - menus 67
 - notes for records 54–55
 - opening 63
 - overview 63
 - private records 116
 - sorting records 53
- Agenda (Date Book view) 88
- Alarm
 - lists 56
 - preset 90
 - setting in Clock 74
 - setting in Date Book 82
 - setting in Note Pad 105
 - sound 75, 90, 150, 176
- Alphabet
 - Graffiti writing 26
 - onscreen keyboard 14, 16
- Application buttons 11, 37
 - for cycling through views 63, 78
 - reassigning 144

Applications

- Address Book 63
 - beaming 32–33
 - Calculator 69
 - categories 38–39
 - Clock 73
 - Date Book 77
 - Expense 91
 - font style 56
 - installing 57
 - Launcher 37–40
 - Memo Pad 99
 - Note Pad 103
 - opening 38
 - removing 60
 - security 109
 - setting preferences 42
 - size in kilobytes 183
 - To Do List 117
 - version of 183
 - viewing as icons 39
 - viewing as list 39
 - See also* Add-on applications
- ## Archive files
- importing data from 34
 - for main applications 34
 - saving deleted records 45
 - saving purged records 46
- ## Automatic fill, in Expense 98
- ## Auto-off delay 149
- ## Autotext. *See* Graffiti ShortCuts

B

- ## Battery
- conserving power 149
 - recharging 168
 - recycling 168
 - warning 188

- Beaming
 - information 32–34
 - location of IR port 12
 - pen stroke to activate 145
 - problems with 182
- Bold font for text 55
- Business card for beaming 32
- Buttons preferences 144

- C**
- Cable
 - connecting to computer 12
 - viewing data when connected 149
 - for local HotSync operations 139
- Calculator
 - buttons explained 69–70
 - memory 70
 - opening 69
 - overview 69
 - recent calculations 69, 70
- Calibration 15, 147, 176
- Call Waiting, disabling 137, 154
- Calling card, using in phone settings 155
- Capital letters (Graffiti writing) 27
- Caring for the handheld 167
- Categories
 - application 38–39
 - assigning records to 46–47
 - beaming 32–33
 - creating 48
 - default 46
 - displaying 47, 67, 177
 - merging 49
 - renaming 49
 - using in Applications Launcher 38, 39
- Chain calculations 70
- Characters, Graffiti 24
- Charging the handheld 12, 149, 168
- Check boxes 14
- Clearing Calculator entries 69
- Clearing notes 44
- Clock
 - alarm 74
 - alarm preferences 75
 - display options 75
 - menus 75
 - opening 73, 74
- Combining categories 49
- Comma delimited files, importing data from 34
- Command
 - buttons 14
 - equivalents (Graffiti writing) 41
 - toolbar 42
- Command stroke 34, 41, 51
- Compressing Day view 90
- Computer keyboard, entering data with 18
- Conduits
 - for connecting to PIMs 13
 - for modem HotSync operations 138
 - for synchronizing applications 178, 125–126, 170, 171
 - for synchronizing applications, Mac 126–127
- Conflicting events 89
- Connecting
 - service templates 156
 - to server or ISP 155
- Connection
 - preferences 150
 - selecting for network 152
- Connector 12
- Continuous events
 - deleting from Date Book 45
 - scheduling 83
- Contrast control 14
- Copying
 - notes into other applications 103
 - text 44
- Country default setting 148
- Creating
 - Address Book entries 64–65
 - categories 38–39, 48
 - currency symbols 95
 - custom fields in Address Book 68
 - Date Book events 78
 - Expense items 92
 - expense reports 96–97
 - memos 99
 - notes for records 54
 - records 43
- Currencies and symbols, custom 95
- Currency
 - default 95
 - defining 95
 - for Expense items 94
- Current date 177

Current time
 displaying in Date Book 85
 setting 20
 Custom fields, in Address Book 68
 Customizing. *See* Preferences
 Cutting text 44
 Cycling through views 63, 78

D

Data entry. *See* Entering data

Date
 displaying in Clock 75
 setting current 20, 177
 To Do List record due 120

Date and Time preferences 19

Date Book
 adding Address Book data to
 records 50–51
 Agenda view 88
 alarm 82
 archive files (.dba) 34
 changing event time 81
 changing event to untimed 81
 conduit for synchronizing 125
 conflicting events 89
 continuous events 83–85
 creating records 43, 78–81
 Day view 85
 deleting records 45
 display options 90
 displaying current time 85
 end time for Day view 90
 fonts 55
 menus 89
 Month view 87
 notes for records 54–55
 opening 77
 overview 77
 private records 116
 purging records 45–46
 repeating events 45, 83–85
 scheduling events 78–81
 selecting dates 80
 start time for Day view 90
 Sunday or Monday to start week 148
 switching views 85
 untimed events 78, 80
 Week view 85, 148, 177

Day
 displaying in Clock 75
 in Date Book view 78, 90
 DBA (Date Book archive file) 34
 Decimal point 148
 Default
 categories 46
 currency in Expense 95
 settings. *See* Preferences
 Deleted data, saving in archive files 45
 Deleting
 applications 57, 60
 Desktop software 61
 Graffiti characters 25
 passwords 110
 records 45
 service templates 161
 text 44
 See also Purging records
 Desktop software
 displaying euro 97
 for entering data 18
 linking to external files 139
 removing 61
 saving deleted data to an archive file 45
 system requirements 5
 upgrading 6
 Digitizer 15, 147, 176
 DNS (Domain Naming System) 158
 Double-booked events 89
 Dragging
 stylus to activate features 145
 using the stylus 16

E

Editing records 43–44

Entering data 16–19, 23–36
 importing from other applications 34–36
 problems with 176
 using Graffiti writing 24
 using Note Pad 31
 using the computer keyboard 34
 using the onscreen keyboard 23

Entries. *See* Address Book

Euro
 displaying on desktop computer 97
 in Expense 94, 95
 in Graffiti writing 29

- in onscreen keyboard 17
- printing 97
- problems with 177

Events. *See* Date Book

Exclamation marks in To Do List 121

Expense

- adding Address Book data to records 52–53
- categorizing records 47
- conduit for synchronizing 125
- creating records 92
- currency 94
- date of item 93
- defining new currency 95
- menus 97
- overview 91
- printing reports 97
- purging records 45
- receipt details 93
- type 93, 98
- vendor 94

F

FAQ 173–183

FCC Statement 187

Files, linking to external 139

Finding

- information in applications 49–51
- phone numbers 50–51
- using the Find application 50

Fonts 55, 56, 97

Formats preferences 147

Frequently asked questions 173–183

Frozen handheld 176

G

Games 150

General preferences

- alarm sounds 150
- auto-off delay 149
- system sounds 150

Glossary. *See* Graffiti ShortCuts

Graffiti

- accented characters 29
- alphabet 24, 26
- basic concepts 24
- capital letters 27

- Command stroke 42
- defined 17
- Giraffe game for practicing 17
- how to write characters 25
- menu commands 41
- moving the cursor 30
- numbers 27
- online Help 44, 144
- problems using 176
- punctuation marks 28
- ShortCuts for entering data 30, 164–165
- symbols 29
- tips 25
- writing 24
- writing area 10, 24

H

Hard reset 169, 175

Help

- Graffiti 44
- online tips 15

Hiding records 114

HotSync

- conduits for synchronizing
 - applications 125–126, 170, 171
- conduits for synchronizing applications, Mac 126–127
- customizing 125, 126
- first-time operation 127–132, 140–142
- IR operation 132
- linking to external files 139
- local operation 128, 178, 179
- local operation on Mac 131
- modem settings 136
- operations using cable 139, 146
- operations using IR port 133–134, 146–147
- problems with 178–181
- problems with IR 180
- remote operation 135–139, 179–180
- restoring data 170–171
- setting options 123–124
- using with another PIM 61

I

Icons

- alarm 82
- application 13, 39
- note 55
- online Tips 15
- onscreen 176
- repeating event 84

Idle timeout of ISP or server connection 157

Importing data 19, 34–36

Infrared

- connections 146
- HotSync operations 133–134, 146–147
- port 12, 132
- problems with IR HotSync
 - operations 180
- requirements for computer 132

Initialization string 147

Installing

- applications 57
- conduit to install applications 125

International characters

- Graffiti writing 29
- onscreen keyboard 23

IP address 157, 159

IR port 12, 132

See also Beaming *and* Infrared

IR to phone HotSync operations 135–139, 179–180

IR. *See* Infrared

IrCOMM 132, 146

IrDA (Infrared Data Association) 132

Items. *See* To Do List or Expense

K

Keyboard

- computer 34
- onscreen 14, 23, 145

L

Letters

- font style 56
- Graffiti 24, 26
- onscreen keyboard 23

List, in Applications Launcher 39

Lithium-ion battery 168

Locking the handheld with a password 111–113, 145, 163

Login scripts 159, 185

Looking up Address Book data

- to add to other records 50–51
- scrolling in Address list 51

Lost

- handheld, contact for 65
- records 177

Lotus Organizer, importing data from 34

M

Maintenance information 167

Masking records 114

Memo Pad

- adding Address Book data to
 - records 50–51
- archive files (.mpa) 34
- categorizing records 46
- conduit for synchronizing 125
- creating records 43, 99
- deleting records 45, 84
- fonts 55
- menus 71, 101
- opening 99, 103
- overview 99
- private records 116
- reviewing memos 100
- sending memos into other
 - applications 99
- sorting records 53, 177

Memory

- amount of free 183
- for beaming 182
- calculator 70
- regaining 45, 175

Memos. *See* Memo Pad

Menus 40–42, 176

- Address Book 67
- choosing 41
- command equivalents (Graffiti
 - writing) 41
- command toolbar 42
- Date Book 75, 89
- Edit menu 44
- Expense 97
- Memo Pad 71, 101, 106
- menu bar 13, 41

- Network Preferences 162
- Note Pad 106
- To Do List 121
- Microsoft Outlook, connecting to 13, 178
- Modem initialization string 147
- Monday, to start week 148
- Month (Date Book view) 87, 90
- Moving the cursor (Graffiti writing) 30
- MPA (Memo Pad archive file) 34

N

- Network
 - connecting 156
 - connection type 157
 - idle timeout 157
 - login scripts 159–161
 - password 152
 - phone settings 153
 - preferences 150–163
 - primary DNS 158
 - secondary DNS 158
 - selecting connection 152
 - selecting service 151
 - TCP/IP 150
 - user name 151
- Note Pad
 - alarm 105
 - clearing notes 44, 105
 - conduit for synchronizing 125
 - copying notes into other applications 103
 - entering data 31
 - menus 106
 - opening 31, 103
 - overview 103
 - private records 116
 - reviewing notes 104
- Notes, attaching to records 54–55
- Numbers
 - decimal point and thousands separator 148
 - Graffiti writing 27
 - onscreen keyboard 14, 23

O

- Onscreen keyboard 16, 23, 44
- Opening
 - Address Book 63
 - applications 37
 - Calculator 69
 - Clock 73, 74
 - Date Book 77
 - Expense 91
 - Memo Pad 99, 103
 - Note Pad 31, 103
 - onscreen keyboard 145
 - Security 109
 - To Do List 117
- Organizer (Lotus PIM) 34
- Outlook, connecting to 13, 178
- Overlapping events 89
- Owner preferences 163

P

- Passwords 109–113
 - changing 110
 - creating 109
 - deleting 110
 - for network 152
 - forgotten 113, 182
- Pasting
 - notes into other applications 103
 - text 44
- Payment, Expense item 94
- Pen stroke, full-screen 144–145
- Personal information managers. *See* PIM
- Phone
 - Phone Lookup 50–51
 - selecting phone numbers for Address list 66
 - selecting types of phone numbers 65
 - settings for ISP or dial-in server 153–155
- Pick lists 14
- PIM (personal information manager)
 - using HotSync Manager with 61
 - using with handheld 13
 - See also* Desktop software
- Ports, IR on handheld 132
- Power button 10
- PPP 157
- PQA (query application file extension) 58
- PRC (application file extension) 58

- Preferences 19
 - applications 42
 - Buttons 144
 - Connection 150
 - Date and Time 19
 - Digitizer 147
 - Formats 147
 - General 148
 - Network 150–163
 - On while charging setting 149
 - Owner 163
 - ShortCuts 164
 - Primary DNS 158
 - Prioritizing To Do List records 118, 121
 - Private records
 - displaying and creating 114–116, 177
 - lost with forgotten password 113
 - See also* Security
 - Profiles 140
 - Punctuation marks
 - Graffiti writing 28
 - onscreen keyboard 23
 - Purging
 - records 45–46
 - See also* Deleting
- R**
- Range of times in Day view 90
 - Receipts, recording in Expense 93
 - Receiving data. *See* Beaming information
 - Recharging the handheld 3, 149, 168
 - Records
 - Address Book 64
 - beaming 32–33
 - choosing categories 46
 - creating 43
 - Date Book 78
 - defined 43
 - deleting 45, 84
 - displaying a category of 47
 - editing 43–44
 - Expense 92
 - fonts 55
 - hiding private 109, 114
 - lost 177
 - masking private 109, 114
 - Memo Pad 99
 - notes for 54–55
 - number of 183
 - private 114–116
 - purging 45–46
 - sorting 53–54
 - To Do List 117
 - unmasking individual 115
 - Reminder lists 56
 - Remote HotSync operations 179–180
 - Removing
 - applications 60
 - Desktop software 61
 - Renaming categories 49
 - Repeating events
 - deleting from Date Book 45
 - scheduling 83
 - Rescheduling events 81
 - Resetting handheld
 - hard reset 169, 175
 - location of reset button 11, 168
 - soft reset 168
 - Restoring data
 - from a Mac 171
 - from a Windows computer 170
- S**
- Saving data 38, 43, 45
 - Scheduling events 78–81
 - Screen
 - blank 175
 - calibrating 15, 147
 - caring for 167
 - touching with your finger 10
 - Scroll
 - bar 14
 - buttons 10
 - Searching. *See* Finding
 - Secondary DNS 158
 - Security 109–113
 - changing password 110
 - deleting password 110
 - displaying owner's name 163
 - forgotten password 113
 - private records 114–116
 - setting a password hint 110
 - unmasking individual records 115

Selecting
 date for event 80
 phone numbers in Address Book 65
 text 44

Sending data. *See* Beaming information

Service
 selecting for network 151
 templates 156, 161

Settings. *See* Preferences

ShortCuts
 backing up 125
 managing 164–165
 menu commands 41
 predefined 31
 preferences 164–165
 using 30

Soft reset 168

Sorting
 applications 38
 records 53–54, 177

Sounds. *See* Alarm *and* System sounds

Stylus
 dragging with 16
 pen stroke to activate a feature 144
 tapping with 15
 writing with 11, 23

Sunday, to start week 148

Symbols
 for currency 94
 in Graffiti writing 29

System
 conduit 125
 requirements for Desktop software 5
 sounds 150

T

Tab delimited files, importing data from 34, 36

Tapping 15, 176

TCP/IP 143, 150, 162

TDA (To Do List archive file) 34

Technical Support 173, 183

Text
 copying 44
 cutting 44
 entry. *See* Entering data
 files, importing data from 34, 35

 fonts for 55
 selecting all 44

Thousands separator 148

Time
 alarm setting 82
 format 148
 setting current 20
 setting event 78
 start and end for Date Book Day view 90

Tips, online 15

To Do List
 adding Address Book data to
 records 50–51
 archive files (.tda) 34
 categorizing records 46, 121
 checking off items 119
 completed items 121
 completion date 121
 conduit for synchronizing 125
 creating records 43
 deleting records 45, 84
 due date 120–121
 fonts 55
 menus 121
 notes for records 54–55
 opening 117
 overview 117
 prioritizing records 118, 121
 private records 116
 purging records 45–46, 121
 sorting records 53

Today. *See* Current date

Transmitting data. *See* Beaming information

Troubleshooting 183

Turning off handheld
 automatically 149
 pen stroke for 145
 problems with 175

Turning on handheld
 application buttons 11
 displaying owner's name 163
 power button 10
 problems with 175

U

Undoing actions 44

Uninstalling Desktop software 61

Unresponsive handheld 176

Untimed events 78, 80, 81, 83

USB 12

 cable 168, 178

 connector 4, 12

 HotSync configuration 178, 179

 port 6, 12, 146, 178

User name

 for ISP 151

 identifying handheld 163

User profiles 140

 HotSync operation with 141–142

 Mac computer 141

V

VCal 34, 36

VCard 34, 36

Vendor for Expense item 94

W

Web sites 13

Week (Date Book view) 85–87, 148, 177

Writing area 10

Writing. *See* Entering data

Free Manuals Download Website

<http://myh66.com>

<http://usermanuals.us>

<http://www.somanuals.com>

<http://www.4manuals.cc>

<http://www.manual-lib.com>

<http://www.404manual.com>

<http://www.luxmanual.com>

<http://aubethermostatmanual.com>

Golf course search by state

<http://golfingnear.com>

Email search by domain

<http://emailbydomain.com>

Auto manuals search

<http://auto.somanuals.com>

TV manuals search

<http://tv.somanuals.com>