

## OWNER'S MANUAL

# Palsonic

61CM CORDLESS REMOTE COLOUR TELEVISION  
MODEL: 6158



Type Tested  
Electrical  
Safety

AS/NZS 3250 Lic 4165  
Standards Australia  
APP No: N16712

PALSONIC CORPORATION PTY LTD  
1 JOYNTON AVENUE  
WATERLOO NSW 2017 AUSTRALIA  
TEL:(02)9313 7111  
FAX:(02)9313 7555  
[www.palsonic.com.au](http://www.palsonic.com.au)

**PALSONIC CUSTOMER SERVICE  
TELEPHONE  
AUSTRALIA:1300 657 888**

---

---

Congratulations on your purchase of this Palsonic colour television receiver.  
We recommend that you thoroughly read this manual before use to fully enjoy the many functions and excellent effects of this receiver.  
Retain is manual in an easily accessible location for future reference.

## Contents

<b>Main features .....</b>	<b>2</b>
<b>Notes for operation .....</b>	<b>3</b>
Cautions for safety.....	3
<b>Installation and appearance .....</b>	<b>4</b>
Antenna connection .....	4
Battery installation .....	4
Appearance .....	5
The remote controller .....	6
<b>Operation .....</b>	<b>7</b>
Turning the power on/off .....	7
Menu operation .....	7
Picture menu .....	8
Preset menu .....	8
Function menu .....	10
Channel selection .....	11
Picture and volume adjustment .....	12
Picture mode selection .....	13
Other functions .....	13
<b>External equipment connections .....</b>	<b>16</b>
<b>Trouble shooting .....</b>	<b>18</b>
<b>Specifications .....</b>	<b>19</b>

---

---

## **Main features**

- **Hyperband.**
- **Auto/manual search.**
- **100 preset channels.**
- **Multi-system: PAL-B/G, NTSC-4.43/3.58 (AV).**
- **No-signal blue background display and AUTO-POWER-OFF function.**
- **Four picture mode settings.**
- **Sound mute function.**
- **Sleep timer.**
- **AV IN/OUT, S-VHS operation function.**

---

---

## NOTES FOR OPERATION

- \* Do not let the TV set be in standby condition for a long period of time. When it is not in use, please turn off the power supply and remove the power plug. When it is to be left for a prolonged period of time, it is recommended to disconnect the connection to the outdoor aerial, to avoid thunder strike.
- \* Please follow cautions for safety in the TV set instructions, and all warnings and descriptions denoted on the TV set.

### ■ Cautions For Safety

Note: This TV set can be operated on an AC power of 240V, 50Hz. You should not use power supply of the other type.

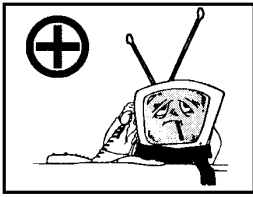

When an unusual situation occurs, turn off the power switch at once and remove the plug from the wall outlet. Contact a qualified service department in your local area.

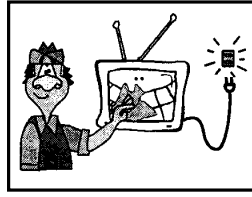

In order to wipe dust off the picture tube or off the cabinet, you should remove the power plug from the wall outlet first. You can wipe lightly with a piece of dry, clean, soft cloth.

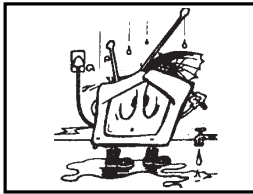

Do not expose the TV set to rain or excessive moisture, to prevent fire disaster or electric shock. Avoid using the set in very warm or damp places. Never use it in a bathroom.

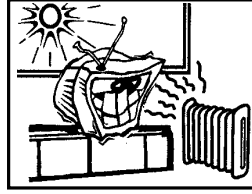

The TV set should be placed on an adequate place without exposing it to direct sunlight and other sources of heat to prevent the deformation of the cabinet or damage to components.

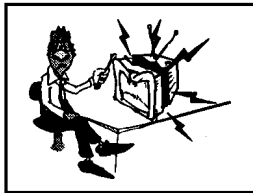

There exists High Voltage in this TV set. Do not remove the cover to avoid danger.

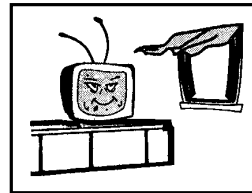

Do not cover the ventilating holes in the cabinet. Keep a space of more than 5 cm from the walls to the TV set, to guarantee the good ventilation.

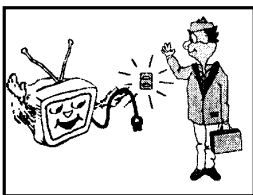

When the TV set is to be left unattended, please turn off the power switch and remove the plug from the wall outlet.

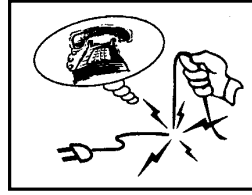

When the power cord or the plug is damaged, please contact a qualified service department to get service.

---

---

## Installation and appearance

### ■ Antenna connection

To ensure a bright - coloured and clear picture, you should use an outdoor aerial or CATV cable. If the signals are strong enough, you may use an indoor aerial.

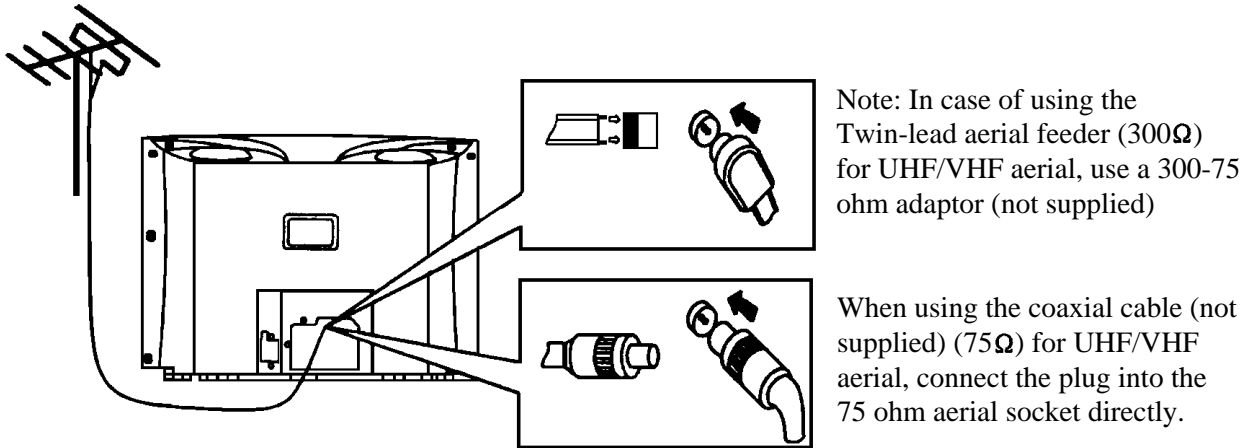

#### Note:

When you connect the outdoor aerial cable to the aerial terminal on the TV set, please turn off the power switch on the TV while connecting the antenna lead.

In thunder and lightning, weather, please disconnect the connection to the outdoor aerial to avoid thunder/lightning strike.

### ■ Battery Installation:

- 1) Remove the back battery cover.

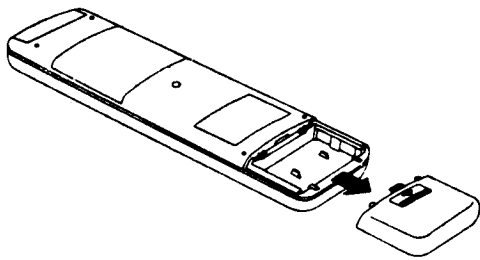

- 2) Insert two size AAA batteries according to the polarity indication inside the remote controller.

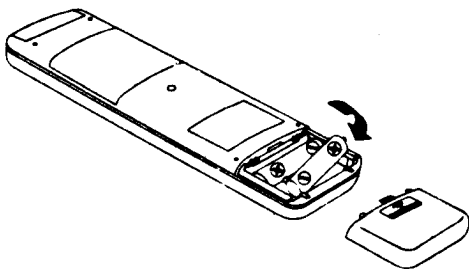

### Effective range of the remote control operation

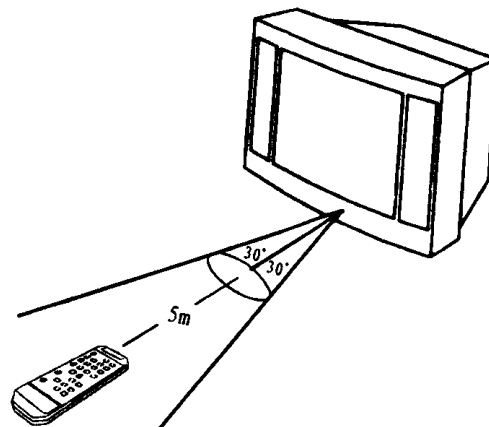

1. When the remote controller is not used for an extended period of time or the batteries are worn out, please remove the batteries in time to avoid battery leakage.
2. Avoid moisture and mechanical shock to the remote controller.

## ■ Appearance

### Front view

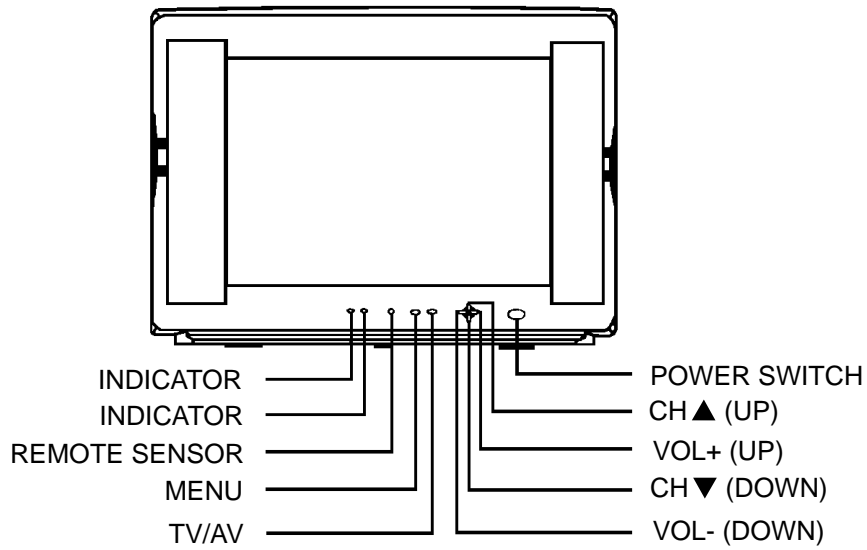

### Back view

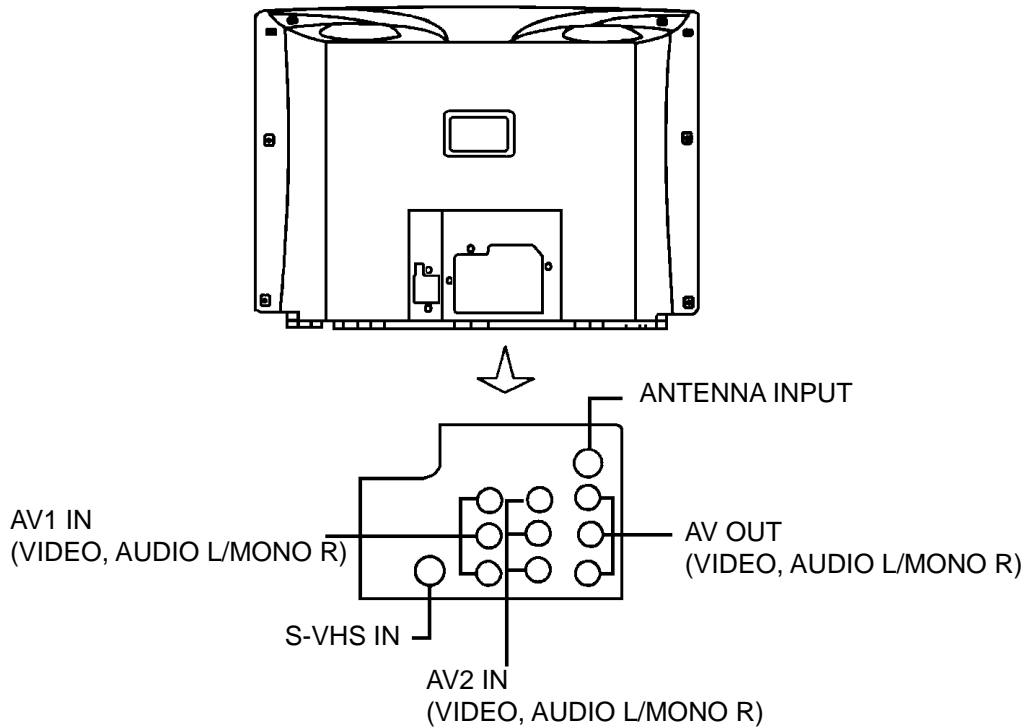

## The remote controller

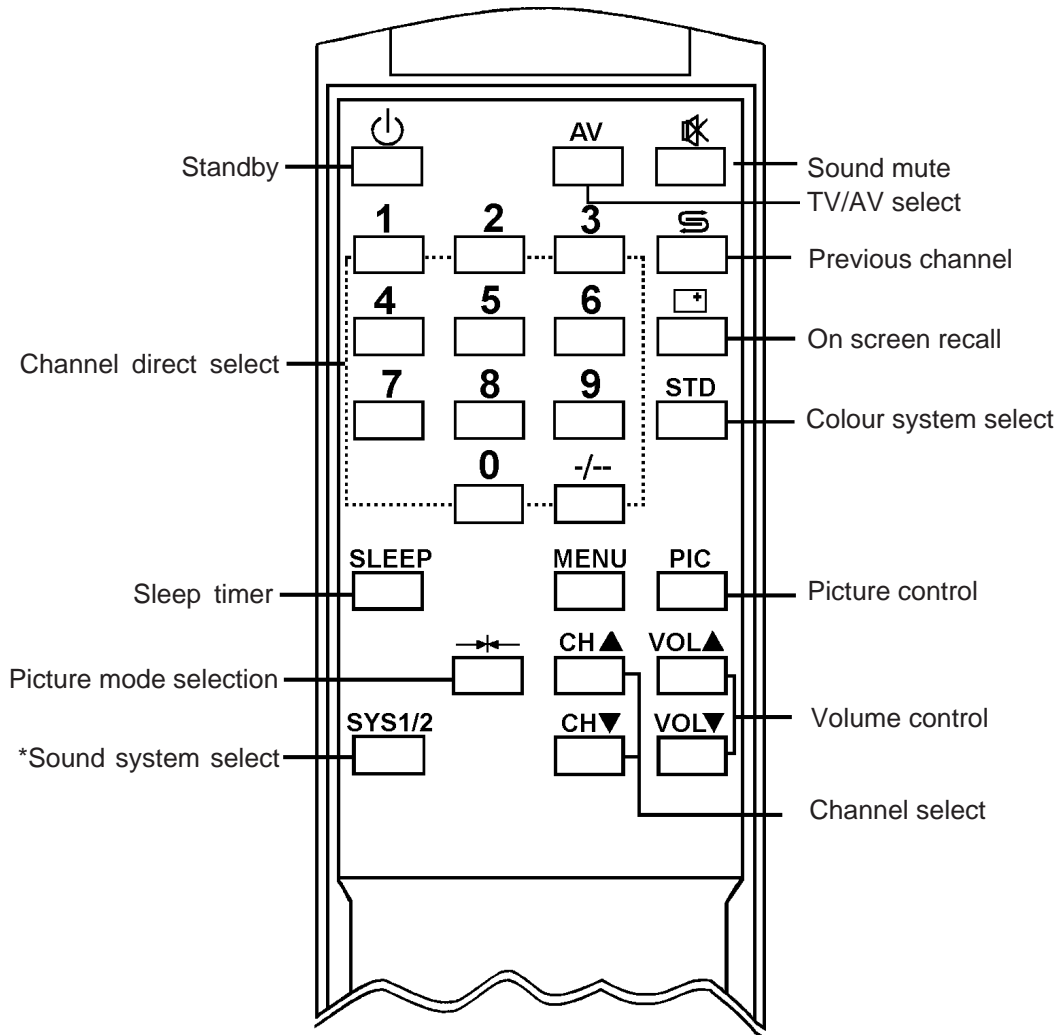

\* NOTE: this TV model's RF sound system is BG only. Therefore the **SYS1/2** button on the remote controller is ineffective in sound system selection. Similarly in the **Preset** and **Function** menus the **SYS** item (sound system selection item) is ineffective.

---

---

## Operation

### ■ Turning the power on/off

1. Connect the power, push the main power switch, the red indicator is on, the set is in standby mode.
2. Push the **⏻** button on the remote controller to turn on the set when the set is in standby, this time, the green indicator is on, on the upper right corner of the screen will display channel number, colour and sound system. Or you can push the **CH ▲/▼** button to turn on the set when in standby.
3. You can push the **⏻** button to switch the set to standby mode when in operation mode, this time the green indicator is off, the red indicator is on.
4. Push the main power switch to turn off the set completely and confirm that all indicators go out.

Note: If there are no input signals for the TV when the set is in TV receiving mode, a blue background will appear on the screen. After 5 minutes if there are still no signals to the TV, it will enter into standby mode automatically and the green indicator goes out. (Unless you have set BLUE OFF in the function menu.)

\* In VIDEO mode, when no signals input, blue background will not appear and AUTO-POWER-OFF function will be ineffective.

### ■ Menu operation

You can select adjustment items by making use of the menu. Press the **MENU** button to display the main menu:

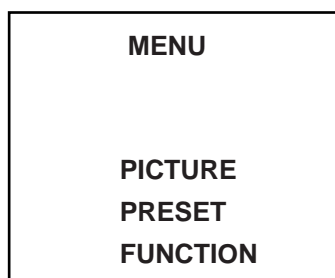

Press the **CH ▲/▼** button to select items upward or downward (the selected item is highlighted in red, while others in green). The item sequence is:



Press the **VOL ▲/▼** button to enter into the sub-menu. To exit the menu press the **MENU** button.

Note: the menu displayed on the screen will disappear automatically in 10 seconds if not in operation.



## 1. PICTURE menu

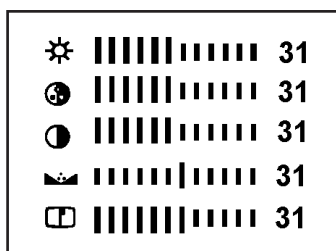

Making use of the PICTURE menu can adjust the picture effect according to your personal preference and it will be stored as picture memory mode automatically.

Press the **CH ▲/▼** button to select the item (the selected item is highlighted in red). Press the **VOL ▲/▼** button to adjust it. The range is 0-63.

Press the MENU button to exit to the main menu.

Below are the characteristics of the picture adjustment item.

Item	OSD		
	Pressing	<b>VOL ▼</b>	<b>VOL ▲</b>
(BRIGHTNESS)		Darker	Brighter
(COLOUR)		Lighter	Stronger
(CONTRAST)		Weaker	Stronger
(TINT)		Purplish	Greenish
(SHARPNESS)		Weaker	Stronger

### Note:

- \* TINT is effective only in NTSC system.
- \* When the receiving TV signals are weaker, please adjust the sharpness to lower level to reduce the noise.
- \* When the receiving TV signals are stronger, please adjust the sharpness to higher level to obtain clearer picture.

## 2. PRESET menu

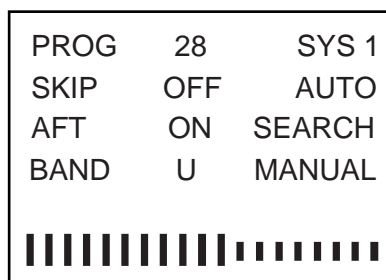

---

---

Making use of the **PRESET** menu can fulfil the function of auto-search, search. manual search , channel and band selection. AFT and skip on/off.

Press **CH ▲/▼** button to select the item. (the selected item is highlighted in red). Press the **MENU** button to exit to the main menu.

### 1) PROG (program)

Select the current program number while "**PROG**" is highlighted. Press **VOL ▲/▼** button to increase or decrease the program number progressively.

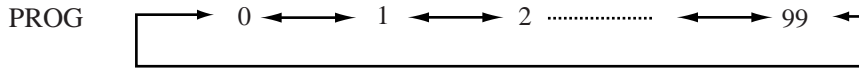

### 2) SKIP-ON/OFF

Press **CH ▲/▼** button to highlight **SKIP ON/OFF**. Press **VOL ▲/▼** button to toggle between **SKIP ON** and **OFF**. When "**SKIP ON**" is set, the current channel program will be skipped. Making use of this function can skip some unwanted channel, say 5, 11, next when you press **CH ▲/▼** button to select channel, 5, 11 channel will be skipped.

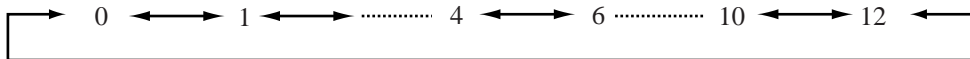

\* Press the channel direct select button can select the skipped channel.

### 3) AFT ON/OFF

Making use of the **AFT** function can automatically fine tune the channel.

Select and highlight **AFT**, pressing **VOL ▲/▼** button it toggles between **ON** and **OFF**. When in **AFT ON**, it can automatically fine tune the channel. In normal circumstances, please set **AFT ON**.

When in the process of manual search, **AFT** is set "**OFF**" automatically.

### 4) Band Selection

Press the **CH ▲/▼** button to highlight **BAND**. Press the **VOL ▲/▼** button to select band. The change sequence is

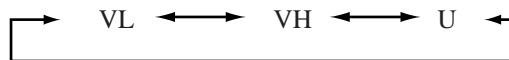

### 5) SYS ( sound system )

This item is used to select sound system. Since this TV model's RF sound system is B/G only, this item gets into ineffectiveness in sound system selection.

---

---

## 6) Auto - search (AUTO)

Press **CH ▲/▼** button to highlight **AUTO**. Press **VOL ▲/▼** button the set will automatically search and store the active TV signals in your local area from lower band to higher band in the sequence of VL→VH→U with the green bar moving rightward. When a station is located, the set will store the signals with a channel number from 0. When all the signals are searched and stored, the TV returns to 0 channel automatically, auto-search is finished.

\* After auto-search, all programs colour system is set to AUTO and in AFT-ON mode.

\* During the process of auto-search, if **⏻**, **MENU** or **CH ▲/▼** button is pressed, the searching is interrupted. Press **VOL ▲/▼** button the searching begins again.

## 7) SEARCH

Making use of SEARCH function will store a TV program at a referred channel position.

Select a channel number, when **SEARCH** is highlighted, press **VOL ▲/▼** button, the set begins to search for signals upward or downward from current channel. When a station is located, the searching stops and the program is stored into the referred channel position.

Repeat the above step and store another program signals into another position. If two channels are same, the previous will be deleted.

When the searching is finished, to store the program signals you should press the **MENU** button to exit the menu and the program signals are stored automatically.

\* When the tuning changing reaches the highest (lowest), the searching turns to next band's lowest (highest) and continues searching. If the signals are not the signals you desire, you can press the **VOL ▲/▼** button again until the desired signals are searched.

## 8) Manual search (MANUAL)

When some program's picture or sound is not good, you can make use of this function to fine tune the tuning voltage.

Press **VOL ▲/▼** button to highlight **MANUAL**. Press **VOL ▲/▼** successively, the set begins searching upward or downward. When the picture has obtained the optimum effect, release the button.

To store the effect you should press the **MENU** button to exit the menu and the effect is stored automatically.

## 3. FUNCTION menu

STD	AUTO
SYS	1
BLUE	ON

Making use of the **FUNCTION** menu can select BLUE ON/OFF and current channel's colour and sound system.

---

---

Press **CH ▲/▼** button to select item (the selected item is highlighted). Press **MENU** button to exit to the main menu.

### 1) STD (colour system) selection.

In this TV model the colour system is automatically identified. In normal circumstances, please set colour system to **AUTO**.

### 2) SYS (sound system) selection.

In this TV model this item is ineffective. (Refer to the **NOTE** on page 6)

### 3) BLUE ON/OFF selection.

Select and highlight **BLUE ON/OFF**. Press **VOL ▲/▼** button to select ON or OFF. When "**BLUE ON**" is selected, blue background will appear on the screen automatically when no input signals, and the sound is mute. After 5 minutes the set will cut off automatically.

## ■ Channel selection

### 1. Using direct select buttons

#### 1) Single digital method ( 0~9 ).

You can select any one of 0~9 channel position directly by pressing the number button accordingly.

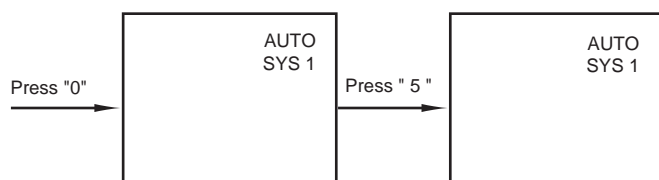

#### 2) Two digit method (10~99).

Press "-/-" button until the symbol "--" is displayed on the screen. In this mode you can choose any one of two digit channel by pressing the number buttons accordingly. For example, if you wish to receive channel 25, press "2" button, then press "5" button.

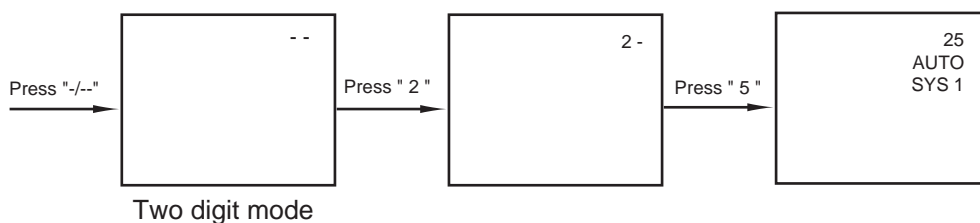

### 2. Using CH ▲/▼ button

Press **CH ▲/▼** button, the channel number will be increased or decreased progressively.

### 3. Making use of **↔** button

Press **↔** button to swap the currently viewed channel with the previous channel.

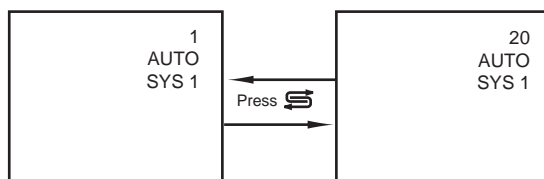

## Picture and volume adjustment

### 1. Picture adjustment

Press **PIC** button repeatedly, on-screen display will change in the sequence below

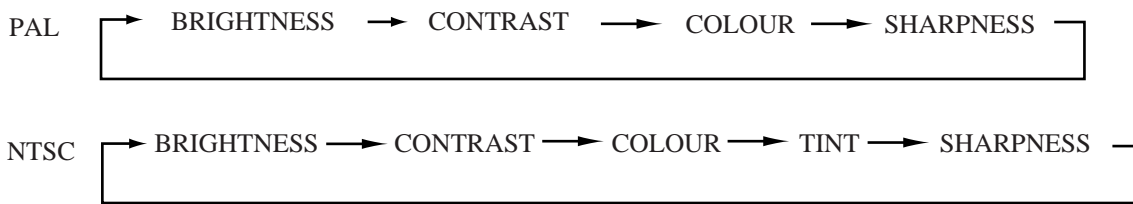

Press **VOL ▲/▼** button to adjust the level. For example, to adjust brightness:

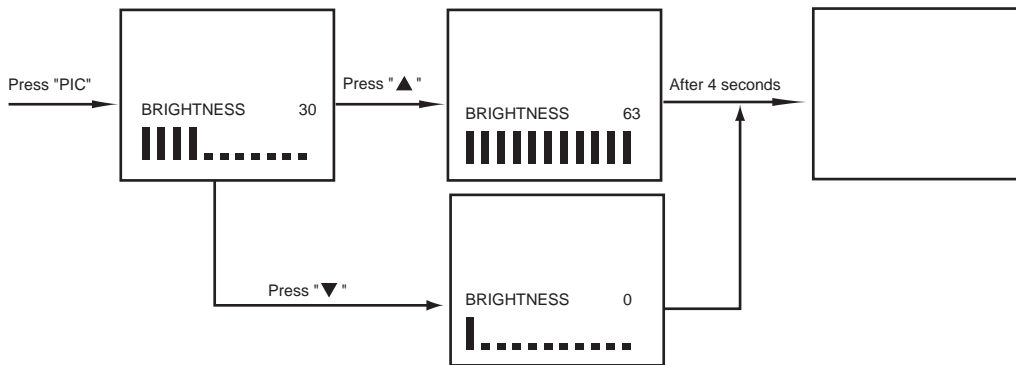

(Note: this button's function is as same as the function of the **PICTURE** menu of the main menu, refer to **PICTURE MENU** on page 8.)

### 2. Volume adjustment

You can press the **VOL ▲/▼** button to adjust the volume, and the green bar will move rightward or leftward, the volume output range is 0-63.

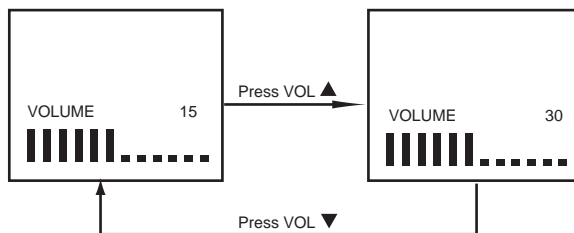

You can press the **MUTE** button to mute the sound. Press the **MUTE** button again or **VOL ▲/▼** button. The sound is restored to normal.

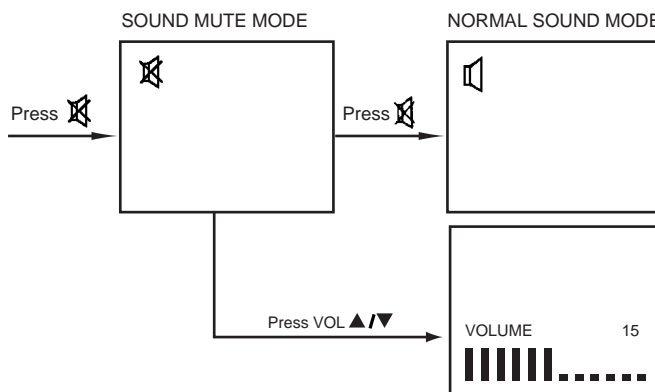

## Picture mode selection

You can select the picture quality instantly among three presets modes and one user-set mode. Press the  $\rightarrow$  button to select the desired picture quality. *DYNAMIC*, *STANDARD*, *MILD* and *MEMORY* (user-set) can be selected cyclically.

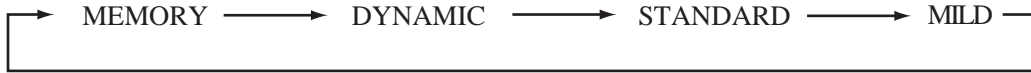

Output Item / Mode	Brightness	Colour	Contrast	Tint	Sharpness
DYNAMIC	31	31	47	31	31
STANDARD	31	31	31	31	31
MILD	31	31	21	31	31
MEMORY	The picture quality you set				

## Other functions

### 1. Retain on-screen display

Press the  $\boxed{+}$  button and the upper right corner will display the current channel number and TV system. After 4 seconds the display on the screen will disappear.

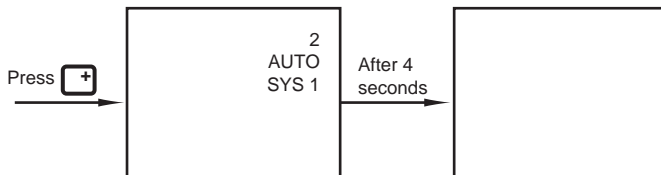

In VIDEO mode, it will only display VIDEO 1 (or VIDEO 2) and the colour system.

### 2. TV colour system selection

Press the STD button and each time the colour system displayed on the screen will change in the sequence of

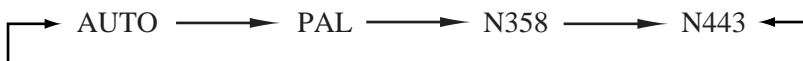

If the system is not set correctly, the picture will have no colour or the colour is abnormal. Press STD button to select the right colour system to obtain normal colour. (Refer to the following table).

	COLOR SYSTEM	COLOR SUB-CARRIER	VERTICAL FREQUENCY
AUTO	PAL(RF/VIDEO)	4.43MHz	50Hz
	NTSC 3.58 (VIDEO)	3.58MHz	60Hz
PAL	PAL(RF/VIDEO)	4.43MHz	50Hz
	PAL-60(RF/VIDEO)		60 Hz
N358	NTSC3.58 (VIDEO)	3.58MHz	60 Hz
N443	NTSC4.43(VIDEO)	4.43MHz	60 Hz

### 3. SLEEP timer

Using the SLEEP button allows you to have the appliance automatically turned off after a preset time (the time range will be as long as 120 minutes) , and set the appliance to standby mode. At every press of the button the setting time will be decreased by 30 minutes.

When the remaining time is 5 minutes left, it will be displayed once every 2 minutes for 4 seconds

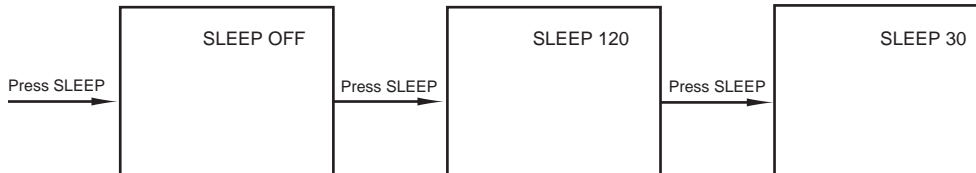

When the SLEEP timer is functioning, if you press SLEEP button again, the TV will display the remaining time. If the power is switched off, the SLEEP timer will be cancelled. You must set it again if wanted.

### 4. TV/AV selection

Press the TV/AV button on the set or AV button on the remote controller to select TV or AV mode.

When the TV is working at RF receiving mode, press AV button the set will be switched to AV1, the screen displays AV1 and colour system; Press the button again and the set will be switched to AV2, the screen displays AV2 and colour system. Press the button once more, the set will be switched to TV mode and the screen displays current TV channel.

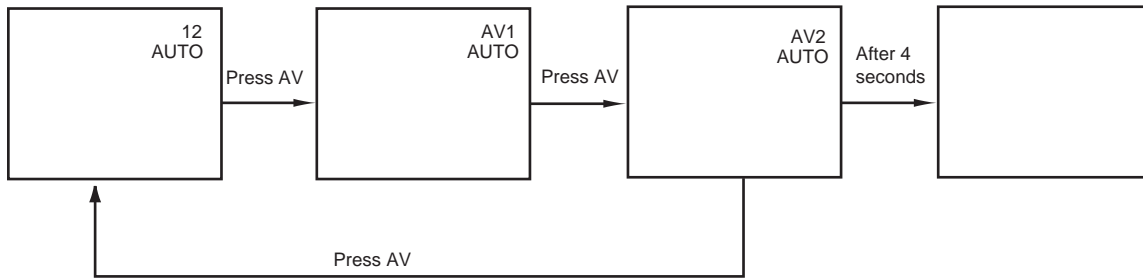

Note: S-VHS IN and AV2 use the same interface. If you want to receive signals input through S-VHS terminal, switch the set to AV2, the S-VHS (S-VIDEO) input terminal has priority over the AV2 VIDEO terminal; To use equipment connected to the AV2 VIDEO IN terminal, disconnect any plug from the S-VHS terminal. S-VHS and AV2 use the same group of AUDIO IN terminals.

- 1) When receiving broadcasting TV program (the TV signals are input through aerial terminal), press the AV button to switch the set to TV mode.
- 2) When receiving programs played back by Video DISC, VCR, Satellite receiver, VCD (the signals are input through AV terminals), please set the receiver to corresponding Video mode (AV1 or AV2).

\* In video mode, the sound system button and the PRESET menu in the main menu have no function.



---

---

## External equipment connection

This set is incorporated with Audio & Video input and output terminals which allows direct connection to external equipments (such as VCR, Video DISC, VCD, Satellite Receiver etc.) for playing back and recording the programs.

### 1. Video playback

If your video equipment has a S-VHS output terminal, connect it to the S-VHS input terminal (special S-VIDEO type) of the set and connect audio line to AV2 AUDIO IN terminal. If not, connect it to the VIDEO terminal (photo type).

1.1 According to the following figure connect the TV set to the VIDEO equipment.

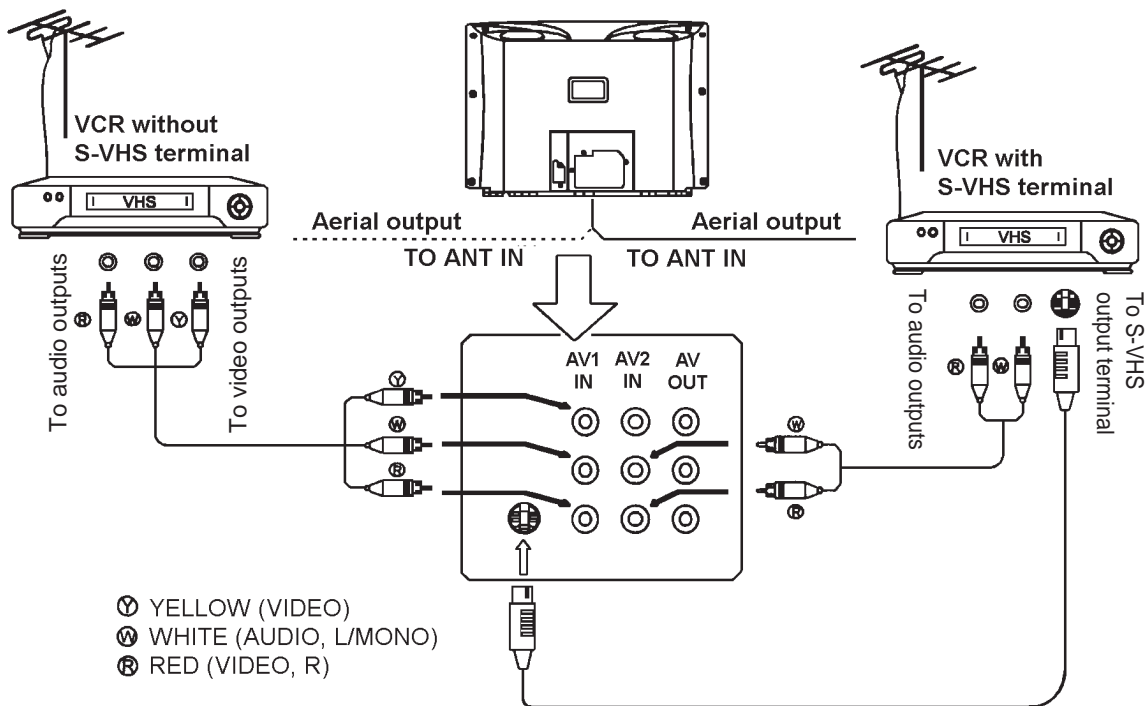

Note: The VIDEO equipment may be VCR, VCD or Satellite Receiver.

1.2 Press the "AV/TV" on the set or "AV" button on the remote controller, let the TV set work at the corresponding video mode, the screen displays "AV1" or "AV2" and corresponding colour system. The picture displayed on the screen is the program played back by the video equipment.

---

---

## 2. Recording

2.1 According to the following figure connect the TV set to the VCR.

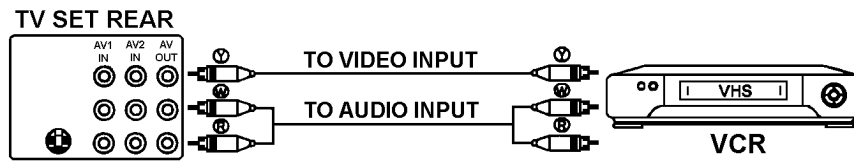

(Y) YELLOW (VIDEO)  
(W) WHITE (AUDIO, L/MONO)  
(R) (AUDIO, R)

2.2 When recording, set the TV on the desired channel, the program recorded is the program displayed on the screen.

---

---

## Troubleshooting

<b>Symptoms</b>	<b>Check the following items</b>
The set cannot be turned on, red indicator is off	<ul style="list-style-type: none"><li>• Be sure the power cord is plugged in or the AC socket is damaged.</li></ul>
Poor colour, poor tint	<ul style="list-style-type: none"><li>• Contrast, colour, tint are not correctly adjusted.</li></ul>
Spots appear on the screen	<ul style="list-style-type: none"><li>• Possible interferences of automobiles, motorcycle, trolley bus, neon lamps, etc.</li></ul>
Stripes appear on the screen	<ul style="list-style-type: none"><li>• Possible interferences of electronic interference from another TV set, a computer, electronics game machine, a broadcast station, etc.</li></ul>
Double images or "ghosts"	<ul style="list-style-type: none"><li>• This may be caused by reflections from nearby mountains or buildings.</li><li>• Check the antenna direction.</li></ul>
Snowy picture	<ul style="list-style-type: none"><li>• It is possible that the aerial "lead - in" is damaged or has come off.</li><li>• Check the antenna direction.</li></ul>
Colour or sound is abnormal	<ul style="list-style-type: none"><li>• The TV system's setting may be wrong, change the colour or sound system.</li></ul>
The remote controller does not work	<ul style="list-style-type: none"><li>• The batteries may be worn out.</li><li>• The batteries may be installed with their polarity reversed.</li></ul>
TV cabinet creaks	<ul style="list-style-type: none"><li>• Even if the picture or sound is normal, changes in the room temperature sometimes makes the TV cabinet expand or contract, making a noise. This does not indicate a malfunction.</li></ul>

---

---

## Specifications

Power supply:	AC 240V, 50Hz
Receiving channel:	VHFL 0~5, 5A; VHFH 6~11; UHF E21-E69
TV system:	PAL-B/G, PAL-60, NTSC 3.58 /4.43 (AV)
Dimension(mm):	720 (W) x 510.5 (H) x 452 (D)
Weight:	35kg
CRT:	61cm Diagonal, blackstripe picture tube
Power consumption:	120W
Antenna impedance:	75 ohm
Sound output:	4W x 2
Accessories:	one remote controller

Note : Design and specifications are subject to change without notice.

PALSONIC CORPORATION PTY LTD  
1 JOYNTON AVENUE  
WATERLOO NSW 2017 AUSTRALIA  
TEL:(02)9313 7111  
FAX:(02)9313 7555  
[www.palsonic.com.au](http://www.palsonic.com.au)

**PALSONIC CUSTOMER SERVICE  
TELEPHONE  
AUSTRALIA: 1300 657 888**

604-25703-0

## Free Manuals Download Website

<http://myh66.com>

<http://usermanuals.us>

<http://www.somanuals.com>

<http://www.4manuals.cc>

<http://www.manual-lib.com>

<http://www.404manual.com>

<http://www.luxmanual.com>

<http://aubethermostatmanual.com>

Golf course search by state

<http://golfingnear.com>

Email search by domain

<http://emailbydomain.com>

Auto manuals search

<http://auto.somanuals.com>

TV manuals search

<http://tv.somanuals.com>