

OWNER'S MANUAL

Palsonic

TFTV-151



15.1" TFT LCD Monitor TV

Palsonic Corporation Pty Ltd
1 Joynton Avenue
WATERLOO NSW 201 7 AUSTRALIA
Tel 61 2 93137111 Fax 61 293137555
www.palsonic.com.au
Customer Service - 1300 657 888

Contents

Safety Instructions	3
General safety precautions	4
Parts Description	
Front Panel	5
Rear Panel	6
Remote Control Unit	7~8
MENU TREE	9
Connecting a PC	10
Viewing a PC screen	
Initial set PC mode	11
When the picture is unstable	11
Adjusting the Picture settings	12
Adjusting the Sound settings	13
Adjusting the Geometry settings	14
PC Stable Adjustment	15
Connecting to watch TV or VCR	
Connecting the Aerial or Cable Television Network	16
Connecting the VCR, DVD or Other External Devices	16
Viewing a TV/VCR screen	
Adjusting the Picture Settings 1,2	17~18
Adjusting the Sound Settings 1,2	19~20
Channel Memory (PAL System)	
Storing the Channel Automatically	21
Storing the Channel Manually	22~23
Fine Tuning Channel Reception	24
Skipping Unwanted Channels	25
Other Functions	
Sleep	26
Recall	26
Surround	26
Appendix	
Power Saver	26
Troubleshooting	27-28
Specification	29
Display Modes	30

Congratulations on your purchase of this Palsonic Product.

We recommend that you thoroughly read this manual before use to fully enjoy the many functions and excellent features of this set.

Retain this manual in an easily accessible location for future reference.

Safety Instructions

Before connecting the AC power cord to the DC adapter outlet, make sure the voltage designation of the DC adapter corresponds to the local electrical supply.

Never insert anything metallic into the cabinet openings of the Liquid Crystal Display (LCD) monitor: doing so may create the danger of electric shock.

To avoid electric shock, never touch the inside of the LCD monitor. Only a qualified Technician should open the case of the LCD monitor.

Never use your LCD monitor if the power cord has been damaged. Do not allow anything to rest on the power cord, and keep the cord away from areas where people can trip over it.

Be sure to hold the plug, not the cord, when disconnecting the LCD monitor from an electric socket.

Openings in the LCD monitor cabinet are provided for ventilation. To prevent overheating, these openings should not be blocked or covered. Also, avoid using the LCD monitor on a bed, sofa, rug, or other soft surface. Doing so may block the ventilation openings in the bottom of the cabinet. If you put the LCD monitor in a bookcase or some other enclosed space, be sure to provide adequate ventilation. Put your LCD monitor in a location with low humidity and a minimum of dust.

Do not expose the LCD monitor to rain or use it near water (in kitchen, near swimming pool, etc.). If the LCD monitor accidentally gets wet, unplug it and contact an authorised dealer immediately. You can clean the LCD monitor with a damp cloth when necessary, but be sure to unplug the LCD monitor first.

Place the LCD monitor on a solid surface and treat it carefully. The screen is made of thin glass with a plastic front surface and be damaged if dropped, hit or scratched. Do not clean the front panel with keton-type materials (e.g., acetone), ethyl alcohol, toluene, ethylacid, methyl, or chloride - these may damage the panel.

Locate your LCD monitor near an easily accessible AC outlet.

	CAUTION RISK OF ELECTRICAL SHOCK DO NOT OPEN	
CAUTION: TO REDUCE THE RISK OF ELECTRICAL SHOCK, DO NOT REMOVE COVER (OR BACK). NO USER-SERVICEABLE PARTS INSIDE. REFER SERVICING TO QUALIFIED SERVICE PERSONNEL.		

General safety precautions

This Monitor has been engineered and manufactured to assure your safety. You can prevent serious electrical shock and other hazards by keeping in mind the following:

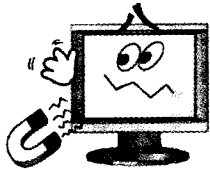

Do not place anything heavy, wet or magnetic on the monitor or the power cord. Never cover the ventilation openings with any material and never touch them with metallic or inflammable materials.



Avoid operating the monitor in extreme heat, humidity or areas affected by dust.

Temperature: 5-35°C Humidity: 30~80RH

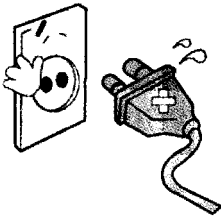

Be sure to turn the monitor off before plugging the power cord into the socket. Make sure that the power cord and the other cords are securely and correctly connected.

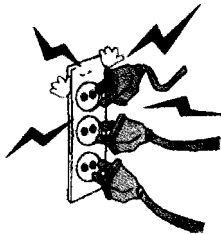

Overloaded AC outlets and extension cords are dangerous, as are frayed power cords and broken plugs, which may cause electric shock or fire. Call your service technician for replacement.

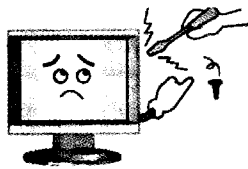

Do not use sharp tools such as a pin or a pencil near the monitor, as they may scratch the LCD surface.



Do not use a solvent, such as benzene, to clean the monitor, as it will damage the LCD surface.

Parts Description

Front Panel

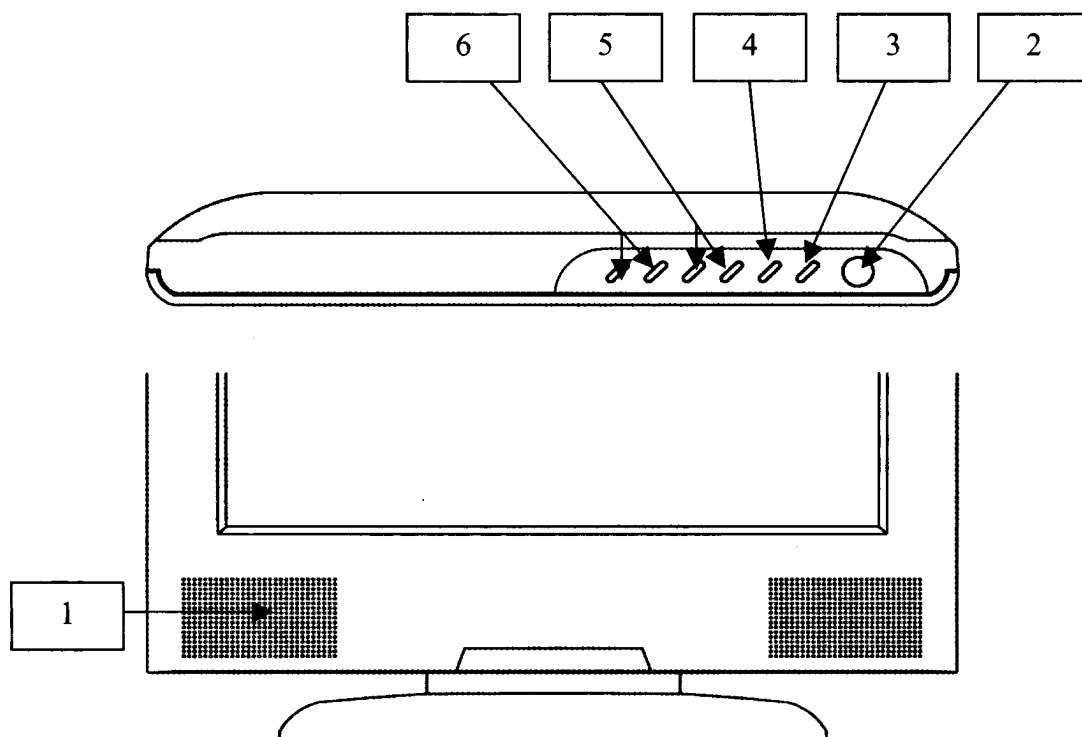

1. SPEAKER

2. POWER

switches the set off (stand-by mode) and on.

3. MENU

display the main on-screen menu. Exit from sub-menu.

4. SELECT

select input signal or select submenu of the on-screen menus.

5. Volume UP, Volume DOWN

adjust the volume. Also adjust the value of a menu option.

6. CH UP, CH DOWN

change channels. Also used to highlight selections on the on-screen menus.

Accessories

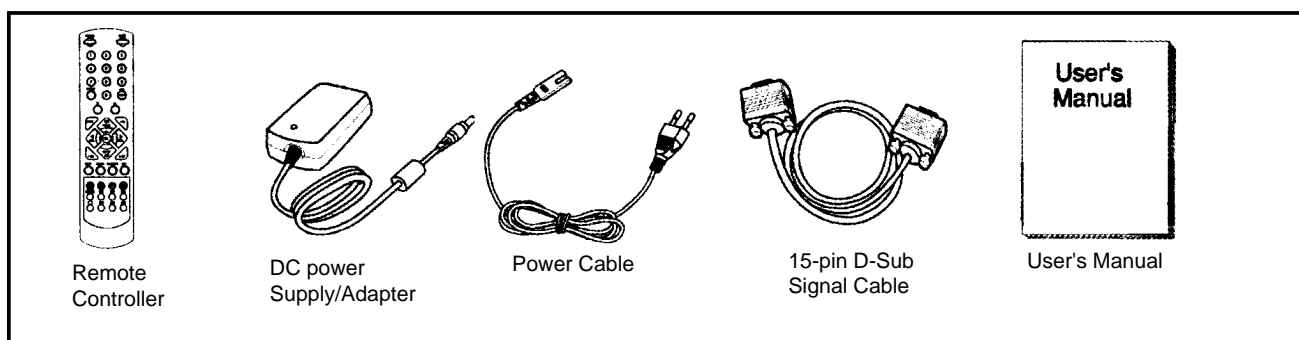

Parts Description

Rear Panel

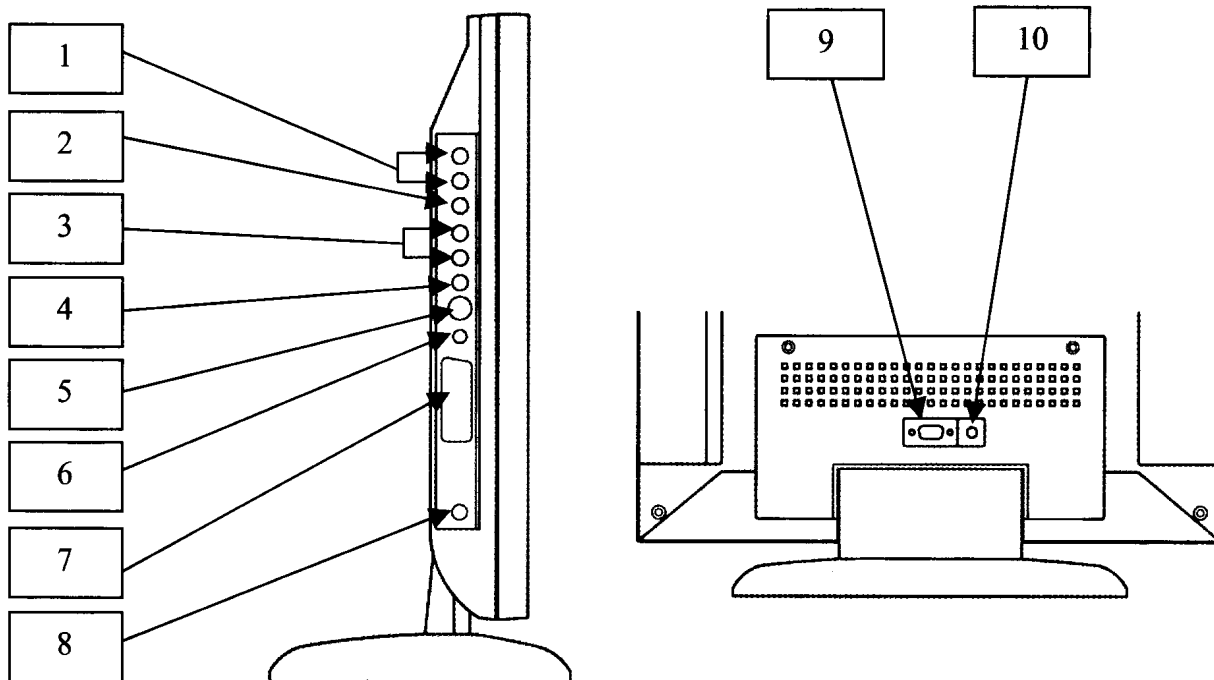

1. AUDIO OUTPUT

connects to the audio input port of an additional device.

2. VIDEO OUTPUT

3. AUDIO INPUT

audio signals from VCR or similar device.

4. VIDEO INPUT

video signals from VCR or similar device.

5. S-VIDEO IN

S-Video signal from an S-VHS VCR or laser disc player.

6. HEAD PHONE JACK

7. SCART (PAL System)

SCART audio/video connector.

8. POWER Jack

to input DC power from power outlet.

9. PC VIDEO INPUT

used to connect a video signal from a personal computer

10. PC AUDIO INPUT

connects to the sound-output port of a personal computer.

Remote Control Unit

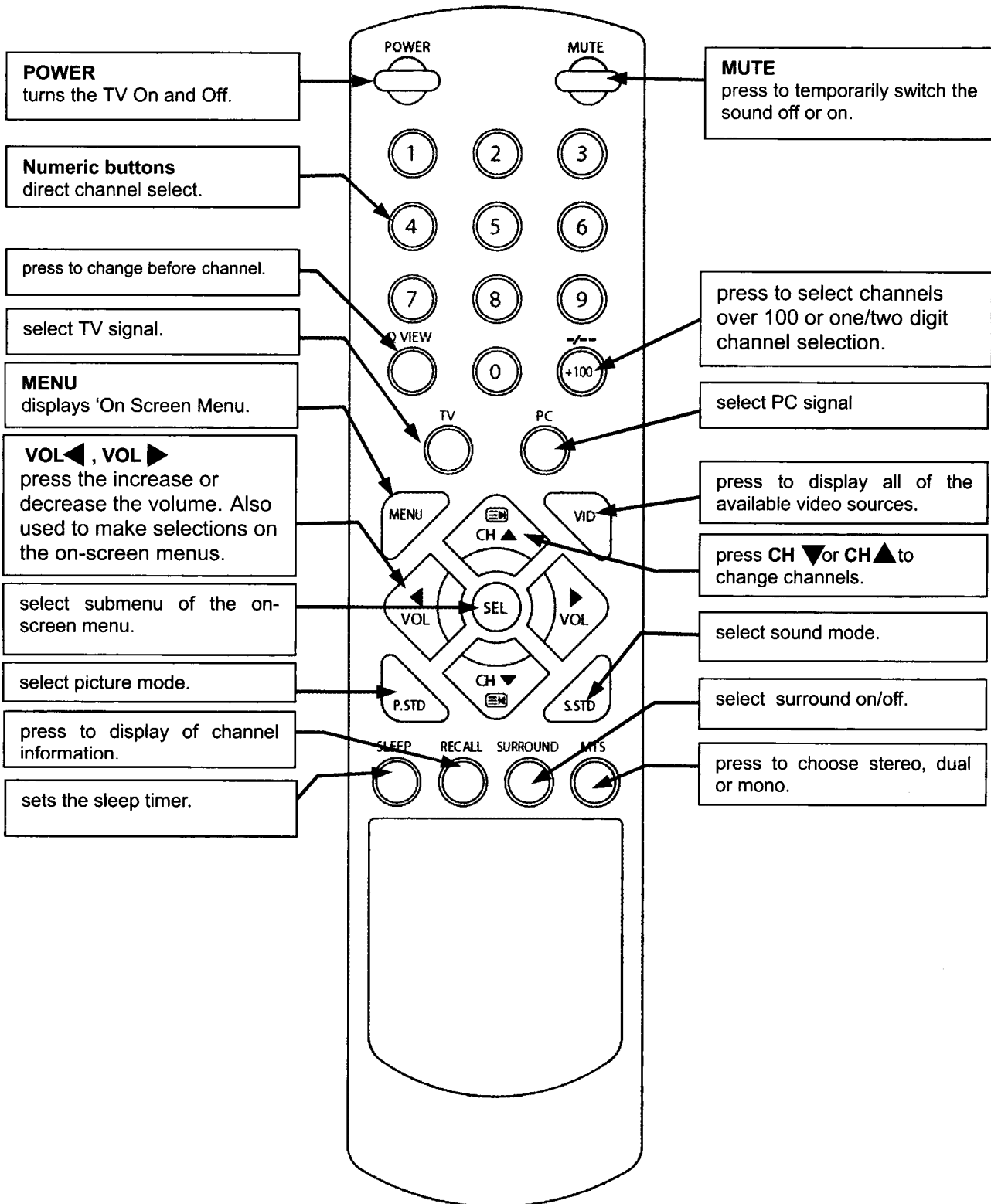

Inserting the Batteries in the Remote Controller

You must insert or replace the batteries in the remote controller when you:

- Purchase the set.
- Find that the remote controller is no longer operating correctly.

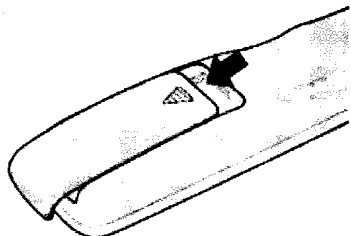

- 1 Remove the cover of the remote controller by pressing the symbol and pulling the cover space in the direction of the arrow.

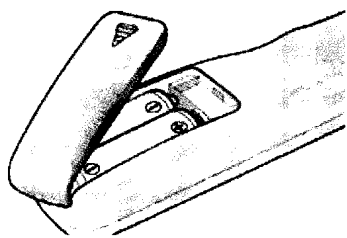

- 2 Insert 2 batteries (AAA size), Care about the polarities.

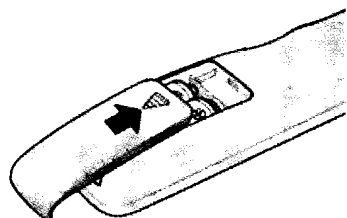

- 3 Replace the cover by pushing it in the direction of the arrow.

! You can use your remote controller within a distance of 7~10m and an angle of 30 degrees from the left and right sides of the remote controller receptor of your monitor.

CAUTION

Danger of explosion if battery is incorrectly replaced.

Replace only with the same or equivalent type recommended by the manufacturer.

Menu Tree

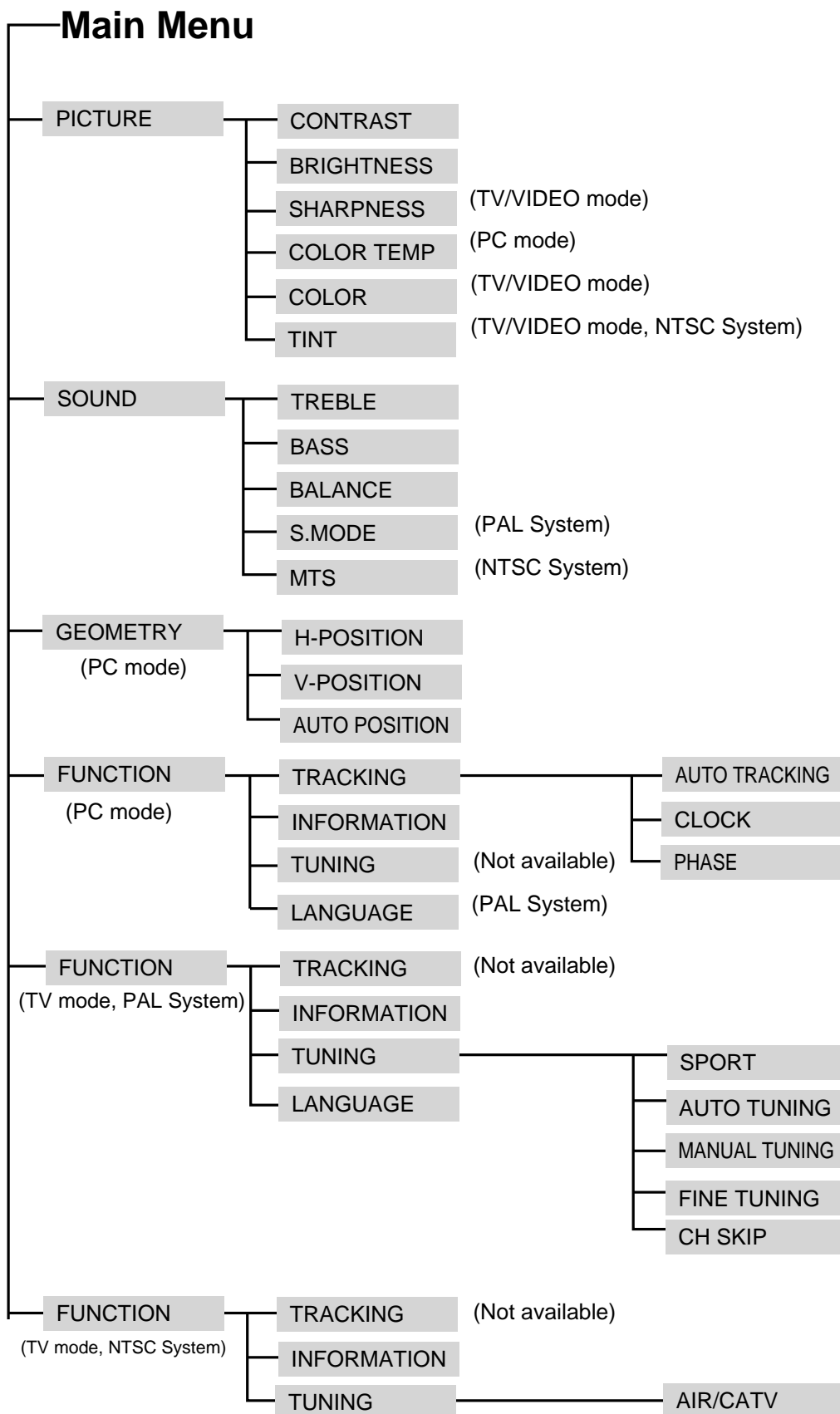

Connecting a PC

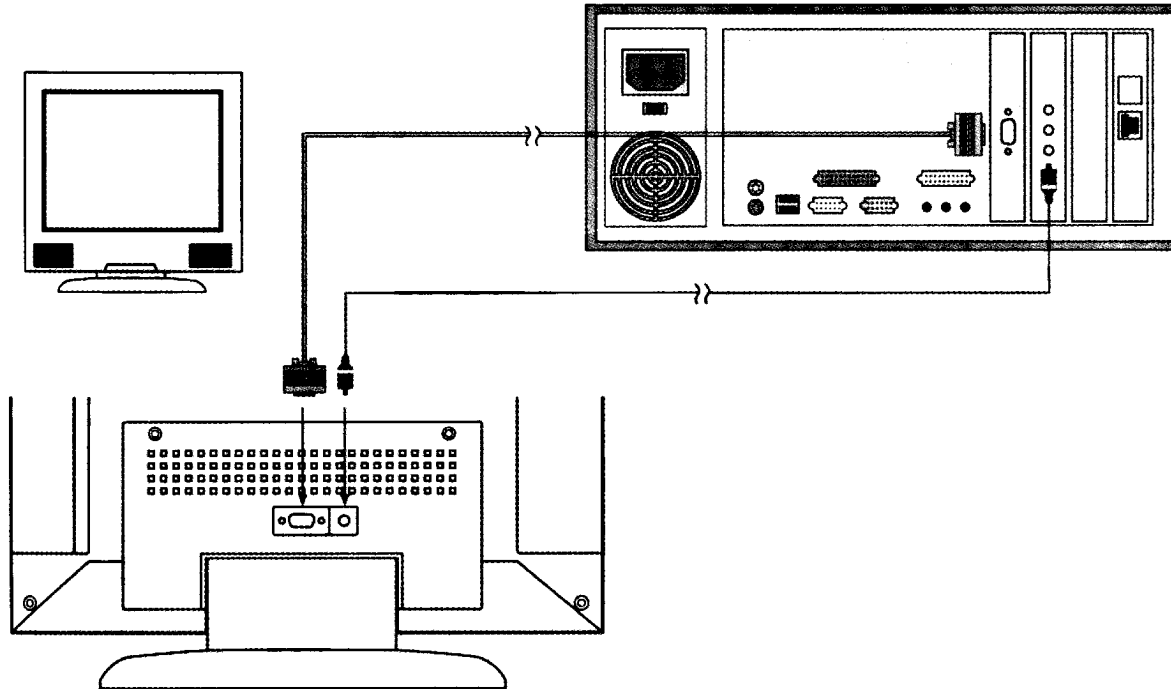

- 1** Turn off your computer and monitor.
- 2** Connect a PC D-Sub cable between your PC and PC-VIDEO-IN of the monitor. And then fasten the screws of both sides of the cable.
- 3** Connect a PC Audio Cable between the Sound Output jack of the sound card on a PC and the PC-AUDIO-IN of the monitor.
- 4** Connect a DC Power unit cable to the Power jack on the rear of your monitor. And connect a power cable to the DC Power unit before connecting to a power outlet.
- 5** Power on the computer before turning on the monitor.

Viewing a PC screen

Initial set PC mode

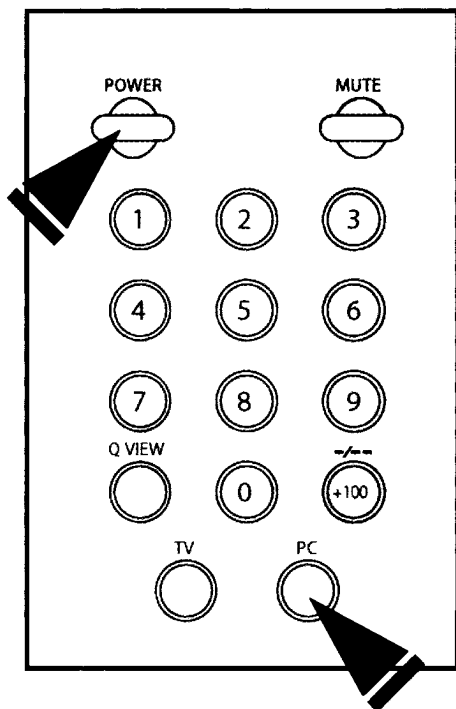

- 1 Power on your monitor by pressing the **POWER** button on the main set or on the remote controller.
- 2 Use the **PC** button on the remote controller to switch to the **PC** mode.
Then the PC screen is automatically set.
When a CD-Title runs, the music is output from speakers.
(You can use an external speaker via the Audio Output jack on the rear of the main set.)

When the picture is unstable

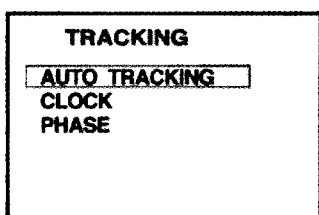
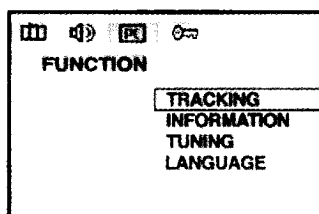

- 1 Press the **MENU** button and the **PICTURE** menu is displayed.
- 2 Use the **VOL** ◀ or **VOL** ▶ button to move to the **FUNCTION** menu.
- 3 Use the **CH** ▼ or **CH** ▲ button to move to **TRACKING**, then press the **SEL** button. Then, the **TRACKING** menu will be displayed.
- 4 Move to **AUTO TRACKING**, then press the **SELECT** button. Then, the message "**AUTO TRACKING PROCESSING ...**" appears on the screen to stabilise the screen.
- 5 Press the **MENU** button repeatedly until the menus disappear.

Viewing a PC screen

Adjusting the Picture Settings

Your monitor has several settings which allow you to control picture quality:

- **CONTRAST, BRIGHTNESS, COLOUR TEMPERATURE**

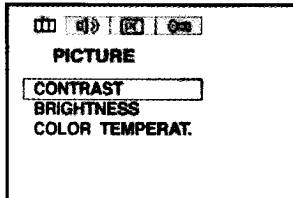

1 Press the **MENU** button.
Result : The **PICTURE** menu is displayed.

2 Use the **CH ▼** or **CH ▲** buttons to select one of the following options:
CONTRAST
BRIGHTNESS
COLOUR TEMPERATURE

3 Press the **SEL** button.

4 Press the **VOL ◀** or **VOL ▶** buttons to suit your personal preference.

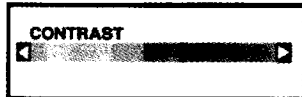

- **CONTRAST:**
Adjust the brightness and darkness between objects and back grounds.

- **BRIGHTNESS:**
Adjust the overall of the screen brighter or darker

- **COLOUR TEMPERATURE:**
The tone of colour can be changed from reddish white to bluish white.

5 Press the **MENU** button repeatedly until the menus disappear.

Viewing a PC screen

Adjusting the Sound Settings

The sound settings can be adjusted to suit your personal preference: **TREBLE**, **BASS**, **BALANCE**, **S.MODE**

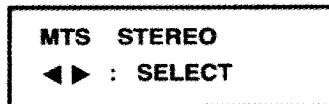
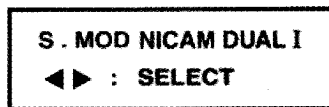
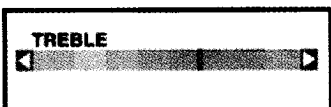
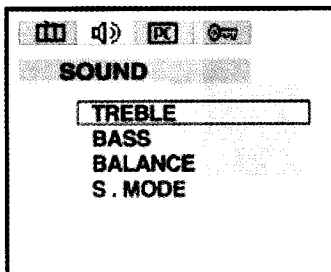

- 1** Press the **MENU** button.
Result: The **PICTURE** menu is displayed.
- 2** Use the **VOL** ◀ or **VOL** ▶ buttons to move the **SOUND** menu.
- 3** Use the **CH** ▼ or **CH** ▲ buttons to select one of the following options:
TREBLE
BASS
BALANCE
S.MODE
- 4** Press the **SEL** button.
- 5** Press the **VOL** ◀ or **VOL** ▶ buttons to suit your personal preference.
 - **S.MODE / MTS** : To select **STEREO** or **MONO**
- 6** Press the **MENU** button repeatedly until the menus disappear.

Viewing a PC screen

Adjusting the Geometry Settings

The geometry settings can be adjusted to centre your viewing screen.

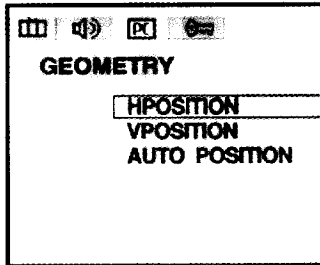

- 1 Press the **MENU** button.
Result : The **PICTURE** menu is displayed.
- 2 Use the **VOL** ◀, **VOL** ▶ buttons to move the **GEOMETRY** menu.
- 3 Use the **CH** ▼ or **CH** ▲ buttons to select one of the following options:
H-POSITION
V-POSITION
AUTO POSITION

4 Press the **SEL** button.

5 Press the **VOL** ◀ or **VOL** ▶ buttons to adjust the position of screen.

- If the position of screen is horizontally off-centred, use **H-POSITION**.
- If the position of screen is vertically off-centred, use **V-POSITION**.

Use the **AUTO POSITION** to position the screen to be **horizontally** and **vertically** centred automatically.

6 Press the **MENU** button repeatedly until the menus disappear.

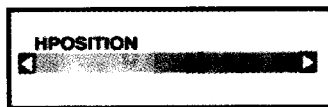

Viewing a PC screen

PC Stable Adjustment

When the screen is unstable in PC settings, or to make your PC stable by adjusting the Clock and Phase, set the PC in the following sequence:

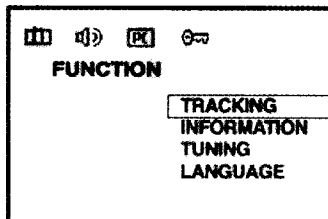

1 Press the **MENU** button.
Result : The **PICTURE** menu is displayed.

2 Use the **VOL**◀, **VOL**▶ buttons to move the **FUNCTION** menu.

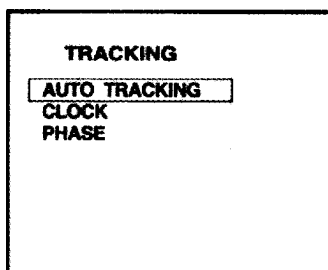

3 Use the **CH**▼ button move to **TRACKING** and then press the **SEL** button.
Result: The **TRACKING** menu is displayed.

4 Use the **CH**▼ or **CH**▲ buttons to select one of the following options:
AUTO TRACKING
CLOCK
PHASE

5 To adjust the..	Press the...
AUTO TRACKING	SEL button.
CLOCK	VOL ◀ or VOL ▶ button.
PHASE	VOL ◀ or VOL ▶ button.

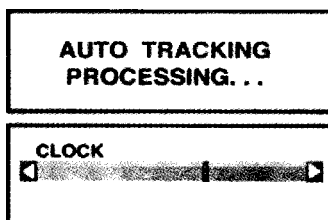

6

- **AUTO TRACKING:** Automatically optimises the status of screen.
This is recommended to perform for new PC.
- **CLOCK:** Adjusts the horizontal size of screen by increasing / decreasing the number of pixels.
- **PHASE:** Sets the focus of screen.
Adjusts when some noise exists or the character lines are seen overlapped.

7 Press the **MENU** button repeatedly until the menus disappear.

Connecting to watch TV or VCR

Connecting the Aerial or Cable Television Network

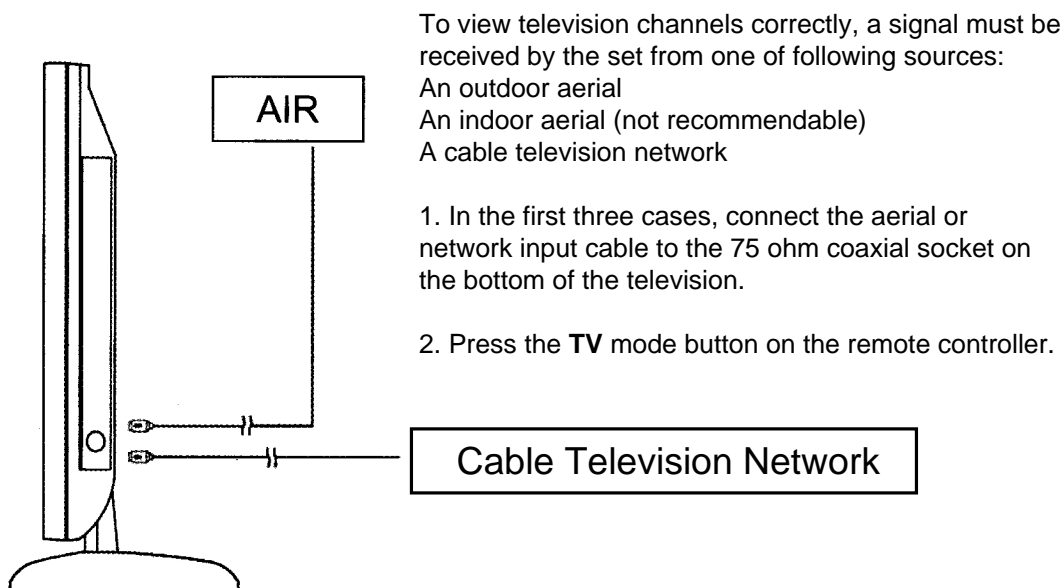

Connecting the VCR, DVD or Other External Devices

1. Connect video and audio cable according to the shape and colour of the video / audio cable. (SCART jack, RCA jacks)

- When an external devices is in **MONO**, the audio connection cable can be connected to either the left and **S.MODE/MTS** should be set **FM MONO/MONO**.

2. For optimal visual image, use **S-VIDEO** connector instead of video (yellow) connector.

- If RCA jack is connected together with SCART jack, RCA jack has priority.

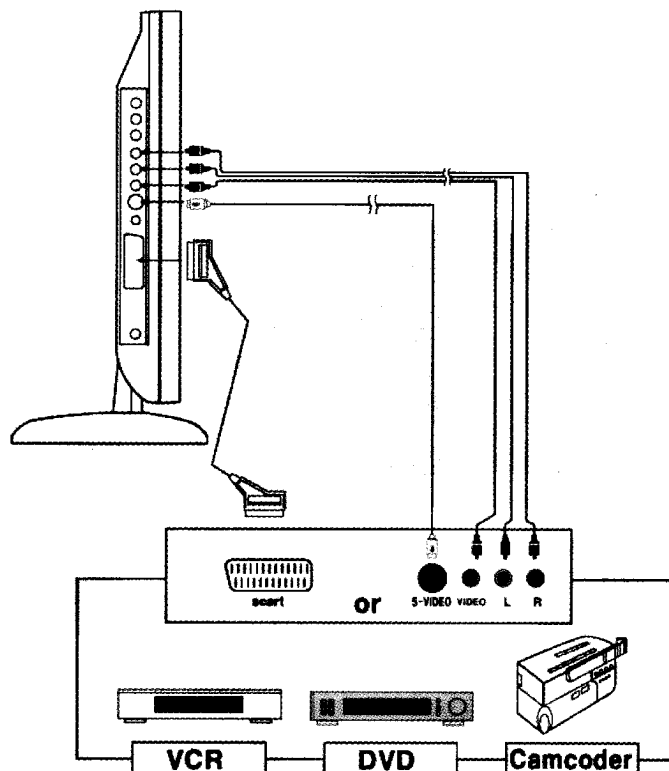

Viewing a TV/VCR screen

Adjusting the Picture Settings 1

Your TV have several settings which allow you to control picture quality:

CONTRAST, BRIGHTNESS, SHARPNESS, COLOUR, TINT

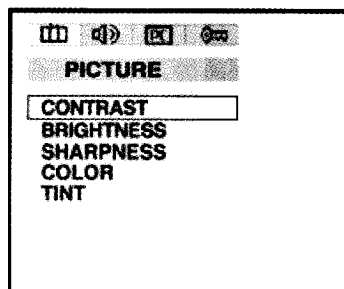

1 Press the **MENU** button.
Result: The **PICTURE** menu is displayed.

2 Use the **CH ▼** or **CH ▲** buttons to select one of the following options:
CONTRAST
BRIGHTNESS
SHARPNESS
COLOUR
TINT (NTSC System)

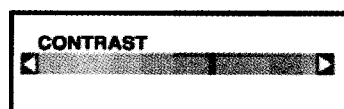

3 Press the **SEL** button.

4 Press the **VOL ◀** or **VOL ▶** buttons to suit your personal preference.

5 Press the **MENU** button repeatedly until the menus disappear.

Adjusting the Picture Settings 2

By pressing the P.STD button on the remote control, you can sequentially select any one of the four possible preferred analogue picture presets.

Whenever this button is pressed, the mode will be changed as follows.

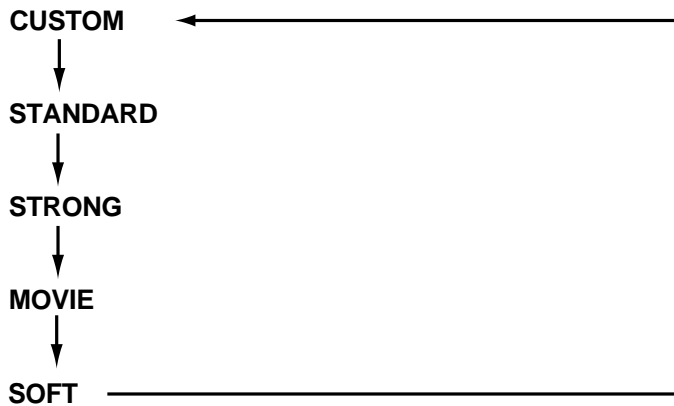

CUSTOM

Select this mode to view the adjusted picture you want.

STANDARD

Select this mode to view the factory - presetting standard picture.

STRONG

Select this mode to

- view a powerful and clear picture.
- watching in the brighter (daylight) environments.

MOVIE

Select this mode to view a DVD or Video picture.

SOFT

Select this mode

- to emphasize mildness.
- when it is dark around.
- to lessen the fatigue of eyes

Viewing a TV/VCR screen

Adjusting the Sound Settings 1

The sound settings can be adjusted to suit your personal preference:

TREBLE, BASS, BALANCE, S.MODE / MTS

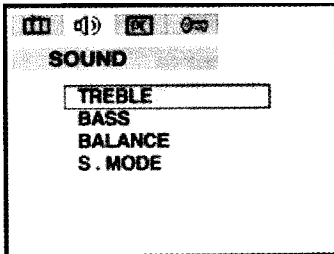

- 1 Press the **MENU** button.
Result: The **PICTURE** menu is displayed.
- 2 Use the **VOL** ◀, **VOL** ▶ buttons to move the **SOUND** menu.
- 3 Use the **CH** ▼ or **CH** ▲ buttons to select one of the following options:
TREBLE
BASS
BALANCE
S.MODE (PAL System)
MTS (NTSC System)

- 4 Press the **SEL** button.

- 5 Press the **VOL** ◀ or **VOL** ▶ buttons to suit your personal preference.
 - **S.MODE** : description below (PAL System)

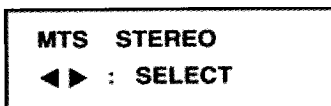
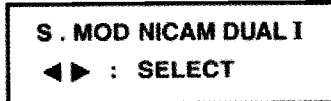
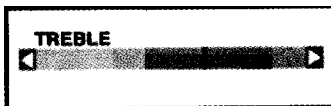

	Type of broadcast	On-screen Indication
NICAM Stereo	Regular broadcast (Standard audio)	Mono (Normal use)
	Regular + NICAM Mono	Mono ←→ Mono (Normal) Nicam
	NICAM Stereo	Stereo ←→ Mono (Normal) Nicam
	NICAM Dual-I/II	Dual-I ←→ Dual-II ←→ Mono (Normal) Nicam Nicam
A2 Stereo	Regular broadcast (Standard audio)	Mono (Normal use)
	Bilingual or Dual-I/II	Dual-I ←→ Dual-II
	Stereo	Stereo ←→ Mono (Forced Mono)

- **MTS**: To select **STEREO, SAP** or **MONO** (NTSC System)

- 6 Press the **MENU** button repeatedly until the menus disappear.

Adjusting the Sound Settings 2

By pressing the S.STD button on the remote control, You may get more best sound and change the sound of a suit with a video source. Whenever this button is pressed, the mode will be changed as follows.

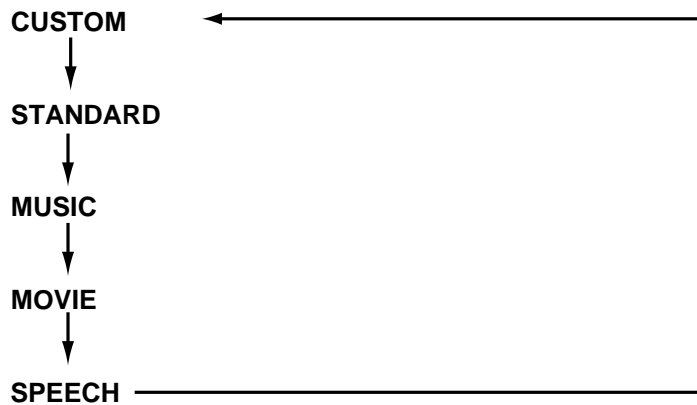

CUSTOM

Select this mode to listen the adjusted sound you want.

STANDARD

Select this mode to listen the factory - presetting standard sound.

MUSIC

Select this mode to listen the music video or the live picture source.

MOVIE

Select this mode to listen the movie sound.

SPEECH

Select this mode to listen the TV news or the TV talk-shows, etc.

Channel Memory (PAL System)

Storing the Channels Automatically

You can scan the frequency ranges available on your television in your country and store all the channels found automatically. The channels are stored in the order in which they appear in the frequency bands. It is possible that the automatically allocated numbers may not correspond to those by which you wish to identify the channels. If this is the case, you can then sort them manually.

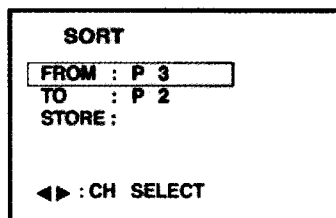
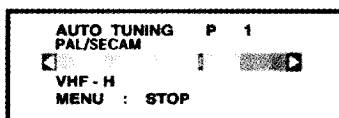
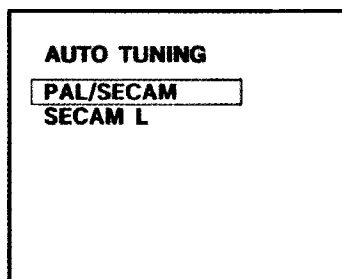
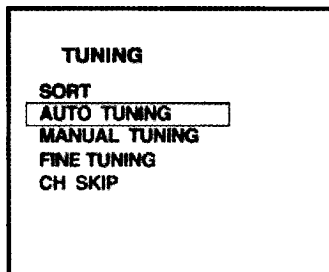
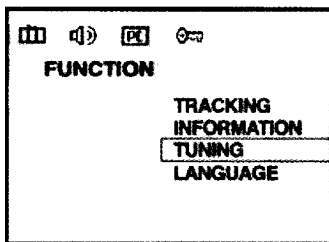

- 1 Press the **MENU** button.
Result: The **PICTURE** menu is displayed.
- 2 Press the **VOL ◀** button to place the selection bar on the **FUNCTION** menu.
- 3 Press the **CH ▼** button to place the selection bar on the **TUNING** mode.
And press the **SEL** button.
- 4 Press the **CH ▼** button to place the selection bar on the **AUTO TUNING** and press the **SEL** button.
- 5 Press the **CH ▼** button, set the broadcasting system. (PAL/ SECAM or SECAM L) and press SEL button.

Result: The **AUTO TUNING** will store found channel automatically. While the **AUTO TUNING** is progressing, the TV will change channels up to 99. When searching and storing is completed, the **SORT** menu is displayed. User can exchange favourite channels to preferred channel number.
- 6 Press the **VOL ◀** or **VOL ▶** button until favourite channel is shown.
- 7 Press the **CH ▼** button to place the selection bar on the TO option. Press the **VOL ◀** or **VOL ▶** until the new number by which you wish to identify the channel is displayed.
- 8 Press the **CH ▼** button to place the selection bar on the store. Press the **VOL ◀** or **VOL ▶** button, the channel will stored in memory displaying **OK** for a moment.
- 9 When searching and storing is complete, press the **MENU** button repeatedly until the menus disappear.

Channel Memory (PAL System)

Storing the Channel Manually

When storing channels manually, you can choose:
whether or not store each of the channels found.

The number by which you wish to identify each stored channel.

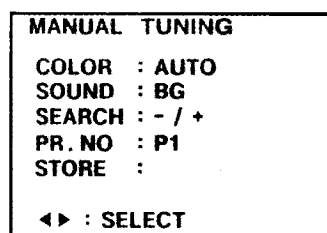
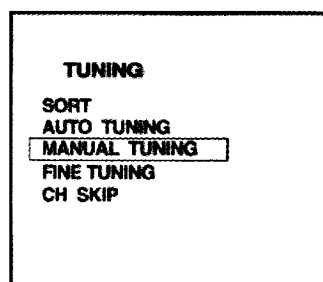
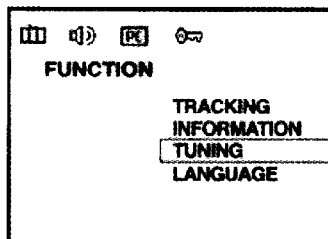

- 1 Press the **MENU** button.
Result: The picture menu is displayed.
- 2 Use the **VOL◀** or **VOL▶** buttons to move the **FUNCTION** menu.
- 3 Press the **CH▼** or **CH▲** button to select the **TUNING** option and press the **SEL** button.
Result: The tuning menu is displayed.
- 4 Press the **CH▼** or **CH▲** button to move the **MANUAL TUNING** and press the **SEL** button.
- 5 Press the **VOL◀** or **VOL▶** button repeatedly until the **COLOR SYSTEM** is best quality.
Result: The **COLOR SYSTEM** is changed.
PAL → SECAM → AUTO
- 6 Press the **CH▼** button to move the **SOUND**.
- 7 Press the **VOL◀** or **VOL▶** button repeatedly until the **SOUND SYSTEM** is best quality
Result: The sound system is changed.
BG → DK → I → L
- 8 Press the **CH▼** button to move the **PR. NO**

Channel Memory (PAL System)

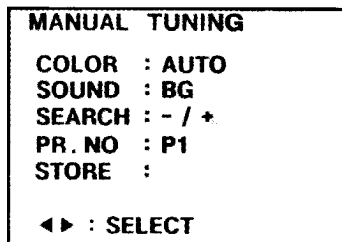

MANUAL TUNING
COLOR : AUTO
SOUND : BG
SEARCH : - / +
PR. NO : P1
STORE :
<left><right> : SELECT

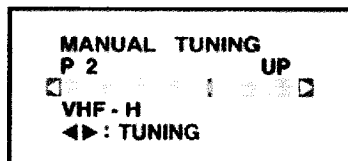

MANUAL TUNING
P 2
UP
VHF - H
<left><right> : TUNING

- 9 To assign a program number to the channel, press the **VOL** ◀ or **VOL** ▶ button until you find the correct number.
- 10 Press the **CH** ▼ button to move the **SEARCH**.
- 11 Press the **VOL** ◀ or **VOL** ▶ button to start the search.
- 12 When the screen is fine tuned, press the **CH** ▼ button to move the **STORE**.
- 13 Press the **VOL** ◀ or **VOL** ▶ button, the channel will automatically stored in memory displaying OK for a moment.
- 14 Repeat steps 8~13 for each channel to be stored.
- 15 When you have finished manual storage, press the **MENU** button repeatedly to return to normal viewing.

Channel Memory (PAL System)

Fine Tuning Channel Reception

If the reception is clear, you do not fine-tune the channel, as this is done automatically during the search and store operation.

If however the signal is weak or distorted, you may have to fine-tune the channel manually.

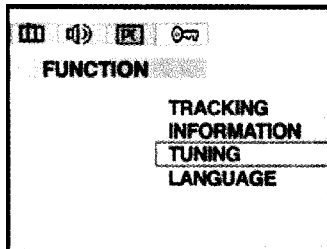

1 Press the **MENU** button.
Result: The **PICTURE** menu is displayed.

2 Use the **VOL ◀** or **VOL ▶** buttons to move the **FUNCTION** menu.

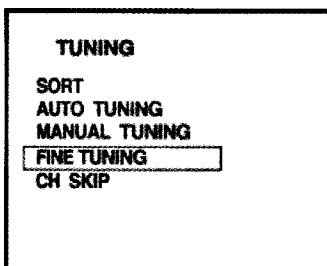

3 Press the **CH ▼** or **CH ▲** button to select the **TUNING** option and press the **SEL** button.
Result: The tuning menu is displayed.

4 Press the **CH ▼** or **CH ▲** button to move the **FINE TUNING** and press the **SEL** button.

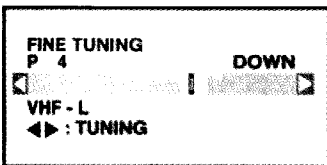

5 When a channel is right viewed by using the **VOL ◀** or **VOL ▶** buttons, the Tuning is automatically set.

6 Press the **MENU** button repeatedly until the menus disappear.

Channel Memory (PAL System)

Skipping Unwanted Channels

You can exclude the channels of your choice from the channel scan operation. When you scan through the stored channels, those you have chosen to skip are not displayed.

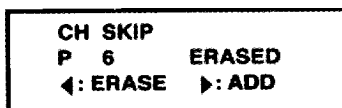
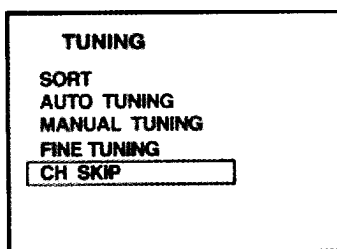
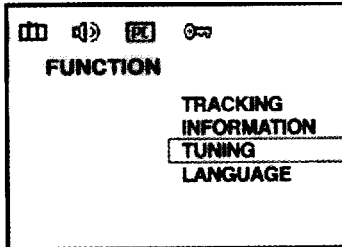

- 1 Press the **MENU** button.
- 2 Use the **VOL**◀ or **VOL**▶ buttons to move the **FUNCTION** menu.
- 3 Press the **CH**▼ or **CH**▲ button to select the **TUNING** option and press the **SEL** button.
Result: The tuning menu is displayed.
- 4 Press the **CH**▼ or **CH**▲ button to move the **CH SKIP** and press the **SEL** button.
- 5 Press the **CH**▼ or **CH**▲ button to select the required channel.
- 6 To add or erase the desired channel by pressing the **VOL**◀ or **VOL**▶
VOL◀ :ERASE, **VOL**▶ :ADD
- 7 Press the **MENU** button repeatedly until the menus disappear.

Other Functions

SLEEP

You don't have to remember to switch the set turn off before you go to sleep.

The sleep timer automatically switches the set to stand-by after the preset time elapses.

For selecting you desired number of minutes, press the **SLEEP** button several times or Continuously. OFF will appear on the screen, followed by 10, 20, 30, 60, 90, 120, 150, and 180.

NOTE:

1. To view the remaining sleep time, press the **SLEEP** button once.
2. To cancel the sleep time, repeatedly press the **SLEEP** button until the display **SLEEP OFF** appears.
3. When you switched the set turn off, the set released the preset sleep time.

RECALL

Press **RECALL** button on the remote control. The number of TV channel or the video mode you are now viewing, will display on the screen.

SURROUND

You can select the special surround effect sound. Press **SURROUND** button, you may get surround effect sound and will display **SURROUND ON**, on the screen. If you don't want this effect, press again **SURROUND** button then you may get normal sound and will display **SURROUND OFF**.

APPENDIX A: Power Saver

This monitor has a built-in power management system called Power saver. This system saves energy by switching your monitor into a low-power mode when it has not been used for a certain period of time. The available modes are "On", "Stand-by", "Sleep" and "Deep Sleep". Power Saver operates with a VESA DPMS compliant video card installed in your computer You use a software utility installed on your computer to set up this feature. See below table for details.

S:rate	Normal Operation	Power-Saving Function mode (EPA / ENERGY 2000)		
		Standby Mode	Sleep Mode Position A1	Deep Sleep Mode Position A2
Horizontal Sync Vertical Sync Video	Active Active Active	Inactive Active Blanked	Active Inactive Blanked	Inactive Inactive Blanked
Power Indicator	Green	Amber	Amber Blinking (0.5 sec interval)	Amber Blinking (1 sec interval)
Power Consumption	30W (Max.)	Less than 3W	Less than 3W	Less than 3W

NOTE: This monitor automatically returns to normal operation when horizontal and vertical sync return. This occurs when you move the computer's mouse or press a key on the keyboard.

APPENDIX B: Troubleshooting

If you have a problem setting up or using your LCD monitor, you may be able to solve it yourself. Before contacting customer service, try the suggested actions that are appropriate to your problem.

What you see...	Suggested Actions	Reference
Screen is blank and power indicator is off	<ul style="list-style-type: none"> Ensure that the power cord is firmly connected and the LCD monitor is on. 	Connecting a PC, page 13.
"CHECK CABLE OR SIGNAL" message	<ul style="list-style-type: none"> Ensure that the signal cable is firmly connected to the PC or video sources. Ensure that the PC or video sources are turned on. 	Connecting a PC, TV or VCR, Page 12, 18.
"INVALID MODE" message	<ul style="list-style-type: none"> Check the maximum resolution and the frequency of the video adaptor. Compare these values with the data in the Display Modes Timing Chart. 	PC Stable Adjustment, page 19. APPENDIX D: Display Modes page 33.
The image is too light or too dark	<ul style="list-style-type: none"> Adjust the Brightness and Contrast. 	BRIGHTNESS, page 15, 20. CONTRAST, page 15, 20.
Horizontal bars appear to flicker, jitter or shimmer on the image	<ul style="list-style-type: none"> Adjust the Clock function. Auto Tracking will clear it automatically. 	PC Stale Adjustment. page 18.
Vertical bars appear to flicker, jitter or shimmer on the image.	<ul style="list-style-type: none"> Adjust the Phase function and then adjust the Clock function. Auto Tracking will clear it automatically. 	
Screen is blank and power indicator light is steady amber or blinks every 0.5 or 1 seconds	<ul style="list-style-type: none"> The monitor is using its power management system. Move the computer's mouse or press a key on the keyboard. 	APPENDIX A : Power Saver, page 33.
Image is not stable and may appear to vibrate	<ul style="list-style-type: none"> Auto tracking will clear it automatically Check that the display resolution and frequency from your PC or video board is an available mode for your monitor. On your computer check : Control Panel, Display, Settings 	PC Stable Adjustment, page 18.
	<ul style="list-style-type: none"> Horizontal frequency Vertical frequency Maximum refresh rate 	31KHz - 69KHz 56Hz - 85Hz 1024 x 768 @85Hz
Image is not centred on the screen.	<ul style="list-style-type: none"> Auto Position will set the best position automatically Adjust the horizontal and vertical position. 	AUTO POSITION, page 17. H-POSITION, page 17. V-POSITION, page 17.

APPENDIX B: Troubleshooting

Problem	Suggested Actions	Reference
No sound	<ul style="list-style-type: none"> • Ensure that the audio cable is firmly connected to both the audio-in jack on your monitor and the audio-out jack on your sound card. 	Connecting a PC, TV or VCR, page 13, 19.
	<ul style="list-style-type: none"> • Check the volume level 	Adjusting the Sound settings, page 16, 21.
Sound level is too low	<ul style="list-style-type: none"> • Check the volume level 	
	<ul style="list-style-type: none"> • If the volume is still too low after turning the control to its maximum, check the volume control on the computer sound card or software program. 	Refer to your computer, sound card or software documentation.
Sound is too high pitched or too low pitched	<ul style="list-style-type: none"> • Adjust the Treble and Bass to appropriate level. 	Adjusting the Sound Settings, page 16, 22.
TV signal is not received	<ul style="list-style-type: none"> • Ensure that the antenna cable is firmly connected to the VHF/UHF jack. 	Connecting to watch TV or VCR, page 19.
	<ul style="list-style-type: none"> • Check "Channel Memory" and make sure you choose the correct channel system. (PAL Model) 	Channel Memory, page 25, 26.
	<ul style="list-style-type: none"> • Select "Auto Tuning" to configure the channel system automatically. (PAL Model) 	
	<ul style="list-style-type: none"> • Check AIR/CATV is correctly selected on screen display menu. (NTSC Model) 	Selecting Broadcast Source, page 29

APPENDIX C: Specification

FUNCTION		MONITOR	TV (PAL model)	TV (NTSC model)	
LCD Panel	Type	15.1" TFT AM LCD			
	Display Area	307.2mm x 230.4mm			
	Display Colour	16,777,216 (8-bit)			
	Pixel Pitch	0.3mm x 0.3mm			
	Max. Resolution	XGA 1024 x 768 (@85Hz)			
	Interface	TTL / TMDS			
	Viewing Angle	120 degrees horizontal / 90 degrees vertical			
	Contrast Ratio	350 : 1 (typical)			
	Brightness	400cd/m ²			
	Physical Rotation	+30 degrees Up, -5 degrees Down			
	Horizontal Frequency	31 ~ 69KHz			
	Vertical Frequency	56 ~ 85Hz			
	Dimension	384(W) mm x 378(H) mm x 57(D) mm			
Input / Output	Video input	PC Analog RGB	A/V, S-Video, SCART	A/V, S-Video	
	Audio Input	PC Audio	PC Audio, A/V, S-Video, SCART	PC Audio, A/V, S-Video	
	Audio Output	Monitor Out			
TV Signal	Area	None	EU (Except France), Australia	USA	
	Antenna Input	None	75 Coaxial Cable		
	Tuning System	None	Programmable Frequency Synthesizer		
	Colour System	None	PAL/SECAM, NTSC	NTSC	
	Sound System	None	B/G, D/K, I	M	
	Tuning Range	VHF Low	None	E2Ch(48.25MHz)~S10Ch(168.25MHz)	1Ch(91.25MHz)~C22Ch(165.25MHz)
		VHF High	None	E5Ch(175.25MHz)~S41Ch(463.25MHz)	4Ch(171.25MHz)~C38Ch(313.25MHz)
		UHF	None	E21Ch(471.25MHz)~E69Ch(885.25MHz)	13Ch(471.25MHz)~62Ch(765.25MHz)
Teletext	None	Optional	None		
Regulation	Safety	UL, CSA, FCC, CE, CCIB, EIAJ			
	EMI	CE, C-Tick			
Other	Power Output	Stand-by: 3Watt / Operation: 45Watt			
	Speaker	3W (PMPO) x 2EA			
	Plug & Play Level	DDC 1/26			
	Weight	NET 4.8Kg/ Gross 7.3Kg			
	Power Supply	DC 12V, 5A, 50/60Hz			

Specification can be changed without prior notice.

APPENDIX D: Display Modes

If the signal from the system equals to the standard signal mode, the screen is adjusted automatically. If the signal from the system doesn't equal to the standard signal mode, adjust the mode with referring to the Video card user guide because the screen might not display or only the power LED might be on. For the display modes listed below, the screen image has been optimised during manufacturing.

Mode	Resolution	Horizontal Frequency (KHz)	Vertical Frequency (Hz)	Pixel Clock Frequency (MHz)	Sync Polarity (H/V)
VGA	720 x 400	31.469	70.087	28.322	-/+
	640 x 480	31.469	59.940	25.175	-/-
	640 x 480	37.500	75.000	31.500	-/-
	640 x 480	43.269	85.008	36.000	-/-
SVGA	800 x 600	46.875	75.000	49.500	+/+
	800 x 600	53.674	85.061	56.250	+/+
XGA	1024 x 768	48.363	60.004	65.000	-/-
	1024 x 768	60.023	75.029	78.750	+/+
	1024 x 768	68.677	84.997	94.500	+/+

PALSONIC CORPORATION PTY LTD
1 JOYNTON AVENUE
WATERLOO NSW 2017 AUSTRALIA
TEL:(02)9313 7111
FAX:(02)9313 7555
www.palsonic.com.au

**PALSONIC CUSTOMER SERVICE
TELEPHONE
AUSTRALIA: 1300 657 888**

KQFIT201Z7

Free Manuals Download Website

<http://myh66.com>

<http://usermanuals.us>

<http://www.somanuals.com>

<http://www.4manuals.cc>

<http://www.manual-lib.com>

<http://www.404manual.com>

<http://www.luxmanual.com>

<http://aubethermostatmanual.com>

Golf course search by state

<http://golfingnear.com>

Email search by domain

<http://emailbydomain.com>

Auto manuals search

<http://auto.somanuals.com>

TV manuals search

<http://tv.somanuals.com>