

DVD/CD/MP3 PLAYER

Palsonic

**DVD2030
USER'S MANUAL**

Please read this manual before connection and use.

PALSONIC CORPORATION PTY LTD
1 JOYNTON AVENUE
WATERLOO NSW 2017 AUSTRALIA
TEL: (02) 9313 7111
FAX: (02) 9313 7555
www.palsonic.com.au

**PALSONIC CUSTOMER SERVICE
TELEPHONE
AUSTRALIA: 1300 657 888**

English

Introduction

- Safety Precautions 2
- Important Safety Instructions..... 3
- Caution 5
- Features 6
- Front Panel and Rear Panel Illustration 7
- Remote Controller 8

Connections

- Connecting to a TV Set 9
- Connecting to an AV Amplifier with 2 Channels Analog Audio Input 10
- Connecting to a AV Amplifier with Digital Audio Input 11

Basic Playback

- Basic Operation 12

Function Illustrations

- Modes and Features Setup 13
- Remote Controller Operation 18
- MP3 Playback 27
- Kodak Picture CD Playback 28

Others

- Trouble Shooting 29
- Specifications 30
- Remote Controller Preparation 30

Safety Precautions

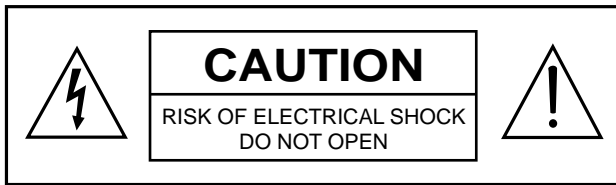

THE LIGHTNING FLASH WITH ARROWHEAD SYMBOL WITHIN AN EQUILATERAL TRIANGLE IS INTENT TO ALERT THE USER TO THE PRESENCE OF UNINSULATED "DANGEROUS VOLTAGE" WITHIN THE UNIT'S CABINET THAT MAY BE OF SUFFICIENT MAGNITUDE TO CONSTITUTE A RISK OF ELECTRIC SHOCK TO PERSONS.



THE EXCLAMATION POINT WITHIN AN EQUILATERAL TRIANGLE IS INTENDED TO ALERT THE USER TO THE PRESENCE OF IMPORTANT OPERATING AND MAINTENANCE (SERVICING) INSTRUCTIONS IN THE MANUAL ACCOMPANYING THE UNIT.

WARNING:

TO PREVENT FIRE OR ELECTRIC SHOCKS, DO NOT EXPOSE THE UNIT TO RAIN OR MOISTURE. NEVER ATTEMPT TO OPEN THE CABINET, DANGEROUS HIGH VOLTAGES ARE PRESENT IN THE UNIT. REFER SERVICING TO QUALIFIED SERVICE PERSONNEL.

CAUTION:

TO PREVENT ELECTRIC SHOCKS, MATCH WIDE-BLADE PLUG WITH WIDE SLOT, FULLY INSERT. THE APPARATUS SHALL NOT BE EXPOSED TO DRIPPING OR SPLASHING AND THAT NO OBJECTS FILLED WITH LIQUIDS SUCH AS VASES SHALL BE PLACED ON THE APPARATUS.

CAUTION:

THE UNIT EMPLOYS A LASER SYSTEM. TO ENSURE THE PROPER USE OF THE UNIT, READ THIS MANUAL CAREFULLY AND KEEP IT FOR FUTURE REFERENCE.

IF THE UNIT REQUIRES SERVICING, CONTACT THE SELLER OR OUR SERVICE CENTRE - SEE "TROUBLE SHOOTING".

TO PREVENT DIRECT EXPOSURE TO THE LASER RADIATION, DO NOT OPEN THE CABINET. VISIBLE LASER MAY RADIATE WHEN THE CABINET OPENED OR THE INTERLOCKS ARE DEFEATED. DO NOT STARE INTO THE LASER BEAMS.

CAUTION:

THE DVD VIDEO PLAYER IS A CLASS 1 LASER PRODUCT. USE OF CONTROLS OR ADJUSTMENTS OR PERFORMANCE OF PROCEDURES OTHER THAN THOSE SPECIFIED HEREIN MAY RESULT IN HAZARDOUS RADIATION EXPOSURE.

AS THE LASER BEAM USED IN THIS DVD VIDEO PLAYER IS HARMFUL TO THE EYES, DO NOT ATTEMPT TO DISASSEMBLE THE CABINET. REFER SERVICING TO QUALIFIED PERSONNEL ONLY.

WARNING:

FCC REGULATIONS STATE THAT ANY CHANGE OR MODIFICATION TO THE EQUIPMENT, NOT EXPRESSLY APPROVED BY MAKER OR ITS AUTHORISED PARTIES, COULD VOID USERS AUTHORITY TO OPERATE THIS EQUIPMENT.

1. READ INSTRUCTIONS

All the safety and operating instructions should be read before the product is operated.

2. RETAIN INSTRUCTIONS

The safety and operating instructions should be retained for future reference.

3. HEED WARNINGS

All warnings on the unit and in the operating instructions should be adhered to.

4. FOLLOW INSTRUCTIONS

All operating and use instructions should be followed.

5. CLEANING

Unplug this product from the wall outlet before cleaning. Do not use liquid cleaners or aerosol cleaners. Use a damp cloth for cleaning.

6. ATTACHMENTS

Do not use attachments not recommended by the product manufacturer as they may cause hazards.

7. WATER AND MOISTURE

Do not use this product near water for example, near a bathtub, wash bowl, kitchen sink or laundry tub; in a wet basement, or near a swimming pool; and the like.

8. ACCESSORIES

Do not place this product on an unstable cart, stand, tripod, bracket, or table. The product may fall, causing serious injury to a child or adult and serious damage to the product. Use only with a cart, stand, tripod, bracket, or table recommended by the manufacturer or sold with the product. Any mounting of the product should follow the manufacturer's instructions, and should use a mounting accessory recommended by the manufacturer.

9. PORTABLE CART WARNING

A product and cart combination should be moved with care. Quick stops, excessive force, and uneven surface may cause the product and cart combination to overturn.



(Symbol provided by RETAC)

10. VENTILATION

Slots and openings in the case are provided for ventilation to ensure reliable operation of the product and to protect it from overheating, and these openings must not be blocked or covered. These openings should never be blocked by placing the product on a bed, sofa, rug, or other similar surface. This product should not be placed in a built-in installation such as a bookcase or rack unless proper ventilation is provided or the manufacturer's instructions have been adhered to.

11. POWER SOURCES

This product should be operated only from the type of power source indicated on the marking label. If you are not sure of the type of power supply to your home, consult your product dealer or local power company. For products intended to operate from battery power, or other sources, refer to the operating instructions.

12. GROUNDING OR POLARISATION

This product may be equipped with a polarised alternating current line plug (a plug having one blade wider than the other). This plug will fit into the power outlet only one way. This is a safety feature. If you are unable to insert the plug fully into the outlet, try reversing the plug. If the plug still fails to fit, contact your electrician to replace your obsolete outlet. Do not defeat the safety purpose of the polarised plug.

13. POWER-CORD PROTECTION

Power supply cords should be routed so that they are not likely to be walked on or pinched by items placed upon or against them, paying particular attention to cords at plugs, convenience receptacles, and the point where they exit from the unit.

14. PROTECTIVE ATTACHMENT PLUG

The product is equipped with an attachment plug having overload protection. This is a safety feature. See Instruction Manual for replacement or resetting of protective device. If replacement of the plug is required, be sure the service technician has used a replacement plug specified by the manufacturer that has the same overload protection as the original plug.

15. OUTDOOR ANTENNA GROUNDING

If an outside antenna or cable system is connected to the product, be sure the antenna or cable system is grounded so as to provide some protection against voltage surges and built-up static charges. Article 810 of the National Electrical Code, ANSI/NFPA70, provides information with regard to proper grounding of the mast and supporting structure, grounding of the lead-in wire to an antenna discharge unit, size of grounding conductors, location of antenna discharge unit, connection to grounding electrodes, and requirements for the grounding electrode. See figure below.

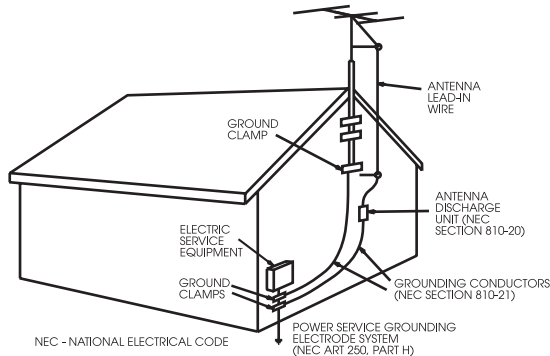

16. LIGHTNING

For added protection for this product during a lightning storm, or when it is left unattended and unused for long periods of time, unplug it from the wall outlet and disconnect the antenna or cable system. This will prevent damage to the product due to lightning and power line surges.

17. POWER LINES

An outside antenna system should not be located in the vicinity of overhead power lines or other electric light or power circuits, or where it can fall in to such power lines or circuits. When installing an outside antenna system, extreme care should be taken to keep from touching such power lines or circuits as contact with them might be fatal.

18. OVERLOADING

Do not overload wall outlets, extension cords, or integral convenience receptacles, as this can result in a risk of fire or electric shock.

19. OBJECT AND LIQUID ENTRY

Never push objects of any kind into this product through openings as they may touch dangerous voltage points or short-out parts that could result in a fire or electric shock. Never spill liquid of any kind on the product.

20. SERVICING

Do not attempt to service this product yourself as opening or removing covers may expose you to dangerous voltage or other hazards. Refer all servicing to qualified service personnel.

21. DAMAGE REQUIRING SERVICE

Unplug this product from the wall outlet and refer servicing to qualified service personnel under the following conditions:

- A) When the power-supply cord or plug is damaged,
- B) If liquid has been spilled, or objects have fallen into the product,
- C) If the product has been exposed to rain or water,
- D) If the product does not operate normally by following the operating instructions. Adjust only those controls that are covered by the operating instructions as an improper adjustment of other controls may result in damage and will often require extensive work by a qualified technician to restore the product to its normal operation,
- E) If the product has been dropped or damaged in anyway, and
- F) When the product exhibits a distinct change in performance this indicates a need for service.

22. REPLACEMENT PARTS

When replacement parts are required, be sure the service technician has used replacement parts specified by the manufacturer or have the same characteristics as the original part. Unauthorised substitutions may result in fire, electric shock, or other hazards.

23. SAFETY CHECK

Upon completion of any service or repairs to this product, ask the service technician to perform safety checks to determine that the product is in proper operating condition.

24. WALL OR CEILING MOUNTING

The product should be mounted to a wall or ceiling only as recommended by the manufacturer.

25. HEAT

The product should be situated away from heat sources such as radiators, heat registers, stoves, or other products (including amplifiers) that produce heat.

- Please use the original box and packing materials for safe transportation of the product.

- It is normal for the cover and rear panel become warm after the player has been operating for an extended period of time.

- Do not move this product during playback. Doing so may cause damage to the pick-up and the disc.

- Press **OPEN/CLOSE** on the front panel or remote to open or close the disc tray. Do not push or touch the tray while it is opening or closing.

- Progress Scan Video output.
- Full compatibility with DVD, DVD+R/RW, DVD-R/RW ,VCD, CD, MP3, Kodak Picture CD, CD-R and CD-RW (finalised).
- Multiple playback modes: Program, Search, 10-Second Review.
- Dynamic spectrum display.
- Coaxial digital audio output.
- S-video, composite video and component (Y,Pb/Cb,Pr/Cr) video outputs.

Disc formats supported by this player:



Progressive scan



Multi-angle



Kodak Picture CDs



Closed Caption



MP3 files on CD-R/CD-RW



Subtitle choices



DVD VIDEO



Audio choices



Parental Lock

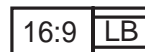

TV Aspect Ratio mode

This product incorporates copyright protection technology that is protected by method claims of certain U.S. patents and other intellectual property rights owned by Macrovision Corporation and other rights owners. Use of this copyright protection technology must be authorised by Macrovision Corporation, and is intended for home and other limited viewing uses only unless otherwise authorised by Macrovision Corporation. Reverse engineering or disassembly is prohibited.

The product complies with KODAK Picture CD format and will display KODAK Picture CDs. The "KODAK Picture CD Compatible" logo is a trademark of Eastman Kodak Company and is used with permission.

Front panel

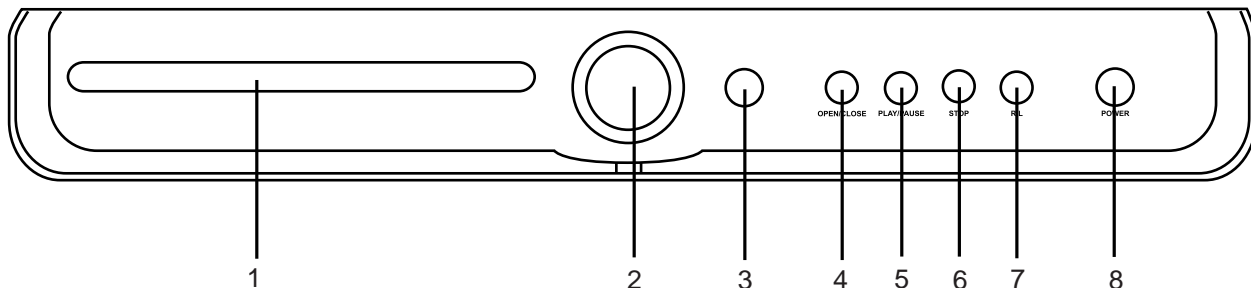

- | | |
|---|--|
| <p>1 Disc Tray - Insert disc here.</p> <p>2 Front Panel Display - Display the player's status.</p> <p>3 IR Sensor
- Receives input from the remote control.</p> <p>4 OPEN/CLOSE - Open and close the disc tray.</p> | <p>5 PLAY/PAUSE - Start/pause playback.</p> <p>6 STOP - Stop playback.</p> <p>7 R/L - Switch right/left channel.</p> <p>8 POWER - Turn the player on and off</p> |
|---|--|

Rear panel

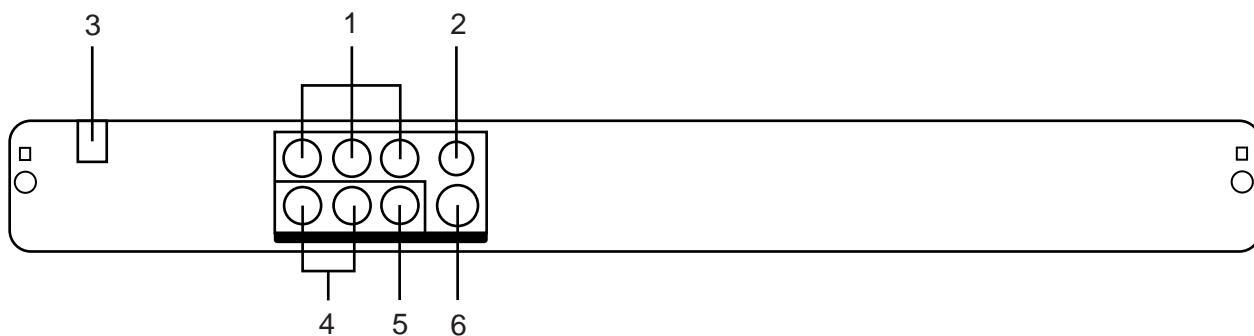

- | | |
|--|--|
| <p>1 Component Video/Progressive Scan Video Output - Connect to a TV equipped with Component Video or Progressive Scan Video inputs.</p> <p>2 Video Output - Connect to a TV or display device with a Video input.</p> <p>3 Power Cord - Connect to a standard power outlet.</p> <p>4 Audio Output - Connect to the audio inputs of a TV, stereo, or analog amplifier.</p> | <p>5 Coaxial Digital Audio Output - Connect to the coaxial input of a digital amplifier/receiver with a Dolby Digital decoder.</p> <p>6 S-Video Output - Connect to a TV equipped with an S-Video input.</p> |
|--|--|

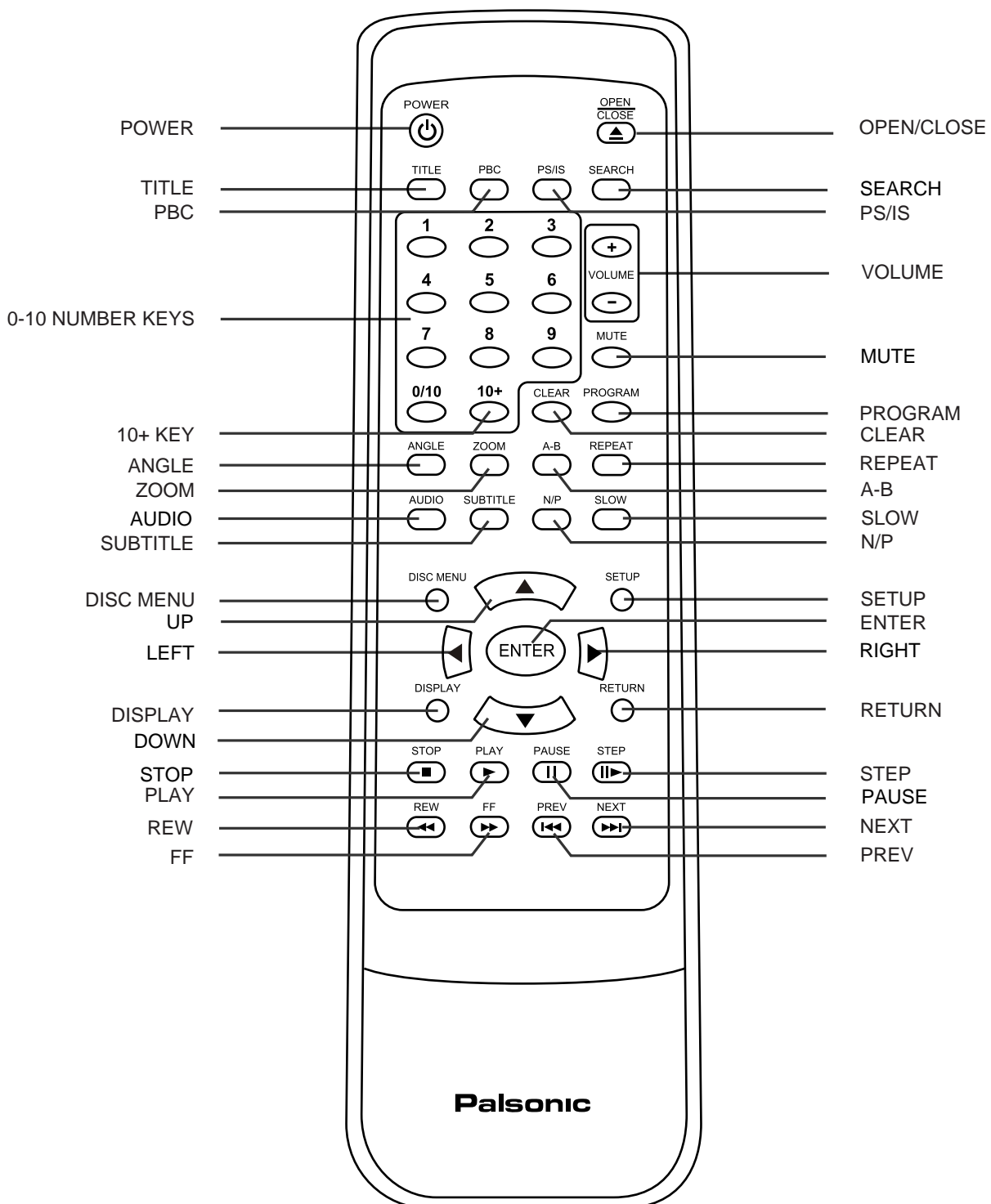

Note:

1. Please note that reference numbers for the remote are described begin on page 20 of this manual.
2. In this manual, "←" "→" "↑" "↓" will be used to represent different NAVIGATION ARROWS on the remote respectively.

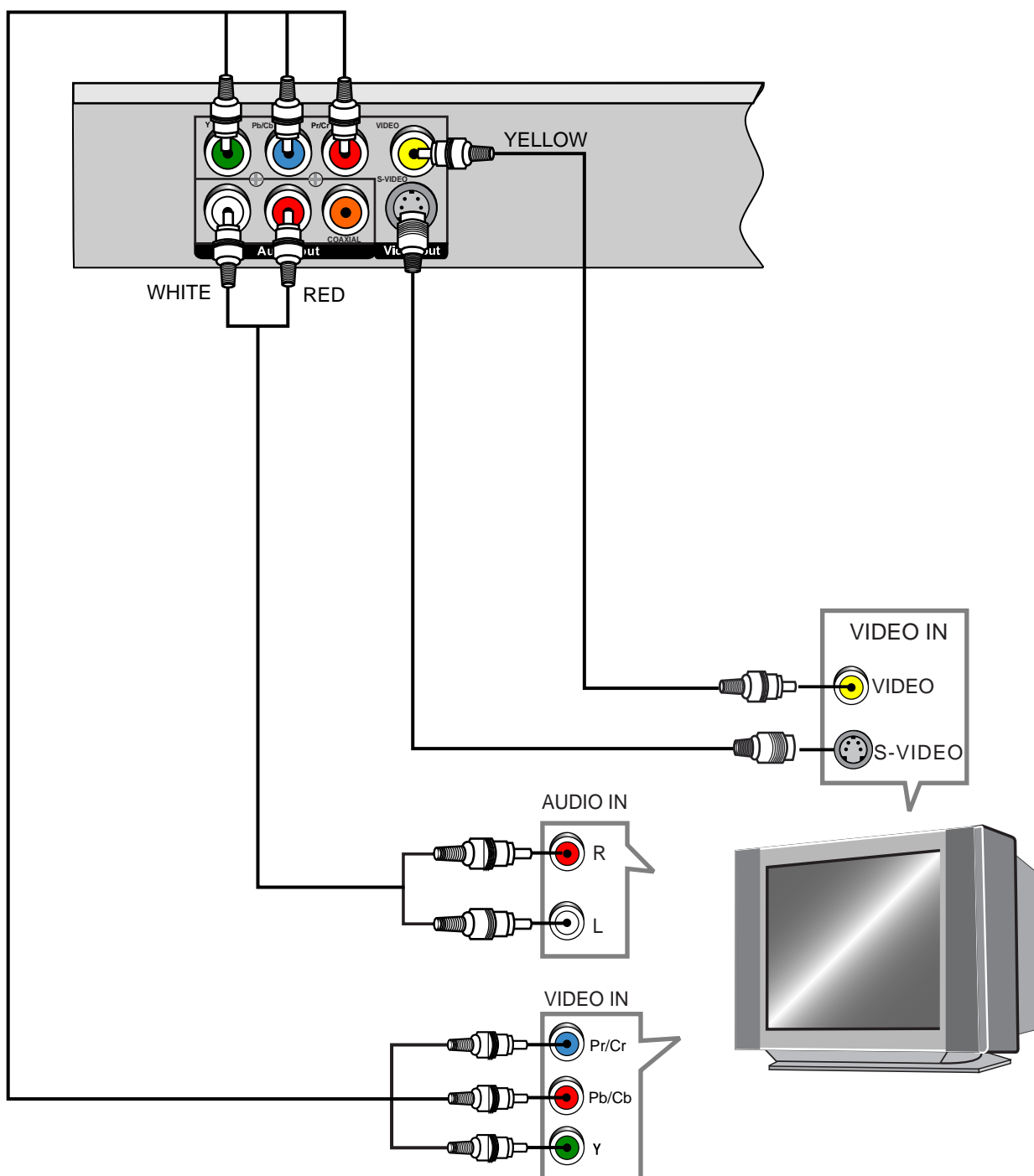

Notes:

There are three ways of connecting the player's AV output to the TV set:

1. S-Video cable and left/right audio cable [set the (Video Type) to (S-Video)].
2. Composite video cable and left/right audio cable.
3. Component video cable and left/right audio cable [set the (Video Type) to (Y Pb/Cb, Pr/Cr)].

Connecting to an AV amplifier with 2 Channel Analog Audio Input

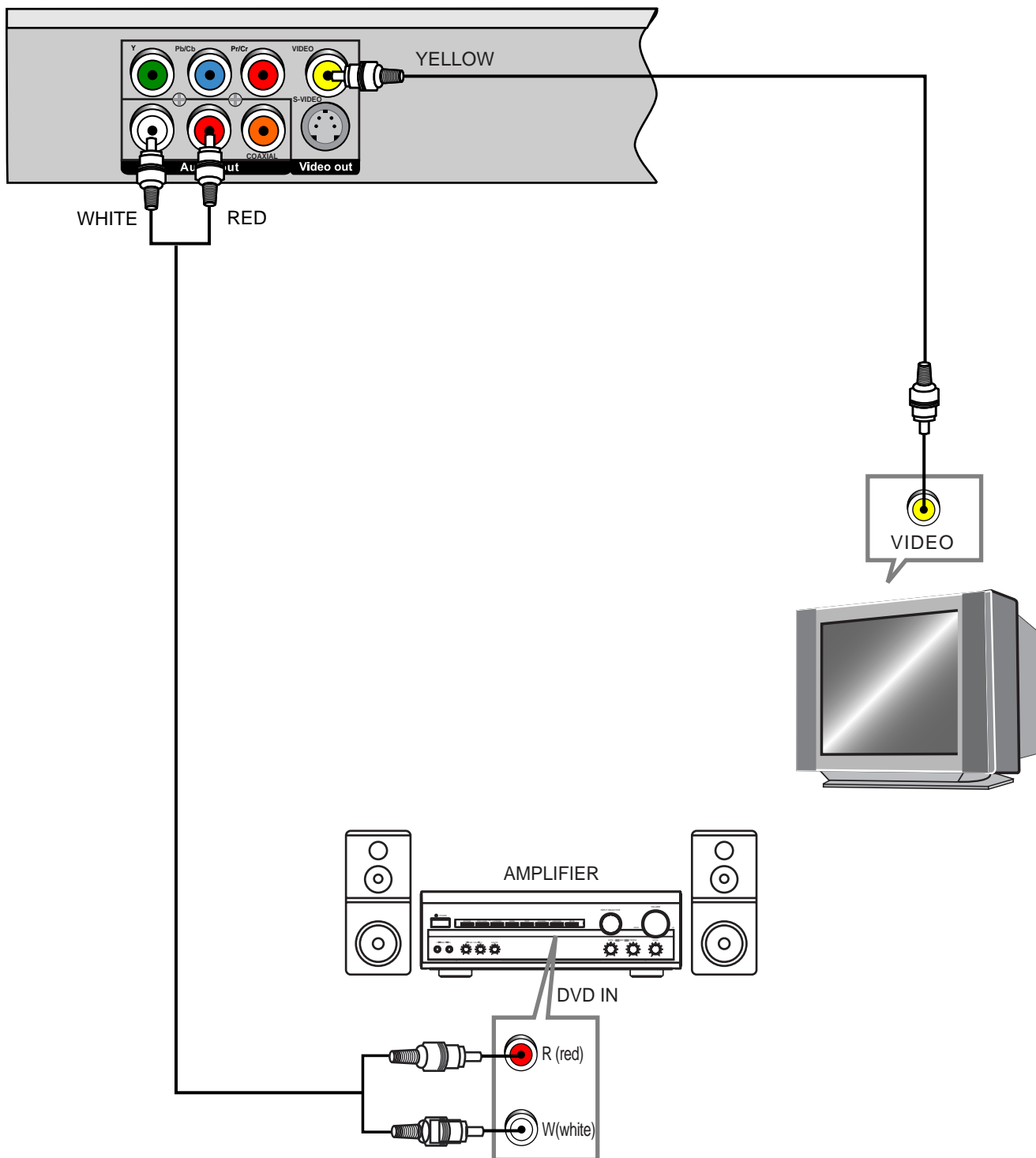

Notes:

1. Set the TV to the AV input connected to the DVD player.
2. Set the Amplifier's to the AV input connected to the DVD Player.

Connecting to an AV Amplifier with Digital Audio Output

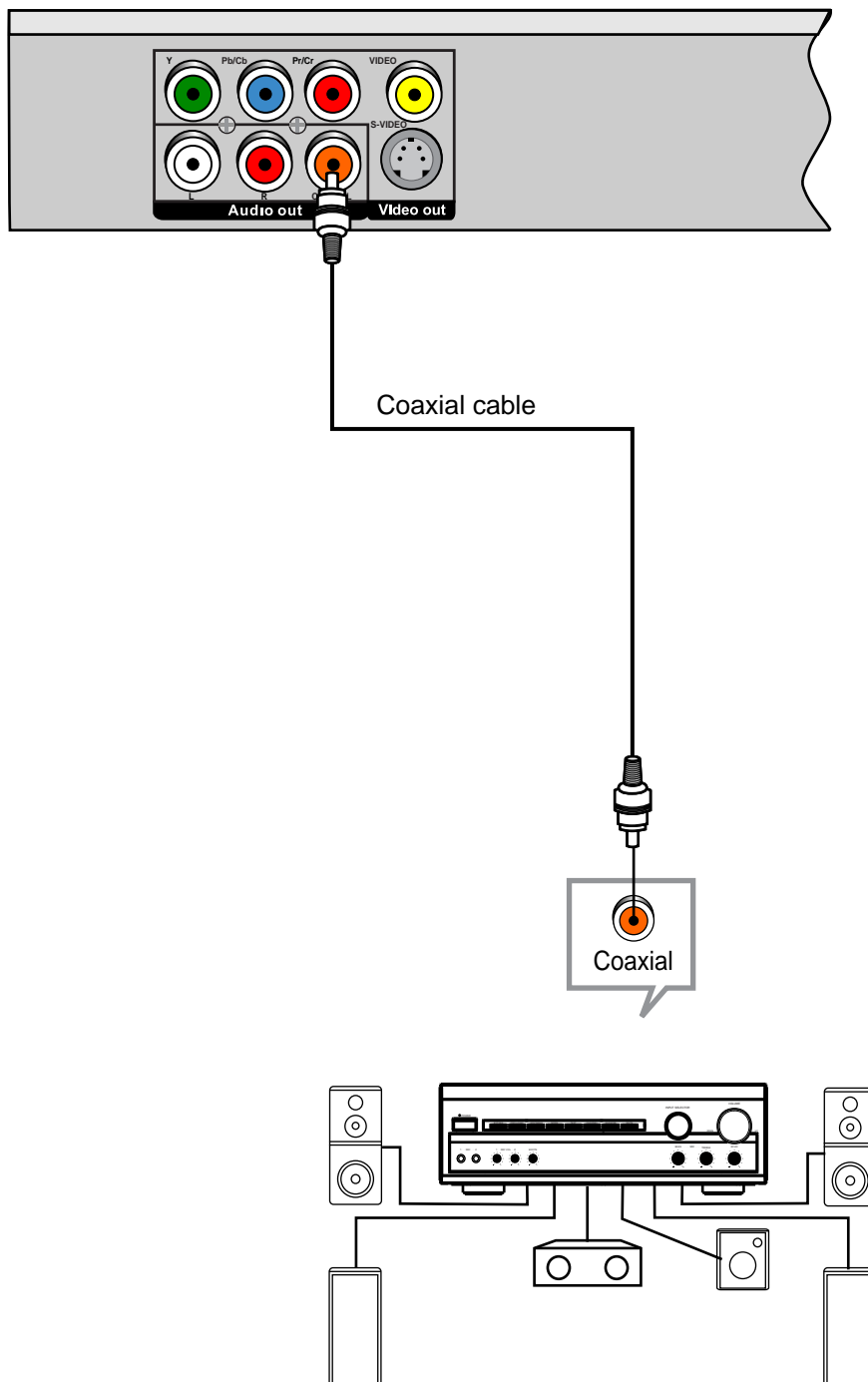

Notes:

1. Select the Coaxial digital audio output.
2. Set the players audio out to **Raw** or **PCM** mode.
3. Set the Amplifier to the AV input connected to the DVD player.

Preparation before playing:

1. Connect your DVD player to the TV and amplifier.
2. Turn on the TV.
3. Set the TV to the AV input connected to the DVD player
4. Turn down the volume on your amplifier, and then power it on.
5. Set the amplifier to the AV input connected to the DVD player.

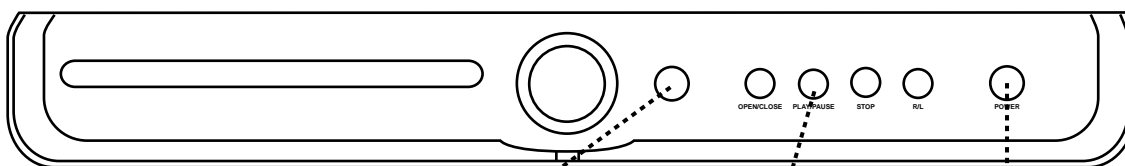

Step 2 - Press **OPEN/CLOSE** button either on front panel or remote control. When the tray is open, place the disc on the tray with the label side up. Press **OPEN/CLOSE** again to Close the disc tray.

Step 3 - Press the **PLAY** button on the front panel or remote control. The player will automatically read and identify the disc and begin playback.

Step 1 - Press the **POWER** to start the player. The logo appears on the TV screen.

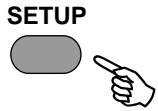

In stop mode, press **SETUP**, and the TV screen will display the Setup Menu as follows:

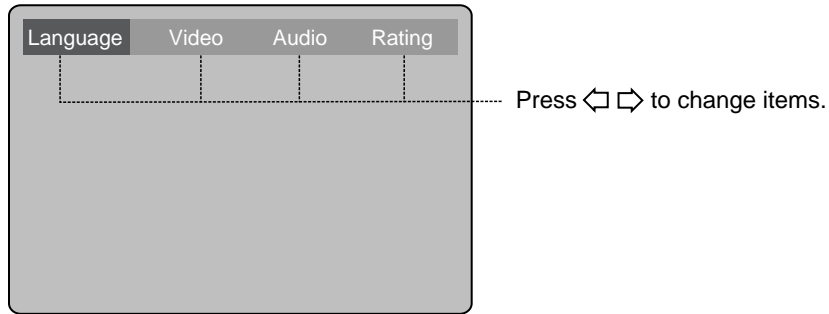

Setup Menu

- A. Press **ENTER** to display each submenu
- B. Press **SETUP** to exit the Setup Menu

Language Setup

Select [Language] in the Setup Menu, and press **ENTER** to display the [Language] submenu:

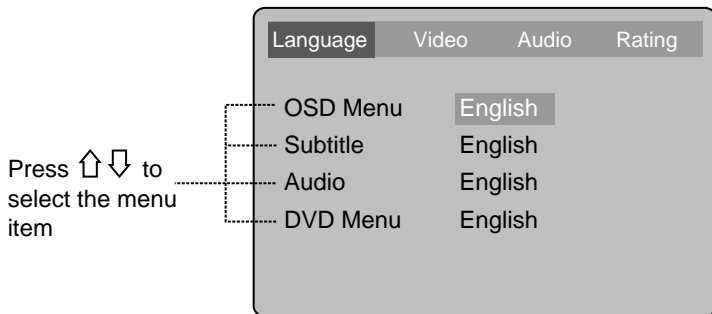

- A. Press **ENTER** or <Right> to set.
- B. Press <Left> to go back one menu.
- C. Press <Left> OR <Up> repeatedly to return to the Setup Menu.

Select [OSD Menu], and press **ENTER** or <Right> to display [OSD Menu] submenu:

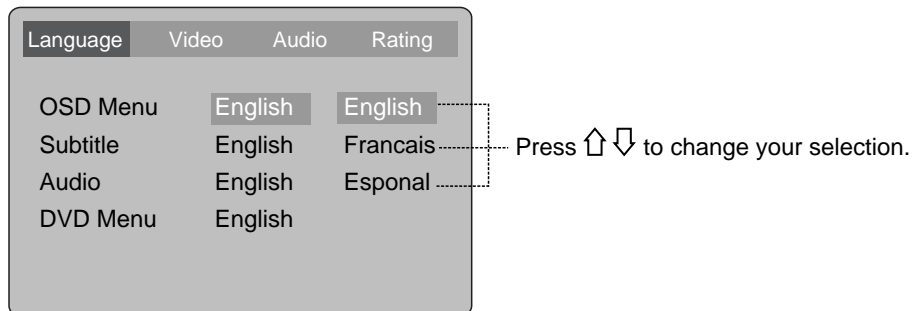

- A. Press **ENTER** to confirm.
- B. Press **SETUP** to exit the Setup Menu.

Language Setup

Select [Subtitle], and press **ENTER** or \rightarrow to display the [Subtitle] submenu:

Language	Video	Audio	Rating
OSD Menu	English		
Subtitle	English	English	
Audio	English	Francais	
DVD Menu	English	Esponal	
		Auto	
		Off	

Press \uparrow \downarrow to change your selection.
Note: Subtitle languages vary by disc.

- A. Press **ENTER** to confirm.
- B. Press **SETUP** to exit the Setup Menu.

Select [Audio], and press **ENTER** or \rightarrow to display the [Audio] submenu:

Language	Video	Audio	Rating
OSD Menu	English		
Subtitle	English		
Audio	English	English	
DVD Menu	English	Francais	
		Esponal	

Press \uparrow \downarrow to change your selection.
Note: Audio languages vary by disc.

- A. Press **ENTER** to confirm.
- B. Press **SETUP** to exit the Setup Menu.

Select [DVD Menu], and press **ENTER** or \rightarrow to display [DVD Menu] submenu:

Language	Video	Audio	Rating
OSD Menu	English		
Subtitle	English		
Audio	English		
DVD Menu	English	English	
		Francais	
		Esponal	

Press \uparrow \downarrow to change your selection.
Note: Menu languages vary by disc.

- A. Press **ENTER** to confirm.
- B. Press **SETUP** to exit the Setup Menu.

Video Setup

Select [Video], in the Setup Menu, and press **ENTER** to display the [Video] submenu:

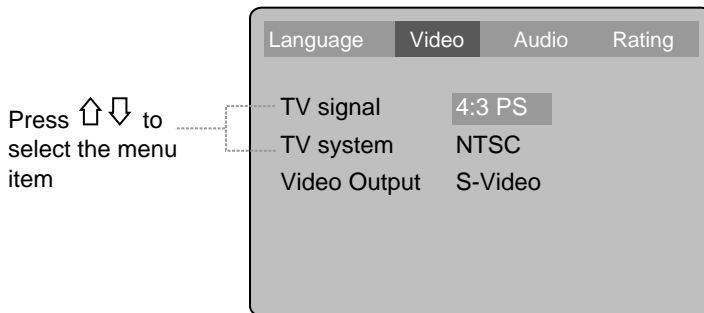

- A. Press **ENTER** or **RIGHT** to set.
- B. Press **LEFT** to return to the Setup Menu.

Select [TV shape], and press **ENTER** or **RIGHT** to display the [TV shape] submenu:

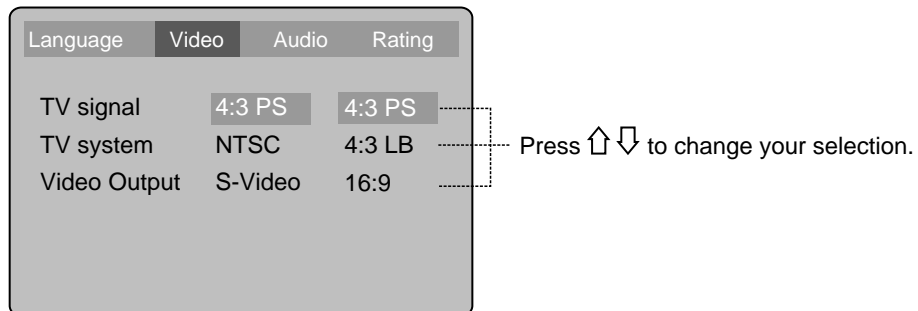

- A. Press **ENTER** to confirm. B. Press **SETUP** to exit the Setup Menu.
- [4:3PS] - Pan and scan refers to pictures where part of pictures is cut off so fills the whole screen.
- [4:3LB] - Letter Box refers to pictures where black bands appear at the top and bottom.
- [16:9] - The picture fill the screen of wide screen (16:9) television.
- Note: Not all DVDs offer movies in Full Screen format. If not, the disc will override your TV display setting and the movie will be displayed in Letterbox format.

Select [TV system], and press **ENTER** or **RIGHT** to display [TV system] submenu:

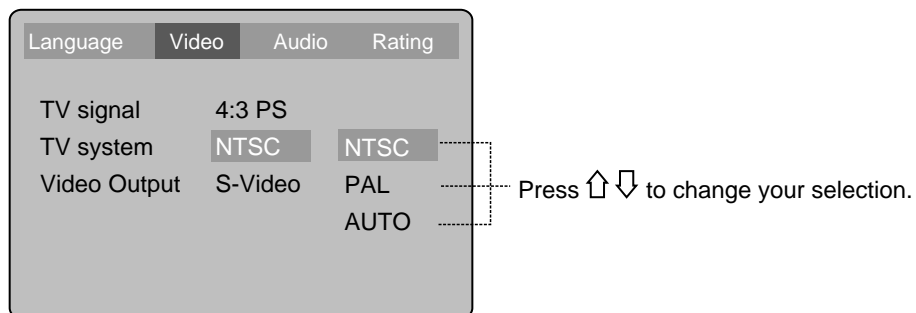

- A. Press **ENTER** to confirm.
- B. Press **SETUP** to exit the Setup Menu.
- [NTSC] - Select if you are using NTSC signal system to match your TV set.
- [PAL] - Select if you are using PAL signal system to match your TV set.
- [AUTO] - Select if you are using AUTO signal system to match your TV set.

Modes and Features Setup

Advanced Features

Select [Video Output], and press **ENTER** or $\square \rightarrow$ to display the [Video Out] submenu:

A. Press **ENTER** to confirm.

B. Press **SETUP** to exit the Setup Menu.

Note: The Composite video and S-video output is always available.

[S-Video] - Select if you connected the DVD player to your TV using the composite Video output.

[YUV] -Select if you connected the DVD player to your TV using the YUV output.

[Y Pb Pr] - Select if you connected the DVD player to your TV using progressive scan.

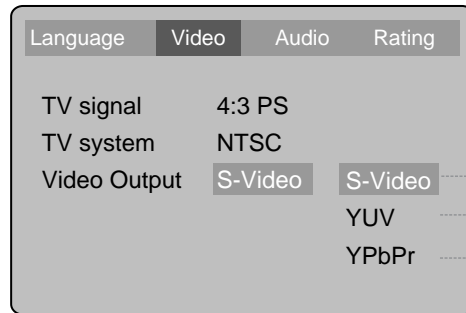

Press $\uparrow \downarrow$ to change your selection.

Audio Setup

The Audio menu allows you to set the analog and digital audio outputs to correspond with the external components you have connected to the player. For example, if you connected the player to a TV using the Stereo Audio jacks, you should set 2 channel to enjoy downmixed stereo audio.

- **You can set the audio format for each of the following sources: MP3, CD and Others.**
- **DVD playback must be stopped in order to adjust the Audio setup.**

AC-3 Setting

Follow these steps to set the analog and digital audio formats of outgoing Dolby Digital 2.1 sound tracks:

A. From Stop mode, press **SETUP**.

B. Select Audio and press **ENTER**.

C. Set Bitstream to:
2 Channel To output downmixed 2 channel stereo from the stereo audio outputs; e.g., to a VCR or TV.

D. Set Digital Out to:
LPCM (default) To output 2 channel digital from the optical/coaxial digital audio outputs; e.g., to a Mini Disc recorder.

E. Press **SETUP** to save and exit.

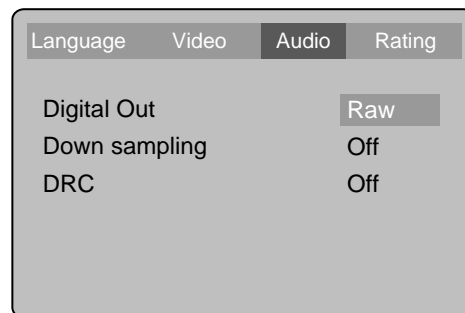

- **PCM stands for Pulse Code Modulation, and is the standard 2-channel stereo format used for audio Cds.**

Down sampling

Down the 96KHz sampling frequency to 48KHz (some equipment that does not support 96Khz).

DRC

You can turn on DRC to make the voice soft.

Note: When the digital output is set to PCM, the DRC is available.

Rating Setup

The Rating menu allows you to block playback of DVDs based on their ratings.

Setting the Password & Rating Level

The DVD player allows you to block playback of inappropriate content with a password protected Rating system (not all discs are rated).

- A. From Stop mode, press **SETUP**.
- B. Select Rating and press **ENTER**.
- C. Select Rating and press **ENTER** repeatedly to set the rating from 1 (most restrictive) to 8 (least restrictive).
If a password has already been set, the lock icon will be closed. You will not be able to select Rating until you select the correct password using the 0-9 keys.
- D. Select Password.
- E. Use the 0-9 keys to select a 4-digit password and press **ENTER**. The lock icon will close to indicate that the rating and password are set.
- F. Press **SETUP** to save and exit.

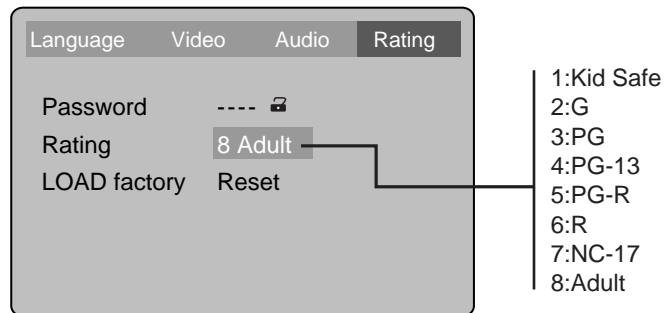

Not all DVDs are rated.

DVDs that are rated higher than the level you select will not play without SELECTING the correct password.

If you forget your Rating password, select 8888 to clear the memory. Keep this password out of reach of children, as it will always unlock the Parental Control setting.

POWER



- During playback, press **POWER** to stop the player and return to standby mode.
- While the player is in standby, press **POWER** or any key on the front panel to resume normal operation.

OPEN/CLOSE



- To open the disc tray, press **OPEN/CLOSE**.
- To Close the disc tray, press **OPEN/CLOSE** again

0-10+ Keys

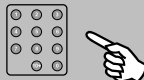

- These keys are used to input time, as well as title, chapter and track numbers.
- When a numeric item is displayed on the screen, press 0-10+ keys to select the desired entry, and press **ENTER** to confirm.

CLEAR



- Press **CLEAR** to delete numbers you have selected.
- Press once to delete on digit. Press and hold to delete all digits.

DISPLAY

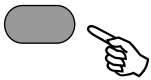

During playback, press **DISPLAY** to display the current time counter position.

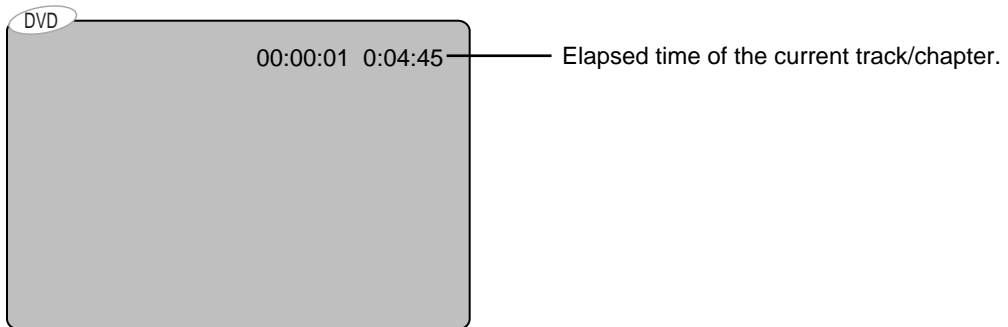

Press **DISPLAY** again to display additional information about the playing disc.

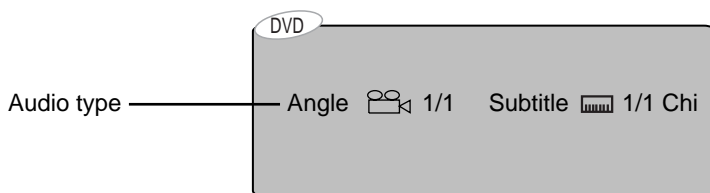
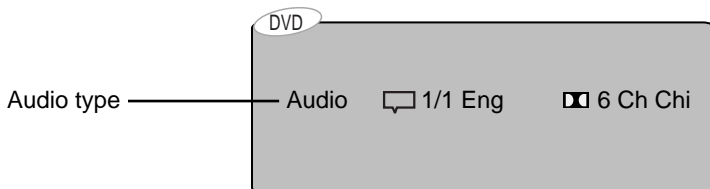
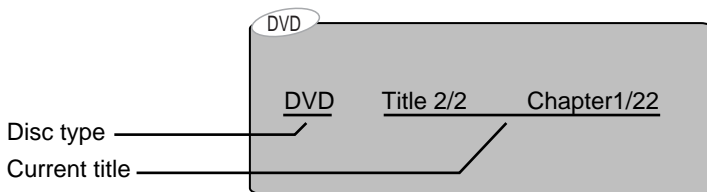
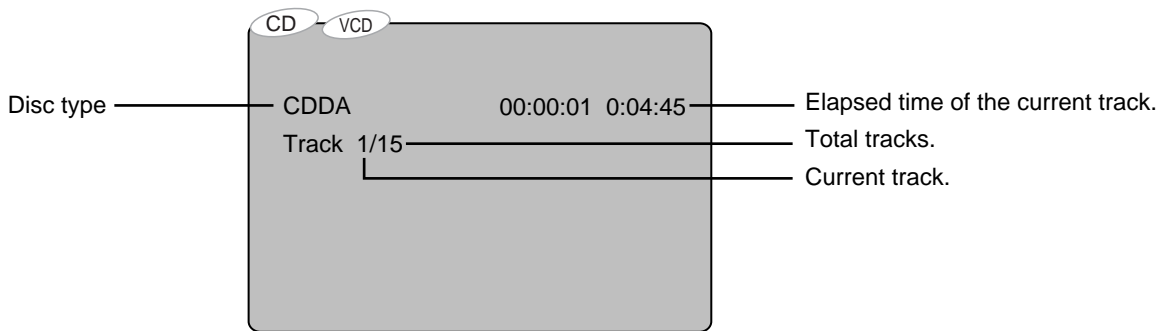

SEARCH

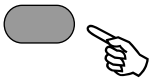

During playback, press **SEARCH**, and the [Track Search] menu will display as follows:

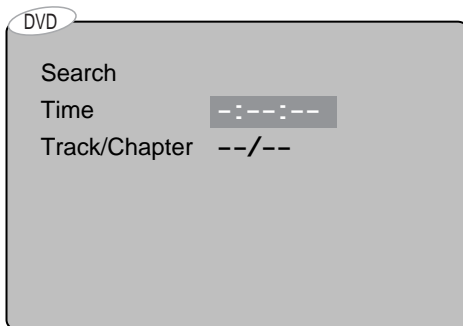
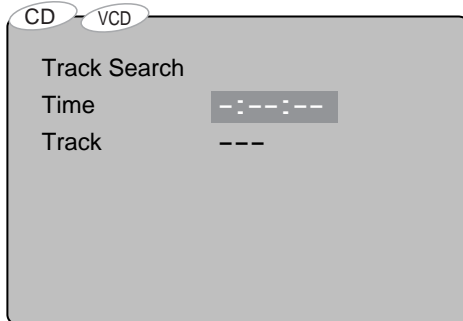

- Note:**
- ① Time searches for an exact time in the movie.
 - ② In Title/Chapter mode, you cannot select a value outside the range of the total number of titles or chapters.
 - ③ For some DVD discs, the Search Function is unavailable.

Use the number keys to input the desired Time, Title or Chapter, then press **ENTER** to confirm. Press **SEARCH** again, the [Disc Search] menu will be displayed as follows:

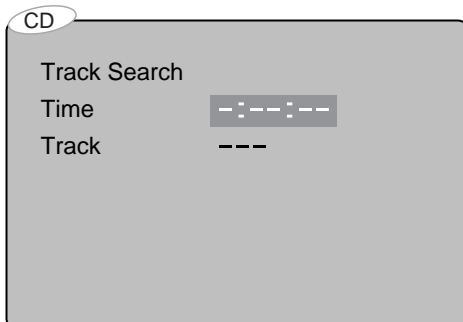



- During DVD or CD/VCD playback, press ►► once to play the next chapter, title or track.
- During DVD or CD/VCD playback, press and hold ►► to scan forward. The player will review the disc at 2, 4, 8 and 20 time normal speed as follows.



- Press **PLAY** to resume normal playback.



- During DVD or CD/VCD playback, press ◀◀ once to play the previous chapter, title or track.
- During DVD or CD/VCD playback, press and hold ◀◀ to scan in reverse. The player will review the disc at 2, 4, 8 and 20 time normal speed as follows.

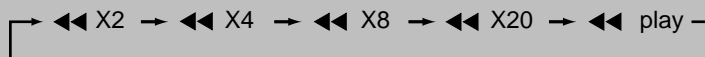

- Press **PLAY** to resume normal playback.

STOP



- Press **STOP** once during playback to stop and hold playback.
- Press **PLAY** to resume playback from the point you pressed **STOP**
- Press **STOP** twice to stop playback completely.

Note: The screen saver will automatically turn on if playback is stopped for about 5 minutes (when Screen Saver is set as on).

PAUSE



- Press **PAUSE** during playback to pause playback.

PLAY



Press **PLAY** from stop mode to start playback

This function is not available if the elapsed time of current track is less than 10 seconds.

Note: MP3 disc and some DVD discs do not have a 10 second review feature.

DISC MENU



- During DVD playback, press **MENU** to return to the program menu.
- In the Setup Menu, press **MENU** to return to the main menu or play mode.
- Any time, press **MENU** to cancel the current OSD or some menus.

Note: This function is subject to the discs.

TITLE

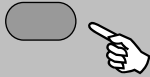

- During DVD playback, press **TITLE** key to display the DVD title menu or play the first title.

Note: This function is subject to the discs.

A-B



- During playback, press **A-B** to select A
- Press it again to select B. The player will repeat the section from A to B automatically.
- Press **A-B** a third time to cancel A-B repeat and clear points A and B.

Note: 1. During CD/SVCD playback, points A and B must be within the same track. During DVD playback, points A and B can be selected from different chapters.
2. This function is subject to the disc.

Please use the [PROG] mode under the state of stopping.
While [PROG] is on, press **ENTER** to display the [Program] submenu:

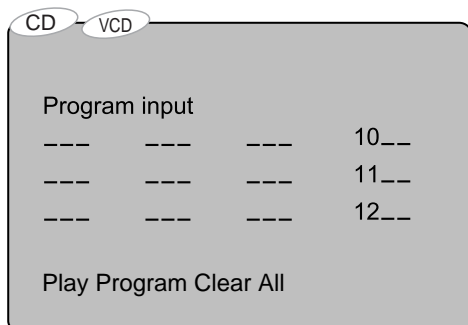

Input the track numbers in the order you would like them to play. When finished, select [Play Program] and then press **ENTER** to play tracks in the new programmed order.
Select [Clear All] and press **ENTER** to clear all the numbers you have input.

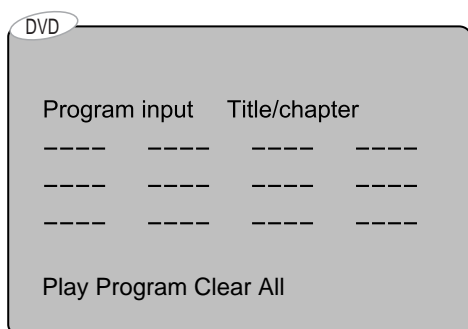

Input the title number and the chapter number in the desired order. Then select [Play Program] and press **ENTER** to play the chapters in the order you have set.
Select [Clear All] and press **ENTER** to clear all the numbers you have input.

PS/IS

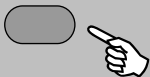

- When playback is stopped.
- Press **PS/IS** button twice to switch to progressive scan mode.
- Press **PS/IS** once to switch back to interlace scan mode.

Note: If you have connected the DVD player to your TV using the component Video Output, you can use PS/IS button to switch to progressive scan for superior video quality.

PREV



- Press PREV to skip to the previous chapter or track.

NEXT



- Press NEXT to skip to the next chapter or track.

N/P

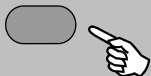

- Press **N/P** when in **STOP** mode to select the mode from **NTSC/PAL/AUTO**.

SLOW



- Press **SLOW** repeatedly to **SLOW DOWN** motion playback at variable speeds.

STEP



- Press **STEP** during playback to pause playback.
- Press **STEP** repeatedly to play frame.
- Press **PLAY** to resume normal playback.

REPEAT

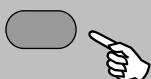

- Select to press **REPEAT** to select Repeat Title, Repeat chapter, Repeat off during DVD playback.
- Press **REPEAT** to select Repeat Single, Repeat All and Repeat off when PBC is off (VCD, CD, SVCD).

RETURN



- Press **RETURN** to the main menu when PBC is on.

VOL+ VOL-

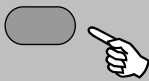

- Press Volume **<VOL+>** button to increase Volume.
- Press **<VOL->** button to reduce volume till no volume output.

PBC

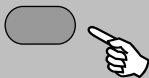

- During **VCD** playback.
- Press **PBC** (playback control) to select **PBC** On and off.

MUTE

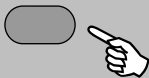

- Press **MUTE** to mute the Audio output.
- Press **MUTE** again to resume normal audio output.

ZOOM



- During VCD/SVCD/DVD playback, press **ZOOM** to magnify the image as follows:

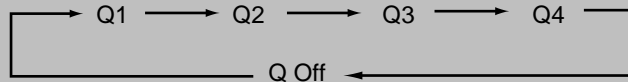

ANGLE



During DVD playback

- Press **ANGLE** to view scenes from different camera angles.
- Press **ANGLE** repeatedly to change from one camera angle to another.

Note: This function is disc specific.

AUDIO



- During CD/VCD/SVCD playback
 - Press **AUDIO** to select a audio channel (STEREO, LEFT, RIGHT etc)
- During DVD playback
- Press **AUDIO** repeatedly to select from up to 8 audio languages/formats.
- During SVCD playback
- Press **AUDIO** repeatedly to select from up to 4 audio languages/formats.
- Note:** This function is disc specific.

SUBTITLE



During DVD playback

- Press **SUBTITLE** repeatedly to select from up to 32 subtitle languages.

Note: This function is disc specific (languages will vary).

Supported formats

- Disc format: ISO9660, Joliet
- Music file format: MP3
- MP3 bit rate (data rate): 32 - 192 kbps
- Total number of music files and albums: around 350 per disc.
- Sampling rate: (CBR)32kHz/44.1kHz/48kHz/64kHz; (VBR) 16kHz/22kHz/24kHz/32kHz (MPEG)

Note: The player will not identify or play MP3 discs under the following conditions: recording format is not supported, badly scratched or deformed disc, MP3 recorded in CD-R or CD-RW which is not finalised, or a dirty pickup. When a MP3 disc is loaded, the screen will display as follows:

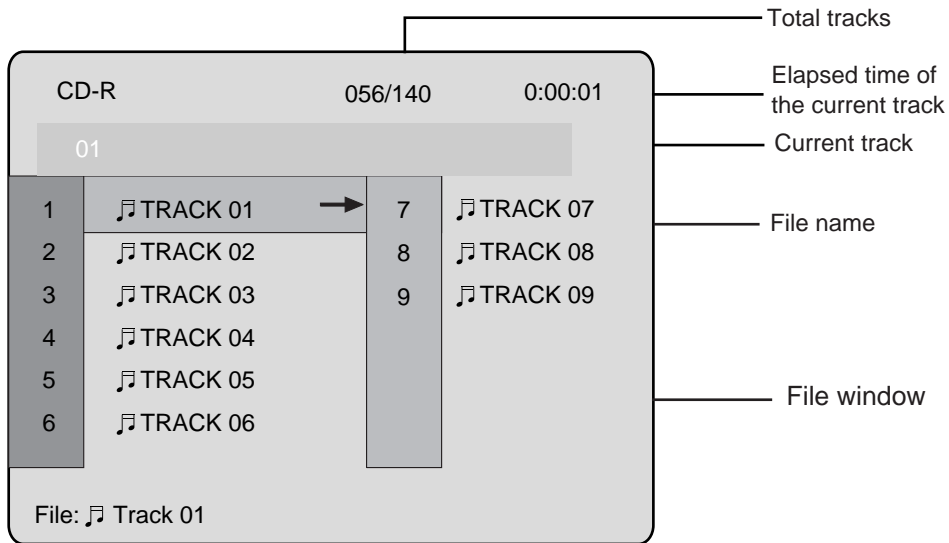

Press \uparrow \downarrow to select the file when the cursor appears in the file window

Press **ENTER** to play the current file selected by the cursor.

Press \leftarrow \rightarrow to switch between the directory window and the file window.

Note: During MP3 playback, **Forward Scan** and **Reverse Scan** are not available.

The introduction of KODAK PICTURE CD

A Kodak Picture CD has the size and shape of a regular CD. You can order a KODAK Picture CD simply by checking the box on the photo finishing envelope when you drop off a roll of film (35mm or Advanced Photo System (APS) colour print film) at the time of processing in Kodak Express store displaying "Kodak Picture CD" sign. When your order is returned, you receive your prints, negatives, and your full roll of pictures safely stored on your KODAK Picture CD. Each KODAK Picture CD brings you the tools to enhance, share and manage your pictures on your computer. You also can record the JPEG picture into CD-R or CD-RW with the CD-Rewriter yourself.

- Note:** 1. The Max. Size of JPEG Picture can be supported: 3840 x 3840 pels.
2. JPEG stands for Joint Picture Experts Group. It is the first International Standard on Still Picture Compressing: ISO 10918-1, constituted by the Committee on Still Picture Compressing Standard of ISO. The pictures on KODAK Picture CD are stored in this format (JPEG). This player can decode the JPEG pictures in KODAK Picture CD and playback the pictures in different modes.

Now, you can playback Kodak Picture CDs on this player and view your wonderful pictures on your TV in the comfort of your living room.

When a Kodak Picture CD is inserted on a player an automatic slide show is launched. Each picture in the Kodak Picture CD will be displayed consecutively in a slide show fashion and will be scaled to fit in the whole TV screen.

General function:

- You can set slide show transition modes for any pictures.
- Press **PAUSE** to stop playing.
- Press **◀◀** or **▶▶** key to continue slide show transition.
- Press **PLAY** key to continue slides how transition.
- Press **STOP** to return to root menu.

Zoom Function:

This player provides both Zoom in/out and Zoom pan function. Press the **ZOOM** consecutively, the picture will zoom in/out in turn as follows:

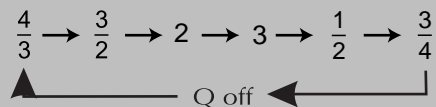

- Note:** During the ZOOM function, slide show transitions and image rotation are disabled.
Q off: close zoom, press **PLAY** again to resume slide show transition mode.

Insert batteries

1 1. Open the cover.

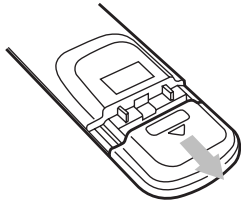

2 2. Insert batteries.

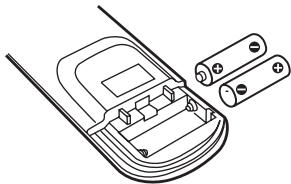

Make sure to match the "+" and "-" of the batteries with the marks inside the battery compartment.

3 3. Close the cover.

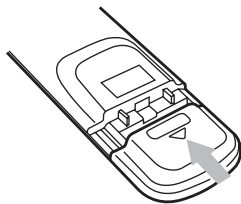

Notes:

Improper use of batteries may cause battery leakage and corrosion. To operate the remote controller correctly, follow the instruction below.

- Do not insert batteries in the wrong direction.
- Do not charge, heat, open, or short-circuit the batteries.
- Do not throw batteries into a fire.
- Do not leave dead batteries in the Remote Control.
- Do not use different types of batteries together or mix old and new batteries.
- If you do not use the remote control for a long period of time, remove the batteries to avoid possible damage from battery corrosion.
- If the remote control does not function correctly or the operating range become reduced, replace all batteries with new ones.
- If battery leakage occurs, clean the battery compartment, then insert new ones.

Using the remote control

Point the remote control at the remote sensor.

(The pictures are only for reference)

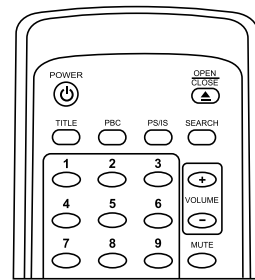
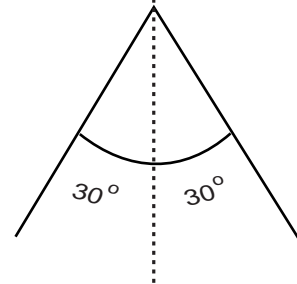
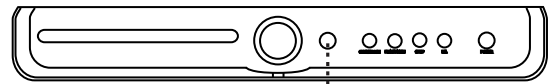

Remarks: Do not expose the remote sensor of the DVD Player to strong light source such as direct sunlight.

Notes:

- Point the remote control at the players remote sensor.
- Do not leave the remote control near an extremely hot or humid place.
- Do not spill water or put anything wet on the remote control.
- Battery life is 1 year under normal conditions.

Please read the user's manual carefully before using the DVD player. If you are having any troubles in using this player, try to solve the problems by the suggestions mentioned below. If you can not correct the trouble after using all the suggestions, please contact our company or the technical service centre authorised by us. For your safety, DO NOT open the cover and attempt to repair the player yourself, it may cause electric shock.

NO PICTURE OR SOUND

- Ensure that the power button is on.
- Ensure that the wall outlet is operational.
- Ensure that the power cord is not damaged.
- Ensure that the power plug is connected firmly to the outlet.

PICTURE BUT NO SOUND

- Ensure the audio jacks are securely connected.
- Ensure the audio connector is not damaged.
- Ensure the volume is turned up in VOL/CH setup.
- Ensure you have set the player's AUDIO settings correctly
- Ensure you have ENTERED the correct AV input for your TV.
- Ensure that the audio is not set mute.

SOUND BUT NO PICTURE

- Ensure the video are securely connected.
- Ensure you have ENTERED the correct AV input for your TV.
- Ensure the video connector is not damaged.
- Ensure you have set the player's VIDEO settings correctly.

POOR PICTURE OR SOUND

- Ensure you have set the player's of AUDIO settings correctly.
- Ensure the disc is scratched or stained.
- Ensure the AV connector or the output terminal is not damaged.

"BAD DISC" DISPLAYED

- Ensure the disc is not warped, damaged or deformed.
- Ensure that the disc is not stained or damaged badly.
- Ensure that the disc format is compatible to the player.
- Please check whether you have tried to play a software CD, if so, please restart the player.

REMOTE NOT WORKING

- Ensure the remote batteries are working.
- Point the remote control directly at the player's IR sensor.
- Remove any obstacles between the remote and the IR sensor.

UNIT NOT WORKING

- Turn off the power, and then turn on again

NO DISC DISPLAYED

- Ensure you have put the disc on the tray.
- Ensure the disc is not upside down.
- Ensure the disc is not distorted, stained or scratched.

Specifications

Power Requirements: 110-240V, 50/60Hz
Power Consumption: 15W
Video Standard: NTSC/PAL/AUTO
Unit Weight: 4.0lbs (1.8kg)

[Accessories]

Video/Audio cable x1
Remote Control x 1
User's Manual x 1
AAA Battery x 2

Specifications are subject to change without notice.
Weight and dimensions are approximate.

Video out

Video out: 1.0V(p-p)/75Ω, sync, negative polarity, RCA-pin Jack x1
S-Video output connector (separate Y, C signal output connectors)
Y output: 1.0V(p-p)/75Ω, sync, negative polarity
C output: 0.286V(p-p)/75Ω

Audio out

5.1 channel out: 1.85V(rms)/10KΩ, RCA pin jack (FL, FR, SL, SR
CEN, SW) x 6
Coaxial out: 0.5V(p-p)/75Ω, RCA pin jack x 1

Frequency response: 20Hz to 20KHz
S/N ratio: >90dB
Total harmonic distortion: <0.05%

This product incorporates copyright protection technology that is protected by method claims of certain U.S. patents and other intellectual property rights owned by Macrovision Corporation and other rights owners. Use of this copyright protection technology must be authorised by Macrovision Corporation, and is intended for home and other limited viewing uses only unless otherwise authorised by Macrovision Corporation. Reverse engineering or disassembly is prohibited.

PALSONIC CORPORATION PTY LTD
1 JOYNTON AVENUE
WATERLOO NSW 2017 AUSTRALIA
TEL: (02) 9313 7111
FAX: (02) 9313 7555
www.palsonic.com.au

**PALSONIC CUSTOMER SERVICE
TELEPHONE
AUSTRALIA: 1300 657 888**

Free Manuals Download Website

<http://myh66.com>

<http://usermanuals.us>

<http://www.somanuals.com>

<http://www.4manuals.cc>

<http://www.manual-lib.com>

<http://www.404manual.com>

<http://www.luxmanual.com>

<http://aubethermostatmanual.com>

Golf course search by state

<http://golfingnear.com>

Email search by domain

<http://emailbydomain.com>

Auto manuals search

<http://auto.somanuals.com>

TV manuals search

<http://tv.somanuals.com>