

Palsonic

DVD R 313 DVD RECORDER

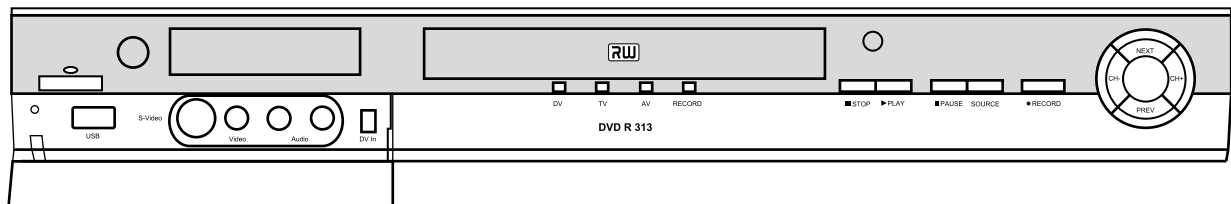

PALSONIC CORPORATION PTY LTD
1 JOYNTON AVENUE
WATERLOO NSW 2017 AUSTRALIA
TEL: (02) 9313 7111
FAX: (02) 9313 7555
www.palsonic.com.au

**PALSONIC CUSTOMER SERVICE
TELEPHONE
AUSTRALIA: 1300 657 888**



Safety Precautions



The lightning flash with an arrowhead symbol within an equilateral triangle is intended to alert the user to the presence of uninsulated "dangerous voltage" within the product's enclosure that may be of sufficient magnitude to constitute a risk of electric shock to persons.



The exclamation point within an equilateral triangle is intended to alert the user to the presence of important operating and maintenance (servicing) instructions in the literature accompanying the appliance.

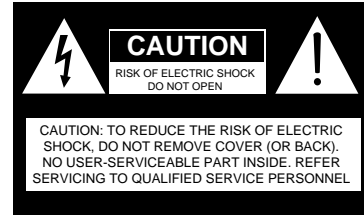

WARNING: **DO NOT EXPOSE THIS APPLIANCE TO RAIN OR MOISTURE, DUE TO THE HIGH RISK OF FIRE OR ELECTRIC SHOCK, DO NOT OPEN THE CABINET DANGEROUS HIGH VOLTAGES ARE PRESENT INSIDE THE ENCLOSURE. ONLY QUALIFIED SERVICE PERSONNEL SHOULD ATTEMPT THIS.**

CAUTION: **TO PREVENT ELECTRIC SHOCK, MATCH WIDE BLADE OF PLUG TO WIDE SLOT, AND FULLY INSERT.**

CAUTION: This Digital Video Disc Player employs a Laser System. To prevent direct exposure to the laser beam, do not try to open the enclosure.
Visible laser radiation emits when open and interlocks are defeated.
Use of controls or adjustments or performance of procedures other than those specified herein may result in hazardous radiation exposure.
DO NOT STARE INTO BEAM.

To ensure proper use of this product, please read this owner's manual carefully and retain for future reference. Should the unit require maintenance, contact an authorised service location, or contact us. Only qualified service personnel should remove the cover.

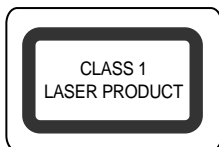

Since it is very usual for DVD movies to be released at different times in different regions of the world, all players have region codes and disks can have an optional region code. If you load a disk of a different region code to your player, you will see the region code notice on the screen. The disk will not play, and should be unloaded.

Safety Information

CAUTION: Use of controls or adjustments or performance of procedures other than those specified herein may result in hazardous radiation exposure. Please carefully study this manual and always keep it available. There are, however, some installation and operation precautions which you should be aware of.

1. Read Instructions - All the safety and operating instructions should be read before the product is operated.
2. Retain Instructions - The safety and operating instructions should be retained for future reference.
3. Heed Warnings - All warnings on the product and in the operating instructions should be adhered to.
4. Follow Instructions - All operating and use instructions should be followed.
5. Cleaning - Unplug this product from the wall outlet before cleaning. Do not use liquid cleaners or aerosol cleaners. Use a damp cloth for cleaning.
6. Attachments - Do not use attachments not recommended by the product manufacturer as they may cause hazards.
7. Water and Moisture - Do not use this product near water - for example, near a bath tub, wash bowl, kitchen sink, or laundry tub; in a wet basement; or near a swimming pool; and the like.
8. Accessories - Do not place this product on an unstable cart, stand, tripod, bracket, or table. The product may fall, causing serious injury to a child or adult, and serious damage to the product. Use only with a cart, stand, tripod, bracket, or table recommended by the manufacturer, or sold with the product. Any mounting of the product should follow the manufacturer's instructions, and should use a mounting accessory recommended by the manufacturer.
9. A product and cart combination should be moved with care. Quick stops, excessive force, and uneven surfaces may cause the product and cart combination to overturn.
10. Ventilation - Slots and openings in the cabinet are provided for ventilation and to ensure reliable operation of the product and to protect it from overheating, and these openings must not be blocked or covered. The openings should never be blocked by placing the product on a bed, sofa, rug, or other similar surface. This product should not be placed in a built-in installation such as a bookcase or rack unless proper ventilation is provided or the manufacturer's instructions have been adhered to.
11. Power Sources - This product should be operated only from the type of power source indicated on the marking label. If you are not sure of the type of power supply to your home, consult your product dealer or local power company. For products intended to operate from battery power, or other sources, refer to the operating instructions.

12. Grounding or Polarisation - This product may be equipped with a polarised alternating-current line plug (a plug having one blade wider than the other). This plug will fit into the power outlet only one way. This is a safety feature. If you are unable to insert the plug fully into the outlet, try reversing the plug. If the plug should still fail to fit, contact your electrician to replace your obsolete outlet. Do not defeat the safety purpose of the polarised plug.

Alternate Warnings - This product is equipped with a three-wire grounding-type plug, a plug having a third (grounding) pin. This plug will only fit into a grounding-type power outlet. This is a safety feature. If you are unable to insert the plug into the outlet, contact your electrician to replace your obsolete outlet. Do not defeat the safety purpose of the grounding-type plug.

13. Power-Cord Protection - Power-supply cords should be routed so that they are not likely to be walked on or pinched by items placed upon or against them, paying particular attention to cords at plugs, convenience receptacles, and the point where they exit from the product.

14. Protective Attachment Plug - The product is equipped with an attachment plug having overload protection. This is a safety feature. See Instruction Manual for replacement or resetting of protective device. If replacement of the plug is required, be sure the service technician has used a replacement plug specified by the manufacturer that has the same overload protection as the original plug.

15. Outdoor Antenna Grounding - If an outside antenna or cable system is connected to the product, be sure the antenna or cable system is grounded so as to provide some protection against voltage surges and built-up static charges. Article 810 of the National Electrical Code, ANSI/NFPA 70, provides information with regard to proper grounding of the mast and supporting structure, grounding of the lead-in wire to an antenna discharge unit, size or grounding conductors, location of antenna-discharge unit, connection to grounding electrodes, and requirements for the grounding electrode.

16. Lightning - For added protection for this product during a lightning storm, or when it is left unattended and unused for long periods of time, unplug it from the wall outlet and disconnect the antenna or cable system. This will prevent damage to the product due to lightning and power-line surges.

17. Power Lines - An outside antenna system should not be located in the vicinity of overhead power lines or other electric light or power circuits, or where it can fall into such power lines or circuits. When installing an outside antenna system, extreme care should be taken to keep from touching such power lines or circuits as contact with them might be fatal.

18. Overloading - Do not overload wall outlets, extension cords, or integral convenience receptacles as this can result in a risk of fire or electric shock.

19. Object and Liquid Entry - Never push objects of any kind into this product through openings as they may touch dangerous voltage points or short-out parts that could result in a fire or electric shock. Never spill liquid of any kind on the product.

20. Servicing - Do not attempt to service this product yourself as opening or removing covers may expose you to dangerous voltage or other hazards. Refer all servicing to qualified service personnel.

21. Damage Requiring Service - Unplug this product from the wall outlet and refer servicing to qualified service personnel under the following conditions:

- a. When the power-supply cord or plug is damaged.
- b. If liquid has been spilled, or objects have fallen into the product.
- c. If the product has been exposed to rain or water
- d. If the product does not operate normally by following the operating instructions. Adjust only those controls that are covered by the operating instructions as an improper adjustment of other controls may result in damage and will often require extensive work by a qualified technician to restore the product to its normal operation.
- e. If the product has been dropped or damaged in any way, and
- f. When the product exhibits a distinct change in performance - this indicates a need for service.

22. Replacement Parts - When replacement parts are required, be sure the service technician has used replacement parts specified by the manufacturer or have the same characteristics as the original part. Unauthorised substitutions may result in fire, electric shock, or other hazards.

23. Safety Check - Upon completion of any service or repairs to this product, ask the service technician to perform safety checks to determine that the product is in proper operating condition.

24. Wall or Ceiling Mounting - The product should be mounted to a wall or ceiling only as recommended by the manufacturer.

25. Heat - The product should be situated away from heat sources such as radiators, heat registers, stoves or other products (including amplifiers) that produce heat.

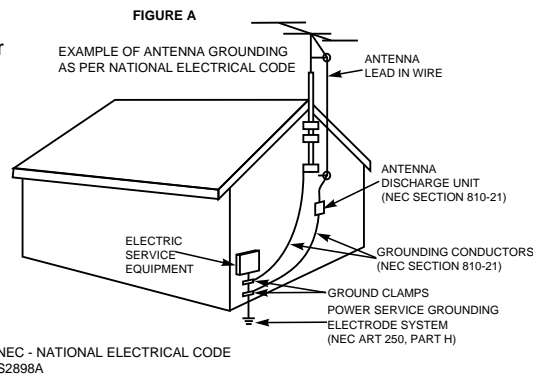

Introduction

Your DVDR313 design combines the function a quality of a DVD player and recorder. As a DVD player, you will be able to enjoy full length movies with true cinema picture quality, and stereo or multichannel sound (depending on the disc and your playback system). Unique features of this player include YUV & S-video outputs for greater picture quality.

What's more, as a DVD Video Recorder, it has some of the key features that allow you to record programs conveniently such as:

- A complete DVD+R/DVD+RW/DVD-R/DVD-RW recorder.
- Preset recording
- Playback of pre-recorded or user-recorded DVDs and CDs
- View, edit and play from a pre-recorded DVD+RW/DVD-RW.

UNPACKING

When shipping the player, the original shipping carton and packing comes in handy. For maximum protection, re-pack the unit as it was originally packed at the factory. It is normal for your changer tray to partially open after you have unpacked the unit. This is a feature designed to allow easier access to disc inside the tray during diagnostics.

First check and identify the contents of your player package, as listed below:

- DVDR313
- Remote control
- RCA cables (3) x 2 (1 yellow, 1 red, 1 white)
- Owner's manual
- Size AAA batteries (2)

If any item should be damaged or missing, please inform your supplier without delay. Keep the packaging materials as you may need them to transport your player in the future.

WHERE TO PLACE YOUR DVD RECORDER

1. Place the unit on a firm, flat surface.
2. When you place this player near a radio or VCR the playback picture may become poor and/or distorted. In this situation, move the DVD video player away from the other units.
3. Keep away from direct sunlight & domestic heating equipment.
4. If placed in a cabinet, please allow at least 2.5 cm (1 inch) of free space around the player for proper ventilation.

TO OBTAIN A CLEAR PICTURE

This player is a high-tech, precision device. If the optical pick-up lens and disc drive parts are dirty or worn down, the picture quality will become poor. To obtain a clear picture, we recommend regular inspection and maintenance (i.e. cleaning or parts replacement) every 1,000 hours of use depending on the operating environment. For details, please contact your nearest dealer.

Table of Contents

Safety Precautions	1	Using the On-screen Display	24
Safety Information	2	Setting the Parental Lock	25
Introduction	3	Customising DVD Function Settings	26
Table of Contents	4	Recording Options	27
Caution	5	Channel Search	27
Identification of Controls	6	Setup Record Quality	27
Operating instructions of the remote controller	8	Record Normal Record	27
Connection	9	Recording Options	28
MP3 & Progressive Scan	13	One-Touch Record	28
Playing Back a Disc	14	Time Record	29
Playing a Normal Disc	14	Editing	30
Playing a DVD+R or DVD+RW or DVD-R or DVD-RW Disc	14	Editing a Title of DVD+RW or DVD-R	30
General Features	15	Chapter Editing	31
Locating a Specific Title/ Chapter/Track	17	Title Icon A Split Title	32
Playing Repeatedly	19	Editing a Disc of DVD+R or DVD+RW or DVD-R or DVD-RW	33
Playing USB/DV	20	Specifications	34
Selecting Camera Angles/Language & Audio Settings	21	Trouble Shooting Guide	35
Playing in a Favourite Order	22		
Selecting Subtitles	23		

CAUTION

1. To prolong the life of your equipment, please do not use scratched, dusty or poor quality discs.

2. You will need to FINALISE a disc after recording, to play on other equipment. You cannot record or make changes to a disc once it is FINALISED. Please keep the disc clean at all times to prevent damage.

3. You cannot record more than one type of format on one disc. (i.e. NTSC or PAL cannot be recorded on the same disc.)

4. A DVD+RW is a + Rewritable disc, which can be recorded on repeatedly.

5. To prevent damage to a disc, do not turn the power off or perform other functions, while editing.

6. Your DVD RECORDER cannot record from the following:

- Videotapes with copyright protection
- DVD's with copyright protection
- Cable TV broadcasts with copyright protection

Identification of Controls

FRONT PANEL

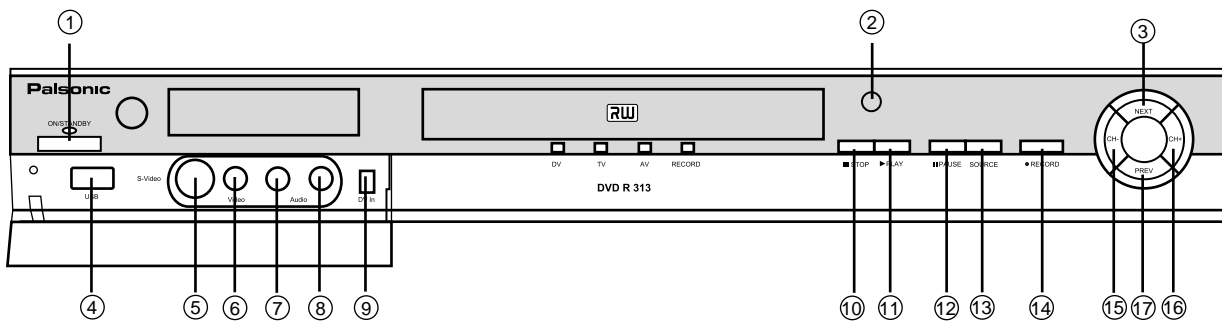

- | | |
|----------------------------------|--------------|
| 1. STANDBY/ON | 10. STOP |
| 2. OPEN/CLOSE | 11. PLAY |
| 3. NEXT | 12. PAUSE |
| 4. USB | 13. SOURCE |
| 5. S-VIDEO INPUT (FRONT) | 14. RECORD |
| 6. COMPOSITE VIDEO INPUT (FRONT) | 15. CHANNEL- |
| 7. AUDIO INPUT (FRONT LEFT) | 16. CHANNEL+ |
| 8. AUDIO INPUT (FRONT RIGHT) | 17. PREVIOUS |
| 9. DIGITAL VIDEO INPUT | |

REAR PANEL

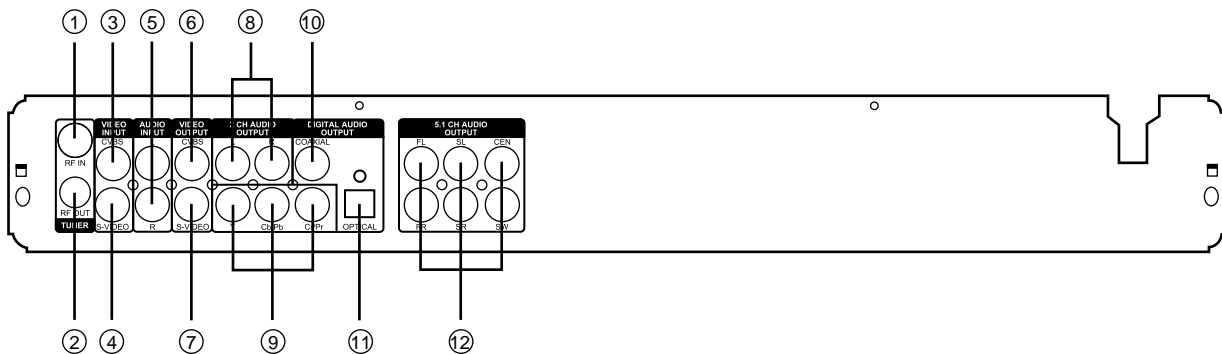

- | | |
|----------------------------------|--|
| 1. RF SIGNAL INPUT | 8. AUDIO OUTPUT (MIXED) |
| 2. RF SIGNAL OUTPUT | 9. COMPONENT OUTPUT FOR PROGRESSIVE SCAN |
| 3. COMPOSITE VIDEO INPUT (REAR) | 10. DIGITAL AUDIO-COAXIAL OUTPUT |
| 4. S-VIDEO INPUT (REAR) | 11. DIGITAL AUDIO- OPTICAL OUTPUT |
| 5. AUDIO INPUT (REAR LEFT/RIGHT) | 12. 5.1 CH AUDIO OUTPUT |
| 6. COMPOSITE VIDEO OUTPUT | |
| 7. S-VIDEO OUTPUT | |

Identification of Controls

REMOTE CONTROL

THE INSTRUCTIONS BELOW DESCRIBE THE FUNCTIONS OF THE REMOTE CONTROL

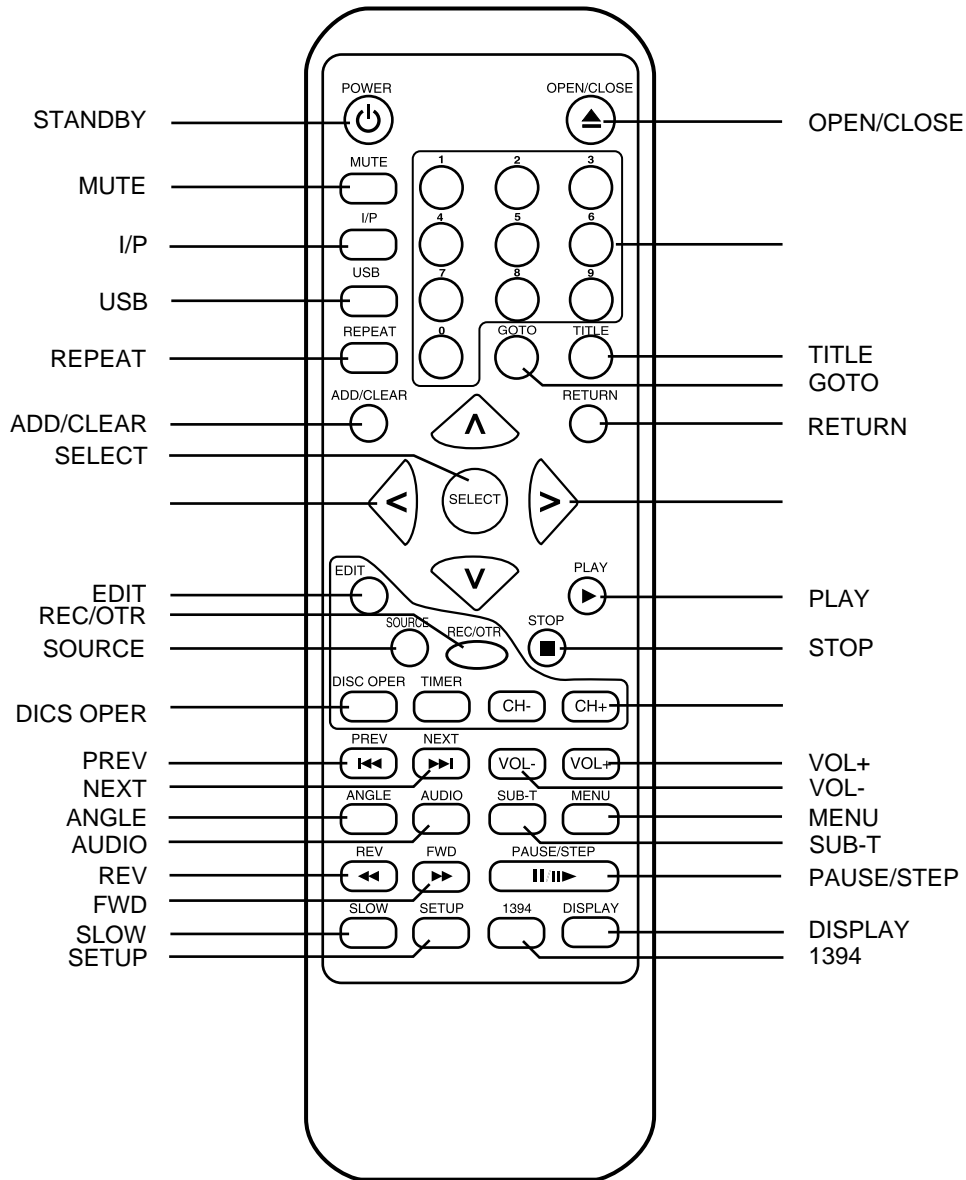

OPERATING INSTRUCTIONS OF THE REMOTE CONTROLLER

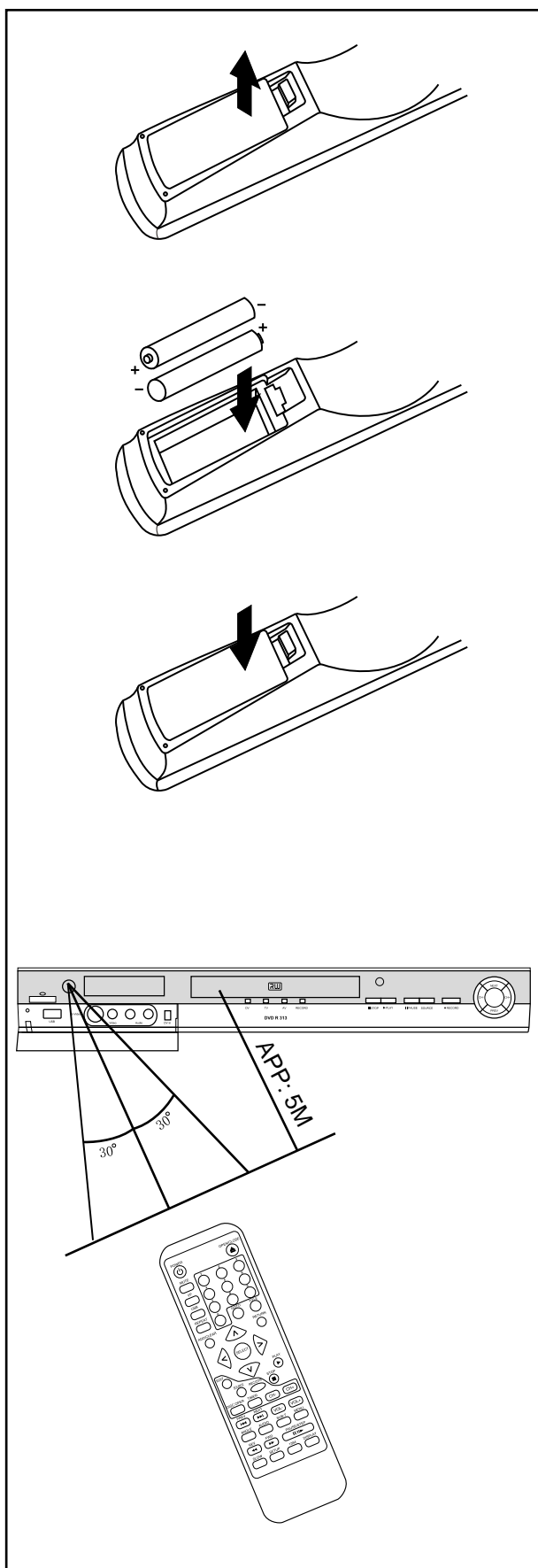

Battery Installation

1. Push the leaf spring down and out to remove the battery compartment cover.
2. Insert two size AA batteries according to the "+" and "-" markings.
3. Make sure the batteries have been properly installed, then close the battery compartment cover.

Notes:

Do not mix different types together, or old batteries with new batteries.

If the remote control will not be used for an extended period of time, remove the batteries to prevent corrosion.

To prevent corrosion resulting in damage, remove exhausted batteries immediately. When the remote control appears not to operate normally, replace both batteries.

Typical life for the batteries provided with this product is about 6 months. The life expectancy may vary according to the use status.

Use of the remote controller

Point the remote controller toward the remote sensor on your DVD home theatre centre. Upon receipt of the signal from the remote controller, the equipment will operate accordingly.

The description in this Manual is based on the buttons on the equipment. You may use the counterparts on the remote controller to do the same.

Notes:

Do not place this equipment in a place exposed to direct sunlight or strong light source like inverting fluorescent light, or else it may interfere with correct operation of the remote controller.

When other similar remote controller is used in the same room, or when this product is used near other equipment using infrared ray, interference with the operation of this remote controller may occur.

Do not place any object on the remote controller, or else it may cause unintentional depression of the buttons and waste the batteries unnecessarily.

The front of the chassis should not be glazed with colour glass, or else it may cause interference with normal operation of the remote controller.

Any barrier between the remote controller and remote sensor will inactivate any operation of the remote controller.

The operating range between the remote controller and the equipment shall be no more than 5 meters (16 inches). When the operating range becomes shorter, replace the batteries with new ones.

Connection

CONNECTION FOR AUDIO OUTPUT

Dolby Pro Logic Surround Sound (GOOD)

Enjoy Dolby Pro Logic Surround by connecting an amplifier and speaker system (right and left front speakers, a centre speaker and subwoofer).

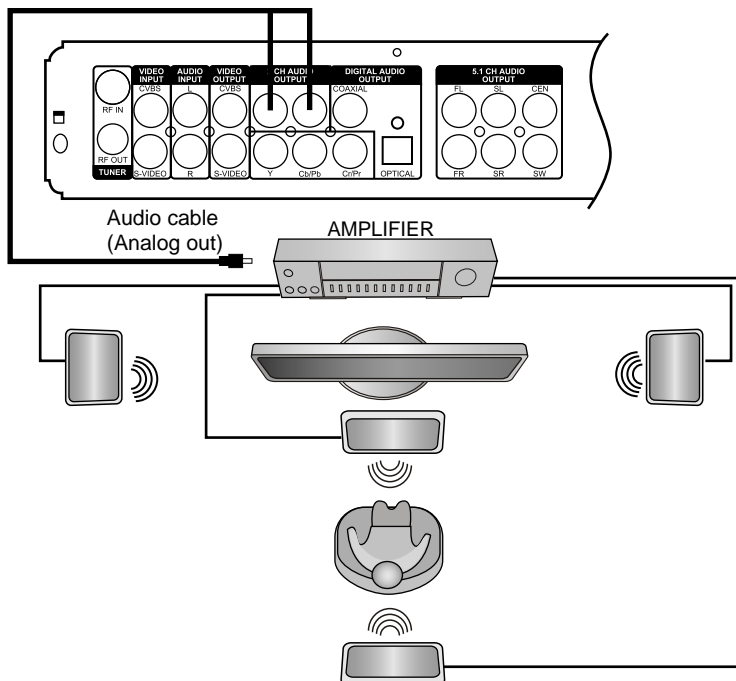

Enjoying Digital Stereo Sound (BETTER)

Enjoy the dynamic sound of Digital Stereo by connecting an amplifier equipped with a digital audio input and speaker system (right and left front speakers, a centre speaker, and one subwoofer speaker, and two rear speakers)

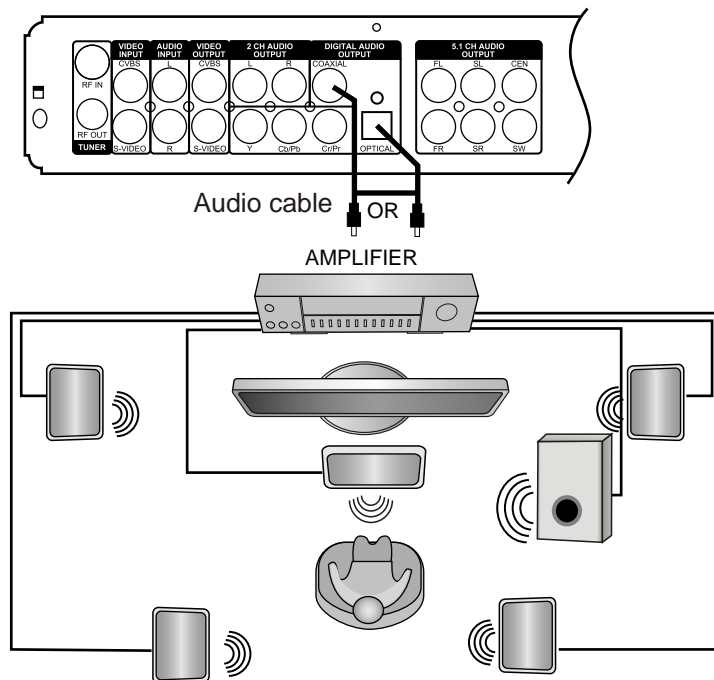

Connection

CONNECTION FOR VIDEO OUTPUT

GOOD

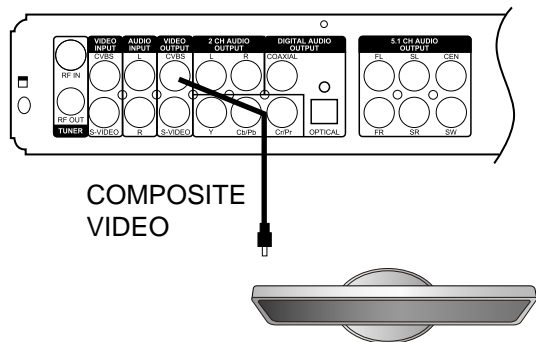

BETTER

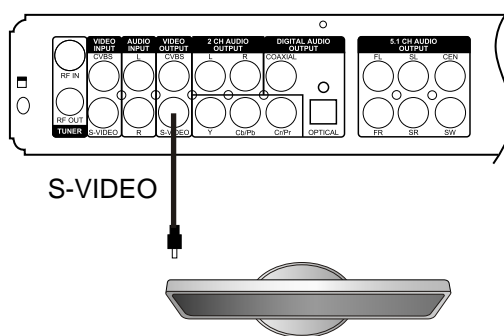

Connect your recorder with the S-Video cable, if the TV has an S-Video input. Do not connect the yellow video cable if you are using the S-Video cable.

COMPONENT/ PSCAN CONNECTION (BEST)

Do not connect the Yellow video cable or S-video cable of using the Component cables.

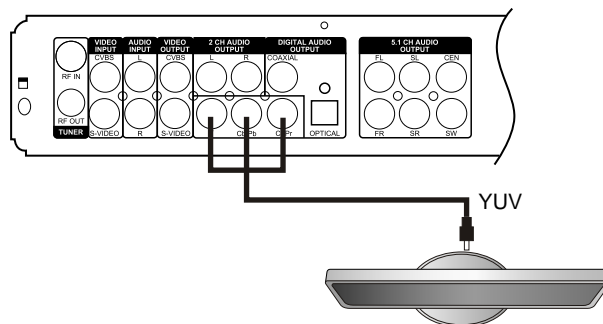

CONNECTIONS FOR TV TUNER

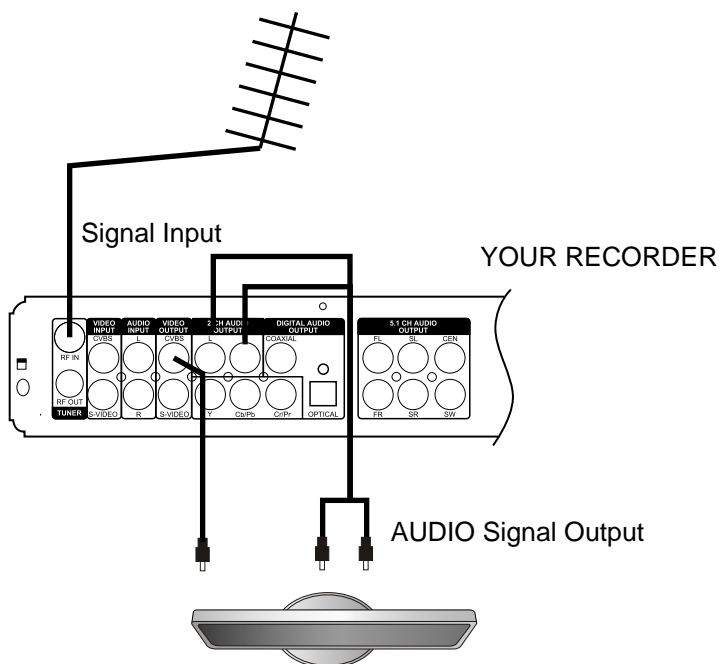

NOTE

- Refer to the manual of the connected TV
- Turn off the power and unplug both units before setting up any connections..

Connection

THE RECORDER ALLOWS YOU TO ENJOY OR RECORD PROGRAMS WITH SIGNAL FROM AV SYSTEMS SUCH AS VCR, DVD PLAYER, ETC.

CONNECTION FOR AV SIGNAL (A/V REAR INPUT)

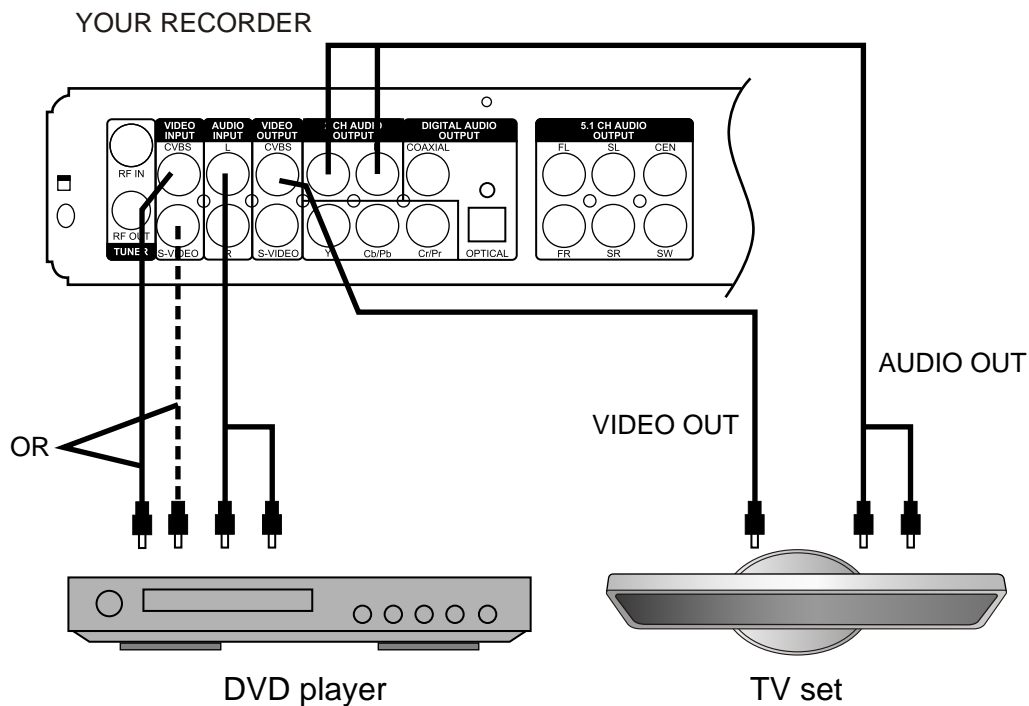

Connect your recorder with the S-Video cable, if the Signal Source has an S-Video input. Do not connect the yellow video cable if using the S-Video cable.

NOTE

- Refer to the manual of the connected system.
- Turn off the power and unplug both units before setting up any connections.

Connection

CONNECTION FOR AV SIGNAL (AV FRONT INPUT)

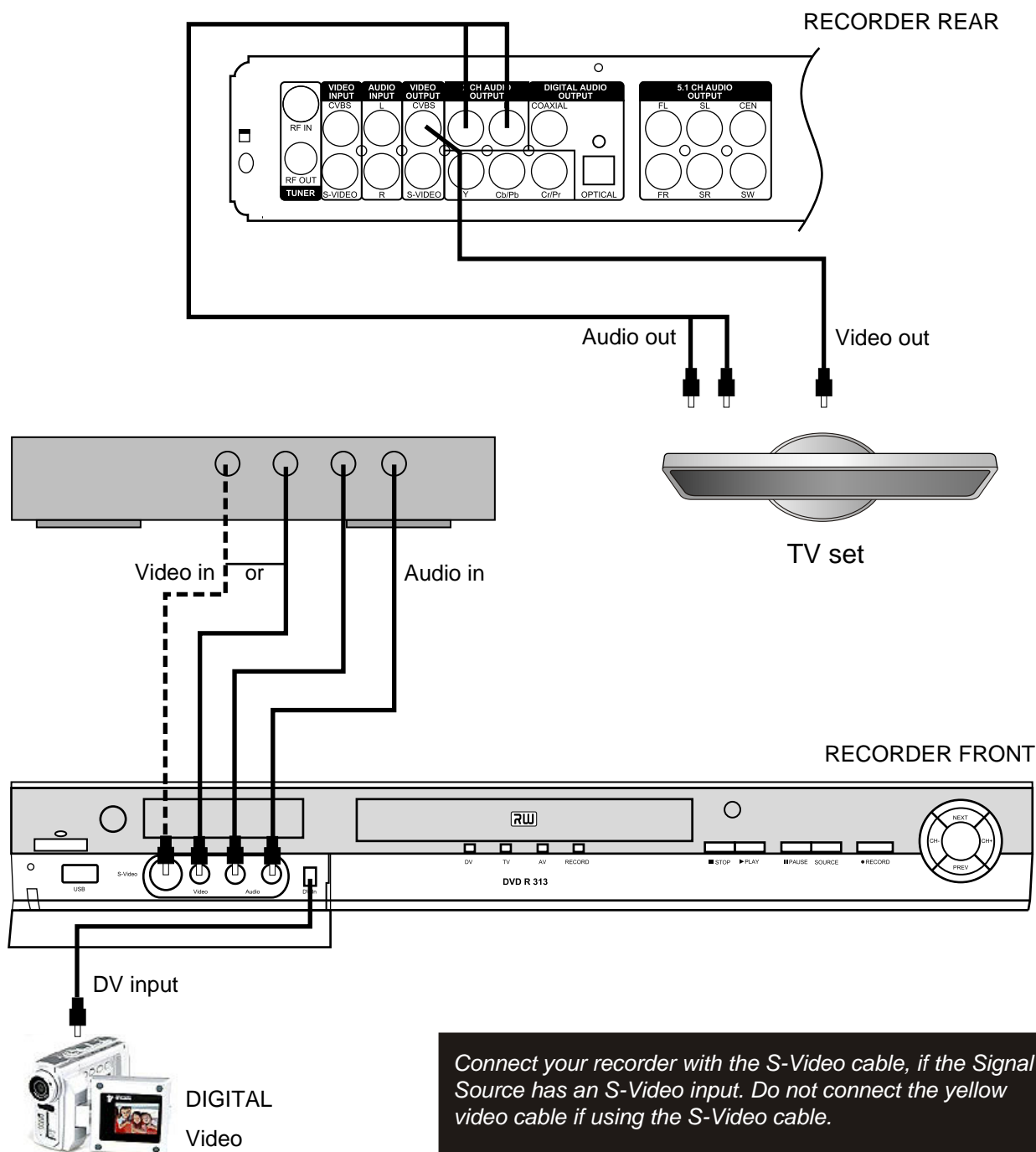

NOTE

- Refer to the manual of the connected system.
- Turn off the power and unplug both units before setting up any connections.

MP3 & Progressive Scan

WHAT IS MP3?

MP3 refers to a new format of music files available for playback over the internet. The popularity of MP3 allows people to download music from MP3 websites onto ones home computer.

WHAT IS PROGRESSIVE SCAN?

Progressive Scan creates a picture with double the scan lines of traditional component video pictures and creates a sharper image. The advantages of progressive scan video output are reduced picture flickering and motion artifacts as well as a sharper image on large screens.

Playing Back a Disc

PLAYING A NORMAL DISC

1. Power on your recorder.
2. Insert a DVD disc.
3. Press Directional Keys or the number buttons to select the title.

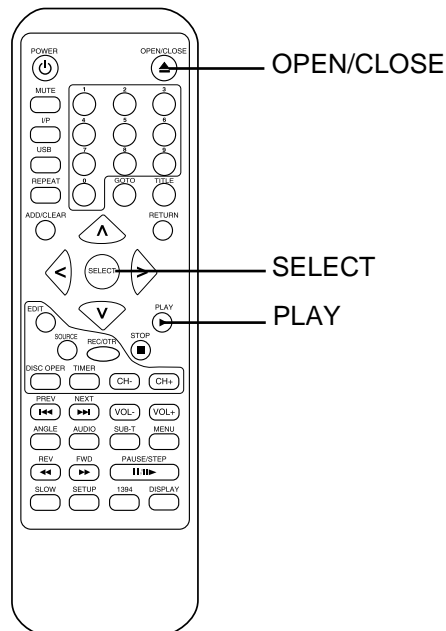

4. Press the **SELECT** or **PLAY** button.
The DVD video player will start playback from the title selected.
5. To remove the disc, press the **OPEN/CLOSE** button.

PLAYING A DVD+R OR DVD+RW OR DVD-R OR DVD-RW DISC

Index Picture Screen

	1. TITLE 01/01/00 12:03:47 SP00:00:20
	1. TITLE 01/01/00 12:06:50 HQ00:00:20
	1. TITLE 01/01/00 12:08:57 SLP00:00:20

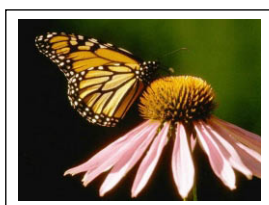

Description:

1. The name of the pre-recorded. The default is TITLE.
2. The date and time of the recording.
3. Title time of the recording.
4. The quality.
5. Length of the recording

1. ___ 1. TITLE
2. ___ 01/01/00
3. ___ 12:03:47
4. ___ SP 00:00:20
5. ___

Playing Back a Disc

PLAYING A DVD+R OR DVD+RW OR DVD-R OR DVD-RW DISC

1. Power on the Reorder.

2. Insert a DVD+R or DVD+RW or DVD-R or DVD-RW disc

The index pictures will appear on the screen.

3. Press the OPEN/CLOSE button

This will open the disc tray and allow for the placement of a playable disc with the playback side down.

4. Choose direction keys (UP/DOWN/RIGHT/LEFT)

To highlight the corresponding items.

5. Press SELECT or PLAY to start playback of the title you selected.

6. Stop playback

Press the STOP button once to stop the player; press the PLAY button to resume.

If from the start, press the STOP button twice then press the PLAY button.

Note:

After finishing playback all titles contained on a DVD+R or DVD+RW or DVD-R or DVD-RW disc, it will return to the Index Picture Screen.

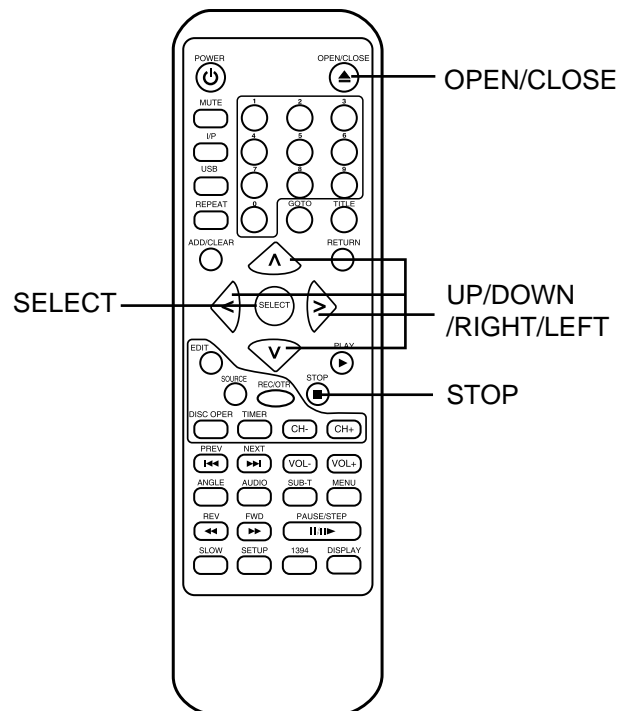

GENERAL FEATURES

All playback operation can be realised by the navigation.

During playback, press DISPLAY button twice to access the control bar:

▶ DVD
MODE Normal ▶
Trick mode Play
TITLE 35/41
CHAPTER 01/01
AUDIO 01/02-OTH
SUBTITLE Off
ANGLE 01/01
T-TIME 00:00:00-00:00:00

The details of every functions is as follows:

Press RIGHT/LEFT to highlight one icon and press SELECT to enter, after pressing UP/DOWN to select item, press SELECT.

Press DISPLAY again to cancel the control bar.

MODE Normal ▶

Playback Mode: Set the playback mode such as PROGRAM, RANDOM or REPEAT

Trick mode Play

Playback Control: Control playback by various setting such as FAST FORWARD, FAST REVERSE, PAUSE, STOP, etc.

TITLE 35/41

Title: Select to choose an available title by inputting numbers.

CHAPTER 01/01

Chapter: Select to choose an available chapter by inputting numbers.

AUDIO 01/02-OTH

Audio: Select your desired Audio setting, if available.

SUBTITLE Off

Subtitle: Select to choose an available Subtitle menu by inputting numbers.

ANGLE 01/01

Angle: Select your desired camera angle, if available.

T-TIME 00:00:00-00:00:00

Timer: Input the time for the point you want to start at.

Playing Back a Disc

GENERAL FEATURES

1. Fast forward playback

Press ►► during normal playback.

The speed will cycle with each press as: FF2, FF4, FF16, FF32 or play.

Press **PLAY** to resume normal playback.

2. Fast reverse playback

Press ◀◀ during normal playback.

The speed will cycle with each press as: FB2, FB4, FB16, FB32 or play.

Press **PLAY** to resume normal playback.

3. Pause playback

Press PAUSE/STEP during normal playback to pause and press **PLAY** to resume normal playback.

4. Frame advance

Press **PAUSE/STEP** during normal playback.

One frame is advanced when pressing **PAUSE/STEP**.

Press **PLAY** to resume normal playback.

5. Slow

Press the **SLOW** button during playback

The playback speed becomes 1/2, 1/4, 1/8 of the normal speed or normal play when pressing the **SLOW** button.

Note:

The above features vary depending on the disc type such as MP3, Audio CD, etc.

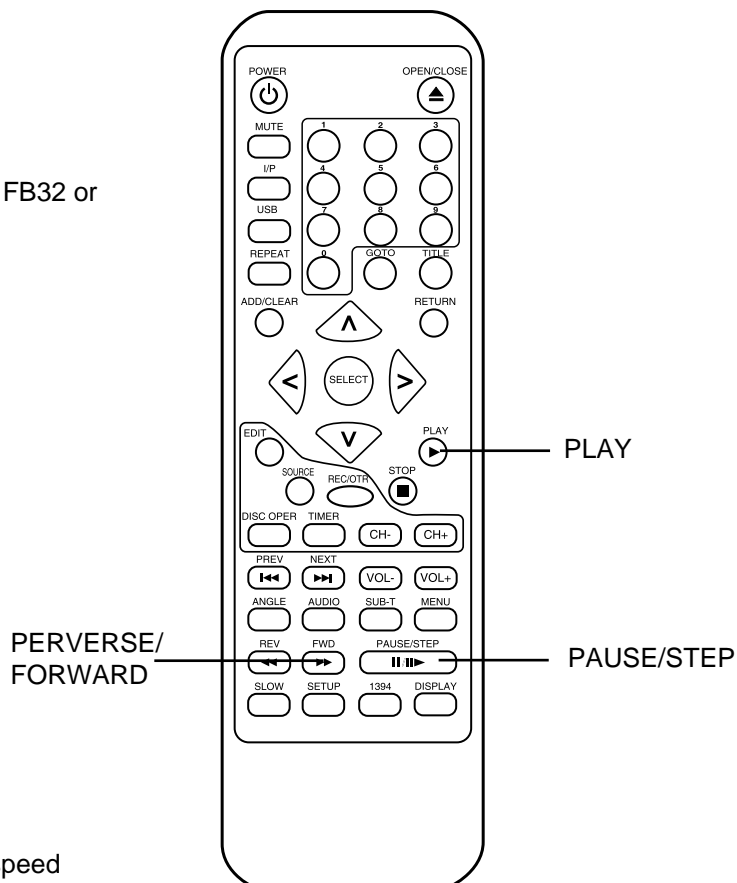

Locating a Specific Title/Chapter/Track

DVD VIDEO DISCS ARE NORMALLY DIVIDED INTO TITLES AND SUB-DIVIDED INTO CHAPTERS. SIMILARLY, CD'S (AUDIO, HDCD, and MP3) ARE DIVIDED INTO TRACKS. YOU CAN CONVENIENTLY LOCATE ANY SPECIFIC TITLE, CHAPTER, OR TRACK WITH THIS DVD PLAYER.

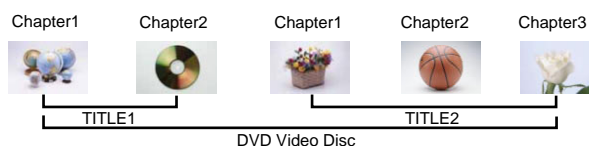

LOCATING A TITLE USING THE TITLE MENU

You can locate a specific title using the title menu function, if a DVD video disc contains a title menu.

1. Press the TITLE button
On the TV screen, the title menu will appear.
2. Press the ▲/▼/◀/▶ button to select the title you want
3. Press the SELECT button
This will cause the DVD video player to start playback from chapter 1 of the title selected.

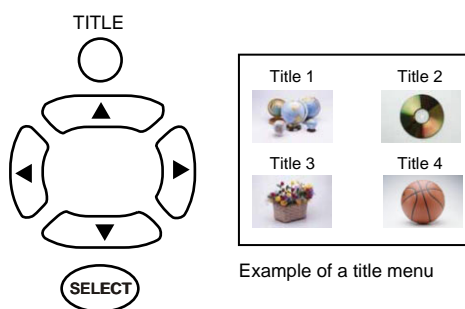

NOTICE

- There are some discs that do not respond to this function.
- If different instructions appear on the TV screen, follow those instructions. The instructions above are described as basic procedure. Procedure may vary depending on the contents of the disc.

LOCATING A SPECIFIC CHAPTER OR TRACK

This player allows you to locate consecutive chapters or tracks.

Press the SKIP ◀◀ or ▶▶ button repeatedly to display the requested chapter or track

- The player starts playback from the selected chapter or track.

PREV NEXT
◀◀ ▶▶

How to locate preceding chapters or tracks

- When you press the **SKIP ◀◀** button, the player starts playback from the beginning of the preceding chapter or track.

How to locate succeeding chapters or tracks

- When you press the **SKIP ▶▶** button, the player starts playback from the beginning of the succeeding chapter or track.

Notice: on some discs the titles may not display the sub-divided chapters.

Locating a Specific Title/Chapter/Track

LOCATING A TITLE

If a DVD video disc contains title numbers, you can locate a specific title by directly selecting a title number.

1. Press **GOTO** during playback.

The control bar will display on the screen.

▶ TITLE:--

▶ CHAPTER--

▶ TIME-: --:--

2. To select a desired Chapter, input the number of an available chapter, then press **SELECT** to confirm.

e.g. To select Title 2

▶ CHAPTER- -2

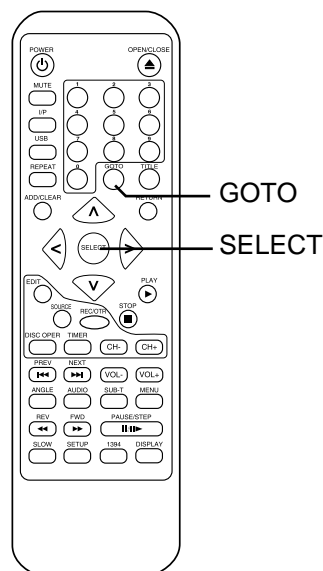

3. To select your desired title, press **GOTO** to highlight the icon and input the number of available title, then press **SELECT**.

▶ CHAPTER--

4. If you want to start playback from some point, press **GOTO** to highlight the icon

▶ TIME-: --:-- , and input the time, then press **SELECT**.

Note:

- The function is invalid on MP3 disc.
- For CD disc, GOTO is used for track/time selection.

Playing Repeatedly

THIS RECORDER ALL ALLOWS YOU TO PLAYBACK A SPECIFIC TITLE, CHAPTER, TRACK, OR SEGMENT REPEATEDLY. (TITLE REPEAT, CHAPTER/TRACK REPEAT, A-B REPEAT)

HOW TO REPEAT A TITLE, CHAPTER OR TRACK

1. Press the **REPEAT** button during playback.
The repeat mode changes, each time you press the **REPEAT** Button.

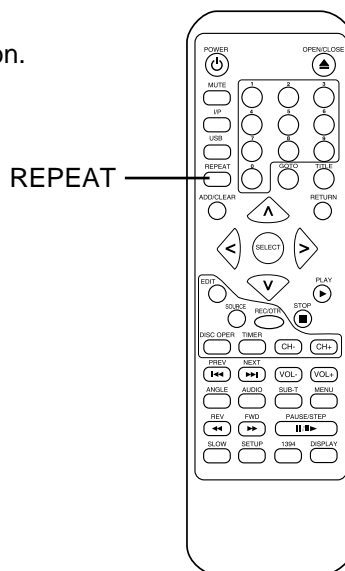
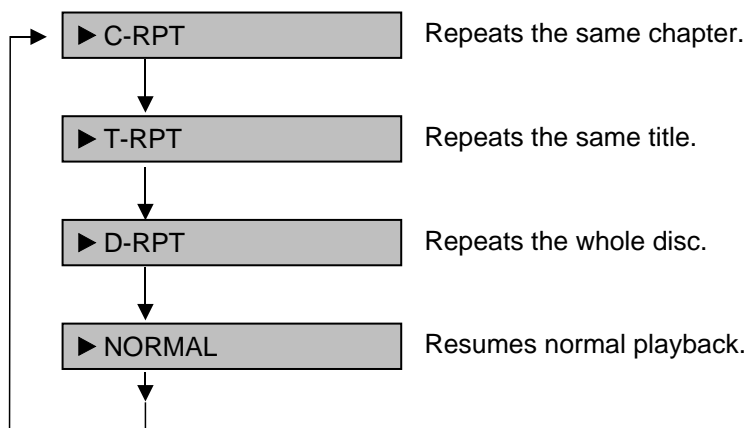

HOW TO REPEAT A SPECIFIC SEGMENT

1. Press **DISPLAY** button twice to access the control bar.
2. Highlight **MODE Normal** by pressing **RIGHT/LEFT**, press **SELECT**.
3. Use **UP/DOWN** to select **A-B Repeat** and press **SELECT** at the beginning of the segment in which you want to repeat playback (point A).

4. Press **SELECT** again at the end of the segment (point B)
The player will automatically return to point A and
Start to repeat playback to the selected segment (A-B)

▶ DVD		Normal
MODE	Normal	Normal
Trick mode	Play	A-B Repeat
TITLE	35/41	Chapter Repeat
CHAPTER	01/01	Title-Repeat
AUDIO	01/02-OTH	Disc Repeat
SUBTITLE	Off	
ANGLE	01/01	
T-TIME	00:00:00-00:00:00	

5. Highlight **MODE A-B Repeat** by pressing **RIGHT/LEFT**, press **SELECT**.
Use **UP/DOWN** to select **NORMAL** and press **SELECT** to resume normal playback.

Note:

- There are two repeat modes for MP3/CD disc. On CD disc, they are track repeat and disc repeat, and on MP3 disc, they are repeat song and repeat directory.

▶ VCD		Normal
MODE	Normal	Normal
Trick mode	Play	A-B Repeat
TRACK	01/01	Track-Repeat
AUDIO	Stereo	Disc-Repeat
PBC	PBC on	Program
TR-TIME	00:01:50-01:25:40	Random

Playing USB

PLAYING USB/DV

USB Function

1. During use USB, press the USB button.
The player will start playback now.
2. Pull out the USB to exit USB.

DV Function

1. Connect the DV with this recorder through DV terminal.
2. Press 1394 button to change the signal source to DV monitor state.
3. Press Play button to play.

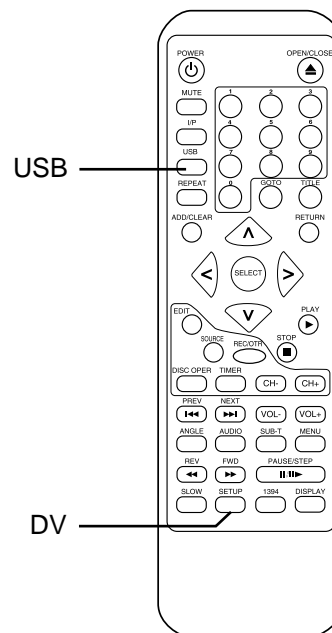

Selecting Camera Angles/Language & Audio Settings

THIS RECORDER ALLOWS YOU TO SELECT FROM SEVERAL DIFFERENT ANGLES AND LANGUAGES.

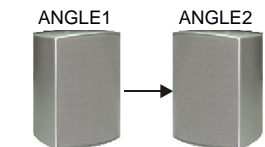

Selecting the camera angle

▶ AUDIO :01/03 GER DOLBY

▶ AUDIO :02/03 ENG DOLBY

▶ AUDIO :03/03 CHI DOLBY

Selecting a language

HOW TO CHANGE THE CAMERA ANGLE

If the video on the DVD was recorded with multiple angles, you have the option to change the camera angle of the scene you are watching.

Press the **ANGLE** button while playing back a scene recorded with multiple angles.

- You may only press the ANGLE button when the angle icon  is shown on the DVD display.
- Each time you press the ANGLE button, the angle will be changed.

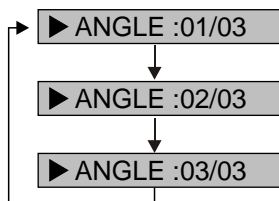

ANGLE

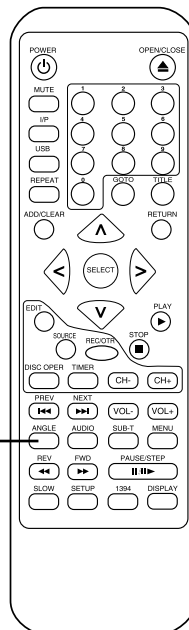

Note:

- The angle function will not work on DVD video discs that do not contain recorded multiple angles.
- During still playback, you are able to change the camera angle. When you resume to normal playback, the camera angle will change to the new settings.
- The angle icon indicator will illuminate while playing back a title that contains at least one scene recorded from multiple angles.

HOW TO SELECT LANGUAGE AND AUDIO SETTING

This player allows you to select a preferred language and sound recording system from those included on the DVD video disc.

1. Press the **AUDIO** button during playback
2. Press the **AUDIO** button repeatedly to cycle through the options

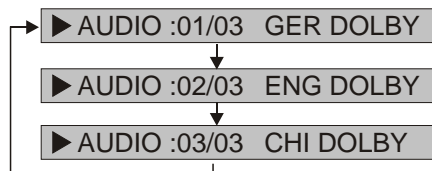

AUDIO

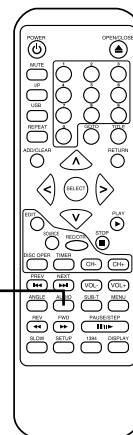

Note:

- The player returns to the initial default settings when you turn on the player or replace a disc.
- The player plays a default sound when unsupported format is selected.
- On MP3/CD disc, AUDIO is used for the selection of LEFT, RIGHT and STEREO.

Playing in a Favourite Order

THIS PLAYER ALLOWS YOU TO PROGRAM UP TO 99 ITEMS INTO MEMORY AND THEN PLAY THEM BACK IN THAT ORDER. (PROGRAM/PLAYBACK)

HOW TO SET TITLES/CHAPTER/TRACKS IN A FAVOURITE ORDER

1. Press **DISPLAY** button twice to access the control bar.

2. Highlight **MODE** Normal by pressing **RIGHT/LEFT**, press **SELECT**.

3. Use **UP/DOWN** to select **PROGRAM** and press **SELECT**, two columns will appear on screen.

The left column displays all titles on the disc.

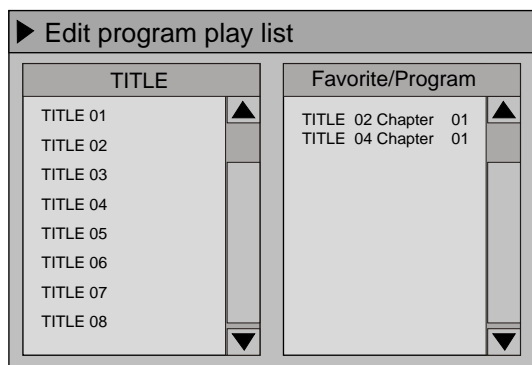

● The right column allows you to edit titles in your favourite order.

2. In the left column, use **UP/DOWN** to select one title, and press **ADD/CLEAR** to add it to the right column.

You can also select one chapter by pressing **SELECT** after highlighting the title.

3. To clear one title you have added in the right column, highlight the one and then press **ADD/CLEAR** to clear it. Use **RIGHT/LEFT** to move the cursor between the column.

4. Press **PROG** to return the **PROGRAM** play back.

5. Press **DISPLAY** button twice to access the control bar

Select **MODE** Program use **UP/DOWN** to select **NORMAL** and press **SELECT** to resume normal playback.

Note:

● On the MP3/CD disc, there are some differences on OSD.

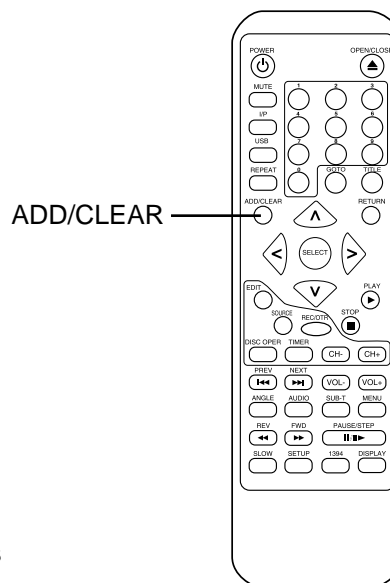

Selecting Subtitles

THIS RECORDER ALLOWS YOU TO DISPLAY THE SUBTITLES FROM THOSE INCLUDED ON THE DISC ON TO YOUR TV SCREEN.



HOW TO DISPLAY SUBTITLES

Press the SUBTITLE button during playback to choose one of the subtitles available on the disc, or turn the subtitle off.

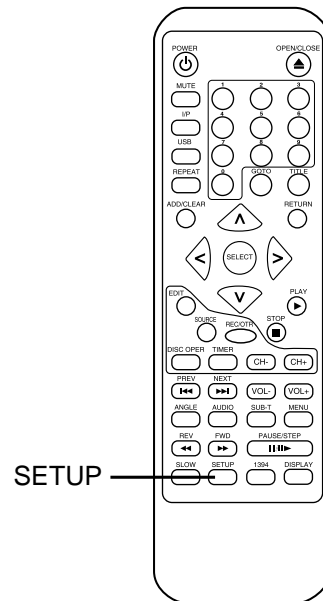
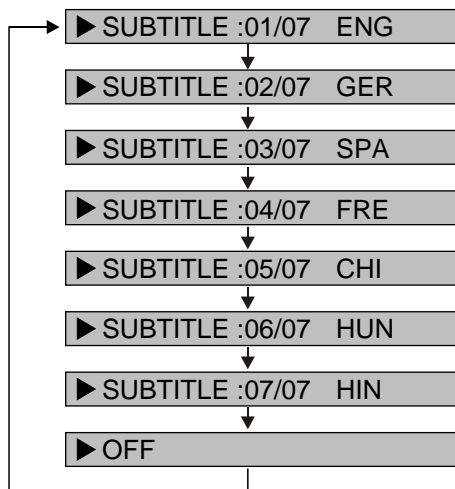

Note:

- Due to the nature of some DVD's, you may not be able to turn off the subtitles as they will appear on screen automatically.
- As you press the SUBTITLE button, the subtitles may not appear immediately during some scenes.
- If the subtitles continue to show on your TV even after the DVD has been turned off, please check the closed caption settings on your TV.

Using the On-Screen Displays

THIS PLAYER ALLOWS YOU TO VIEW STATUS AND DISC INFORMATION ON YOUR TV SCREEN.

CHECKING THE OPERATIONAL STATUS

With this function, you can view the following information on your TV screen:

- Play back status
- Current title
- Current chapter
- Current language
- Current title Time

Press **DISPLAY** button during DVD playback.

▶ Normal Play T01/25 C06/21 AU01/03 00:26:48

→ PLAY BACK STATUS

▶ Normal Play T01/25 C06/21 AU01/03 00:26:48

→ CURRENT TITLE/TOTAL TITLE

▶ Normal Play T01/25 C06/21 AU01/03 00:26:48

→ CURRENT CHAPTER/TOTAL CHAPTER

▶ Normal Play T01/25 C06/21 AU01/03 00:26:48

→ CURRENT LANGUAGE

▶ Normal Play T01/25 C06/21 AU01/03 00:26:48

→ CURRENT TITLE TIME

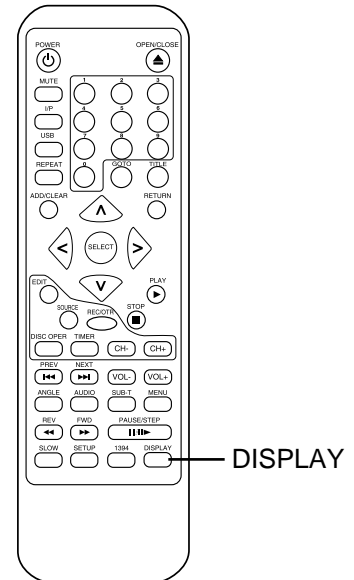

Setting the Parental Lock

YOU CAN USE THE PARENTAL LOCK FUNCTION ONLY WITH DVDs EQUIPPED WITH THIS FEATURE.

SETTING THE PARENTAL LOCK

DVDs equipped with the Parental Lock function are rated according to their content. The contents allowed by the Parental Lock level will vary from disc to disc. For example, if the disc allows it, you could edit out violent scenes unsuitable for children and replace them with more suitable scenes, or lock out playback of the disc all together.

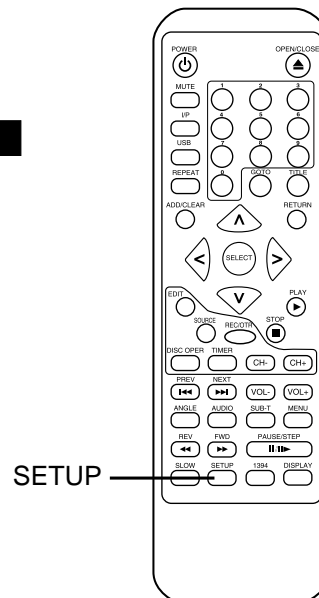

1. Press **STOP** button twice during playback.
2. Press **SETUP** during stop status.
3. Highlight the **PLAY** icon by pressing **RIGHT/LEFT**.

The menu appears on the TV screen.

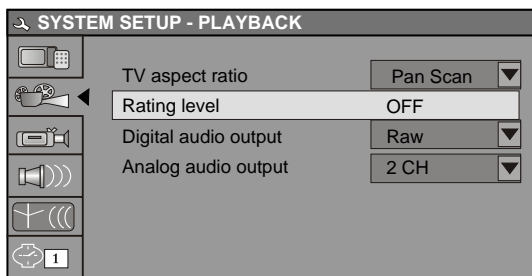

4. Use **UP/DOWN** to select Rating Level, press **SELECT** button.
5. Input your password , highlight **OK** and press **SELECT**.

The pre-set password is 3308

6. Press **SELECT** , the sub-menu of Set Rating Level appears, use **UP/DOWN** to select one rating, press **SELECT** to confirm it.

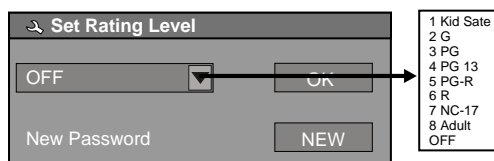

7. Highlight **OK** and press **SELECT** to save your setting.

8. Press **SETUP** button to exit setup, press **PLAY** button to start

TO CHANGE YOUR PASSWORD:

1. Follow step 1-6 to select "New".
2. Enter new password.
3. Re-enter to confirm your new password.
5. Highlight **OK** and press **SELECT** to save it.
6. Press **SETUP** button to exit.

Customising Function Settings

THIS PLAYER ALLOWS YOU TO CUSTOMISE THE PERFORMANCE TO YOUR PERSONAL PREFERENCES.

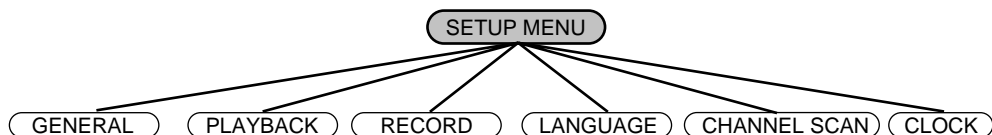

DISPLAYING THE SETUP MENU SCREEN

The SETUP MENU screen asks you to select a setting category from General, Speaker, Audio and Preferences. The selected category will provide you the setting details using the succeeding screen.

Main Page		
GENERAL	General Setup	
	Screen Saver	ON/OFF
	Progressive/Interlace	Interlace/Progressive
	Country	Australia
	Video output	PAL/NTSC
	Restore factory settings	OK
PLAYBACK	Playback Setup	
	TV aspect ratio	16:9/Pan Scan/Letter box
	Rating level	OFF
	Digital audio output	RAW/LPCM
	Analog audio output	2CH/5.1CH
RECORD	Record Setup	
	Auto Chapter Marker	ON/OFF
	Default source	Tuner/Front CVBS/Front S-VIDEO/Rear CVBS/Rear S-VIDEO/DV
	Default quality	SLP/EP/SP/HQ
LANGUAGE	Language Setup	
	OSD language	English/Francias/.....
	Menu language	English/Chinese/...../Original
	Subtitle language	Off/English/Chinese/...../Original
	Audio language	English/Chinese/...../Original
CHANNEL SCAN	Details see page 27	
CLOCK	Date & Time Setup	
	Date(mm/dd/yy)	01/01/00
	Time(hh:mm:ss)	01:15:01

1. Press **SETUP** during stop status.
2. Press direction keys (**UP/DOWN/RIGHT/LEFT**) to select category (highlight), then press **SELECT**.
3. Press **SETUP** to exit the setup menu.

Recording Options

CHANNEL SEARCH

To record TV programs, you should search TV channels first.

1. Press **SCAN** to access the TV setup menu.

2. Use the **UP/DOWN** button to highlight **SCAN** and press **SELECT**.

It will search channels automatically.

During auto-searching, press **STOP** to cancel searching.

3. To browse the found channels, use the **UP/DOWN** button to highlight **EDIT** and press **SELECT** to setup it, press **UP/DOWN** to Name, and you can also input numbers and press **SELECT**.

In the **SKIP** column, If a channel cannot be found, it will be highlighted "YES".

4. If you want to skip one channel, select the corresponding channel. Use the **UP/DOWN** button to highlight the channel you want to skip and press **SELECT**. Press the **UP/DOWN** button to highlight **YES**, and press **SELECT**.

5. Use **UP/DOWN** to highlight the **OK** and press **SELECT**.

6. Press **SETUP** again to exit.

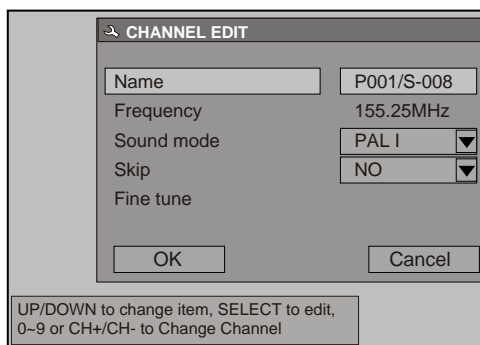
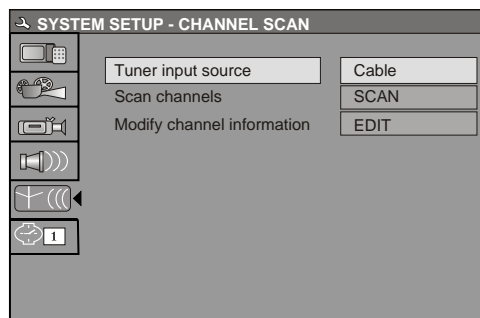

SETUP RECORDING QUALITY

1. Press **SETUP** during stop status.
2. Press direction keys (**UP/DOWN**) to select.
3. Select default quality.

HQ: Perfect quality, nearly 60 minutes in a blank disc

SP: Standard play quality, nearly 120 minutes in a blank disc

EP: Extend play, nearly 240 minutes in a blank disc

SLP: Standard long play, nearly 360 minutes in a blank disc

NORMAL RECORDING

1. Make connections illustrated as page 9-12.

2. Insert a recordable **DVD+R** or **DVD+RW** or **DVD-R** or **DVD-RW** into the recorder.

3. Press **DV**, **TV** or **AV** to select the input source which you have connected as step 1.

F-A/V: Front Audio/Video Input (on the front panel)

R-A/V: Rear Audio/Video Input (on the rear panel)

F-SV: Front S-Video (on the front panel)

R-SV: Rear S-Video (on the rear panel)

TV: (you can select it by pressing **CHANNEL+/-** or input the assigned number of the channel to select your desired one directly)

DV: Digital vidicon

4. Press **RECORD** to start recording.

If you want to stop recording, press **STOP**.

If the **DVD+R** or **DVD+RW** or **DVD-R** or **DVD-RW** is new, it will take about three minutes to stop.

Recording Options

ONE-TOUCH RECORD

1. During normal recording, press **RECORD**, the recorder will automatically stop in 30 minutes.

2. The recording time will extend for another 30 minutes with each press.

The length of recording time is determined by disc capacity and record quality.

With your setting, if it will exceed the capacity of the disc, OTR will be cancelled, and switched to normal record.

3. If you want to stop recording, press **STOP**.

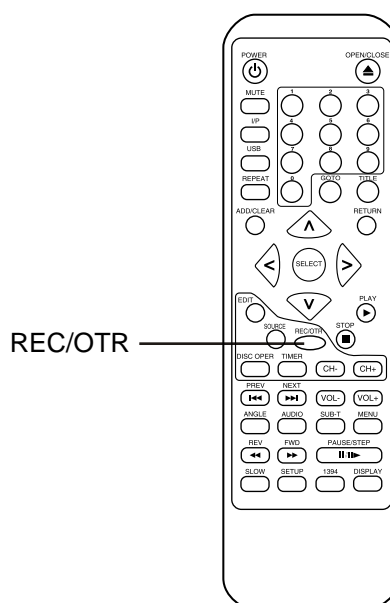

HOW TO SWITCH TO PLAYBACK MODE

When the recording is suspended, you can press **PLAY** to switch to normal playback mode.

CLOCK SETUP

1. During stop status, press **SETUP** to access the Setup Menu.

2. Use **RIGHT/LEFT** to highlight the **CLOCK** icon as the right figure.

3. With “Date (mm/dd/yy)” highlighted, press **SELECT**, and input the local date by numbers, press **SELECT** again.

4. With “Time (hh:mm:ss)” highlighted, press **SELECT**, and input the local time by numbers, press **SELECT** again.

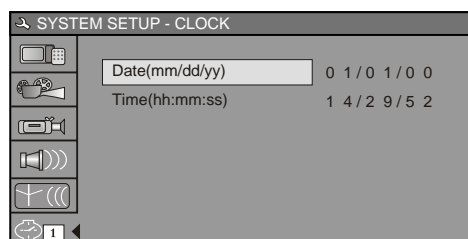

Note:

If you want to cancel input, press **RETURN**.

Recording Options

TIMER RECORD

1. First setup the clock of your system as "CLOCK SETUP" on page 26.

It is recommended to setup your local date and time.

2. Press **TIMER**, the record scheduler will pop up.

Record scheduler						
	Source	Quality	Date	Start	End	
W	1	DV	SP	12/01/03	14:41	15:11
W	2	Rear CVBS	SP	DAILY	07:03	08:33
W	3	Ch057	HQ	12/31/03	12:44	13:05
	4					
	5					
	6					

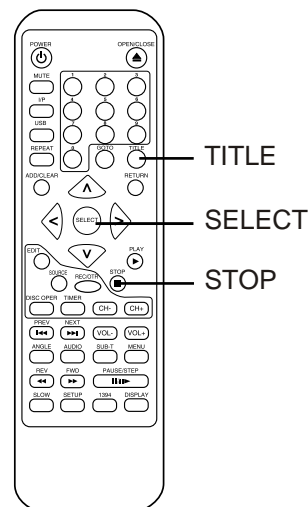

Note:

- If you want to delete a scheduled recording, highlight the specific schedule and press **ADD/CLEAR**.

2. Use **UP/DOWN** to select one schedule, and press **SELECT** to access Item Editor as below:

In each item you can also use direction keys to highlight and press **SELECT** to choose your setting:

Signal input source, details see page 27, step 3.

Record quality, details see

page 27 setup record quality.

Record frequency, once, daily or weekly.

Mm/dd/yy

Start time for recording

End time for recording

Item Editor	
Source	DV
Quality	SP
Mode	Once
Date	0 1/0 1 /0 4
Start	12 : 46
End	1 5 : 1 1
VPS	OFF
<input type="button" value="OK"/> <input type="button" value="Cancel"/>	

3. Select **CONFIRM** to save your settings.

4. Five minutes before the schedule recording is to begin, Record Prompt Menu will appear.

Press **Confirm** to continue or press **Cancel** to delete. If no instructions are given, the unit will record automatically.

Note:

- In standby mode, your recorder can wake up in 2 minutes before recording.
- During recording, you can press **STOP** to suspend the recording.
- A DVD+R/DVD+RW/DVD-R/DVD-RW can record for up to 360 minutes.

EDITING A TITLE OF DVD+RW OR DVD-RW

1. Insert a recorded DVD+RW/DVD-RW on the disc tray.

The Index Picture screen pops up.

2. Use the direction keys to highlight the title which you want to edit.

3. Press **EDIT**, the edit bar appears on the screen while playing back.

Press **RIGHT/LEFT** to highlight one icon and enter it, press **UP/DOWN** to select a sub-item.



View current title/total title

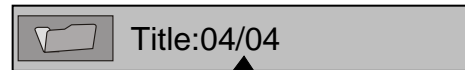

View current chapter/total chapter.

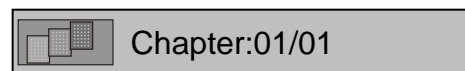

Current operation status



Chapter editing Select to add one chapter, or delete the current/all chapters, details see the next page.

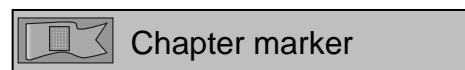

Chapter hide or unhide Select to hide the current chapter, details see the next page.



Title face or Title name Select to set the current image played back to the face of the title or select to name the current title, details see the next page.



Divide current two titles are current point

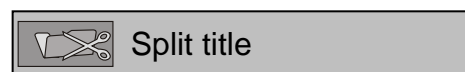

4. Press **EDIT** to quit the menu.

CHAPTER EDITING

From the control bar, select the fourth icon, press **SELECT** repeatedly. It will cycle as follows:

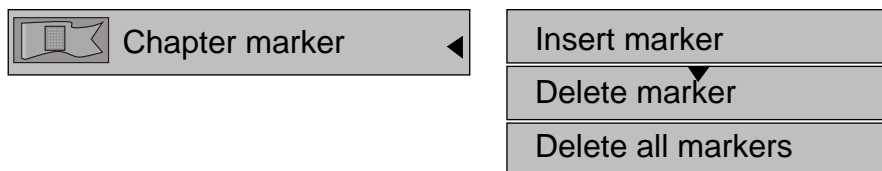

When **Insert marker** is selected by pressing **SELECT**, a new chapter marker will be added to the current point.

When **Delete marker** is selected by pressing **SELECT**, the marker of the current chapter will be deleted.

When **Delete all markers** is selected by pressing **SELECT**, all of the chapter markers will be deleted.

Note:

From the second icon in the control bar, the above operation can be viewed.

If only one chapter is available in the current title, there is only **Insert marker** to select.

CHAPTER HIDE OR UNHIDE

From the control bar, select the fifth icon, press **SELECT**.

When the icon displays  **Hide chapter**, it shows the current chapter is visible, and you can select it to hide it by pressing **SELECT**.

When the icon displays  **Unhide chapter**, it shows the current chapter is invisible, and you can select it to unhide it by pressing **SELECT**.

TITLE ICON AND SPLIT TITLE

From the control bar, select the sixth icon, press SELECT.

When you want to set the current frame as the icon of the current title,

Press SELECT with  INDEX PICTURE displayed.

From the control bar, select the seventh icon, press SELECT.

When  SPLIT TITLE is selected by pressing SELECT, a new title marker will be added to the current point.

EDIT TITLE NAME

1. Insert a recorded DVD+RW or DVD-RW on the disc tray.

The Index Picture screen pops up.

2. Use the direction keys to highlight the title which you want to edit.

3. Press RIGHT, the edit bar appears on the screen while playing back.

Press UP/DOWN to highlight one icon and SELECT it.

4. From the control bar, select the fourth icon, press SELECT.

On the screen, there appears a keyboard:

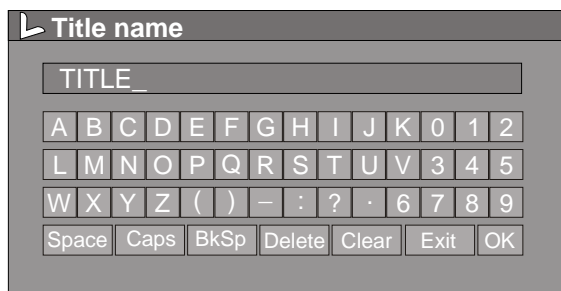
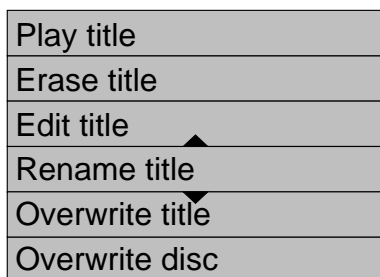

Press the direction keys (UP/DOWN/RIGHT/LEFT) to highlight the one which you want to input, and press SELECT to confirm it.

The control bars of the last line in the keyboard is for editing command.

Select OK to save the name.

Note:

The maximum length of the title name is up to 9 characters.

EDITING A DISC OF A DVD+RW OR DVD-RW

1. Insert a DVD+RW or DVD-RW on the disc tray.
2. Press DISC OPER to access the disc editing menu.
3. Highlight each icon by pressing UP/DOWN. The corresponding description of each operation will be displayed on the screen (i.e. Erase disc, Rename disc, Record new title etc.)
4. Press SELECT to run the operation.

DVD+RW/DVD-RW Display

Play
Erase disc
Rename disc
Record a new title
Overwrite disc
Lock disc

DVD+R/DVD-R Display

Play
Rename disc
Finalize disc
Record a new title

EDITING A DISC OF A DVD+R OR DVD+RW OR DVD-R OR DVD-RW

Play

Press SELECT to playback from the disc.

Erase disc

ERASE (only DVD+RW and DVD-RW)

Press SELECT to begin erasing.

Rename disc

Press the direction keys (UP/DOWN/RIGHT/LEFT) to highlight the one which you want to input, and press SELECT to confirm it.

The control bars of the last line in the keyboard is for editing command. Select OK to save the name.

Note:

The maximum length of the title name is up to 9 characters.

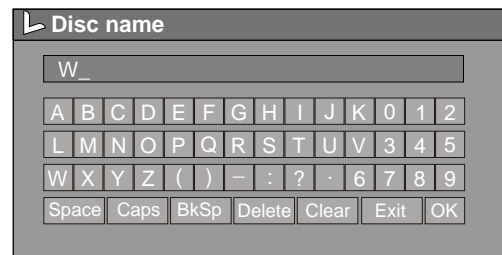

Lock disc

LOCK (only DVD+RW and DVD-RW)

When the icon displays LOCK, it shows your current disc is LOCKED. If your disc is LOCKED, you cannot make any changes. Choose UNLOCK to be able to edit disc.

Finalise disc

Finalise (only DVD+R and DVD-R)

Highlight the icon and press SELECT. It will take a few minutes to finalise the disc.

Note:

If a DVD+R has been finalised, you can not record or edit the disc. If you want to make your disc compatible with the other DVD player, you should go on FINALISE operation.

Specifications

DVD Player	
TV System	NTSC/PAL
Compatible Discs	DVD+R, DVD, CD, MP3, DVD+RW, CD-R, CD-RW VCD SVCD, JPEG, WMA, MP4, DVD-R/RW
Recordable discs format	DVD+R, DVD+RW DVD-R, DVD-RW
Resolution Ratio	Greater Than 500 lines
Video S/N Ratio	65dB
Frequency Response	fs (96KHz/24bit) 4Hz - 44KHz: +/-2dB
Audio S/N Ratio	95dB
Degree of Distortion	<0.01%
D/A Converter	192KHz/24bit
Video Out	1Vp-p
S-Video Out	Y: 1Vp-p(75Ω) C: 0.3Vp-p(75Ω);
Audio Out	2.0V 5.1 Channel, 2 Channel mixed
Digital Audio Output Connections	Optical, Coaxial YUV, PSAN S-Video

Remote Control	
Transmitter	Infrared Ray
Signal Range	Approximately 15'
Power Source	2 "AAA" Batteries

General	
Power Supply	AC 120V-240V AC50/60Hz
Consumed Power	35W
Standby Power	<3W
Size (WxHxD)	430 x 55 x 230mm

Because its products are subject to continuous improvement, We reserves the right to modify product design and/or specifications without notice and without incurring any obligations.

SYMPTOMS AND CORRECTION

Symptom	Correction
No power	<ul style="list-style-type: none"> • Connect the power plug into the wall outlet securely.
No picture	<ul style="list-style-type: none"> • Verify the connection from the DVD video output to the TV video input. Then switch TV to appropriate mode (video 1). • Connect the video cable into the jacks securely. Refer to your television owners manual.
No sound	<ul style="list-style-type: none"> • Connect the audio cables into the jacks securely. • Verify the connection from the DVD audio output to the TV or receiver audio input. Then switch to the appropriate source on the receiver. Refer to your audio amplifier owners manual.
Black & White picture	<ul style="list-style-type: none"> • Damaged S connector (bent pin).
The playback picture has occasional distortion	<ul style="list-style-type: none"> • A small amount of picture distortion may appear because of a poor quality video/sound transfer to disc. This is especially true of some discs manufactured between 1997-1998. • Scratched disc.
Brightness is unstable or noises are produced on playback pictures	<ul style="list-style-type: none"> • Connect the DVD player directly through the TV and not through any other source. What you're viewing is the effect of the copy protection circuitry required on all DVD players. • If you don't have a video input on your TV, you must purchase an Therefore Adaptor from your dealer.
The DVD video player does not start playback	<ul style="list-style-type: none"> • Place the disc with the graphics side up. • Place the disc on the disc tray correctly inside the guide. • Make sure the disc is free from scratches & fingerprints. • Press the SETUP button to turn off the menu screen. • Cancel the parental lock function or change the parental lock level. (The Preset password is 3308.) • Turn the power off then disconnect the power plug and reinsert it back into the wall. Retry again. • Use only region 4 Disc.
MP3 won't read disc or it skips	<p>Re-burn disc as the software edition used may not be compatible with the player. Check web site for instruction.</p> <ul style="list-style-type: none"> • Use new editions of software such as Voyetra Audiostation 4, Adaptec's "Easy CD Creator", NTI or Roxio's Toast Titanium. • Make sure MP3 file are not encoded with a variable bit rate such as provided by Real Networks.
The remote control does not work properly	<ul style="list-style-type: none"> • Replace the batteries with new ones.
The recorder cannot record.	<ul style="list-style-type: none"> • The type of the disc is wrong, it's not a DVD+R or DVD+RW or DVD-R or DVD-RW disc. • The disc is recorded full. • The disc (DVD+R or DVD+RW or DVD-R or DVD-RW) is locked, it should be unlocked. • The DVD+R or DVD-R has been finalised.
Some keys do not work	<ul style="list-style-type: none"> • The type of the disc is wrong, it's not a DVD+R or DVD+RW or DVD-R or DVD-RW disc. • The unit is in record mode or it is recording.
The image is distorted.	<ul style="list-style-type: none"> • The setup of Interlaced or Progressive is wrong. Press the I/P button to switch from each other.

PALSONIC CORPORATION PTY LTD
1 JOYNTON AVENUE
WATERLOO NSW 2017 AUSTRALIA
TEL: (02) 9313 7111
FAX: (02) 9313 7555
www.palsonic.com.au

**PALSONIC CUSTOMER SERVICE
TELEPHONE
AUSTRALIA: 1300 657 888**

Free Manuals Download Website

<http://myh66.com>

<http://usermanuals.us>

<http://www.somanuals.com>

<http://www.4manuals.cc>

<http://www.manual-lib.com>

<http://www.404manual.com>

<http://www.luxmanual.com>

<http://aubethermostatmanual.com>

Golf course search by state

<http://golfingnear.com>

Email search by domain

<http://emailbydomain.com>

Auto manuals search

<http://auto.somanuals.com>

TV manuals search

<http://tv.somanuals.com>