

# OWNER'S MANUAL

# Palsonic

**76CM WIDE SCREEN HDTV READY  
MODEL: 76WSHD**



Type Tested  
Electrical  
Safety

AS/NZS 3250 Lic 4166  
Standards Australia  
APP No: N18748

**PALSONIC CORPORATION PTY LTD  
1 JOYNTON AVENUE  
WATERLOO NSW 2017 AUSTRALIA  
TEL: (02) 9313 7111  
FAX: (02) 9313 7555  
[www.palsonic.com.au](http://www.palsonic.com.au)**

**PALSONIC CUSTOMER SERVICE  
TELEPHONE  
AUSTRALIA: 1300 657 888**

# Contents

## **Congratulations on your purchase of Palsonic's HDTV ready.**

We recommend that you thoroughly read this manual before use to fully enjoy the many functions and excellent effects of this equipment.

Retain this manual in an easily accessible location for future reference.

\* Screen displays and illustrations in this manual may differ from the actual ones for better visibility.

<b>1. Cautions for safety</b> .....	1
<b>2. Locations of controls</b> .....	3
2.1 Front view .....	3
2.2 Side view .....	3
2.3 Back view .....	4
2.4 Remote controller .....	5
<b>3. Installation</b> .....	6
3.1 Antenna connection .....	6
3.2 Battery installation .....	7
3.3 Effective distance of the remote control transmitter .....	7
3.4 External equipment connections .....	8
3.4.1 To connect AV input terminals .....	8
3.4.2 To connect DVD input terminals .....	9
3.4.3 To connect AV output terminals .....	9
3.4.4 To connect XGA input interface .....	10
3.4.5 To connect HDTV set top box .....	10
<b>4. Switching on/off</b> .....	11
<b>5. Signal source selection</b> .....	11
 <b>Enhanced TV operation (RF mode)</b>	
<b>6. Brief menu operation and introduction</b> .....	12
<b>7. Channel presetting</b> .....	13
7.1 Auto tune .....	13
7.2 Manual search .....	14
7.3 To skip unnecessary position numbers .....	15
7.4 Fine tuning .....	15
7.4.1 AFC (auto frequency control) .....	15
7.4.2 Fine tune .....	16
7.5 VCR .....	16
7.6 The setting of colour and sound system .....	16
7.6.1 Use OSD button .....	16
7.6.2 The setting of colour system .....	17
7.6.3 The setting of sound system .....	17
<b>8. Channel selection</b> .....	18
8.1 Using the direct select buttons (0-9 & -/-- button) .....	18
8.2 Using the Channel up/down buttons .....	19
8.3 Using the previous channel button .....	19
8.4 Using the PREVIEW button .....	19
<b>9. Picture and sound adjustments</b> .....	20
9.1 Picture adjustment .....	20
9.1.1 Making use of PERSONAL button .....	20
9.1.2 Making use of PICTURE menu .....	20

## Contents

9.1.3 Making use of DYNAMIC button .....	21
9.1.4 Making use of P.SCAN button .....	21
9.1.5 Making use of STILL button .....	21
9.1.6 Making use of PHOTO button .....	21
9.1.7 Making use of PANORAMA button .....	22
<b>9.2 Sound adjustment .....</b>	<b>23</b>
9.2.1 Bass/Treble adjustment .....	23
9.2.2 BALANCE adjustment .....	23
9.2.3 Making use of surround sound .....	23
9.2.4 Making use of LOUDNESS .....	24
9.2.5 Volume adjustment and sound mute .....	24
9.2.6 NICAM function .....	24
<b>10. Timer setting .....</b>	<b>25</b>
10.1 OFF timer .....	25
10.2 ON timer .....	25
10.3 ALARM timer .....	26
10.4 Program timer .....	26
10.5 PROG number .....	26
<b>11. Making use of OPTION menu .....</b>	<b>27</b>
11.1 OSD language selection .....	27
11.2 AUTO-POWER-OFF function .....	27
11.3 Rotate function .....	27
11.4 Default screen aspect ratio setting .....	28
11.5 Picture moving .....	28
11.6 Degaussing .....	28
11.7 Blue screen setting .....	28
11.8 Colour bar signal .....	29
11.9 Game .....	29
<b>Menu operation in VIDEO mode .....</b>	<b>30</b>
<b>Menu operation in YCbCr mode .....</b>	<b>31</b>
<b>Operation in HDTV mode</b>	
<b>12. Buttons' function .....</b>	<b>32</b>
<b>13. Signal source selection .....</b>	<b>33</b>
<b>14. OSD introduction .....</b>	<b>34</b>
14.1 Menu introduction .....	35
14.2 Contrast, brightness adjustment .....	36
14.3 To switch between TEXT mode and IMAGE mode .....	36
14.4 Volume adjustment .....	36
14.5 Screen adjustment .....	37
14.6 Function menu item's selection .....	37
14.7 Audio adjustment .....	37
<b>15. Display mode setting .....</b>	<b>38</b>
Displaying pattern .....	38
<b>16. Troubleshooting guide .....</b>	<b>39</b>
<b>17. Specifications .....</b>	<b>40</b>

## 1. Cautions for safety

**!** **Note:** This set can be operated on an AC power of 240V, 50Hz. You must not use a power supply of any other type.

- ◆ *When any unusual situation occurs, turn off the power supply at once and remove the plug from the wall outlet. Contact a qualified service department in your local area.*

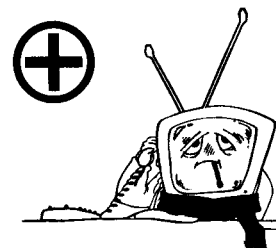

- ◆ *Do not expose the TV set to rain or excessive moisture. Avoid using the set in very warm or damp places and never use it in a bathroom.*

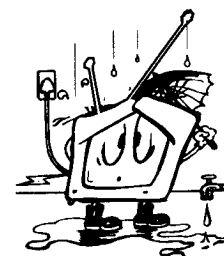

- ◆ *When cleaning dust off the picture tube disconnect the power first. You can wipe lightly with a piece of dry, clean and soft cloth. Normally, the screen surface should not be cleaned; however, if it is essential, clean the surface with a soft, dry cloth while the TV is turned off. Never use any detergent cleaners to clean the surface. The screen surface may be scratched if a hard cloth is used.*

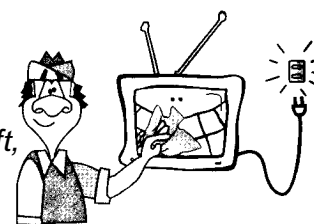

- ◆ *Avoid exposing the set to direct sunlight and other sources of heat to prevent damage to the cabinet and components.*

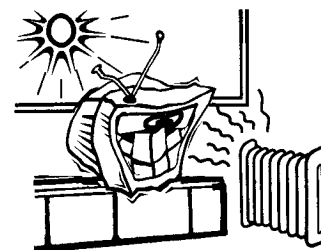

- ◆ *High voltage exists in this TV set. Do not remove the cover.*

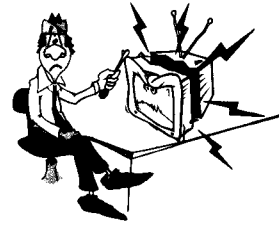

- ◆ *Do not cover the ventilating hole in the cabinet. Keep a space of more than 5 cm from the walls to the TV set to ensure adequate ventilation.*

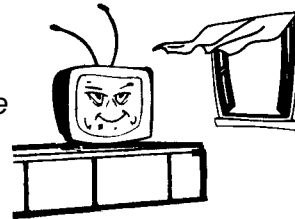

- ◆ *If the power cord or the plug is damaged contact a qualified service department for service.*

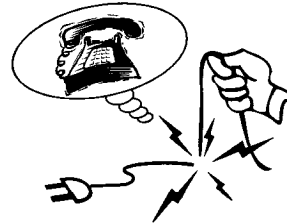

- ◆ *When the TV set is to be left unattended for a long period of time, turn off the power supply and remove the plug from the wall outlet.*

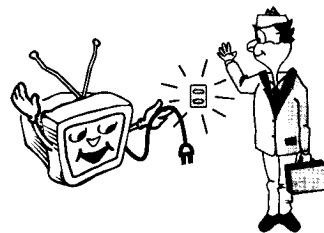

- ◆ *Don't try to push anything into the cabinet or place any vessel with water on the TV set.*

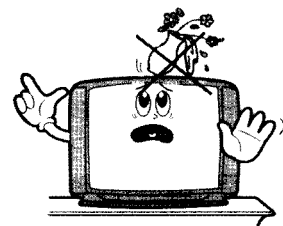

- ◆ *Don't overload wall outlets; extension cords, or integral convenience receptacles as this can result in a risk of fire or electric shock.*

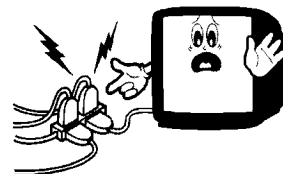

## 2. Location of controls

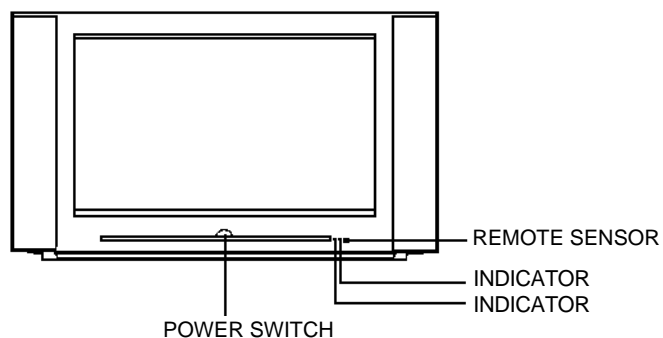

2.1 FRONT VIEW

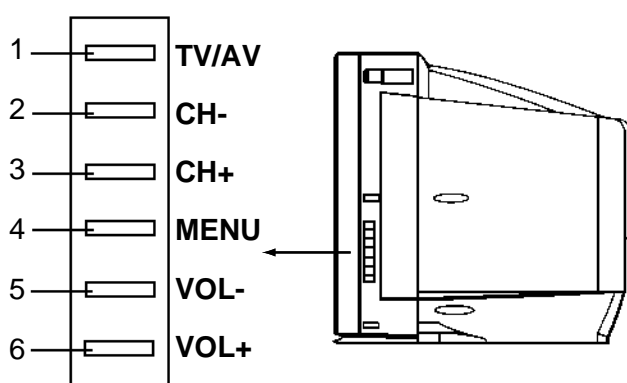

2.2 SIDE VIEW

1. **TV/AV** button: Open the signal source selection menu.
2. **CH-** button: Select a lower position number.
3. **CH+** button: Select a higher position number.
4. **MENU** button: Enter into the menu.
5. **VOL-** button: Lower the volume
6. **VOL+** button: raise the volume.

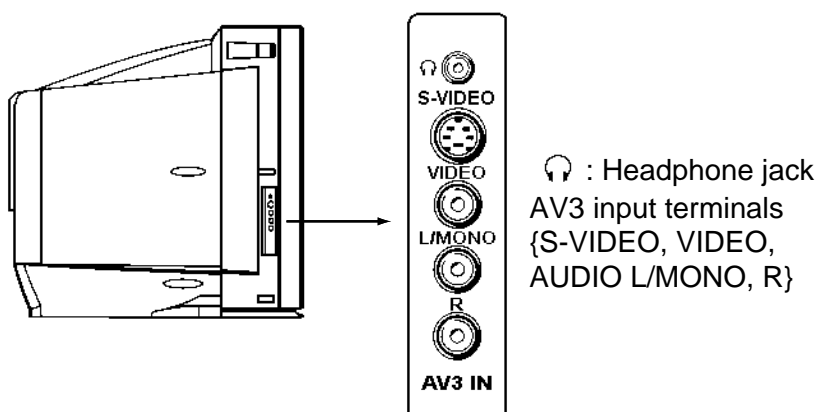

## 2.3 Back View

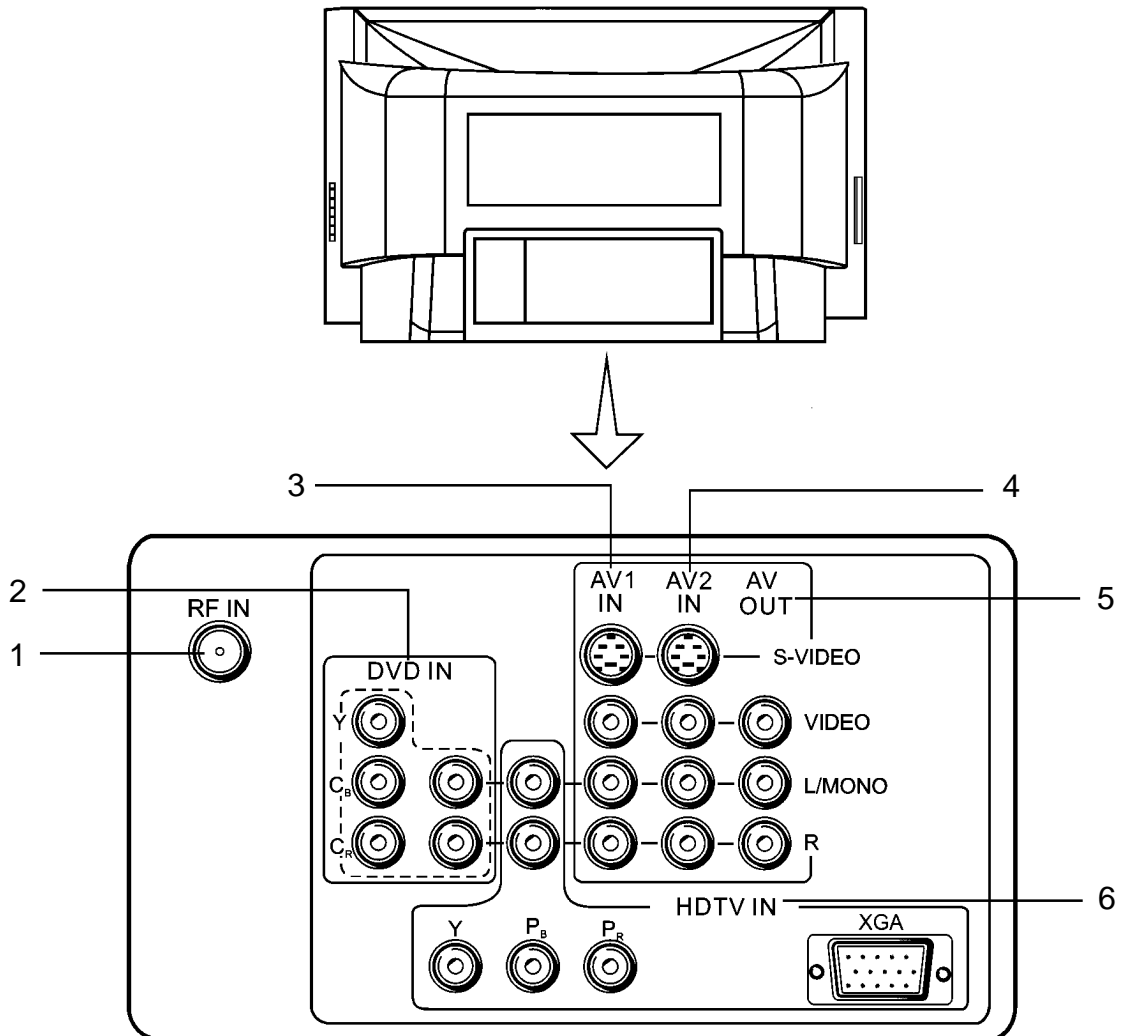

1. Antenna input
2. DVD input terminals { VIDEO: Y, C<sub>B</sub>, C<sub>R</sub>, AUDIO: L/MONO, R}
3. AV1 input terminals { S-VIDEO, VIDEO, AUDIO: L/MONO, R}
4. AV2 input terminals { S-VIDEO, VIDEO, AUDIO: L/MONO, R}
5. AV output terminals {VIDEO, AUDIO: L/MONO, R}
6. HDTV input {Y, P<sub>B</sub>, P<sub>R</sub>, XGA, AUDIO: L/MONO, R}

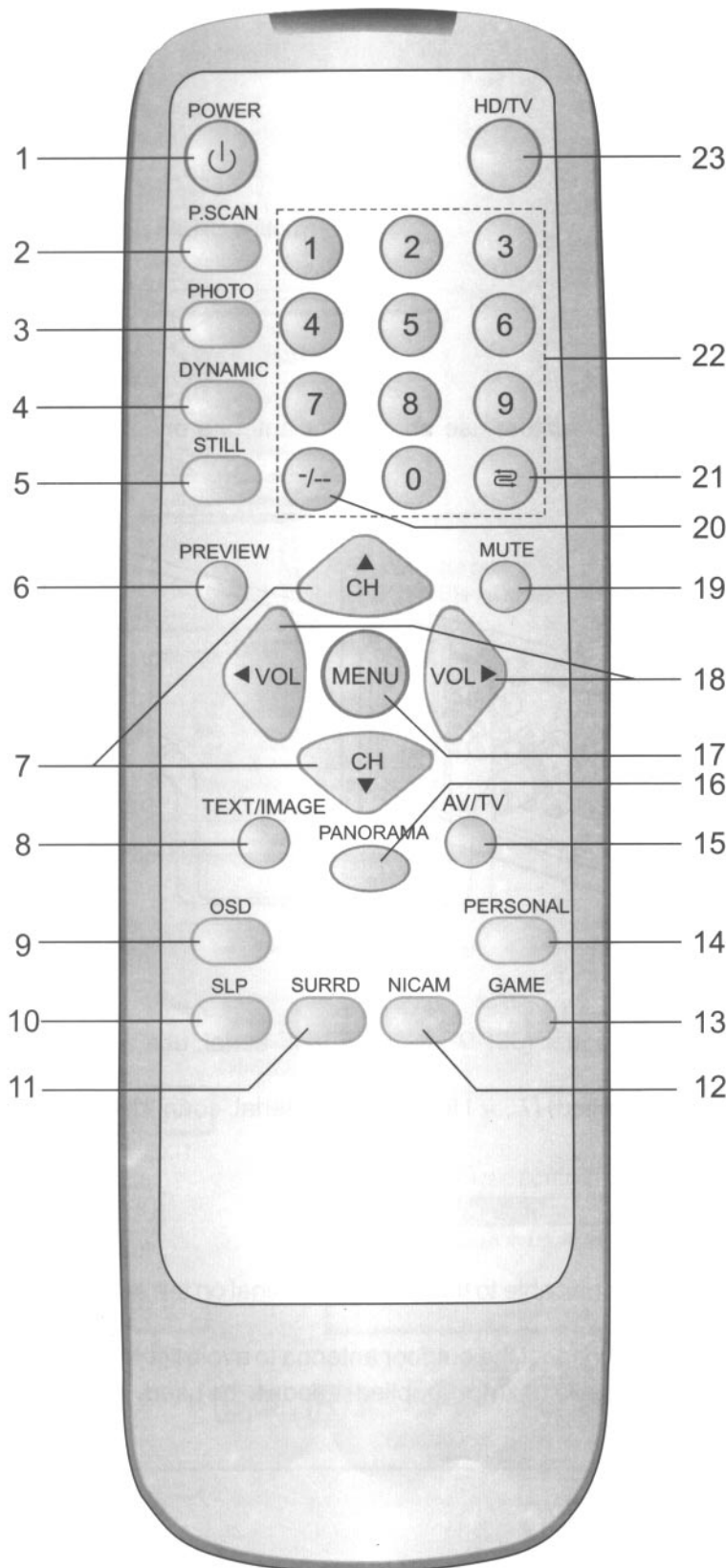

## 2.4 Remote Controller

### Button function:

1. Power on/standby
2. Scan mode selection
3. To caption moving into 4 successive frozen frames
4. STATIC/MOVING picture mode selection
5. Still the current picture
6. Channel preview
7. Channel up/down  
In menu operation used to move the cursor upward or downward.
8. Text /image mode switch over
9. Retain on-screen display
10. Sleep timer
11. Surround sound control
12. NICAM/FORCE FM sound decoder selection
13. Play game
14. Selectable picture
15. Open the signal source selection menu
16. Screen aspect ratio selection
17. Open/close the menu
18. Volume up/down  
In menu operation used to move the cursor leftward / rightward, adjust menu item, or enter into the next level menu
19. Sound mute
20. One digit/two digit/three digit channel selector
21. Previous channel
22. Direct channel selector
23. HDTV/TV



## 3. Installation

### 3.1 Antenna Connection

To ensure a bright-coloured and clear picture use an outdoor antenna or CATV cable.

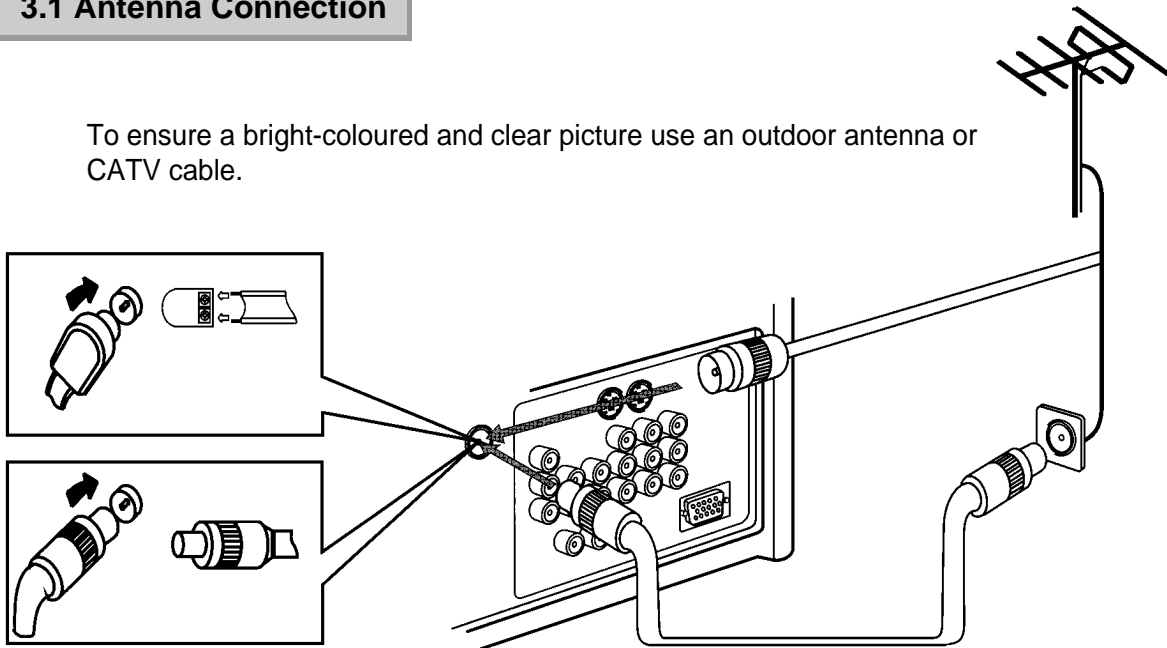
**Note:**

In case of using the Twin-lead aerial feeder (300 $\Omega$ ) for UHF/VHF aerial, use a 300-75 ohm adaptor (not supplied).  
When using the coaxial cable (not supplied) (75 $\Omega$ ) for UHF/VHF aerial, connect the plug into the 75 ohm aerial socket directly.

**Note:**

1. When you connect the outdoor antenna cable to the antenna terminal on the set, turn off the power supply to the set first.
2. In thunder and lightning weather, disconnect the outdoor antenna to avoid lightning strike.
3. When receiving CATV programs, a cable box (not supplied) needs to be used.

### 3.2 Battery installation

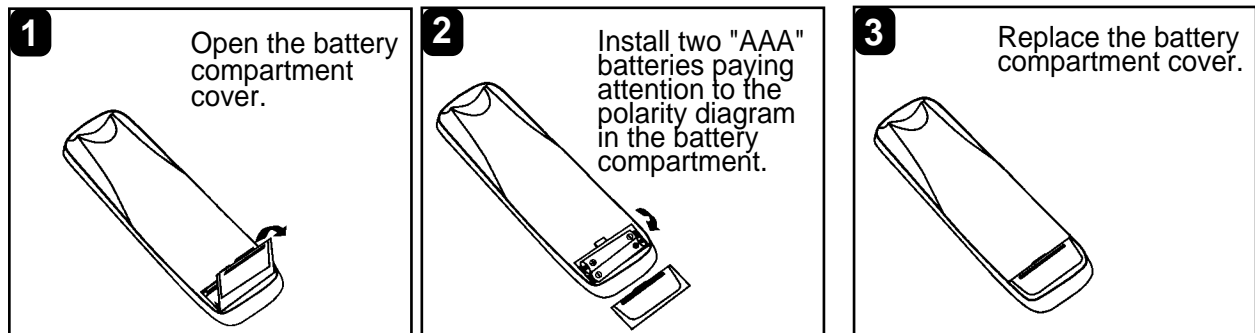

#### BATTERY PRECAUTIONS

Follow these precautions when using batteries in this device:

1. Use only the size and type of batteries specified.
2. Be sure to follow the correct polarity when installing the batteries as indicated in the battery compartment. Reversed batteries may cause damage to the device.
3. Do not mix different types of batteries together or old batteries with fresh ones.
4. If the device is not to be used for a long period of time, remove the batteries to prevent damage or injury from possible battery leakage.
5. Do not try to recharge batteries not intended to be recharged; they can overheat and rupture. (Follow battery manufacturer's directions.)

### 3.3 EFFECTIVE DISTANCE OF THE REMOTE CONTROL TRANSMITTER

#### ! NOTES:

- \* When there is an obstacle between the TV and the transmitter, the transmitter may not operate.
- \* When direct sunlight, an incandescent lamp, fluorescent lamp or any other strong light shines on the REMOTE SENSOR of the TV, the remote operation may be unstable.

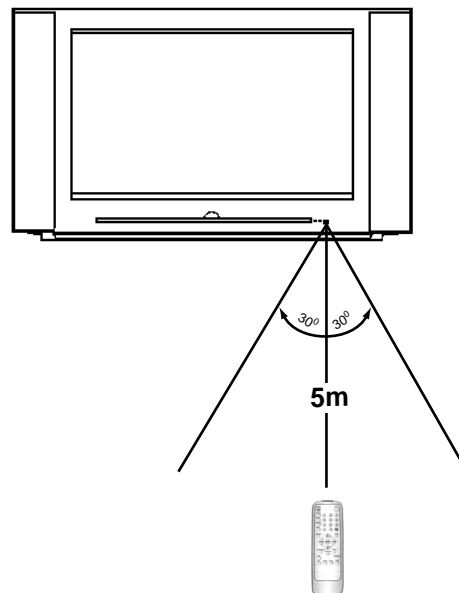

#### FAQs

Why is the remote not working properly?

- The remote control is not aimed at the sensor.
- Distance is too far away from the remote sensor
- There is too much light in the room.
- There is an obstacle in the path of the beam.
- The batteries are weak or dead.
- The batteries are inserted incorrectly.

### 3.4 External Equipment connections

(Please refer to the owner's manual of the equipment to be connected as well.)

#### 3.4.1 To connect AV input terminals

You can connect video equipments such as a VTR and video camera to this TV and enjoy the high quality picture and sound.

If your video equipment has a S-VIDEO output terminal, connect it to the S-VIDEO input terminal (special S-VIDEO type) of the unit. If not, connect it to the VIDEO terminal (phono type).

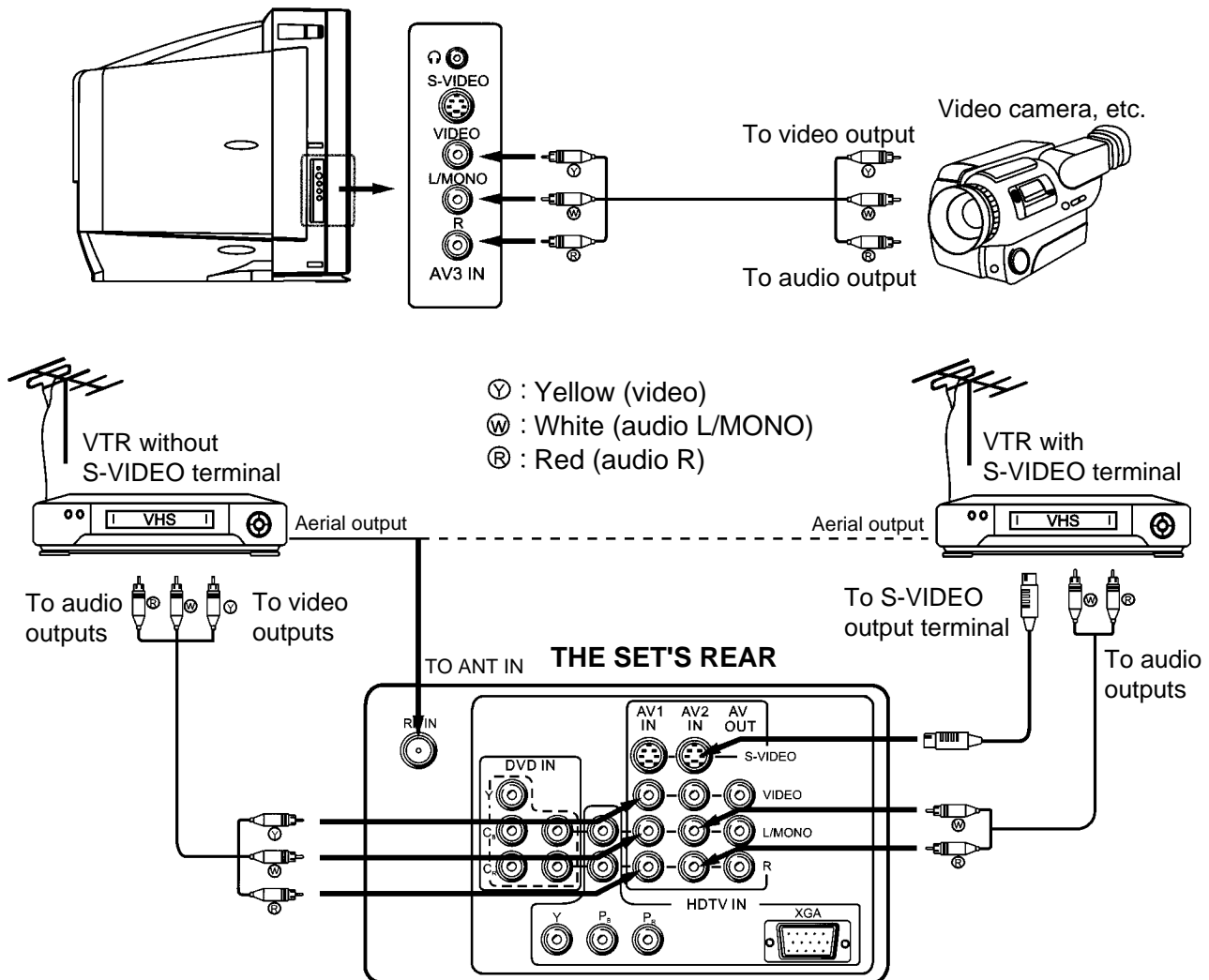

To select the input, press **AV/TV** button to display the signal source selection menu and press the **CH▲** or **CH▼** button to select the corresponding input mode ( VIDEO 1 or VIDEO 2 or VIDEO 3) and press **VOL▶** button to confirm.

#### Note on the S-VIDEO terminal

The S-VIDEO input terminal has priority over the AV1, AV2 VIDEO terminals on the rear and the AV3 VIDEO terminal on the side. To use equipment connected to the video terminals, disconnect any plug from the S-VIDEO terminal.

### 3.4.2 To connect DVD input terminals

The figure below shows how to connect the DVD input terminals of the TV set to the DVD Player, Laser Disk Player, etc.

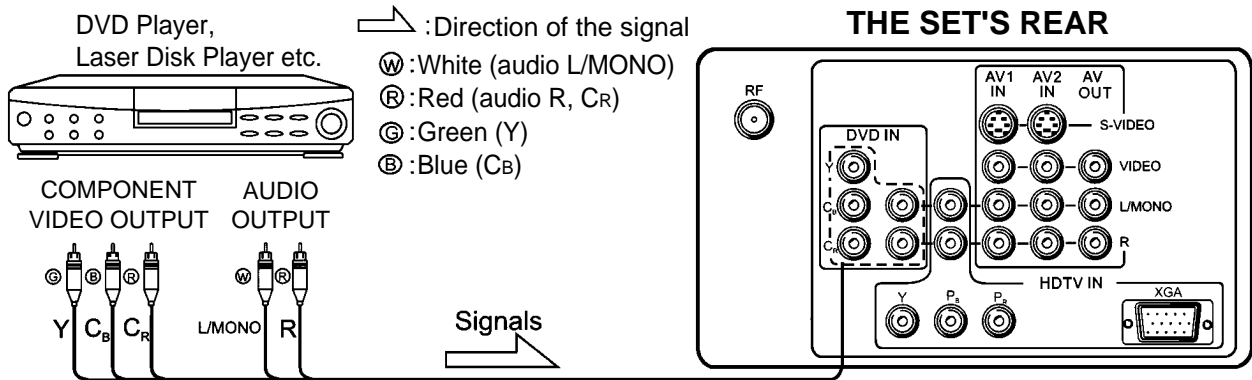

Press **AV/TV** button to display the signal source selection menu and select **YCbCr** mode. The picture shown on the screen is the program from the DVD Player.

**Note:** Both the component video Cr terminal and the audio R terminal are red for easy identification. Make sure these are correctly connected.

### 3.4.3 To connect AV output terminals

You can connect a stereo system to the audio output terminals (phono type) on the set to enjoy a high-quality sound from the stereo system. You can also connect AV output terminals to VTR to record programs being displayed on the screen. (Note: Only when the signal source is input through RF or AV1 IN or AV2 IN or AV3 IN, there is signal for AV OUT terminals to output.)

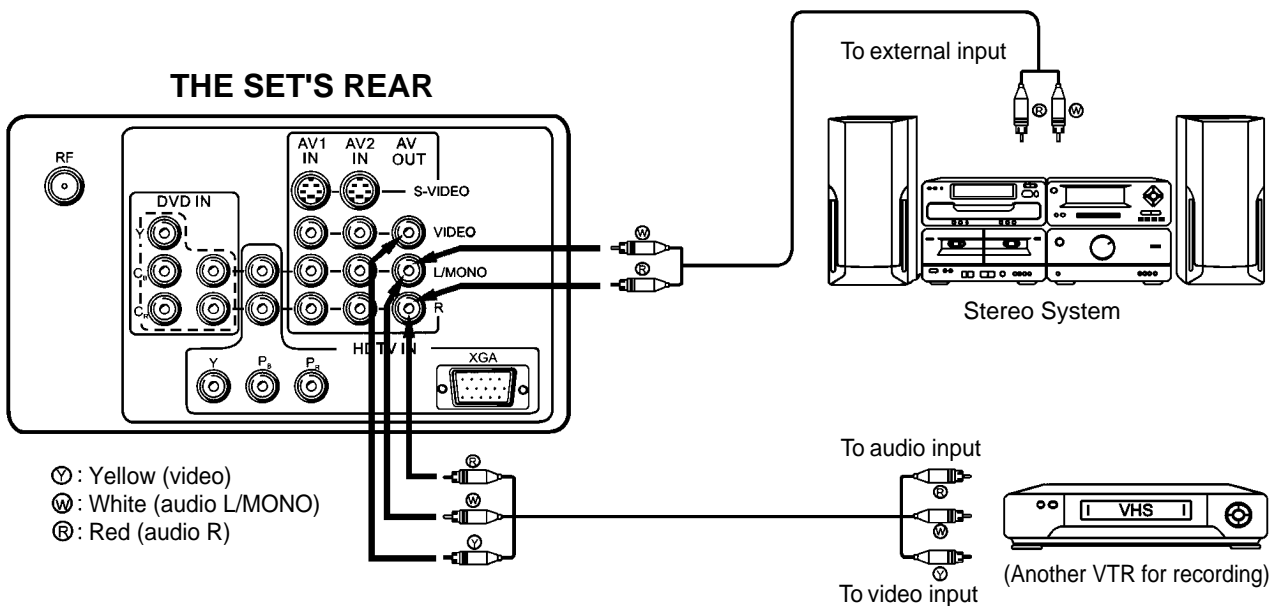

### 3.4.4 To connect XGA input interface

The figure below shows how to connect the set to the computer through XGA interface.

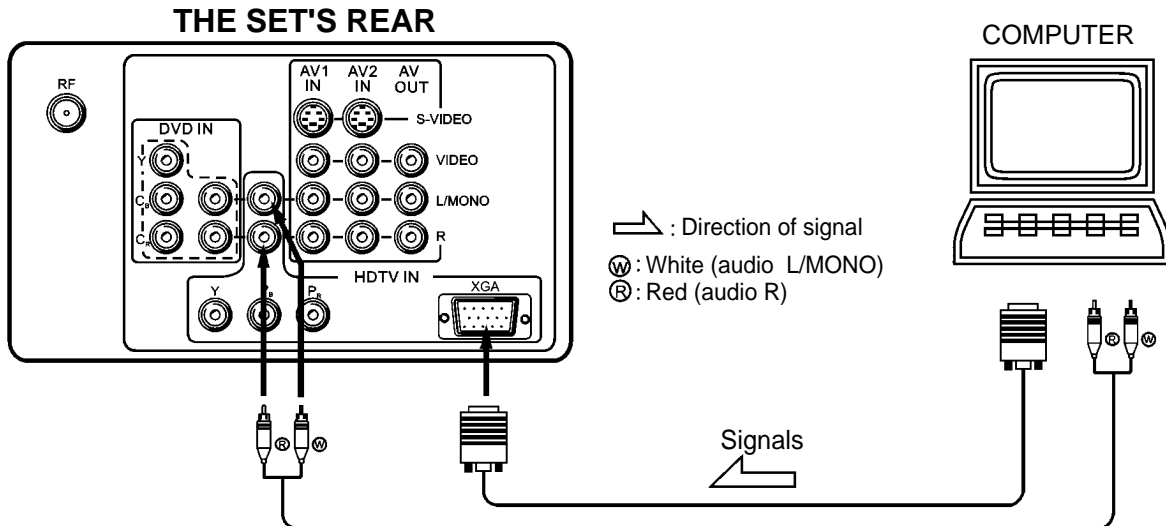

Press **AV/TV** button to display the signal source selection menu and select **HDTV-XGA** mode. At this time the screen will display information from the computer.

### 3.4.5 To connect HDTV set top box

If your HDTV set top box is incorporated with YPbPr terminals, connect the set top box to the TV set through the YPbPr terminals, connect audio lines from set top box to HDTV IN L/R sound inputs, note that L to L and R to R.

(If your set top box is incorporated with XGA interface, please connect according to "To connect XGA input interface" which is shown above.)

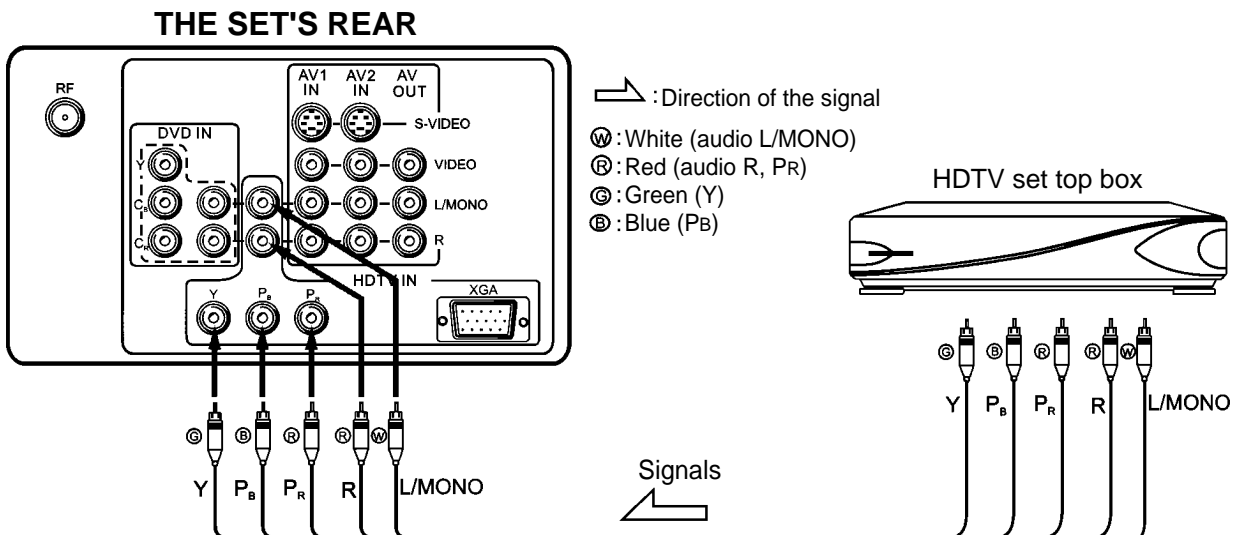

Press **AV/TV** button to display the signal source selection menu and then select **YPbPr** mode. Now you can view programs played back by the set top box.

## 4. Switching on/off

- 1) Press the main **POWER SWITCH** (1) the red power indicator lights up, the set is in standby mode.
- 2) Press the **POWER** button (2) on the remote controller to turn on the set, and the power indicator turns to yellow. Or you can directly press **CH+ / CH-** button on the set to turn on the set.
- 3) To turn off the set completely, press the main **POWER SWITCH** (1).
- 4) To turn off the set temporarily, press the **POWER** button (2) the set is in standby mode, the indicator turns to red.
- 5) When the remote operation is received by the set, the **TIMER** indicator (green) on the set's front will glitter to inform the user.

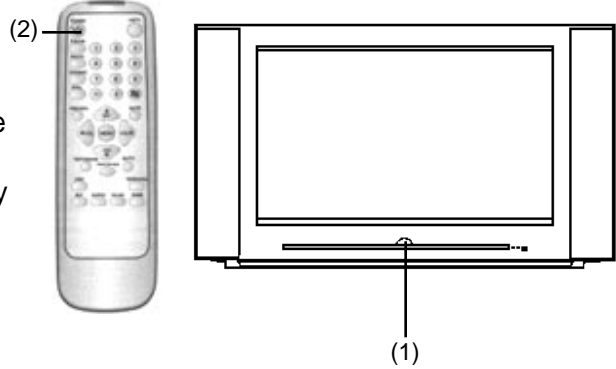

! The buttons in this manual refer to the ones on the remote controller if without special indication.

## 5. Signal source selection

- 1) Press the **AV/TV** button (1) to display signal source selection menu.
- 2) Press the **CH▲** or **CH▼** button (2) to select one of RF / VIDEO1 VIDEO2/ VIDEO3 / YCbCr / HDTV-XGA / YPbPr.
- 3) Press **◀VOL** or **VOL▶** button (3) to confirm your choice.

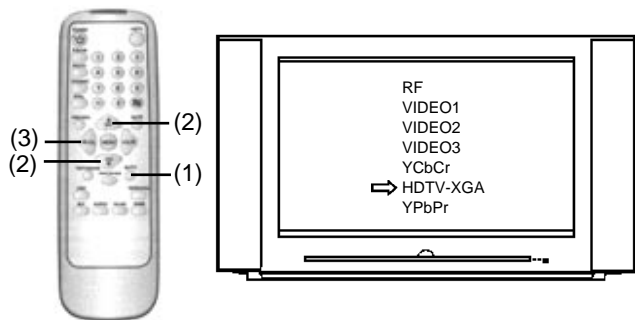

## 6. Brief menu operation and introduction

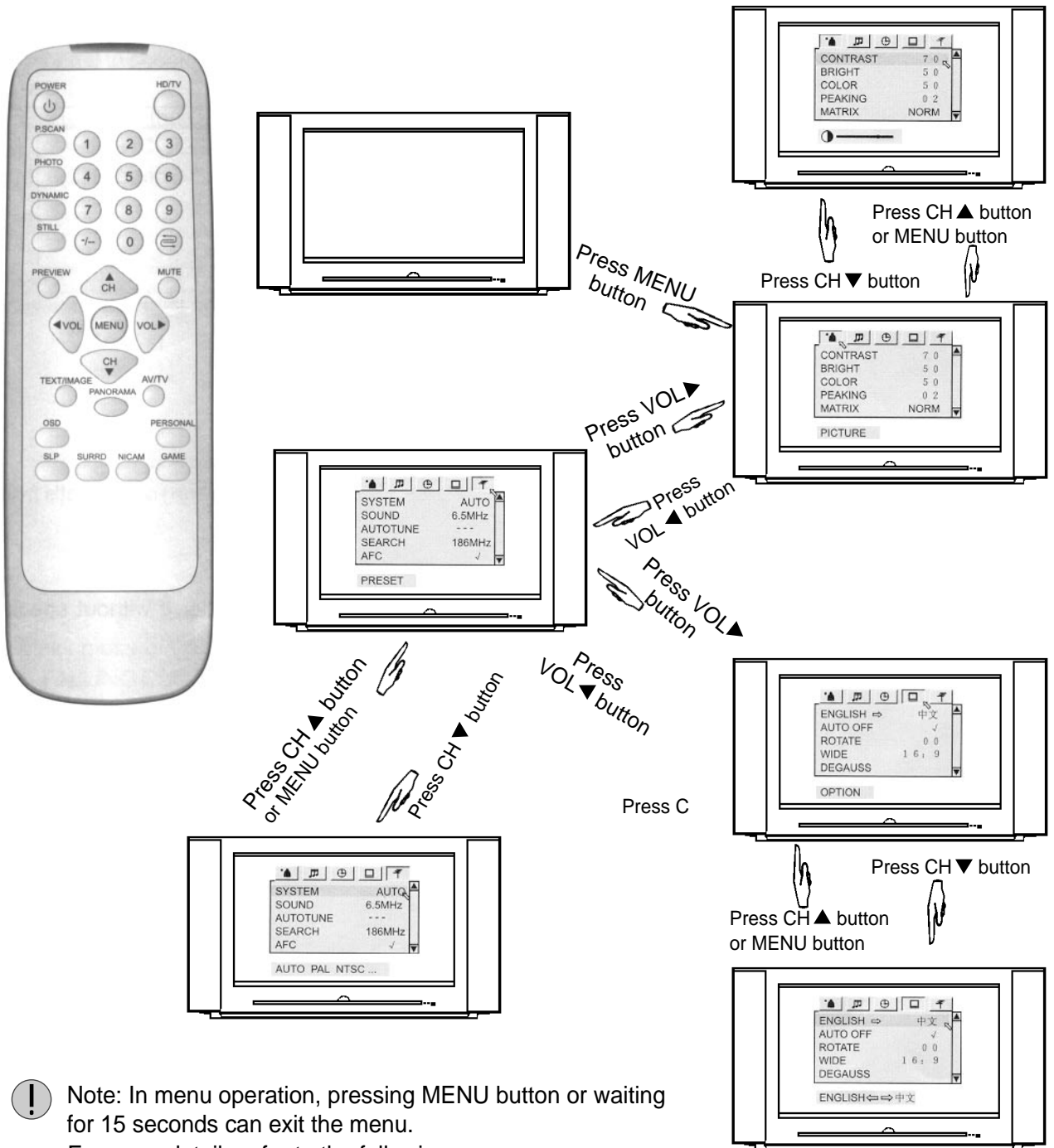

**!** Note: In menu operation, pressing MENU button or waiting for 15 seconds can exit the menu. For more details refer to the following pages.

# TV Operation (RF mode)

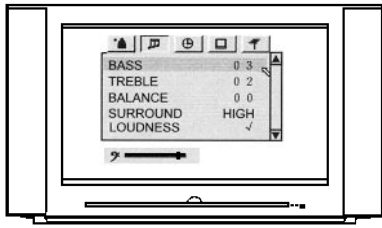

The PICTURE menu includes the following items: Contrast, Bright, Colour, Peaking, Tint Matrix, CTI, COMB, DNR, SVM

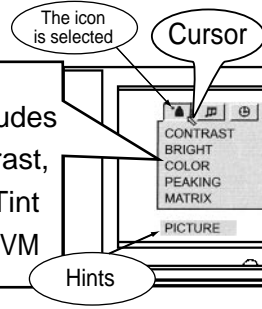

Press CH ▲ button or MENU button

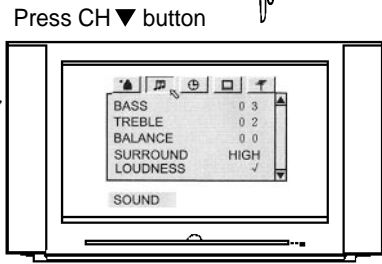

The SOUND menu includes the following items: Bass, Treble, Balance Surround sound, Loudness.

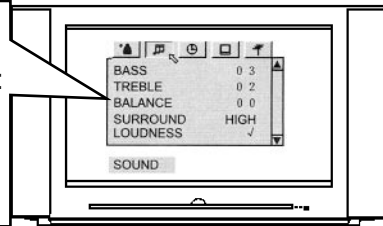

Press VOL ▲ button  
Press VOL ▼ button

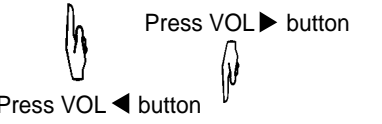

The TIMER menu includes the following items: TIMER OFF, TIMER ON, TIMER PR., PROG NO., ALARM.

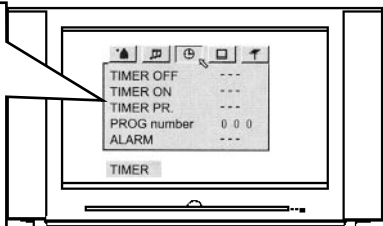

Press VOL ► button  
Press VOL ◀ button

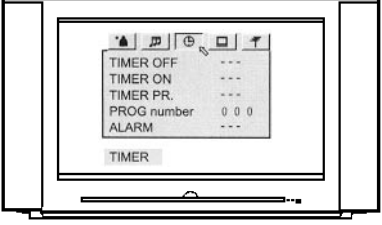

The OPTION menu includes the following items: OSD language, Auto power off, Rotation, Default screen aspect ratio, Picture moving, Degauss, Blue screen, Colour bar, Game.

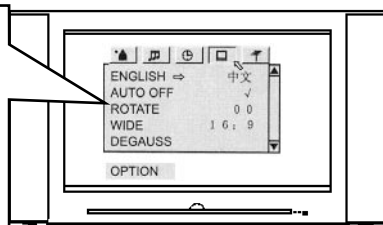

Press CH ▼ button  
Press CH ▲ button or MENU button

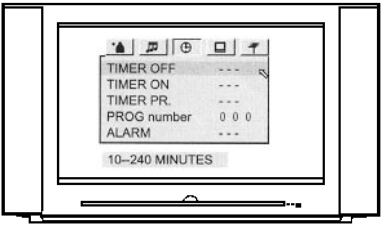

The PRESET menu includes the following items: colour, system, sound system, auto tune, search AFC, Fine tune, Skip, VCR.

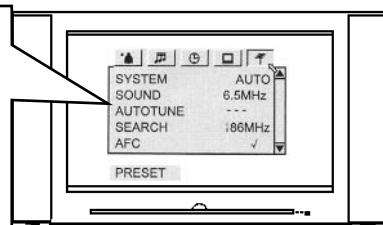



## 7. Channel Presetting

If you have preset the channels, you can directly watch TV programs after turning on the set. If not, then preset channels in one of the following ways.

### 7.1 AUTO TUNE

#### Method 1:

- 1) Press **MENU** button (1) to enter into the main menu.
- 2) Press **◀VOL or VOL▶** button (2) to select **PRESET** menu, press **CH▼** button (3) to select and highlight **AUTO TUNE**.
- 3) Press **◀VOL or VOL▶** button (2) to start the auto tune. All active channels will be searched or stored into the memory automatically. After auto-tune, the TV will return to the first active channel program.
- 4) During auto tune, pressing **MENU** button (1) can exit.

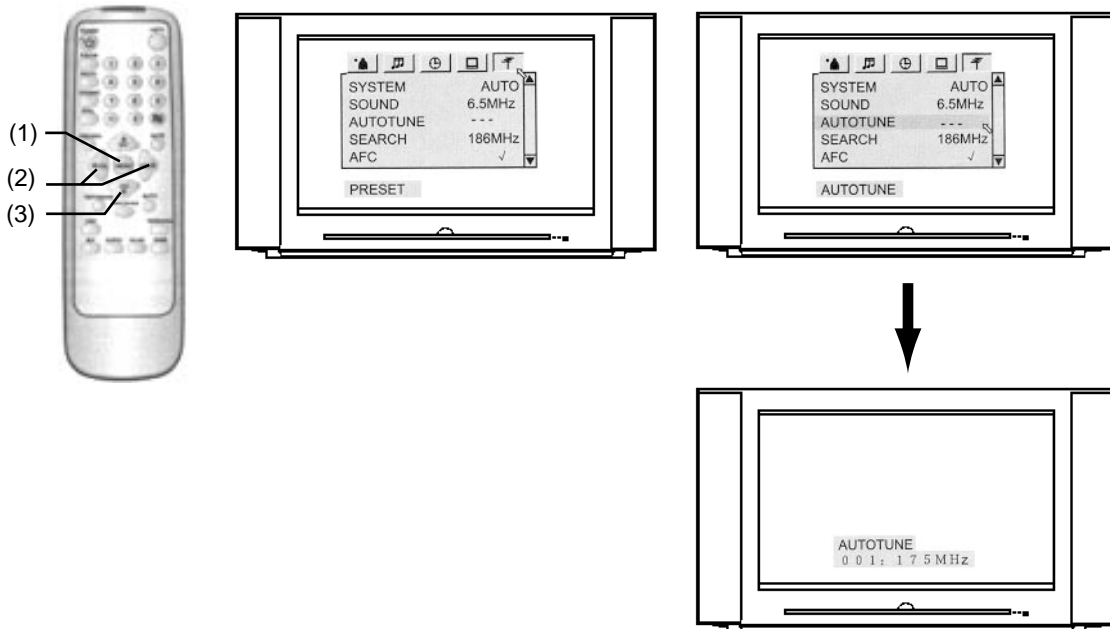

## 7.2 Manual search

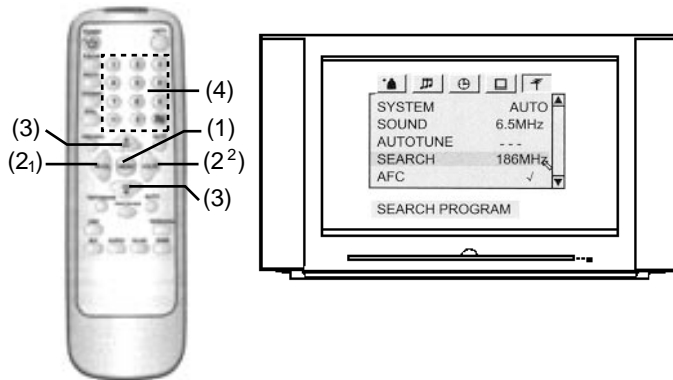
**Method 2:**

If auto tune can not preset the desired channels, or you want to preset the desired channels one by one with the preferred channel number, please make use of **SEARCH**.

- 1) Use number buttons (4) or **CH ▲/▼** button (3) to select a channel number.
- 2) Enter into the **PRESET** menu, press **CH ▲/▼** button (3) to select **SEARCH**.

- 3) Press **VOL ◀** button (2<sup>1</sup>) to search channels from current channel to lower channel, press **VOL ▶** button (2<sup>2</sup>) to search from current channel to higher channel. When a channel is located, the searching stops, this channel is then memorised with the preset channel number. If the channel is not the one you desire, please keep pressing **◀VOL** or **VOL ▶** button (2) to continue searching.

**!** **Note:** If you know the frequency value of the desired channel, you can directly input the value using the digit keys.

### 7.3 To skip unnecessary position numbers

After presetting the channels, you can skip unnecessary position numbers so that only the channels you want to watch are selected with **CH ▼** or **CH ▲** button.

- 1) Press the number button (4) or **CH ▲/▼** button (3) to select a channel number you want to skip.
- 2) Enter into the **PRESET** menu, press **CH ▲/▼** button (3) to select **SKIP**.
- 3) Press **VOL ◀/▶** button (2) to select **SKIP ✓ (ON)**. Thus, when you select channels with **CH ▲/▼** button (3), this channel will then be skipped.
- 4) To restore a skipped position number, select the position number you want to restore with the number buttons, enter into the **PRESET** menu to select **SKIP X (OFF)**.

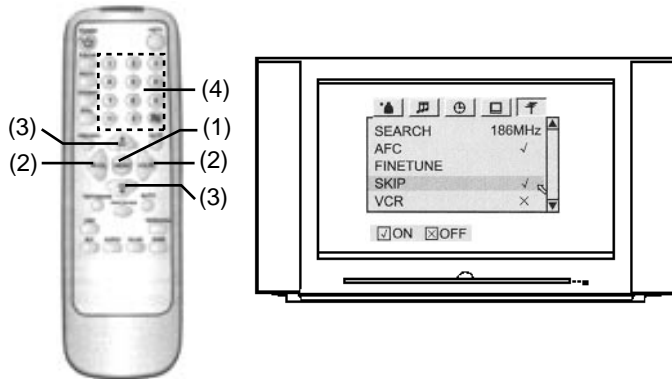

### 7.4 Fine Tune

When picture and sound's effect of a channel is poor (for example, one or two CATV channel's picture and sound are not standard), you can correct them by making use of Fine Tuning.

#### 7.4.1 AFC (Auto Frequency Control)

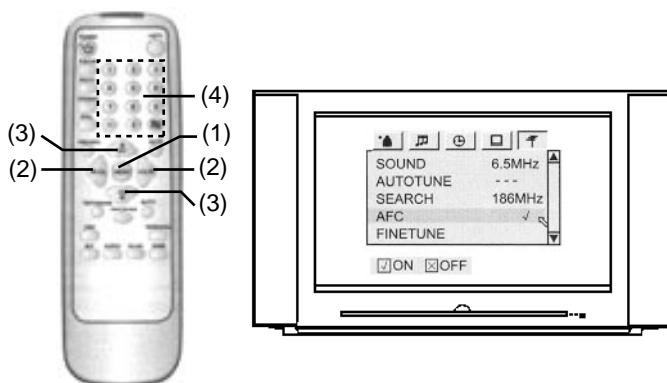

- 1) Press the number buttons (4) or **CH ▲/▼** button (3) to select the channel you want to fine-tune.
- 2) Enter into the **PRESET** menu, press **CH ▲/▼** button (3) to select **AFC**, then press **VOL ◀/▶** button (2) to select **AFC ✓** to activate it, the set begins fine-tune until the optimum picture and sound is achieved.

To use **AFC** is recommended. If you are not satisfied with the effects after the **AFC**, you can shut down **AFC** and make use of **FINE TUNE** until you get satisfied effect.

### 7.4.2 FINE TUNE

- 1) Press the number buttons (4) or **CH▲/▼** button (3) to select the channel you want to fine-tune.
- 2) Enter into the **PRESET** menu, press **CH▲/▼** button (3) to select Fine tune, then press and hold the **VOL◀** or **VOL▶** button (2) to begin fine-tune until the optimum picture and sound is achieved.

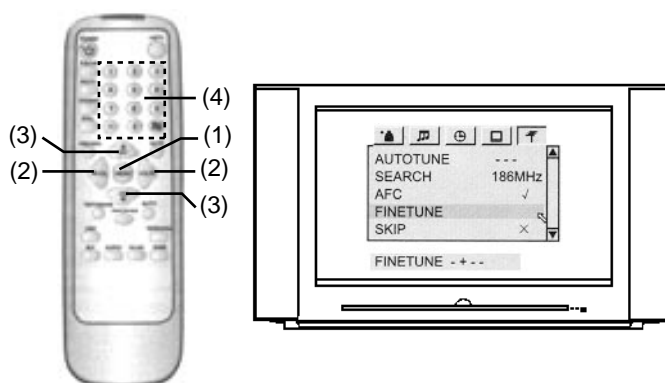

**!** **Note:** if some channel's colour or sound is abnormal, it may be that the setting of the colour or the sound system is wrong, please do adjustment according to "8.6 The setting of colour and sound system" to set the proper colour and sound system.

### 7.5 VCR

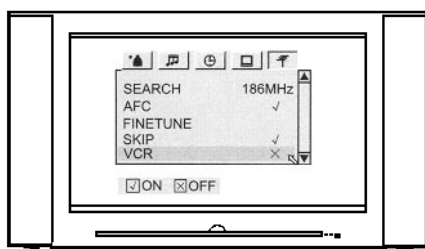

When receiving **VCR** programs, there may occur jump of the picture or bend of upper picture. You can solve this problem by activating **VCR** function. Please do the following steps: Enter into the **PRESET** menu, press **CH▼** or **CH▲** button to select **VCR** item, and press **◀VOL** or **VOL▶** button to set **VCR ✓ (ON)**. If you do not meet this problem, or the signal source is not from VCR, please shut off this function.

### 7.6 The setting of colour and sound system

#### 7.6.1 Use OSD button

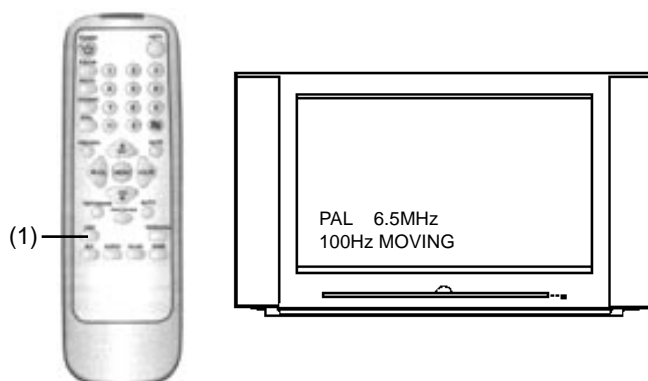

Press **OSD** button (1), the screen will display position number, colour and sound system. scan mode etc. Check whether the colour and sound system is correct.

### 7.6.2 The setting of colour system

- 1) Press the number buttons (4) or **CH ▲/▼** button (3) to select the channel you need to set the colour system.
- 2) Enter into the **PRESET** menu, press **CH ▲/▼** button (3) to select **SYSTEM**, then press **VOL ◀/▶** button (2) to select proper colour system. Every time you press **◀VOL** or **VOL ▶** button (2), the colour system will change in the sequence below:

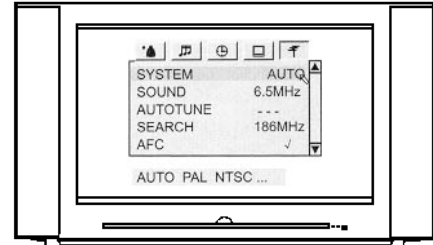
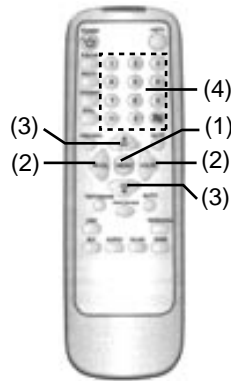

AUTO ↔ PAL ↔ SECAM ↔ PAL60 ↔ N443 ↔ NTSC

In normal circumstances, please set the colour system to AUTO, and the set can automatically select the proper colour system. If colour is still abnormal, then select the proper colour system manually.

### 7.6.3 The setting of sound system

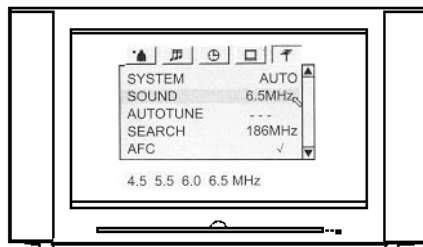
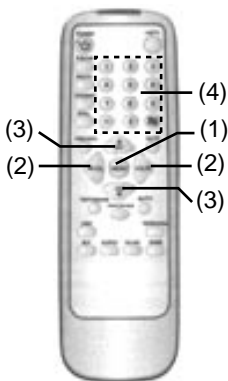

- 1) Press the number buttons (4) or **CH ▲/▼** button (3) to select the channel you need to set the sound system.
- 2) Enter into the **PRESET** menu, press **CH ▲/▼** button (3) to select **SOUND**, then press **VOL ◀/▶** button (2) to select proper sound system. Every time you press **◀VOL** or **VOL ▶** button (2), the sound system will change in the sequence below:

4.5MHZ ↔ 5.5MHZ ↔ 6.0MHZ ↔ 6.5MHZ

## 8. Channel selection

You can select your desired TV program by one of the following methods.

### 8.1 Using the direct select buttons (0-9 & -/-- button)

#### To select a one-digit position number

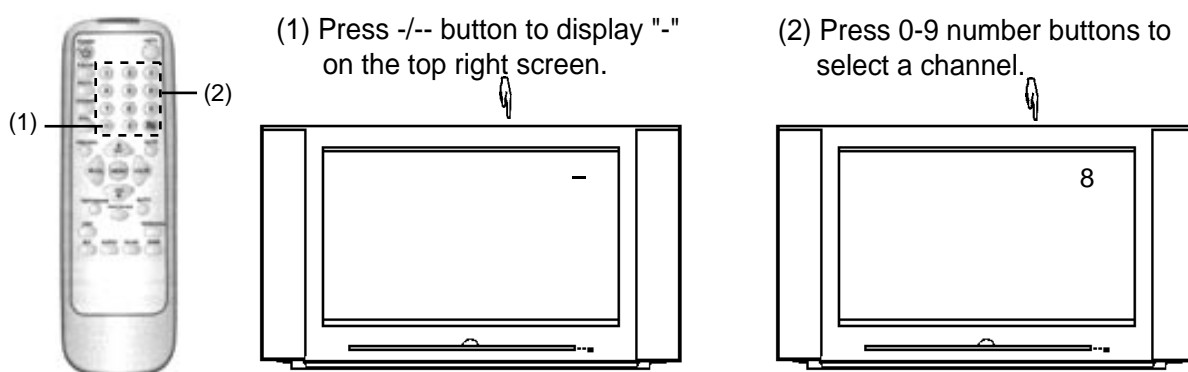

#### To select a two-digit position number

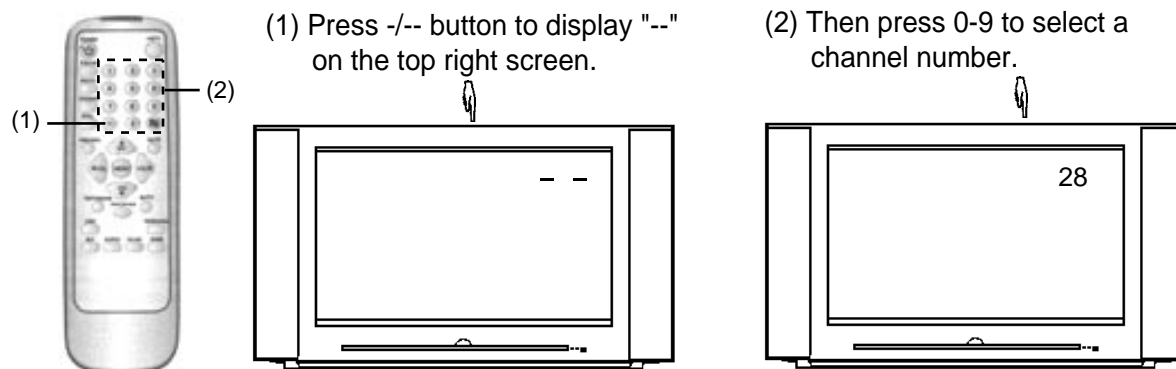

#### To select a three-digit position number

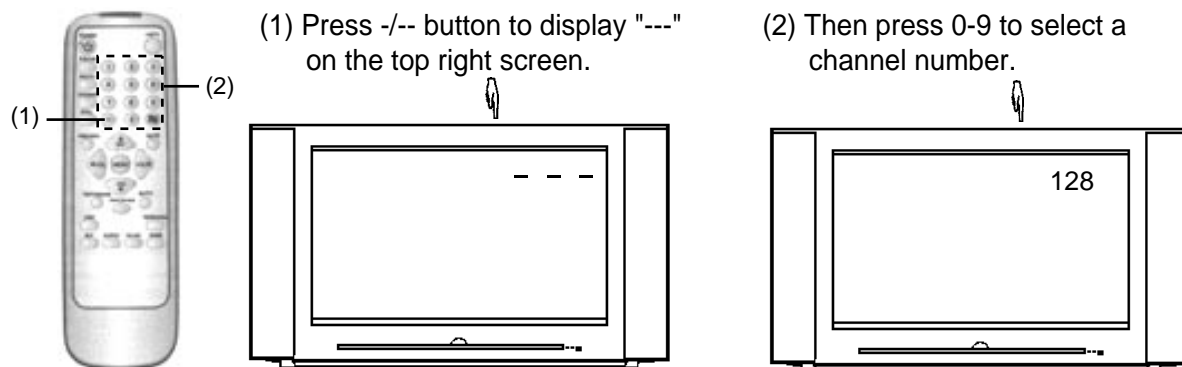

### 8.2 Using the CH▼ or CH▲ buttons

Press **CH▲** (1) to select higher position numbers; **CH▼** (2) to select lower ones.

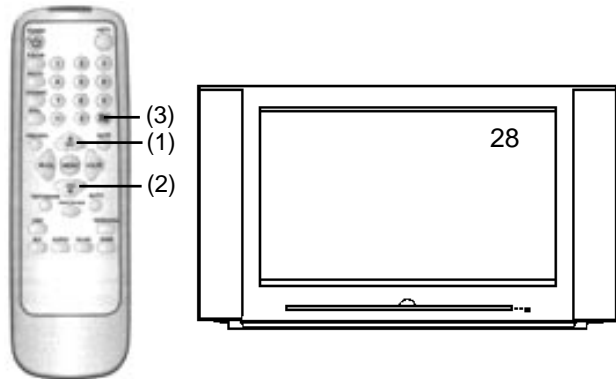

### 8.3 Using the PREVIOUS channel button (↔)

Press the ↔ button on the remote controller can swap the current viewed channel with the previous one.

**!** **Note:** Pressing the ↔ button can also switch between programs from RF, AV1, AV2, AV3, DVD IN, HDTV IN (but this button can not be used to switch between YPbPr and XGA).

### 8.4 Using the PREVIEW button

Press **PREVIEW** button to start scanning from the current channel to higher channel, 16 sub-pictures will fill up the whole screen one by one. You can press one of P.SCAN, PHOTO, DYNAMIC, STILL, 0-9, -/--, ↔ buttons on the remote controller to select a corresponding channel program.

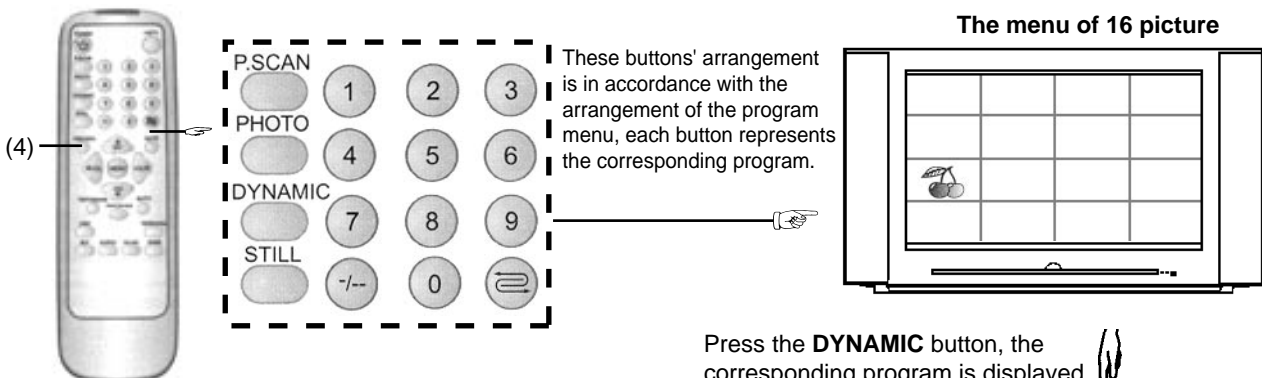

Press the **DYNAMIC** button, the corresponding program is displayed on the main screen.

If there are more than 16 programs, a new series of programs from 17th program will be displayed in turn, overwriting the previous screen until all the programs be displayed, and then recycle.

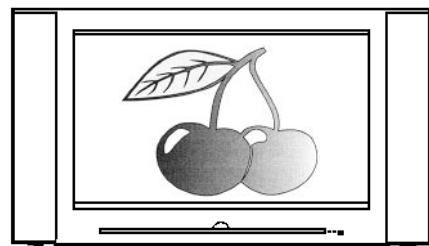

## 9. Picture and sound adjustments

### 9.1 Picture adjustment

#### 9.1.1 Making use of PERSONAL button

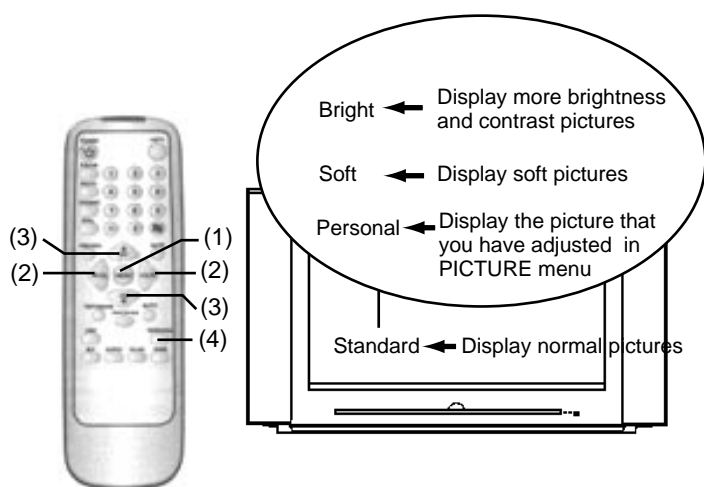

You can select the picture quality instantly among three preset modes and one user-set mode. Press the **PERSONAL** button (4) to select the desired picture quality. **STANDARD, BRIGHT, SOFT** and **PERSONAL** (user-set) can be selected cyclically. In these settings, brightness and contrast are different. You can select one of them to fit different environment and the program type. The picture quality you have set in PICTURE menu will be stored into PERSONAL.

#### 9.1.2 Making PICTURE menu

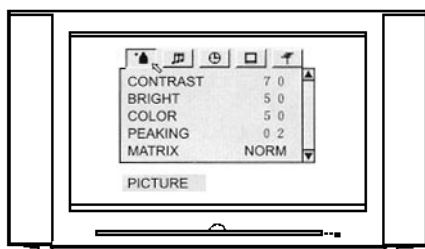

- 1) Press the **MENU** button (1) to enter into the main menu, press **◀VOL** or **VOL▶** button (2) to select PICTURE menu.
- 2) Press **CH▲/▼** (3) to cycle through the menu and select the desired adjusting item, press **VOL◀/▶** button (2) to adjust.

**!** **Note:** When watching moving pictures, do not set **DNR** to **MID** or **HIGH**, otherwise the receiving effects will be affected.

\*TINT is only for NTSC system.

\*There is no COMB item when in YCbCr or S-VIDEO input mode.



ITEM	PRESSING	
	◀ VOL	VOL ▶
CONTRAST	WEAKER	STRONGER
BRIGHT	DARKER	LIGHTER
COLOUR	PALER	DEEPER
PEAKING	LOWER	HIGHER
*TINT	-50~+50	
MATRIX	NORMAL/WARM/COLD	
CTI	ON/OFF	
*COMB	ON/OFF	
DNR	OFF/LOW/HIGH/MILD	
SVM	OFF/LOW/HIGH	

### 9.1.3 Making use of DYNAMIC button

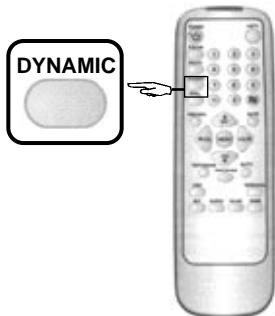

Press **DYNAMIC** button to switch the set between **STATIC** picture and **MOVING** picture mode according to the type of the program you are watching. For example, if you are watching programs in which characters are main and moving and changing are less such as stock information, selecting **STATIC** is suggested. If you are watching programs such as TV play or sports in which moving and changing are more and quicker, selecting **MOVING** is suggested.

### 9.1.4 Making use of P.SCAN button

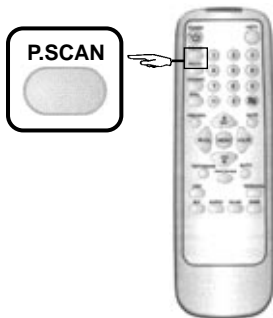

Press **P.SCAN** button to cycle through **AUTO SCAN/100Hz/P.SCAN** and select the proper scan mode in which most satisfying picture can be displayed. **Note:** In **AUTO SCAN** mode, the set can automatically set to 100Hz scanning when the signal source is in PAL system. When the signal source is in NTSC system, the set will automatically set to progressive scanning.

### 9.1.5 Making use of STILL button



Press **STILL** button to still the current picture, press it again to restore.

### 9.1.6 Making use of PHOTO Button

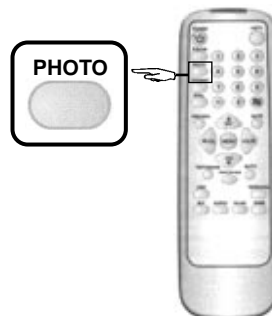

Press **PHOTO** button to caption moving picture into 4 successive frozen frames. In a certain interval a new series of "photo finish" picture is displayed, overwriting the old ones. Press the button again to cancel.

### 9.1.7 Making use of PANORAMA button

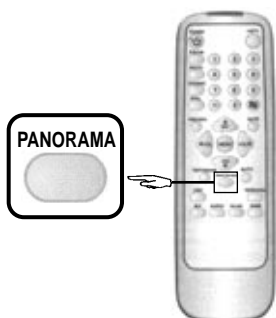

Press **PANORAMA** button to cycle through 16:9 Mode/PANORAMA/4:3 Mode /ZOOM/TITLE and select your desired screen aspect ratio. When you switch to other programs, the screen aspect ratio will restore to the default one. If you wish to keep your selected screen aspect ratio even when changing programs, please enter into the **OPTION** menu and select **Default** item to set the default screen aspect ratio.

**16:9 mode** expands the conventional 4:3 picture into a full 16:9 picture and at the same time still maintains the height of the picture. Or view DVD program, movie in 16:9 mode.

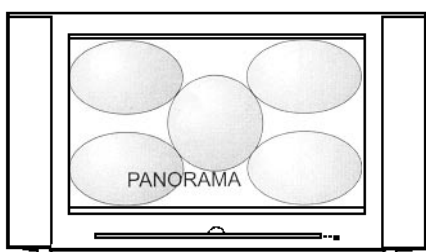
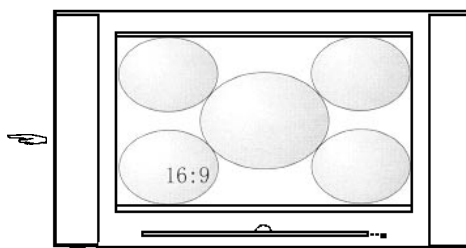

**PANORAMA** mode expands the conventional 4:3 picture into a full 16:9 picture and at the same time still maintains a good aspect ratio at the centre of the screen. This will minimise distortion and produce a remarkable panoramic picture.

The **4:3 mode** leaves conventional 4:3 picture as they are, with black bars on both sides of your screen.



**Note:** the **4:3 display mode** is one which is suggested not to use. When the current picture's brightness changes largely, there occurs blurry and tingling on picture's left and right sides, or when picture's upper and lower part's brightness differs greatly, there is tilt on picture's sides, these are normal phenomena, it is not necessary to worry about them.

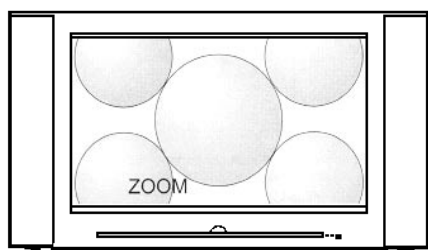
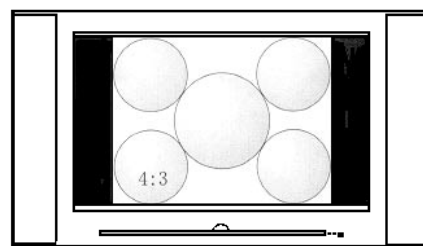

This feature is recommended for viewing "letter-box" movie (picture with a black bar on the top and bottom) with 16:9 format. When you select this mode, you are able to fill up the whole screen. If you watch a 4:3 picture in this mode, the picture will be expanded and some information at the top and bottom will be lost.

**Title** mode moves the picture in ZOOM mode upward so that when viewing programs with title at the bottom, the bottom title can be revealed.

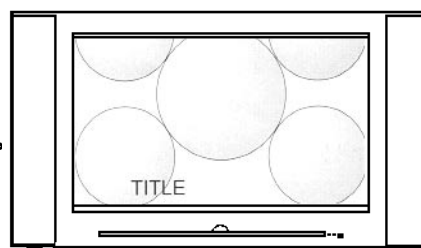

## 9.2 Sound adjustment

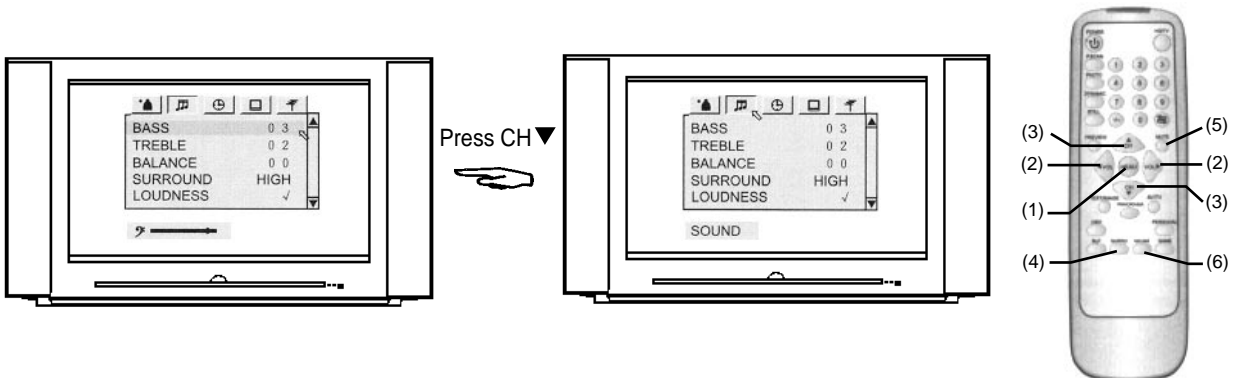

- 1) Press the MENU button (1) to enter into the main menu, press ◀ VOL or VOL ▶ button (2) to select SOUND menu.
- 2) Press CH ▲/▼ button (3) to cycle through the menu and select the desired adjusting item, press VOL ◀/▶ button (2) to adjust.

### 9.2.1 Bass/Treble adjustment

In SOUND menu select BASS or TREBLE, press ◀ VOL or VOL ▶ button (2) to adjust the level.

### 9.2.2 BALANCE adjustment

In SOUND menu select BALANCE, press ◀ VOL or VOL ▶ button (2) to adjust the level. Press ◀ VOL button (2) to decrease the right channel's sound, press VOL ▶ button (2) to decrease the left channel's sound.

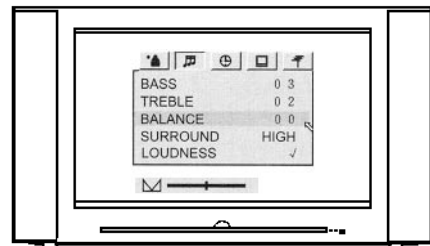

### 9.2.3 Making use of Surround sound

Making use of surround sound, you can enjoy the dynamic sound effect that is like being in a music hall. Enter into the SOUND menu and select SURROUND, press ◀ VOL or VOL ▶ button (2) to select SURROUND OFF/LOW/HIGH.

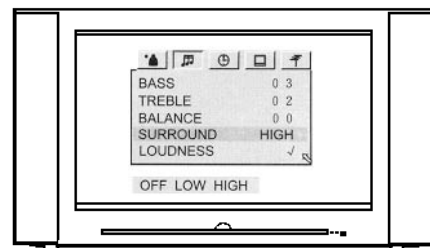

or you can directly press the SURRD button (4) on the remote controller to select **SURROUND OFF/HIGH/LOW** to get the optimum surround sound effect.

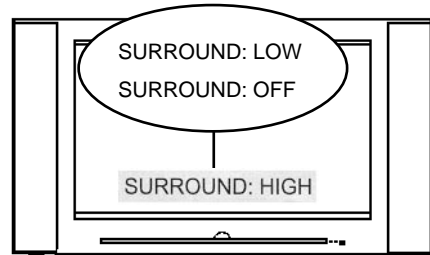

### 9.2.4 Making use of LOUDNESS

In **SOUND** menu select **LOUDNESS**, press ◀**VOL** or **VOL**▶ (2) to select **LOUDNESS ON/OFF**. When selecting **LOUDNESS ON**, you can let the ears enjoy enough bass and treble even if the volume is lower.

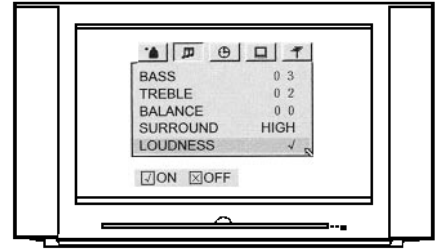

### 9.2.5 Volume adjustment and sound mute

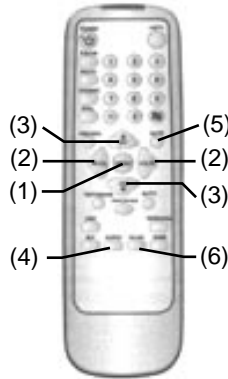
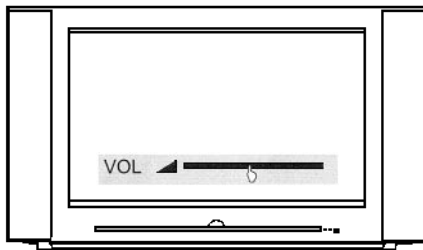

Press ◀ **VOL** or **VOL** ▶ (2) to adjust the volume.

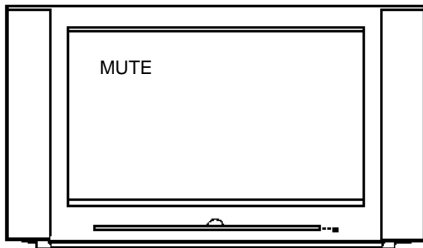

Press **MUTE** button (5) to mute the sound temporarily and press it again to restore the sound.

### 9.2.6 NICAM function

This set can identify NICAM program. If you are receiving NICAM program and you want to get NICAM effect, please press **NICAM** button (6) on the remote controller to select NICAM. Press the NICAM button again the set will restore to FORCE FM mode. If the program is an ordinary one without NICAM, pressing this button has no effect.

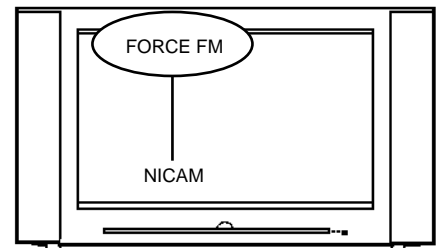

## 10. TIMER setting

The **TIMER** setting you have made will restore to default value in about 6 seconds after you turn off the set.

Press the **MENU** button (1) to display the main menu, press **◀VOL** or **VOL▶** (2) to select **TIMER** menu, press **CH▲/▼** (3) to cycle through the menu and select the desired item.

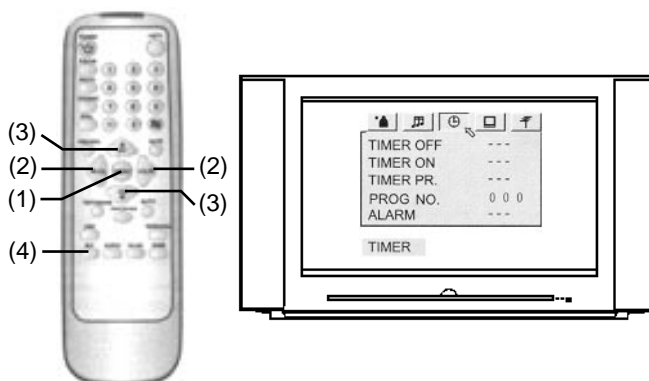

### 10.1 OFF timer

With the OFF timer, the TV will automatically switch to standby mode at a preset time. The setting steps are as follows:

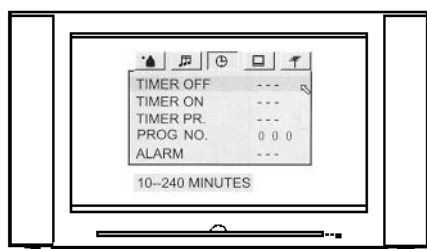

In **TIMER** menu press **CH▼** or **CH▲** button (3) to select **Timer Off** and press **◀VOL** or **VOL▶** button (2) to set the time after which you want to turn off the set. (from 10-240 minutes and in 10-minute step). If you want to cancel OFF timer, press **◀VOL** or **VOL▶** button (2) until "----" is displayed.

You can also make use of **SLEEP** timer function to turn off the set automatically after a preset time, and bring the set to standby mode. Every time you press the **SLP** button (4) the timer will skip to the next one (in 10-minute step) until it reaches to 240 minutes. Press it again, the timer returns to ---, and the sleep timer is cancelled.

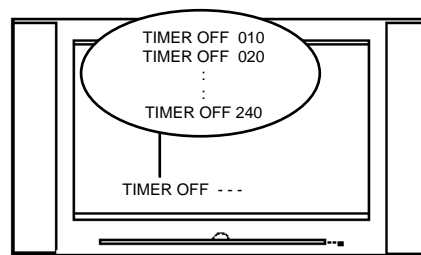

### 10.2 ON timer

With the ON timer, the TV which is at standby mode will automatically turn on at a preset time. The setting steps are as follows:



Press **CH▼** or **CH▲** (3) to select **Timer On** and press **◀VOL** or **VOL▶** (2) to set the TV ON time (range from 10-720 minutes and in 10-minute step). If you want to cancel ON timer, press **◀VOL** or **VOL▶** (2) until "----" is displayed. Note: when the ON timer setting is effective, the green timer indicator will light up to inform the user.

### 10.3 ALARM timer

This function allows the to alarm automatically at the preset time. The setting steps are as follows:

Press **CH▼** or **CH▲** button (3) to select **Alarm**, then press **◀VOL** or **VOL▶** button (2) to set the amount of time after which you want the TV to alarm (range from 10-240 minutes and in 10-minute step). If you want to cancel ALARM timer, press **◀VOL** or **VOL▶** (2) until is "---" displayed.

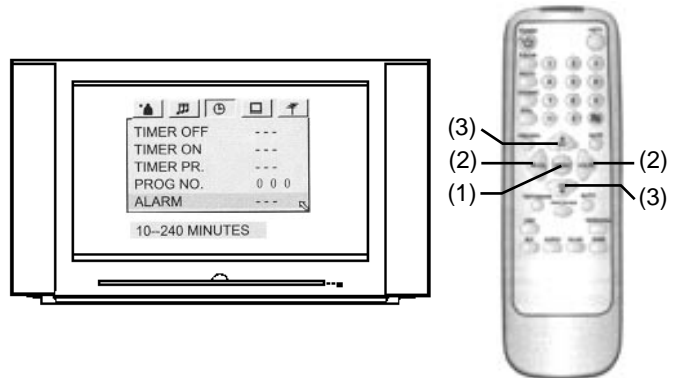

### 10.4 Program timer

This function allows the set to automatically switch to the preset channel at a preset time. The steps are as follows: Press **CH▼** or **CH▲** (3) to select **TIMER PR.**, then press **◀VOL** or **VOL▶** (2) to set the amount of time after which you want the TV to switch. (range from 10-240 minutes and in 10-minute step). If you want to cancel this function, press **◀VOL** or **VOL▶** (2) until "---" is displayed.

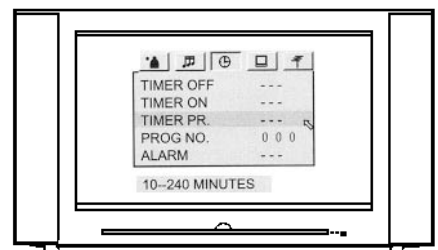

### 10.5 Prog Number

Making use of this function to set the program number which you want the set to switch to automatically at the preset time. The steps are as follows: Press **CH▼** or **CH▲** (3) to select **PROG NO.**, press **◀VOL** or **VOL▶** (2) to set the program number which you want the TV to switch to. If you want to cancel this function, press **◀VOL** or **VOL▶** (2) until "000" is displayed.

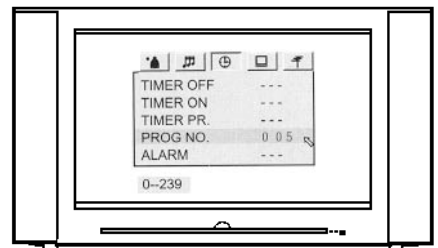

## 11. Making use of **OPTION** menu

Press the **MENU** button (1) to display the main menu, press **◀VOL** or **VOL▶** button (2) to select **OPTION** menu. Press **CH▲/▼** button (3) to cycle through the menu and select the desired item.

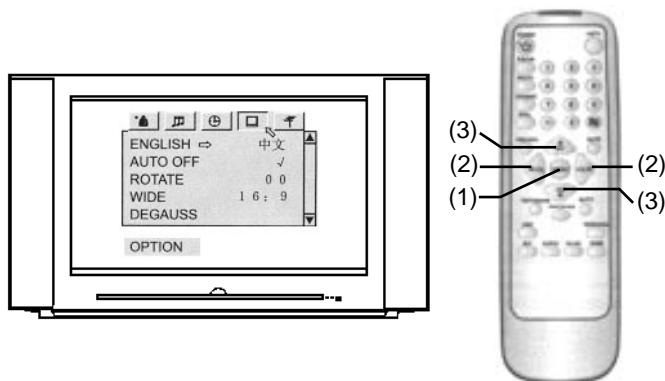

### 11.1 OSD language selection

In **OPTION** menu, press **CH▼** or **CH▲** (3) to select **ENGLISH** item, press **◀VOL** or **VOL▶** (2) to switch the OSD language between **ENGLISH** and **CHINESE**.

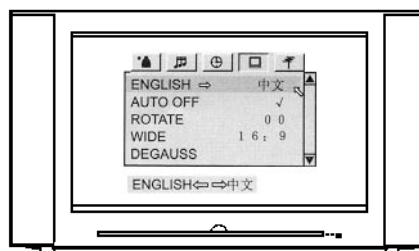

### 11.2 AUTO-POWER-OFF function

With **AUTO-POWER-OFF** function **ON**, the TV will automatically turn off after about certain minutes if a vacant channel is tuned or TV broadcast for a day is finished or no signal is being received.

Enter into the **OPTION** menu, press **CH▼** or **CH▲** (3) to select **AUTO OFF**, press **◀VOL** or **VOL▶** (2) to switch between **✓** (**ON**) and **X** (**OFF**).

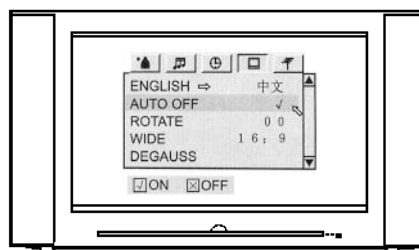

### 11.3 Rotate function

When you switch on your TV, there may be a slight tilt of the picture to the left or right. This is due to the earth's magnetic field or position of your TV. To rectify, you can do the following.

Enter into the **OPTION** menu, press **CH▼** or **CH▲** button (3) to select **ROTATE**, press **◀VOL** or **VOL▶** button (2) to tilt the picture leftward or rightward until you rectify it.

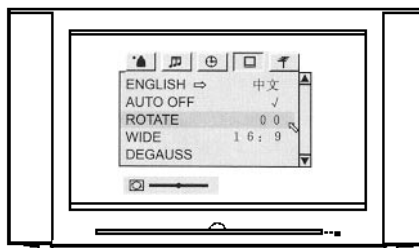

### 11.4 Default screen aspect ratio setting

Making use of this function can set the default screen aspect ratio.

Enter into the **OPTION** menu, press **CH ▼** or **CH ▲** button (3) to select Default, press **◀ VOL** or **VOL ▶** button (2) to cycle through 16:9, PANORAMA, 4:3, ZOOM, TITLE and make your choice to set the default screen aspect ratio. Later on, when you switch channels, the screen will remain in the default aspect ratio.

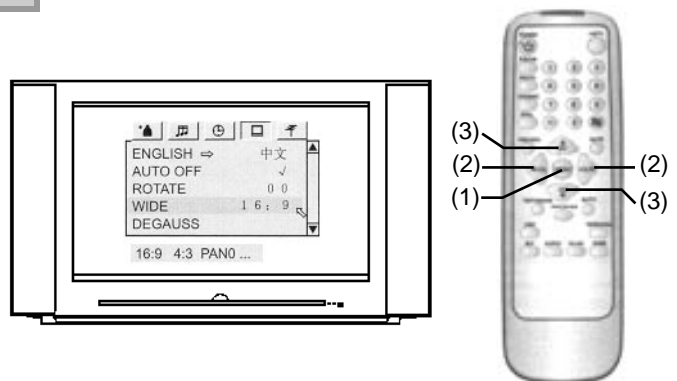

### 11.5 Picture moving

In **OPTION** menu, if you have set **TITLE** for default screen aspect ratio, then **P.MOV** menu item will appear below **WIDE** item. Select **P.MOV**, then press **◀ VOL** or **VOL ▶** button (2) to move the picture downward or upward, thus to adjust the position of the title. After completion, exit the menu, and the title position will be memorised.

**Note:** If you set the current channel's screen to TITLE by pressing PANORAMA button, enter into the **OPTION** menu and adjust P.MOV, the title position can not be memorised.

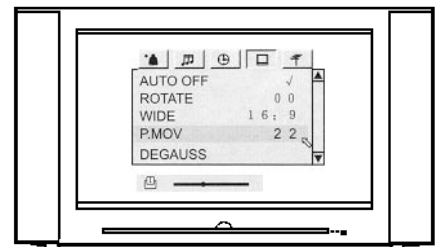

### 11.6 Degaussing

If there occurs magnetisation, please do the following to degauss the set:

Enter into the **OPTION** menu, press **CH ▼** or **CH ▲** button (3) to select **Degauss**, then press **◀ VOL** or **VOL ▶** button (2) the degaussing circuit begins to work. If still can not degauss thoroughly, please repeat the above operation after 15-20 minutes until magnetisation disappear.

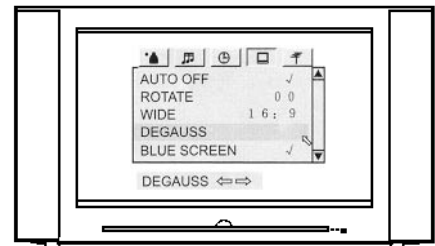

### 11.7 Blue screen setting

With the **BLUE SCREEN** function ON, the TV will automatically turn blue when no signal is being received. Otherwise snowy picture will appear on the screen when no signal is being received.

Enter into the **OPTION** menu, press **CH ▼** or **CH ▲** (3) to select **BLUE SCREEN**, press **◀ VOL** or **VOL ▶** (2) to switch between ✓ (ON) and X (OFF).

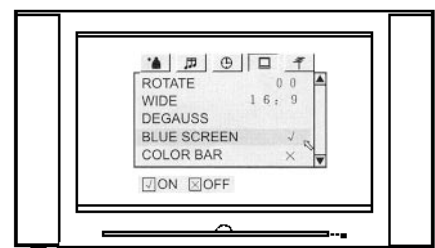



### 11.8 Colour bar signal

The colour bar signal is an alignment signal used by service personnel to check the set, and common user is suggested not to use it.

Enter into the **OPTION** menu, press **CH▲** or **CH▼** button (3) to select **COLOUR BAR**, then press **VOL◀** or **VOL▶** button (2) to open (✓) or shut off (X) the colour bar.

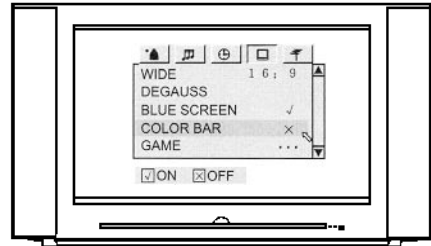

### 11.9 Game

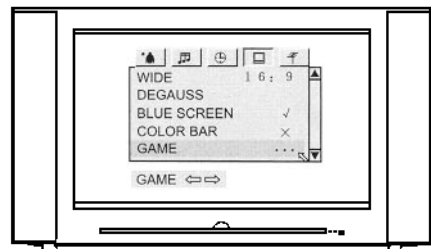
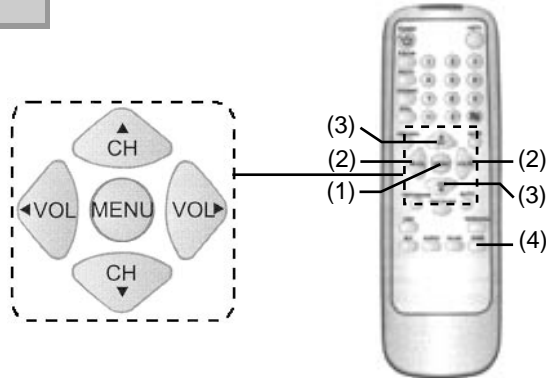

Making use of this function allows you to play game- **FALLING CUBE**.

Press **GAME** button (4) or enter into the **OPTION** menu and select **GAME** item, then press **◀VOL** or **VOL▶** (2) to enter into the game-playing interface.

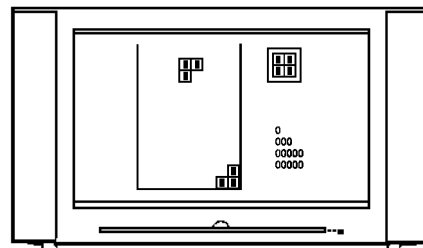

Press **CH▲**, **CH▼** or **◀VOL**, **VOL▶** button to play the game.

**◀VOL**, **VOL▶** button (2): move the cube leftward/rightward.

**CH▲** button (3): rotate the cube.

**CH▼** button (3): accelerate the falling cube's speed.

If you want to change the playing difficulty, in game starting page or wait until the current game ends and the grade is 0, press **CH▲**, **CH▼** button (3) to change the game grade, then press the **MENU** button (1) to restart the game.

**MENU** button (1): start or pause the game.

**Exit the game:** pressing any button except the above control buttons can exit.

**Pause the game:** exit the game following the above way and do not turn off the set, then the last game-playing status will be stored automatically. Enter the game again, you can continue to play.

## Menu operation in video mode

You can connect video equipments such as a VCD, VTR to this TV and enjoy the program playbacked by the video equipment. Press the **AV/TV** button to display the signal source selection menu and then select video mode.

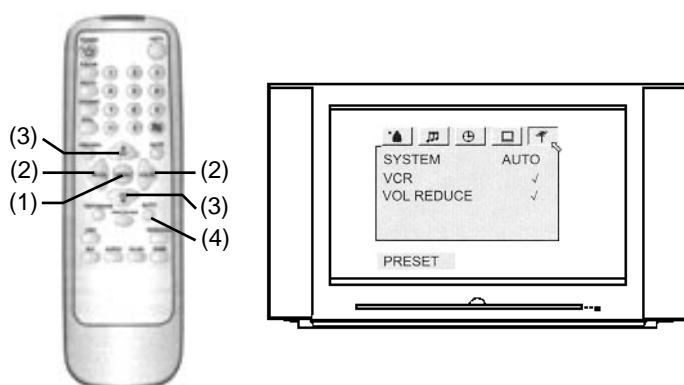

### Colour system setting

As same as 7.6.2 "The setting of colour system"

### VCR

Normally when watching VCR (video cassette recorder) program, the picture is normal, selecting **VCR X (OFF)** is OK. But since some cassette's quality is poor, and non-synchronous phenomenon may occur, the picture's top is distorted and is abnormal. At this time, please set **VCR √ (ON)**, and the picture will be normal. Please do the following steps:

Press the **MENU** button (1) to display the main menu, press **VOL ◀** or **VOL ▶** button (2) or select **PRESET** menu, press **CH ▲/▼** button (3) to select **VCR**, then press **VOL ◀** or **VOL ▶** button (2) to set **VCR √ (ON)**.

**!** **Note:** when the signal source is not from **VCR** (that is, not from video **cassette** recorder), please set **VCR X (OFF)**.

### VOLUME REDUCE

When the sound is too loud and coarse and in distortion, you can activate **VOLUME REDUCE** function to reduce the sound.

Enter into the **PRESET** menu, press **CH ▼** or **CH ▲** button (3) to select **VOL REDUCE**, press **◀ VOL** or **VOL ▶** button (2) to set **VOL REDUCE √ (ON)**, otherwise set **VOL REDUCE X (OFF)**.

**!** **Note:** as regards to the other menu items' adjustment, please refer to the instructions described in the previous pages.

## Menu operation in YCbCr mode

You can connect the set to DVD or other equipment with YCbCr terminal. Press the **AV/TV** button (4) to display the signal source selection menu and then select **YCbCr**.

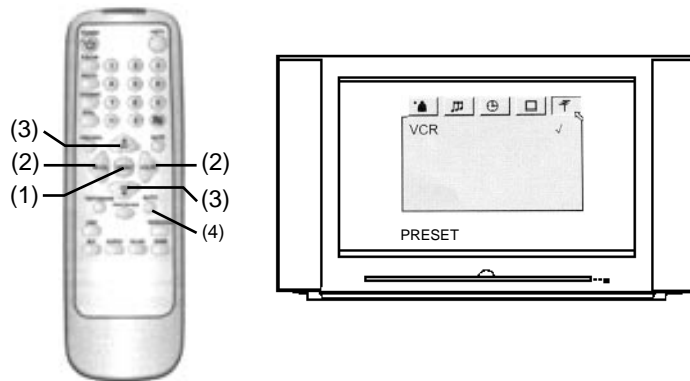

**!** **Note:** as regards to the menu operation and menu item adjustment in YCbCr mode, please refer to the instructions described in the previous pages.

## Operation in HDTV mode

### 12. Buttons' function

When the signal source is input through XGA interface or YPbPr terminals, then the set will work in HDTV mode

**MENU** (1) on the set or **MENU** (1) on the remote controller: It is used to call up OSD menu, or to enter or exit from the selected menu item after OSD menu is activated.

**CH+** (3) on the set or **CH▲** (3) on the remote controller: It is used to move the cursor upward or clockwise after OSD menu is activated, or increase the value of parameter after menu item is selected.

**CH -** (3) on the set or **CH▼** (3) on the remote controller: It is used to move the cursor downward or anti-clockwise after OSD menu is activated, or decrease the value of parameter after menu item is selected.

**TEXT/IMAGE** (4): It is used to cancel the OSD menu after OSD menu is activated. It is also used to switch between text mode and image mode (in either mode contrast and brightness are different).

The sound control buttons are as same as the sound buttons introduced in **Sound adjustments** in page 23 and 24. The audio parameters you have set in RF mode such as Bass, Treble and Loudness also function in HDTV mode.

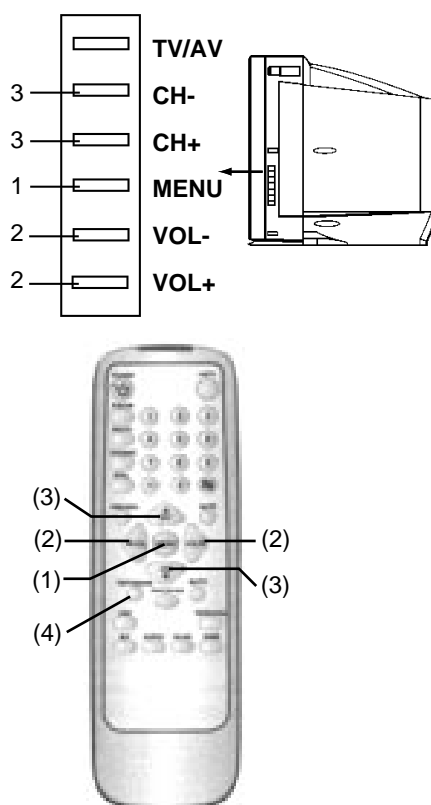

## 13. Signal source selection

If you previously watch programs in RF mode and now you want to watch HDTV programs, please first press the **AV/TV** button (4) call up the signal source selection menu, press the **CH ▲** or **CH ▼** button (3) to select HDTV-XGA or YPbPr, and press **VOL ◀** or **VOL ▶** button (2) to confirm your choice. Later you can directly press **HD/TV** button (5) to switch between the previous RF mode and HDTV mode.

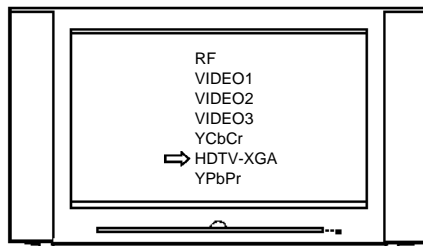
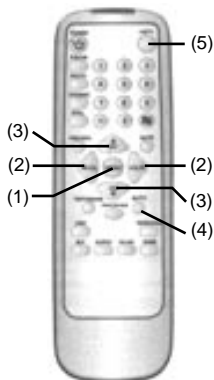

If your selected terminal has no input signal source, the screen will display **"NO SIGNAL"**.

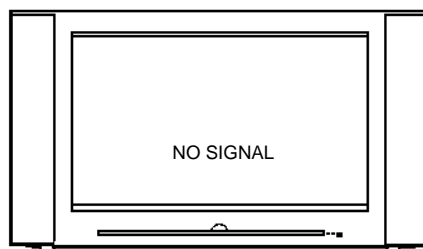

At this time please press **MENU** button (1) to call up **HDTV SOURCE** menu, press **CH ▲** or **CH ▼** button (3) to select the other terminal which has signal input and press **MENU** button (1) to confirm. Then you can enjoy the program

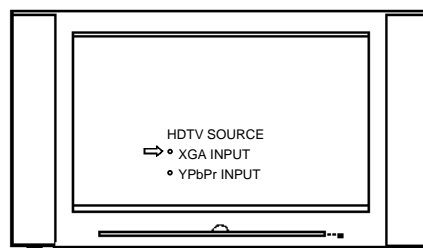

If both the XGA and YPbPr have signal source and you want to switch from the current signal source to the other signal source (for example, you are watching XGA program and then you want to watch program from YPbPr), please press **MENU** button (1) to call up the main menu, press **CH ▲** or **CH ▼** button (3) to select  ( XGA ↔ YPbPr), then press **MENU** button (1) the signal source is switched over.

Moreover, there is only one group of audio input terminals in HDTV mode, therefore you can only select to connect either XGA or YPbPr audio terminals.

## 14. OSD menu introduction

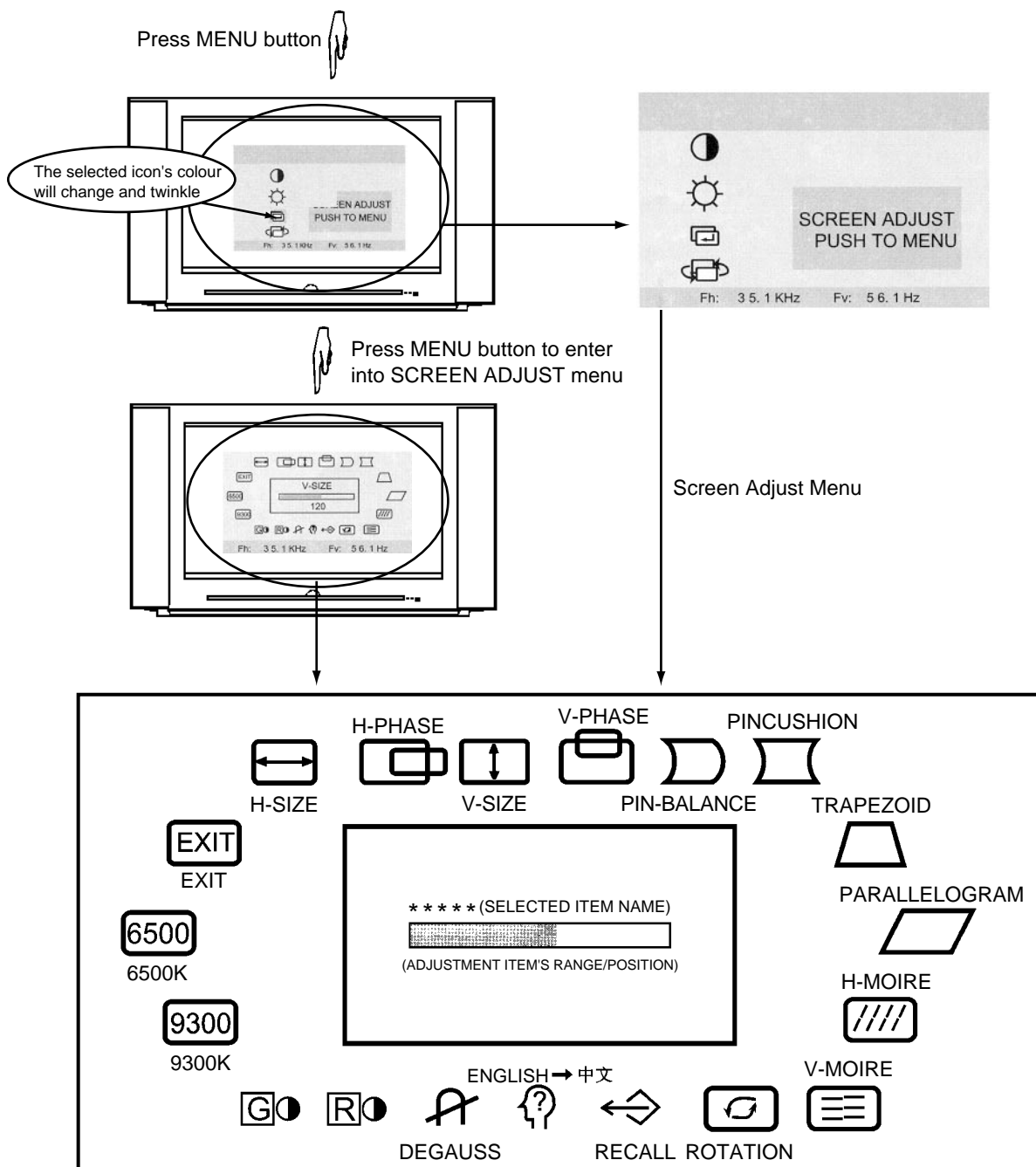

## 14.1 Menu introduction

CONTRAST		Adjust the picture contrast.
BRIGHTNESS		Adjust the picture brightness.
H-SIZE		Adjust the picture s horizontal size.
H-PHASE		Adjust the horizontal position of the picture.
V-SIZE		Adjust the pictures vertical size.
V-PHASE		Adjust the vertical position of the picture.
PIN-BALANCE		Balance pincushion distortion.
PINCUSHION		Pincushion correction.
TRAPEZOID		Correct the trapezoid distortion.
PARALLELOGRAM		Adjust the angle between horizontal and vertical
H-MOIRE		Eliminate horizontal moire.
V-MOIRE		Eliminate vertical moire.
ROTATION		Rotate the current picture.
RECALL		To restore to original factory preset mode.
ENGLISH/CHINESE		English/Chinese menu on-screen display language selection.
DEGAUSS		Manually degauss the set
R		Adjust white balance R at current colour temperature (red adjustment).
G		Adjust white balance G at current colour temperature (green adjustment).
9300K		Restore the current picture s colour temperature to 9300K.
6500K		Restore the current pictures colour temperature to 6500K.
EXIT		Exit the current OSD and store all the current adjusted parameters.

**Notes:**

When the HD monitor gets signal from external equipment (such as Set top box, computer, DVD, etc. ) through XGA interface or YPbPr terminals, because of signal difference, the screen colour may not be in optimum state, this time, you can adjust and item in the SCREEN ADJUST menu until you get satisfying colour.

Using or can restore the value of and to default setting.

## 14.2 Contrast, Brightness adjustment

- 1) Press **MENU** button (1) to call up the OSD main menu.
- 2) Press **CH▲** button (3) or **CH▼** button (3) to move the cursor upward or downward and select ☉(Contrast) or ☀(Brightness). (The colour of the selected icon will change and glitter).
- 3) Press **MENU** (1) to enter into the submenu.
- 4) Press **CH▲** or **CH▼** (3) to adjust the level.
- 5) Press **MENU** (1) to exit from the adjustment of current item.

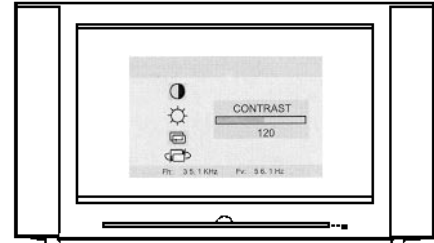
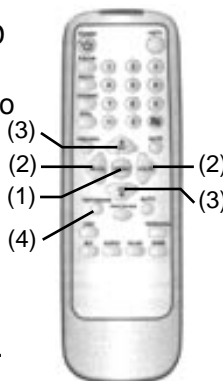

Repeat the above 2 - 5 steps if you want to continue the adjustment. After completion of the adjustment, press **TEXT/IMAGE** button (4) to exit the main menu, or you can wait for some time and the menu will automatically disappear.

## 14.3 To switch between text mode and image mode

- 1) Press **TEXT/IMAGE** button (4) can switch between **Text** mode and **Image** mode. In either mode, the contrast and brightness are different.
- 2) Press **MENU** button (1) to exit. Or you can wait for some time and the OSD will automatically disappear.
- 3) If you are not satisfied with current status' contrast and brightness, you can adjust them in the main menu.

## 14.4 Volume adjustment

- 1) Press **◀ VOL** or **VOL ▶** button (2) to adjust the volume.
- 2) Press **TEXT/IMAGE** button (4) to exit. Or you can wait for some time and the OSD will automatically disappear.

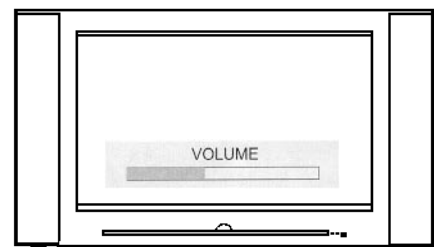



### 14.5 Screen adjustment

The screen adjustment includes H-SIZE, H-PHASE, V-SIZE, V-PHASE, PIN-BALANCE, PINCUSHION, TRAPEZOID, PARALLELOGRAM. H-MOIRE, V-MOIRE, ROTATION, etc.

1. Press **MENU** button to call up the main menu, press **CH▲** or **CH▼** button to move the cursor to **SCREEN ADJUST** icon.
2. Press **MENU** button again to enter into **SCREEN ADJUST** sub-menu.
3. Press **CH▲** or **CH▼** button to move the cursor and select your wanted menu item.
4. Press **MENU** button to confirm the choice. If the value of the item is adjustable, go to the next step, otherwise go to above 3 step after completion of switch operation if you want to continue the adjustment.
5. Press **CH▲** or **CH▼** button to adjust the level until you are satisfied.
6. Press **MENU** button to exit this item's adjustment.
7. Repeat the above 3-6 steps to adjust other items. After completion of adjustment, select **EXIT** icon or press TEXT/IMAGE button to exit the **SCREEN ADJUST** menu. Or you can wait for some time and the OSD will automatically disappear.

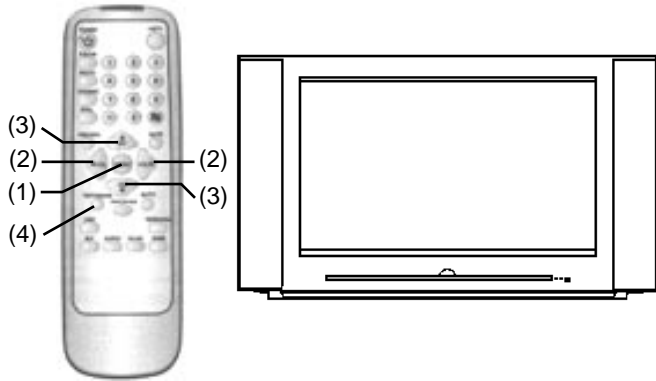

### 14.6 Function menu item's selection

**RECALL:** It's used to restore parameters of the current display mode to factory default setting.

**EXIT:** It's used to exit the current OSD menu.

**DEGAUSS:** It's used to activate the degaussing circuit. (To conduct the next degauss operation you should wait for 10-20 minutes).

**6500:** It's used to set the state of colour temperature which suits for professional departments such as television and broadcast station.

**9300:** It's used to set the state of colour temperature which suits for general user.

### 14.7 Audio adjustment

To adjust Bass, Treble, Surround sound, Balance, please switch to RF mode and operate them (please refer to **Sound adjustment** on page 23 and 24 ). The audio effects you get in RF mode also function in HDTV mode.

## 15. Display mode setting

In factory the set has been set with multi display modes which are frequently-used at present. (See **17. Specifications** on page 40 ). With the development of digital processing technology, in the future there are external equipment with different display modes. If user discovers the input signal's display mode is different, while the horizontal and vertical frequency accords with the requirement of the set, the set can also support this display mode. It can support and store up to 8 new display modes. User is only required to adjust this mode's display parameters to satisfying status according to **Operation in HDTV mode** and the adjusted parameters will be stored into the MEMORY automatically even if you turn off the set.

### Displaying pattern

Item No.	Displaying pattern	H-frequency V-frequency	Adoptive Standard	Aspect ratio
1	720 x 600 I	31.25KHz/100Hz	PAL 100Hz	4:3/16:9
2	720 x 600 P	31.25KHz/50Hz	PAL progressive	4:3/16:9
3	720 x 500 I	31.25KHz/120Hz	NTSC 120Hz	4:3/16:9
4	720 x 500 P	31.25KHz/60Hz	NTSC progressive	4:3/16:9
5	1920 x 1080 I	28.125KHz/50Hz	China HDTV interlace	16:9
6	1920 x 1080 I	33.75KHz/60Hz	American HDTV standard interlace	16:9
7	1280 x 720 P	45KHz/60Hz	American HDTV standard progressive	16:9
8	640 x 480 P	31.5KHZ/60Hz	PC VGA	4:3
9	640 x 480 P	37.8KHz/75Hz	PC VGA	4:3
10	720 x 400 P	31.5KHZ/70Hz	PC VGA	4:3
11	800 x 600 P	37.88KHZ/60HZ	PC SVGA	4:3
12	800 x 600 P	46.8KHz/75Hz	PC SVGA	4:3
13	1024 x 768 P	48.4KHz/60Hz	PC XGA	4:3

## 16. Troubleshooting Guide

Before calling service personnel, please check the following chart for a possible cause to the trouble you are experiencing.

Symptoms	Check the following items
The screen has no content, the power indicator is not lit up.	Be sure the power cord is plugged in.
The screen has no content, the power indicator is red.	The set is in stand-by mode. Press the power button on the remote controller to turn on the set.
Poor colour, poor tint	Contrast, colour, tint are not correctly adjusted.
Stripes appear on the screen	Possible interference of electronic interference from another TV set, a computer, an electronics game machine, a broadcast station, etc.
Spots appear on the screen	Possible interferences of automobiles, motorcycle, trolley bus, neon lamps, etc.
Double images or "ghosts"	This may be caused by reflections from nearby mountains or buildings. Check the antenna direction.
Snowy picture	It is possible that the aerial "lead-in" is damaged or comes off. Check the antenna direction.
The remote controller does not work	The batteries may be worn out. The batteries may be installed with their polarity reversed.
TV cabinet creaks	Even if the picture or sound is normal, changes in the room temperature sometimes make the TV cabinet expand or contract, making a noise. This does not indicate a malfunction.
Magnetisation phenomenon, colour spots in the screen.	Using the remote controller to turn off the set or moving the set around may result in magnetisation phenomenon. When magnetisation appears, please enter into the OPTION menu and select DEGAUSS item to degauss the set (recommended). Or by switching off the set and waiting for 10 minutes before switching on again can eliminate it.

## 17. Specifications

### ● Monitor

Display field	Min. 659 x 370 (unit: mm)
Horizontal frequency	28KHz - 48KHz
Colour temperature	6500 <sup>0</sup> K/9300 <sup>0</sup> K
RGB bandwidth	30MHz
Video adaptor card	VGA, S-VGA, VESA VGA, XGA
XGA cable	15-pin D-Sub type (Standard VGA cable)

### ● TV

TV system	PAL/SECAM/NTSC
CATV	Hyperband
Search	Auto search/Manual search
Picture	5D picture improver
S-video/Video/Audio input	Three groups
RF IN, DVD IN	One group respectively
AV OUT	One group
Additional functions	ON/OFF timer, AUTO-POWER-OFF, No-signal blue background display, games, etc.

### ● The whole unit

Power supply	AC 240V, 50Hz
Power consumption	230W
CRT	76cm
Sound output	8W x 2
External control mode	I <sup>2</sup> C bus control
Surround sound	Yes
Full function remote control	Yes
Dimensions	968 (W) x 570 (D) x 564 (H) mm
Weight	66 kg
Stored Temperature	-10 <sup>0</sup> C~50 <sup>0</sup> C
Working Temperature	0 <sup>0</sup> C~40 <sup>0</sup> C
Accessories	XGA D15 signal cable x 1, Remote controller x 1, Power cord x 1, RF cable x 1, Instruction manual x 1

**Note:** Design and specifications are subject to change without notice.

PALSONIC CORPORATION PTY LTD  
1 JOYNTON AVENUE  
WATERLOO NSW 2017 AUSTRALIA  
TEL: (02) 9313 7111  
FAX: (02) 9313 7555  
[www.palsonic.com.au](http://www.palsonic.com.au)

**PALSONIC CUSTOMER SERVICE  
TELEPHONE  
AUSTRALIA: 1300 657 888**

604-32613-00

## Free Manuals Download Website

<http://myh66.com>

<http://usermanuals.us>

<http://www.somanuals.com>

<http://www.4manuals.cc>

<http://www.manual-lib.com>

<http://www.404manual.com>

<http://www.luxmanual.com>

<http://aubethermostatmanual.com>

Golf course search by state

<http://golfingnear.com>

Email search by domain

<http://emailbydomain.com>

Auto manuals search

<http://auto.somanuals.com>

TV manuals search

<http://tv.somanuals.com>