

OWNER'S MANUAL

Palsonic

**107CM CORDLESS REMOTE PLASMA TELEVISION & MONITOR
MODEL: PDP4290HD**



N111

**PALSONIC CORPORATION PTY LTD
1 JOYNTON AVENUE
WATERLOO NSW 2017 AUSTRALIA
TEL: (02) 9313 7111
FAX: (02) 9313 7555
www.palsonic.com.au**

**PALSONIC CUSTOMER SERVICE
TELEPHONE
AUSTRALIA: 1300 657 888**

Table of Contents

Important Safety Precautions	1
Important Notice	3
Preparations	4
Identification of Controls	6
Connections	9
Basic Operations	13
Memorizing the Channels	15
Channel and Program Selection	18
Picture Adjustment	19
Sound Adjustment	20
Rating and Lock Setup	22
Time Zone & EPG & Sleep Time	24
Teletext & Subtitle	25
Image Adjustments for D-SUB (PC) Mode/Component Mode	26
Troubleshooting	27
Specifications	29

Important Safety Precautions

Electrical energy can perform many useful functions, but it can also cause personal injuries and property damage if improperly handled. This product has been engineered and manufactured with the highest priority on safety. But **IMPROPER USE CAN RESULT IN POTENTIAL ELECTRICAL SHOCK OR FIRE HAZARD.** In order to prevent potential danger, please observe the following instructions when installing, operating and cleaning the product. To ensure your safety and prolong the service life of your TV product, please read the following precautions carefully before using the product.

- 1. Read these instructions** --- All operating instructions must be read and understood before the product is operated.
- 2. Keep these instructions** --- These safety and operating instructions must be kept in a safe place for future reference.
- 3. Read all warnings** --- All warnings on the product and in the instructions must be observed closely.
- 4. Follow all instructions** --- All operating instructions must be followed.
- 5. Attachments** --- Only use attachments/accessories specified by the manufacturer. Do not use attachments not recommended by the manufacturer. Use of improper attachments can result in accidents,
- 6. Power source** --- This product is intended to be supplied by a listed power supply indicated on the marking label. If you are not sure of the type of power supply to your home, consult your product dealer or local power company. For added protection for this product during a lightning storm, or when it is left unattended and unused for long periods of time, unplug it from the wall outlet and disconnect the cable system.
- 7. Power cord protection** --- Protect the power cord from being walked on or pinched particularly at plugs, convenience receptacles, and the point where they exit from the apparatus.
- 8. Overloading** --- Do not overload wall outlets, extension cords, or convenience receptacles on other equipment as this can result in a risk of fire or electric shock.
- 9. Entering of objects and liquids** --- Never insert an object into the product through vents or openings. High voltage flows in the product, and inserting an object can cause electric shock and/or short internal parts. For the same reason, do not spill water or liquid on the product.
- 10. Servicing** --- Refer all servicing to qualified service personnel. Servicing is required when the apparatus has been damaged in anyway, such as power-supply cord or plug is damaged, liquid has been spilled or objects have fallen into the apparatus, the apparatus has been exposed to rain or moisture, does not operate normally, or has been dropped.
- 11. Damage requiring service** --- If any of the following conditions occurs, unplug the power cord from the AC outlet, and request a qualified service person to perform repairs.
 - a. When the power cord or plug is damaged.
 - b. When a liquid is spilled on the product or when objects have fallen into the product.
 - c. When the product has been exposed to rain or water.
 - d. When the product does not operate properly as described in the operating instructions.
Do not touch the controls other than those described in the operating instructions. Improper adjustment of controls not described in the instructions can cause damage, which often requires extensive adjustment work by a qualified technician.
 - e. If the product has been dropped or the cabinet has been damaged in anyway.
 - f. When the product displays an abnormal condition or exhibits a distinct change in performance. Any noticeable abnormality in the product indicates that the product needs servicing.
- 12. Replacement parts** --- In case the product needs replacement parts, make sure that the service person uses replacement parts specified by the manufacturer, or those with the same characteristics and performance as the original parts. Use of unauthorised parts can result in fire, electric shock and/or other danger.
- 13. Safety checks** --- Upon completion of service or repair work, request the service technician to perform safety checks to ensure that the product is in proper operating condition.
- 14. Wall or ceiling mounting** --- When mounting the product on a wall or ceiling, be sure to install the product according to the method recommended by the manufacturer. This is a safety feature.

Important Safety Precautions (Continued)

15. Stand --- Use only with the cart, stand, tripod, bracket, or table specified by the manufacturer, or sold with the apparatus. Do not place the product on an unstable trolley, stand, tripod or table. Placing the product on an unstable base can cause the product to fall, resulting in serious personal injuries as well as damage to the product. When mounting the product on a wall, be sure to follow the manufacturer's instructions. Use only the mounting hardware recommended by the manufacturer.

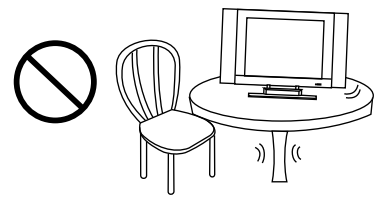

16. Careful move --- When a cart is used, use caution when moving the cart/apparatus combination to avoid injury from tip-over. Sudden stops, excessive force and uneven floor surfaces can cause the product to fall from the trolley.



17. Lightning --- Unplug this apparatus during lightning storms or when unused for long periods of time.

For added protection for this television equipment during a lightning storm, or when it is left unattended and unused for long periods of time, unplug it from the wall outlet and disconnect the antenna. This will prevent damage to the equipment due to lightning and power-line surges.

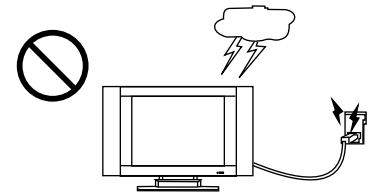

18. Do not use this apparatus near water --- for example, near a bathtub, washbowl, kitchen sink, or laundry tub, in a wet basement, or near a swimming pool, and the like. Do not use immediately after moving from a low temperature to high temperature environment, as this causes condensation, which may result in fire, electric shock, or other hazards.

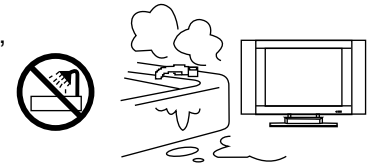

19. Clean only with dry cloth --- Unplug this product from the wall outlet before cleaning. Do not use liquid cleaners or aerosol cleaners. Use a damp cloth for cleaning.

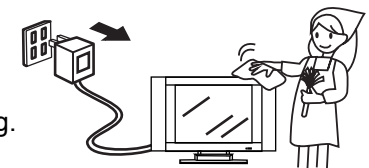

20. Ventilation --- Do not block any ventilation openings. Install in accordance with the manufacturer instructions. The vents and other openings in the cabinet are designed for ventilation. Do not cover or block these vents and openings since insufficient ventilation can cause overheating and/or shorten the life of the product. Do not place the product on a bed, sofa, rug or other similar surface, since they can block ventilation openings. This product is not designed for built-in installation; do not place the product in an enclosed place such as a bookcase or rack, unless proper ventilation is provided or the manufacturer's instructions are followed.

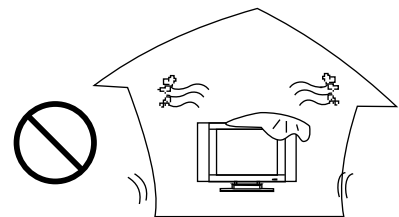

21. Heat sources --- Do not install near any heat sources such as radiators, heat registers, stoves, or other apparatus (including amplifiers) that produce heat.

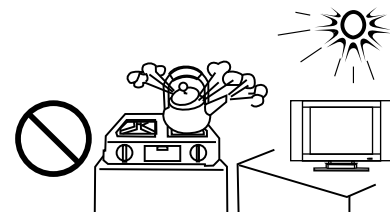

22. Panel protection - The display panel used in this product is made of glass. Therefore, it can break when the product is dropped or impacted upon by other objects. Be careful not to be injured by broken glass pieces in case the LCD panel breaks.

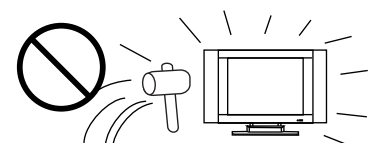

23. Pixel defect - The display panel is a very high technology product, giving you finely detailed pictures. Occasionally, a few non-active pixels may appear on the screen as a fixed point of blue, green or red. Please note that this does not affect the performance of your product.

Important Notice

About Temperature

Do not use in hot and cold rooms (locations)

- When the unit is used in rooms (locations) with low temperature, the picture may leave trails or appear slightly delayed. This is not a malfunction, and the unit will recover when the temperature returns to normal.
- Do not leave the unit in a hot or cold location. Also, do not leave the unit in a location exposed to direct sunlight or near a heater, as this may cause the cabinet to deform and the screen to malfunction.
- Storage temperature: 0°C to + 50°C.
- Working temperature: 5°C to + 40°C;

Cleaning and Maintenance

The front of the display panel has been specially treated. Wipe the panel surface gently using only a cleaning cloth or a soft, lint-free cloth.

- If the surface is particularly dirty, soak a soft, lint-free cloth in a weak detergent solution and then wring the cloth to remove excess liquid. Use this cloth to wipe the surface of the display panel, then wipe it evenly with a dry cloth, of the same type, until the surface is dry.
- Do not scratch or hit the surface of the panel with fingernails or other hard objects. Furthermore, avoid contact with volatile substances such as insect sprays, solvents and thinner, otherwise the quality of the surface may be adversely affected.

If the cabinet becomes dirty, wipe it with a soft, dry cloth.

- If the cabinet is particularly dirty, soak the cloth in a weak detergent solution and then wring the cloth dry. Use this cloth to wipe the cabinet, and then wipe it dry with a dry cloth.
- Do not allow any detergent to come into direct contact with the surface of the Plasma Display.
- If water droplets get inside the unit, operating problems may result.
- Avoid contact with volatile substances such as insect sprays, solvents and thinner, otherwise the quality of the cabinet surface may be adversely affected or the coating may peel off. Furthermore, do not leave it for long periods in contact with articles made from rubber or PVC.

Preparations

Using the Remote Control

- Use the remote control by pointing it towards the remote sensor window of the set. Objects between the remote control and sensor window may prevent proper operation.

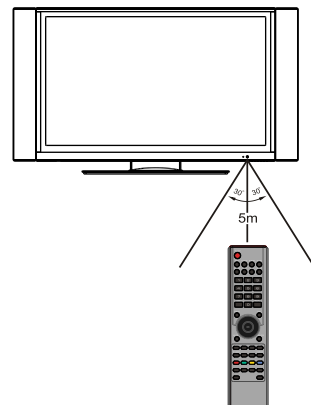

Cautions regarding use of remote control

- Do not expose the remote control to shock. In addition, do not expose the remote control to liquids, and do not place in an area with high humidity.
- Do not install or place the remote control under direct sunlight. The heat may cause deformation of the unit.
- The remote control may not work properly if the remote sensor window of the main unit is under direct sunlight or strong lighting. In such a case, change the angle of the lighting or TV set, or operate the remote control closer to the remote sensor window.

Installing the Batteries

If the remote control fails to operate the TV functions, replace the batteries in the remote control.

- 1 Open the battery cover.
- 2 Insert two size-AAA batteries.
 - (Place the batteries with their terminals corresponding to the (+) and (-) indications in the battery compartment.)
- 3 Replace the cover and slide in reverse until the lock snaps.

Precautions on battery use

Improper use of batteries can result in a leakage of chemicals and/or explosion. Be sure to follow the instructions below.

- Place batteries with their terminals corresponding to the (+) and (-) indications.
- Different types of batteries have different characteristics. Do not mix batteries of different types.
- Do not mix old and new batteries. Mixing old and new batteries can shorten the life of new batteries and/or cause old batteries to leak chemicals.
- Remove batteries as soon as they are non-operable. Chemicals that leak from batteries can cause a rash. If chemical leakage is found, wipe with a cloth.
- The batteries supplied with the product may have a shorter life expectancy due to storage conditions.
- If the remote control is not used for an extended period of time, remove the batteries from the remote control.

Preparations (Continued)

Antenna Connection

INSTALL the unit in a room where direct light will not fall upon the screen. Total darkness or a reflection on the picture screen may cause eyestrain. Soft and indirect lighting is recommended for comfortable viewing.

Optimum reception of colour requires a good signal and will generally mean that an outdoor antenna must be used. The exact type and position of the antenna will depend upon your particular area.



Note

- It is recommended that the 75-ohm coaxial cable be used to eliminate interference and noise which may occur due to radio wave conditions.
- The antenna cable should not be bundled with the power cord and the like.
- Since your new TV has a digital receiver, please ensure you have the best possible antenna installation so to avoid picture defects and disappointment, otherwise picture defects may occur.

Speaker Connection

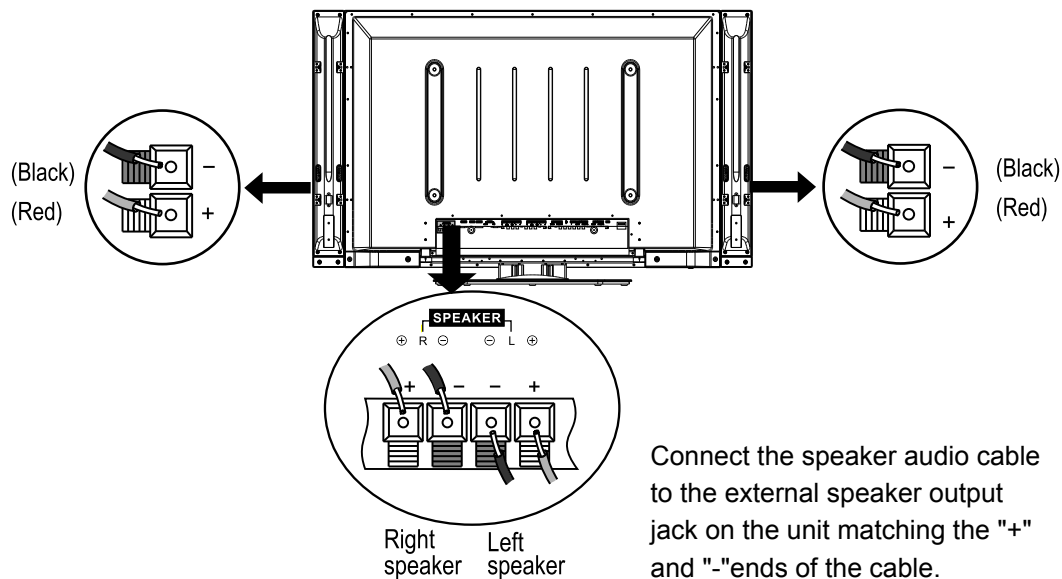

Note

- Unplug the plasma display and all connected components before connecting the Speakers.
- The illustration may be different depending on model.

Power Connection

Insert the AC plug into a conveniently located AC outlet.

Note

- This product should be operated only from the type of power source indicated on the marking label.
- Always unplug the AC cord from power outlet when not using for a long period of time.

Identification of Controls

Main Unit (front view)

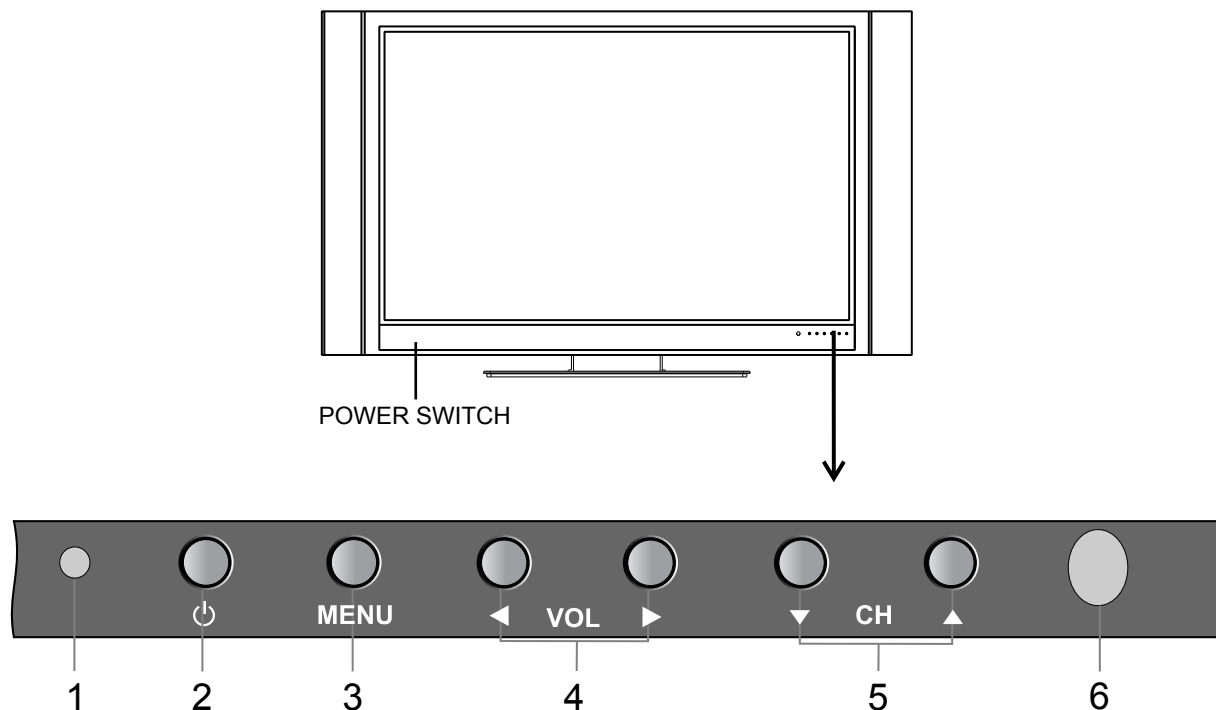

1. INDICATOR



2. POWER

Press this button to turn the unit ON from STANDBY mode. Press it again to turn the set back to STANDBY.

Press this button to access the MENU main page.

3. MENU

4. VOLUME /

Press the VOL  or VOL  button to directly increase or decrease the sound volume level.

In menu operations, these buttons serve as right/left buttons.

5. CHANNEL /

Press these two buttons to directly change the TV channel.

In menu operations, these buttons serve as up/down buttons.

6. REMOTE SENSOR

Note

Functions of **VOL+/-**, **CH+/-**, **MENU** and **POWER ** are also provided to the remote control. This operation manual provides a description based on operating functions with the remote control.

Identification of Controls (Continued)

Main Unit (rear view)

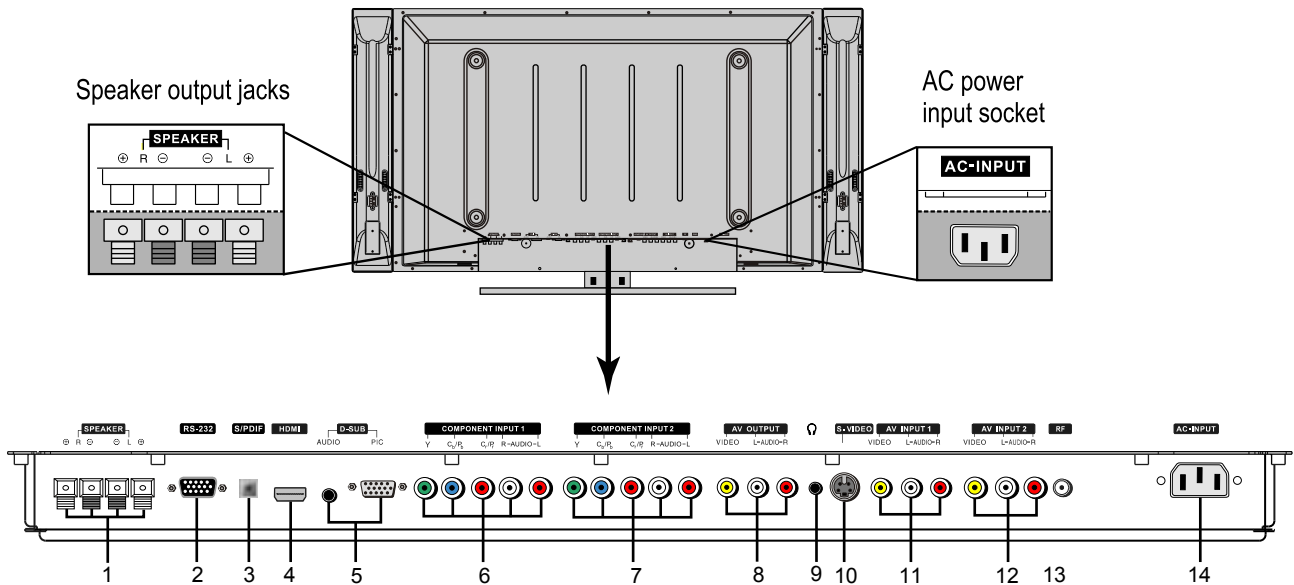

1 Speaker output jacks

2 **RS-232 terminal:** For service only. The user should not use this terminal.

3 **S/PDIF digital audio output (optical):** Connects to the digital audio input of a digital audio component.

4 **HDMI input:** HDMI (High-Definition Multimedia Interface) provides an uncompressed, all-digital audio/video interface between this TV and any HDMI-equipped audio/video component, such as a set-top box and DVD player. HDMI supports enhanced, or high-definition video, plus two-channel digital audio.

5 **D-SUB PIC (Video) /AUDIO input:** Connects to a PC or other Analog RGB devices such as Video Conferencing.

6 **COMPONENT INPUT 1:** Connects to your DVD player. Component video provides better picture quality than the S-VIDEO or the composite video connections.

7 **COMPONENT INPUT 2:** Connects to your DVD player. Component video provides better picture quality than the S-VIDEO or the composite video connections.

8 **AV OUTPUT:** Connects to your VCR to record programs as desired or connects to your audio amplifier. Only analog TV programs, AV 1 and AV 2 input sources can be output through the AV output jacks.

9 **Headphones jack:** Connects to your headphones. If your headphones do not match the jack, use a suitable plug adaptor (not supplied).

10 **S-VIDEO input:** Connects to the S-VIDEO output jack of your VCR or other video equipment that has S-VIDEO. S-VIDEO provides better picture quality than the composite video connection.

11 **AV INPUT 1:** Connects to the composite video and audio output jacks on your VCR or other video device.

12 **AV INPUT 2:** Connects to the composite video and audio output jacks on your VCR or other video device.

13 **RF input:** Connects to your cable system or outdoor antenna

14 **AC power input jack:** Connects to AC power cord..

Identification of Controls (Continued)

Remote Control Unit

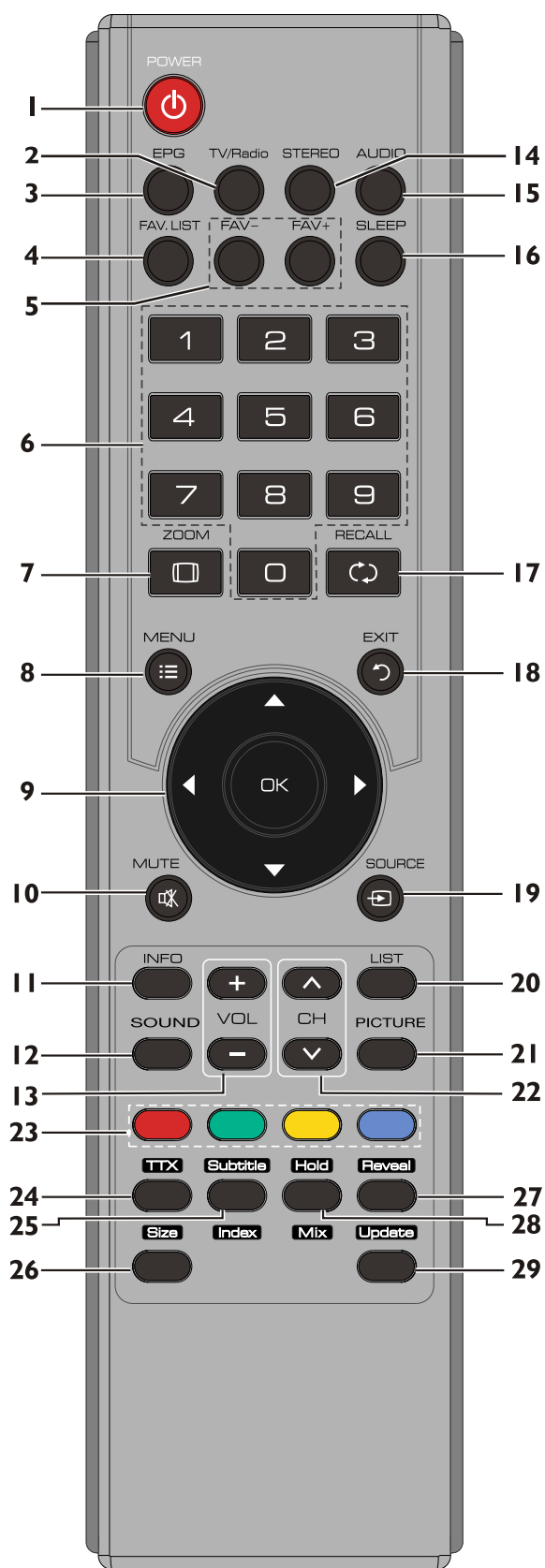

- 1 **POWER** : Switches the TV power on or Standby
 - 2 **TV/Radio**: Switches between TV and Radio mode. (DTV only).
 - 3 **EPG**: Displays the Electronic Program Guide. (DTV only)
 - 4 **FAV +/-**: Selects the favourite channel.
 - 5 **FAV.LIST**: Displays the favourite channel list.
 - 6 **0-9 number buttons**: Press to enter channel numbers or input password.
 - 7 **ZOOM**: Selects the screen size. (For analog program only)
 - 8 **MENU**: Displays the main menu screen.
 - 9 **▲/▼/◀/▶OK**: Press the arrows to navigate through the menus or adjust an item. Press OK to confirm a selection or enter a sub-menu.
 - 10 **MUTE**: Mutes the sound.
 - 11 **VOL+/-**: Increases or decreases the volume.
 - 12 **INFO**: Displays the information banner.
 - 13 **SOUND**: Selects sound mode.
 - 14 **STEREO**: Selects Stereo or Mono sound.
 - 15 **AUDIO**: Selects audio track. (DTV only)
 - 16 **SLEEP**: Sets the sleep timer.
 - 17 **RECALL**: Returns to the previous channel.
 - 18 **EXIT**: Exits the menu screen.
 - 19 **SOURCE**: Displays input source menu.
 - 20 **CH ▲/▼**: Changes channel up and down.
 - 21 **LIST**: Displays the channel list.
 - 22 **PICTURE**: Selects picture mode.
- Below is teletext control buttons:**
- 23 **Coloured buttons (RED/GREEN/YELLOW/BLUE)**: Direct access to the coloured items or corresponding pages. (Teletext)
 - 24 **TTX**: Used to call teletext, change to transparent mode and then exit. (Teletext)
 - 25 **Subtitle**: Displays the subtitle. (DTV only)
 - 26 **Size**: Press this button several times to display the upper, then the lower part of the screen and then return to the normal size teletext page. (Teletext)
 - 27 **Reveal**: To reveal or hide the concealed information. (Teletext)
 - 28 **Hold**: To stop or resume sub-page acquisition. (Teletext)
 - 29 **Update**: Press the button to view the updated teletext page. (Teletext)

Note In teletext mode, **EPG** button is used to display the index page.

Connections

Cautions before connecting

- Carefully check the terminals for position and type before making any connections.
- The illustration of the external equipment may be different depending on your model.
- Loose connectors can result in image or colour problems. Make sure that all connectors are securely inserted into their terminals.
- Refer to the operating manual of the external device as well.
- When connecting an external device, turn the power off to avoid any issues.

Connecting digital optical audio

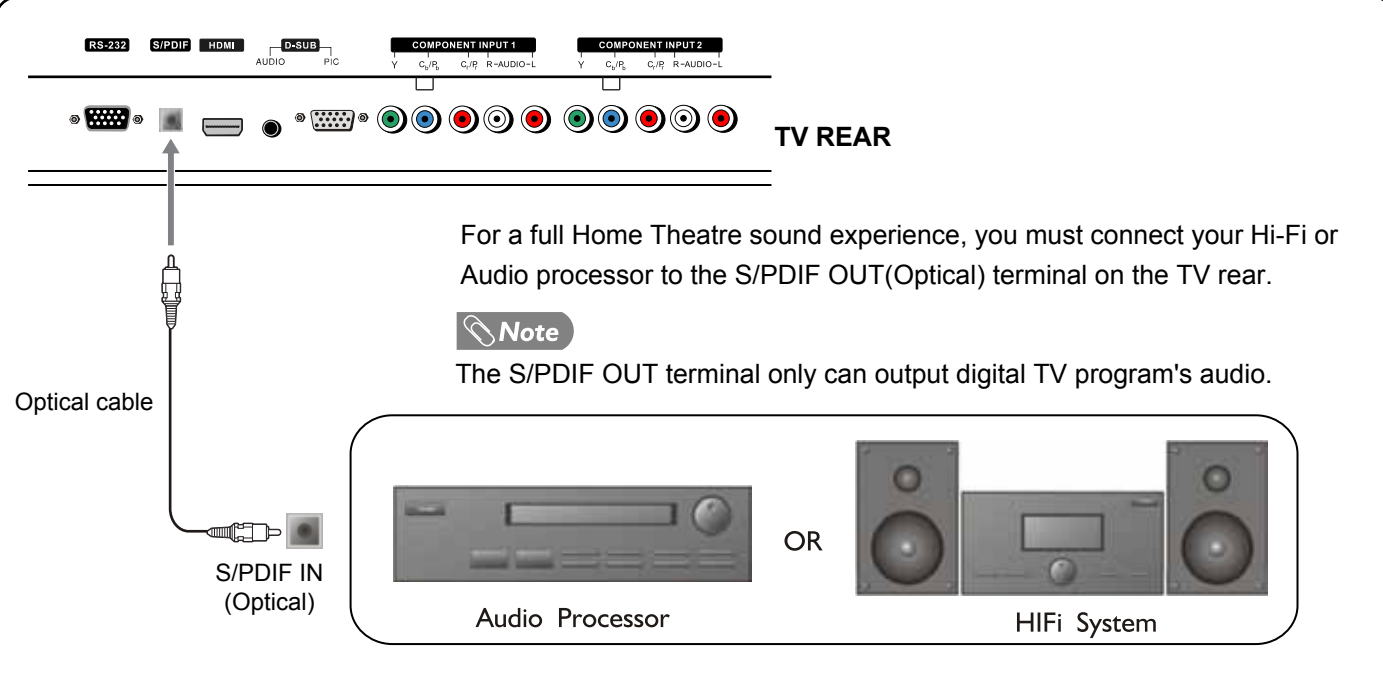

TV REAR

For a full Home Theatre sound experience, you must connect your Hi-Fi or Audio processor to the S/PDIF OUT(Optical) terminal on the TV rear.

Note
The S/PDIF OUT terminal only can output digital TV program's audio.

Optical cable

S/PDIF IN (Optical)

Audio Processor OR HiFi System

Connecting a VCR

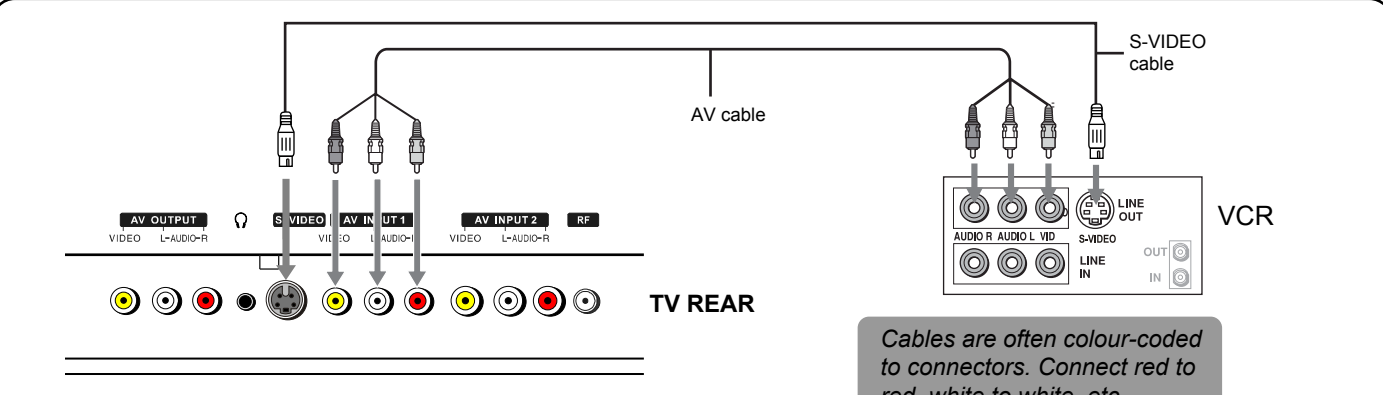

TV REAR

VCR

AV cable

S-VIDEO cable

Cables are often colour-coded to connectors. Connect red to red, white to white, etc.

How to connect:

Connect the Audio/Video cables between the Audio (L/R)/Video jacks on the unit and VCR.

Note: For better video, you can use the S-Video terminal if your source supports it.

To play VCR

1. Turn on your TV then press **SOURCE** button. The **SOURCE** menu opens.
2. Press **▲** or **▼** to select **AV 1** (or **S-Video** if using S-VIDEO terminal), then press **OK** to confirm.
3. Turn on your VCR, insert a videotape and press the **Play** button.

Connections (Continued)

Connecting a Camcorder

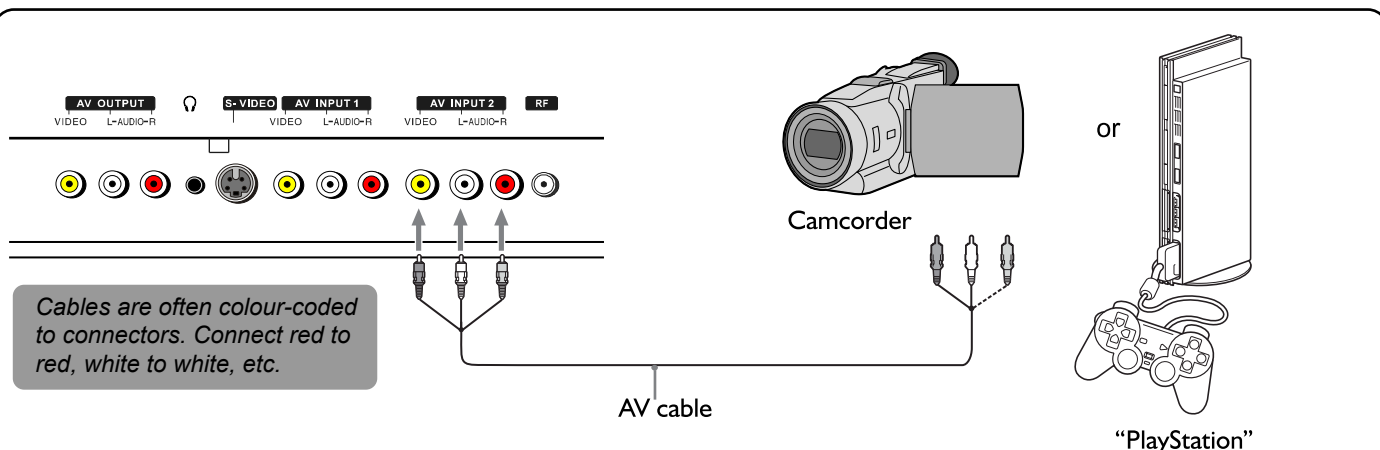

How to connect:

Connect the Audio/Video cables between the Audio (L/R)/Video jacks on the unit and camcorder.

To playback Camcorder

1. Turn on your TV, then press **SOURCE** button. The **SOURCE** menu opens.
2. Press **▲** or **▼** to select **AV 2**, then press **OK** to confirm.
3. Turn on your camcorder and set it to output mode. (For details, refer to your camcorder user manual.)
4. Insert the tape into the camcorder and press **Play** button.

Note

The operations of the camcorder may be different and is dependant on your model. Please read the user manual of your camcorder to confirm operation.

Connecting a HDMI device

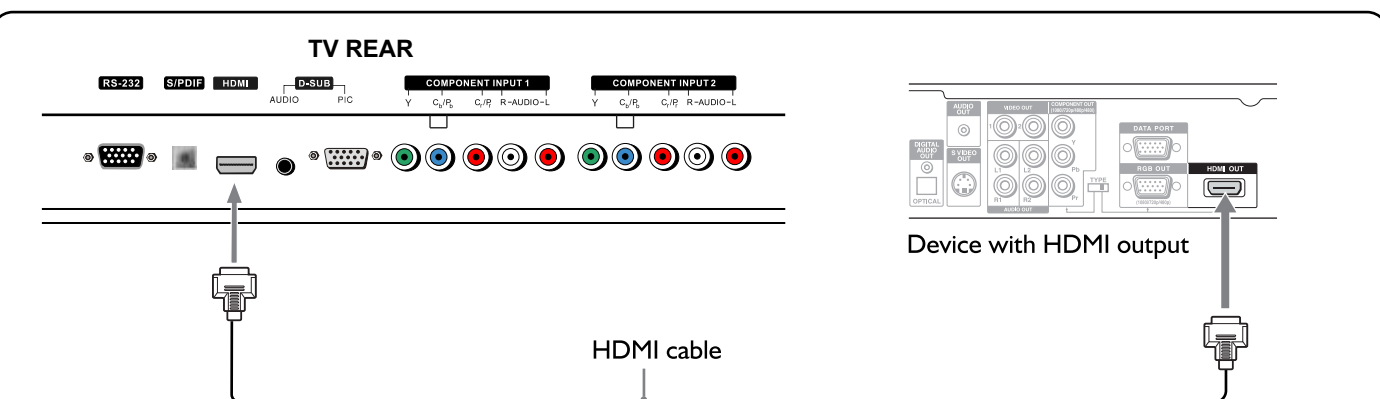

How to connect a device using HDMI Connection:

Connect the HDMI cable between the HDMI interface on the unit and HDMI output on the device.

To play from the device using HDMI:

1. Turn on your TV, then press **SOURCE** button. The **SOURCE** menu opens.
2. Press **▲** or **▼** to select **HDMI**, then press **OK** to confirm.
3. Turn on your device and set it to the correct mode. See the device's user guide for more information.

Note

If the external device has DVI output only, use a DVI to HDMI adapter cable to connect to the HDMI terminal. Connect the audio cable to the D-SUB AUDIO IN jack on the TV rear.

Connections (Continued)

Connecting a Component Video

TV REAR

RS-232 S/PDIF HDMI D-SUB AUDIO PIC

COMPONENT INPUT 1 Y C_b/P_b C_r/P_r R-AUDIO-L

COMPONENT INPUT 2 Y C_b/P_b C_r/P_r R-AUDIO-L

Component video cable

Device with component video

Audio cable

Cables are often colour-coded to connectors. Connect red to red, white to white, etc.

To connect a device using component video:

Connect the Component Video cable between the Y, Cb/Pb, Cr/Pr input jacks on the unit and Y, Cb/Pb, Cr/Pr output jacks on the device.

Connect the Audio cable between the AUDIO input jacks on the unit and AUDIO output jacks on the device.

To play component video from an external device:

1. Turn on your TV then press **SOURCE** button. The **SOURCE** menu opens.
2. Press ▲ or ▼ to select **YPbPr 1** (or **YPbPr 2**), then press **OK** to confirm.
3. Turn on your external device and set it to the correct mode. See the device's user guide for more information.

Connecting a Computer

RS-232 S/PDIF HDMI D-SUB AUDIO PIC

COMPONENT INPUT 1 Y C_b/P_b C_r/P_r R-AUDIO-L

COMPONENT INPUT 2 Y C_b/P_b C_r/P_r R-AUDIO-L

D-sub cable (analog RGB)

To monitor port (15-pin D-Sub)

To audio output jack

Audio cable (stereo mini plugs)

How to connect:

Connect a D-sub cable between the D-SUB jack on the computer and the D-SUB input jack on the unit.

Connect an Audio cable between the AUDIO output on the computer and AUDIO input jack on the unit.

To play video from a computer

1. Turn on your TV then press **SOURCE** button. The **SOURCE** menu opens.
2. Press ▲ or ▼ to select **D-Sub**, then press **OK** to confirm.
3. Turn on your computer, and adjust the display properties as required.

Connections (Continued)

Connecting a VCR (for Recording)

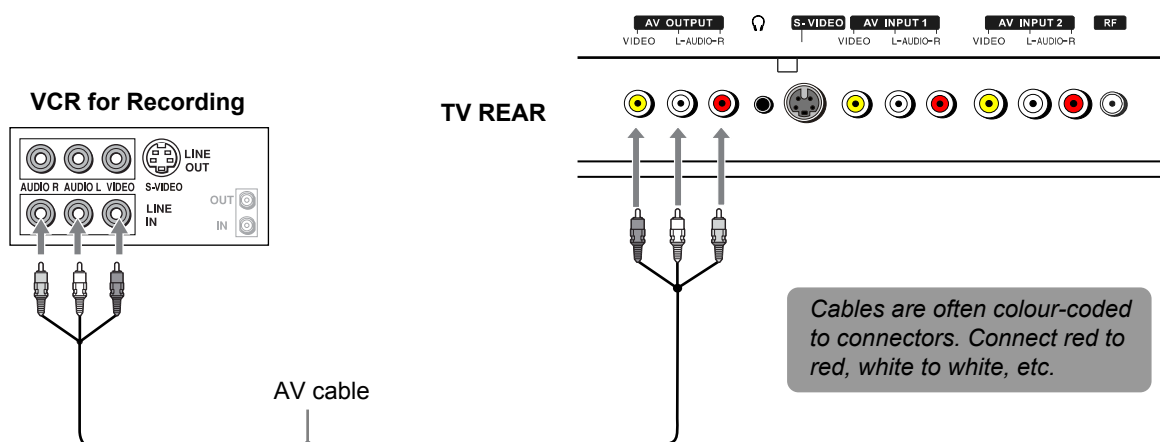

How to connect:

Connect the Audio/Video cables between the Audio (L/R)/Video jacks on the unit and VCR.

To record program

1. Turn on your TV, select a program you wish to record.
2. Turn on your VCR, insert a videotape for recording.
3. Press the Record button to begin recording.

Note

Only analog TV programs, AV1 and AV 2 input sources can be output through the AV output jacks.

Connecting Headphones

Insert the plug of the headphone into the TV's Headphone jack.

When using headphones, adjust the headphone volume so as to avoid excessive levels, as hearing damage may result.

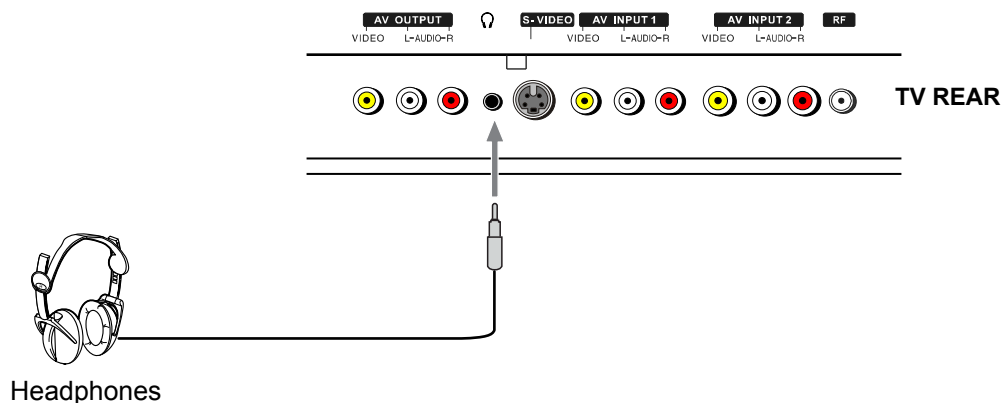

Basic Operations

Turning On/Off the Power

■ Turning On

Insert the power cord into the wall outlet.

Press the **Power Switch** on the unit, then press the **POWER** button on the unit or on the remote control.

The unit will be turned on and you will be ready to use its features.

■ Turning Off

With the power on, press the **POWER** button on the unit or on the remote control to turn off the unit, and put the unit in standby mode. To cut off the power completely, press the **Power Switch**.

Main Menu Overview

■ List of main menus to help you with operations

The image displays six screenshots of the TV's OSD main menu screens, arranged in two rows of three. Each screen has a navigation bar at the top with icons for VIDEO, AUDIO, SETUP, RATE, SYSTEM, and DISPLAY. The first screen (VIDEO) shows settings for Aspect Ratio (Wide), Picture Mode (Custom), Contrast (77%), Brightness (50%), Color (50%), Tint (50%), Sharpness (50%), and an Advanced option. The second screen (AUDIO) shows Sound Mode (Custom) with sliders for 100Hz (94%), 500Hz (79%), 1KHz (50%), 5KHz (79%), 10KHz (94%), Balance (50%), SPDIF Mode (Auto), and HP Volume (19%). The third screen (SETUP) shows Auto Install, Manual Install, Channel List, Favorite List, and Manual Adjust. The fourth screen (RATE) shows Rating, Channel Lock, Password, and Parental Lock. The fifth screen (SYSTEM) shows Source (TV) and State (NSW ACT). The sixth screen (DISPLAY) shows H.Position (42%), V.Position (48%), Phase (60%), and an Auto Adjust option.

Note

- **DISPLAY** menu can only be used in D-Sub and Component mode.
- Menu items that are not selectable are greyed out.
- The illustrations and on-screen displays in this manual are for explanation purposes (some are enlarged, others cropped) and may vary slightly from the actual ones.

■ To navigate through the OSD main menu

- 1 With the power on, press **MENU** and the main menu screen displays.
- 2 Press the **◀ / ▶** to select menu. Press **▼** to access the menu.
- 3 Within the menu, press **▲, ▼, ◀, ▶** to navigate through the options or adjust an option. Press **OK** to confirm a selection or enter a sub-menu.
- 4 Press **MENU** or **EXIT** to return to the previous level menu. To exit the menu system, press **MENU** or **EXIT** repeatedly. Or you may wait for some seconds and the on-screen menu will disappear from the screen automatically.

Note

- To clearly introduce the menu operations, this operation manual provides a description based on operation with the remote control.

Basic Operation (Continued)

Selecting the Input Signal Source

1 Press **SOURCE** button.

2 Press **▲** or **▼** to select the input source.

You can quickly go to first item (TV) and last item (HDMI) by pressing **◀** or **▶** button.

Options include:

- **TV** - Watch the TV signal.
- **AV1** - Watch the signal from the AV1 input terminals.
- **AV2** - Watch the signal from the AV2 input terminals.
- **S-Video** - Watch the signal from the S-VIDEO input terminal.
- **YPbPr1** - Watch the signal from the COMPONENT input 1 terminals.
- **YPbPr2** - Watch the signal from the COMPONENT input 2 terminals.
- **D-Sub** - Watch the signal from the D-SUB jack.
- **HDMI** - Watch the signal from the HDMI input jack.

3 Press **OK** or **SOURCE** button to confirm the selection.

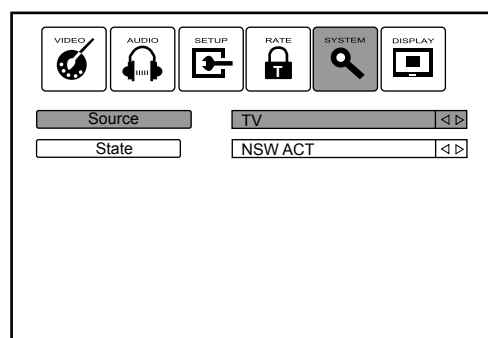
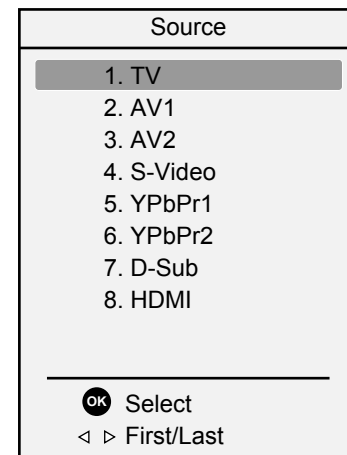

Note

- You can also make use of OSD main menu (SYSTEM menu) to select the input source.

Displaying the Information Banner

Press the **INFO** button to display the information banner. The information banner displays current status information such as the channel number and signal source.

Depending on the mode, different information is displayed. In DTV mode, more information will be displayed. Below is an example banner in DTV mode.

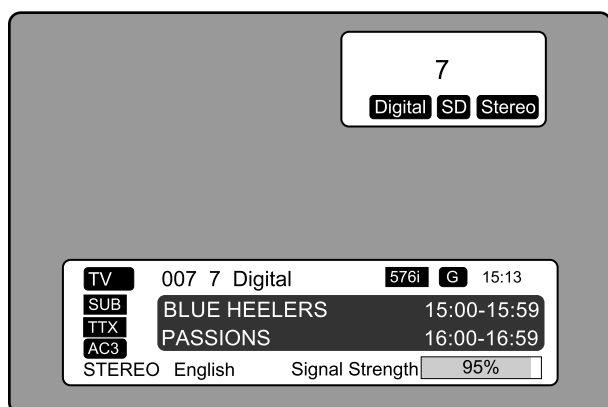

In DTV mode, the information banner may contain:

- Channel number and name.
- Current time.
- Current program name, start and end playtimes.
- Next program name and start and end playtimes.
- TV or Radio.
- Audio mode (stereo or mono), audio track.
- Signal strength for current channel.
- Signal resolution.
- Program rating, etc.

Note

- The above OSD is only served as an example. and it is in DTV mode.
- Information banner content varies, depending on the broadcaster and your settings.

Memorizing the Channels

Your TV can memorize and store all of the available programs (including TV and Radio programs). After the available programs are memorized, use Channel up/down button to scan through the available stations

Auto Searching for Programs

You can complete an auto search to search for all programs (including radio and TV stations) available to your television. The television then stores them in memory on the program list.

- 1 Press **MENU** and the main menu screen displays.
- 2 Press **◀ / ▶** to select **SETUP** menu, press **▼** to access the menu.
- 3 Highlight **Auto Install** item, and then press **OK**. Now a confirmation box opens up, use **◀ / ▶** to select **Yes** to confirm and the TV automatically searches for all available TV/DTV program and radio program, or select **No** to cancel the operation.

Note

- You can press **EXIT** button to stop the search.

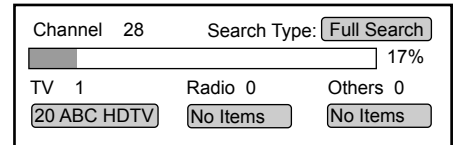
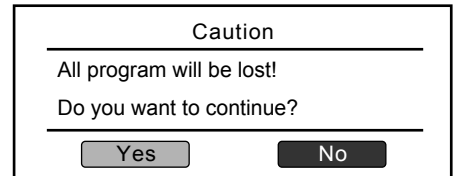
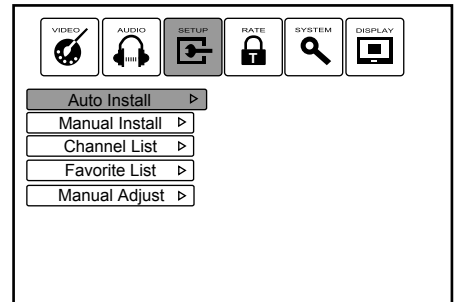

Manual Searching for Programs

If desired programs can not be searched by Auto Install, you can make use of Manual Install to search programs manually.

- 1 Use channel select buttons to select a channel position in which you want to store.
- 2 Navigate to **SETUP** menu and press **▲** or **▼** to select **Manual Install** and then press **OK**.
- 3 Now a process screen opens up, press **◀** or **▶** to search program upward or downward. When a program is located, the search stops, and this program is stored in the specified channel position.

Note

- Manual Install is only used to search analog TV program.
- You can press **EXIT** button to stop the search.

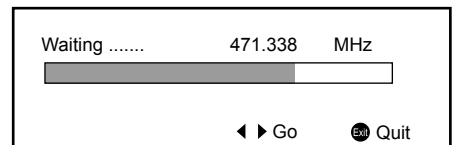
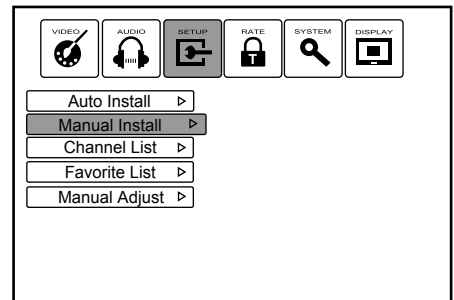

Manual Fine Tuning

Fine tuning is not necessary under normal conditions. However, in area of inferior broadcast conditions where adjustment is necessary for a better picture and sound, use Fine tuning.

- 1 Navigate to **SETUP** menu and press **▲** or **▼** to select **Manual Adjust**, and then press **OK** to access the sub-menu.
- 2 Highlight **Program**, press **◀** or **▶** to select a program which you want to perform fine tune.
- 3 Press **▼** to select **Fine Tune**, and then press and hold **◀** or **▶** to fine tune until the best possible picture and sound are obtained.

Note

- Fine Tune is only for analog TV program.

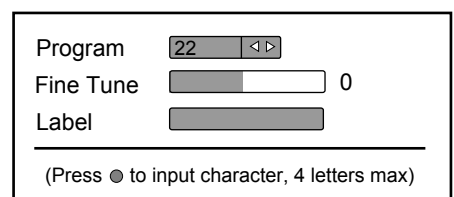
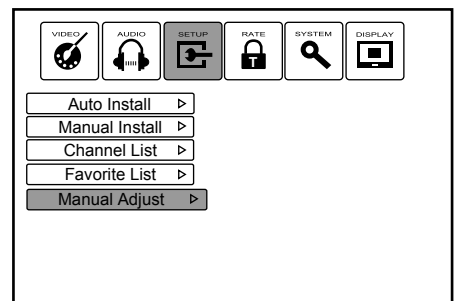

Memorizing the Channels (Continued)

Labelling Channel

If a channel is not already labelled, you can label the channel so you know what channel you are watching.

- 1 Navigate to **SETUP** menu and press **▲** or **▼** to select **Manual Adjust**, and then press **OK** to access the sub-menu.
- 2 Highlight **Program**, press **◀** or **▶** to select a program which you want to label.
- 3 Press **▲** or **▼** to select **Label**, and then press **YELLOW** button to open the label editing screen. Use **▲**, **▼**, **◀**, **▶** to navigate among characters and then press **OK** to select it. To delete, press **RED** button; to switch between uppercase and lowercase, press **YELLOW** button; to save, press **GREEN** button.
The maximum length of label is 4 characters.

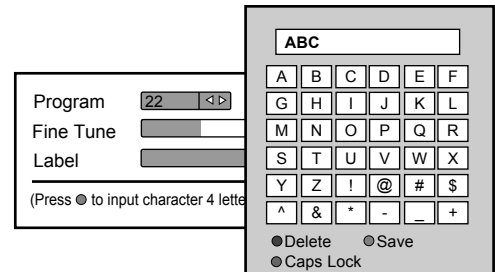
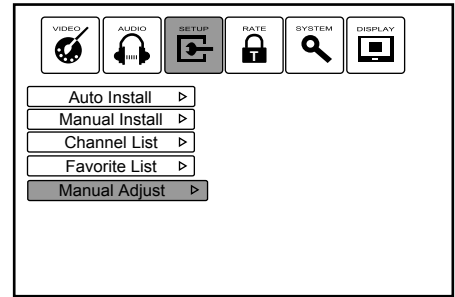

Note

- The labels of digital broadcasting channels are automatically assigned and thus can not be assigned by users.

Channel List Management

After auto install, a default channel list is created. You can make use of Channel List to select program, to skip unnecessary channels, to sort programs, and to create a favourite program list.

■ To skip unnecessary channels

After auto install, you can skip unnecessary channels so that only the channels you want to watch are selected with Channel up/down buttons.

- 1 Press **LIST** button to call up **Channels List**.
Or you may navigate to **SETUP** menu and press **▲** or **▼** to select **Channel List**, and then press **OK** to access the sub-menu.
- 2 Press **▲** or **▼** to select your unwanted channel, press **GREEN** button and a skip symbol appears alongside the selected channel in the list, which means this channel will be skipped.
- 3 If you want to skip more channels, repeat the above steps to set more skip symbols to more channels.
Press **EXIT** to quit the list. Now when you press Channel up/down buttons, these unwanted channels will be skipped.

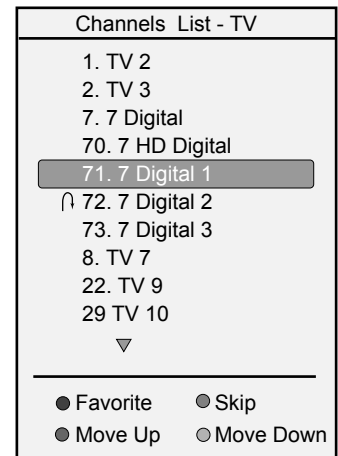

Note

- To restore a skipped channel, enter into the channel list, use **▲** or **▼** to select the channel, then press **GREEN** button and the skip symbol will disappear.
- If the channel list has more than one page, you may press **◀** or **▶** to scroll the page upward or downward.

■ To sort channels

This function allows you to arrange the channel order.

- 1 Select the channel you want to move in the channel list.
- 2 Press **BLUE** or **YELLOW** button to move the channel upward or downward to a desired new position.
- 3 Repeat the above steps for each channel you wish to move.

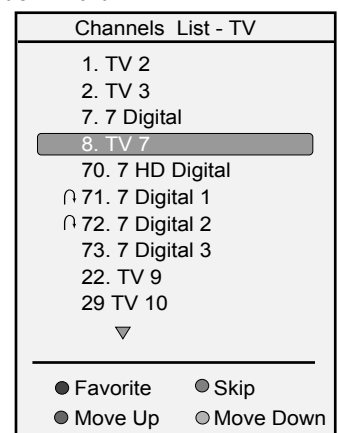

Note

- If the channel list has more than one page, you may press **◀** or **▶** to scroll the page upward or downward.

Memorising the Channels (Continued)

Favourite Channel Setup

You can make use of channel list to set up your favourite channels.

- 1 In the channel list, press ▲ or ▼ to select your favourite program, press **RED** button and a favourite symbol appears alongside the selected channel.
- 2 Repeat the above steps to set more favourite channels.
- 3 Now a favourite channel list has been created. You can press **FAV.LIST** button to call up the favourite list, or make use of OSD main menu (**SETUP** menu) to display the favourite list.

Note

- If you want to cancel favourite setting, select the program in the channel list, press **RED** button and the favourite symbol will disappear.
- If the channel list has more than one page, you may press ◀ or ▶ to scroll the page upward or downward.

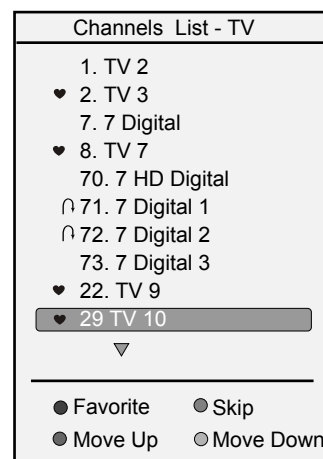

Favourite List Management

After favourite list is created, you can arrange the favourite program order.

■ To sort favourite channels

This function allows you to arrange the favourite program order.

- 1 Select the channel you want to move in the Favourite List.
- 2 Press **BLUE** or **YELLOW** button to move the channel upward or downward to a desired new position.
- 3 Repeat the above steps for each channel you wish to move.

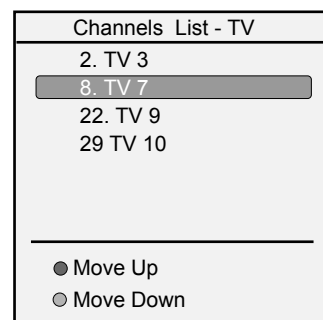

Channel and Program Selection

Please note: your new TV is capable of receiving both radio and TV broadcasts. And for TV reception, your new TV is capable of receiving both traditional analog channels and digital channels.

When watching digital TV program and you want to listen to radio program, simply press TV/Radio button to switch. To return to TV program, press TV/Radio button again. (When watching analog TV program, the TV/Radio button does not work.)

The TV allows channel and program selection in the following ways:

■ Method 1 - Using CH▲ or CH▼

Press the CH▲ or CH▼ to cycle among all available channels. The skipped channels can not be selected by Channel up/down button.

■ Method 2 - Using RECALL button

Press RECALL to switch to the previously tuned channel.

Press RECALL again to switch back to the currently tuned channel.

Note

- This button will not work if no channel has been changed after TV is turned on.

■ Method 3 - Using 0 - 9 and OK button

Press the 0 - 9 number buttons to input a channel number, then wait for some seconds or press OK to go directly to that channel.

When both analog and digital channels have same channel number, input the channel number first time and the TV will tune to the digital channel. While the digital program is displayed, input the same channel number a second time and the TV will tune to the analog channel.

When selecting, the TV will indicate the channel through the information banner.

Note

- When in Radio mode, you can press TV/Radio button to switch to TV mode.
- If you input one-digit or two-digit channel number, you can press OK to go directly to the channel without waiting.

■ Method 4 Using channel list

Press LIST button to display the channel list (or you can make use of OSD main menu - SETUP menu to open the channel list). Use ▲ or ▼ to select a channel and then press OK.

Note

- If the channel list has more than one page, you may press ◀ or ▶ to scroll the page upward or downward.

■ Method 5 - Using favourite channel list

After you have created the favourite channel list, you can press FAV.LIST button to display the favourite channel list (or you can make use of OSD main menu - SETUP menu to open the favourite channel list). Use ▲ or ▼ to select a channel and then press OK.

Note

- You can directly press FAV+/- button to cycle among the favourite channels.

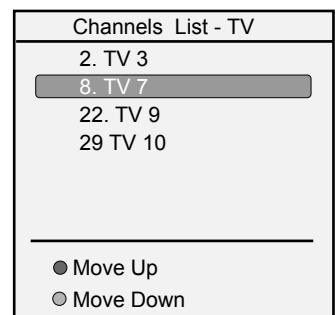
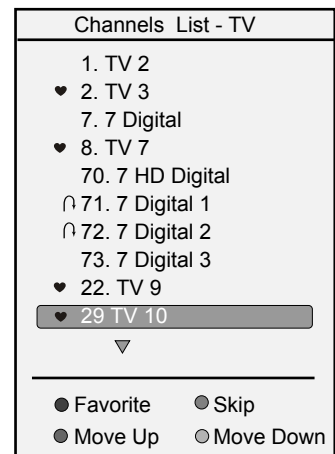

Picture Adjustment

Customising the Picture

- 1 Press **MENU** and the main menu screen displays.
- 2 Press **◀ / ▶** to select **VIDEO** menu, press **▼** to access the menu.
- 3 Within the menu, press **▲, ▼, ◀, ▶** to navigate through the options or adjust an option. Press **OK** to confirm a selection or enter a sub-menu

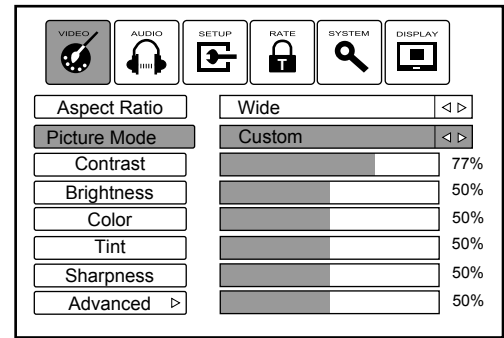

Option	Description
Aspect Ratio	You can select the aspect ratio (display proportions) according to your video signal type or personal preference. You can select from Wide , Zoom and Normal . Wide: Displays a full-screen (16:9) picture. (Works only in 4:3 analog programs) Zoom: Magnifies the picture while maintaining correct screen proportions. Normal: Displays a 4:3 picture. (Works only in analog programs) Note: You can press the ZOOM button repeatedly to select a desired aspect ratio.
Picture Mode	Selects a desired picture mode. You can select from Standard , Vivid , Mild and Custom . Standard: Select for a normal picture. Vivid: Select for a bright and vivid picture. Mild: Select for a finely detailed picture. Custom: The picture quality you set. Note: To quickly change the picture mode, press the PICTURE button repeatedly.
Contrast	Adjusts image contrast.
Brightness	Adjusts screen brightness for easier viewing of dark picture such as night scenes and black hair.
Colour	Adjusts colour saturation.
Tints	Adjusts tint for image.
Sharpness	Adjusts image sharpness and displays a sharp image.
Advanced (Colour Temperature)	Selects one of three automatic colour adjustments. Sets to Warm to enhance hotter colours such as red, or set to Cool to see less intense colours with more blue. You can select from Warm , Cool and Normal .

Note

- Tint is only for NTSC system.
- Menu item that is not selectable is greyed out.
- Select "Advanced" and then press **OK** to set "Colour Temperature".

Sound Adjustments

Adjusting the Volume

■ Using the volume buttons (VOL+ and VOL-)

Press the **VOL+** or **VOL-** to increase or decrease the volume.

■ Using the MUTE

Press the **MUTE** button to temporarily turn off all sound. To restore the sound, press the **MUTE** button again.

Customizing the Sound

- 1 Press **MENU** and the main menu screen displays.
- 2 Press **◀ / ▶** to select **AUDIO** menu, press **▼** to access the menu.
- 3 Within the menu, press **▲** or **▼** to navigate through the options, press **◀** or **▶** to adjust an option.

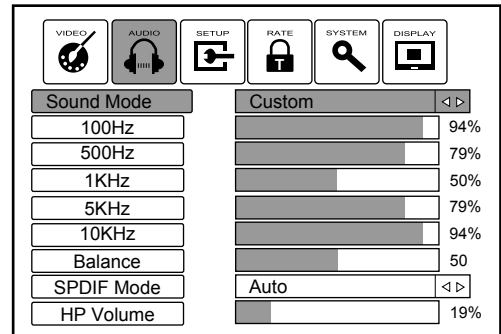

Option	Description
Sound Mode Select	Selects a desired sound mode. You can select from Music , Movie , Speech and Custom . Music: Select for a music program. Movie: Select for a movie program. Speech: Select for a speech or conversation program. Custom: The sound quality you set.
Five-Band Equalizer (100Hz, 500Hz, 1KHz, 5 KHz, 10KHz)	You can adjust the sound quality to your preference by adjusting the Five-band Equalizer.
SPDIF Mode	Select the digital audio output mode for S/PDIF. You can select from Auto, AC3, MPEG. Auto: Output audio signal as its original format. If both AC3 and MPEG are available, AC3 is auto selected. AC3: Output audio signal by AC3 form (if available). MPEG: Output audio signal by MPEG form (if available).
HP Volume	Adjust headphones volume.

Note: To select **Auto** is recommended.

Sound Adjustments (Continued)

Stereo/Bilingual Selection (for analog channels)

You can quickly select sound multiplex mode by using the **STEREO** button on the remote control.

■ **NICAM Broadcast Selection**

This enables the selection of the reception mode when receiving a NICAM signal. To let you enjoy NICAM broadcasting, this TV set receives NICAM system stereo, bilingual, and monaural broadcasts.

Stereo

When the TV set is receiving a stereo broadcast, press the **STEREO** button to select **STEREO** or **MONO**. When **MONO** is selected, the TV sound is output monaurally.

Bilingual

When the TV set is receiving a bilingual program, press the **STEREO** button to select **Dual A** or **Dual B**.

■ **IGR (German stereo system) Broadcasts**

This enables the selection of the reception mode when receiving an IGR signal. To let you enjoy IGR broadcasting, this TV set receives IGR system stereo and bilingual broadcasts.

Stereo

When the TV set is receiving a stereo broadcast, press the **STEREO** button to select **STEREO** or **MONO**. When **MONO** is selected, the TV sound is output monaurally.

Bilingual

When the TV set is receiving bilingual program, press the **STEREO** button to select **Dual A** or **Dual B**.

Stereo/Mono Selection (for digital channels)

When watching digital programs, you can select stereo or mono sound to match the broadcast signal or your home entertainment stereo system by making use of **STEREO** button on the remote control.

Audio Track Selection (for digital channels)

The digital TV transmission system is capable of simultaneous transmission of many audio tracks (for example, simultaneous translations of the program into foreign languages, or different commentators for sport events). You can press **AUDIO** button to select the audio track.

Note

- *The availability of these additional "multi-tracks" depends upon the broadcaster.*

Rating and Lock Setup

Password Setup

The Password setup sub-menu is used to set a new system password or to change an existing system password. By default, the system password is 0000 and you may change it. To access Rating control, to lock or unlock channels, to view locked channels, or to set up Parent Lock, the system password is required.

■ To create a new password

- 1 Press **MENU** and the main menu screen displays. Press **◀ / ▶** to select **RATE** menu, press **▼** to access the menu.
- 2 Press **▲** or **▼** to select **Password** item, and then press **OK** to access its sub-menu.
- 3 Highlight **Old Password** item, use the number buttons to input the old password (the default password is 0000).
- 4 Use **▲** or **▼** to highlight **New Password** item, use the number buttons to input a new password (4- digit).
- 5 Use **▲** or **▼** to highlight **Confirm New Password** item, use the number buttons to input the same password a second time and then press **OK** to confirm.
Now the new password has been created successfully.

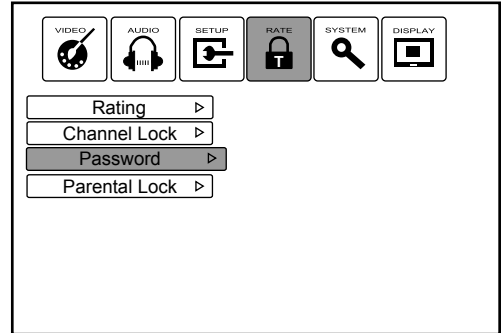

Old Password

New Password

Confirm New Password

Note: Password must be 4 digits

Note

- If you forget your password, you may use the super password (2580) to overwrite the old password, and the system will auto reset the password to 0000.

Rating Setup

Rating Control blocks programs according to their classification so that children can not view certain programs. Parents can set the ratings limit in the Rating control sub-menu.

- 1 Navigate to the **RATE** menu and use **▲** or **▼** to highlight **Rating** item, press **OK** to access.
- 2 Now a password is required to input. Use number buttons to input the password and then press **OK**.
- 3 Now the Rating control screen opens. Use **▲** or **▼** to select your desired rating, and press **OK** to either block or unblock the rating.

Use the "Block All" setting to completely block all viewing. The menu can still be accessed to unblock all programs.
- 4 Press **EXIT** one or more times to quit the menu and return to your program.

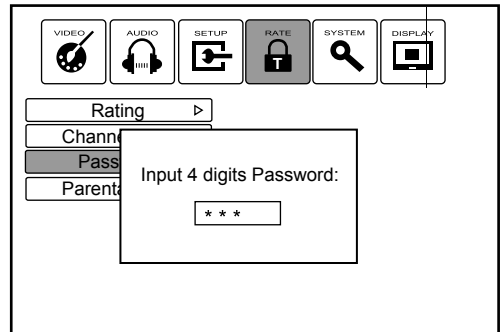

G (General Audiences): Content not offensive to most viewers.
PG (Parental Guidance Suggested): Content is such that parents may not want their children to view the program.
M (Mature Audience): Suitable for mature audience.
MA (Mature Adult Audience): May contain mature themes, profane language, graphic violence, and sexual situations.
AV (Adult Audience): Strong violence.
R (Restricted viewing): Not for children under age 17. Strong elements of sex and/or violence.

Block All

Block G & above

Block PG & above

Block M & above

Block MA & above

Block AV & above

Block R & above

No Block

Rating and Lock Setup (Continued)

Channel Lock Setup

The Channel Lock function blocks the viewing of any channel for which the channel lock has been set.

- 1 Navigate to the **RATE** menu and use ▲ or ▼ to highlight **Channel Lock** item, press **OK** to access.
- 2 Now a password is required to input. Use number buttons to input the password and then press **OK**.
- 3 Now the **Channel Lock** screen opens. Use ▲ or ▼ to select the channel you want to lock, then press **RED** button to set lock to the channel. A lock symbol appears alongside the locked channel.
- 4 Repeat the above steps for each program you wish to lock.
- 5 Press **EXIT** one or more times to quit the menu. The Channel Lock comes into effect for the Locked channel.

Note

- To view a locked channel, just input the password.
- To cancel channel lock, enter into the **RATE** menu, use password to enter into the **Channel Lock** screen, use **RED** button to unlock the channel, and the lock symbol will disappear.

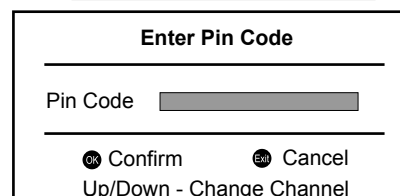
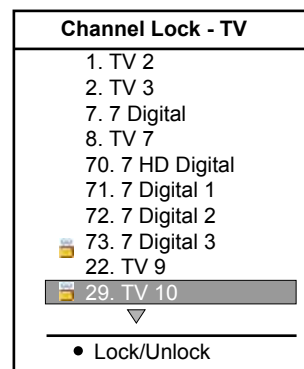
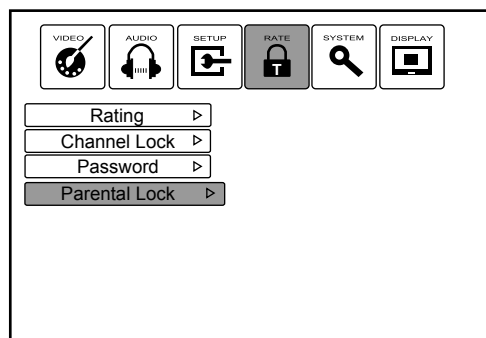

Parental Lock Setup

Making use of Parent Lock you can protect some TV settings from being accidentally changed. After Parent Lock is set to ON, the Auto Install, Manual Install, and Manual Adjust can not be performed by the user without the password.

- 1 Navigate to the **RATE** menu and use ▲ or ▼ to highlight Parent Lock item, press **OK** to access.
- 2 Now a password is required to input. Use number buttons to input the password and then press **OK**.
- 3 Now the **Parent Setting** screen opens. Use ◀ or ▶ to turn on or turn off the Parent Lock. Once you turn on Parent Lock, the Auto Install, Manual Install and Manual Adjust can not be done by the user without the password. To cancel, use password to enter into Parent Setting screen and set Parent Lock to OFF.

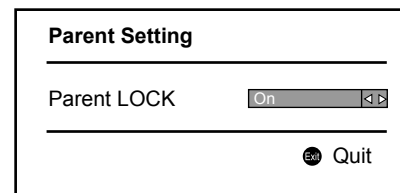
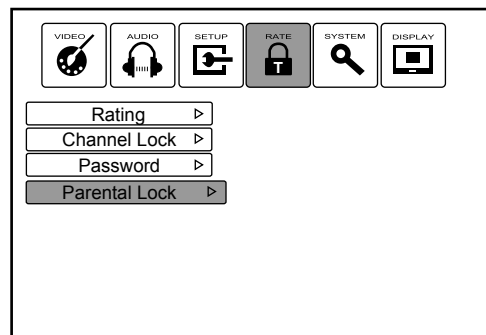

Time Zone, EPG & Sleep Timer

Time Zone Selection

To obtain local time, you should first set local time zone, and it depends on your local station whether has broadcast time zone information.

- 1 Press **MENU** and the main menu screen displays.
- 2 Press **◀ / ▶** to select **SYSTEM** menu, press **▼** to access the menu.
- 3 Press **▲** or **▼** to select **State** item, and then press **◀ / ▶** to select the appropriate time zone.

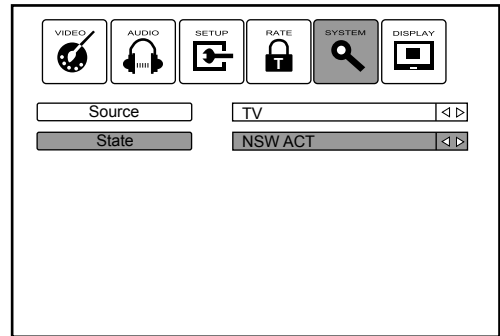

EPG

The EPG displays information about current and upcoming programs.

■ Operation

- 1 Press the **EPG** button to open the EPG (Electronic Program Guide). An example of an EPG window is given on the right.
- 2 In the EPG window, several channels' current and upcoming program's information will be displayed. You can use **▲, ▼, ◀, ▶** buttons to navigate among the channels and program events. On the upper window detailed information (if available) about the current highlighted program will be displayed.
- 3 To clear the EPG window, press **OK** or **EXIT** button.

Channel Schedule		08.18.2006		
15:00-15:59 BLUE HEELERS				
Tom thinks he's found a suitable creche for his grandson Sam - until rumours of baby bashing start to circulate.				
SERVICE NAME	15:00	15:30	16:00	16:30
7 Digital	BLUE HEELERS	PASSIONS		
7 HD Digital	BLUE HEELERS	PASSIONS		
7 Digita1	BLUE HEELERS	PASSIONS		
7 Digital2	BLUE HEELERS	PASSIONS		
7 Digital3	BLUE HEELERS	PASSIONS		
◄ Channel	▶ Program Event	OK: Return		

Note

- The EPG will only work when you are receiving digital channels.
- To enable EPG to work properly, it is suggested to set the appropriate time zone.

Setting the Sleep Timer

The sleep timer lets you select the amount of time before your TV turns off automatically.

To set the sleep timer, press the **SLEEP** button repeatedly to select the amount of time (30 minutes, 1 hour, and 2 hours can be selected). To turn off the timer, select Sleep Off.

Note

- After you have set sleep timer, when the last 30 seconds have come up, the Power Off screen will appear to remind you after how many seconds the TV will power off. You can press any button to quit.

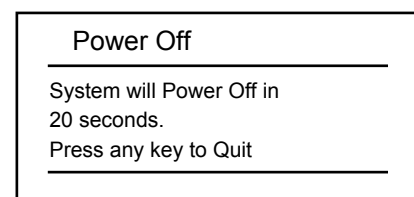

Teletext & Subtitle

Teletext

■ What Is Teletext?

Your System receives Teletext signals broadcast by a TV network, and decodes them into graphical format for viewing. News, weather and sports information, stock exchange prices and programme previews are among the many services available.

■ To Turn On/Off Teletext

- 1 Select a TV channel providing the Teletext program
Press **TTX** button to display the teletext.
- 2 Press **TTX** button again, the text will be superimposed on a TV picture with transparent background. (**Mix** mode)
- 3 Press **TTX** button once more to exit the teletext.

■ Teletext control button list

- **TTX button**
Used to call teletext, change to transparent mode and then exit.
- **EPG button**
In teletext mode, press this button to display the index page.
- **▲/▼button**
Used to scroll page upward or downward.
- **0-9 button**
Directly select any page by using 0 - 9.
Coloured buttons (RED/GREEN/YELLOW/BLUE)
Coloured areas are displayed at the bottom of the screen. The 4 coloured buttons are used to access the items or corresponding pages.
- **Hold button**
Certain pages contain sub-pages which are automatically displayed successively. This button is used to stop or resume sub-page acquisition.
- **Reveal button**
Press the button to reveal the concealed information such as games solutions. Press the button again to hide the information.
- **Size button**
Press this button several times to display the upper, then the lower part of the screen and then return to the normal size teletext page.
- **Update button**
Press the button to view the updated teletext page.



Subtitle

- 1 If the program has subtitle, simply press Subtitle button to display subtitle.
- 2 Press Subtitle again to cancel the subtitle.

Note

- The subtitle function only works in digital channels.

Image Adjustment for D-Sub (PC) Mode/Component Mode

Before adjusting the image, make sure that you select the correct source (D-Sub or YPbPr).

To adjust the image

- 1 Press **MENU** and the main menu screen displays.
- 2 Press **◀ / ▶** to select **DISPLAY** menu, press **▼** to access the menu.
- 3 Within the menu, press **▲, ▼, ◀, ▶** to navigate through the options or adjust an option, press **OK** to confirm a selection and activate it.

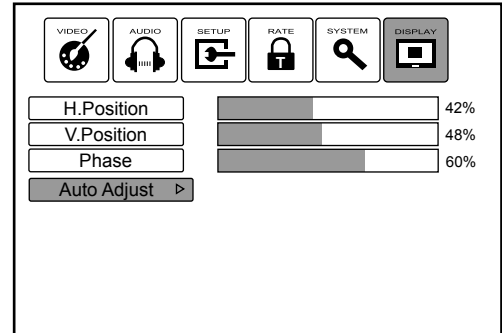

Option	Description
H.Position	Moves the image on the screen left or right.
V Position	Moves the image on the screen up or down.
Phase	Improves the focusing of a stable image.
Auto Adjust (PC mode only)	Selects and activates to start auto adjustment. The television automatically adjusts the image settings, such as position and phase.

Note

- Only in D-Sub and Component mode, the DISPLAY menu can be accessed.
- Only in D-Sub mode, the Auto Adjust can be activated.

Troubleshooting

If after reading these operating instructions, you have additional questions related to the use of your television, please call the services centre in your local area.

Before calling service, please check the symptoms and follow suggested solutions.

Remote Control

<i>Problem</i>	<i>Possible Solutions</i>
Remote control does not operate	<ul style="list-style-type: none">• The batteries could be weak. Replace the batteries.• Check the orientation of the batteries.• Make sure the power cord is plugged in.

Video and Audio

<i>Problem</i>	<i>Possible Solutions</i>
No picture (screen not lit), No sound	<ul style="list-style-type: none">• Make sure the power cord is plugged in.• Press POWER on the TV or on the remote control.• Try another channel; it could be station trouble.
Dark, poor or no picture (Screen lit), good sound	<ul style="list-style-type: none">• Select a proper picture mode.• Adjust the brightness in the video setting.• Check the antenna connections.
No colour/dark picture/colour is not correct	<ul style="list-style-type: none">• Adjust the colour saturation in the video setting.
Only snow and noise appear on the screen	<ul style="list-style-type: none">• Check the antenna connections.• Try another channel; it could be station trouble.
Dotted lines or stripes	<ul style="list-style-type: none">• Adjust the antenna.• Move the TV away from noise sources such as cars, neon signs, or hair dryers.
Double images	<ul style="list-style-type: none">• Using a highly directional outdoor antenna or a cable may solve the problem.
Good picture, no sound	<ul style="list-style-type: none">• The sound may be muted. Press MUTE again to cancel.• Make sure the stereo mode is set to stereo or mono.
Audio noise	<ul style="list-style-type: none">• Communication problems may occur if infrared communication equipment (e.g., infrared cordless headphones) is used near the TV. Move the infrared communication equipment away from the TV until the noise is eliminated.

Troubleshooting

General

<i>Problem</i>	<i>Possible Solutions</i>
One or some channels can't be displayed	<ul style="list-style-type: none">• These channels may be locked. Please unlock them (see <Channel Lock Setup> section).• These channels may be set skipped in the channel list. You may set it to not skipped or select them with 0-9 number buttons.
Lost password	<ul style="list-style-type: none">• You may use the super password (2580) to overwrite the old password, and the system will auto reset the password to 0000.
Some items can't be accessed	<ul style="list-style-type: none">• If a setting option appears in gray, this indicates that the settings option is unavailable in current input mode.
TV cabinet creaks	<ul style="list-style-type: none">• When the TV is in use, there is a natural rise in temperature, causing the cabinet to expand or contract and may be accompanied by a slight creaking noise. This is not a malfunction.
Some settings (such as volume setting, etc.) may not be memorized when the TV loses power or you press main Power Switch to turn off the TV	<ul style="list-style-type: none">• After you make some settings or adjustments, and within 10 seconds you turn off the TV by main Power Switch or the TV loses power, then the settings you have made within 10 seconds may not be memorized. But you can use Power button to switch the TV to standby mode before cutting off the power, then the settings can be memorized.
Control buttons do not operate	<ul style="list-style-type: none">• Disconnect the power cord and wait for a few seconds. Then re-plug the power cord and turn on the unit again.

Plasma Display panel

<i>Problem</i>	<i>Possible Solutions</i>
Some parts of the screen do not light up.	The plasma display panel is manufactured using an extremely high level of precision technology, however, sometimes some parts of the screen may be missing picture elements or have luminous spots. This is not a malfunction.
After-images appear	<p>Do not allow a still picture to be displayed for an extended period, as this can cause a permanent after-image to remain on the Plasma Display.</p> <p>Examples of still pictures include logos, video games, computer images, teletext and images displayed in 4:3 mode.</p> <p>Note</p> <p>The permanent after-image on the Plasma Display resulting from fixed image use is not: an operating defect.</p> <p>This product is not designed to display fixed images for extended periods of time.</p>
Snapping sounds may be heard from the display unit.	This sound is produced when the cabinet expands or contracts due to variations in temperature and is not a malfunction.

Note

If your problem is not solved, turn your unit off and then on again.

Cautions:

Never attempt to repair a defective TV yourself.

Specifications

Type:	PDP TV
Display Size diagonal:	107cm
Power Supply:	AC 100-240V 50/60Hz
Power Consumption:	350W
Dimensions (mm):	1246(W) x 753(H) x 263(D)
Unit Weight (kg):	39
TV System:	Analogue: CCIR (PAL-B/G, NTSC (AV)) Digital: DVB-T (2K/8K OFDM)

DTV Technical Data

Channel Coverage	VHF (174MHz~230MHz), UHF (519MHz~820MHz)
Channel Bandwidth	7MHz
FFT Mode	2K.8K
Constellation	QPSK, 16QAM, 64QAM
Guard Interval Modes	1/4, 1/8, 1/16, 1/32 active symbol duration
Automatic FEC selection	1/2, 2/3, 3/4, 5/6, 7/8
Input Impedance	

Supported Format

Mode	Format	Horizontal frequency (KHz)	Vertical frequency (Hz)
VGA	640X480	31.5 KHz	60 Hz
	640X480	37.5 KHz	75 Hz
	640X480	37.9 KHz	72 Hz
	640X480	43.3 KHz	85 Hz
	720X400	31.5 KHz	70 Hz
SVGA	800X600	35.2 KHz	56 Hz
	800X600	37.9 KHz	60 Hz
	800X600	48.1 KHz	72 Hz
	800X600	46.9 KHz	75 Hz
	800X600	53.7 KHz	85 Hz
XGA	1024X768	48.4 KHz	60 Hz
	1024X768	56.5 KHz	70 Hz
	1024X768	60 KHz	75 Hz

Note

- Design and specifications are subject to change without notice.

PALSONIC CORPORATION PTY LTD
1 JOYNTON AVENUE
WATERLOO NSW 2017 AUSTRALIA
TEL: (02) 9313 7111
FAX: (02) 9313 7555
www.palsonic.com.au

**PALSONIC CUSTOMER SERVICE
TELEPHONE
AUSTRALIA: 1300 657 888**

5944030070
YG Ver. 1.0

Free Manuals Download Website

<http://myh66.com>

<http://usermanuals.us>

<http://www.somanuals.com>

<http://www.4manuals.cc>

<http://www.manual-lib.com>

<http://www.404manual.com>

<http://www.luxmanual.com>

<http://aubethermostatmanual.com>

Golf course search by state

<http://golfingnear.com>

Email search by domain

<http://emailbydomain.com>

Auto manuals search

<http://auto.somanuals.com>

TV manuals search

<http://tv.somanuals.com>