

OWNER'S MANUAL

Palsonic

**127CM CORDLESS REMOTE PLASMA TELEVISION & MONITOR
MODEL: PDP5010**



N111

**PALSONIC CORPORATION PTY LTD
1 JOYNTON AVENUE
WATERLOO NSW 2017 AUSTRALIA
TEL: (02) 9313 7111
FAX: (02) 9313 7555
www.palsonic.com.au**

**PALSONIC CUSTOMER SERVICE
TELEPHONE
AUSTRALIA: 1300 657 888**

Table of Contents

| | |
|--|----|
| Important Information | 1 |
| Important Safety Precautions | 2 |
| Preparations | 5 |
| Using the Remote Control | 5 |
| Cautions regarding use of remote control | 5 |
| Batteries for the Remote Control | 5 |
| Precaution on battery use | 5 |
| Antenna Connection | 6 |
| Power Connection | 6 |
| Identification of Controls | 7 |
| Main Unit | 7 |
| Remote Control | 9 |
| Connections | 10 |
| Cautions Before Connecting | 10 |
| Connect AV1 Input Terminals | 10 |
| Connect AV2 Input Terminals | 11 |
| Connect AV Output Terminals | 12 |
| Connect Component Input Terminals | 13 |
| Connect the HDMI Interface | 14 |
| Connect the D-SUB Interface | 15 |
| Basic Operations | 16 |
| Turning the Unit On and Off | 16 |
| Viewing the MENU | 16 |
| Select Input Signal Source | 16 |
| Displaying Status Information | 16 |
| Displaying Supported Formats | 16 |
| Changing Channels | 17 |
| Adjusting the Volume | 17 |
| Memorising the Channels | 18 |
| Storing Channels in Memory Automatically | 18 |
| Storing Channels in Memory Manually | 18 |
| Setting Auto Frequency Control (AFC) | 18 |
| Manual Fine Tuning | 19 |
| Adding and Erasing Channels | 19 |
| Setting Colour and Sound System | 19 |
| Editing Channels | 20 |
| Editing Channel Number | 20 |
| Editing Channel Name | 20 |
| Setting Picture | 21 |
| Setting Picture | 21 |
| Customising Colour Temperature | 21 |
| Setting Sound | 22 |
| Setting Sound | 22 |
| Setting System | 23 |
| Setting System | 23 |
| Setting On-Screen Display | 23 |
| Setting Menu Skin | 23 |
| Setting Time | 24 |
| Setting Window | 25 |
| Setting Window | 25 |
| Troubleshooting..... | 26 |
| Care and Maintenance | 27 |
| Specifications | 28 |

Important Information

WARNING: TO REDUCE THE RISK OF OR ELECTRIC SHOCK, DO NOT EXPOSE THIS APPARATUS TO RAIN OR MOISTURE.

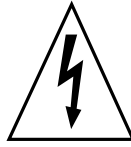
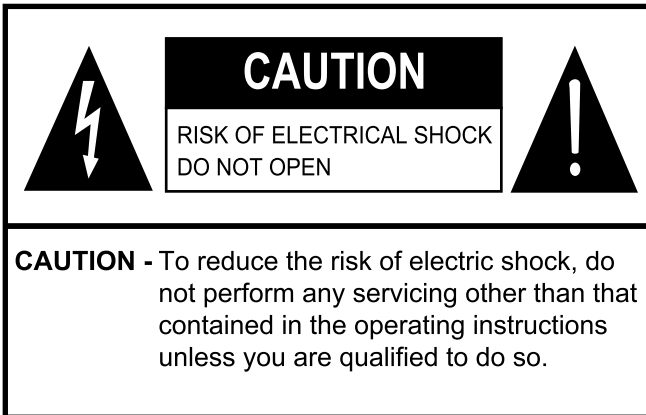

The lightning flash with arrowhead symbol, within an equilateral triangle is intended to alert the user to the presence of insinuated dangerous voltage within the product's enclosure that may be of sufficient magnitude to constitute a risk of electric shock to persons.



The exclamation point within an equilateral triangle is intended to alert the user to the presence of ,important operating and maintenance (servicing) instructions in the literature accompanying the appliance.

Note to CATV system installer: This reminder is provided to call the CATV system installer's attention to Article 820-40 of the National Electrical Code that provides guidelines for proper grounding and, in particular, specifies that the cable ground shall be connected to the grounding system of the building, as close to the point of cable entry as practical. (America only)

This product utilises tin-lead solder, and fluorescent lamp containing a small amount of mercury. Disposal of these materials may be regulated due to environmental considerations. For disposal or recycling information, please contact your local authorities or the Electronic Industries Alliance: www.eia.org (America only)

FCC STATEMENT (America only)

FCC Notice

PDP TV: A CLASS B digital device

This equipment has been tested and found to comply with the limits for a Class digital device, pursuant to part 15 of the FCC Rules. These limits are designed to provide reasonable protection against harmful interference when the equipment is operated in a commercial environment.

This equipment generates, uses, and can radiate radio frequency energy and, if not installed and used in accordance with the instruction manual, may cause harmful interference to radio communications. Operation of this equipment in a residential area is likely to cause harmful interference in which case the user will be required to correct the interference at his own expense.

FCC CAUTION:

Pursuant to 47CFR, Part 15.21 of the FCC rules, any changes or modifications to this monitor not expressly approved by the manufacturer could cause harmful interference and would void the user's authority to operate this device.

WARNING: This is a CLASS B product. In a domestic environment this product may cause radio interference in which case the user may be required to take adequate measures to counter interference.

Important Safety Precautions

Electrical energy can perform many useful functions, but it can also cause personal injuries and property damage if improperly handled. This product has been engineered and manufactured with the highest priority on safety. But **IMPROPER USE CAN RESULT IN POTENTIAL ELECTRICAL SHOCK OR FIRE HAZARD**. In order to prevent potential danger, please observe the following instructions when installing, operating and cleaning the product. To ensure your safety and prolong the service life of your PDP TV product, please read the following precautions carefully before using the product.

- 1. Read these instructions**---All operating instructions must be read and understood before the product is operated.
- 2. Keep these instructions**---These safety and operating instructions must be kept in a safe place for future reference.
- 3. Heed all warnings**---All warnings on the product and in the instructions must be observed closely.
- 4. Follow all instructions**---All operating instructions must be followed.

5. Do not use this apparatus near water---for example, near a bathtub, washbowl, kitchen sink, or laundry tub, in a wet basement, or near swimming pool, and the like.

Do not use immediately after moving from a low temperature to high temperature environment, as this causes condensation, which may result in fire, electric shock, or other hazards.



6. Clean only with dry cloth---Unplug this product from the wall outlet before cleaning. Do not use liquid cleaners or aerosol cleaners. Use a damp cloth for cleaning.

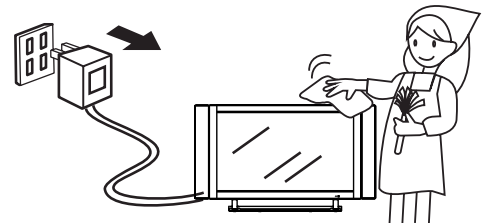

7. Ventilation---Do not block any ventilation openings. Install in accordance with the manufacturer instructions. The vents and other openings in the cabinet are designed for ventilation. Do not cover or block these vents and openings since insufficient ventilation can cause overheating and/or shorten the life of the product. Do not place the product on a bed, sofa, rug or other similar surface, since they can block ventilation openings. This product is not designed for built-in installation; do not place the product in an enclosed place such as a bookcase or rack, unless proper ventilation is provided or the manufacturer's instructions are followed.

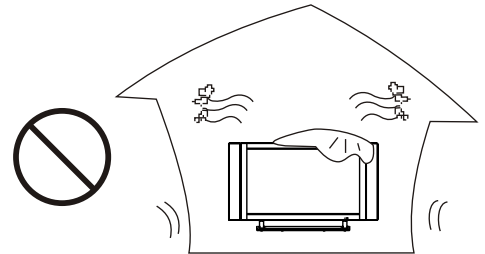

8. Heat sources---Do not install near any heat sources such as radiators, heat registers, stoves, or other apparatus (including amplifiers) that produce heat.

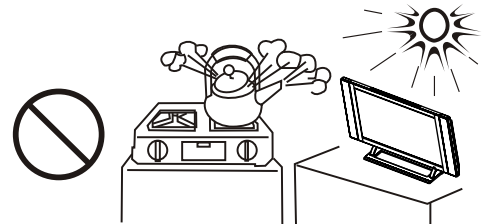

9. Grounding or Polarisation---Do not defeat the safety purpose of the polarised or grounding-type plug. A polarised plug has two blades with one wider than the other. A grounding type plug has two blades and a third grounding prong. The wide blade or the third prong are provided for your safety. If the provided plug does not fit into your outlet, consult an electrician for replacement of the obsolete outlet. **(America only)**

10. Power cord protection---Protect the power cord from being walked on or pinched particularly at plugs, convenience receptacles, and the point where they exit from the apparatus.

11. Attachments---Only use attachments/ accessories specified by the manufacturer. Do not use attachments not recommended by the manufacturer. Use of improper attachments can result in accidents.

Important Safety Precautions

12. Stand---Use only with the cart, stand, tripod, bracket, or table specified by the manufacturer, or sold with the apparatus. Do not place the product on an unstable trolley, stand, tripod or table. Placing the product on an unstable base can cause the product to fall, resulting in serious personal injuries as well as damage to the product. When mounting the product on a wall, be sure to follow the manufacturer's instructions. Use only the mounting by the hardware recommended manufacturer.

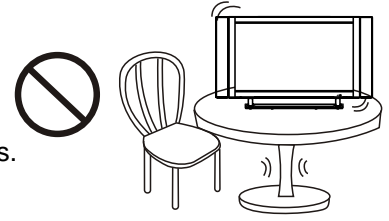

13. Carefully move---When a cart is used, use caution when moving the cart/apparatus combination to avoid injury from tip-over. Sudden stops, excessive force and uneven floor surfaces can cause the product to fall from the trolley.



14. Lightning---Unplug this apparatus during lightning storms or when unused for long of periods time. For added protection for this television equipment during a lightning storm, or when it is left unattended and unused for long periods of time, unplug it from the wall outlet and disconnect the antenna. This will prevent damage to the equipment due to lightning and power-line surges.

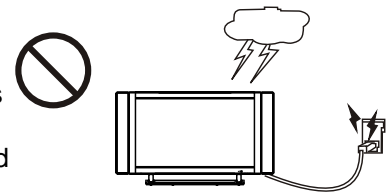

15. Servicing---Refer all servicing to qualified service personnel. Servicing is required when the apparatus has been damaged in any way, such as power-supply cord or plug is damaged, liquid has been spilled or objects have fallen into the apparatus, the apparatus has been exposed to rain or moisture, does not operate normally, or has been dropped.

16. Replacement parts---In case the product needs replacement parts, make sure that the service person uses replacement parts specified by the manufacturer, or those with the same characteristics and performance as the shock and/or original parts. Use of unauthorised parts can result in fire, electric other danger.

17. Overloading---Do not overload wall outlets, extension cords, or convenience receptacles on other equipment as this can result in a risk of fire or electric shock.

18. Entering of objects and liquids---Never insert an object into the product through vents or openings. High voltage flows and/or in the product, and inserting an object can cause electric shock short internal parts. For the same reason, do not spill water or liquid on the product.

19. Damage, requiring service---If any of the following conditions occurs unplug the power cord from the AC outlet, and repairs. request a qualified service person to perform

- When the power cord or plug is damaged.
- When a liquid is spilled on the product or when objects have fallen into the product.
- When the product has been exposed to rain or water.
- When the product does not operate properly as described in the operating instructions.

Do not touch the controls other than those described in the operating instructions. Improper adjustment of controls not described in the instructions can cause damage, which often requires extensive adjustment work by a qualified technician.

- If the product has been dropped or the cabinet has been damaged in any way.
- When the product displays an abnormal condition or exhibits a distinct change in performance. Any noticeable abnormality in the product indicates that the product needs servicing.

20. Safety checks---Upon completion of service or repair work, request the service technician to perform safety checks to ensure that the product is in proper operating condition.

21. Wall or ceiling mounting---When mounting the product on a wall or ceiling, be sure to install the product according to the method recommended by the manufacturer. This is a safety feature.

Important Safety Precautions

22. Power source---This product is intended to be supplied by a listed power supply indicated on the marking label. If you are not sure of the type of power supply to your home, consult your product dealer or local power company. For added protection for this product during a lightning storm, or when it is left unattended and unused for long periods of time, unplug it from the wall outlet and disconnect the cable system. This will prevent damage to the product due to lightning and power line surges. When the unit has to be used with another power supply voltage, the power cable must be changed. Consult your product dealer. The socket outlet should be installed near the equipment and easily accessible. Use only the power cord designated by our dealer to ensure safety and EMC. When connecting other products such as VCRs and personal computers, you should turn off the power of the unit for protection against electric shock.

23. Panel protection---The PDP panel used in this product is made of glass. Therefore, it can break when the product is dropped or impacted upon by other objects. Be careful not to be injured by broken glass pieces in case the PDP panel breaks.

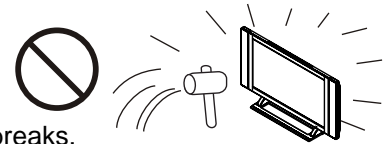

24. Pixel defect---The PDP panel is a very high technology product, giving you finely detailed pictures. Occasionally, a few non-active pixels may appear on the screen as a fixed point of blue, green or red. Please note that this does not affect the performance of your product.

■ If an outside antenna is connected to the television equipment, be sure the antenna system is grounded so as to provide some protection against voltage surges and built-up static charges. Section 810 of the National Electrical Code provides information with respect to proper grounding of the mast and supporting structure, grounding of the lead-in wire to an antenna discharge unit, size of grounding conductors, location of antenna-discharge unit, connection to grounding electrodes, and requirements for the grounding electrode. (America only)

EXAMPLE OF ANTENNA GROUNDING AS PER NATIONAL ELECTRICAL CODE

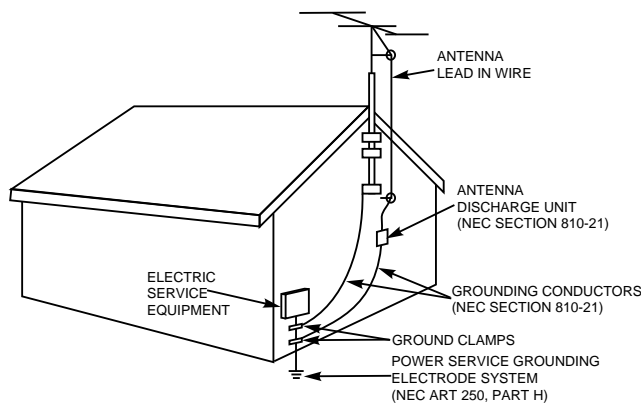

NEC---NATIONAL ELECTRICAL CODE

■ An outside antenna system should not be located in the vicinity of overhead power lines or other electric light or power circuits, or where it can collide with such power lines or circuits. When installing an outside antenna system, extreme care should be taken to keep from touching such power lines or circuits, as contact with them might be fatal.

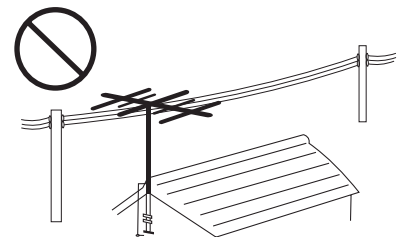

Preparations

Using the Remote Control

Use the remote control by pointing it towards the remote sensor window of the set. Objects between the remote control and sensor window may prevent proper operation.

Note: This illustration is for reference only. The remote sensor may be in different locations on different models.

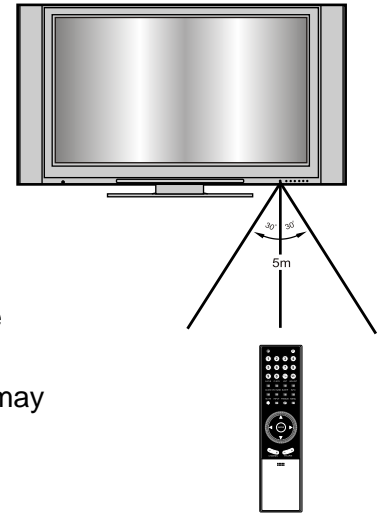

Cautions regarding use of remote control

- Do not expose the remote control to shock. In addition, do not expose the remote control to liquids, and do not place in an area with high humidity.
- Do not install or place the remote control under direct sunlight. The heat may cause deformation of the unit.
- The remote control may not work properly if the remote sensor window of the main unit is under direct sunlight or strong lighting. In such a case, change the angle of the lighting or PDP TV set, or operate the remote control closer to the remote sensor window.

Batteries for the Remote Control

If the remote control fails to operate the PDP TV functions, replace the batteries in the remote control.

- Open the battery cover.
- Insert two size-AAA batteries.
Install two "AAA" batteries matching the +/- polarities of the battery to the +1- marks inside the battery compartment.
- Replace the battery cover.

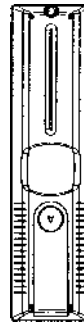

Precaution on battery use

Improper use of batteries can result in a leakage of chemicals and/or explosion. Be sure to follow the instructions below.

- Place batteries with their terminals corresponding to the (+) and (-) indications.
- Different types of batteries have different characteristics.
- Do not mix batteries of different types.
- Do not mix old and new batteries. Mixing old and new batteries can shorten the life of new batteries and/or cause old batteries to leak chemicals.
- Remove batteries as soon as they are non-operable. Chemicals that leak from batteries can cause a rash. If chemical leakage is found, wipe with a cloth.
- The batteries supplied with the product may have a shorter life expectancy due to storage conditions.
- If the remote control is not used for an extended period of time, remove the batteries from the remote control.

Preparations

Antenna Connection

INSTALL the unit in a room where direct light will not fall upon the screen. Total darkness or a reflection on the picture screen may cause eyestrain. Soft and indirect lighting is recommended for comfortable viewing. Optimum reception of colour requires a good signal and will generally mean that an outdoor aerial must be used. The exact type and position of the aerial will depend upon your particular area.

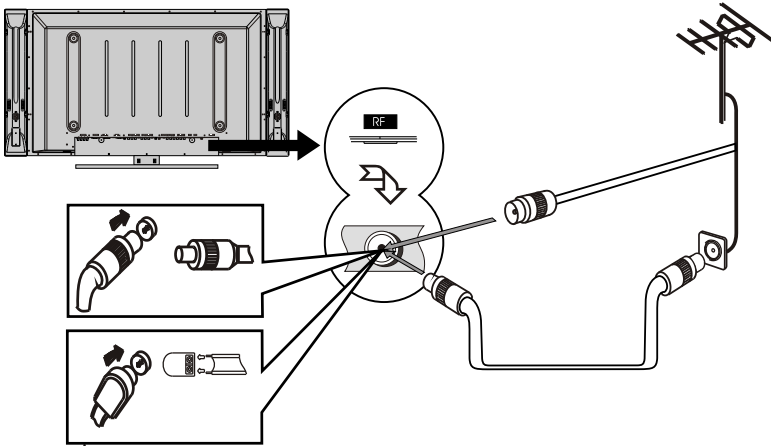

Note:

- It is recommended that the 75-ohm coaxial cable be used to eliminate interference and noise that may occur due to radio wave conditions.
- The aerial cable should not be bundled with the power cord and the like.

Speaker Connection

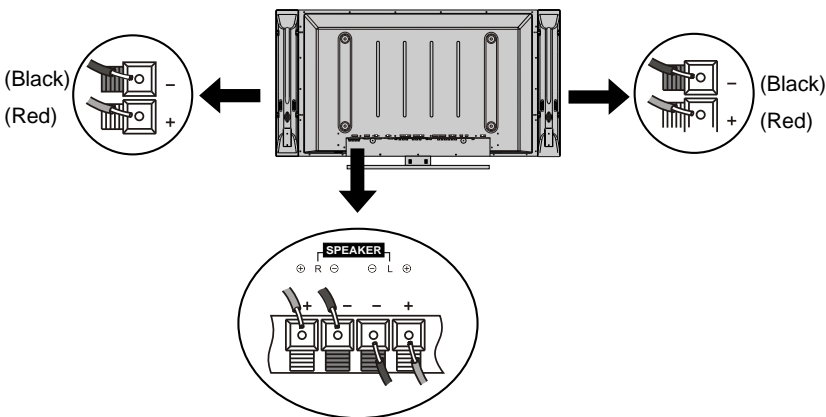

Connect the speaker audio cable to the external speaker output jack on the unit matching the "+" and "-" ends of the cable.

Note:

1. Unplug the plasma display and all connected components before connecting the Speakers.
2. The illustration may be different depending on model.

Power Connection

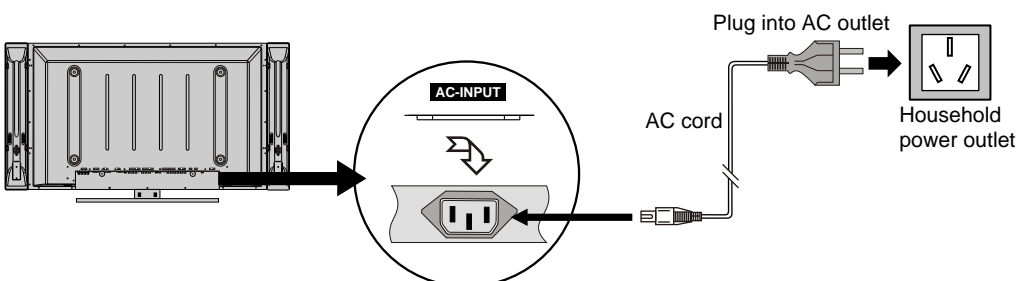

1. Connecting the female plug to the AC socket on the unit.
2. Connecting the male plug to the wall outlet as illustrated.

Note:

- This product should be operated only from the type of power source indicated on the marking label.
- Always unplug the AC cord from power outlet when not using for a long period of time.
- The illustration of the AC plug is for your reference only.

Identification of Controls

Main Unit

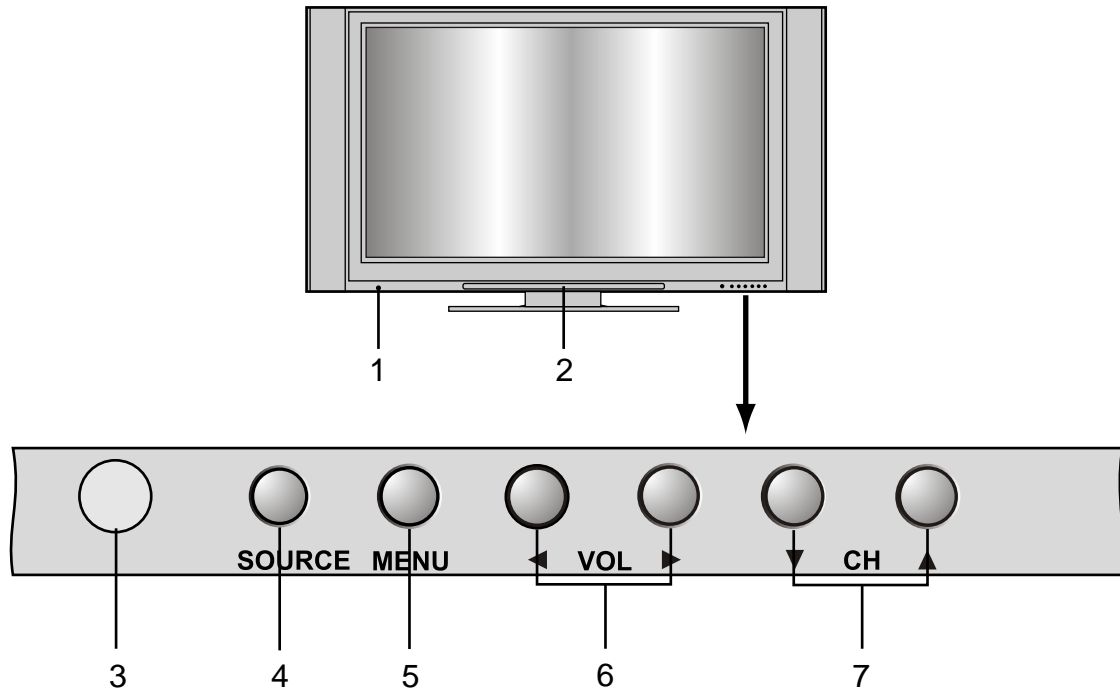

1. **POWER SWITCH**
2. **INDICATOR**
3. **REMOTE SENSOR**

4. **SOURCE**

To select the input signal source.

5. **MENU**

Press this button to access the MENU main page.

6. **VOL ◀/▶**

Press the **VOL ▶** or **VOL ◀** button to directly increase or decrease the sound volume level;
In OSD MENU, press these buttons to adjust the value or setting of each item.

7. **CH ▲/▼**

Press these two buttons to directly change the TV channel;
In OSD MENU, press these buttons to choose the OSD items.

Note:

*Functions of **VOL ◀/▶**, **CH ▲/▼**, **MENU** and **SOURCE** are also provided to the remote control.
This operating manual provides a description based on operating functions with the remote control.*

Identification of Controls

Main Unit

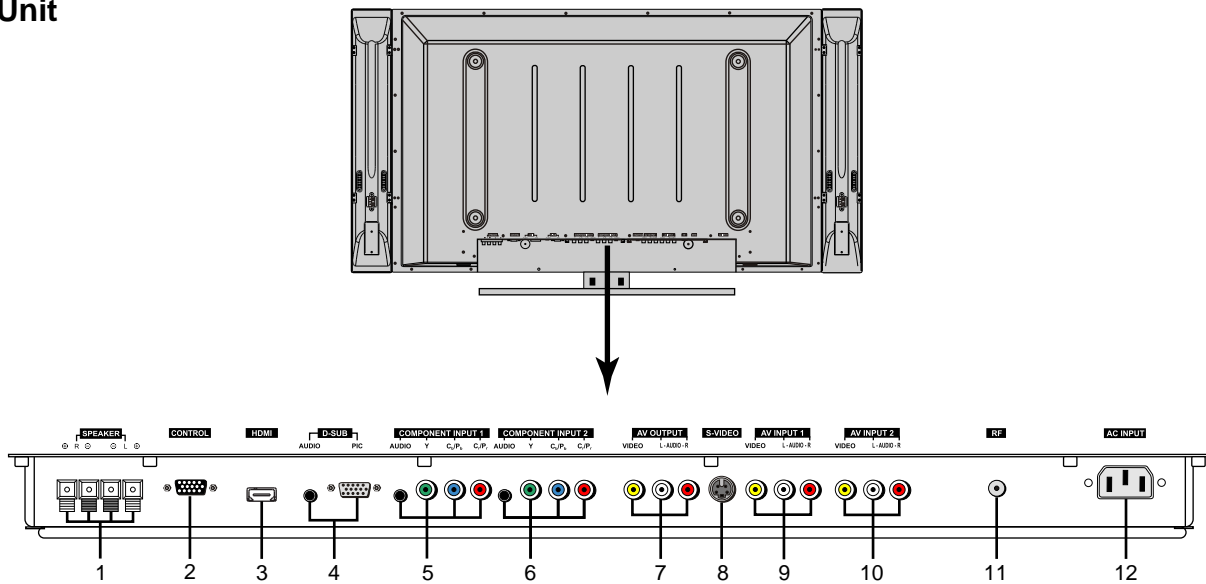



- 1 **Speaker output jacks**
- 2 **RS232 control interface**
For service only. The user cannot operate the unit through the RS232 terminals.
- 3 **HDMI input**
To connect with those equipments with HDMI interface, for example, Set-top box or DVD player.
- 4 **D-Sub interface/Audio in**
Connect with those equipments with D-Sub interface, for example, PC.
Connect the audio jacks as well with audio cable.
- 5 **Component inputs 1**
Connect to the audio and component output jacks of a DVD player or Set-Top Box.
- 6 **Component inputs 2**
Connect to the audio and component output jacks of a DVD player or Set-Top Box.
- 7 **AV outputs**
Connect to the VCR input jacks to record programs.
- 8 **S-Video input**
Receive a S-Video signal from external source such as VCR or DVD player.
- 9 **AV inputs 1**
Receive a video/audio signals from external sources such as VCR or DVD player.
- 10 **AV inputs 2**
Receive a video/audio signals from external sources such as VCR or DVD player.
- 11 **Antenna input**
Allow you to connect cable or outdoor antenna.
- 12 **AC power input**

Identification of Controls

Remote Control

Descriptions for the button functions

1. **POWER**  Turn the unit on or off
2. **0-9 Buttons** Direct channel select
3. **--/← button** To select channel digit.
4.  **button** To quickly jump between current channel and last selected channel.
5. **S-SYS** To set sound system
6. **C-SYS** To set colour system
7. **LIST** To display the supported format list in D-SUB, HDMI or Component input mode.
8. **ADJUST** To rectify the picture automatically in VGA mode
9. **AUDIO** To select sound mode
10. **PICTURE** To select picture mode
11. **SLEEP** To set sleep timer
12. **INFO** To display current status information
13. **MUTE** Sound mute
14. **INPUT** To access Input Select menu
15. **FREEZE** To freeze current picture
16. **MENU** To access the MENU main page
17. **▲/▼/◀/▶** Menu navigators in menu operations
18. **ENTER** To confirm your operation or setting or access the submenu
19. **CHANNEL +/-** To switch channels
20. **VOLUME +/-** To adjust volume

This button has no function

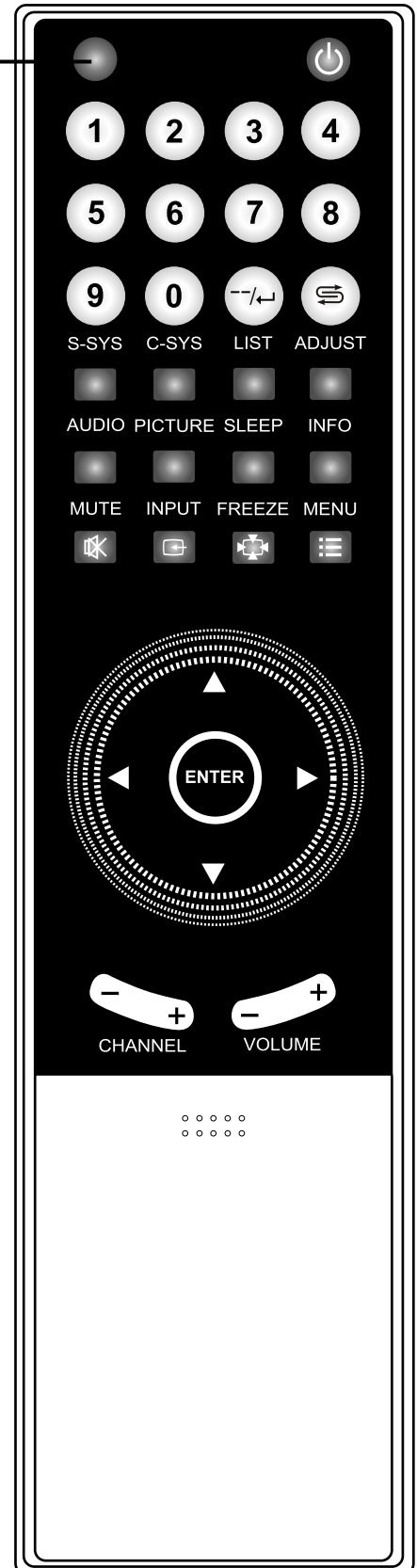

Connections

Cautions Before Connecting

- Carefully check the terminals for position and type before making any connections.
- The illustration of the external equipment may be different depending on your model.
- Loose connectors can result in image or colour problems. Make sure that all connectors are securely inserted into their terminals.
- Refer to the operating manual of the external device as well.
- When connecting an external device, turn the power off on the panel to avoid any issues.

Connect AV1 Input Terminals

Connect the Audio/Video cables between the Audio (L/R)/Video jacks on the unit and the video player.

For better video, you can use the S-video jack if your source supports it. The S-video shares the same audio terminals with video terminal.

To view the program from the AV1 input terminals, please select AV1 (or S-VIDEO when using s-video jack) in the INPUT SELECT menu after proper connection.

| INPUT SELECT |
|--------------|
| D-SUB |
| HDMI |
| TV |
| ✓ AV 1 |
| AV 2 |
| S-VIDEO |
| HDTV 1 |
| HDTV 2 |

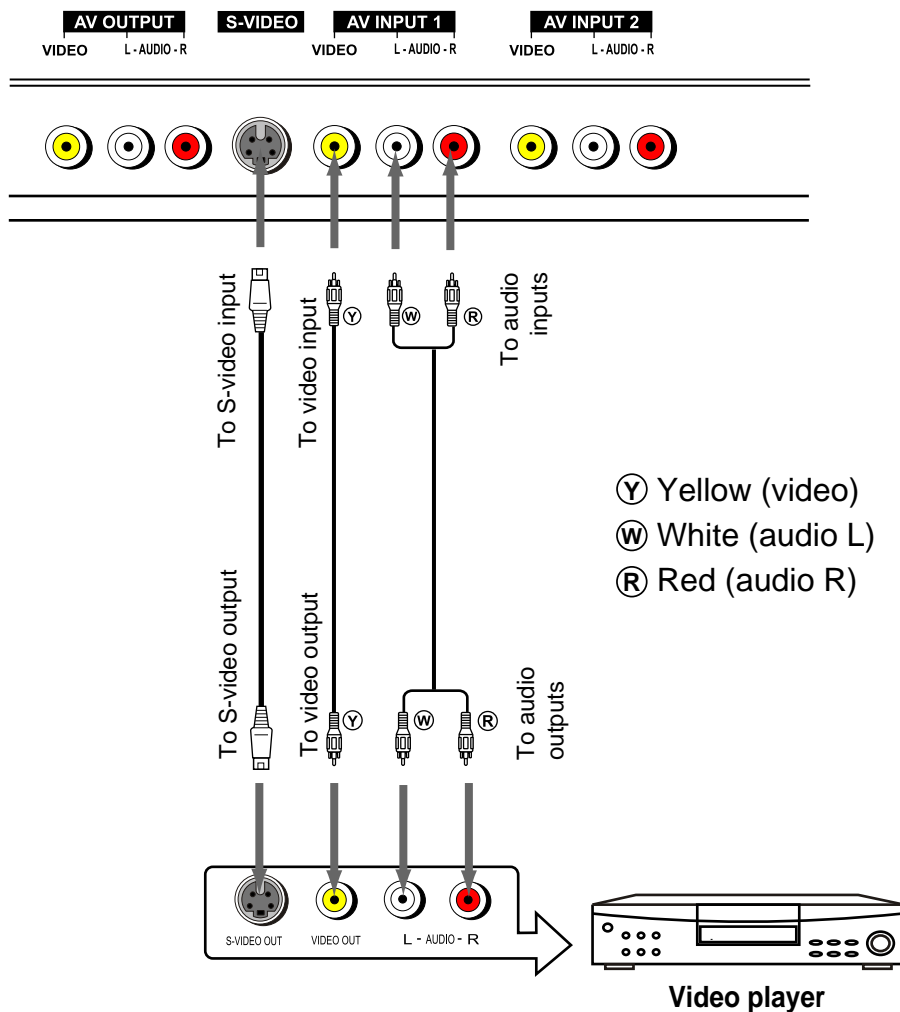

Connections

Connect AV2 Input Terminals

Connect the Audio/Video cables between the Audio (L/R)/Video jacks on the unit and the video camera.

To view the program from the AV2 input terminals, please select AV2 in the INPUT SELECT menu after proper connection.

| INPUT SELECT |
|--------------|
| D-SUB |
| HDMI |
| TV |
| AV 1 |
| √ AV 2 |
| S-VIDEO |
| HDTV 1 |
| HDTV 2 |

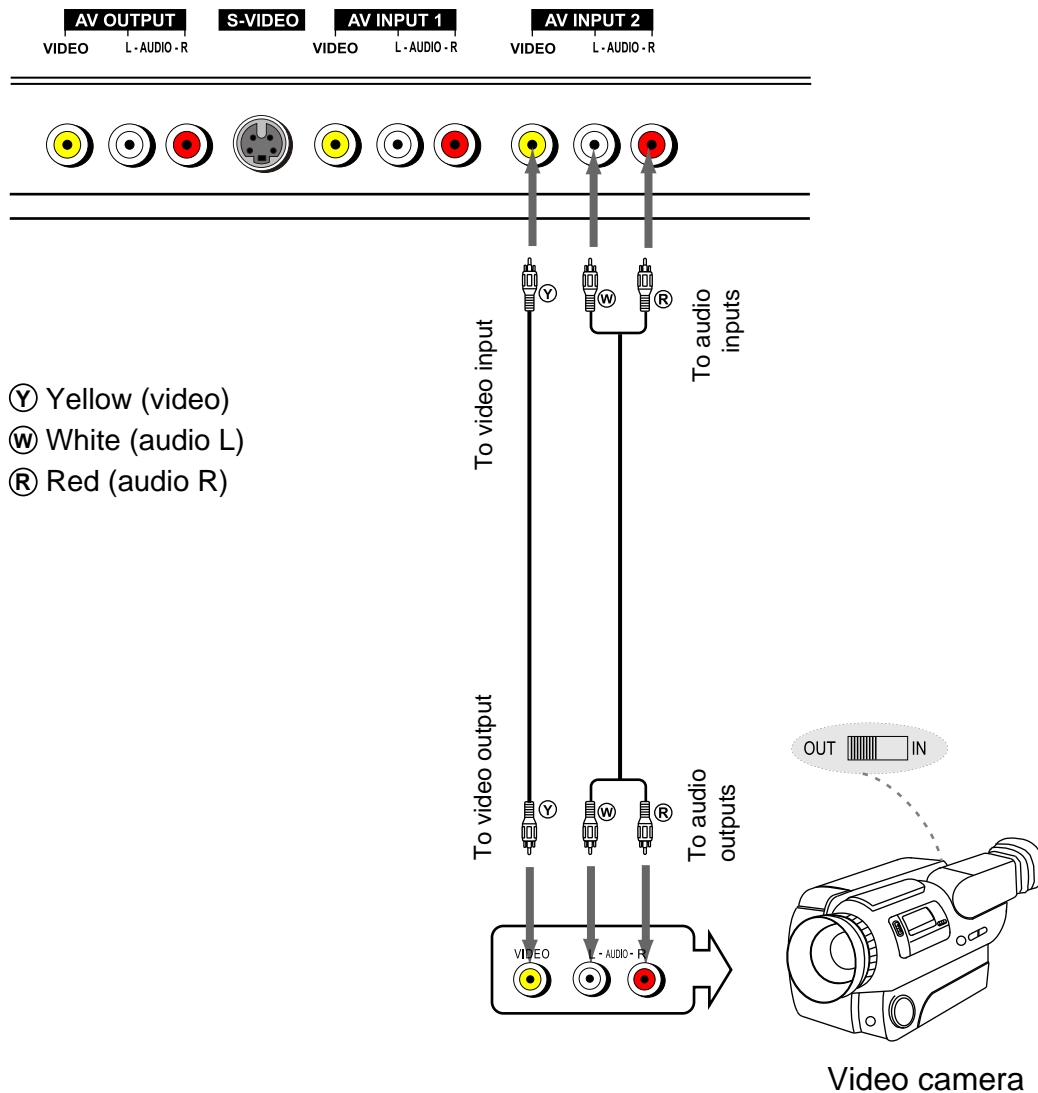

Connections

Connect AV Output Terminals

Connect the Audio/Video cables between the Audio (L/R)/Video jacks on the unit and VCR.

To record the desired program, please select a program you wish to record firstly, then turn on your VCR, insert videotape for recording and press the Record button to begin recording.

Note: The AV output terminals output the audio/video signal from the Antenna input or AV inputs.

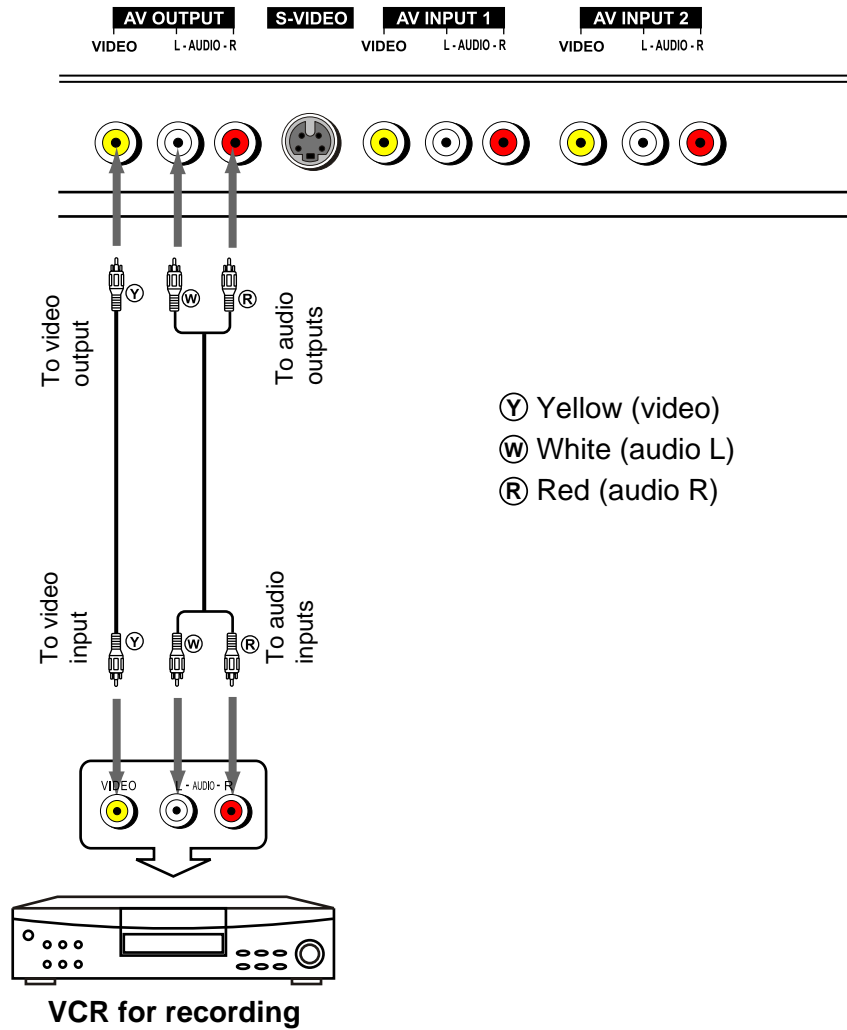

Connections

Connect Component Input Terminals

Connect the component video cable between the component input jacks on the unit and component output jacks on the video player, for example, DVD player or Set-top box.

Connect the Audio cable between the audio input jacks on the unit and audio output jacks on the video player.

To view the program from component terminals, please select HDTV1 or HDTV2 in the INPUT SELECT menu according to your connection.

| INPUT SELECT |
|--------------|
| D-SUB |
| HDMI |
| TV |
| AV 1 |
| AV 2 |
| S-VIDEO |
| ✓ HDTV 1 |
| HDTV 2 |

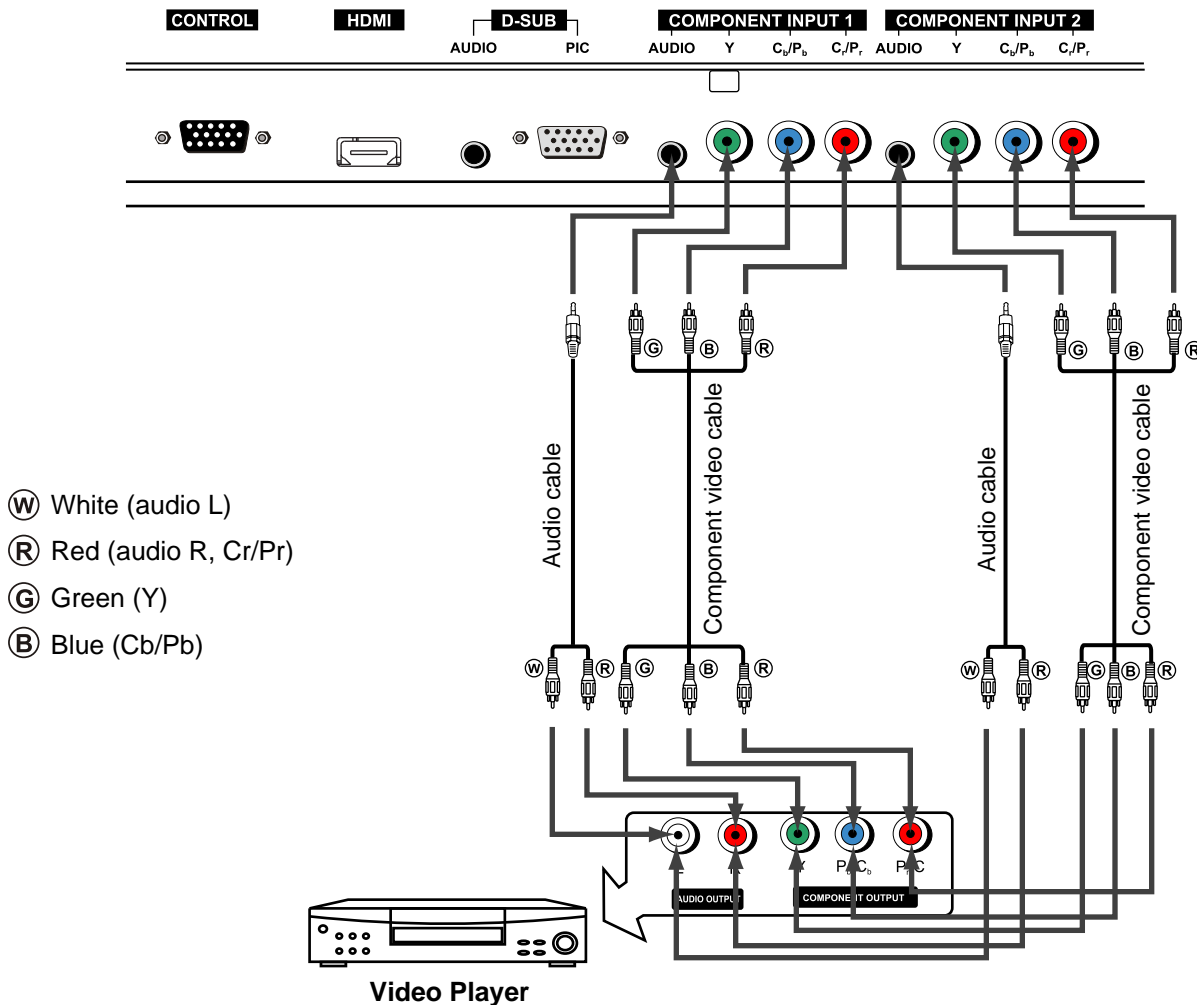

Connections

Connect the HDMI Interface

Connect the HDMI cable between the HDMI interface on the unit and the HDMI output interface on the video equipment.

To view the program from the HDMI interface, please select HDMI in the INPUT SELECT menu after proper connection.

Note:

The HDMI Sources are compatible with DVI displays through the use of a passive cable converter. So you may connect product with DVI output jack to the unit.

Connect a passive cable converter between the HDMI input jack on the unit and DVI jack on the product. Connect an Audio cable between the AUDIO output on your product and AUDIO input jack of D-SUB IN on the unit.

| INPUT SELECT |
|--------------|
| D-SUB |
| √ HDMI |
| TV |
| AV 1 |
| AV 2 |
| S-VIDEO |
| HDTV 1 |
| HDTV 2 |

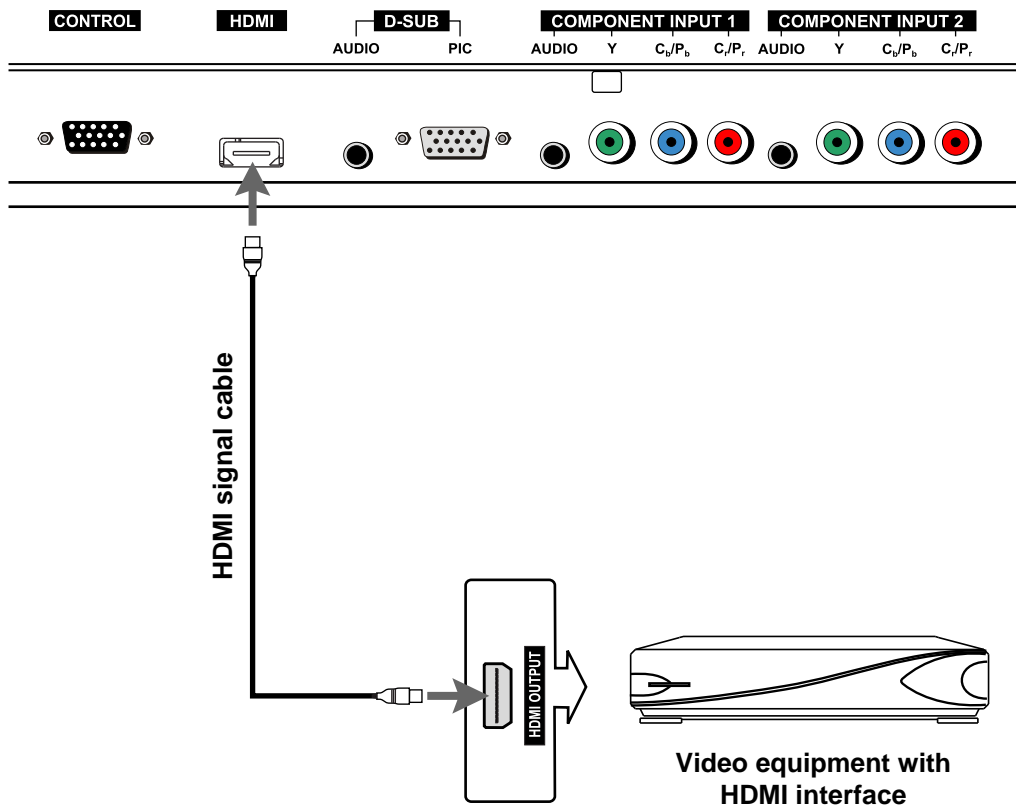

Connections

Connect the D-SUB Interface

Connect the D-SUB cable between the D-SUB interface on the unit and the D-SUB output interface on the video equipment or PC.

Connect the Audio cable between the audio input jacks on the unit and audio output jacks on the video player or PC.

To view the program from the D-SUB interface, please select D-SUB in the INPUT SELECT menu after proper connection.

| INPUT SELECT |
|--------------|
| ✓ D-SUB |
| HDMI |
| TV |
| AV 1 |
| AV 2 |
| S-VIDEO |
| HDTV 1 |
| HDTV 2 |

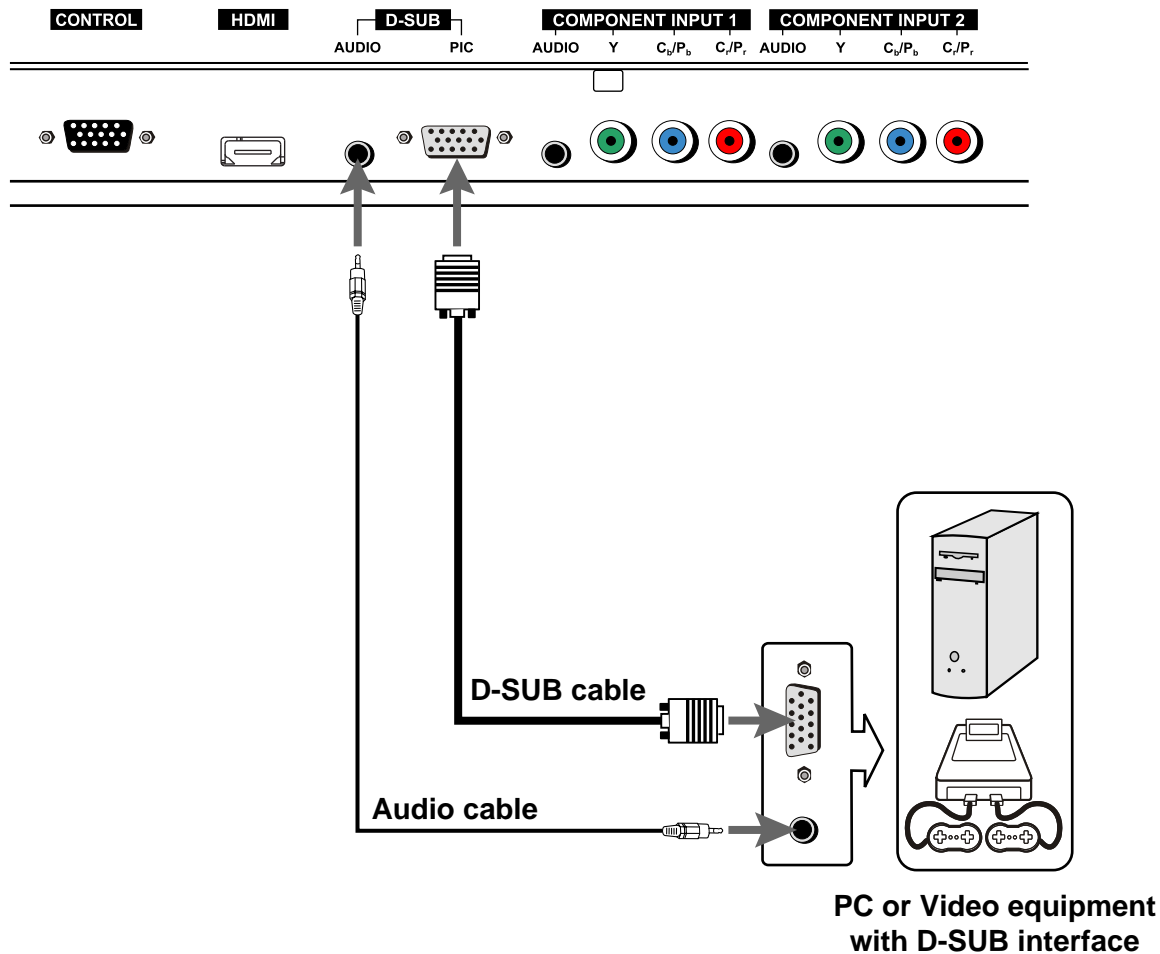

Basic Operations

Turning the Unit On and Off

■ Turning On

Insert the power cord into the wall outlet. Press the power switch to power on.

If the unit is in STANDBY mode, please press the POWER  button to turn on the unit.

■ Turning Off

With the power on, press the Power  button to turn off.

If you would like to cut off the power completely, press the power switch directly.

Viewing the MENU

Your PDP TV has a simple, easy-to-use menu system that appears on the screen. This system makes it convenient and fast to use features on the unit. The unit also lets you display the status of many of your PDP TV features.

- With the power on, press the MENU button on the remote control. The main menu appears on the screen.
- Use ▲/▼ to select submenu item. Use the ENTER or ◀/▶ to access the selected submenu page.
- Use ▲/▼ to select menu items and the ◀/▶ to adjust the value of the selected item. Also use the ENTER ▶ or to confirm your settings or access the sub pages. Those items that are unnecessary to adjust cannot be selected
- During menu operations, use the MENU button to return to the parental menu or exit the menu operations.

| PICTURE | |
|--------------|----------|
| Brightness | 65 |
| Contrast | 50 |
| Color | 50 |
| Sharpness | 3 |
| Color Temp. | Warm |
| Picture Mode | Personal |

Note: To clearly introduce the menu operations, this operating manual provides a description based on operation with the remote control.

Select Input Signal Source

- Press the INPUT button to display the INPUT SELECT menu.
- Press ▲/▼ to select the desired input source.
- Press ENTER to confirm.

Note: the last input source will be memorised when the unit is turned off.

| INPUT SELECT |
|--------------|
| D-SUB |
| HDMI |
| TV |
| AV 1 |
| AV 2 |
| S-VIDEO |
| ✓ HDTV 1 |
| HDTV 2 |

Displaying Status Information

Press the INFO button on the remote control, the unit displays current status information such as channel number, signal source, etc.

Displaying Supported Formats

Press the LIST button on the remote control, the unit displays all formats supported by this unit in current mode. The button may not work in some modes, for example, in TV mode.

Basic Operations

Changing Channels

■ Using the Channel Buttons (CH+ or CH-)

Press the **CH+** or **CH-** to change channels.

When you press the **CH+** or **CH-**, the unit changes channels in sequence. You will see all the channels that the unit has memorised.

You will not see channels that were erased.

■ Direct Accessing Channels

Press the number buttons to go directly to a channel.

To select a one-digit channel: press the 1-9 number buttons to input the channel number and the unit goes to the selected channel.

To select a two-digit channel: press the $\overline{\text{---}}/\leftarrow$ button to display - -, press the 0-9 number buttons to input the channel number and the unit goes to the selected channel.

To select a three-digit channel: press the $\overline{\text{---}}/\leftarrow$ button to display - - -, press the 0-9 number buttons to input the channel number and the unit goes to the selected channel.

Note: *There are some other methods to select by using the 0-9 number buttons.*

When you use the number buttons, you can directly select those channels that were skipped.

■ Using the Return \Rightarrow button

Press this button to switch between the current channel and the previous channel.

Adjusting the Volume

■ Using the volume buttons (VOL+ and VOL-)

Press the **VOL +** or **VOL-** to increase or decrease the volume.

■ Using the MUTE button

At any time, you can temporarily cut off the sound using the MUTE button. To turn mute off, press the MUTE button again.

Memorising the Channels

Your PDP TV can memorise and store all the available channels. After the available channels are memorised, use CH+/- to scan the channels.

Storing Channels in Memory Automatically

- Press MENU to display the menu main page.
- Press ▲/▼ repeatedly to select CHANNEL item.
- Press ENTER or ◀/▶ to access the submenu.
- Press ▲/▼ repeatedly to select Auto Search item.
- Press ▶ to start the process of auto searching. The unit stores all available channels in memory automatically.
During the process of the Auto Search, you can press MENU to exit.

Note: Before you start Auto Search, please refer to the section of [Setting Colour and Sound System] to select a proper sound system according to your area.

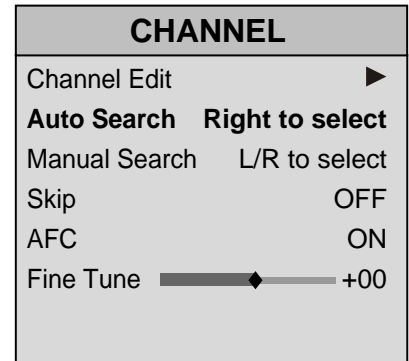

Storing Channels in Memory Manually

Use Manual Search if desired channels cannot be memorised or if you would like to store channels to specific channel numbers one by one.

- Press MENU to display the menu main page.
- Press ▲/▼ repeatedly to select CHANNEL item.
- Press ENTER or ◀/▶ to access the submenu.
- Press ▲/▼ repeatedly to select Manual Search item.
- Press ◀/▶ start manual search.
Pressing ▶ the set searches towards higher frequency;
Pressing ◀ the set searches towards lower frequency;
The search stops when a program is found and this program will be stored in current channel.

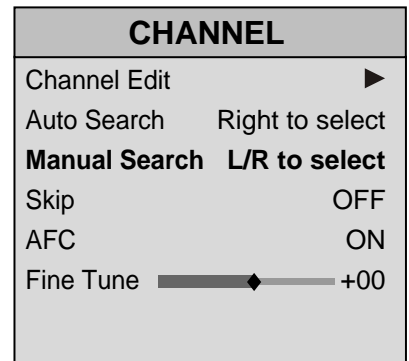

Setting Auto Frequency Control (AFC)

- Press MENU to display the menu main page.
- Press ▲/▼ repeatedly to select CHANNEL item.
- Press ENTER or ◀/▶ to access the submenu.
- Press ▲/▼ repeatedly to select AFC item.
- Press ◀/▶ to select ON or OFF.
When the AFC is set to ON, the unit will automatically tune the program frequency to provide the best possible picture and sound.

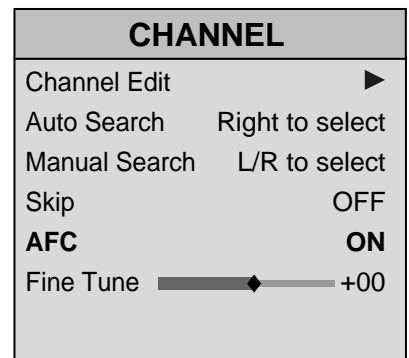

Memorising the Channels

Manual Fine Tuning

- Press MENU to display the menu main page.
- Press ▲/▼ repeatedly to select CHANNEL item.
- Press ENTER or ◀/▶ to access the submenu.
- Press ▲/▼ repeatedly to select Fine Tune item.
- Press ◀/▶ to fine tune till the best possible picture and sound are obtained.
If you fine tune a program manually, the AFC will be turned off automatically.

| CHANNEL | |
|---------------|-----------------|
| Channel Edit | ▶ |
| Auto Search | Right to select |
| Manual Search | L/R to select |
| Skip | OFF |
| AFC | ON |
| Fine Tune | ◀ ◆ ▶ +00 |

Adding and Erasing Channels

- Press MENU to display the menu main page.
- Press ▲/▼ repeatedly to select CHANNEL item.
- Press ENTER or ◀/▶ to access the submenu.
- Press ▲/▼ repeatedly to select Skip item.
- Press ◀/▶ to select ON or OFF.
When the item is set to ON, the selected channel will be erased.
When the item is set to OFF, the selected channel will be added.
The erased channels cannot be selected by using the CH+/- buttons unless you use number buttons to input channel number directly.

| CHANNEL | |
|---------------|-----------------|
| Channel Edit | ▶ |
| Auto Search | Right to select |
| Manual Search | L/R to select |
| Skip | OFF |
| AFC | ON |
| Fine Tune | ◀ ◆ ▶ +00 |

Setting Colour and Sound System

- Press MENU to display the menu main page.
- Press ▲/▼ repeatedly to select OPTION item.
- Press ENTER or ◀/▶ to access the submenu.
- Press ▲/▼ to select Video Format item.
- Press ◀/▶ to select a proper colour system.
Normally, this item is set to AUTO.
- Press ▲/▼ to select Audio Format item.
- Press ◀/▶ to select a proper sound system according to your area's broadcasting system.

| OPTION | |
|--------------|-----|
| Video Format | PAL |
| Audio Format | BG |

Note: You may use the C-SYS button to quickly select the color system;
You may also use the S-SYS button to quickly select the sound system.

Editing Channels

Editing Channel Number

You may use this function to arrange the channel order as your will.

- Press MENU to display the menu main page.
- Press ▲/▼ repeatedly to select CHANNEL item.
- Press ENTER or ◀/▶ to access the submenu.
- Press ▲/▼ to select Channel Edit item.
If the Channel Edit is highlighted automatically, this step can be skipped.
- Press ENTER or ▶ to access the sub page.
- Press ▲/▼ to select Channel Number Edit item.
If the Channel Number Edit is highlighted automatically, this step can be skipped.
- Press ENTER or ▶ to access the sub page.
In the channel number editing page, use ◀/▶ to move the cursor; use ▲/▼ to select a target channel that is to exchange contents with current channel. Use ENTER to confirm or MENU to return.

```
Current Channel Num    004
Current Channel Name

Edit Channel Number   005
Left / right key to move cursor
Up / down to change channels
Select to Edit / menu to Exit
```

```
CHANNEL
Channel Edit ▶
Auto Search      Right to select
Manual Search    L/R to select
Skip              OFF
AFC              ON
Fine Tune       [Progress Bar] +00
```

```
CHANNEL
Channel Number Edit ▶
Channel Name Edit   ▶
```

Editing Channel Name

You may use this function to edit the channel name as your will.

- From the channel editing sub page, press ▲/▼ to select Channel Name Edit item.
- Press ENTER or ▶ to access the sub page.
In the channel name editing page, use ◀/▶ to move the cursor; use ▲/▼ to change name. Use INPUT to clear or MENU to return.

```
CHANNEL
Channel Number Edit ▶
Channel Name Edit   ▶
```

```
Current Channel Num    004
Current Channel Name   TV1

Edit Channel Name     TV1
left / right key to move cursor
up / down to change name
source to clear label
menu to Exit
```

Setting Picture

Setting Picture

- Press MENU to display the menu main page.
- Press ▲/▼ repeatedly to select PICTURE item.
- Press ENTER or ◀/▶ to access the submenu.
- Press ▲/▼ to select menu item that you would like to adjust.
- Press ◀/▶ to adjust the value of the selected item.

As an example, the right illustration is the PICTURE menu page in TV mode.

| PICTURE | |
|--------------|----------|
| Brightness | 65 |
| Contrast | 50 |
| Color | 50 |
| Sharpness | 3 |
| Color Temp. | Warm |
| Picture Mode | Personal |

| Item | Descriptions | Notes |
|--------------|---|---|
| Brightness | Press ◀/▶ to adjust screen brightness for easier viewing of dark picture such as scenes and black hair. | <ul style="list-style-type: none"> ■ The Tint is for NTSC only. The menu items may be different when the unit works in different mode. For example, the Frequency and Phase items may be unavailable in TV and AV mode. ■ Some items display in grey and you will find that they cannot be selected. In this case, these items are unnecessary to adjust. ■ The unit allows you to customise the color temperature in VGA mode only. ■ You may press the PICTURE button to quickly select a desired picture mode. |
| Contrast | Press ◀/▶ to adjust image contrast. | |
| Color | Press ◀/▶ to adjust image colour saturation. | |
| Tint | Press ◀/▶ to adjust the skin tone. | |
| Sharpness | Press ◀/▶ to adjust the image sharpness. | |
| Color Temp. | Press ◀/▶ to select colour temperature setting for the image. | |
| Picture Mode | Press ◀/▶ to select a desired picture mode. | |
| Frequency | Press ◀/▶ to adjust the image frequency. Adjust the clock frequency of the set's internal clock signal. If shimmering or rainbow-like noise is apparent in the image, try adjusting the clock frequency setting. | |
| Phase | Press ◀/▶ to adjust the image phase. You may find that images blur, depending on the clock phase of your PC's Processor. If you experience blurring, you can obtain a clearer image by adjusting the phase setting. | |

Customising Colour Temperature

- With working in VGA mode, press ▲/▼ to select Color Temp item in the PICTURE menu page.
- Press ◀/▶ to select User and press ENTER to access the sub page.
- Press ▲/▼ to select Red, Green or Blue item.
- Press ◀/▶ to adjust the value until the colour temperature is satisfied. Press MENU to return or exit.

| PICTURE | |
|---------|-----|
| Red | 20 |
| Green | 20 |
| Blue | 200 |

Setting Sound

Setting Sound

- Press MENU to display the menu main page.
- Press ▲/▼ repeatedly to select SOUND item.
- Press ENTER ◀/▶ or to access the submenu.
- Press ▲/▼ to select menu item that you would like to adjust.
- Press ◀/▶ to adjust the value of the selected item.

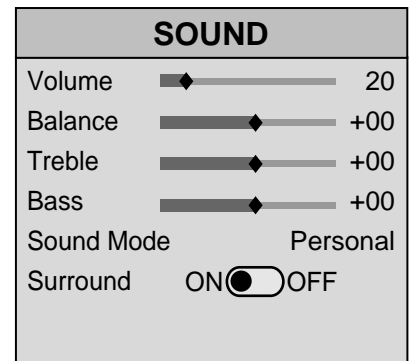

| Item | Descriptions | Notes |
|------------|---|--|
| Volume | Press ◀/▶ to adjust the volume. | <ul style="list-style-type: none"> ■ The menu items may be different when the unit works in different mode. ■ You may press the Audio button to quickly select a desired sound mode. |
| Balance | Press ◀/▶ to adjust the sound balance. | |
| Treble | Press ◀/▶ to adjust treble sound effect. | |
| Bass | Press ◀/▶ to adjust bass sound effect. | |
| Sound Mode | Press ◀/▶ to select a desired sound mode. | |
| Surround | Press ◀/▶ to turn on or off this effect. | |

Setting System

Setting System

- Press MENU to display the menu main page.
- Press ▲/▼ repeatedly to select SETTING item.
- Press ENTER or ◀/▶ to access the submenu.
- Press ▲/▼ to select menu item that you would like to adjust.

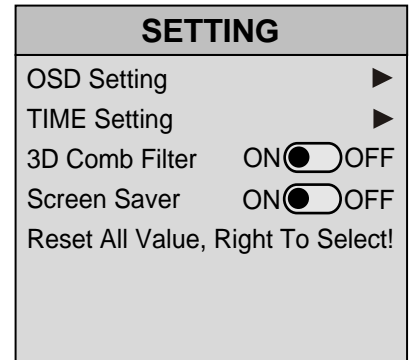

| Item | Descriptions |
|----------------|---|
| OSD Setting | Refer to chapter [Setting On-Screen Display]. |
| TIME setting | Refer to chapter [Setting Time]. |
| 3D Comb Filter | Press ◀/▶ to turn on or off 3D Comb Filter. |
| Screen Saver | Press ◀/▶ to turn on or off screen saver. |
| Reset | Press ▶ to reset all value to default. |

Setting On-Screen Display

- From the SETTING submenu page, Press ▲/▼ repeatedly to select OSD Setting item.
- Press ENTER or ▶ to access the sub page.
- Press ▲/▼ to select menu item that you would like to adjust.

| Item | Descriptions |
|--------------|---|
| OSD Language | Press ◀/▶ to select a proper OSD language. |
| OSD Skin | Press ◀/▶ to select Main or Sub, which means you would like to adjust the skin of the main menu or submenu. Press ENTER to access sub page. |
| OSD Trans. | Press ◀/▶ to adjust the OSD transparency. |
| OSD Timeout | Press ◀/▶ to set the time that how long the OSD displays on the screen without any operation. |

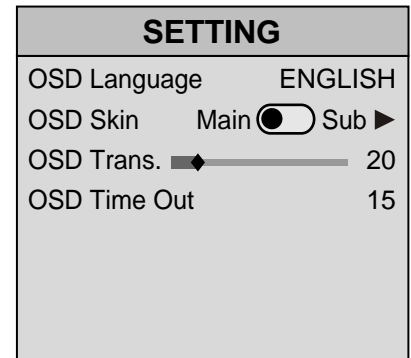

Setting Menu Skin

- From the OSD SETTING sub page, Press ▲/▼ repeatedly to select OSD Skin item.
- Press ENTER to access the sub page to set menu skin.
- Press ▲/▼ repeatedly to select item.
- Press ◀/▶ to adjust the item's value or press ENTER to confirm your operation.

Setting System

Setting Time

- Press MENU to display the menu main page.
 - Press ▲/▼ repeatedly to select SETTING item.
 - Press ENTER or ◀/▶ to access the submenu.
 - Press ▲/▼ to select TIME Setting item.
 - Press ENTER or ▶ to access the time setting sub page.
- Press ▲/▼ to select item to adjust.

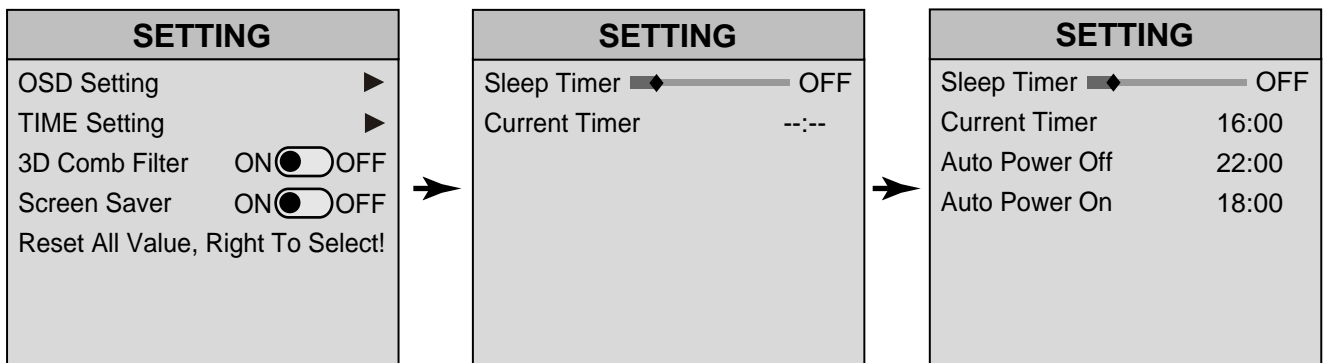

| Item | Descriptions |
|----------------|--|
| Sleep Timer | Press ◀/▶ to set sleep timer. You may also use SLEEP button to quickly set sleep timer. |
| Current Timer | Press ◀/▶ to move the cursor, use 0-9 buttons to input time. |
| Auto Power Off | This item cannot be accessed until you finish setting current timer. Press ◀/▶ to move the cursor, use 0-9 buttons to input time. If you would like to cancel this function after setting, press ▶ repeatedly until OFF appears. |
| Auto Power On | This item cannot be accessed until you finish setting current timer. Press ◀/▶ to move the cursor, use 0-9 buttons to input time. If you would like to cancel this function after setting, press ▶ repeatedly until OFF appears. |

Note:

- If you have set the timer of Auto Power On, once you perform turn-on operation ahead of the preset time, the Auto Power On setting will be cancelled.
- If you have set the timer of Auto Power Off, once you perform turn-off operation ahead of the preset time, the Auto Power Off setting or sleep timer setting will be cancelled.
- Once the Auto Power On, Auto Power Off or sleep timer function is executed, these functions need to be reset again if you would like to use these functions.

Setting Window

Setting Window

- Press MENU to display the menu main page.
- Press ▲/▼ repeatedly to select WINDOW item.
- Press ENTER or ◀/▶ to access the submenu.
- Press ▲/▼ to select menu item that you would like to adjust.
- Press ◀/▶ to adjust the value of the selected item.

As an example, the right illustration is the WINDOW menu page in TV mode.

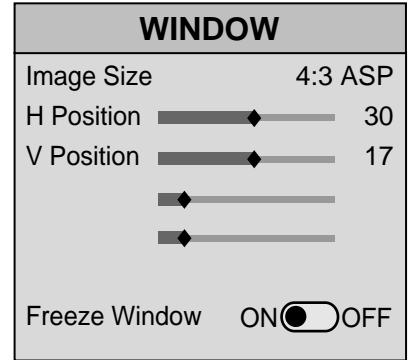

| Item | Descriptions | Notes |
|---------------|--|---|
| Image Size | Press ◀/▶ to select a proper image size. | <ul style="list-style-type: none"> ■ Some items display in grey and you will find that they cannot be selected. In this case, these items are unnecessary to adjust. |
| H Position | Press ◀/▶ to adjust horizontal position for current image. | |
| V Position | Press ◀/▶ to adjust vertical position for current image. | |
| H Width | Press ◀/▶ to adjust horizontal width for current image. | |
| V Width | Press ◀/▶ to adjust vertical width for current image. | <ul style="list-style-type: none"> ■ You may also use the ADJUST button to quickly perform auto-adjustment. |
| Auto Adjust | With working in component input mode or VGA mode, if the image displays abnormally, press ▶ perform auto-adjustment. The unit automatically adjusts phase, clock or position, etc. | <ul style="list-style-type: none"> ■ You may also use the FREEZE button to quickly freeze current image |
| Freeze Window | Press ◀/▶ to select On or Off to freeze current image or cancel freezing function. | |

☑ Important Cautions:

1. For the sake of protecting the screen, please DO NOT freeze an image for a long time.
2. To avoid the brightness dissonance between the screen centre and the screen edges, please do not use 4:3 mode for a long time.
3. If you are watching programs from DVD or VCR equipment, when the program has been finished, some player device may display its logo on the screen. Displaying this kind of static logo may damage the screen, please turn off the player equipment in time.

Troubleshooting

Before calling for repair service, check the following items for possible remedies to an encountered symptom.

| Symptoms | Check item |
|---|---|
| "Ghost" or double images | <ul style="list-style-type: none"> ■ This may be caused by obstruction to the antenna due to high rise buildings or hills. Using a highly directional antenna may improve the picture. |
| No power | <ul style="list-style-type: none"> ■ Check that the AC power cord is plugged into the mains socket. ■ Unplug the power cord, wait for 60 seconds. Then reinsert plug into the mains socket and turn on the unit again. |
| No picture | <ul style="list-style-type: none"> ■ Check antenna connections at the rear of the unit to see if it is properly connected to the unit. ■ Possible broadcast station trouble. Try another channel. ■ Adjust the contrast and brightness settings. ■ Select a correct input. ■ Is a non-compatible signal being input? |
| Good picture but no sound | <ul style="list-style-type: none"> ■ Increase the VOLUME. ■ Check that the unit is not muted. |
| Good sound but poor colour | <ul style="list-style-type: none"> ■ Adjust the contrast, colour and brightness settings. |
| Poor picture | <ul style="list-style-type: none"> ■ Sometimes, poor picture quality occurs when having activated an S-VHS camera or camcorder connected and having connected another peripheral at the same time. In this case, switch off one of the other peripherals. ■ Check whether the room is too bright. |
| Horizontal dotted line | <ul style="list-style-type: none"> ■ This may be caused by electrical interference (e.g. hair dryer, nearby neon lights, etc.) ■ Turn off the equipment. |
| Television not responding to remote control | <ul style="list-style-type: none"> ■ Check whether the batteries are working. Replace if necessary. ■ Clean the remote control sensor lens on the unit. ■ Do not use the remote control under strong or fluorescent lighting. ■ The batteries should be inserted with polarity (+, -) aligned. |
| Snowy picture and noise | <ul style="list-style-type: none"> ■ Check the antenna connection. |
| No stable or not synchronised D-Sub picture | <ul style="list-style-type: none"> ■ Check if you have selected the correct D-Sub mode in your PC. |
| No output from one of the speakers | <ul style="list-style-type: none"> ■ Adjust Balance in the SOUND (AUDIO) menu. |
| Control buttons do not work | <ul style="list-style-type: none"> ■ Unplug the power cord, wait for some seconds. Then re-plug the power cord and turn on the unit again. |

Note:

*If your problem is not solved, restart your TV by turning it off and then on again once.
Never attempt to repair a defective TV yourself.*

Care and Maintenance

Do not use in hot or cold rooms (locations)

- When the unit is used in rooms (locations) with low temperature, the picture may leave trails or appear slightly delayed. This is not a malfunction, and the unit will recover when the temperature returns to normal.
- Do not leave the unit in a hot or cold location. Also, do not leave the unit in a location exposed to direct sunlight or near a heater, as this may cause the cabinet to deform and the PDP panel to malfunction.
(Storage temperature: 0°C to +50°C Working temperature: 5°C to +40°C)

PDP Display Panel

| Symptoms | Check item |
|---|---|
| Some parts of the screen do not light up. | The plasma display panel is manufactured using an extremely high level of precision technology, however, sometimes some parts of the screen may be missing picture elements or have luminous spots. This is not a malfunction. |
| After-images appear | Do not allow a still picture to be displayed for an extended period, as this can cause a permanent after-image to remain on the Plasma Display. Examples of still pictures include logos, video games, computer images, teletext and images displayed in 4:3 mode. Note: The permanent after-image on the Plasma Display resulting from fixed image use is not an operating defect. This product is not designed to display fixed images for extended periods of time. |
| Snapping sounds may be heard from the display unit. | This sound is produced when the cabinet expands or contracts due to variations in temperature and is not a malfunction. |

Cleaning and Maintenance

The front of the display panel has been specially treated. Wipe the panel surface gently using only a cleaning cloth or a soft, lint-free cloth.

- If the surface is particularly dirty, soak a soft, lint-free cloth in a weak detergent solution and then wring the cloth to remove excess liquid. Use this cloth to wipe the surface of the display panel, and then wipe it evenly with a dry cloth, of the same type, until the surface is dry.
- Do not scratch or hit the surface of the panel with fingernails or other hard objects. Furthermore, avoid contact with volatile substances such as insect sprays, solvents and thinner; otherwise the quality of the surface may be adversely affected.

If the cabinet becomes dirty, wipe it with a soft, dry cloth.

- If the cabinet is particularly dirty, soak the cloth in a weak detergent solution and then wring the cloth dry. Use this cloth to wipe the cabinet, and then wipe it dry with a dry cloth.
- Do not allow any detergent to come into direct contact with the surface of the Plasma Display. If water droplets get inside the unit, operating problems may result.
- Avoid contact with volatile substances such as insect sprays, solvents and thinner, otherwise the quality of the cabinet surface may be adversely affected or the coating may peel off. Furthermore, do not leave it for long periods in contact with articles made from rubber or PVC.

Specifications

| | |
|--------------------|-----------------------------|
| Power supply: | AC 100-240V 50/60Hz |
| Power Consumption: | 450W |
| Screen: | 127cm |
| Weight: | 54 kg |
| Dimensions | 1430(W) x 813(H) x 305(D)mm |

TV system & channel coverage:

| System | VHF | UHF | CATV |
|-----------|------|-------|-----------------------|
| PAL-D/K | 1-12 | 13-57 | Z1-Z37 |
| PAL-B/G | 2-12 | 21-69 | X-Z+2, S1-S41 |
| PAL-I | 2-12 | 21-69 | |
| NTSC-M | 2-13 | 14-69 | A-6--A-1, A-W, AA-FFF |
| SECAM-B/G | 2-12 | 21-69 | X--Z+2, S1-S41 |
| SECAM-D/K | 1-12 | 21-69 | |

| | |
|----------------|---|
| Colour system: | PAL/SECAM/NTSC |
| Accessories | Operating manual x 1 Remote control unit x 1 |



- 1. Design and specifications are subject to change without notice.**
- 2. Weight and Dimensions shown are approximate.**
- 3. Specifications and external appearance may be changed for the sake of improvement.**

PALSONIC CORPORATION PTY LTD
1 JOYNTON AVENUE
WATERLOO NSW 2017 AUSTRALIA
TEL: (02) 9313 7111
FAX: (02) 9313 7555
www.palsonic.com.au

**PALSONIC CUSTOMER SERVICE
TELEPHONE
AUSTRALIA: 1300 657 888**

604-PS50T183-00
Ver. 1.0

Free Manuals Download Website

<http://myh66.com>

<http://usermanuals.us>

<http://www.somanuals.com>

<http://www.4manuals.cc>

<http://www.manual-lib.com>

<http://www.404manual.com>

<http://www.luxmanual.com>

<http://aubethermostatmanual.com>

Golf course search by state

<http://golfingnear.com>

Email search by domain

<http://emailbydomain.com>

Auto manuals search

<http://auto.somanuals.com>

TV manuals search

<http://tv.somanuals.com>