

OWNER'S MANUAL

Palsonic

**58CM CORDLESS REMOTE LCD TELEVISION & MONITOR
MODEL: TFTV580**



N111

**PALSONIC CORPORATION PTY LTD
1 JOYNTON AVENUE
WATERLOO NSW 2017 AUSTRALIA
TEL: (02) 9313 7111
FAX: (02) 9313 7555
www.palsonic.com.au**

**PALSONIC CUSTOMER SERVICE
TELEPHONE
AUSTRALIA: 1300 657 888**

Contents

Important Safety Precautions	1
Control Panel and Back Terminals	4
Control Panel	4
Back Terminals	5
Remote Control Unit	6
Installation	8
Antenna Connection	8
Power Connection	8
Connecting External Device	9
Basic Operations	13
Turning On	13
Turning Off	13
Selecting Input Signal	13
Menu Operations	13
Setting OSD (On-Screen Display)	13
Channel Setting	14
Auto Search	14
Manual Search	14
Fine Tuning	14
To Skip Unnecessary Channel	14
Channel Selection	15
Using Keypad Buttons	15
Using CH+/- Buttons	15
Using Previous Channel Button	15
Channel Edit	15
Adjusting Picture and Sound	16
Picture Adjustment	16
Picture Mode	16
Adjusting Volume	16
Muting the Sound	16
Sound Mode	16
Setting Sound Output	17
Adjusting Bass or Treble	17
Adjusting Balance	17
Stereo/Bilingual Selection	17
System Setting	18
Setting Blue Screen	18
Setting Colour System	18
Setting Sound System	18
Setting scaler Mode	18
Setting Sleep Timer	18
Operations In RGB/YPbPr Mode	19
Select RGB/YPbPr Mode	19
PC Signal Format	19
Auto Adjusting	19
Adjusting Brightness/Contrast	19
Setting Colour Temperature	19
Adjusting Phase/Frequency	20
Adjusting Picture Position	20
Troubleshooting	21
Specification	22

Important Safety Precautions

Electrical energy can perform many useful functions, but it can also cause personal injuries and property damage if improperly handled. This product has been engineered and manufactured with the highest priority on safety. But **IMPROPER USE CAN RESULT IN POTENTIAL ELECTRICAL SHOCK OR FIRE HAZARD**. In order to prevent potential danger, please observe the following instructions when installing, operating and cleaning the product. To ensure your safety and prolong the service life of your LCD TV product, please read the following precautions carefully before using the product.

1. Read these instructions --- All operating instructions must be read and understood before the product is operated.
2. Keep these instructions --- These safety and operating instructions must be kept in a safe place for future reference.
3. Head all warnings --- All warnings on the product and in the instructions must be observed closely.
4. Follow all instructions --- All operating instructions must be followed.

5. Do not use this apparatus near water --- for example, near a bathtub, washbowl, kitchen sink, or laundry tub, in a wet basement, or near a swimming pool, and the like. Do not use immediately after moving from a low temperature to high temperature environment, as this causes condensation, which may result in fire, electric shock, or other hazards.

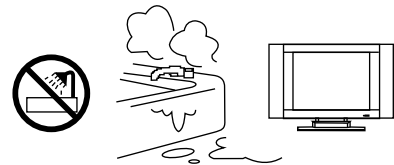

6. Clean only with dry cloth --- Unplug this product from the wall outlet before cleaning. Do not use liquid cleaners or aerosol cleaners. Use a damp cloth for cleaning.

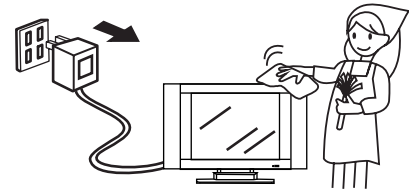

7. Ventilation --- Do not block any ventilation openings. Install in accordance with the manufacturer instructions. The vents and other openings in the cabinet are designed for ventilation. Do not cover or block these vents and openings since insufficient ventilation can cause overheating and/or shorten the life of the product. Do not place the product on a bed, sofa, rug or other similar surface, since they can block ventilation openings. This product is not designed for built-in installation; do not place the product in an enclosed place such as a bookcase or rack, unless proper ventilation is provided or the manufacturer's instructions are followed.

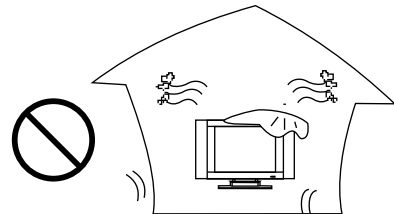

8. Heat sources --- Do not install near any heat sources such as radiators, heat registers, stoves, or other apparatus (including amplifiers) that produce heat.

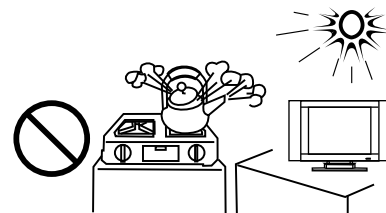

9. Grounding or Polarisation --- Do not defeat the safety purpose of the polarised or grounding-type plug. A polarised plug has two blades with one wider than the other. A grounding type plug has two blades and a third grounding prong. The wide blade or the third prong are provided for your safety. If the provided plug does not fit into your outlet, consult an electrician for replacement of the obsolete outlet. (America only)

10. Power cord protection --- Protect the power cord from being walked on or pinched particularly at plugs, convenience receptacles, and the point where they exit from the apparatus.

11. Attachments --- Only use attachments/accessories specified by the manufacturer. Do not use attachments not recommended by the manufacturer. Use of improper attachments can result in accidents,

Important Safety Precautions

12. Stand --- Use only with the cart, stand, tripod, bracket, or table specified by the manufacturer, or sold with the apparatus. Do not place the product on an unstable trolley, stand, tripod or table. Placing the product on an unstable base can cause the product to fall, resulting in serious personal injuries as well as damage to the product. When mounting the product on a wall, be sure to follow the manufacturer's instructions. Use only the mounting hardware recommended by the manufacturer.

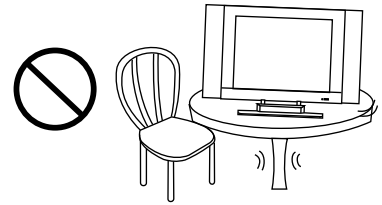

13. Careful move --- When a cart is used, use caution when moving the cart/apparatus combination to avoid injury from tip-over. Sudden stops, excessive force and uneven floor surfaces can cause the product to fall from the trolley.



14. Lightning --- Unplug this apparatus during lightning storms or when unused for long periods of time. For added protection for this television equipment during a lightning storm, or when it is left unattended and unused for long periods of time, unplug it from the wall outlet and disconnect the antenna. This will prevent damage to the equipment due to lightning and power-line surges.

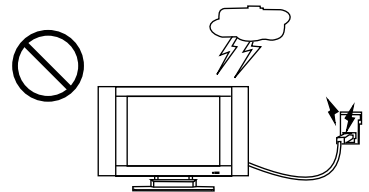

15. Servicing --- Refer all servicing to qualified service personnel. Servicing is required when the apparatus has been damaged in anyway, such as power-supply cord or plug is damaged, liquid has been spilled or objects have fallen into the apparatus, the apparatus has been exposed to rain or moisture, does not operate normally, or has been dropped.

16. Replacement parts --- In case the product needs replacement parts, make sure that the service person uses replacement parts specified by the manufacturer, or those with the same characteristics and performance as the original parts. Use of unauthorised parts can result in fire, electric shock and/or other danger.

17. Overloading --- Do not overload wall outlets, extension cords, or convenience receptacles on other equipment as this can result in a risk of fire or electric shock.

18. Entering of objects and liquids --- Never insert an object into the product through vents or openings. High voltage flows in the product, and inserting an object can cause electric shock and/or short internal parts. For the same reason, do not spill water or liquid on the product.

19. Damage requiring service --- If any of the following conditions occurs, unplug the power cord from the AC outlet, and request a qualified service person to perform repairs.

- When the power cord or plug is damaged.
- When a liquid is spilled on the product or when objects have fallen into the product.
- When the product has been exposed to rain or water.
- When the product does not operate properly as described in the operating instructions. Do not touch the controls other than those described in the operating instructions. Improper adjustment of controls not described in the instructions can cause damage, which often requires extensive adjustment work by a qualified technician.
- If the product has been dropped or the cabinet has been damaged in anyway.
- When the product displays an abnormal condition or exhibits a distinct change in performance. Any noticeable abnormality in the product indicates that the product needs servicing.

20. Safety checks --- Upon completion of service or repair work, request the service technician to perform safety checks to ensure that the product is in proper operating condition.

21. Wall or ceiling mounting --- When mounting the product on a wall or ceiling, be sure to install the product according to the method recommended by the manufacturer. This is a safety feature.

Important Safety Precautions

22. Power source --- This product is intended to be supplied by a listed power supply indicated on the marking label. If you are not sure of the type of power supply to your home, consult your product dealer or local power company. For added protection for this product during a lightning storm, or when it is left unattended and unused for long periods of time, unplug it from the wall outlet and disconnect the cable system. This will prevent damage to the product due to lightning and power line surges. When the unit has to be used with another power supply voltage, the power cable must be changed. Consult your product dealer. The socket outlet should be installed near the equipment and easily accessible. Use only the power cord designated by our dealer to ensure safety and EMC. When connecting other products such as VCRs and personal computers, you should turn off the power of the unit for protection against electric shock.

23. Panel protection --- The LCD panel used in this product is made of glass. Therefore, it can break when the product is dropped or impacted upon by other objects. Be careful not to be injured by broken glass pieces in case the LCD panel breaks.

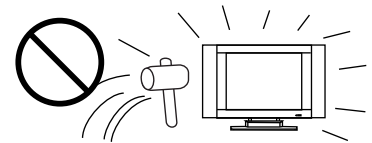

24. Pixel defect --- The LCD panel is a very high technology product, giving you finely detailed pictures. Occasionally, a few non-active pixels may appear on the screen as a fixed point of blue, green or red. Please note that this does not affect the performance of your product.

- If an outside antenna is connected to the television equipment, be sure the antenna system is grounded so as to provide some protection against voltage surges and built-up static charges.
- An outside antenna system should not be located in the vicinity of overhead power lines or other electric light or power circuits, or where it can collide with such power lines or circuits. When installing an outside antenna system, extreme care should be taken to keep from touching such power lines or circuits, as contact with them might be fatal.

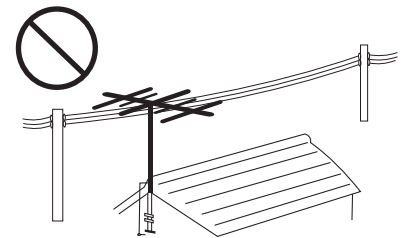

Control Panel and Back Terminals

Control Panel

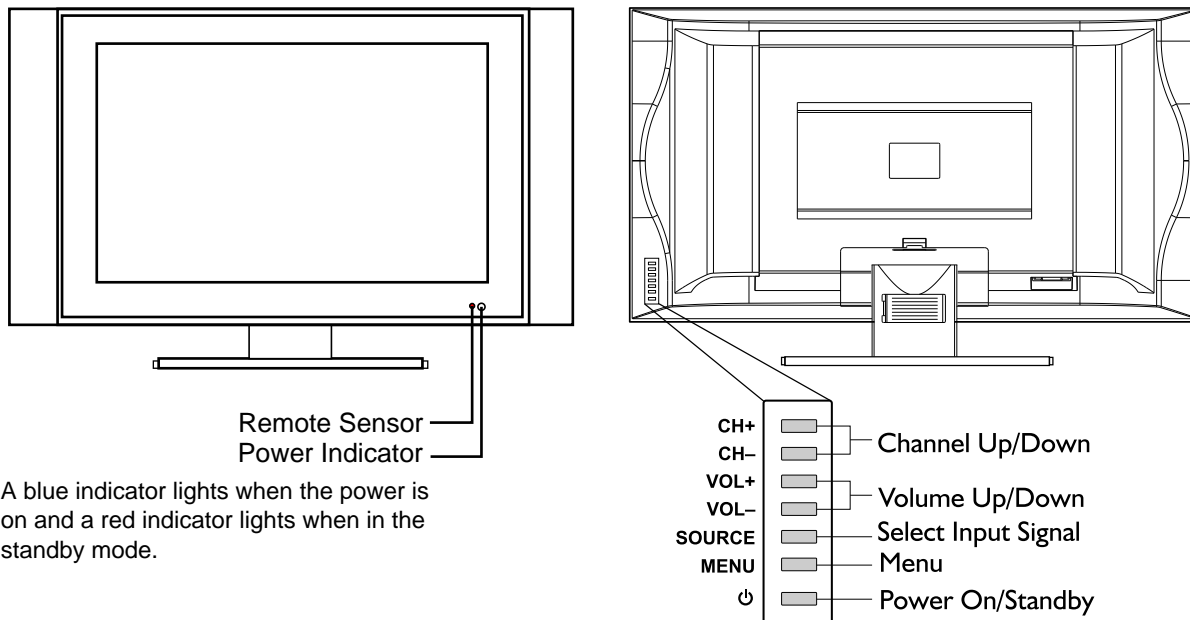

A blue indicator lights when the power is on and a red indicator lights when in the standby mode.

1. POWER ⏻

Press this button to turn the unit ON from STANDBY mode. Press it again to turn the set back to STANDBY

2. MENU

Press this button to access the Menu main page

3. SOURCE

To access signal source select menu

4. VOL+/-

Press the **VOL+** or **VOL-** button to directly increase or decrease the sound volume level;
In OSD Menu, press these buttons to adjust the value or setting of each item

5. CH+/-

Press these two buttons to directly change the TV channel;
In OSD Menu, press these buttons to choose the OSD items

Note:

*Functions of **VOL+/-**, **CH+/-**, **MENU**, **SOURCE** and **POWER** ⏻ are also provided to the remote control. This operation manual provides a description based on operating functions with the remote control.*

Control Panel and Back Terminals

Back Terminals

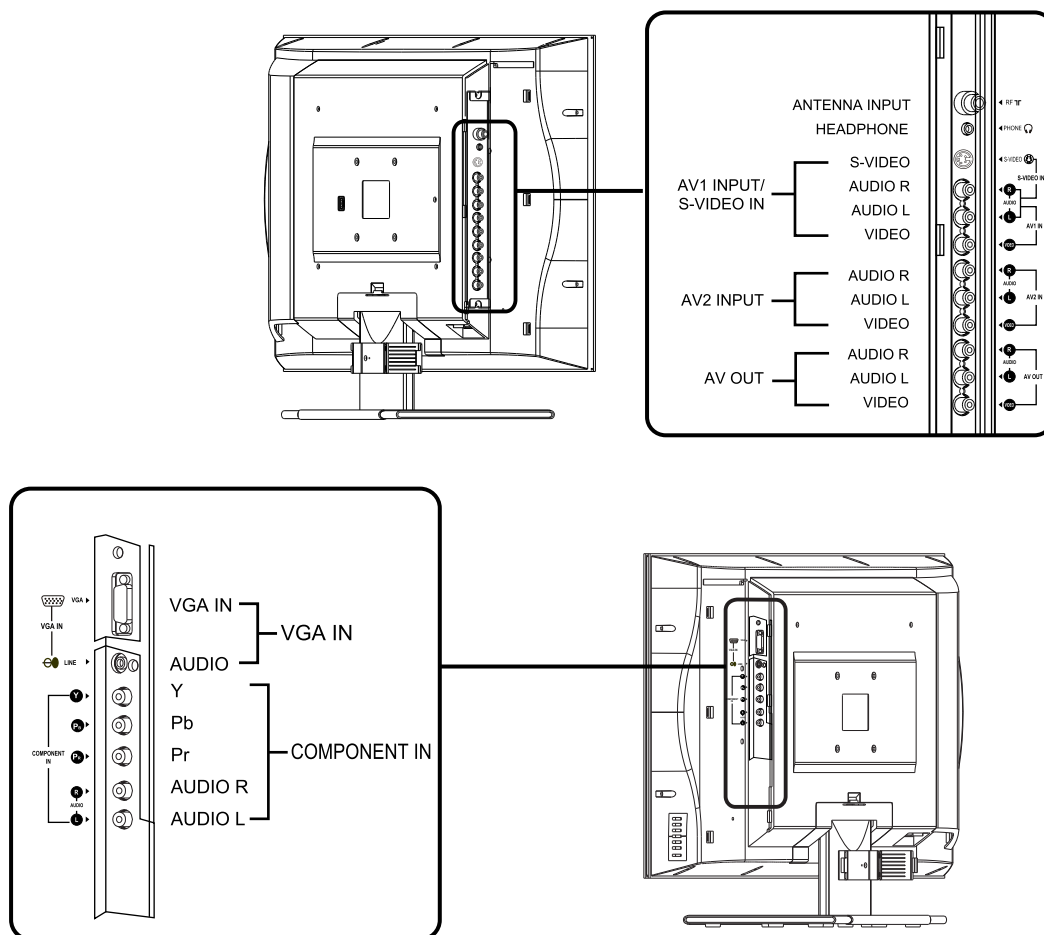

1. Antenna input

Allows you to connect cable or outdoor antenna

2. Headphone jack

3. AV1 inputs (Video, Audio L, R) / S-Video input

Receive video/audio signals from external sources such as VCR or DVD player.

Receive a S-Video signal from external source such as VCR or DVD player.

4. AV2 inputs (Video, Audio L, R)

Receive video/audio signals from external sources such as VCR or DVD player.

5. AV outputs (Video, Audio L, R)

Connect to the VCR input jacks to record programs.

6. VGA input/Audio line in

Connect to the VGA/Audio output jacks on your PC equipment

7. COMPONENT inputs (Y, Pb, Pr, Audio L, R)

Connect to the audio and component output jacks of a DVD player or Set-Top Box.

Remote Control Unit

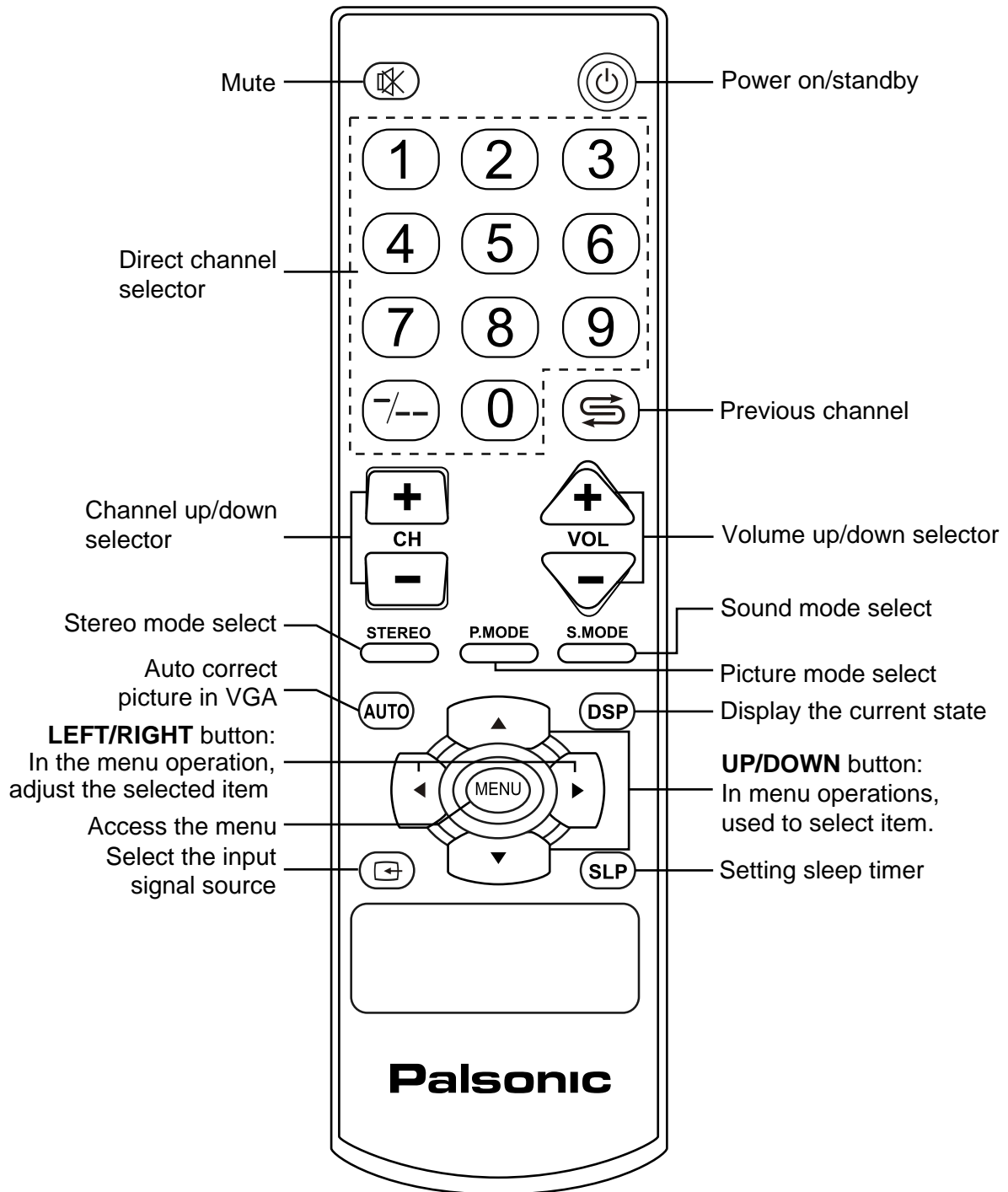

Remote Control Unit

Batteries for the Remote Control

If the remote control fails to operate the LCD TV functions, replace the batteries in the remote control.

- 1 Open the battery cover.
- 2 Insert two size-AAA batteries.
(Place the batteries with their terminals corresponding to the (+) and (-) indications in the battery compartment.)
- 3 Replace the cover.

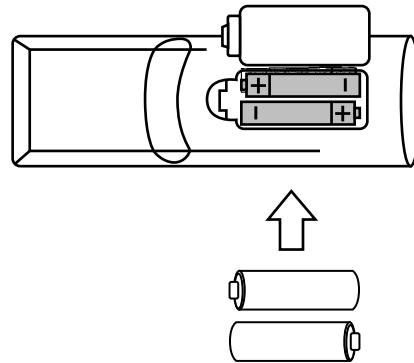

Effective range of the remote control

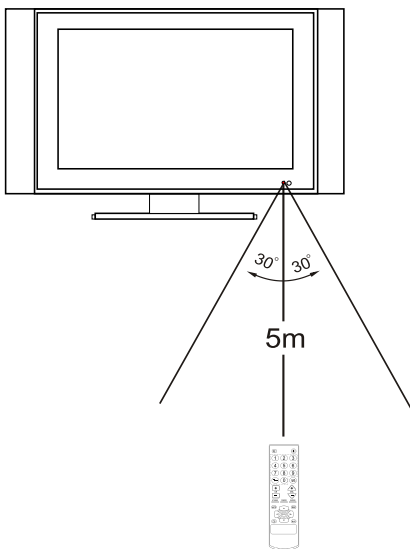

! Notes:

1. When the remote control will not be used for a long period of time or when the batteries are worn out, remove the batteries.
2. Do not drop or dampen the remote control.
3. Do not disassemble the remote control.
4. There should be no obstacle between the TV and the transmitter.
5. Use the remote control within the effective range as shown in the figure on the left.
6. If the remote control does not work, please check whether the batteries are exhausted or if they have been installed properly.
7. When direct sunlight, and incandescent lighting, fluorescent lamp or any other strong light shines on the remote sensor of the TV, the remote operation can be come erratic.
8. Do not mix different types of batteries in the remote.

Installation

Antenna Connection

Optimum reception of colour requires a good signal and will generally mean that an outdoor aerial must be used. The exact type and position of the aerial will depend upon your particular area.

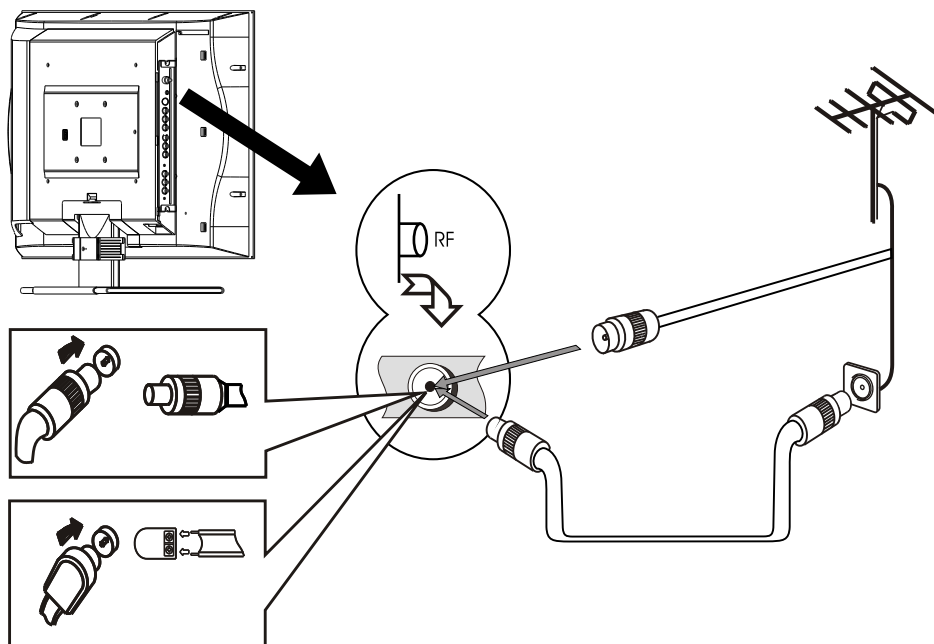

Note:

It is recommended that the 75-ohm coaxial cable be used to eliminate interference and noise which may occur due to radio wave conditions.

The aerial cable should not be bundled with the power cord and the like.

Power connection

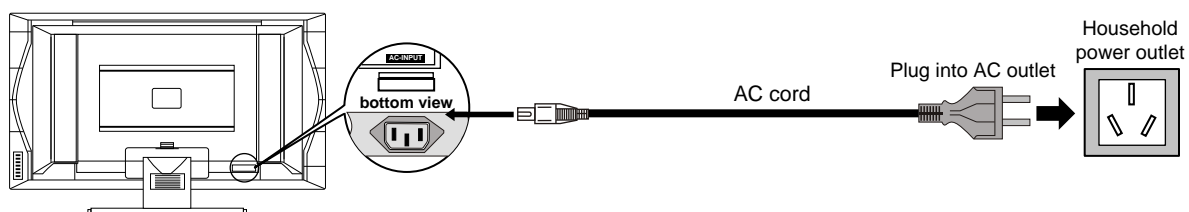

1. Connecting the female plug to the AC socket on the unit.
2. Connecting the male plug to the wall outlet as illustrated.

Note:

- *This illustration is for reference only. The AC plug may be different on different models.*
- *This product should be operated only from the type of power source indicated on the marking label.*
- *Always unplug the AC cord from power outlet when not using for a long period of time.*

Installation

Connecting External Device

► Notes about connection

1. Carefully check the terminals for position and type before making any connections.
2. Loose connectors will result in image or colour problems. Make sure that all connectors are securely inserted into their terminals.
3. When connecting an external device, turn off the power of the main unit first to prevent any possible damage.
4. Please refer to the instruction manual of the equipment to be connected as well.

► Composite Video signal connection

Connect the composite video signal terminal on the TV to the output of AV equipment through composite cable.

If you select the video signal, please set the input signal source of LCD-TV to **AV1/AV2** mode.

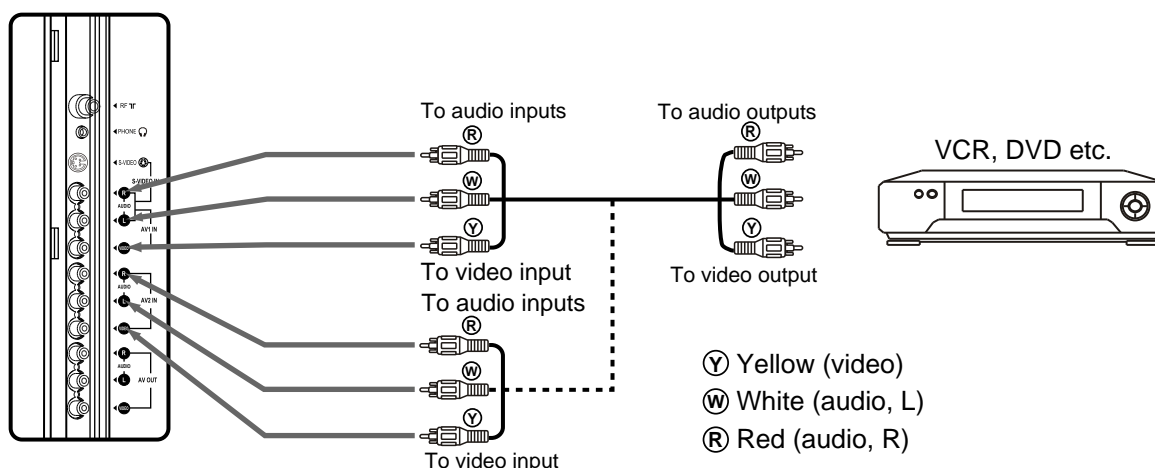

! Note:

Composite video signal is the most common signal, but the picture quality is not very good.

► S-VIDEO Signal Connection

Connect the S-video terminal on the TV to the output of AV equipment through S-video cable.

If you select S-video signal, please set the input signal source of LCD-TV to **SVIDEO** mode.

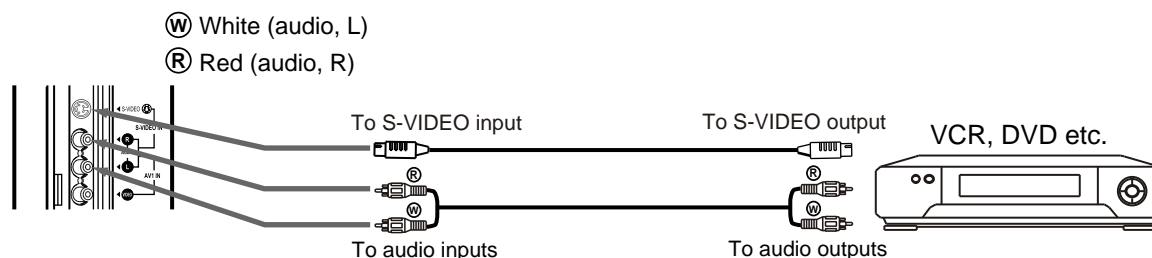

! Note:

S-Video is a signal format which transfers the colour and bright of the picture respectively. The picture quality is better than composite signal.

Installation

► The PC input signal connection

Connect the VGA (D-Sub) signal terminal on the TV to the output of PC equipment through Min D-sub 15 pin cable as illustrated. Connect a cable, which matches the audio output terminal on the computer. If you select PC signal, please set the input signal source of LCD-TV to **RGB** mode.

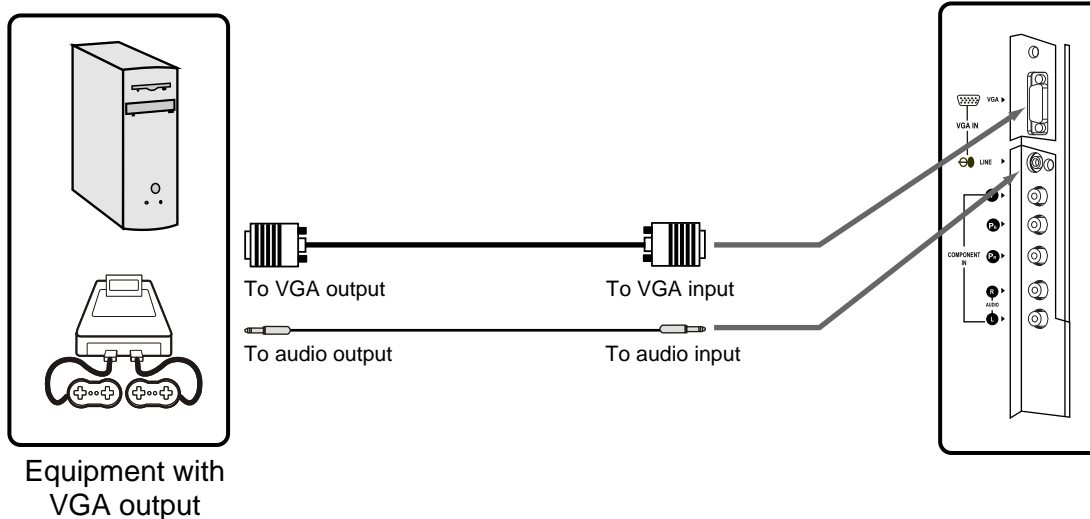

! Notes:

1. The native display resolution is 1280 768. If the signal resolution exceed the native resolution, it may not be possible to show fine detail with sufficient clarity.
2. We strongly recommend that you set the vertical scanning frequency for PC signals to 60Hz. If you set it above 60Hz the unit may not display correctly.

Installation

► AV OUT connection

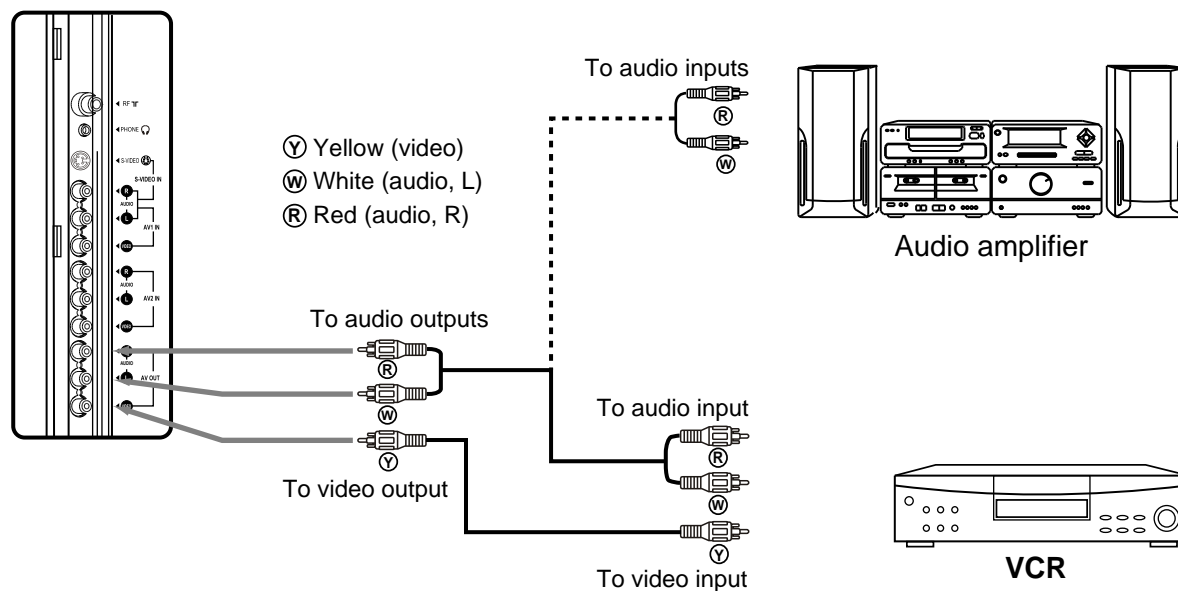

How to connect:

Connect the video/audio output terminals on the TV set to the signal input terminals of the VCR equipment or the video/audio input terminals on other TV set through video/audio cable.

Connect the audio output terminals on the TV set to the Audio amplifier through audio cable.

How to record the TV program:

1. Turn on the LCD TV and select program.
2. Turn on the VCR and insert the tape.
3. Press the RECORD button to begin recording.

How to enjoy high quality sound by Audio amplifier:

1. Turn the volume of the Audio amplifier to minimum.
2. Turn on the LCD TV and select program.
3. Turn on the power amplifier and adjust the volume as favourite.

Installation

► YPbPr/YCbCr input connection

If the signal/source is the equipment with YPbPr/YCbCr output terminals, we recommend you to use the YPbPr/YCbCr terminals on the equipment. Please connect it with the YPbPr/YCbCr input terminals on the TV set for better picture quality. And connect the audio outputs of it with the corresponding audio input terminals on the TV set.

If you select YPbPr/YCbCr signal, please set the input signal source of the LCD-TV to **YPbPr** mode.

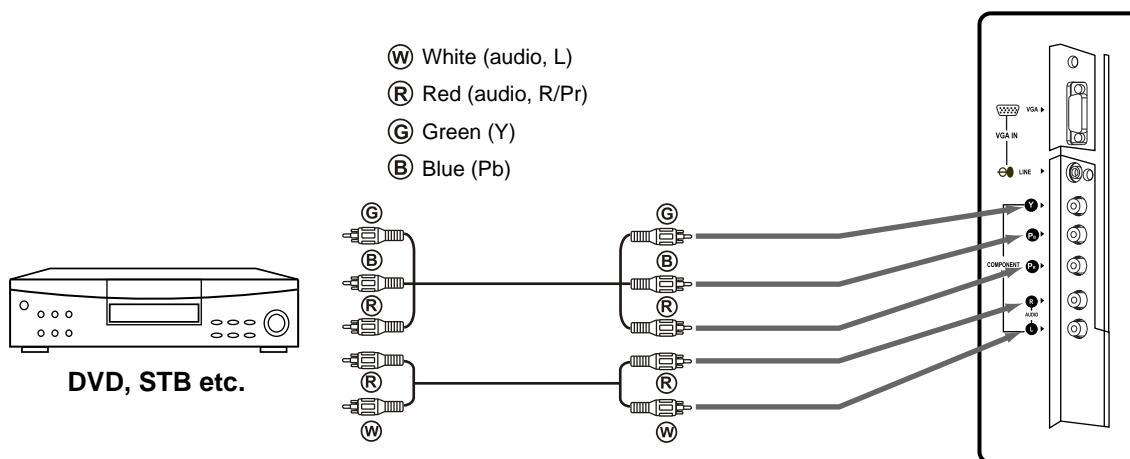

Basic Operations

Turning On

- 1 Connect the Power correctly.
- 2 The indicator lights up, the unit is in STANDBY mode.
- 3 Press the **POWER** (⏻) button on the remote control or on the unit to turn on the TV set.

Turning Off

- 1 With the power on, press the **POWER** (⏻) button to turn off the TV and the TV is in STANDBY mode.
- 2 If you want to turn off the power completely, unplug the power cord from the wall outlet.



Notes:

The unit automatically goes to STANDBY mode by:

- A. Without input signal for about 15 minutes (the **Blue Screen** should be set to **On** in advance)
- B. Sleep timer function (needs to be set in advance).

Selecting Input Signal

- 1 Press the **SOURCE** button on the unit or  button on the remote control. The screen displays the menu as shown on the right.
- 2 Press **UP/DOWN** to highlight your desired input signal source. Press **LEFT/RIGHT** or wait for about 4 seconds and the desired signal source will be selected.

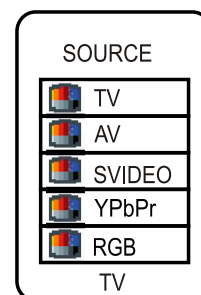

Menu Operations

- ▶ Press **MENU** to display menu page.
- ▶ Press **LEFT/RIGHT** to select menu page.
- ▶ Press **DOWN** to access sub-menu.
- ▶ Press **UP/DOWN** to select menu item.
- ▶ Press **LEFT/RIGHT** to adjust the selected item.



Setting OSD (On-Screen Display)

From the OSD menu page, you may set OSD language, OSD position, OSD background and OSD timeout.

- 1 Setting OSD language: From the OSD menu page, press **UP/DOWN** to select **language** item. Press **LEFT/RIGHT** to select a desired OSD language.
- 2 Setting OSD position: From the OSD menu page, press **UP/DOWN** to select **OSD position** item. Press **LEFT/RIGHT** to select a desired OSD position.
- 3 Setting OSD background: From the OSD menu page, press **UP/DOWN** to select **OSD background** item. Press **LEFT/RIGHT** to select **opaque** or **translucent**.
- 4 Setting OSD timeout: From the OSD menu page, press **UP/DOWN** to select **OSD timeout** item. Press **LEFT/RIGHT** to toggle between 5, 10, 15, ..., 55, 60 seconds.

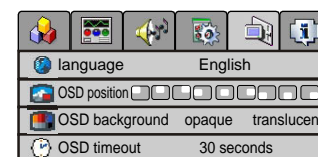

Note:

To clearly introduce the menu operations, this operating manual provides a description based on operation with the remote control.

Channel Setting

There are two ways to preset channels: to preset channels automatically and to preset channels manually. Below we will describe how to preset the channels by making use of the menu.

Auto Search

- 1 Access **Channel Setting** menu.
- 2 Press **UP/DOWN** button repeatedly to highlight **auto search** item.
- 3 Press **LEFT/RIGHT** to start Auto Search.
All active channels will be preset and stored into the memory automatically.
During the process of **Auto Search**, pressing **MENU** will stop the process.

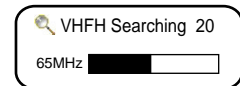
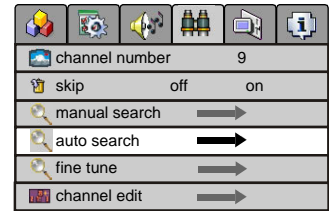

Manual Search

If Auto Search can not preset the desired channels, or you want to preset the desired channels one by one with the preferred channel numbers, please make use of Manual Search.

- 1 Use channel select buttons to select a channel number.
- 2 Access **Channel Setting** menu.
- 3 Press **UP/DOWN** button repeatedly to highlight **manual search** item and press **RIGHT** to enter.
- 4 Press **LEFT/RIGHT** button to perform the searching.
When a channel is located, the searching stops, this channel is then memorised with the preset channel number.

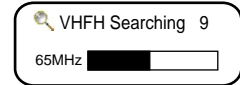
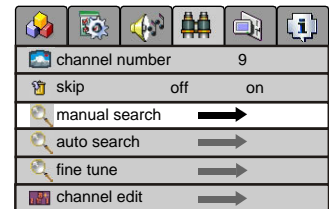

Fine Tuning

Fine tuning is not necessary under normal conditions. However, in area of inferior broadcast conditions where adjustment is necessary for a better picture and sound, use Fine tuning.

- 1 Access the **Channel Setting** menu.
- 2 Press **UP/DOWN** button repeatedly to highlight **fine tune** item.
- 3 Press **LEFT/RIGHT** to fine tune to achieve best picture and sound.

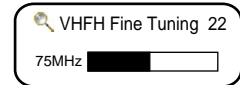
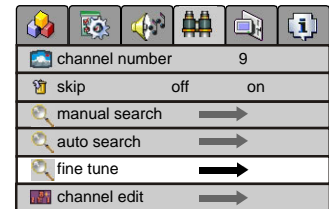

To Skip Unnecessary Channel

After presetting the channels, you can skip unnecessary channels so that only the channels you want to watch are selected when you press the **CH+/-** to change channels.

- 1 Select the channel number which you want to skip using the keypad.
- 2 Access the **Channel Setting** menu.
- 3 Press **UP/DOWN** to select **skip** item.
- 4 Press **LEFT/RIGHT** to select on.

Now when you press **CH+/-** to change channels, this channel will be skipped.

If you want to resume a skipped channel, use the keypad buttons to enter the channel, then access the **Channel Setting** menu and select **skip**, press **LEFT/RIGHT** to set **skip off**. When you press **CH+/-** to change channels, the channel will be present.

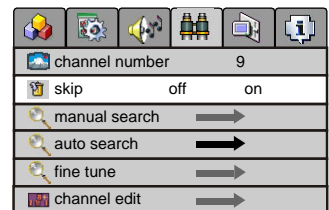

Channel Selection

Using Keypad Buttons

- 1 To select one-digit channel numbers:**
Input the channel using the **0-9 number button**, then wait for about 2 seconds.
- 2 To select two-digit channel numbers:**
Press **-/--** button to display **--**, then input the channel using the **0-9 number button**.
- 3 To select three-digit channel numbers:**
Press **-/--** button to display **---**, then input the channel using the **0-9 number button**.
Note: The period between presses should be within 2 seconds.

Using CH+/- Buttons

- 1** Press **CH+** button, the channel number increases;
- 2** Press **CH-** button, the channel number decreases.
Note: When you press **CH+** or **CH-**, the unit cycles among those channels which are memorised during **auto search**.

Using Previous Channel Button

Press  button to switch between the current channel and previous channel.

Channel Edit

You can edit the channel programs in your favourite order.

- 1** Access the **Channel Setting** menu.
- 2** Press **UP/DOWN** to select **channel edit**. Press **RIGHT** to enter into the sub-menu.
- 3** Press **UP/DOWN** to select **current channel**, press **LEFT/RIGHT** to select a current channel number.
- 4** Press **DOWN** to select **exchange to**, press **LEFT/RIGHT** to select a target channel number.
- 5** Press **DOWN** to select **exchange channel**, press **LEFT/RIGHT** then these two channels' contents are exchanged.

Repeat the above steps to edit the programs in your favourite order.

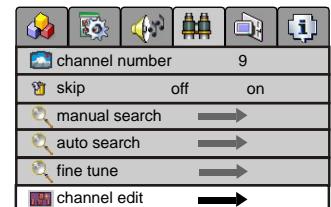

Adjusting Picture and Sound

Picture Adjustment

- 1 Access **Picture Setting** menu by pressing **MENU** button.
- 2 Press **UP/DOWN** to select the item that you want to adjust.
- 3 Press **LEFT/RIGHT** to adjust selected item.



Item	Function	Range
brightness	To adjust picture's brightness	0-100
contrast	To adjust picture's contrast	0-100
color	To adjust picture's colour	0-32
sharpness	To adjust pictures sharpness	0-63
Tint*	To adjust picture's tint	-32-+31

Note: Tint is only for NTSC system.

Picture Mode

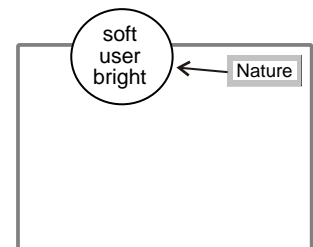

You can select picture mode by **P.MODE** button.
There are four picture modes: **bright**, **nature**, **soft** and **user**.



Adjusting Volume

Press **VOL+/-** to adjust volume. Press **VOL+** button, the volume increases. Press **VOL-** button, the volume decreases.

Muting the Sound

You can press the  button on the remote control to mute the sound.
Press the  button again to restore. You can also press **VOL+** to restore the sound.

Sound Mode

You can select sound mode by **S.MODE** button.
There are four sound modes: **movie**, **music**, **news** and **user**.

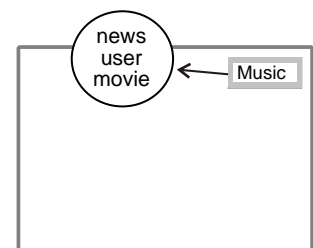

Adjusting Picture and Sound

Setting Sound Output

- 1 Access **Audio Setting** menu.
- 2 Press **UP/DOWN** to select **sound output** item.
- 3 Press **LEFT/RIGHT** to select **speaker**, **earphone** or **speaker + earphone**.

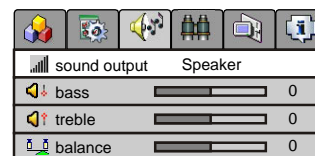

Adjusting Bass or Treble

- 1 Access **Audio Setting** menu.
- 2 Press **UP/DOWN** to select **bass** or **treble** item.
- 3 Press **LEFT/RIGHT** to adjust.

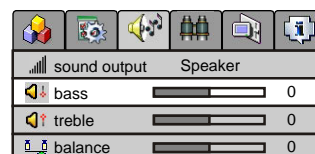

Adjusting Balance

- 1 Access **Audio Setting** menu.
- 2 Press **UP/DOWN** to select **balance** item.
- 3 Press **LEFT/RIGHT** to adjust balance.

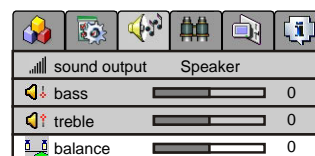

Stereo/Bilingual Selection

You can quickly select sound multiplex mode by using the **STEREO** button on the remote control.

• NICAM Broadcast Selection

This enables the selection of the reception mode when receiving a NICAM signal. To let you enjoy NICAM broadcasting, this TV set receives NICAM system stereo, bilingual, and monaural broadcasts.

Stereo

When the TV set is receiving a stereo broadcast, press the **STEREO** button to select **NICAM STEREO** or **MONO**. When **MONO** is selected, the TV sound is output monaurally.

Bilingual

When the TV set is receiving a bilingual program, press the **STEREO** button to select **NICAM A**, **NICAM B** or **MONO**.

• IGR (German stereo system) Broadcasts

This enables the selection of the reception mode when receiving an IGR signal. To let you enjoy IGR broadcasting, this TV set receives IGR system stereo and bilingual broadcasts.

Stereo

When the TV set is receiving a stereo broadcast, press the **STEREO** button to select **FM STEREO** or **MONO**. When **MONO** is selected, the TV sound is output monaurally.

Bilingual

When the TV set is receiving bilingual program, press the **STEREO** button to select **FM A** or **FM B** or **MONO**.

System Setting

Setting Blue Screen

- 1 Access **System Setting** menu.
- 2 Press **UP/DOWN** to select **blue screen** item.
- 3 Press **LEFT/RIGHT** to select **on** or **off**.
If you set this item to on, the unit displays a blue screen when there is no input signal.

Note:

Only when the Blue Screen is On, the set will turn off automatically after 15 minutes if there is no input signal (in TV or AV mode).

blue screen	on	off			
scaler mode	fill all				
color sys.	Auto				
sound sys.	B/G				
sleep time	10 minutes				

Setting Color System

- 1 Access **System Setting** menu.
- 2 Press **UP/DOWN** to select **color sys.** item.
- 3 Press **LEFT/RIGHT** to select a proper colour system. Normally, please set the color system to auto.

blue screen	on	off			
scaler mode	fill all				
color sys.	Auto				
sound sys.	B/G				
sleep time	10 minutes				

Setting Sound System

- 1 Access **System Setting** menu.
- 2 Press **UP/DOWN** to select **sound sys.** item.
- 3 Press **LEFT/RIGHT** to select a proper sound system.

blue screen	on	off			
scaler mode	fill all				
color sys.	Auto				
sound sys.	B/G				
sleep time	10 minutes				

Setting scaler mode

- 1 Access **System Setting** menu.
- 2 Press **UP/DOWN** to select **scaler mode** item.
- 3 Press **LEFT/RIGHT** to select **fill all** or **16:9** aspect ratio.

blue screen	on	off			
scaler mode	fill all				
color sys.	Auto				
sound sys.	B/G				
sleep time	10 minutes				

Setting Sleep Timer

- 1 Access **System Setting** menu.
- 2 Press **UP/DOWN** to select **sleep time** item.
- 3 Press **LEFT/RIGHT** to adjust the sleep time.

You may quickly select a sleep time by using the **SLP** button on the remote control. When the presetting time is elapsed, the set will auto turn off and be in standby mode.

blue screen	on	off			
scaler mode	fill all				
color sys.	Auto				
sound sys.	B/G				
sleep time	10 minutes				

Operations In RGB/YPbPr Mode

Select RGB/YPbPr mode

- 1 Press the **SOURCE** button on the unit or  button on the remote control. The screen displays the menu shown as right.
- 2 Press **UP/DOWN** to highlight the **RGB** or **YPbPr** item. Press **LEFT/RIGHT** or wait about 4 seconds and the signal source is selected.

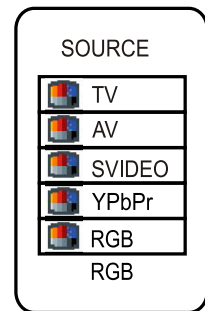

PC Signal Format

Connect VGA input and be sure that there is VGA input signal. Adjust the resolution on your PC to obtain a proper picture.

Note:

The resolution of the LCD panel is 1280 x 768; any higher Resolution output from your PC Video card might distort the image.

Auto Adjusting

When VGA signal format is changed or when you switch to RGB mode from another source, the unit adjusts frequency and phase automatically to obtain the best display. During the process of auto correction, the screen displays **Analog RGB Acquiring Signal**, and all buttons on the set and on the remote control do not work until this process is finished.

When the set displays some nonstandard VGA signals and can not adjust the picture to the best status by itself, you can adjust it again by pressing the **AUTO** button on the remote control.

Adjusting Brightness/Contrast

- 1 Access the **Picture Setting** menu.
- 2 Press **UP/DOWN** to select **brightness** or **contrast** item.
- 3 Press **LEFT/RIGHT** to adjust the selected item.

Item	Function	Notes
brightness	Adjust the brightness of the picture.	Adjusting the picture under RGB mode, will not affect the display settings in the TV & AV mode
contrast	Adjust the contrast of the picture.	

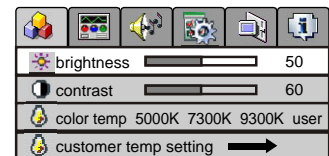

Setting Color Temperature

- 1 Access the **Picture Setting** menu.
- 2 Press **UP/DOWN** to select **color temp** item.
- 3 Press **LEFT/RIGHT** to switch the color temperature between 5000K, 7300K, 9300K and User.
- 4 If you want to change the value of the user mode, set **color temp** to **user** first, then select **customer temp setting** item, and press **LEFT/RIGHT** to access the sub-menu.
- 5 Press **UP/DOWN** to select the item and press **LEFT/RIGHT** to adjust it. The value you set will be stored.

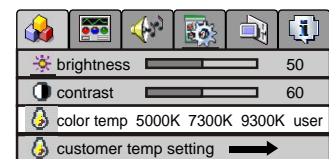

Operations In RGB/YPbPr Mode

Adjusting Phase/Frequency

- 1 Access the **Picture Position** menu.
- 2 Press **UP/DOWN** to select **phase** or **frequency** item.
- 3 Press **LEFT/RIGHT** to adjust the selected item.

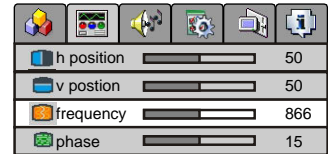

h position	50
v position	50
frequency	866
phase	15

You may find that images blur, depending on the clock phase of your PC's Processor. If you experience blurring, you can obtain a clearer image by adjusting the phase item. Adjust the clock frequency of the set's internal clock signal. If shimmering or rainbow-like noise is apparent in the image, try adjusting the frequency item.

Adjusting Picture Position

After connecting the unit to your PC, adjust the position of the screen if it is not well-aligned.

- 1 Access the **Picture Position** menu.
- 2 Press **UP/DOWN** to select **h position** or **v position** item.
- 3 Press **LEFT/RIGHT** to adjust the value of the item until the screen is well-aligned.

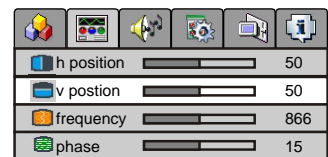

h position	50
v position	50
frequency	866
phase	15

Troubleshooting

Before calling for repair service, check the following items for possible remedies to an encountered symptom.

Symptoms	Check item
Ghost or double images	<ul style="list-style-type: none"> • This may be caused by obstruction to the antenna due to high rise buildings or hills. Using a highly directional antenna may improve the picture.
No power	<ul style="list-style-type: none"> • Check that the AC power cord is plugged into the mains socket. • Unplug the power cord, wait for 60 seconds. Then reinsert plug into the mains socket and turn on the unit again.
No picture	<ul style="list-style-type: none"> • Check antenna connections at the rear of the unit to see if it is properly connected to the unit. • Possible broadcast station trouble. Try another channel. • Adjust the contrast and brightness settings. • Select a correct input. • Is a non-compatible signal being input?
Good picture but no sound	<ul style="list-style-type: none"> • Increase the VOLUME. • Check that the unit is not muted. • Check Whether the sound is output to headphone.
Good sound but poor colour	<ul style="list-style-type: none"> • Adjust the contrast, colour and brightness settings.
Poor picture	<ul style="list-style-type: none"> • Sometimes, poor picture quality occurs when having activated an S-VHS camera or camcorder connected and having connected another peripheral at the same time. In this case, switch off one of the other peripherals. • Check whether the room is too bright.
Horizontal dotted line	<ul style="list-style-type: none"> • This may be caused by electrical interference (e.g. hair dryer, nearby neon lights, etc.) • Turn off the equipment.
Television not responding to remote control	<ul style="list-style-type: none"> • Check whether the batteries are working. Replace if necessary. • Clean the remote control sensor lens on the unit. • Do not use the remote control under strong or fluorescent lighting. • The batteries should be inserted with polarity (+, -) aligned.
Snowy picture and noise	<ul style="list-style-type: none"> • Check the antenna connection.
No stable or not synchronised D-Sub picture	<ul style="list-style-type: none"> • Check if you have selected the correct VGA mode in your PC.
No output from one of the speakers	<ul style="list-style-type: none"> • Adjust Sound Balance.
Controls buttons do not work	<ul style="list-style-type: none"> • Unplug the power cord, wait for some seconds. Then re-plug the power cord and turn on the unit again.

■ **Do not use in hot and cold rooms (location)**

When the unit is used in rooms (locations) with low temperature, the picture may leave trails or appear slightly delayed. This is not a malfunction, and the unit will recover when the temperature returns to normal.

Do not leave the unit in a hot or cold location. Also, do not leave the unit in a location exposed to direct sunlight or near a heater, as this may cause the cabinet to deform and the LCD panel to malfunction.

(Storage temperature: 0°C to +50°C Working temperature: 5°C to 40°C.)

Note:

If your problem is not solved, restart your TV by turning it off and then on again once.

Never attempt to repair a defective TV yourself.

Specifications

Power Supply:	240V 50Hz
Power Consumption:	130W (Max.)
Dimensions (mm):	705(W) x 180(D) x 454(H)
Weight (kg):	11.5
Screen (cm):	58

TV system & channel coverage.

SYSTEM	VHF	UHF	CATV
PAL-B/G	2-12	21-69	X~Z+2, S1~S41

Colour system:	PAL-BG, NTSC (AV)
Sound output:	3.5W x 2
Accessories	Operation manual x 1, Power cord x1 AV cable x 1, Remote control x 1, AAA Battery x 2.

 Note: Design and specifications are subject to change without notice.

PALSONIC CORPORATION PTY LTD
1 JOYNTON AVENUE
WATERLOO NSW 2017 AUSTRALIA
TEL: (02) 9313 7111
FAX: (02) 9313 7555
www.palsonic.com.au

**PALSONIC CUSTOMER SERVICE
TELEPHONE
AUSTRALIA: 1300 657 888**

604-L23H63-00
Ver1.0

Free Manuals Download Website

<http://myh66.com>

<http://usermanuals.us>

<http://www.somanuals.com>

<http://www.4manuals.cc>

<http://www.manual-lib.com>

<http://www.404manual.com>

<http://www.luxmanual.com>

<http://aubethermostatmanual.com>

Golf course search by state

<http://golfingnear.com>

Email search by domain

<http://emailbydomain.com>

Auto manuals search

<http://auto.somanuals.com>

TV manuals search

<http://tv.somanuals.com>