

OWNER'S MANUAL

Palsonic

**81CM CORDLESS REMOTE LCD TV/MONITOR
MODEL: TFTV812U**



N111

**PALSONIC CORPORATION PTY LTD
1 JOYNTON AVENUE
WATERLOO NSW 2017 AUSTRALIA
TEL: (02) 9313 7111
FAX: (02) 9313 7555
www.palsonic.com.au**

**PALSONIC CUSTOMER SERVICE
TELEPHONE
AUSTRALIA: 1300 657 888**

Table of Contents

Important Information	1
Important Safety Precautions	2
Preparations	5
Using the Remote Control	5
Batteries for the Remote Control	5
Power Connection	5
Antenna Connection	6
Identification of Controls	7
Main Unit	7
Remote Control	9
Connections	10
Cautions Before Connecting	10
Connect a VCR	10
Connect a Camcorder	11
Connect a DVD Player	12
Connect a product to HDMI	13
Connect a PC	14
Connect A VCR for Recording	15
Turning the Unit On and Off	16
Turning the Unit On and Off.....	16
Viewing the Menus and Displays	16
Viewing TV Programs	17
Auto Search	17
Manual Search	17
Skipping Channel	18
Exchange Channel	18
Setting AFC Function ON or OFF	19
Manual Fine Tuning	19
Basic Operations	20
Changing Channels	20
Adjusting the Volume	20
Select Input Source Signal	21
Setting Colour System	21
Setting Sound System	21
Setting Picture	22
Customising the Picture	22
Using the Preset Picture Mode	22
Adjusting Screen Aspect	23
Reducing Picture Noise	23
Freezing Picture	23
Setting Timer	24
Setting Clock Time	24
Setting ON Timer	24
Setting OFF Timer	24
Setting Sleep Timer	25

Table of Contents (continued)

Setting Sound	26
Customising the Sound	26
Using the Preset Sound Mode	26
Adjusting On-Screen Display	27
Adjusting OSD Position	27
Adjusting OSD Transparency	27
Setting OSD Timeout	27
PIP Operations	28
Viewing and Changing The Position of the PIP Frame	28
Selecting the Signal Source for the PIP Frame	28
Selecting Sound Source for PIP Frame	28
Adjustment in VGA Mode	29
Adjusting Picture	29
Adjusting Image Size	29
Changing the Position of Image	30
Adjusting the CLOCK and PHASE	30
Adjusting the Picture Automatically	30
Troubleshooting	31
Specifications	31

Important Information

WARNING: TO REDUCE THE RISK OF OR ELECTRIC SHOCK, DO NOT EXPOSE THIS APPARATUS TO RAIN OR MOISTURE.

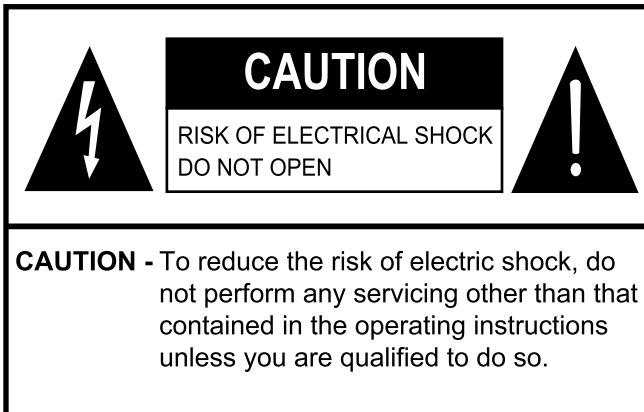

The lightning flash with arrowhead symbol, within an equilateral triangle is intended to alert the user to the presence of insinuated dangerous voltage within the product's enclosure that may be of sufficient magnitude to constitute a risk of electric shock to persons.



The exclamation point within an equilateral triangle is intended to alert the user to the presence of ,important operating and maintenance (servicing) instructions in the literature accompanying the appliance.

Note to CATV system installer: This reminder is provided to call the CATV system installer's attention to Article 820-40 of the National Electrical Code that provides guidelines for proper grounding and, in particular, specifies that the cable ground shall be connected to the grounding system of the building, as close to the point of cable entry as practical. (America only)

This product utilises tin-lead solder, and fluorescent lamp containing a small amount of mercury. Disposal of these materials may be regulated due to environmental considerations. For disposal or recycling information, please contact your local authorities or the Electronic Industries Alliance: www.eia.org (America only)

FCC STATEMENT (America only)

FCC Notice

LCD TV: A CLASS B digital device

This equipment has been tested and found to comply with the limits for a Class digital device, pursuant to part 15 of the FCC Rules. These limits are designed to provide reasonable protection against harmful interference when the equipment is operated in a commercial environment.

This equipment generates, uses, and can radiate radio frequency energy and, if not installed and used in accordance with the instruction manual, may cause harmful interference to radio communications. Operation of this equipment in a residential area is likely to cause harmful interference in which case the user will be required to correct the interference at his own expense.

FCC CAUTION:

Pursuant to 47CFR, Part 15.21 of the FCC rules, any changes or modifications to this monitor not expressly approved by the manufacturer could cause harmful interference and would void the user's authority to operate this device.

WARNING: This is a CLASS B product. In a domestic environment this product may cause radio interference in which case the user may be required to take adequate measures to counter interference.

Important Safety Precautions

Electrical energy can perform many useful functions, but it can also cause personal injuries and property damage if improperly handled. This product has been engineered and manufactured with the highest priority on safety. But **IMPROPER USE CAN RESULT IN POTENTIAL ELECTRICAL SHOCK OR FIRE HAZARD**. In order to prevent potential danger, please observe the following instructions when installing, operating and cleaning the product. To ensure your safety and prolong the service life of your PDP TV product, please read the following precautions carefully before using the product.

1. Read these instructions---All operating instructions must be read and understood before the product is operated.

2. Keep these instructions---These safety and operating instructions must be kept in a safe place for future reference.

3. Heed all warnings---All warnings on the product and in the instructions must be observed closely.

4. Follow all instructions---All operating instructions must be followed.

5. Do not use this apparatus near water---for example, near a bathtub, washbowl, kitchen sink, or laundry tub, in a wet basement, or near swimming pool, and the like.

Do not use immediately after moving from a low temperature to high temperature environment, as this causes condensation, which may result in fire, electric shock, or other hazards.

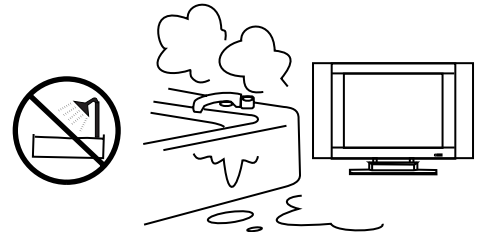

6. Clean only with dry cloth---Unplug this product from the wall outlet before cleaning. Do not use liquid cleaners or aerosol cleaners. Use a damp cloth for cleaning.

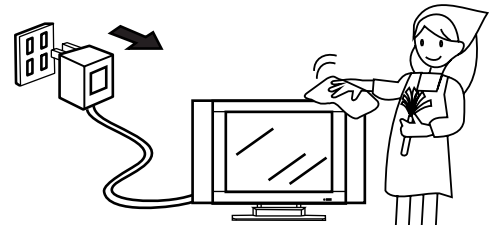

7. Ventilation---Do not block any ventilation openings. Install in accordance with the manufacturer instructions. The vents and other openings in the cabinet are designed for ventilation. Do not cover or block these vents and openings since insufficient ventilation can cause overheating and/or shorten the life of the product. Do not place the product on a bed, sofa, rug or other similar surface, since they can block ventilation openings. This product is not designed for built-in installation; do not place the product in an enclosed place such as a bookcase or rack, unless proper ventilation is provided or the manufacturer's instructions are followed.

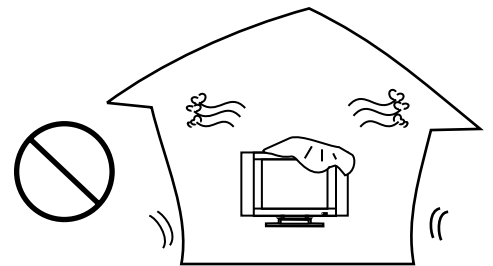

8. Heat sources---Do not install near any heat sources such as radiators, heat registers, stoves, or other apparatus (including amplifiers) that produce heat.

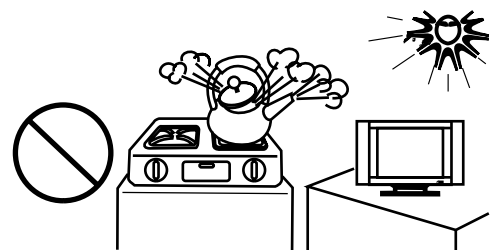

9. Grounding or Polarisation---Do not defeat the safety purpose of the polarised or grounding-type plug. A polarised plug has two blades with one wider than the other. A grounding type plug has two blades and a third grounding prong. The wide blade or the third prong are provided for your safety. If the provided plug does not fit into your outlet, consult an electrician for replacement of the obsolete outlet. **(America only)**

10. Power cord protection---Protect the power cord from being walked on or pinched particularly at plugs, convenience receptacles, and the point where they exit from the apparatus.

11. Attachments---Only use attachments/ accessories specified by the manufacturer. Do not use attachments not recommended by the manufacturer. Use of improper attachments can result in accidents.

Important Safety Precautions (continued)

12. Stand---Use only with the cart, stand, tripod, bracket, or table specified by the manufacturer, or sold with the apparatus. Do not place the product on an unstable trolley, stand, tripod or table. Placing the product on an unstable base can cause the product to fall, resulting in serious personal injuries as well as damage to the product. When mounting the product on a wall, be sure to follow the manufacturer's instructions. Use only the mounting by the hardware recommended manufacturer.

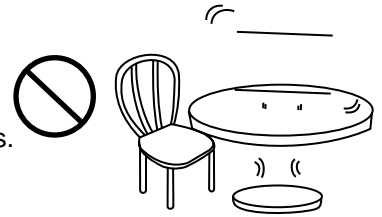

13. Carefully move---When a cart is used, use caution when moving the cart/apparatus combination to avoid injury from tip-over. Sudden stops, excessive force and uneven floor surfaces can cause the product to fall from the trolley.



14. Lightning---Unplug this apparatus during lightning storms or when unused for long of periods time.

For added protection for this television equipment during a lightning storm, or when it is left unattended and unused for long periods of time, unplug it from the wall outlet and disconnect the antenna. This will prevent damage to the equipment due to lightning and power-line surges.

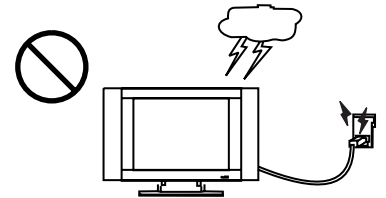

15. Servicing---Refer all servicing to qualified service personnel. Servicing is required when the apparatus has been damaged in any way, such as power-supply cord or plug is damaged, liquid has been spilled or objects have fallen into the apparatus, the apparatus has been exposed to rain or moisture, does not operate normally, or has been dropped.

16. Replacement parts---In case the product needs replacement parts, make sure that the service person uses replacement parts specified by the manufacturer, or those with the same characteristics and performance as the shock and/or original parts. Use of unauthorised parts can result in fire, electric other danger.

17. Overloading---Do not overload wall outlets, extension cords, or convenience receptacles on other equipment as this can result in a risk of fire or electric shock.

18. Entering of objects and liquids---Never insert an object into the product through vents or openings. High voltage flows and/or in the product, and inserting an object can cause electric shock short internal parts. For the same reason, do not spill water or liquid on the product.

19. Damage, requiring service---If any of the following conditions occurs unplug the power cord from the AC outlet, and repairs. request a qualified service person to perform

- When the power cord or plug is damaged.
- When a liquid is spilled on the product or when objects have fallen into the product.
- When the product has been exposed to rain or water.
- When the product does not operate properly as described in the operating instructions.

Do not touch the controls other than those described in the operating instructions. Improper adjustment of controls not described in the instructions can cause damage, which often requires extensive adjustment work by a qualified technician.

- If the product has been dropped or the cabinet has been damaged in any way.
- When the product displays an abnormal condition or exhibits a distinct change in performance. Any noticeable abnormality in the product indicates that the product needs servicing.

20. Safety checks---Upon completion of service or repair work, request the service technician to perform safety checks to ensure that the product is in proper operating condition.

21. Wall or ceiling mounting---When mounting the product on a wall or ceiling, be sure to install the product according to the method recommended by the manufacturer. This is a safety feature.

Important Safety Precautions (continued)

22. Power source---This product is intended to be supplied by a listed power supply indicated on the marking label. If you are not sure of the type of power supply to your home, consult your product dealer or local power company. For added protection for this product during a lightning storm, or when it is left unattended and unused for long periods of time, unplug it from the wall outlet and disconnect the cable system. This will prevent damage to the product due to lightning and power line surges. When the unit has to be used with another power supply voltage, the power cable must be changed. Consult your product dealer. The socket outlet should be installed near the equipment and easily accessible. Use only the power cord designated by our dealer to ensure safety and EMC. When connecting other products such as VCRs and personal computers, you should turn off the power of the unit for protection against electric shock.

23. Panel protection---The LCD panel used in this product is made of glass. Therefore, it can break when the product is dropped or impacted upon by other objects. Be careful not to be injured by broken glass pieces in case the LCD panel breaks.

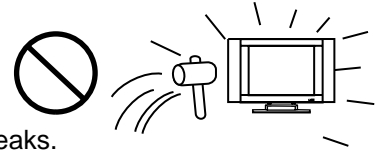

24. Pixel defect---The LCD panel is a very high technology product, giving you finely detailed pictures. Occasionally, a few non-active pixels may appear on the screen as a fixed point of blue, green or red. Please note that this does not affect the performance of your product.

■ If an outside antenna is connected to the television equipment, be sure the antenna system is grounded so as to provide some protection against voltage surges and built-up static charges. Section 810 of the National Electrical Code provides information with respect to proper grounding of the mast and supporting structure, grounding of the lead-in wire to an antenna discharge unit, size of grounding conductors, location of antenna-discharge unit, connection to grounding electrodes, and requirements for the grounding electrode. (America only)

EXAMPLE OF ANTENNA GROUNDING AS PER NATIONAL ELECTRICAL CODE

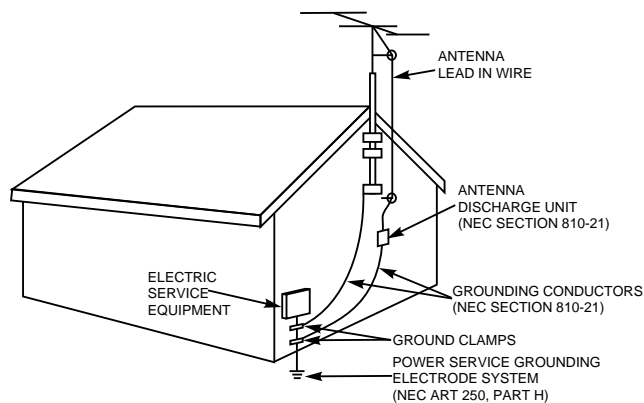

NEC --- NATIONAL ELECTRICAL CODE

■ An outside antenna system should not be located in the vicinity of overhead power lines or other electric light or power circuits, or where it can collide with such power lines or circuits. When installing an outside antenna system, extreme care should be taken to keep from touching such power lines or circuits, as contact with them might be fatal.

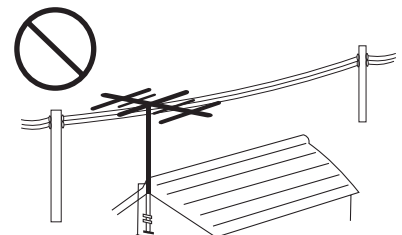

Preparations

Using the Remote Control

- Use the remote control by pointing it towards the remote sensor window of the set. Objects between the remote control and sensor window may prevent proper operation.

Note: the illustration is for your reference only, the remote sensor may locate differently with different model.

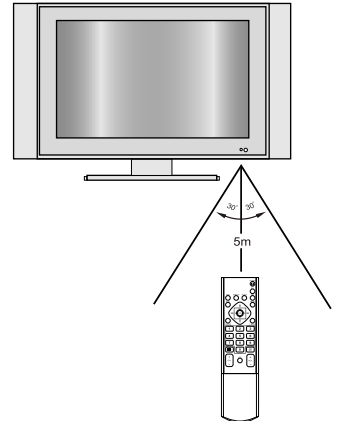

Cautions regarding use of remote control

- Do not expose the remote control to shock. In addition, do not expose the remote control to liquids, and do not place in an area with high humidity.
- Do not install or place the remote control under direct sunlight. The heat may cause deformation of the unit.
- The remote control may not work properly if the remote sensor window of the main unit is under direct sunlight or strong lighting. In such a case, change the angle of the lighting or LCD TV set, or operate the remote control closer to the remote sensor window.

Batteries for the Remote Control

If the remote control fails to operate the LCD TV functions, replace the batteries in the remote control.

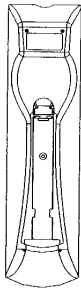

- 1 Open the battery cover.
- 2 Insert two size-AAA batteries.
 - (Place the batteries with their terminals corresponding to the (+) and (-) indications in the battery compartment.)
- 3 Replace the cover.

Precautions on battery use

Improper use of batteries can result in a leakage of chemicals and/or explosion. Be sure to follow the instructions below.

- Place batteries with their terminals corresponding to the (+) and (-) indications.
- Different types of batteries have different characteristics. Do not mix batteries of different types.
- Do not mix old and new batteries. Mixing old and new batteries can shorten the life of new batteries and/or cause old batteries to leak chemicals.
- Remove batteries as soon as they are non-operable. Chemicals that leak from batteries can cause a rash. If chemical leakage is found, wipe with a cloth.
- The batteries supplied with the product may have a shorter life expectancy due to storage conditions.
- If the remote control is not used for an extended period of time, remove the batteries from the remote control.

Power Connection

Insert the AC socket into a conveniently located AC outlet.

Note:

- This product should be operated only from the type of power source indicated on the marking label.
- Always unplug the AC cord from power outlet when not using for a long period of time.

Preparations (continued)

Antenna Connection

INSTALL the unit in a room where direct light will not fall upon the screen. Total darkness or a reflection on the picture screen may cause eyestrain. Soft and indirect lighting is recommended for comfortable viewing.

Optimum reception of colour requires a good signal and will generally mean that an outdoor aerial must be used. The exact type and position of the aerial will depend upon your particular area.

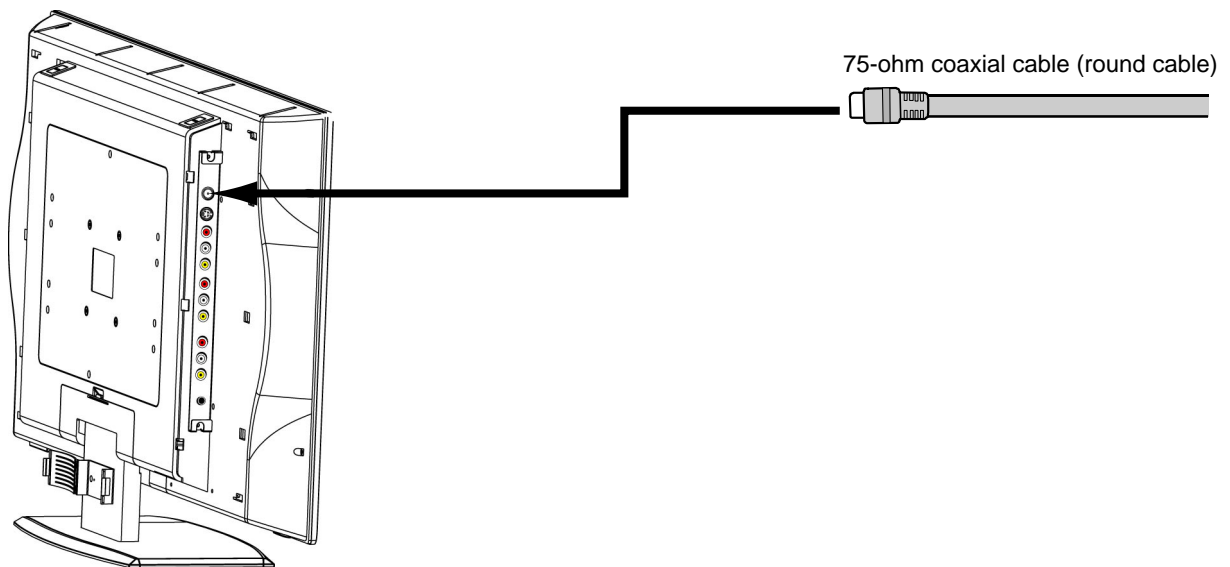

Note:

It is recommended that the 75-ohm coaxial cable be used to eliminate interference and noise which may occur due to radio wave conditions.

The aerial cable should not be bundled with the power cord and the like.

The illustration is for your reference only.

Identification of Controls

Main Unit

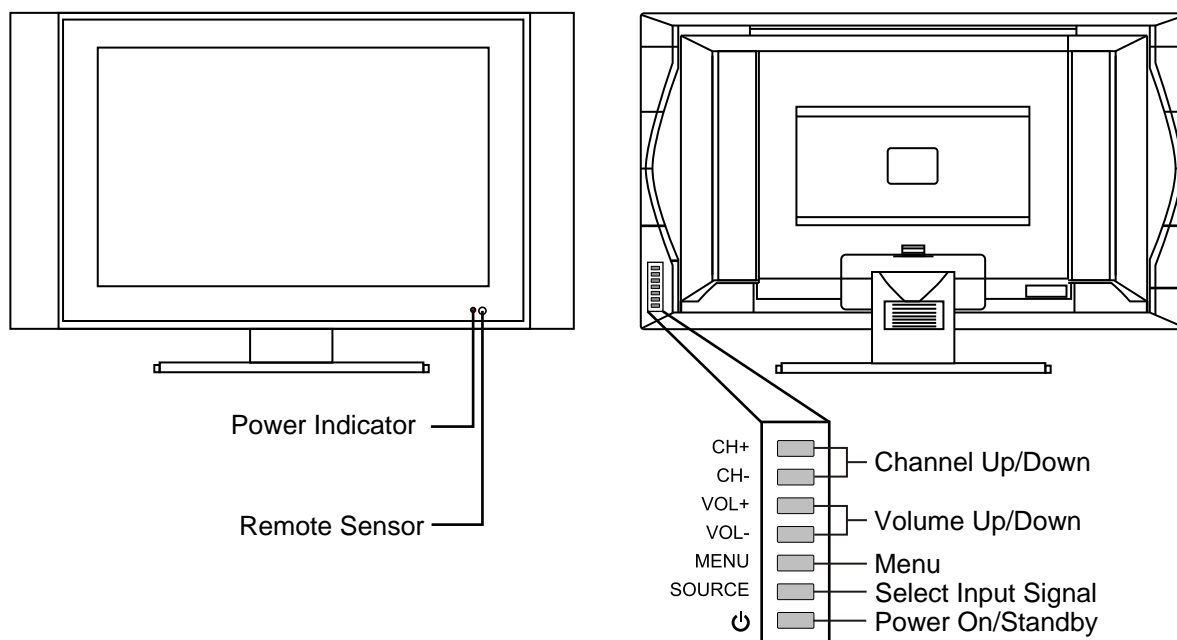

1. POWER

Press this button to turn the unit ON from STANDBY mode. Press it again to turn the set back to STANDBY.

2. SOURCE

To access signal source select menu

In OSD Menu, press this button to confirm your setting or operation

3. MENU

Press this button to access the Menu main page

4. VOL+/-

Press the **VOL+** or **VOL-** button to directly increase or decrease the sound volume level;

In OSD Menu, press these buttons to adjust the value or setting of each item

5. CH+/-

Press these two buttons to directly change the TV channel;

In OSD Menu, press these buttons to choose the OSD items

Note:

*Functions of **VOL+/-**, **CH+/-**, **MENU**, **SOURCE** and **POWER ** are also provided to the remote control. This operation manual provides a description based on operating functions with the remote control.*

Identification of Controls (continued)

Main Unit

Removing or installing the Back Cover

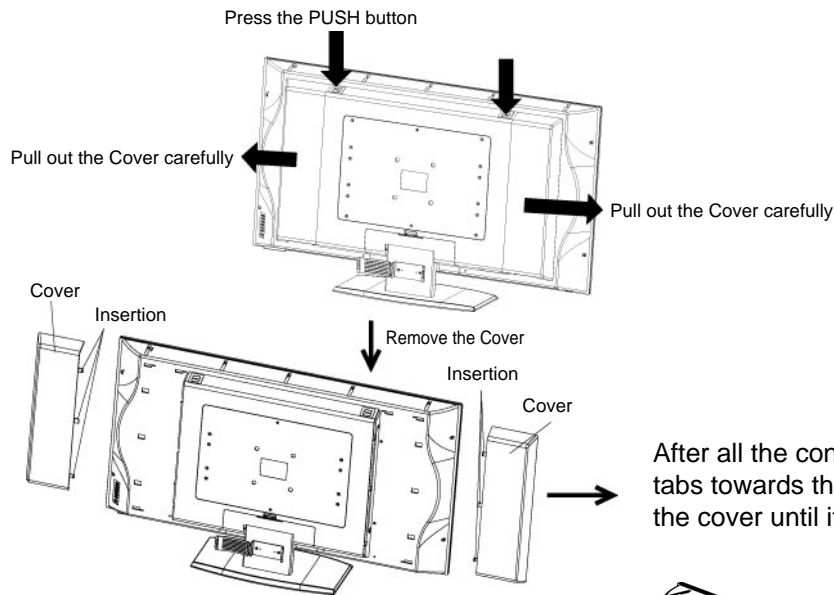

After all the connections are made, aim the insertion tabs towards the locating grooves, then carefully push the cover until it locks in place with a click

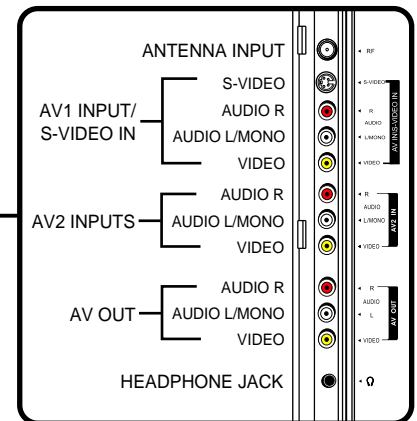
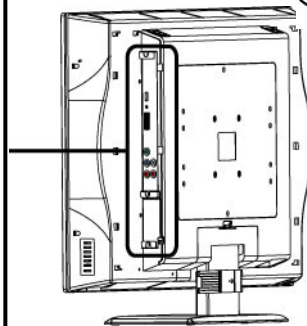
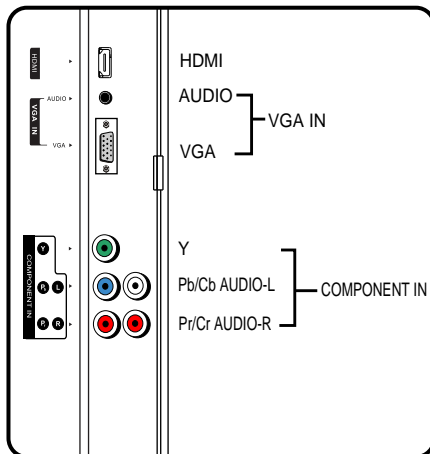

1. Antenna Input

Allows you to connect cable or outdoor antenna

2. AV2 Inputs (Video, Audio L/Mono, R) / S-Video input

Receive video/audio signals from external sources such as VCR or DVD player.

Receive a S-Video signal from external source such as VCR or DVD player.

3. AV1 Inputs (Video, Audio L/Mono, R)

Receive a S-Video signal from external source such as VCR or DVD player.

4. AV Outputs (Video, Audio L/Mono, R)

5. Headphone jack

6. HDMI input jack

7. VGA input / Audio in

Connect to the VGA/audio output jacks on your equipment.









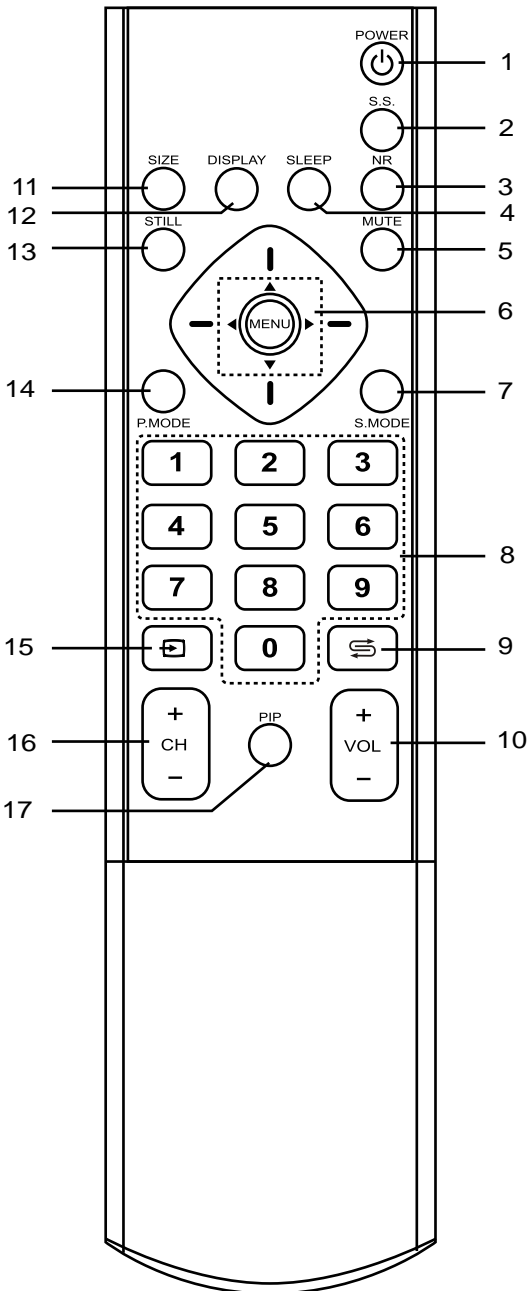

8. COMPONENT Inputs (Y, Pb/Cb, Pr/Cr, Audio L, R)

Connect to the audio and component output jacks of a DVD player or Set-Top Box.

Identification of Controls (continued)

Remote Control



- 1. POWER** 
 - Turn the unit on or off
- 2. S.S.**
 - To select sound output from the main frame or the PIP frame when in PIP mode
- 3. NR (Noise Reduce)**
 - To enhance the picture quality by reducing the noise (snow)
- 4. SLEEP**
 - To set Sleep timer
- 5. MUTE**
 - Sound mute
- 6. MENU**
 - To access the Menu main page or exit menu operation
 -    
 -  : To move upward or downward in menu operation;
 -  : To move left or right in menu operation;
 - To adjust selected menu item in menu operation;
 - To confirm your operation or setting or access a submenu
- 7. S.MODE**
 - Sound mode select
- 8. 0~9 number buttons**
 - Direct channel select
- 9. Return** 
 - To quickly jump between current channel and last selected channel
- 10. VOL+/-:** Use to adjust volume;
- 11. SIZE**
 - To quickly select SIZE MODE.
- 12. DISPLAY**
 - To display channel status or signal information
- 13. STILL**
 - To freeze current picture
- 14. P.MODE**
 - Picture mode select
- 15. Source** 
 - To access source select menu and to select the source
- 16. CH+/-:** Use to switch channels;
- 17. PIP**
 - To activate PIP function and change the position of the PIP frame

Connections

Cautions before connecting

- Carefully check the terminals for position and type before making any connections.
- The illustration of the external equipment may be different depending on your model.
- Loose connectors can result in image or colour problems. Make sure that all connectors are securely inserted into their terminals.
- Refer to the operating manual of the external device as well.
- When connecting an external device, turn the power off on the panel to avoid any issues.

Connect a VCR

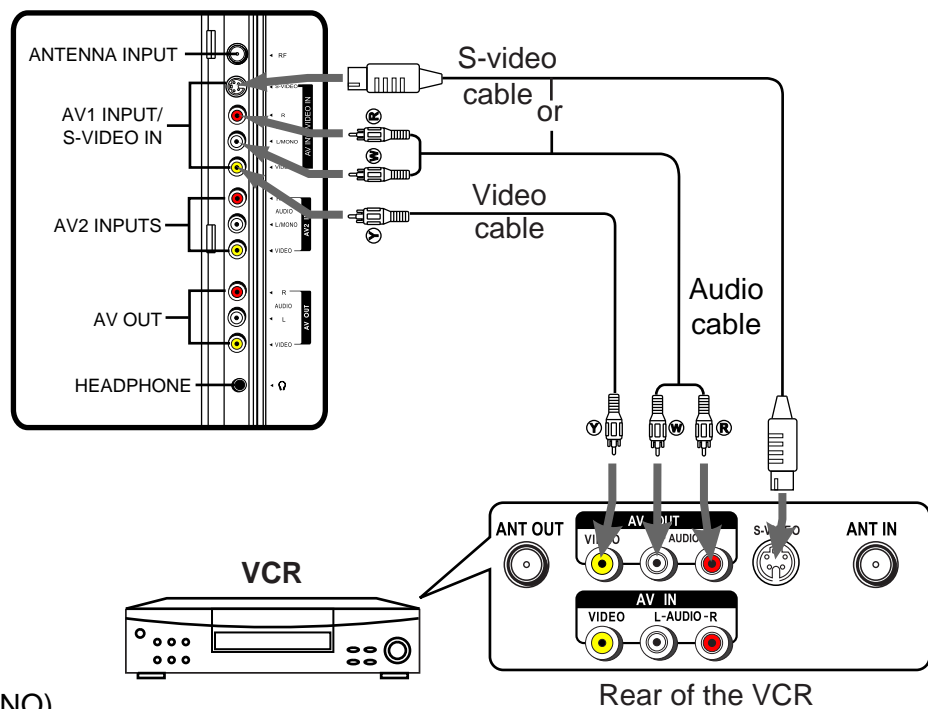

How to connect:

Connect the Audio/Video cables between the Audio (L/R)/Video jacks on the unit and VCR.

Note:

For better video, you can use the **S-Video** terminal if your source supports it.

The unit chooses the S-Video signal prior to the Video signal.

The **Video** input terminal on the **AV IN(2)** and the **S-Video** input terminal share the same Audio input terminals.

To play VCR

1. Turn on your LCD TV, press **Source** button on the remote control.
2. Press **Source** button repeatedly to select **AV2/SV**. Note that the period of two-press should be within 2 seconds.
3. Turn on your VCR, insert a video tape and press the Play button.

SOURCE
TV AV1 AV2/SV YPBPR VGA HDMI

Connections (continued)

Connect a Camcorder

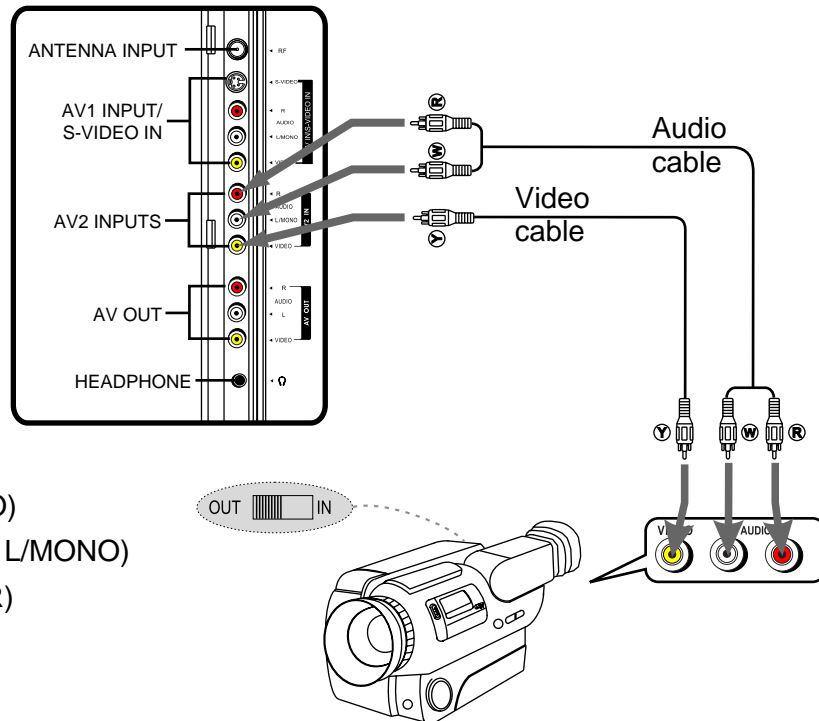

How to connect:

Connect the Audio/Video cables between the Audio (L/R)/Video jacks on the unit and camcorder.

To playback Camcorder

1. Turn on your LCD, press **Source** button on the remote control.
2. Press **Source** button repeatedly to select **AV1**.
3. Turn on your camcorder and set it to output mode. (For details, refer to your camcorder owner's manual.)
4. Insert the tape into the camcorder and press Play button.

SOURCE

TV AV1 AV2/SV YPBPR VGA HDMI

Note:

The operations of the camcorder may be different and is dependent on your model. Please read the owner's manual of your camcorder to confirm operation.

Connections (continued)

Connect a DVD player

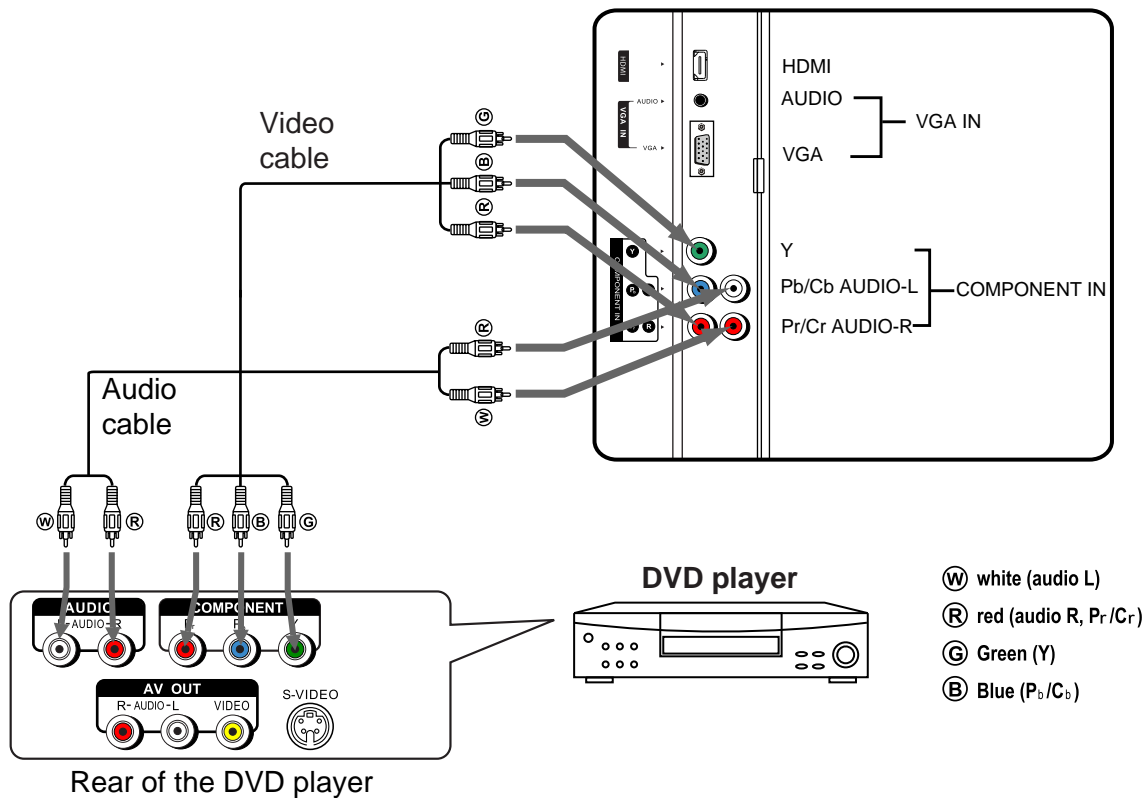



How to connect a DVD Player using Component Video Connections:

Connect the Video cable between the Y, Pb/Cb, Pr/Cr input jacks on the unit and Y, Pb, Pr (or Cb, Cr) output jacks on the DVD player.

Connect the Audio cable between the AUDIO input jacks on the unit and AUDIO output jacks on the DVD player.

To play DVD

1. Turn on your LCD TV, press **Source**  button on the remote control.
2. Press **Source**  button repeatedly to select **YPBPR**.
3. Turn on your DVD player, insert a DVD disc and press the Play button.

SOURCE
TV AV1 AV2/SV **YPBPR** VGA HDMI

Connections (continued)

Connect a product to HDMI

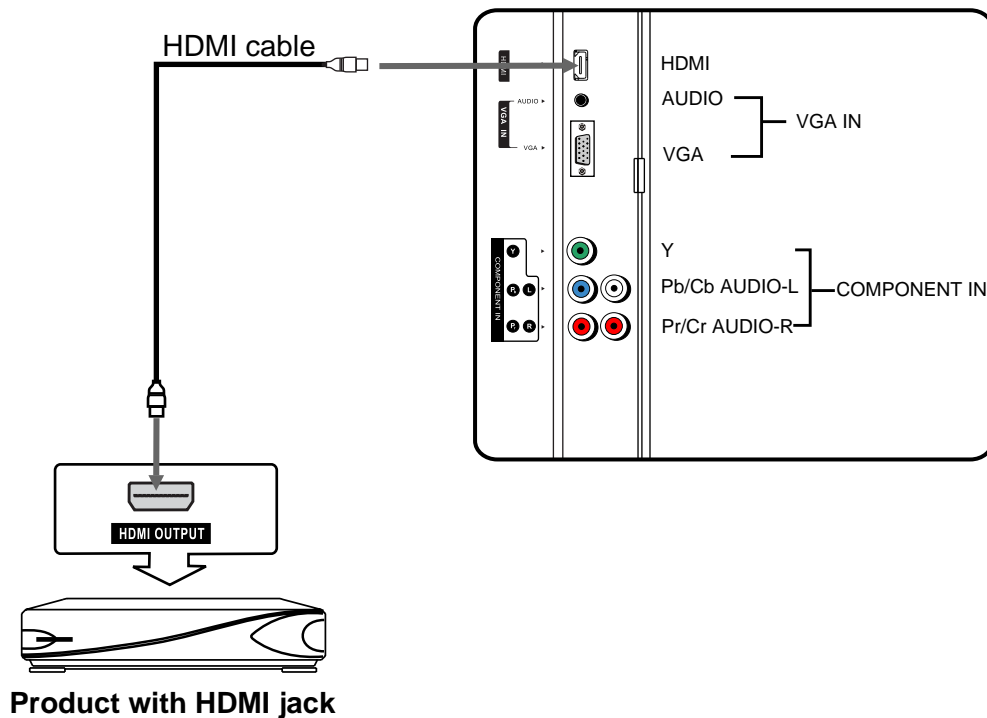

How to connect:

Connect the HDMI cable between the HDMI input jacks on the unit and HDMI output jacks on the product.



Note:

The HDMI Sources are compatible with DVI displays through the use of a passive cable converter. So you may connect product with DVI output jack to the unit.

Connect a passive cable converter between the HDMI input jack on the unit and DVI output jack on the product.

Connect an Audio cable between the AUDIO output on your product and AUDIO input jack of **VGA IN** on the unit.

To Watch your Product

1. Turn on your LCD TV, press **Source**  button on the remote control.
2. Press **Source**  button repeatedly to select **HDMI**.
3. Turn on your Product.

SOURCE
TV AV1 AV2/SV YPBPR VGA **HDMI**

Connections (continued)

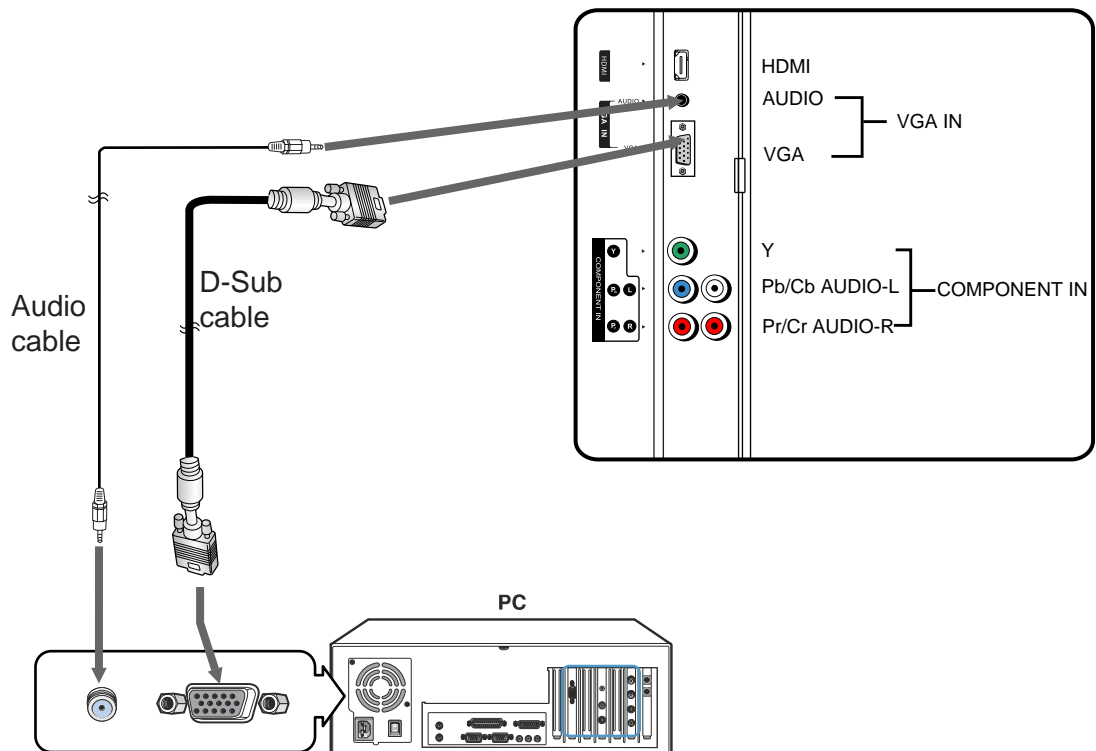

Connect a PC



How to connect:

Connect a D-Sub cable between the VGA interface on the PC and the VGA input on the unit.
Connect an Audio cable between the AUDIO output on the PC and AUDIO input jack on the unit.

To Watch the PC screen

1. Turn on your LCD TV, press **Source**  button on the remote control.
2. Press **Source**  button repeatedly to select **VGA**.
3. Turn on your PC and check for PC system requirements.
4. Adjust the screen resolution and settings on your computer to the preferred settings.

SOURCE
TV AV1 AV2/SV YPBPR **VGA** HDMI

Connections (continued)

Connect a VCR for Recording

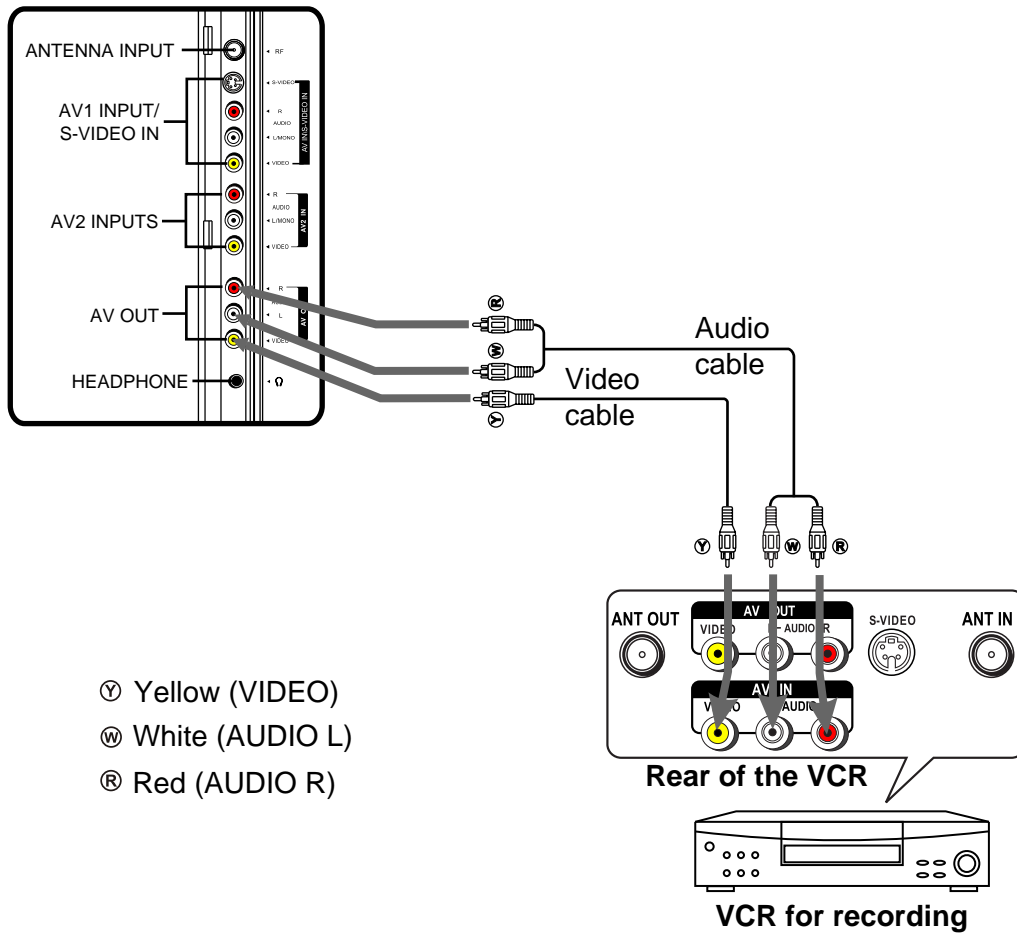

How to connect:

Connect the Audio/Video cables between the Audio (L/R)/Video jacks on the unit and VCR.

To record program

1. Turn on your LCD TV, select a program you wish to record.
2. Turn on your VCR, insert a videotape for recording.
3. Press the Record button to begin recording.

Note:

The AV output terminals output the audio/video signal from the Antenna input or AV inputs.

Turning the Unit On and Off

Turning the Unit On and Off

Turning On

Insert the power cord into the wall outlet.
Press the **Power** ⏻ button on the remote control.
The unit will be turned on and you will be ready to use its features.

Turning Off

With the power on, Press the **Power** ⏻ button on the remote control to turn off.

Note:

You can also use the **Power** ⏻ button on the Control panel on the main unit.

Viewing the Menus and Displays

Your LCD TV has a simple, easy-to-use menu system that appears on the screen. This system makes it convenient and fast To use features on the unit. The unit also lets you display the status of many of your LCDTV features.

Viewing the Menus

1 With the power on, press the **MENU** button on the remote control.
The main menu appears on the screen.

2 Use the ▲ ▼ to select menu page. Use ▶ to access the submenu.

3 Use the ▲ ▼ to select menu item. Use ◀ ▶ to adjust value of item.
You can press the **MENU** button repeatedly to exit the menu operations.



Note:

To clearly introduce the menu operations, this operation manual provides a description based on operation with the remote control.

Displaying Status Information

Press the **DISPLAY** button on the remote control, the unit will display current status information such as channel number, or signal source, etc.

Viewing TV Programs

Your LCD TV can memorise and store all the available channels. After the available channels are memorised, use CH+/- to scan the channels.

Auto Search

- 1 Press **MENU** to display the menu main page.
- 2 Press **▲ ▼** repeatedly to select **SOURCE** menu.
- 3 Press **▶** to access the submenu.
- 4 Press **▼** repeatedly to select **AUTO SEARCH** item.
- 5 Press **◀ ▶** to store channels in memory automatically.
The unit will begin memorising all the available channels. During the process of the Auto Search, you can press **MENU** to exit.

Note: Before AUTO SEARCH, please set the TV's colour system to AUTO and sound system to your local area's sound system.

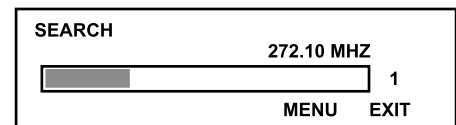

Manual Search

- 1 Press **MENU** to display the menu main page.
- 2 Press **▲ ▼** repeatedly to select **SOURCE** menu.
- 3 Press **▶** to access the submenu.
- 4 Press **▼** repeatedly to select **MANUAL SEARCH** item.
- 5 Press **▶** to access the submenu.
- 6 Press **▼** repeatedly to select **SEARCH NEXT** item.
- 7 Press **◀ ▶** to search program from current frequency.
Press **◀**, then the unit searches towards the lower frequency.
Press **▶**, then the unit searches towards the higher frequency.
- 8 Press **MENU** to exit.

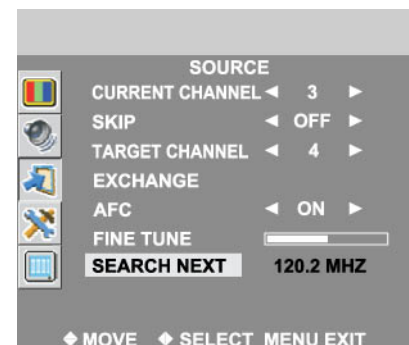

Viewing TV Programs (continued)

Skipping Channels

- 1 Press **MENU** to display the menu main page.
- 2 Press **▲ ▼** repeatedly to select **SOURCE** menu.
- 3 Press **▶** to access the submenu.
- 4 Press **▼** repeatedly to select **MANUAL SEARCH** item.
- 5 Press **▶** to access the submenu.
The [CURRENT CHANNEL] will be highlighted automatically.
- 6 Press **◀ ▶** to access a channel number that you want to skip.
- 7 Press **▼** to select **SKIP** item.
- 8 Press **◀ ▶** to select **ON** or **OFF**.
- 9 Press **MENU** to exit.



When the item is set to **ON**, the selected channel will be skipped.
When the item is set to **OFF**, the selected channel will not be skipped.
The skipped channels can not be selected by using the **CH+/-** buttons unless you use the **number buttons** to input channel number directly.

Exchanging Channel

- 1 Press **MENU** to display the menu main page.
- 2 Press **▲ ▼** repeatedly to select **SOURCE** menu.
- 3 Press **▶** to access the submenu.
- 4 Press **▼** repeatedly to select **MANUAL SEARCH** item.
- 5 Press **▶** to access the submenu.
The [CURRENT CHANNEL] will be highlighted automatically.
- 6 Press **◀ ▶** to select a channel number as your current channel.
- 7 Press **▼** to select **TARGET CHANNEL** item.
- 8 Press **◀ ▶** to select a target channel number that you want to exchange with the current channel.
- 9 Press **▼** to select **EXCHANGE** item.
- 10 Press **▶** to exchange the contents of the current channel and the target channel.

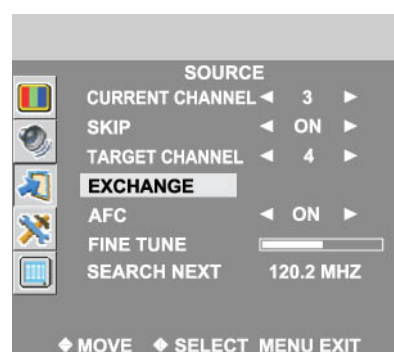

For example, if the current channel number is channel 3, and you select channel 4 as your target channel, now the contents of channel 3 and channel 4 will be exchanged if you perform the above steps.

Viewing TV Programs (continued)

Setting AFC Function ON or OFF

- 1 Press **MENU** to display the menu main page.
- 2 Press **▲ ▼** repeatedly to select **SOURCE** menu.
- 3 Press **▶** to access the submenu.
- 4 Press **▼** repeatedly to select **MANUAL SEARCH** item.
- 5 Press **▶** to access the submenu.
- 6 Press **▼** repeatedly to select **AFC** item.
- 7 Press **◀ ▶** to select **ON** or **OFF**.
- 8 Press **MENU** to exit.



When the item is set to **ON**, the unit will automatically tune the program frequency to provide the best possible picture and sound.

Manual Fine Tuning

- 1 Press **MENU** to display the menu main page.
- 2 Press **▲ ▼** repeatedly to select **SOURCE** menu.
- 3 Press **▶** to access the submenu.
- 4 Press **▼** repeatedly to select **MANUAL SEARCH** item.
- 5 Press **▶** to access the submenu.
- 6 Press **▼** to select **FINE TUNE** item.
- 7 Press **◀ ▶** to fine tune till the best possible picture and sound are obtained.
- 8 Press **MENU** to exit.



Basic Operations

Changing Channels

Using the Channel Buttons (CH+ or CH-)

Press the **CH+** or **CH-** to change channels.

When you press the **CH+** or **CH-**, the unit changes channels in sequence. You will see all the channels that the unit has memorised.

You will not see channels that were erased.

Direct Accessing Channels

Press the **number buttons** to go directly to a channel.

To select a one-digit channel: press the **0-9 number buttons** to input the channel number and the unit automatically goes to the selected channel.

To select a two-digit channel: press the **0-9 number buttons** to input the channel number and the unit goes to the selected channel immediately.

To select a three-digit channel: press the **0-9 number buttons** to input the channel number and the unit goes to the selected channel.

Note:

When you use the number buttons, you can directly select channels that were skipped.

The period of two-press should be within 2 seconds

Using the Return button

Press this button to switch between the current channel and the previous channel.

Adjusting the Volume

Using the volume buttons (VOL+ and VOL-)

Press the **VOL+** or **VOL-** to increase or decrease the volume.

Using the MUTE button

At any time, you can temporarily cut off the sound using the **MUTE** button.

1 Press the **MUTE** button and the sound cuts off.

2 To turn mute off, press the **MUTE** button again.

Basic Operations (continued)

Select Input Source Signal

- 1 Press **MENU** to display the menu main page.
- 2 Press **▲ ▼** repeatedly to select **SOURCE** menu.
- 3 Press **▶** to access the submenu.
- 4 Press **▼** repeatedly to select **PICTURE SOURCE** item.
- 5 Press **◀ ▶** to select.
- 6 Press **MENU** to exit.

TV ----- Select TV signal.

AV1 ----- Select signal from AV IN (1) terminals.

AV2/SV ----- Select signal from AV IN (2) or S-video terminals.

YPBPR ----- Select signal from YPbPr.

VGA ----- Select signal from VGA jack.

HDMI ----- Select signal from HDMI jack.

You can also use the **Source**  button to select input source signal.



Setting Colour System

- 1 Press **MENU** to display the menu main page.
- 2 Press **▲ ▼** repeatedly to select **SOURCE** menu.
- 3 Press **▶** to access the submenu.
- 4 Press **▼** repeatedly to select **COLOR SYSTEM** item.
- 5 Press **◀ ▶** to select.
- 6 Press **MENU** to exit.



Setting Sound System

- 1 Press **MENU** to display the menu main page.
- 2 Press **▲ ▼** repeatedly to select **SOURCE** menu.
- 3 Press **▶** to access the submenu.
- 4 Press **▼** repeatedly to select **SOUND SYSTEM** item.
- 5 Press **◀ ▶** to select.
- 6 Press **MENU** to exit.

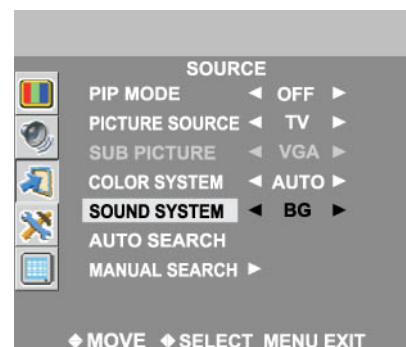

Setting Picture

Customising the Picture

- 1 Press **MENU** to display the menu main page.
The picture menu page will be displayed automatically.
- 2 Press **▶** to access the **PICTURE** submenu.
- 3 Press **▲ ▼** to select the item you wish to change.
- 4 Press **◀ ▶** to adjust the value of the item.
- 5 Press **MENU** to exit.

Note: Tint [TINT] item is for NTSC only.

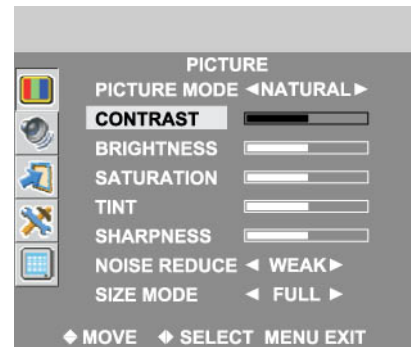

Using the Preset Picture Mode

- 1 Press **MENU** to display the **PICTURE** menu page.
- 2 Press **▶** to access the **PICTURE** submenu.
The [PICTURE MODE] will be highlighted automatically.
- 3 Press **◀ ▶** to select a desired picture mode.
- 4 Press **MENU** to exit.

There are three preset picture modes (**BRIGHT**, **SOFT** and **NATURAL**) and one user-set picture mode (**PERSONAL**). Each preset mode has its own picture settings.

BRIGHT: Select for a bright picture.

SOFT: Select for a finely detailed picture.

NATURAL: Select for a normal picture.

Adjusted settings are stored in **PERSONAL** mode.

You may quickly use the **P.MODE** button on the remote control to select picture mode.

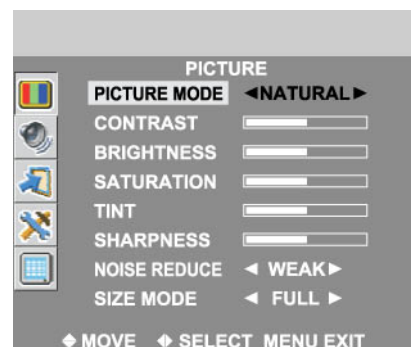

Setting Picture (continued)

Adjusting Screen Aspect

- 1 Press **MENU** to display the menu main page.
The picture menu page will be displayed automatically.
- 2 Press **▶** to access the submenu.
- 3 Press **▼** repeatedly to select **SIZE MODE** item.
- 4 Press **◀ ▶** to select a desired aspect ratio.
You can select the image aspect ratio between **FULL**, **ZOOM1**, **ZOOM2** and **NORMAL**.

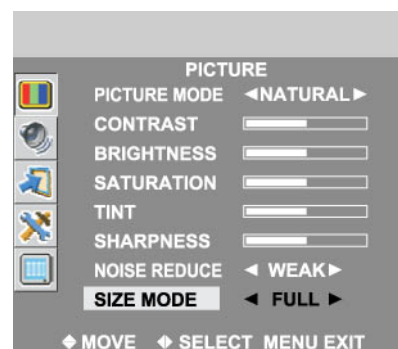

FULL – In this mode the picture is progressively stretched toward each side of the screen.

ZOOM1 – This feature is recommended for viewing "letter-box" movie (picture with a black bar on the top and bottom). If you watch a 4:3 picture in this mode, the picture will be expanded and some information at the top and bottom will be lost.

ZOOM2 – In this mode the picture is vertically stretched toward upside of the screen so that when viewing programs with title at the bottom, the bottom title can be revealed.

NORMAL – In this mode the picture is displayed without modification, in its native aspect ratio.

Note:

You may quickly switch the aspect ratio between **FULL**, **ZOOM1**, **ZOOM2** and **NORMAL** by using the **SIZE** button on the remote control.

Reducing Picture Noise

- 1 Press **MENU** to display the menu main page.
The picture menu page will be displayed automatically.
- 2 Press **▶** to access the submenu.
- 3 Press **▼** repeatedly to select **NOISE REDUCE** item.
- 4 Press **◀ ▶** to select **OFF**, **WEAK** or **STRONG**.

Sometimes a noisy picture may appear on the screen because of poor signal. This function helps to enhance the picture quality by reducing the noise.

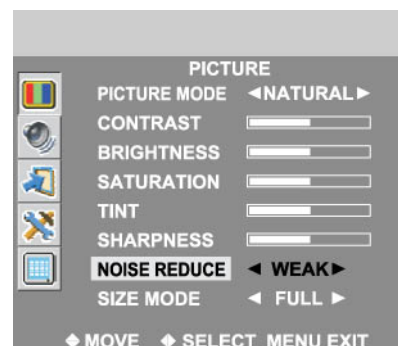

Note:

You may quickly reduce the picture noise by using **NR** button on the remote control.

Freezing picture

Press the **STILL** button to hold on the image on the screen (the video sources still run). Press it again to reactivate the image.

Note:

For the sake of protecting the screen, please **DO NOT** freeze a picture for a long time.

Setting Timer

Setting Clock Time

Making use of this function can set the current time for the TV.

- 1 Press **MENU** to display the menu main page.
- 2 Press **▲ ▼** repeatedly to select **FUNCTION** menu.
- 3 Press **▶** to access the submenu.
The **[CLOCK]** item will be highlighted automatically.
- 4 Press **▼** to access.
Use **▲ ▼** to set the hour (00-23) and the minute (00-59), use **◀ ▶** to switch between the hour and minute.
- 5 Press **MENU** to exit.

NOTE:

Before setting the **TIME ON** and **TIME OFF**, please set the **CLOCK** item first.



Setting ON timer

With the ON timer, the TV will automatically turn on at a preset time.

- 1 Press **MENU** to display the menu main page.
- 2 Press **▲ ▼** repeatedly to select **FUNCTION** menu.
- 3 Press **▶** to access the submenu.
- 4 Press **▼** repeatedly to select **TIME ON** item.
- 5 Press **▶** to access.
Use **▲ ▼** to set the hour (00-23) and the minute (00-59), use **◀ ▶** to switch between the hour and minute.
- 6 Press **MENU** to exit.

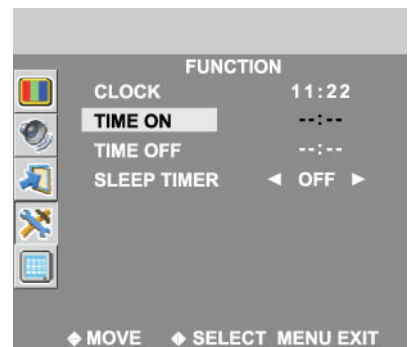

Setting OFF timer

With the OFF timer, the TV will automatically turn off at a preset time.

- 1 Press **MENU** to display the menu main page.
- 2 Press **▲ ▼** repeatedly to select **FUNCTION** menu.
- 3 Press **▶** to access the submenu.
- 4 Press **▼** repeatedly to select **TIME OFF** item.
- 5 Press **▶** to access.
Use **▲ ▼** to set the hour (00-23) and the minute (00-59), use **◀ ▶** to switch between the hour and minute.
- 6 Press **MENU** to exit.



POWER DOWN:

58

NOTE

The time interval between **CLOCK** and **TIME OFF** should be above 1 minute. When the last 1 minute comes, there exit two situations. The one is: the unit will show you after how many seconds the set will be turned off. During this period if you do not want the unit to be turned off, press any button to exit before the unit turn off. The other is: the **OFF** timer will be cancelled automatically under certain conditions such as sound mute, picture freeze or other OSD items adjustment etc.

Setting Timer (continued)

Setting Sleep Timer

Making use of this function allows you to have the set automatically turn off after a preset time.

- 1 Press **MENU** to display the menu main page.
- 2 Press **▲ ▼** repeatedly to select **FUNCTION** menu.
- 3 Press **▶** to access the submenu.
- 4 Press **▼** repeatedly to highlight **SLEEP TIMER** item.
- 5 Press **◀ ▶** repeatedly to select.
- 6 Press **MENU** to exit.

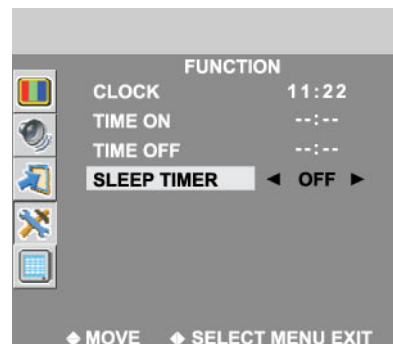

Note:

You may quickly set the sleep time by using the **SLEEP** button on the remote control.

Setting Sound

Customising the Sound

- 1 Press **MENU** to display the menu main page.
- 2 Press **▲ ▼** repeatedly to select **SOUND** menu.
- 3 Press **▶** to access the submenu.
- 4 Press **▼** repeatedly to select the option items you want to adjust.
- 5 Press **◀ ▶** to adjust the value.

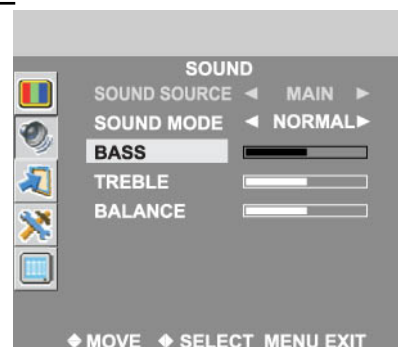

Using the Preset Sound Mode

- 1 Press **MENU** to display the menu main page.
- 2 Press **▲ ▼** repeatedly to select **SOUND** menu.
- 3 Press **▶** to access the submenu.
- 4 Press **▼** repeatedly to select **SOUND MODE** item.
- 5 Press **◀ ▶** to select a desired sound mode.

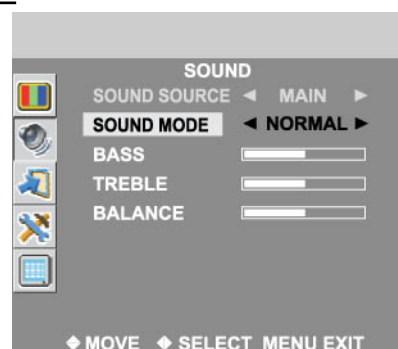

There are three preset sound modes (**NORMAL**, **MUSIC** and **NEWS**) and one user-set sound mode (**PERSONAL**). Each preset mode has its own sound settings (Bass and Treble).

NORMAL: Set the value of Bass and Treble to middle level.

MUSIC: Set the value of Bass and Treble to higher level.

NEWS: Set the value of Bass and Treble to lower level.

Adjusted settings are stored in **PERSONAL** mode.

You may directly use the **S.MODE** button to quickly select sound mode.

Adjusting On-Screen Displays

Adjusting OSD Position

- 1 Press **MENU** to display the menu main page.
- 2 Press **▲ ▼** repeatedly to select **OSD** menu.
- 3 Press **▶** to access the submenu.
- 4 Press **▼** repeatedly to select **H-POSITION** or **V-POSITION** item.
- 5 Press **◀ ▶** to adjust the OSD position.



Adjusting OSD Transparency

- 1 Press **MENU** to display the menu main page.
- 2 Press **▲ ▼** repeatedly to select **OSD** menu.
- 3 Press **▶** to access the submenu.
- 4 Press **▼** repeatedly to select **TRANSPARENCY** item.
- 5 Press **◀ ▶** to adjust the OSD transparency.



Setting OSD Timeout

This setting allows you to set the time for the main OSD menu to be displayed on screen.

- 1 Press **MENU** to display the menu main page.
- 2 Press **▲ ▼** repeatedly to select **OSD** menu.
- 3 Press **▶** to access the submenu.
- 4 Press **▼** repeatedly to select **DURATION** item.
- 5 Press **◀ ▶** to adjust the value.



PIP Operations

Viewing and Changing the Position of the PIP Frame

- 1 Press **MENU** to display the menu main page.
- 2 Press **▲ ▼** repeatedly to select **SOURCE** menu.
- 3 Press **▶** to access the submenu.
The [PIP MODE] item will be highlighted automatically.
- 4 Press **◀ ▶** repeatedly to select OFF, P1S1, P1S2, P2S1, P2S2, P3S1, P3S2, P4S1 or P4S2.
- 5 Press **MENU** to exit.

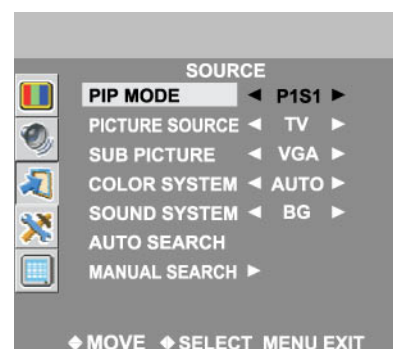

NOTE:

You may quickly open or close PIP frame by directly using the **PIP** button.
You may also change the position of the PIP frame by holding the **PIP** button.

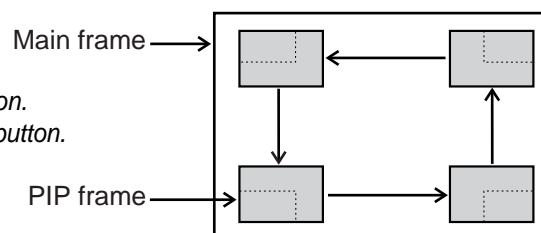

Selecting the Signal Source for the PIP Frame

- 1 With the PIP working, press **MENU** to display the menu main page.
- 2 Press **▲ ▼** repeatedly to select **SOURCE** menu.
- 3 Press **▶** to access the submenu.
- 4 Press **▼** repeatedly to select **SUB PICTURE** item.
- 5 Press **◀ ▶** to select signal source for the PIP frame.

The input signal source are divided into two groups. One contains TV, AV1 and AV2/SV, the other contains YPbPr, VGA and HDMI.

If the input signal source selected for the main frame is one kind from one group, you may only allow to select a kind of input signal source for PIP frame from the other group.

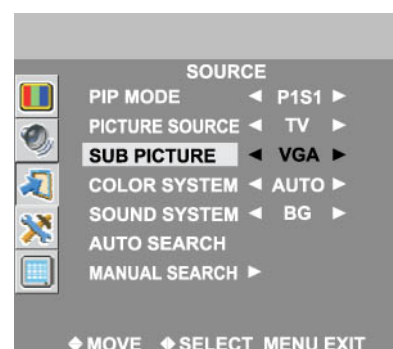

Selecting Sound Source for PIP Frame

- 1 With the PIP working, press **MENU** to display the menu main page.
- 2 Press **▲ ▼** repeatedly to **SOUND** select menu.
- 3 Press **▶** to access the submenu.
The [SOUND SOURCE] item will be highlighted automatically.
- 4 Press **◀ ▶** to select between **MAIN** or **SUB**.
- 5 Press **MENU** to exit.

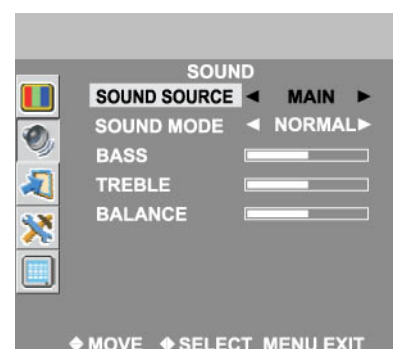

NOTE:

If you select **MAIN**, the main frame sound will be output;
If you select **SUB**, the pip frame will be highlighted with a blue border and the sound will be output.
You may directly use the **S.S** button for selection.

Adjustment in VGA Mode

Adjusting the Picture

- 1 Press **MENU** to display the menu main page.
The [PICTURE] menu will be highlighted automatically.
- 2 Press **▶** to access the submenu.
- 3 Press **▲ ▼** repeatedly to select the item you wish to change.
- 4 Press **◀ ▶** to adjust the value of the item.
- 5 Press **MENU** to exit.

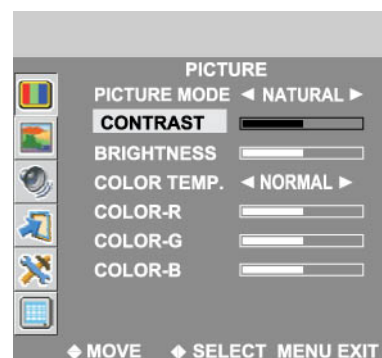

Adjusting Image Size

- 1 Press **MENU** to display the menu main page.
- 2 Press **▲ ▼** repeatedly to select **SCREEN** menu.
- 3 Press **▶** to access the submenu.
The [SIZE MODE] item will be highlighted automatically.
- 4 Press **◀ ▶** to **FULL** or **ASPECT**.
- 5 Press **MENU** to exit.

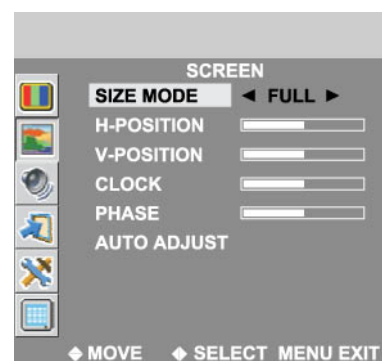

Adjusting in VGA Mode (continued)

Changing the Position of Image

- 1 Press **MENU** to display the menu main page.
- 2 Press **▲ ▼** repeatedly to select **SCREEN** menu.
- 3 Press **▶** to access the submenu.
- 4 Press **▼** repeatedly to select **H-POSITION** or **V-POSITION** item.
- 5 Press **◀ ▶** to adjust the value of the item until the screen is well-aligned.
- 6 Press **MENU** to exit.

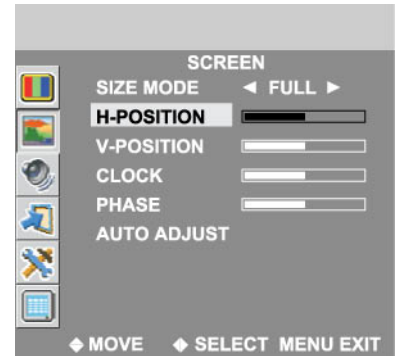

Adjusting the CLOCK and PHASE

- 1 Press **MENU** to display the menu main page.
- 2 Press **▲ ▼** repeatedly to select **SCREEN** menu.
- 3 Press **▶** to access the submenu.
- 4 Press **▼** repeatedly to select **CLOCK** or **PHASE** item.
- 5 Press **◀ ▶** to adjust the value of the item.
- 6 Press **MENU** to exit.

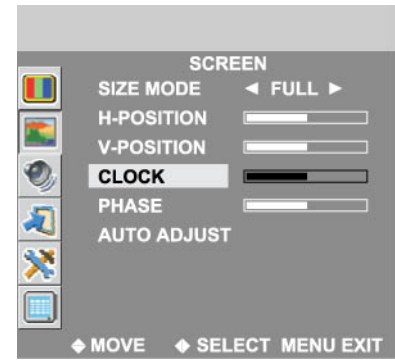

You may find that images blur, depending on the clock phase of your PC's Processor. If you experience blurring, you can obtain a clearer image by adjusting the phase item.

Adjust the clock frequency of the set's internal clock signal. If shimmering or rainbow-like noise is apparent in the image, try adjusting the clock frequency item.

Adjusting the Picture Automatically

If you are not satisfied with the picture, you may adjust the picture by using this function.

- 1 Press **MENU** to display the menu main page.
- 2 Press **▲ ▼** repeatedly to select **SCREEN** menu.
- 3 Press **▶** to access the submenu.
- 4 Press **▼** repeatedly to select **AUTO ADJUST** item.
- 5 Press **▶** to start adjusting.

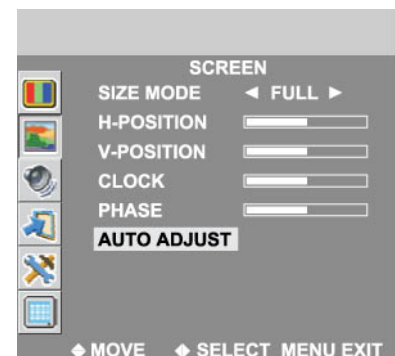

Troubleshooting

Before calling for repair service, check the following items for possible remedies to an encountered symptom.

Symptoms	Check item
"Ghost" or double images	<ul style="list-style-type: none"> • This may be caused by obstruction to the antenna due to high rise buildings or hills. Using a highly directional antenna may improve the picture.
No power	<ul style="list-style-type: none"> • Check that the AC power cord is plugged into the mains socket. • Unplug the power cord, wait for 60 seconds. Then reinsert plug into the mains socket and turn on the unit again.
No picture	<ul style="list-style-type: none"> • Check antenna connections at the rear of the unit to see if it is properly connected to the unit. • Possible broadcast station trouble. Try another channel. • Adjust the contrast and brightness settings. • Select a correct input. • Is a non-compatible signal being input?
Good picture but no sound	<ul style="list-style-type: none"> • Increase the VOLUME. • Check that the unit is not muted.
Good sound but poor colour	<ul style="list-style-type: none"> • Adjust the contrast, colour and brightness settings.
Poor picture	<ul style="list-style-type: none"> • Sometimes, poor picture quality occurs when having activated an S-VHS camera or camcorder connected and having connected another peripheral at the same time. In this case, switch off one of the other peripherals. • Check whether the room is too bright.
Horizontal dotted line	<ul style="list-style-type: none"> • This may be caused by electrical interference (e.g. hair dryer, nearby neon lights, etc.) • Turn off the equipment.
Television not responding to remote control	<ul style="list-style-type: none"> • Check whether the batteries are working. Replace if necessary. • Clean the remote control sensor lens on the unit. • Do not use the remote control under strong or fluorescent lighting. • The batteries should be inserted with polarity (+, -) aligned.
Snowy picture and noise	<ul style="list-style-type: none"> • Check the aerial connection.
No stable or not synchronised VGA picture	<ul style="list-style-type: none"> • Check if you have selected the correct VGA mode in your PC.
No output from one of the speakers	<ul style="list-style-type: none"> • Adjust Balance in the SOUND menu.
Controls buttons do not work	<ul style="list-style-type: none"> • Unplug the power cord, wait for some seconds. Then re-plug the power cord and turn on the unit again.

Do not use in hot and cold rooms (location)

When the unit is used in rooms (locations) with low temperature, the picture may leave trails or appear slightly delayed. This is not a malfunction, and the unit will recover when the temperature returns to normal.

Do not leave the unit in a hot or cold location. Also, do not leave the unit in a location exposed to direct sunlight or near a heater, as this may cause the cabinet to deform and the LCD panel to malfunction.

(Storage temperature: 0°C to +50°C; Working temperature: 5°C to +40°C.)

Note:

If your problem is not solved, restart your TV by turning it off and then on again once.

Never attempt to repair a defective TV yourself.

Specifications

Type:	LCD TV
Display Size Diagonal:	32"
Power supply:	AC 100-240V 50/60Hz
Power Consumption:	140W
Dimensions:	937 (W) x 563 (D) x 242 (H) (mm)
Weight:	21kg
TV System:	PAL BG, NTSC (AV)

 **Design and specification are subject to change without notice.**

PALSONIC CORPORATION PTY LTD
1 JOYNTON AVENUE
WATERLOO NSW 2017 AUSTRALIA
TEL: (02) 9313 7111
FAX: (02) 9313 7555
www.palsonic.com.au

**PALSONIC CUSTOMER SERVICE
TELEPHONE
AUSTRALIA: 1300 657 888**

604-L32U53-01
V1.0

Free Manuals Download Website

<http://myh66.com>

<http://usermanuals.us>

<http://www.somanuals.com>

<http://www.4manuals.cc>

<http://www.manual-lib.com>

<http://www.404manual.com>

<http://www.luxmanual.com>

<http://aubethermostatmanual.com>

Golf course search by state

<http://golfingnear.com>

Email search by domain

<http://emailbydomain.com>

Auto manuals search

<http://auto.somanuals.com>

TV manuals search

<http://tv.somanuals.com>