

8 Operating Instructions

SAFETY PRECAUTIONS

Before operating, please read the following "Safety Precautions" carefully.

- To prevent personal injury, injury to others and property damage, the following instructions must be followed.
- Incorrect operation due to failure to follow instructions will cause harm or damage, the seriousness of which is classified as follow:

Warning
This sign warns of death or serious injury.

Caution
This sign warns of damage to property.

- The instructions to be followed are classified by the following symbols:

 This symbol (with a white background) denotes an action that is PROHIBITED.

 These symbols (with a black background) denote actions that are COMPULSORY.

Installation Precautions

Warning

- Do not install, remove and reinstall the unit by yourself.**
Improper installation will cause leakage, electric shock or fire. Please engage an authorized dealer or specialist for the installation work.

Caution

- This room air conditioner must be earthed.**
Improper grounding could cause electric shock.
- Ensure that the drainage piping is connected properly.**
Otherwise, water will leak out.
- Do not install the unit in a potentially explosive atmosphere.**
Gas leak near the unit could cause fire.

Operation Precautions

Warning
This sign warns of death or serious injury.

- Do not share outlet.
- Do not insert plug to operate the unit. Do not pull out plug to stop the unit.
- Do not operate with wet hands.
- Do not damage or modify the power cord.
- Do not insert finger or other objects into the indoor or outdoor units.
- Do not expose directly to cold air for a long period.

- Plug in properly.
- Use specified power cord.

- If abnormal condition (burnt smell, etc.) occurs, switch off and unplug the power supply.

Caution
This sign warns of injury.

- Do not pull the cord to disconnect the plug.
- Do not wash the unit with water.
- Do not use for other purposes such as preservation.
- Do not use any combustible equipment at airflow direction.
- Do not sit or place anything on the indoor or outdoor unit.

- Switch off the power supply before cleaning.
- Ventilate the room regularly.
- Pay attention as to whether the installation rack is damaged after long period of usage.

- Switch off the power supply if the unit is not used for a long period.

NAME OF EACH PART

Indoor Unit

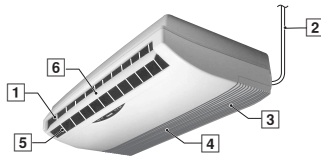

- 1 Air Outlet Vent
- 2 Power Supply Cord
- 3 Air Intake Vent
- 4 Air Filters (behind the panel)
- 5 Horizontal Airflow Direction Louver (manually adjusted)
- 6 Vertical Airflow Direction Louver

Indoor Unit Controls

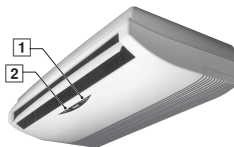

- 1 Operation Indication Lamps
- 2 Signal Receptor



- 1 Auto Operation Button
- 2 Power Mode Indicator - GREEN
- 3 Timer Mode Indicator - ORANGE
- 4 Sleep Mode Indicator - ORANGE
- 5 Air Swing Mode Indicator - ORANGE

Outdoor Unit

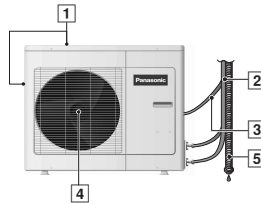

CU-V18CTP5, CU-V24CTP5
CU-A18CTP5, CU-A24CTP5

- 1 Air Intake Vents
- 2 Piping
- 3 Connecting Cable
- 4 Air Outlet Vents
- 5 Drain Hose



CU-V12CTP5
CU-A12CTP5

Accessories

Remote Control



Remote Control Indication Sticker

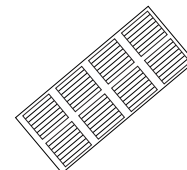

Remote Control Holder

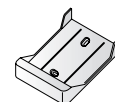

Two R03 (AAA) dry-cell batteries or equivalent



NAME OF EACH PART

Remote Control

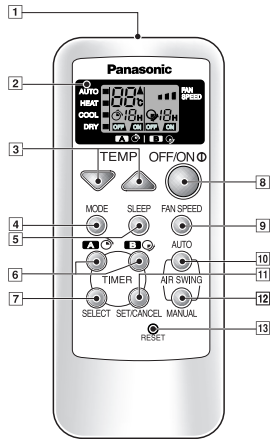

Remote Control Signal.

- Make sure it is not obstructed.
- Maximum distance : 10 m.
- Signal received sound.
One short beep or one long beep.

Notes for Remote Control.

- Do not throw or drop.
- Do not get it wet.
- Certain type of fluorescent lamps may affect signal reception. Consult your dealer.

- Do not place the remote control in a location exposed to direct sunlight, or next to a heating unit, or other heat source.

- 1 Signal Transmitter
- 2 Operation Display

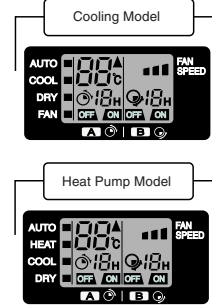

- 3 Room Temperature Setting Button (Illuminating button)
- 4 Operation Mode Selection Button
- 5 Sleep Mode Operation Button (Illuminating button)
- 6 Timer Setting Button
- 7 Timer Selection Button
- 8 OFF/ON Button (Illuminating button)
- 9 Fan Speed Selection Button
- 10 Auto Airflow Direction Button
- 11 Timer Set/Cancel Button
- 12 Manual Airflow Direction Selection Button
- 13 Reset Point (Press with fine-tipped object to clear the memory)

How to Insert the Batteries

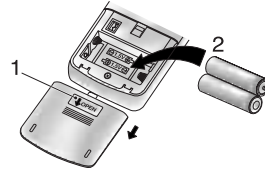

1 Gently press the place marked **OPEN** and slide the cover towards you.

2 Insert the batteries
- Be sure the direction is correct.

About the batteries

- Can be used for approximately one year.
- Observe the following when replacing the batteries
 - Replace with new batteries of the same type.
 - Do not use rechargeable batteries (Ni-Cd).
 - Remove the batteries if the unit is not going to be used for a long period.

Proper way to operate the remote control in the case of ceiling/wall mounting.

- Operate the remote control in parallel with the floor. (See the figure below)

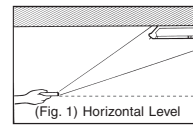

- The signal changes as shown in the figure below. It means that the receiving conditions are bad and the signal can not be controlled properly.

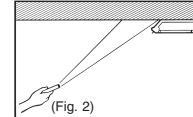

PREPARATION BEFORE OPERATION

Indoor Unit



- 1 Connect the power supply cord to an independent power supply.

HOW TO OPERATE

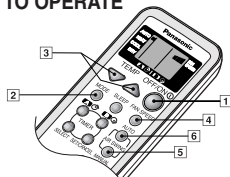

To start the operation

- Press [1].
- POWER indicator (green) on the indoor unit will light up.
- To stop, press once more.

Setting Mode

- Press [2] to select-

Cooling Model	
AUTO	- Automatic Operation
COOL	- Cooling Operation
DRY	- Soft Dry Operation
FAN	- Air Circulation Operation

Heat Pump Model	
AUTO	- Automatic Operation
HEAT	- Heating Operation
COOL	- Cooling Operation
DRY	- Soft Dry Operation

Setting Temperature

- Press [3] to increase or decrease the temperature.
- The temperature can be set between 16°C - 30°C
- Recommended temperature:

Cooling Model	Heat Pump Model
COOL → 26°C - 28°C	COOL → 26°C - 28°C
DRY → 1°C - 2°C lower than the room temperature	DRY → 1°C - 2°C lower than the room temperature
	HEAT → 20°C - 24°C

- During AUTO Operation, press [3] to select-
 - Hi: Operation with 2°C higher than the standard temperature.
 - : Operation with the standard temperature.
 - Lo: Operation with 2°C lower than the standard temperature.

Standard Temperature

Indoor temperature	Cooling Model		Standard temperature
	Operation	Standard temperature	
23°C	Cooling	25°C	25°C
	Soft Dry	22°C	

- Once the Automatic Operation is selected, the indoor temperature sensor operates automatically to select the desired operation mode with Cooling or Soft Dry.
- After the operation mode has been selected, the mode does not change.

Indoor temperature	Heat Pump Model		Standard temperature
	Operation	Standard temperature	
23°C	Cooling	25°C	25°C
	Soft Dry	22°C	
	Heating	21°C	

- At the beginning of the automatic operation, Heating, Cooling or Soft Dry is automatically selected according to the indoor temperature.
- After the operation mode has been selected, the mode does not change.

Operation Details

COOL - Cooling Operation

- To set the room temperature at your preference cooling comfort.

AUTO - Automatic Operation

- Sense indoor temperature to select the optimum mode.
- Temperature is not displayed on the remote control during AUTO operation.

DRY - Soft Dry Operation

- A very gentle Cooling Operation, prior to dehumidification. It does not lower the room temperature.
- During Soft Dry operation, the indoor fan operates at Low Fan Speed.

HEAT - Heating Operation

- (for Heat Pump Model only)
- Heat is obtained from outdoor air to warm up the room. When the outdoor ambient air temperature falls, the heating capacity of the unit might be reduced.
- Defrosting Operation
Depend on the outdoor temperature, the operation occasionally stops to melt the frost on the outdoor unit.

FAN - Air Circulation Operation

- (for Cooling Model only)
- Heated air rises and collects at the top of the room. The air circulation circulates the heated air downward, thus increasing heating effectiveness. When the unit is installed floor mounted, you should set the temperature higher than that of ceiling mounted.

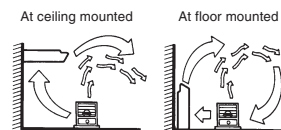

Setting the Fan Speed

- Press [4] to select:
 - FAN - Low Fan Speed
 - FAN - Medium Fan Speed
 - FAN - High Fan Speed
 - AUTO - Automatic Fan Speed
- The speed of the indoor fan is adjusted automatically according to the operation. The indoor fan stops occasionally during cooling operation.

Vertical Airflow Direction

- Manual Operation**
 - Press and hold the Manual Airflow Direction Selection Button [5], then release the button at the desired airflow direction.
- Cooling / Soft Dry/ Heating (for Heat-Pump Model only)**

The airflow direction can be adjusted as desired by using the remote control. This is effective when you want to cool yourself directly, such as when coming out of the bath. The louver can be adjusted within a range between the horizontal and 25 degrees downward at Cooling and Soft Dry Operation, and between the horizontal and 45 degrees downward at Heating Operation. (for Heat-Pump Model only)

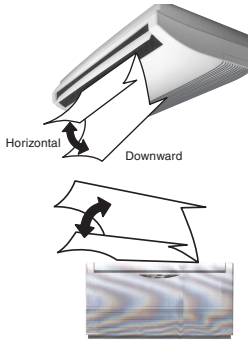

Automatic Operation

- Press the Auto Airflow Direction Button [6].
- Cooling / Soft Dry**

The louver will automatically swing up and down to create the feeling of a refreshing breeze.

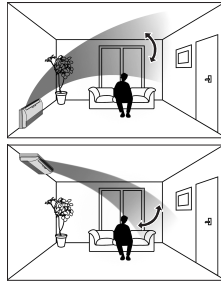

- Heating (for Heat-Pump Model only)**

When the discharge air temperature is low such as at starts of heating operation, the air blows at horizontal level. As the temperature rises, the hot air blows in a downwards direction.

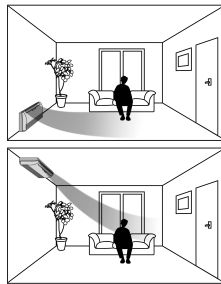

Setting the Horizontal Airflow Direction



- Adjust it manually
- Use this air conditioner under the following conditions:

Cooling Model		(Unit in °C)			
DBT: Dry Bulb Temp WBT: Wet Bulb Temp	Indoor		Outdoor		
	DBT	WBT	DBT	WBT	
Maximum Temperature	32	23	43	26	
Minimum Temperature	16	11	16	11	

Heat Pump Model		(Unit in °C)			
DBT: Dry Bulb Temp WBT: Wet Bulb Temp	Indoor		Outdoor		
	DBT	WBT	DBT	WBT	
Maximum Temperature-Cooling (Maximum Temperature-Heating)	32 (30)	23 (-)	43 (24)	26 (18)	
Minimum Temperature-Cooling (Minimum Temperature-Heating)	16 (16)	11 (-)	16 (-5)	11 (-6)	

- Notes**
 - If the unit is not going to be used for an extended period of time, turn off the main power supply. If it is left at the ON position, approximately 2.0 W of electricity will be used even if the indoor unit has been turned off with the remote control.
 - If operation is stopped, then restart immediately, the unit will resume operation only after 3 minutes.

SETTING THE TIMER

- Press the Timer Selection Button [1].
- Timer indicator on the indoor unit will light up.
- Select one of the following five types of operation. Each time the button is pressed, the operation mode is shifted in the arrow direction.

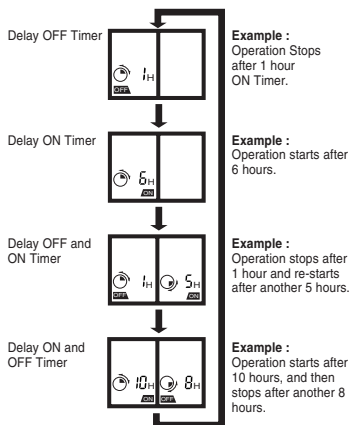

- Then press the Timer Setting Button [2] or [3] to the desired number of hours. (Number of hours which can be set : 1 - 12)
- Press the Timer Set/Cancel Button [4].

CONVENIENCE OPERATION

- Sleep Mode Operation**
 - To obtain a comfortable room temperature while sleeping:
 - Press [5].
 - Sleep mode indicator on the indoor unit will light up.
 - To cancel this operation, press once more.
- Sleep Mode Operation Details**
 - When the room temperature reaches the set temperature, the airflow volume will change to low automatically.
 - Sleep Mode Operation time is 8 hours.
 - When used together with the timer, the timer has a priority.

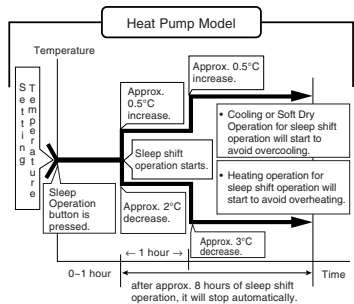
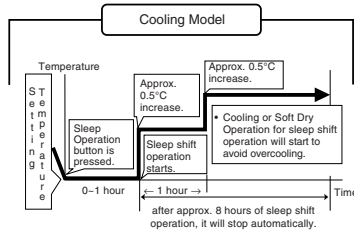

CARE AND MAINTENANCE

- Cleaning the Indoor Unit and Remote Control**
 - Wipe gently with a soft, dry cloth.
 - Do not use water hotter than 40°C or polishing fluid to clean the unit.
- Cleaning the Air Filter**

(Recommendation:- If the unit is operated in a dusty environment, clean the filters every two weeks, continuous use of this dirty filters will reduce cooling or heating efficiency)

 - Remove dirt using a vacuum cleaner.
 - Wash back of the air filter with water.
 - If badly soiled, wash it with soap or a mild household detergent.
 - Let it dry and reinstall it. Be sure the "FRONT" mark is facing you.
 - ⊗ Damaged air filter. Consult the nearest authorized dealer. Part No.: CWD001088.
 - Do not use benzene, thinner, scouring powder or clothes soaked in caustic chemical to clean the unit.

Pre-season Inspection

- Clean the air filters, re-insert and operate the air conditioners.

- **Is the discharged air cold / warm?**
Operation is normal if 15 minutes after the start of operation, the difference between the air intake and outlet vents temperature is:-

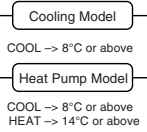

- **Are the air intake or outlet vents of the indoor or outdoor units obstructed?**

- **Are the remote control batteries weak?**
If the remote control display appears weak, replace the batteries.

When the Air Conditioner is Not Used for an Extended Period of Time

- 1 To dry the internal parts of the indoor unit, operate the unit for 2 - 3 hours using:-

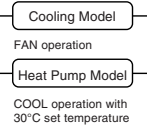

- 2 Turn off the power supply and unplug.

- 3 Remove the remote control batteries.

Recommended Inspection

- After used over several seasons, the unit will become dirty and thus decreases the unit's performance. Depending on the operation conditions, a dirty unit may produce odour and dust may pollute dehumidification system. Therefore, a seasonal inspection is recommended in addition to regular cleaning. (Consult an authorized dealer).

HELPFUL INFORMATION

Auto Operation

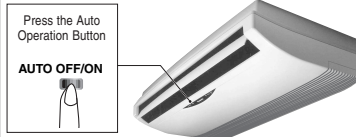

- **Automatic Operation**
 - If the remote control fails to function or has been misplaced, press the Auto Operation button to start the Automatic operation.
 - The Automatic operation will be activated immediately once the Auto operation button is pressed. However, temperature cannot be adjusted in this operation.
 - The power indicator on the indoor unit will blink until the operation mode is selected automatically.
 - To cancel this operation, press once more.

- **Timer Setting**
 - When power failure occurs, the timer setting will be cancelled. Once power is resumed, reset the timer.

- **Thunder and Lightning**
 - This air conditioner is equipped with a built-in surge protective device. However, in order to further protect your air conditioner from being damaged by abnormally strong lightning activity, you may switch off the main power supply and unplug from power socket.

- **Auto Restart Control**
 - If power is resumed after a power failure, the operation will restart automatically after 3 - 4 minutes.
 - Operation will be restarted automatically under the previous operation mode and airflow direction when power is resumed as the operation is not stopped by the remote control.

ENERGY SAVING AND OPERATION HINTS

- **Setting the Temperature**
 - Approximately 10% of electricity can be saved.
 - Set the temperature higher or lower than the desired temperature.

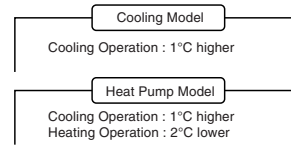

- **Air Filters**
 - Clean the air filters every 2 weeks.
 - Dirty filters may reduce cooling or heating efficiency.
- **Keep All Doors and Windows Closed**
 - Otherwise, cooling or heating performance will be reduced and electricity cost is wasted.
- **Outdoor Unit**
 - Do not block the air outlet vents. Otherwise, it will lower the cooling or heating performance.
- **Timer and Sleep Mode**
 - To prevent wastage of electricity, use sleep mode when sleeping or Timer when going out.
- **Avoid Direct Sunlight**
 - Keep curtains or drapes closed to avoid direct sunlight during cooling operation.

TROUBLESHOOTING

Normal Operation

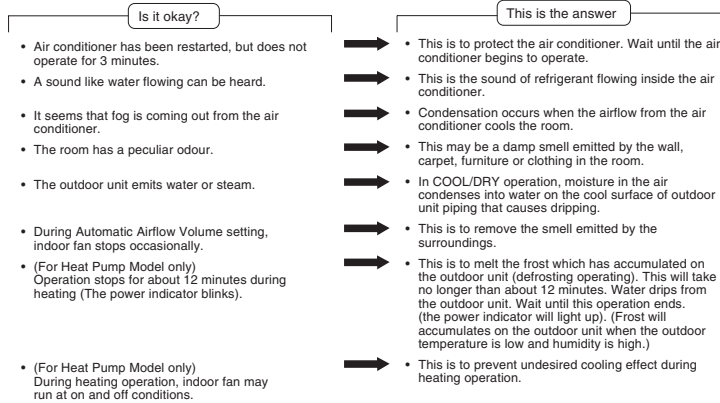

Abnormal Operation

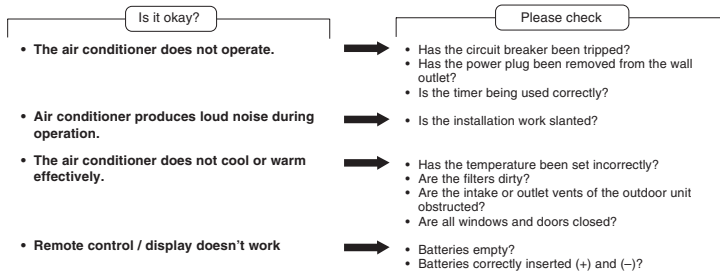

Call the Dealer Immediately

If the following conditions occur, turn off and unplug the main power supply, and then call the dealer immediately.

- **Abnormal noise is heard during operation.**
- **Water or foreign material gets into the remote control by mistake.**
- **Water leak from the indoor unit.**
- **Switches or buttons do not operate properly.**
- **The circuit breaker switches off frequently.**
- **Power supply cord and plug become unusually warm.**



Free Manuals Download Website

<http://myh66.com>

<http://usermanuals.us>

<http://www.somanuals.com>

<http://www.4manuals.cc>

<http://www.manual-lib.com>

<http://www.404manual.com>

<http://www.luxmanual.com>

<http://aubethermostatmanual.com>

Golf course search by state

<http://golfingnear.com>

Email search by domain

<http://emailbydomain.com>

Auto manuals search

<http://auto.somanuals.com>

TV manuals search

<http://tv.somanuals.com>