

Panasonic®

Operating Instructions Air Conditioner



Indoor Unit	Outdoor Unit
CS-PC30JKF	CU-PC30JKF
CS-PC36JKF	CU-PC36JKF



٧ ~ ٢

عربي

يرجى قراءة تعليمات التشغيل بعناية
تامة قبل تشغيل مكيف الهواء، واحفظ
هذا الكتيب كمرجع في المستقبل.

ENGLISH

8 ~ 13

Before operating the unit, read these
operating instructions thoroughly and
keep them for future reference.



دليل سريع

QUICK GUIDE

© Panasonic HA Air-Conditioning (M) Sdn. Bhd. 2008.
Unauthorized copying and distribution is a violation
of law.

SAFETY PRECAUTIONS

DEFINITION

The instructions to be followed are classified by the following symbols:



This symbol denotes an action that is **PROHIBITED**.



These symbols denote actions that are **COMPULSORY**.

To prevent personal injury, injury to others, or property damage, please observe the following.

Incorrect operation due to failure to follow instructions may cause harm or damage, the seriousness of which is classified as below:



Warning This sign warns of death or serious injury.



Caution This sign warns of injury or damage to property.

Remote Control



- Do not use rechargeable (Ni-Cd) batteries.
- Do not allow infants and small children to play with the remote control to prevent them from accidentally swallowing the batteries.



- Remove the batteries if the unit is not going to be used for a long period of time.
- New batteries of the same type must be inserted following the polarity stated to prevent malfunction of the remote control.

Indoor Unit



- Do not install, remove and reinstall the unit by yourself; improper installation will cause leakage, electric shock or fire. Please consult authorized dealer or specialist for the installation work.
- Do not insert your fingers or other objects into the unit, rotating parts may cause injury.
- Do not attempt to repair the unit by yourself.

Indoor Unit



- Do not install the unit in a potentially explosive atmosphere.
- Do not wash the unit with water, benzene, thinner or scouring powder.
- Do not use for other purposes such as preservation of food.
- Do not use any combustible equipment in front of the airflow outlet.
- Do not expose directly to cold air for a long period.
- Ensure that the drainage pipe is connected properly. Otherwise, leakage may occur.
- Aerate the room regularly.



Power Supply



- Do not share the same power outlet with other equipment.
- Do not modify power cords.
- Do not use extension cords.
- Do not operate with wet hands.



- Use the specified supply cord.
- If the supply cord is damaged, it must be replaced by the manufacturer, its service agent or similarly qualified persons in order to avoid a hazard.



- This equipment must be earthed and strongly recommended to be installed with Earth Leakage Circuit Breaker (ELCB) or Residual Current Device (RCD). Otherwise, it may cause electrical shock or fire in case of malfunction.



- In case of emergency or abnormal conditions (burnt smell, etc), turn off the power supply, and please consult authorized dealer.

Power Supply



- Switch off the power supply before cleaning or servicing.
- Turn off the power supply if the unit is not used for a long period of time.
- This air conditioner is equipped with a built-in surge protective device. However, in order to further protect your air conditioner from being damaged by abnormally strong lightning activity, you may want to disconnect it from the power supply. Do not touch the air conditioner during lightning, it may cause electric shock.

Outdoor Unit



- Do not insert your fingers or other objects into the unit, rotating parts may cause injury.

Outdoor Unit



- Do not sit or step on the unit, you may fall down accidentally.



- Do not touch the sharp aluminum fin, sharp parts may cause injury.



- After long periods of use, make sure the installation rack is not damaged.

REGULATORY INFORMATION

Thank you for purchasing
Panasonic Air Conditioner

This appliance is not intended for use by persons (including children) with reduced physical, sensory or mental capabilities, or lack of experience and knowledge, unless they have been given supervision or instruction concerning use of the appliance by a person responsible for their safety. Children should be supervised to ensure that they do not play with the appliance.

OPERATION CONDITION

Use this air conditioner under the following temperature range
(CU-PC30JKF)

Temperature (°C)		Indoor		Outdoor	
		*DBT	*WBT	*DBT	*WBT
COOLING	Maximum	32	23	55	31
	Minimum	16	11	16	11

(CU-PC36JKF)

Temperature (°C)		Indoor		Outdoor	
		*DBT	*WBT	*DBT	*WBT
COOLING	Maximum	32	23	52	31
	Minimum	16	11	16	11

*DBT: Dry bulb temperature

*WBT: Wet bulb temperature

TABLE OF CONTENTS

SAFETY PRECAUTIONS	8
REGULATORY INFORMATION	9
PRODUCT OVERVIEW & OPERATIONS	10~11
CARE & CLEANING	12
TROUBLESHOOTING	13
QUICK GUIDE	BACK COVER

ENGLISH

NOTE :

The illustrations in this manual are for explanation purposes only and may differ from the actual unit. It is subjected to change without notice for future improvement.

Information for Users on Collection and Disposal of Old Equipment and used Batteries



[Information on Disposal in other Countries outside the European Union]

These symbols are only valid in the European Union. If you wish to discard these items, please contact your local authorities or dealer and ask for the correct method of disposal.



Note for the battery symbol (bottom two symbol examples):

This symbol might be used in combination with a chemical symbol. In this case it complies with the requirement set by the Directive for the chemical involved.



- Do not switch ON the unit when waxing the floor. After waxing, aerate the room properly before operating the unit.
- Do not install the unit in oily and smoky areas.

PRODUCT OVERVIEW & OPERATIONS

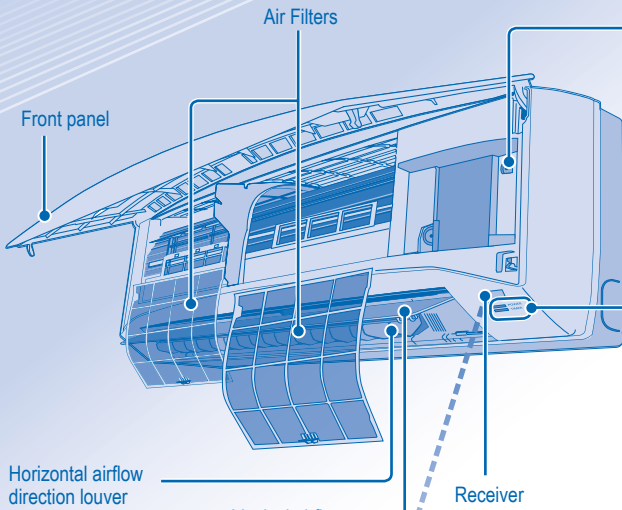

Horizontal airflow direction louver
 • Manually adjustable.



Vertical airflow direction louver
 • Do not adjust by hand.

Auto OFF/ON button

- Used when remote control is misplaced or malfunction.

Action	Mode
Press once.	Auto
Press and hold until 1 beep is heard, then release.	Cooling
Press the button to turn off.	

INDICATOR

- POWER (Green)
- TIMER (Orange)

Maximum distances: 8m

Remote control display



OFF/ON 

TO TURN ON OR OFF THE UNIT

- Please be aware of the OFF indication on the remote control display to prevent the unit from starting/stopping improperly.



TO SET TEMPERATURE

- Selection range : 16°C ~ 30°C.
- Operating the unit within the recommended temperature could induce energy saving.
COOL mode : 26°C ~ 28°C.
DRY mode : 1°C ~ 2°C lower than room temperature.

MODE 

TO SELECT OPERATION MODE

AUTO mode - For your convenience

- Unit selects the operation mode according to the room temperature.

COOL mode - To enjoy cool air

DRY mode - To dehumidify the environment

- Unit operates at low fan speed to give a gentle cooling operation.

FAN SPEED 

TO SELECT FAN SPEED (3 OPTIONS)



- For AUTO, the indoor fan speed is automatically adjusted according to the operation mode.

AIR SWING 

TO ADJUST VERTICAL AIRFLOW DIRECTION (4 OPTIONS)





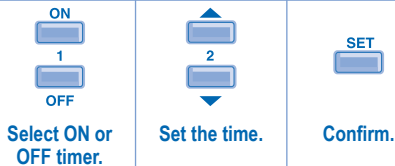

- Keeps the room ventilated.
- If AUTO is set, the louvers swing up/down automatically.

TO SET THE TIMER

- To turn ON or OFF the unit at a preset time.



- To cancel ON or OFF timer, press  or  then press .

- When ON Timer is set, the unit may start earlier (up to 15 minutes) before the actual set time in order to achieve the desired temperature on time.
- Timer operation is based on the clock set in the remote control and repeats daily once set. For clock setting, please refer to Remote Control Preparation at back cover.
- If timer is cancelled manually or due to power failure, you can restore the previous setting (once power is resumed) by pressing .

OPTIONAL SETTINGS

 Press and hold for approximately 10 seconds to show temperature setting in °C or °F.

 Press and hold for approximately 5 seconds to show 12-hour (am/pm) or 24-hour time indication.

 Press to restore the remote control's default setting.

Use curtains to screen off sunlight and outdoor heat to reduce power consumption during cool mode.

CARE & CLEANING



CAUTION

- **Switch off the power supply before cleaning.**
- **Do not touch the aluminium fin, sharp parts may cause injury.**

WASHING INSTRUCTIONS

- Do not use benzene, thinner or scouring powder.
- Use only soap (\approx pH7) or neutral household detergent.
- Do not use water hotter than 40°C.

HINT

- To ensure optimal performance of the unit, cleaning maintenance have to be carried out at regular intervals. Please consult authorized dealer.

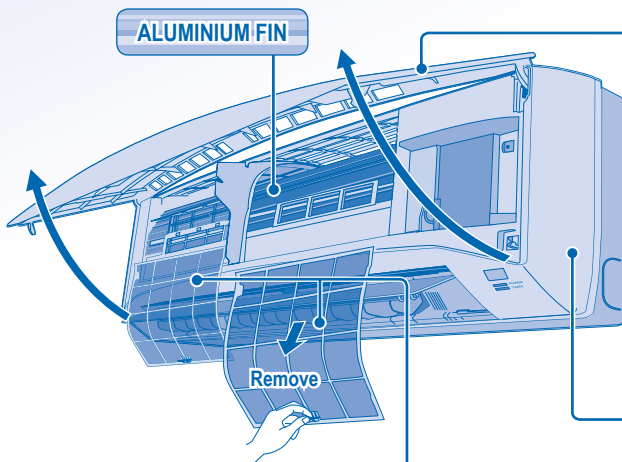

FRONT PANEL

Remove Front Panel

- Raise and pull to remove the front panel.
- Wash gently and dry.

Close Front Panel



- Press down both ends of the front panel to close it securely.

INDOOR UNIT

Wipe the unit gently with a soft, dry cloth.

AIR FILTERS

- Air filters cleaning is needed every two weeks.
- Wash/rinse the filter gently with water to avoid damage to the filter surface.
- Dry the filters thoroughly under the shade, away from fire or direct sunlight.
- Replace any damaged filter.

FOR SEASONAL INSPECTION AFTER EXTENDED NON-USE

- Checking of remote control batteries.
- No obstruction at air inlet and air outlet vents.
- After 15 minutes of operation, it is normal to have the following temperature difference between air inlet and air outlet vents:
Cooling: $\geq 8^{\circ}\text{C}$

FOR EXTENDED NON-USE

- Turn off the power supply.
- Remove the remote control batteries.

NON SERVICEABLE CRITERIAS

TURN OFF POWER SUPPLY then please consult authorized dealer under the following conditions:

- Abnormal noise during operation.
- Water/foreign particles have entered the remote control.
- Water leaks from Indoor unit.
- Circuit breaker switches off frequently.
- Power cord becomes unnaturally warm.
- Switches or buttons are not functioning properly.

TROUBLESHOOTING

The following symptoms do not indicate malfunction.

Symptom	Cause
Mist emerges from indoor unit.	<ul style="list-style-type: none">• Condensation effect due to cooling process.
Water flowing sound during operation.	<ul style="list-style-type: none">• Refrigerant flow inside the unit.
The room has a peculiar odour.	<ul style="list-style-type: none">• This may due to damp smell emitted by the wall, carpet, furniture or clothing.
Indoor fan stops occasionally during automatic fan speed setting.	<ul style="list-style-type: none">• This helps to remove the surrounding odours.
Operation is delayed a few minutes after restart.	<ul style="list-style-type: none">• The delay is a protection to the unit's compressor.
Outdoor unit emits water/steam.	<ul style="list-style-type: none">• Condensation or evaporation occurs on pipes.
Timer indicator is always on.	<ul style="list-style-type: none">• The timer setting repeats daily once set.
Cracking sound during operation.	<ul style="list-style-type: none">• Changes of temperature cause the expansion/contraction of the unit.

Check the following before calling for servicing.

Symptom	Check
Cooling operation is not working efficiently.	<ul style="list-style-type: none">• Set the temperature correctly.• Close all doors and windows.• Clean or replace the filters.• Clear any obstruction at the air inlet and air outlet vents.
Noisy during operation.	<ul style="list-style-type: none">• Check if the unit has been installed at an incline.• Close the front panel properly.
Remote control does not work. (Display is dim or transmission signal is weak.)	<ul style="list-style-type: none">• Insert the batteries correctly.• Replace weak batteries.
The unit does not work.	<ul style="list-style-type: none">• Check if the circuit breaker is tripped.• Check if timers have been set.
The unit does not receive the signal from the remote control.	<ul style="list-style-type: none">• Make sure the receiver not obstructed.• Certain fluorescent lights may interfere with signal transmitter. Please consult authorized dealer.

تخضير وحدة التحكم عن بعد • Remote Control Preparation

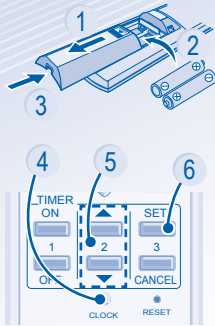

- 1 اسحب • Pull out
- 2 ادخل بطاريات AAA أو R03 (يمكن استخدامها لمدة سنة واحدة) • Insert AAA or R03 batteries (can be used ~ 1 year)
- 3 اغلق الغطاء • Close the cover
- 4 اضغط CLOCK • Press CLOCK
- 5 اضبط الوقت • Set time
- 6 تأكد • Confirm

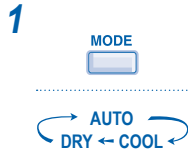
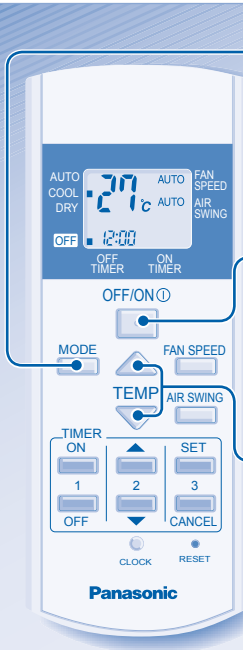

اختيار الوضع المرغوب.
Select the desired mode.



بدء/ايقاف التشغيل.
Start/stop the operation.



اختيار درجة الحرارة المرغوبة.
Select the desired temperature.

Free Manuals Download Website

<http://myh66.com>

<http://usermanuals.us>

<http://www.somanuals.com>

<http://www.4manuals.cc>

<http://www.manual-lib.com>

<http://www.404manual.com>

<http://www.luxmanual.com>

<http://aubethermostatmanual.com>

Golf course search by state

<http://golfingnear.com>

Email search by domain

<http://emailbydomain.com>

Auto manuals search

<http://auto.somanuals.com>

TV manuals search

<http://tv.somanuals.com>