

Panasonic

Compact Plain Paper Fax with 2.4GHz Cordless
and Answering System

Operating Instructions

Model No. **KX-FC175AL**

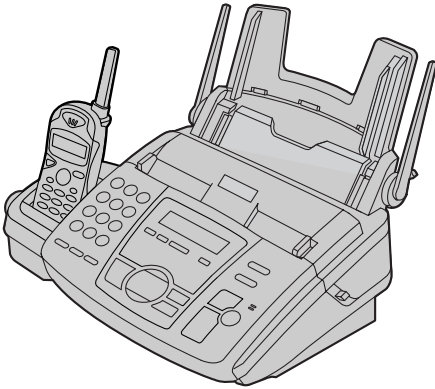

Please read these Operating Instructions before using the unit and save for future reference.

This model is designed to be used in Australia and New Zealand.
**TO USE IN NEW ZEALAND,
CHANGE THE LOCALE SETTING
(feature #74 on page 77).**

Thank you for purchasing a Panasonic facsimile.

Things you should keep a record of

Attach your sales receipt here

For your future reference

Date of purchase

Serial number

(found on the rear of the unit)

Dealer's name and address

Dealer's telephone number

This model is designed to be used in Australia and New Zealand according to the locale setting feature.

The default setting is Australia. To use in New Zealand, change the setting (feature #74 on page 77).

Caution:

- Note that the images of copied or received documents will remain on the used ink film. Use discretion when disposing of the used ink film.
- Do not rub or use an eraser on the printed side of recording paper, as the print may smear.
- This model is designed for the Australian and New Zealand network.

Copyright:

This manual is copyrighted by Kyushu Matsushita Electric Co., Ltd. (KME) and its licensee. Under the copyright laws, this manual may not be reproduced in any form, in whole or part, without the prior written consent of KME and its licensee.

© Kyushu Matsushita Electric Co., Ltd. 2001

For Australian users

Warning:

- This equipment will be inoperable when mains power fails.
- When a failure occurs which results in the internal parts becoming accessible, disconnect the power supply cord immediately and return this unit to an authorised service centre.
- Disconnect the telephone connection before disconnecting power connection prior to relocating the equipment, and reconnect the power first.
- To minimize the possibility of lightning damage, when you know that a thunderstorm is coming, we recommend that you:
 - A. Unplug the telephone line cord from the phone jack.
 - B. Unplug the power supply cord from the AC power outlet.
- No "000" or other calls can be made from this device during a mains power failure.
- The earcap on the handset is magnetised and may retain metallic.

For New Zealand users

Warning:

- WHEN A FAILURE OCCURS WHICH RESULTS IN THE INTERNAL PARTS BECOMING ACCESSIBLE, DISCONNECT THE POWER SUPPLY CORD IMMEDIATELY AND RETURN THIS UNIT TO AN AUTHORISED SERVICE CENTRE.
- DISCONNECT THE TELECOM CONNECTION BEFORE DISCONNECTING THE POWER CONNECTION PRIOR TO RELOCATING THE EQUIPMENT, AND RECONNECT THE POWER FIRST.
- NO "111" OR OTHER CALLS CAN BE MADE FROM THIS DEVICE DURING A MAINS POWER FAILURE.

IMPORTANT NOTICE

Under power failure conditions, this telephone may not operate. Please ensure that a separate telephone, not dependent on local power, is available for emergency use.

Notice:

- The grant of a Telepermit for any item of terminal equipment indicates only that Telecom has accepted that the item complies with minimum conditions for connection to its network. It indicates no endorsement of the product by Telecom, nor does it provide any sort of warranty. Above all, it provides no assurance that any item will work correctly in all respects with another item of Telepermitted equipment of a different make or model, nor does it imply that any product is compatible with all of Telecom's network services.
- This equipment shall not be set to make automatic calls to the Telecom "111" Emergency Service.
- This equipment should not be used under any circumstances which may constitute a nuisance to other Telecom customers.
- Not all telephones will respond to incoming ringing when connected to the extension socket.
- This equipment may not provide for the effective hand-over of a call to another device connected to the same line.

Important information (for Australian users)

Instructions to customer

Installation

Attached to this apparatus is an approval label. This label is evidence that it is a "Permitted Attachment" which has been authorised to be connected to your telephone service.

Conditions relating to connection and operation of this Permitted Attachment are contained in Telecommunications General By-Law 220 (5).

You are authorised to install this Permitted Attachment yourself by plugging it into the line socket of any regular telephone. You may connect it in place of your existing telephone or to any spare telephone socket installed in your premises.

To disconnect your existing telephone you must first remove its plug from the line socket. You can then insert the plug of your Permitted Attachment into the socket and use your equipment.

If the plug of your existing telephone cannot be readily removed, you will have to remove the screw securing it. To do this proceed as follows:

1. Loosen screw "A" sufficiently to remove the socket cover. (See Fig. 1.)
2. Remove screw "B" and withdraw the plug. (See Fig. 2.)
3. Replace screw "B". (See Fig. 3.) Ensure that it screws completely into the socket recess. (If the screw is too long, increase the hole depth or replace the screw with one 5 mm shorter.)
4. Replace socket cover and tighten screw "A". (See Fig. 4.)

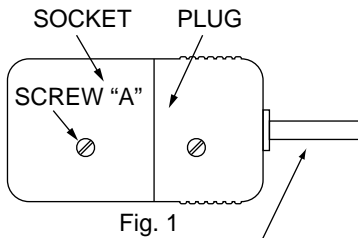

Fig. 1

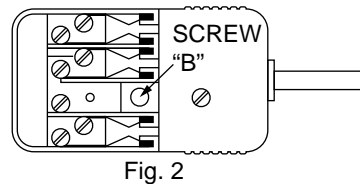

Fig. 2

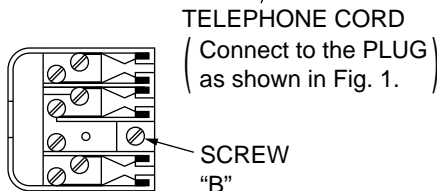

Fig. 3

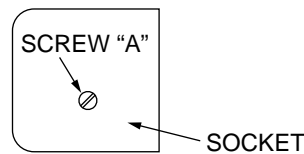

Fig. 4

If you are satisfied with the operation of your telephone service after plugging in your Permitted Attachment, your installation is completed.

You will be unable to connect this Permitted Attachment if your telephone service consists only of a wall phone or an old style telephone which is not connected by means of a modern plug and socket. In such cases a new socket will need to be installed.

Should the Permitted Attachment not operate when plugged into a socket, it is either faulty or unsuitable for operation with your telephone service. It should be returned to the store where purchased.

Service difficulties

If at any time a fault occurs on your telephone service carry out the following checks before you call for service:

- Disconnect the Permitted Attachment and try using the service with the normal telephone.
- If the telephone service then operates satisfactorily, the fault is in your Permitted Attachment. Leave the Permitted Attachment disconnected and report the fault to its supplier or agent to arrange for repair.
- If when using the telephone the service is still faulty, report the fault to "Service Difficulties and Faults" for attention.

You are required to keep this Permitted Attachment in good working order while it is connected to your telephone service. Its construction or internal circuit must not be modified in any way without permission.

For best performance

Battery charge

Lay the handset in the cradle of the base unit for about **6 hours** before initial use.

- A beep will sound, and the following will be displayed for an instant on the base unit.

Base unit display:

CHARGING

↓
The display will show the date and time.

- For further details, see page 22.

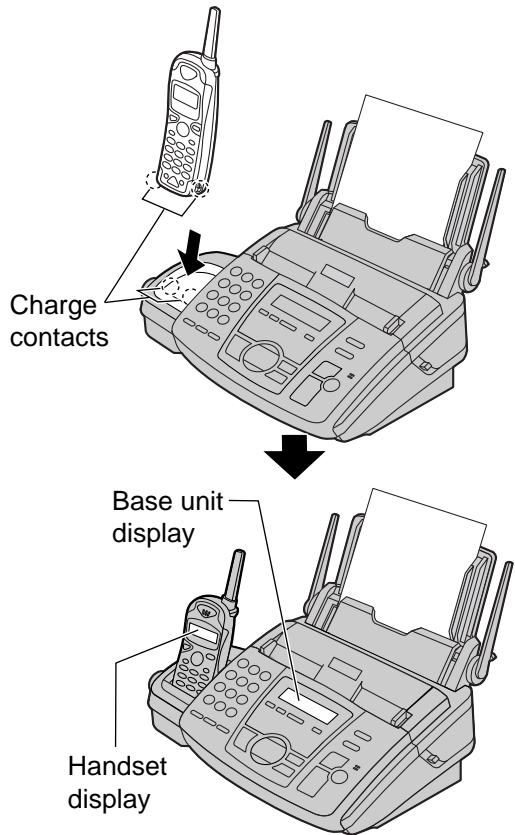

Operating distance and noise

Calls are transmitted between the base unit and the handset using wireless radio waves.

For maximum distance and noise-free operation, the recommended base unit location is:

Away from electrical appliances such as a TV, personal computer or another cordless phone.

In a **HIGH** and **CENTRAL** location with no obstructions such as walls.

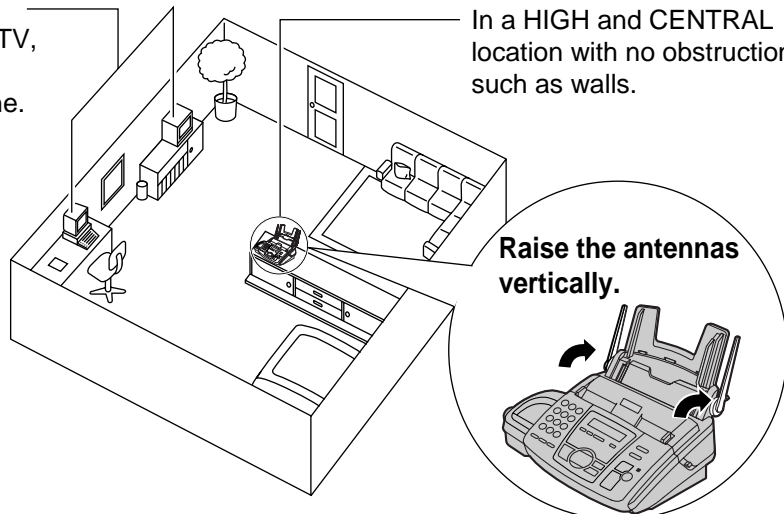

Note:

- If you are using the handset near a microwave oven which is in use, noise may be heard from the receiver. Move away from the microwave oven and closer to the base unit.
- If more than one cordless phone is being used and your handset is near another cordless phone's base unit, noise may be heard. Move away from the other cordless phone's base unit and closer to your base unit.

Safety instructions

Important safety instructions

When using this unit, basic safety precautions should always be followed to reduce the risk of fire, electric shock, or personal injury.

1. Read and understand all instructions.
2. Follow all warnings and instructions marked on this unit.
3. Unplug this unit from power outlets before cleaning. Do not use liquid or aerosol cleaners. Use a damp cloth for cleaning.
4. Do not use this unit near water, for example near a bath tub, wash bowl, kitchen sink, or the like.
5. Place the unit securely on a stable surface. Serious damage and/or injury may result if the unit falls.
6. Do not cover slots and openings on the unit. They are provided for ventilation and protection against overheating. Never place the unit near radiators, or in a place where proper ventilation is not provided.
7. Use only the power source marked on the unit. If you are not sure of the type of power supplied to your home, consult your dealer or local power company.
8. For safety purposes this unit is equipped with a grounded plug. If you do not have this type of outlet, please have one installed. Do not defeat this safety feature by tampering with the plug.
9. Do not place objects on the power cord. Install the unit where no one can step or trip on the cord.
10. Do not overload wall outlets and extension cords. This can result in the risk of fire or electric shock.
11. Never push any objects through slots in this unit. This may result in the risk of fire or electric shock. Never spill any liquid on the unit.
12. To reduce the risk of electric shock, do not disassemble this unit. Take the unit to an authorised service centre when service is required. Opening or removing covers may expose you to dangerous voltages or other risks. Incorrect reassembly can cause electric shock when the unit is subsequently used.
13. Unplug this unit from the wall outlet and refer servicing to an authorised service centre when the following conditions occur:
 - A. When the power supply cord or plug is damaged or frayed.

- B. If liquid has been spilled into the unit.
 - C. If the unit has been exposed to rain or water.
 - D. If the unit does not work normally by following the operating instructions. Adjust only controls covered by the operating instructions. Improper adjustment may require extensive work by an authorised service centre.
 - E. If the unit has been dropped or physically damaged.
 - F. If the unit exhibits a distinct change in performance.
14. During thunderstorms, avoid using telephones except cordless types. There may be a remote risk of an electric shock from lightning.
 15. Do not use this unit to report a gas leak, when in the vicinity of the leak.

SAVE THESE INSTRUCTIONS

INSTALLATION:

- Never install telephone wiring during a lightning storm.
- Never install telephone jacks in wet locations unless the jack is specifically designed for wet locations.
- Never touch uninsulated telephone wires or terminals unless the telephone line has been disconnected at the network interface.
- Use caution when installing or modifying telephone lines.

WARNING:

- To prevent the risk of fire or electrical shock, do not expose this product to rain or any type of moisture.

OTHER INFORMATION:

- Keep the unit away from electrical noise generating devices, such as fluorescent lamps and motors.
- The unit should be kept free from dust, high temperature and vibration.
- The unit should not be exposed to direct sunlight.
- Do not place heavy objects on top of this unit.
- Do not touch the plug with wet hands.

CAUTION:

Battery

To reduce the risk of fire or injury to persons, read and follow these instructions.

- Use only the battery(ies) specified.
- Do not dispose of the battery(ies) in a fire. They may explode. Check with local waste management codes for special disposal instructions.
- Do not open or mutilate the battery(ies). Released electrolyte is corrosive and may cause burns or injury to the eyes or skin. The electrolyte may be toxic if swallowed.
- Exercise care in handling batteries in order not to short the battery to conductive materials such as rings, bracelets, and keys. The battery and/or conductor may overheat and cause burns.
- Charge the battery(ies) provided with or identified for use with this product only in accordance with the instructions and limitations specified in this manual.

Splash-resistant (Handset only)

The handset is designed to be splash resistant and you can use the handset with wet hands, but please note the following:

- Do not immerse in water or leave under running water.
- Keep the handset away from salt water.
- Avoid exposure to prolonged high humidity.
- Since water in headset jack may cause damage, close the headset jack cover when the optional headset is not in use. When the optional headset is connected, do not use the handset with wet hands.
- If the handset is wet, wipe with a soft dry cloth.
- The base unit is not designed to be splash resistant. Do not place the wet handset on the base unit.

Shock-resistant (Handset only)

Although the handset is designed to be shock resistant, do not throw or step on the handset.

NOTICE:

- Operating near 2.4GHz electrical appliances may cause interference. Move away from the electrical appliances and/or press the CH (Channel) button.
- Consult the manufacturer of any personal medical devices, such as pacemakers, to determine if they are adequately shielded from external RF (radio frequency) energy. (The unit operates in the frequency range of 2.4015GHz to 2.4705GHz, and the power output level can range from 0.001 watts to 0.20 watts.) Do not use the unit in health care facilities if any regulations posted in the area instruct you not to do so. Hospitals or health care facilities may be using equipment that could be sensitive to external RF (radio frequency) energy.

Table of Contents

Initial Preparation

Accessories	Included accessories	10
	Accessory information	10
Help Button	Help function	11
Finding the Controls (Base Unit)	Overview	11
	Location.	12
Setup (Base Unit)	Ink film – installing / replacing	13
	Paper tray	15
	Recording paper	15
	Connections.	16
	Date and time, your logo and facsimile telephone number.	17
Setup (Handset)	Location.	21
	Belt clip and headset	21
	Battery charge.	22
Volume	Adjusting handset volume	23
	Adjusting base unit volume	23

Telephone

Making and Answering Calls	Phone calls - making.	24
	Phone calls - answering	25
	Intercom	26
	Transferring a call	27
Navigator Directory	Storing names and telephone numbers into the directory.	28
	Editing a stored item	30
	Erasing a stored item	31
	Making a phone call using the directory.	32
Caller ID	Caller ID service from your phone company	33
	Viewing and calling back using caller information	34
	Erasing caller information	36
	Storing caller information	38
Voice Contact	Talking to the other party after fax transmission or reception	39

Fax

Sending Faxes	Sending a fax manually.	40
	Documents you can send	41
	Sending a fax using the directory	42
	Broadcast transmission	43
Receiving Faxes	Setting the unit to receive faxes	46
	TEL mode (answering all calls manually)	48
	FAX ONLY mode (all calls are received as faxes)	49
	TEL/FAX mode (receiving phone calls with ring signals and faxes without ring signals when you are near the unit).	50
	Extension telephone	52
	Pager call - when the unit receives a fax or voice message	52
	Receive polling (retrieving a fax placed on another fax machine).	53
Distinctive Ring	Using with the ring detection feature	53

Copy

Copying	Making a copy	54
----------------	-------------------------	----

Answering Device

Setup	TAD/FAX mode (receiving phone calls and faxes automatically)	56
Greeting	Recording your own greeting messages	57
	Erasing your own recorded greeting messages	58
Memo Message	Leaving a message for others or yourself	58
Incoming Messages	Listening to recorded messages using the base unit	59
	Listening to recorded messages using the handset	60
Remote Operation	Operating from a remote location	61
Voice Mailbox	How callers can leave you private messages.	64
	Recording your own mailbox greeting messages	65
	Listening to recorded messages using the base unit	66
	Listening to recorded messages using the handset	67
	Listening to recorded messages from a remote location.	67
Option	Transferring recorded messages to another telephone	68

Programmable Features

Features Summary	Programming	69
	Basic features	70
	Advanced features	72

Help







Error Messages	Reports	78
	Display	79
Operations	When a function does not work, check here before requesting help	81
	If a power failure occurs	85
Jams	Recording paper jam.	86
	Document jams – sending.	87
Battery	Replacing the handset battery	87
Cleaning	Document feeder	88
	Thermal head	88

General Information

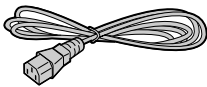
Printed Reports	Reference lists and reports	90
Specifications	Technical data about this product	91
Index	Program index	93
	Index	94

Accessories

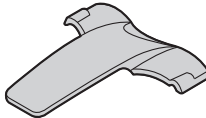
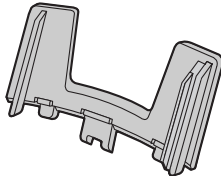
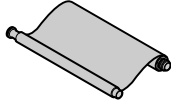
Included accessories

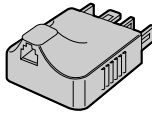
Power cord1 	Telephone line cord1 (for Australian users only)  (Modular type plug)	Telephone line cord1 (for New Zealand users only)  (New Zealand type plug)
Cordless handset1  — The rechargeable battery is pre-installed.	Belt clip.....1 	Paper tray.....1 
Ink film1  — The ink film is pre-installed.	Operating instructions1 	Telephone plug1 (for Australian users only) 

- If any items are missing or damaged, check with the place of purchase.
- Save the original carton and packing materials for future shipping and transportation of the unit.

Accessory information

We recommend that you buy a full-size replacement film for continuous use of your unit. For best results, use genuine Panasonic replacement film Model No. KX-FA53A or KX-FA55A.

Model No.	Item	Specifications / Usage
KX-FA53A	Replacement film	1 roll – 216 mm x 50 m
KX-FA55A	Replacement film	2 rolls – 216 mm x 50 m
P-P510	Rechargeable battery	Ni-Cd battery for the cordless handset.
KX-TCA89BX	Headset	For a hands-free telephone conversation.

- **The ink film is not reusable. Do not rewind and use the ink film again.**

Help Button / Finding the Controls (Base Unit)

Help function

You can print a quick reference for assistance as follows.

1 Press **HELP**.

Display:

PRESS NAVI. [◀ ▶] & SET

2 Press **◀** or **▶** until the desired item is displayed.

1. How to send faxes with the voice guide.

SEND GUIDE PRESS SET

2. How to set the date, time, your logo and fax number.

QUICK SET UP PRESS SET

3. How to program the features.

FEATURE LIST PRESS SET

4. How to store names in the directory and how to dial them.

DIRECTORY PRESS SET

5. Help with problems operating the answering device.

TAD OPERATION PRESS SET

6. Help with problems receiving faxes.

FAX RECEIVING PRESS SET

7. How to use the copier function.

COPIER PRESS SET

8. List of available reports.

REPORTS PRESS SET

9. How to use the Caller ID service.

CALLER ID PRESS SET

3 Press **SET**.

PRINTING

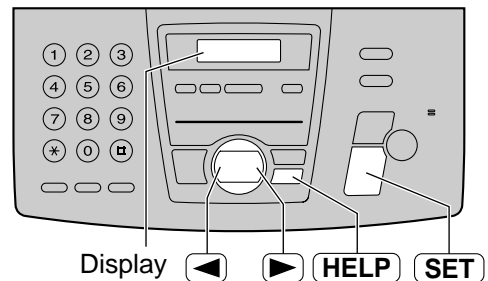

Overview

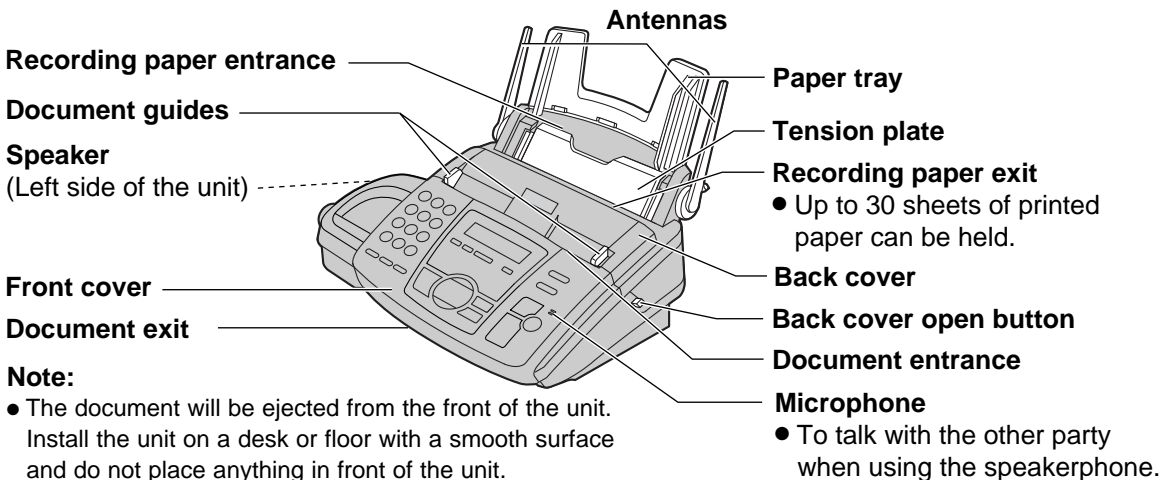

Finding the Controls (Base Unit)

Location

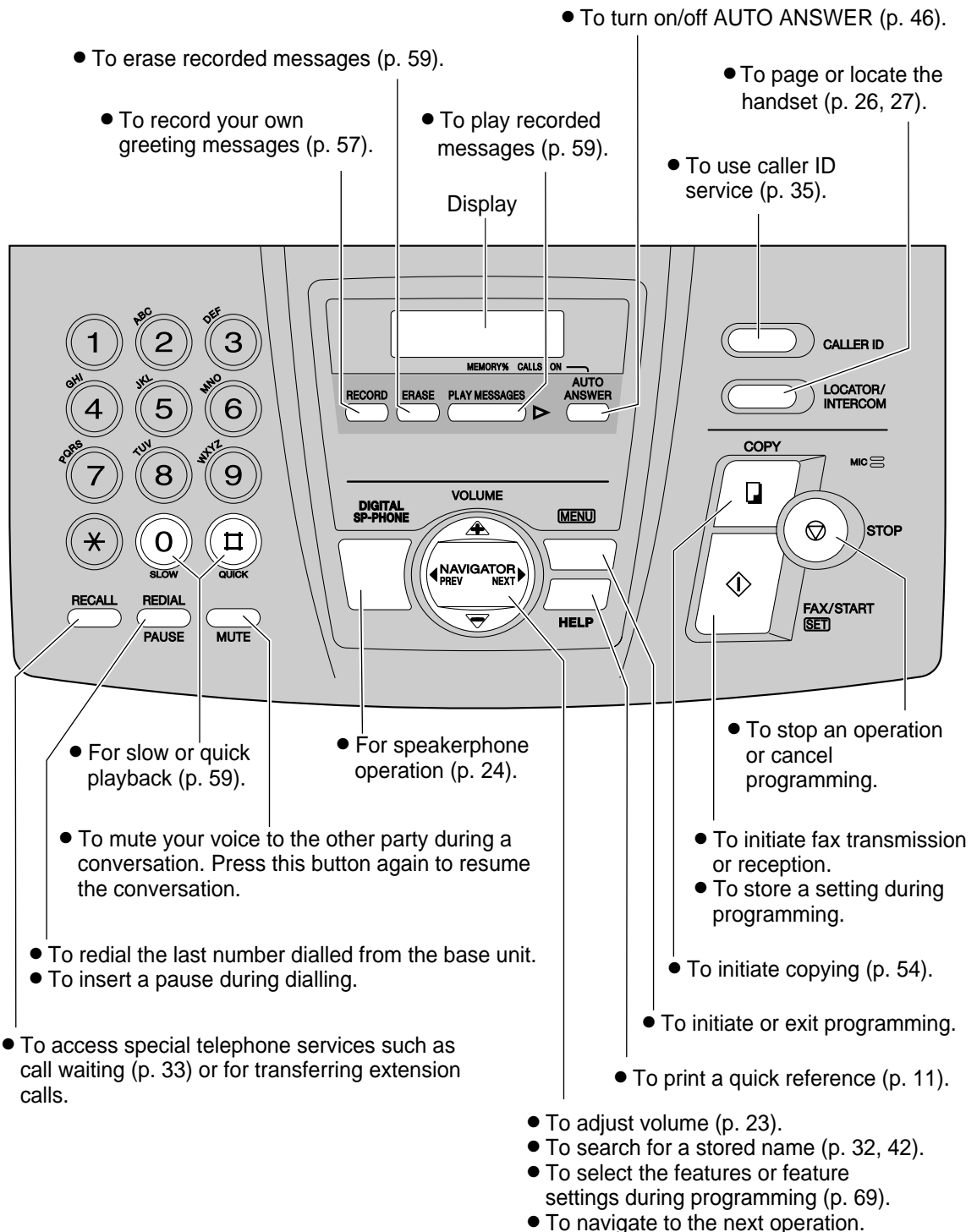

Ink film – installing / replacing

Install the included ink film or replace the used ink film with a new one.

The following ink films are available for replacement.

Model No. KX-FA53A: Replacement film (1 roll)

Model No. KX-FA55A: Replacement film (2 rolls)

Each roll prints about 140 A4-sized pages or 150 letter-sized pages. See page 10 for accessory information.

- 1 Open the front cover by pulling up the centre part.

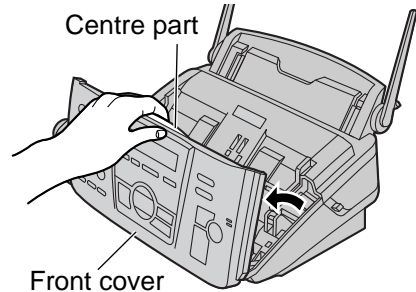

- 2 Push the back cover open button (green) on the right side of the unit.
OR
Push the back cover open lever (green) inside of the unit.

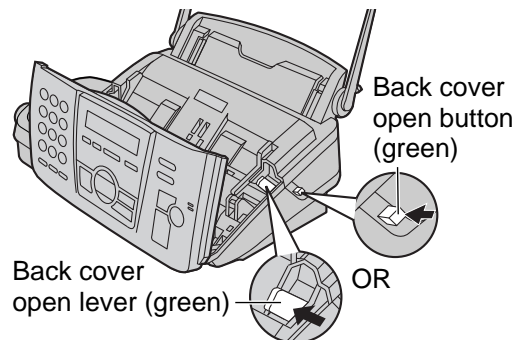

- 3 Open the back cover.
 - For first time installation of the supplied ink film, skip to step 6.

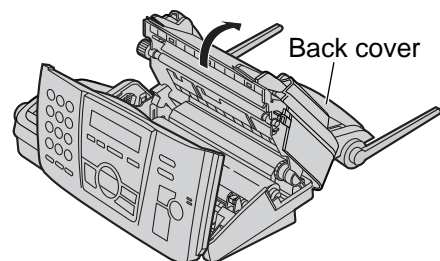

- 4 **For replacement only**
Pull out the blue gear and remove the used ink film. Remove the used core.

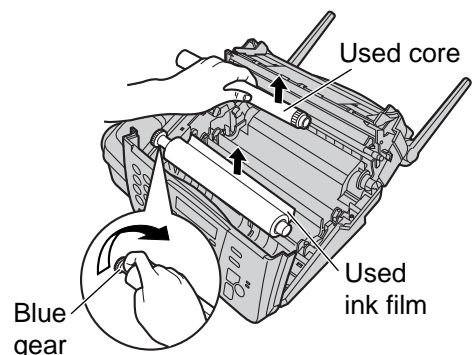

(continued)

Setup (Base Unit)

- 5 For replacement only**
Remove the stoppers and tags from the new ink film. Find the "T" shaped gear (blue).

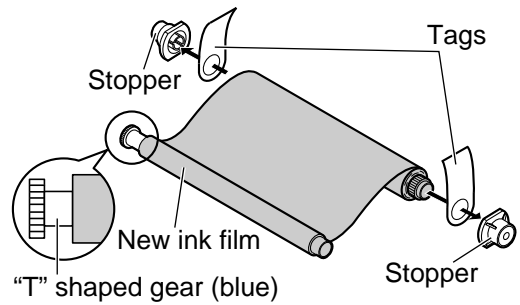

- 6** Insert the blue core of the front ink film roll into the right slot of the unit (①). Insert the "T" shaped gear (blue) into the left slot of the unit (②). Insert the rear ink film roll (③).

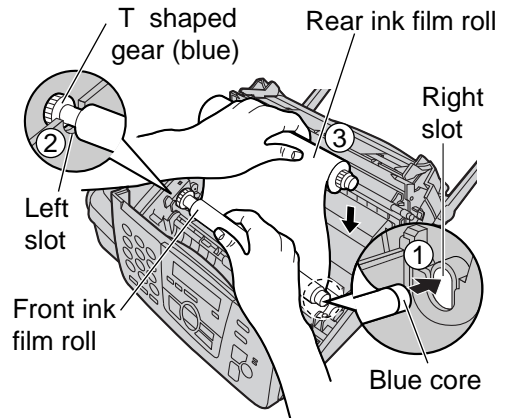

- 7** Turn the "T" shaped gear (blue) in the direction of the arrow.
• Make sure that the ink film is wrapped around the blue core at least once.

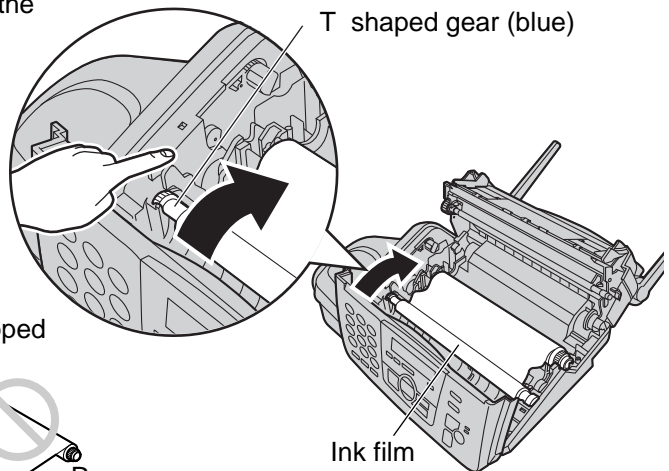
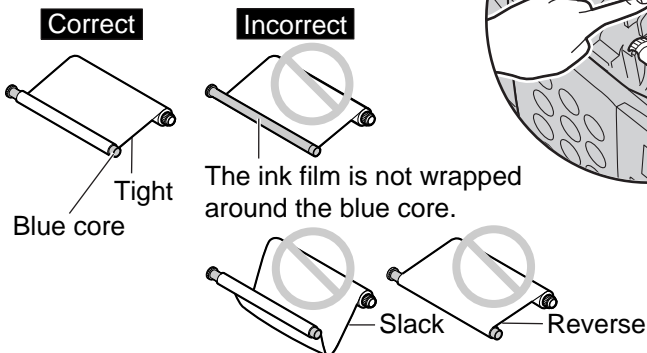

- 8** Close the back cover securely by pushing down on the dotted area at both ends (①). Close the front cover securely (②).
• The following will be displayed while the unit is checking that there is no slack in the ink film.

Display: PLEASE WAIT

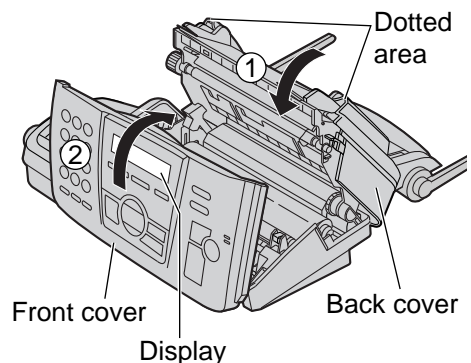

Note:

- The ink film is completely safe to touch, and will not rub off on your hands like carbon paper.

Paper tray

Insert the tab on the paper tray into the slot on the back of the unit.

Note:

- Do not place the unit in areas where the paper tray may be obstructed (i.e. by a wall, etc.).

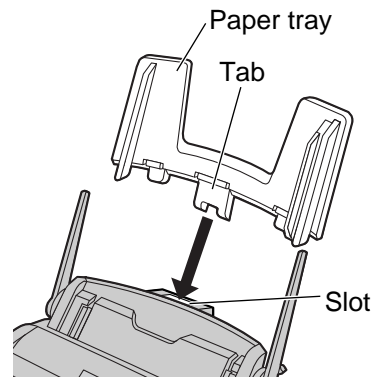

Recording paper

A4 size recording paper can be loaded. The unit can hold up to 50 sheets of 60 g/m² to 75 g/m² (16 lb. to 20 lb.) paper or 30 sheets of 90 g/m² (24 lb.) paper. See the note for paper specifications on page 89.

- 1 Fan the stack of paper to prevent a paper jam.
- 2 Pull the tension plate forward and hold open while inserting the paper.
 - The paper should not be over the tab.
 - If the paper is not inserted correctly, readjust the paper, or the paper may jam.

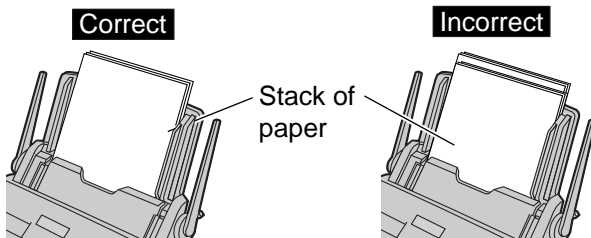
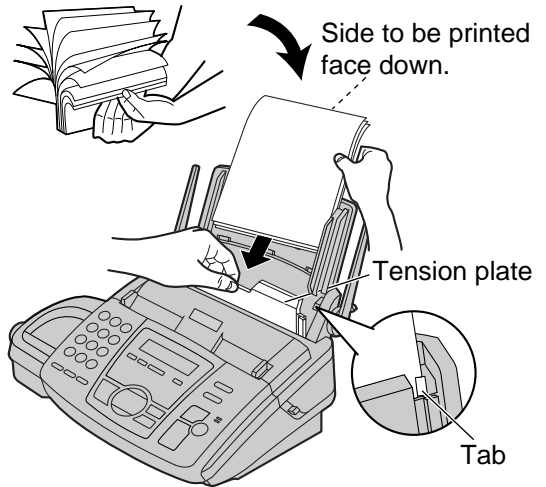

Adding paper

1. Pull the tension plate forward and hold open while removing all of the installed paper.
2. Add paper to the stack of paper you removed and straighten.
3. Fan the stack of paper.
4. Pull the tension plate forward and hold open while inserting the paper.

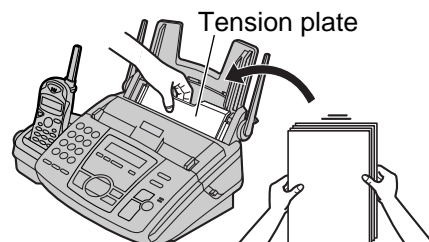

Setup (Base Unit)

Connections

1 Connect the telephone line cord.

2 Connect the power cord.

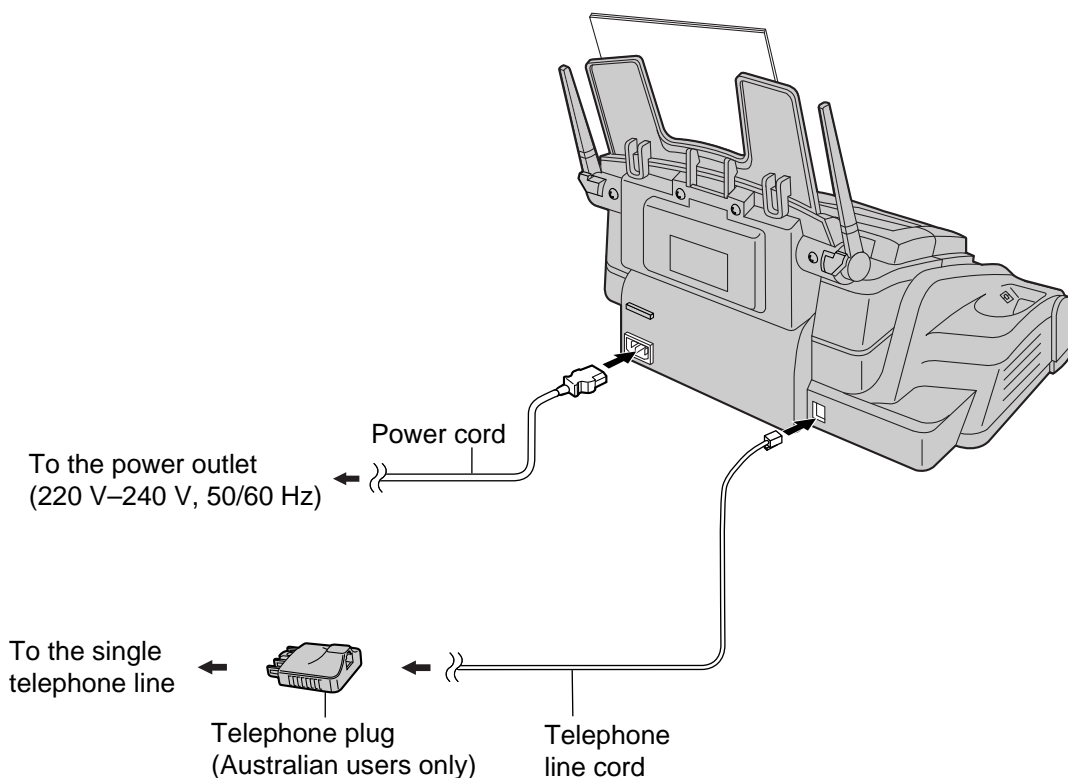

Caution:

- When you operate this product, the power outlet should be near the product and easily accessible.

To use the fax machine with a computer on the same line

- We recommend you use separate wall jacks for the fax machine and the computer.
- Set the fax machine to TEL mode (p. 48).
- The device which has the shortest ring setting will answer the call first.
- If the computer provides a port for a telephone line, connect the fax machine to this port on the computer.

Date and time, your logo and facsimile telephone number

You should program the date and time, your logo and facsimile telephone number. This information will be printed on each page transmitted from your unit.

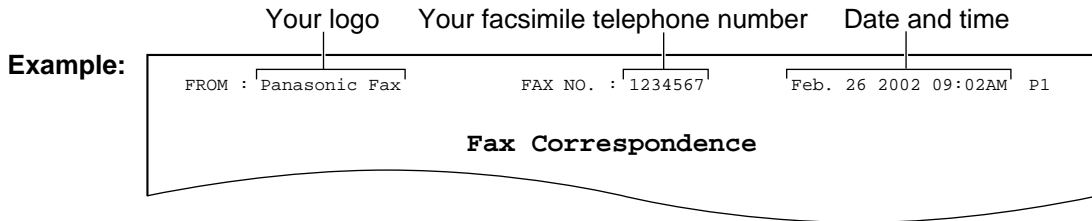

Setting the date and time

1 Press **MENU**.

Display: SYSTEM SET UP
PRESS NAVI. [◀ ▶]

2 Press **◀** or **▶** until the following is displayed.

SET DATE & TIME
PRESS SET

3 Press **SET**.

Cursor
Example: M:01/D:01/Y:02
TIME: 12:00AM

4 Enter the correct month/day/year by selecting 2 digits for each, using the dial keypad.

Example: August 10, 2002

Press **0 8 1 0 0 2**.

M:08/D:10/Y:02
TIME: 12:00AM

5 Enter the correct hour/minute by selecting 2 digits for each, using the dial keypad.

Press ***** to select "AM" or "PM".

Example: 3:15PM

1. Press **0 3 1 5**.

M:08/D:10/Y:02
TIME: 03:15AM

2. Press ***** until "PM" is displayed.

M:08/D:10/Y:02
TIME: 03:15PM

6 Press **SET**.

- The next feature will be displayed.

YOUR LOGO
PRESS SET

7 Press **MENU**.

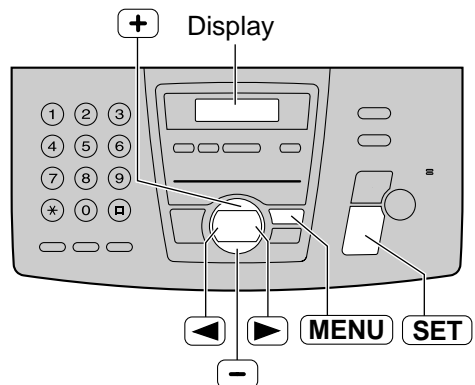

Note:

- You can enter the number by pressing **+** or **-** in steps 4 and 5. In this case, press **▶** to move the cursor.
- The accuracy of the clock is approximately ± 60 seconds a month.

To correct a mistake

- Press **◀** or **▶** to move the cursor to the incorrect number, and make the correction.

Setup (Base Unit)

Setting your logo

The logo can be your company, division or name.

1 Press **MENU**.

Display:

SYSTEM SET UP PRESS NAVI. [◀ ▶]

2 Press **◀** or **▶** until the following is displayed.

YOUR LOGO PRESS SET

3 Press **SET**.

LOGO=

4 Enter your logo, up to 30 characters, using the dial keypad. See the next page for details.

Example: "Bill"

1. Press **2** 2 times.

Cursor

LOGO= B

2. Press **4** 6 times.

LOGO= Bi

3. Press **5** 6 times.

LOGO= Bill

4. Press **▶** to move the cursor to the next space and press **5** 6 times.

LOGO= Bill

5 Press **SET**.

• The next feature will be displayed.

YOUR FAX NO. PRESS SET

6 Press **MENU**.

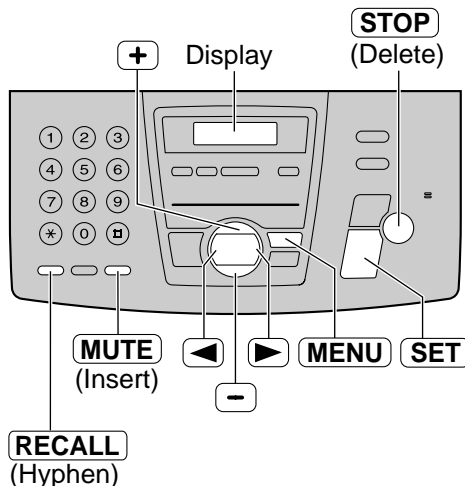

Note:

- You can enter your logo by pressing **+** or **-** (see the next page) in step 4. In this case, press **▶** to move the cursor.

To correct a mistake

- Press **◀** or **▶** to move the cursor to the incorrect character, and make the correction.

To delete a character

- Move the cursor to the character you want to delete and press **STOP** (Delete).



To insert a character

1. Press **◀** or **▶** to move the cursor to the position to the right of where you want to insert the character.
2. Press **MUTE** (Insert) to insert a space and enter the character.

Setup (Base Unit)

To select characters with the dial keypad

Pressing the dial keys will select a character as shown below.

Keys	Characters
①	1 [] { } + - / = , . _ ` : ; ?
②	A B C a b c 2
③	D E F d e f 3
④	G H I g h i 4
⑤	J K L j k l 5
⑥	M N O m n o 6
⑦	P Q R S p q r s 7
⑧	T U V t u v 8
⑨	W X Y Z w x y z 9
⑩	0 () < > ! " # \$ % & ¥ * @ ^ ' →
RECALL	Hyphen button (To insert a hyphen.)
MUTE	Insert button (To insert one character or one space.)
STOP	Delete button (To delete a character.)
	▶ key (To move the cursor to the right.) To enter another character using the same number key, move the cursor to the next space.
	◀ key (To move the cursor to the left.)

To select characters using **+** or **-**

Instead of pressing the dial keys, you can select characters using **+** or **-**.

1. Press **+** or **-** until the desired character is displayed.
2. Press  to move the cursor to the next space.
 - The character displayed in step 1 is inserted.
3. Return to step 1 to enter the next character.

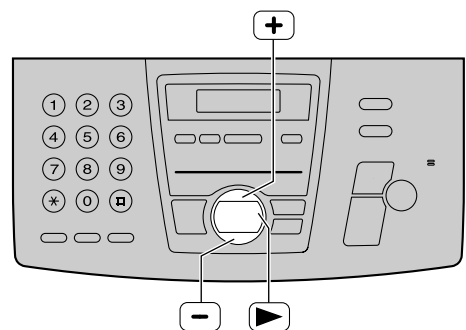

Display order of characters

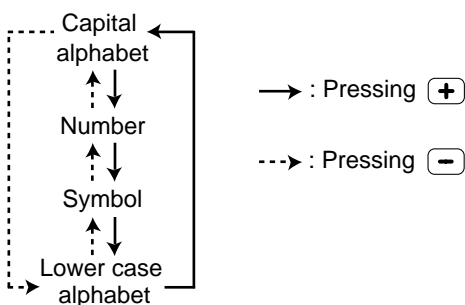

Setup (Base Unit)

Setting your facsimile telephone number

- 1 Press **MENU**.
Display:

SYSTEM SET UP PRESS NAVI. [◀ ▶]

- 2 Press **◀** or **▶** until the following is displayed.

YOUR FAX NO. PRESS SET

- 3 Press **SET**.

NO. =

- 4 Enter your facsimile telephone number, up to 20 digits, using the dial keypad.
Example:

NO. =1234567

- 5 Press **SET**.
 - The next feature will be displayed.

SENDING REPORT MODE=ERROR [±]

- 6 Press **MENU**.

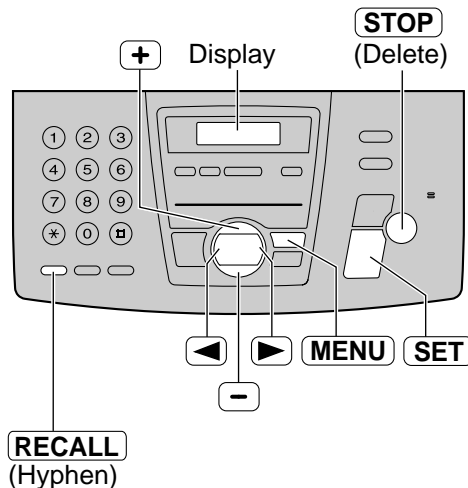

Note:

- You can enter your facsimile telephone number by pressing **+** or **-** in step 4. If you use **+** or **-**, press **▶** to move the cursor.
- The ***** button replaces the digit with a "+" and the **#** button replaces it with a space.

Example (using the dial keypad): +234 5678

Press ***** **2** **3** **4** **#** **5** **6** **7** **8**.

- To enter a hyphen in a telephone number, press **RECALL** (Hyphen).

To correct a mistake

- Press **◀** or **▶** to move the cursor to the incorrect number, and make the correction.

To delete a number

- Move the cursor to the number you want to delete and press **STOP** (Delete).

Location

- To adjust volume (p. 23).
- To search for a stored name (p. 32).
- To view caller information (p. 34).
- To make/answer/end calls (p. 24, 25).
- To select a clear channel (p. 24).
- To enter programming (p. 28).
- To stop viewing (p. 34).
- To access special telephone services such as call waiting (p. 33) or for transferring extension calls.
- To listen to recorded messages (p. 60).

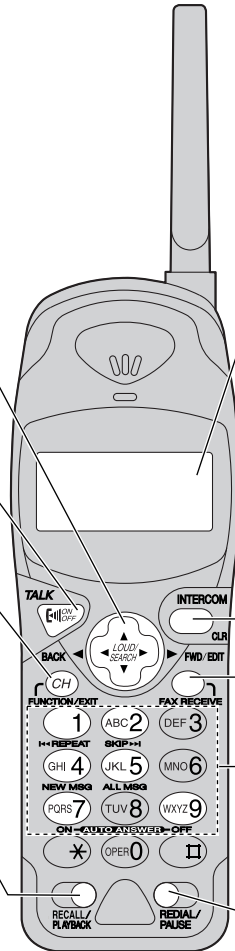

- Backlit LCD display
The lighted display will stay on for a few seconds after pressing a handset button or lifting the handset off the base unit.
- To page the base unit (p. 26, 27).
- To erase an item (p. 31).
- To erase caller information (p. 36).
- To receive a fax (p. 48).
- Dial 1: To repeat the recorded messages (p. 60).
- Dial 2: To skip the recorded messages (p. 60).
- Dial 4: To play new recorded messages (p. 60).
- Dial 5: To play all recorded messages (p. 60).
- Dial 7: To turn AUTO ANSWER on (p. 60).
- Dial 9: To turn AUTO ANSWER off (p. 60).
- To redial the last number dialed from the handset.
- To insert a pause during dialling.

Belt clip and headset

Belt clip

To install the belt clip

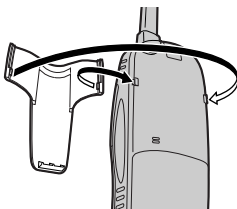

To remove the belt clip



Headset (optional)

Plugging the headset into the handset allows a hands-free telephone conversation. For best results, use the Panasonic headset Model No. KX-TCA89BX. See page 10 for accessory information.

To connect the headset

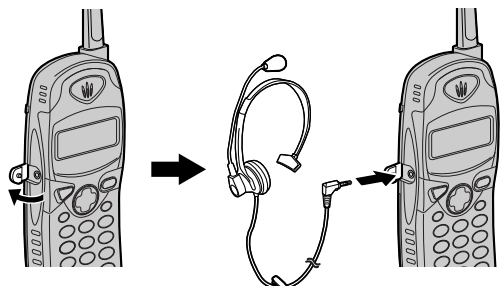

Setup (Handset)

Battery charge

Lay the handset in the cradle of the base unit for about **6 hours** before initial use.

- A beep will sound, and the following will be displayed for an instant on the base unit.

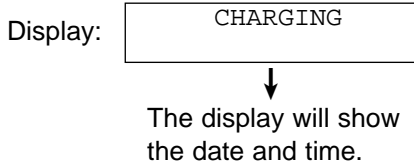

- If the base unit is in use, a beep may not sound and the above display may not be shown.
- While charging, the battery strength mark (see below) will be shown on the handset display.

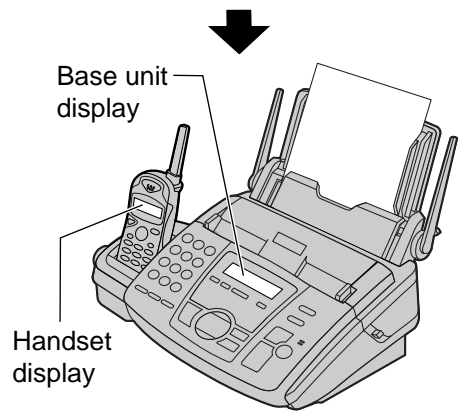
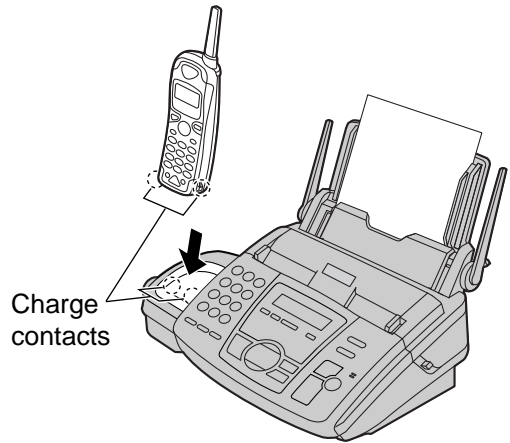

Note:

- **Clean the handset and the base unit charge contacts with a dry cloth once a month**, or the battery may not charge properly.
- The battery cannot be overcharged.

Battery strength

You can check the battery strength on the handset display while the handset is in use, or for about 5 seconds after using the handset.

Handset display	Battery strength
{■■■■}	Fully charged
{■■■}	Medium
{■}	Low
{■} (flashing)	Needs to be recharged.

Battery life

If your Panasonic battery is fully charged;

- the battery life will last up to 4.5 hours while in use (in conversation) near the base unit within about 3 m.
- the battery life will last up to 3.5 hours while in use (in conversation) away from the base unit.
- it will last for up to about 11 days while not in use (off the base unit).
- Battery life may vary depending on usage conditions and ambient temperature.

Recharge

Recharge the battery when:

- the handset beeps intermittently while it is in use, or
- the following is shown and “{ ■ }” flashes on the handset display.

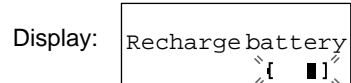

- Recharge the handset battery for more than 15 minutes, or the display will continue showing the above indication.

Automatic security code setting

Whenever you place the handset on the base unit, the unit will automatically select one of a million security codes. These codes help to avoid unauthorised use of your telephone line by another cordless telephone.

Adjusting handset volume

Ringer volume

3 levels (high/low/off) are available.

Make sure the handset is idle.

1. Press **FUNCTION/EXIT**.
2. Press **▼** to select "Ringer volume".

Display:

```
Save directory
▶Ringer volume
▼▲                    ▶=Yes
```

3. Press **▶**.
4. Press **▼** or **▲** to select the desired volume.
 - The current ringer will sound.
 - To change the volume, press **▼** or **▲** again within 5 seconds.

To turn the ringer off:

Press and hold **▼** until you hear 2 beeps in step 4.

Ringer off

- To turn the ringer back on, press **▲** in step 4.

While the ringer volume is set to off:

When receiving a call, the handset will not ring.

Handset receiver volume

3 levels (high/middle/low) are available.

While talking, press **▼** or **▲**.

Adjusting base unit volume

Ringer volume

4 levels (high/middle/low/off) are available.

While the unit is idle, press **+** or **-**.

- If any documents are in the document entrance, you cannot adjust the ringer volume. Confirm that there are no documents in the entrance.

To turn the ringer off:

1. Press **-** repeatedly until the following is displayed.

Display:

```
RINGER OFF= OK?
YES:SET/NO:STOP
```

2. Press **SET**.

RINGER OFF

- To turn the ringer back on, press **+**.

While the ringer volume is set to off:

When a call is received, the unit will not ring and will display the following.

INCOMING CALL

Ringer pattern

- You can select one of three ringer patterns. Change the setting (feature #17 on page 71). The ringer pattern you selected will sound when the unit receives a call.

Speaker volume

8 levels (high to low) are available.

While using the speakerphone, press

+ or **-**.

Fax voice guidance volume

9 levels (high to off) are available.

While listening to the fax voice guidance, press **+** or **-**.

Answering device volume

9 levels (high to off) are available.

While listening to the recorded messages, press **+** or **-**.

Making and Answering Calls

Phone calls - making

With the handset

- 1** Handset is off the base unit:
Press **TALK**.

Handset is on the base unit:
Lift the handset and press **TALK**.

- 2** Dial the telephone number.

Example:

Talk 1112222

- If noise interferes with the conversation, press **CH** to select a clear channel or move closer to the base unit.

- 3** When finished talking, press **TALK** or lay the handset on the base unit.

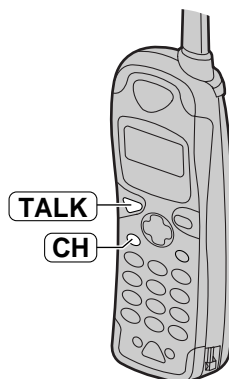

Note:

- If short beeps sound when you press **TALK**;
 - move closer to the base unit, or
 - lay the handset on the base unit.Then try again.
- If **TALK** is pressed while the base unit is in use, the call will be switched to the handset and the base unit is disconnected.

With the base unit

- 1** Press **DIGITAL SP-PHONE**.

Display:

TEL= PRESS NAVI. [▶]

- 2** Dial the telephone number.

Example:

TEL=2345678

- 3** When the other party answers, talk into the microphone.

- 4** When finished talking, press **DIGITAL SP-PHONE**.

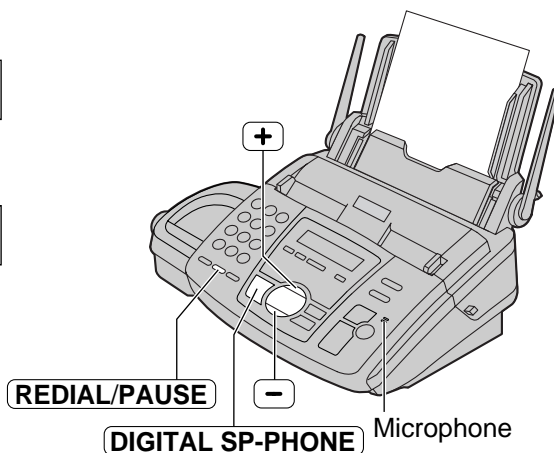

To redial the last number

The last number dialled will be redialled.

1. Press **DIGITAL SP-PHONE** or lift the handset.
2. Press **REDIAL/PAUSE**.

■ For New Zealand users only

- If the line is busy when using the **DIGITAL SP-PHONE** button, the unit will automatically redial the number twice.
- During redial, the following will be displayed.

Display:

WAITING REDIAL

Speakerphone operation

- Use the speakerphone in a quiet room.
- Adjust the speakerphone volume using **+** or **-**.

Phone calls - answering

With the handset

- Handset is off the base unit:**
 Press **TALK** when the handset rings.
 - You can also answer a call by pressing any dial key 0 to 9, *, or #.**(Any key talk feature)**

Handset is on the base unit:
 Lift the handset and press **TALK** when the base unit rings.

- When finished talking, press **TALK** or lay the handset on the base unit.



With the base unit

- When the base unit rings, press **DIGITAL SP-PHONE** and talk into the microphone.

- When finished talking, press **DIGITAL SP-PHONE**.

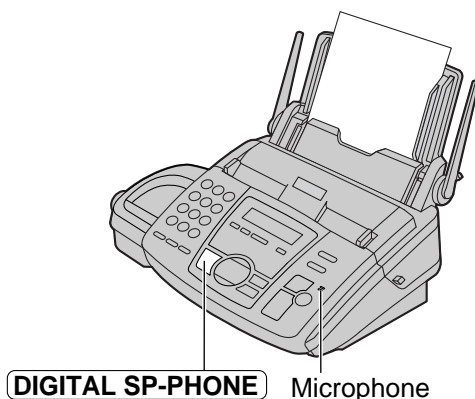

Auto talk feature (Handset)

You can answer a call by just lifting the handset off the base unit without pressing **TALK**. This feature is set to off. To activate this feature, proceed as follows.

Make sure the handset is idle.

- Press **FUNCTION/EXIT**.

Display:

▶Save directory
Ringer volume
▼▲ ▶=Yes

- Press ▼ 2 times to select "Talk switching".

▶Talk switching
▼▲ ▶=Yes

- Press ►.

Auto talk
:Off
▼▲ ▶=Save

- Press ▼ or ▲ to select "On".

Auto talk
:On
▼▲ ▶=Save

- Press ►.

- Press **FUNCTION/EXIT** to exit the program.

Note:

- If you subscribe to Caller ID service, and want to view the caller's information on the handset display before answering a call, turn off this feature.

Making and Answering Calls

Intercom

Paging the base unit from the handset

- Handset:**
Press **INTERCOM**.
 - The base unit will ring. You can then talk with the base unit user.

Handset display:
(Example)

Intercom
00-01-12 [■■■■]

Conversation time

- Base unit:**
Answer through the microphone.

Base unit display:

PAGING

↓

INTERCOM

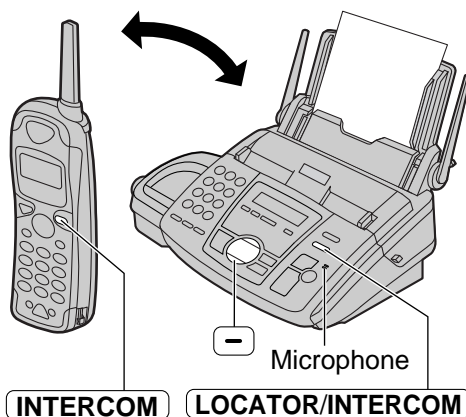

- Handset:**
When finished talking, press **INTERCOM**.

Note:

- If the handset user has difficulty hearing the base unit user, ask the base unit user to decrease the speaker volume by pressing **-**.
- Intercom can only be ended using the handset.

Paging the handset from the base unit

Using this feature, you can locate the handset if it has been misplaced (**Handset locator**).

- Base unit:**
Press **LOCATOR/INTERCOM**.
 - The base unit will page the handset for about 1 minute.

Base unit display:

PAGING

Handset display:

Paging
Press INTERCOM

- To stop paging, press **LOCATOR/INTERCOM** again.

- Handset:**
Press **INTERCOM** to answer.

Handset display:
(Example)

Intercom
00-01-12 [■■■■]

- Base unit:**
Speak into the microphone.

Base unit display:

INTERCOM

- Handset:**
When finished talking, press **INTERCOM**.

Note:

- Intercom can only be ended using the handset.

Making and Answering Calls

Transferring a call

The intercom can be used during a conversation. This feature enables you to transfer an outside call between the handset and the base unit.

From the handset to the base unit

1 Handset:
During an outside call, press **INTERCOM** to page the base unit.

- The handset user can talk with the base unit user.
- The outside call will be put on hold.

Handset display:
(Example)

Intercom hold
00-01-12 {■■■■}

Base unit display:

PAGING

INTERCOM HOLD

- If there is no answer on the base unit, press **TALK** to return to the outside call.

2 Base unit:
Talk with the handset user through the microphone.

3 Base unit:
To answer the outside call, press **DIGITAL SP-PHONE**.

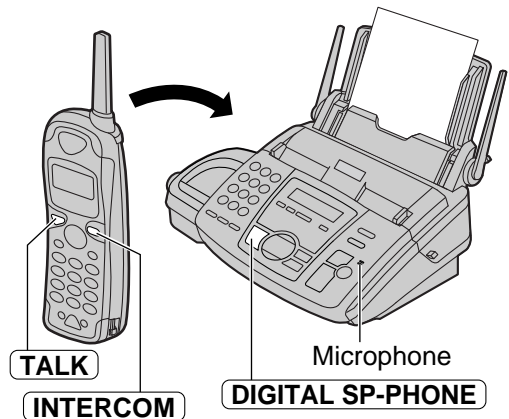

From the base unit to the handset

1 Base unit:
During an outside call, press **LOCATOR/INTERCOM** to page the handset.

- The base unit will start paging the handset for 1 minute.
- The outside call will be put on hold.

Base unit display:

PAGING

Handset display:

Paging
Press INTERCOM

2 Handset:
Press **INTERCOM** to answer the page.

Handset display:
(Example)

Intercom hold
00-01-12 {■■■■}

Base unit display:

INTERCOM HOLD

3 Handset:
To answer the outside call, press **TALK**.

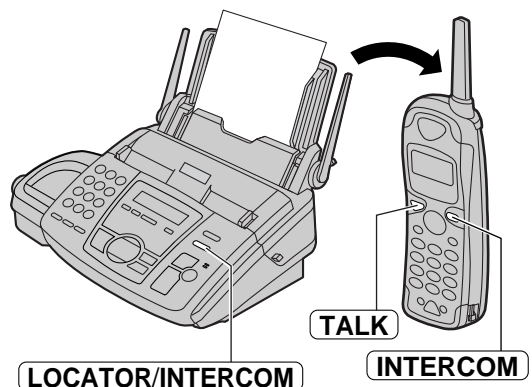

Navigator Directory

Storing names and telephone numbers into the directory

For rapid access to frequently dialled numbers, the unit provides the navigator directory. You can store the names and telephone numbers using both the handset and base unit up to 50 items in total.

Using the handset

1 Press **FUNCTION/EXIT**.

Display: ▶Save directory
Ringer volume
▼▲ ▶=Yes

2 Press **▶**.

Example: Directory=
2 items
↓
Enter name
◀▶ ▼=Next

3 Enter the name, up to 10 characters (see right).

Example: Enter name
Tom Jones
◀▶ ▼=Next

4 Press **▼**.

Enter phone no.

5 Enter the telephone number, up to 30 digits, using the dial keypad.

Example: 3334444
◀▶ ▼=Next

6 Press **▼**.

Example: Tom Jones
3334444
▲=Edit ▶=Save

7 Press **▶**.
• To program other items, repeat steps 2 to 7.

8 Press **FUNCTION/EXIT** to exit the program.

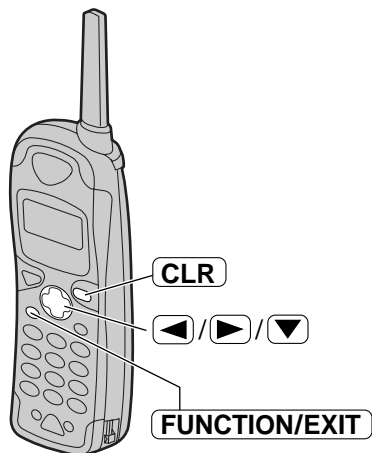

Keys	Characters
1	1 (Space) [] { } + - / = , . _ ` : ; ?
2	A B C a b c 2
3	D E F d e f 3
4	G H I g h i 4
5	J K L j k l 5
6	M N O m n o 6
7	P Q R S p q r s 7
8	T U V t u v 8
9	W X Y Z w x y z 9
0	0 () < > ! " # \$ % & ¥ * @ ^ ' →

Note:

- To enter another character using the same number key, press **▶** to move the cursor to the next space.

To correct a mistake

1. Press **◀** or **▶** to move the cursor to the incorrect character.
2. Press **CLR**.
3. Enter the correct character.

Using the base unit

- 1** Press **MENU** repeatedly until the following is displayed.

Display:

DIRECTORY SET
NAVI.=* BROAD=#

- 2** Press ***** to select "NAVI.".

Display:

NAME=
STORE:PRESS SET

- 3** Enter the name, up to 10 characters (see page 19 for instructions).

Example:

NAME=Alice
STORE:PRESS SET

- 4** Press **SET**.

Display:

NO.=

- 5** Enter the telephone number, up to 30 digits, using the dial keypad.

Example:

NO.=5552233

- If you want to enter a hyphen, press **RECALL/CALL WAIT** (Hyphen).

- 6** Press **SET**.

REGISTERED
↓

NAME=
STORE:PRESS SET

- To program other items, repeat steps 3 to 6.

- 7** Press **MENU** to exit the program.

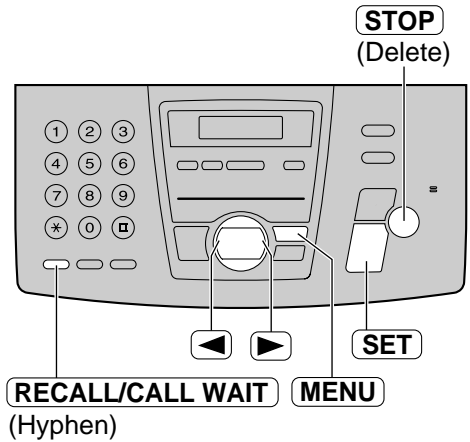

Helpful hint:

- You can confirm the stored items on the telephone number list (p. 90).

Note:

- When the following is displayed in step 6, you can store only 5 more items.

Display:

REGISTERED
SPACE= 5 DIRS.

- If there is no space to store new items, the following is displayed in step 6.

Display:

REGISTERED
DIRECTORY FULL

Erase unnecessary items (p. 31).

- A hyphen or a space entered in a telephone number counts as two digits.

To correct a mistake

- Press **◀** or **▶** to move the cursor to the incorrect character/number, and make the correction.

To delete a character/number

- Move the cursor to the character/number you want to delete, and press **STOP** (Delete).

Editing a stored item

Items stored in the handset and the base unit are for common use and can be edited from both the handset and the base unit.

Using the handset

1 Press or .

Display:

Directory list
▼▲
▶=Caller's list

2 Press or until the desired item is displayed.

Example:

Jane
1234567

3 Press .

Example:

Enter name
Jane
◀▶ ▼=Next

- If you do not need to edit the name, skip to step 5.

4 Edit the name (see page 28 for instructions).

5 Press .

Example:

1234567
◀▶ ▼=Next

- If you do not need to edit the telephone number, skip to step 7.

6 Edit the telephone number. For further details, see page 28.

7 Press .

Example:

Jane
6789453
▲=Edit ▶=Save

8 Press .

9 Press **FUNCTION/EXIT** to exit the program.

Using the base unit

1 Press .

- Confirm that there are no documents in the document entrance.

Display:

DIRECTORY [+ -]
<MAILBOX>▶

2 Press or until the desired item is displayed.

Example:

Mary
0123456

↓

Mary
EDIT:PRESS MENU

3 Press **MENU**.

Example:

NAME=Mary
EDIT=* DELETE=#

4 Press to select "EDIT".

Example:

NAME=Mary
STORE:PRESS SET

- If you do not need to edit the name, skip to step 6.

5 Edit the name (see page 19 for instructions).

6 Press **SET**.

Example:

NO.=0123456

- If you do not need to edit the telephone number, skip to step 8.

7 Edit the telephone number. For further details, see page 28.

8 Press **SET**.

REGISTERED

Erasing a stored item

Once erased, an item cannot be accessed from either the handset or the base unit.

Using the handset

1 Press **◀** or **▶**.

Display:

```
Directory list
▼▲
▶=Caller's list
```

2 Press **▼** or **▲** until the desired item is displayed.

Example:

```
Helen
1234567890
```

3 Press **CLR**.

```
Clear?
◀=No      ▶=Yes
```

- To cancel erasing, press **◀**.

4 Press **▶** or **CLR**.

```
Clear
```

- The stored name and number are erased.

5 Press **FUNCTION/EXIT** to exit the program.

Using the base unit

1 Press **▶**.
• Confirm that there are no documents in the document entrance.

Display:

```
DIRECTORY [+ -]
<MAILBOX>▶
```

2 Press **+** or **-** until the desired item is displayed.

Example:

```
Peter
9876543
```



```
Peter
EDIT:PRESS MENU
```

3 Press **MENU**.

Example:

```
NAME=Peter
EDIT=* DELETE=#
```

4 Press **☒** to select "DELETE".

```
DELETE OK?
YES:SET/NO:STOP
```

- To cancel erasing, press **STOP**.

5 Press **SET**.

```
DELETED
```

- The stored name and number are erased.

Note:

- You can use the following method to erase.

1. Press **▶**.

- Confirm that there are no documents in the document entrance.

2. Press **+** or **-** until the desired item is displayed.

3. Press **ERASE**.

4. Press **SET**.

Making a phone call using the directory

Before using this feature, program the desired names and telephone numbers into the directory (p. 28, 29).

Using the handset

1 Press or .

Display:

Directory list
▼▲
▶=Caller's list

2 Press or until the desired item is displayed.

Example:

Frank
4567890

- If the desired name has not been stored, press **FUNCTION/EXIT** and dial the number manually.

3 Press **TALK**.
• The unit will start dialling automatically.

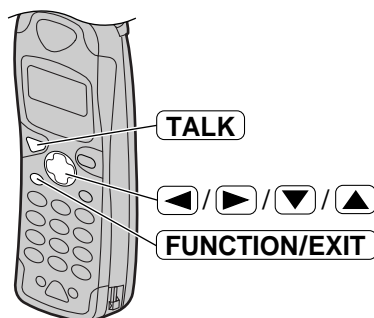

Using the base unit

1 Press .
• Confirm that there are no documents in the document entrance.

Display:

DIRECTORY [+ -]
<MAILBOX>▶

2 Press **+** or **-** until the desired item is displayed.

Example:

Lisa
2233445

↕

Lisa
EDIT:PRESS MENU

- If the desired name has not been stored, press **STOP** and dial the number manually.

3 Press **DIGITAL SP-PHONE** or lift the handset and press **TALK**.
• The unit will start dialling automatically.

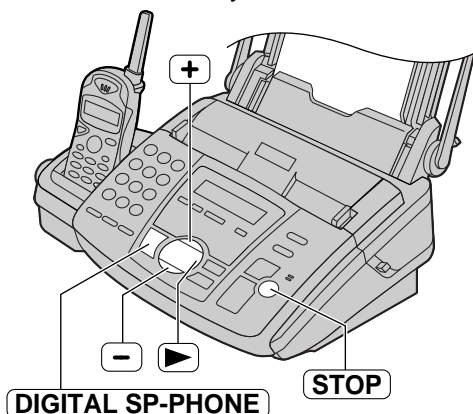

To search for a name by initial

Example: "Lisa"

1. Press .
 - Confirm that there are no documents in the document entrance.
2. **Handset:**
Press or to enter the directory.
Base unit:
Press **+** or **-** to enter the directory.
3. Press **5** repeatedly until any name with the initial "L" is displayed.
 - To search for symbols (not letters or numbers), press *****.

4. **Handset:**
Press until "Lisa" is displayed.
Base unit:
Press **+** until "Lisa" is displayed.
 - To stop the search, press **FUNCTION/EXIT** on the handset or **STOP** on the base unit.
 - To make a call, press **TALK** on the handset or **DIGITAL SP-PHONE** on the base unit.

Caller ID service from your phone company

This unit is compatible with the Caller ID service offered by your local telephone company. To use this feature, you must subscribe to the Caller ID service.

How Caller ID is displayed

The calling party's name or telephone number will be displayed after the first ring. You then have the option of whether or not to answer the call depending on the caller.

The unit will automatically store the caller information (name, telephone number and the time of the call). You can view the caller information (p. 34, 35) and print the caller ID list (p. 90).

Note:

- If the unit is connected to a PBX (Private Branch Exchange) system, you may not receive the caller information. Consult your PBX supplier.
- If the unit cannot receive caller information, the following will be displayed.

Base unit display

UNAVAIL NAME&NO

Handset display

Unavailable
Name & No.

The caller dialed from an area which does not provide Caller ID service.

PRIVATE CALLER

Private caller

The caller requested not to send caller information.

Note for Australian users:

- The KX-FC175AL will not display the name from the Directory. Telstra and Optus do not currently transmit names with the Caller ID.

Note for New Zealand users:

- Telecom New Zealand does not currently send a NAME for Caller ID.
- Your telephone service provider may charge you for a local call when it is dialled with an area code prefix. If the charge for local call is unacceptable, only the 7-digits of the local number should be dialled from your telephone. Do not dial the "0" prefix or the area code digit.

To confirm caller information using the Caller ID list

The unit will store information for the most recent 30 callers.

— To print manually, see page 90.

— To print automatically after every 30 new calls, activate feature #26 (p. 72).

Visual Call Waiting (Call Waiting ID) Service (For Australian users only)

If you hear a call-waiting tone during a conversation, the display will show the second caller's information.

Press **RECALL** to answer the second call.

- The first call is put on hold and you can answer the second call.
- To return to the first caller, press **RECALL** again.

Note:

- The second caller's information will not be displayed when:
 - the answering system is recording an incoming message,
 - an extension telephone on the same line is in use, or
 - you are sending or receiving a fax document.
- Please contact your telephone company for details and availability of this service in your area.

Viewing and calling back using caller information

You can easily view caller information and call back.

Important:



- Calling back will not be possible in the following cases:
 - The telephone number includes data other than numbers (i.e. * or #).
 - The caller information does not include a telephone number.

Using the handset

1 Handset is off the base unit:

Press  or .

Handset is on the base unit:

Lift the handset and press  or .

Example:

2 new calls ▼▲ ▶=Directory

(2 new calls are received)

2 Press to show the most recent caller information.

Press  to show the calls which have already been viewed.

Example:

KEVIN PARKER 3334444 11:50A JUN.10 ✓
--

This means this call has already been viewed or answered.

3 Press to call back the displayed party.

- The unit will start dialling automatically.

Note:

- Telstra, Optus and Telecom New Zealand do not currently send a NAME for Caller ID.

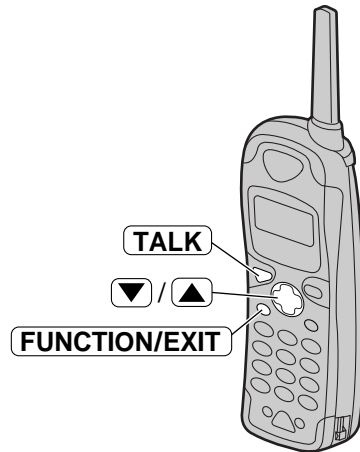

Display while viewing

No caller data

 When no calls have been received.

To stop viewing

Press  after step 2.

Using the base unit

1 Press **CALLER ID**.

Example:

2 NEW CALLS PRESS NAVI. [+ -]

(2 new calls are received)

2 Press **+** to show the most recent caller information.
Press **-** to show the calls which have already been viewed.

3 Handset is off the base unit:
Press **TALK** on the handset to call back the displayed party.

Handset is on the base unit:
Press **DIGITAL SP-PHONE** or lift the handset and press **TALK**.

- The unit will start dialling automatically.
- To send a fax – insert the document **FACE DOWN** and press **FAX/START** (p. 40).

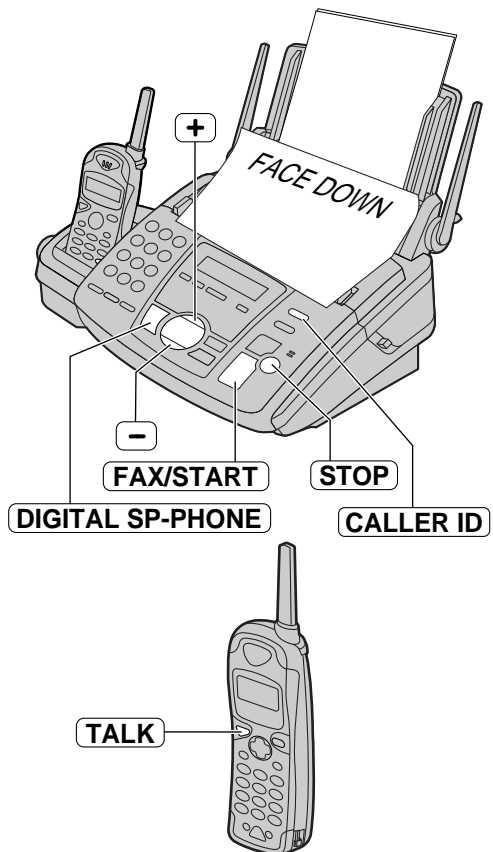

To display the caller's telephone number

Press **CALLER ID** after step 2.

Example (for Australian users):

SAM LEE 11:20A Jul20 ✓	↔	3456789012 11:20A Jul20 ✓
---------------------------	---	------------------------------

This means this call has already been viewed or answered.

Example (for New Zealand users):

3456789012 11:20A Jul20 ✓	↔	SAM LEE 11:20A Jul20 ✓
------------------------------	---	---------------------------

Note:

- Telstra, Optus and Telecom New Zealand do not currently send a NAME for Caller ID.

Display while viewing

NO NAME RCVD

When the unit could not receive a name.

NO CALLER DATA

When no calls have been received.

To stop viewing

Press **STOP** after step 2.

Erasing caller information

You can erase all or specific caller information. Once erased, it cannot be accessed from either the handset or the base unit.

Erasing all caller information using the handset

1 Handset is off the base unit:

Press or .

Handset is on the base unit:

Lift the handset and press or .

Example:

2 Press **CLR**.

3 Press to select "All clear".

4 Press or **CLR**.

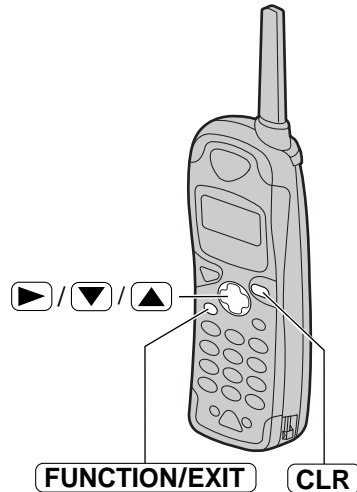

Erasing specific caller information using the handset

1 Handset is off the base unit:

Press or .

Handset is on the base unit:

Lift the handset and press or .

Example:

2 Press or repeatedly until the desired item is displayed.

Example:

3 Press **CLR**.

- Example:
- To erase other items, repeat steps 2 and 3.

4 Press **FUNCTION/EXIT** to exit the program.

Note:

- Telstra, Optus and Telecom New Zealand do not currently send a NAME for Caller ID.

Erasing all caller information using the base unit

- 1** Press **MENU** repeatedly until the following is displayed.

Display: CALLER SET UP
PRESS SET

- 2** Press **SET**.

CALL LIST ERASE
PRESS SET

- 3** Press **SET**.

ERASE ALL OK?
YES: SET/NO: STOP

- To cancel erasing, press **STOP**, then **MENU**.

- 4** Press **SET**.

ERASE COMPLETED

- 5** Press **STOP** to exit the program.

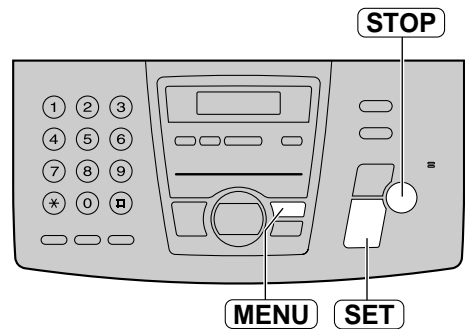

Erasing specific caller information using the base unit

- 1** Press **CALLER ID**.

Example: 2 NEW CALLS
PRESS NAVI. [+ -]

- 2** Press **+** or **-** until the desired item is displayed.

Example: SAM LEE
12:10A Jul20

- 3** Press **ERASE**.

DELETED

Example: ALLAN STONE
12:12A Jul20

- To erase other items, repeat steps 2 and 3.

- 4** Press **STOP** to exit the program.

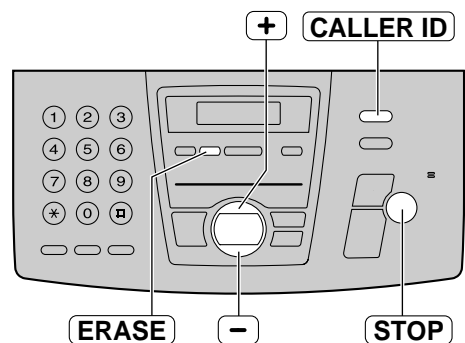

Note:

- Telstra, Optus and Telecom New Zealand do not currently send a NAME for Caller ID.

Storing caller information

Important:

- This feature is not available in the following cases.
 - The telephone number includes data other than numbers (i.e. * or #).
 - The caller information does not include a telephone number.

Into the handset

1 Handset is off the base unit:

Press or .

Handset is on the base unit:

Lift the handset and press or .

Example:

```
3 new calls
▼▲ ▶=Directory
```

2 Press or until the desired item is displayed.

Example:

```
CINDY TURNER
234456789
11:20A JAN.12
```

3 Press .

```
▶Edit
Save directory
▼▲ ▶=Yes
```

4 Press to select "Save directory".

```
Edit
▶Save directory
▼▲ ▶=Yes
```

5 Press .

Example:

```
CINDY TURNER
234456789
```

6 Press **FUNCTION/EXIT** to exit the program.

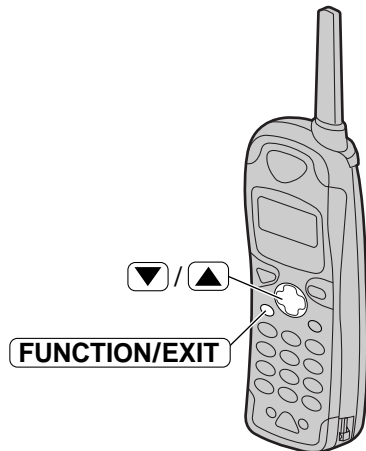

Into the base unit

1 Press **CALLER ID**.

Example:

```
2 NEW CALLS
PRESS NAVI.[+ -]
```

2 Press **+** or **-** until the item desired is displayed.

Example:

```
SAM LEE
11:50A Apr14
```

3 Press **MENU**.

Example:

```
NAME=SAM LEE
STORE:PRESS SET
```

4 Press **SET**.

Example:

```
NO.=1345678901
```

5 Press **SET**.

```
REGISTERED
```

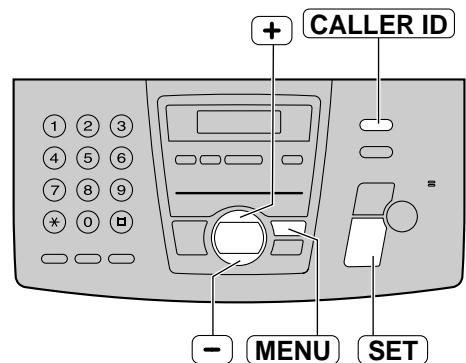

Note:

- You can confirm the stored items on the telephone number list (p. 90).
- The unit can only store a name of up to 10 characters long.
- To edit a name and number, see page 30.
- Telstra, Optus and Telecom New Zealand do not currently send a NAME for Caller ID.

Talking to the other party after fax transmission or reception

You can talk to the other party after a fax message is completed. This will save the added expense and time of making another call.

This feature only works when the other party's fax machine is equipped with a voice contact feature.

Initiating voice contact

- 1 Press **DIGITAL SP-PHONE** while transmitting or receiving documents.

Example:

TO:1234567 VOICE STANDBY

- Your unit will call the other party with a distinctive ring.
- When the other party answers, your unit will emit a distinctive ring.

- 2 To start talking:
 - press **DIGITAL SP-PHONE**,
 - lift the handset from the base unit, or
 - press **TALK** on the handset.

Note:

- If you initiate voice contact during transmission, the unit will call you with a distinctive ring after all of the documents have been transmitted.
- If you initiate voice contact during reception, the unit will call you with a distinctive ring after the current page of the document has been received.

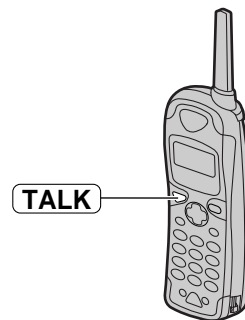
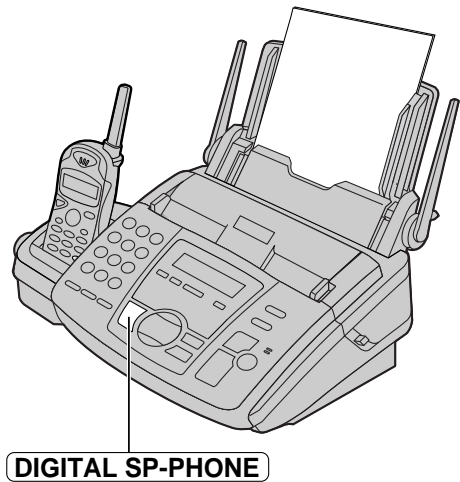

Receiving a request for voice contact

- 1 If the other party initiates voice contact, your unit will sound a distinctive ring and the following will be displayed.

Base unit display:

PLEASE PICK UP

- 2 To start talking:
 - press **DIGITAL SP-PHONE**,
 - lift the handset from the base unit, or
 - press **TALK** on the handset, within 10 seconds of the distinctive ring.

Note:

- If you do not answer within 10 seconds of the distinctive ring;
 - in TAD/FAX mode, your unit will play a greeting message and record an incoming voice message.
 - in FAX ONLY, TEL or TEL/FAX mode, the line will be disconnected.

Sending Faxes

Sending a fax manually

- 1 Adjust the width of the document guides to the size of the document.
- 2 Insert the document (up to 10 pages) **FACE DOWN** until a single beep is heard and the unit grasps the document.

Display:

STANDARD
PRESS NAVI. [+ -]

- 3 If necessary, press **+** or **-** repeatedly to select the desired resolution (see below).

- 4 Press **DIGITAL SP-PHONE**.

Display:

TEL=
PRESS NAVI. [▶]

- 5 Dial the fax number.

Example:

TEL=5678901

- 6 **When a fax tone is heard:**

Press **FAX/START**.
OR

When the other party answers your call:

Ask them to press their start button. When the fax tone is heard, press **FAX/START**.

Display:

CONNECTING.....
STANDARD [±]

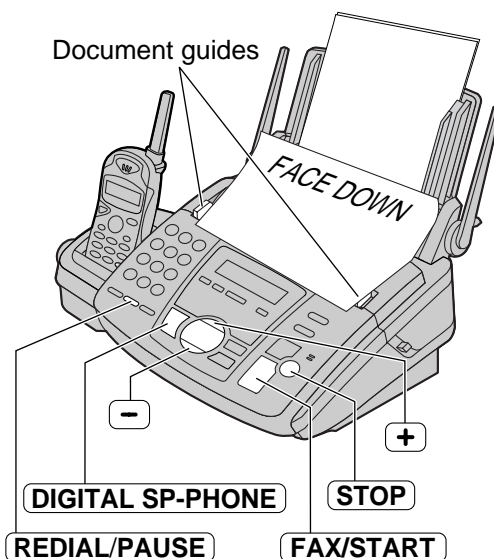

To select the resolution

Select the desired resolution according to the type of document.

- **STANDARD:** For printed or typewritten originals with normal-sized characters.
- **FINE:** For originals with small printing.
- **SUPER FINE:** For originals with very small printing. This setting only works with other compatible fax machines.
- **PHOTO:** For originals containing photographs, shaded drawings, etc.
- Using the "FINE", "SUPER FINE", or "PHOTO" setting will increase transmission time.
- If the resolution setting is changed during feeding, it will be effective from the next sheet.

To stop transmission

Press **STOP**.

To redial the last number

Press **REIDIAL/PAUSE**.

- If the line is busy, the unit will automatically redial the number up to 2 times.
- During redial, the following will be displayed.

Display:

WAITING REDIAL

- To cancel redialling, press **STOP**.

Convenient way to send a fax

You can dial the fax number first before inserting the document. This is convenient if the other party's number is indicated on the document.

1. Enter the fax number.
2. Insert the document.
3. Press **FAX/START**.

To transmit more than 10 pages at a time

- Insert the first 10 pages of the document. Add the other pages (up to 10 at a time) before the last page feeds into the unit.

Sending a fax with the voice guide

You can send documents by following the voice guide.

1. Press **HELP** 2 times.
 2. Press **SET**.
 3. Follow steps 1 to 6 on page 38.
- After transmission, the voice guide will turn off automatically.

Quick scan feature

This feature is helpful when you want to send the document, then take it for other uses. To use this feature, activate feature #34 on page 73.

1. Insert the document.
 2. Enter the fax number.
 3. Press **FAX/START**.
- The document will be fed into the unit and scanned into memory. The unit will then transmit the data. If the document exceeds the memory capacity (p. 91), sending will be cancelled and this feature will be turned off automatically. Transmit the entire document manually.

Sending report for confirmation

This report will provide you with a printed record of transmission results. To use this feature, activate feature #04 (p. 70). For the communication message in the result column, see page 78.

Journal report

The unit stores the 30 most recent fax communication results.

- To print manually, see page 90.
- To print automatically after every 30 new fax communications, activate feature #22 (p. 72).

For the communication message in the result column, see page 78.

Documents you can send

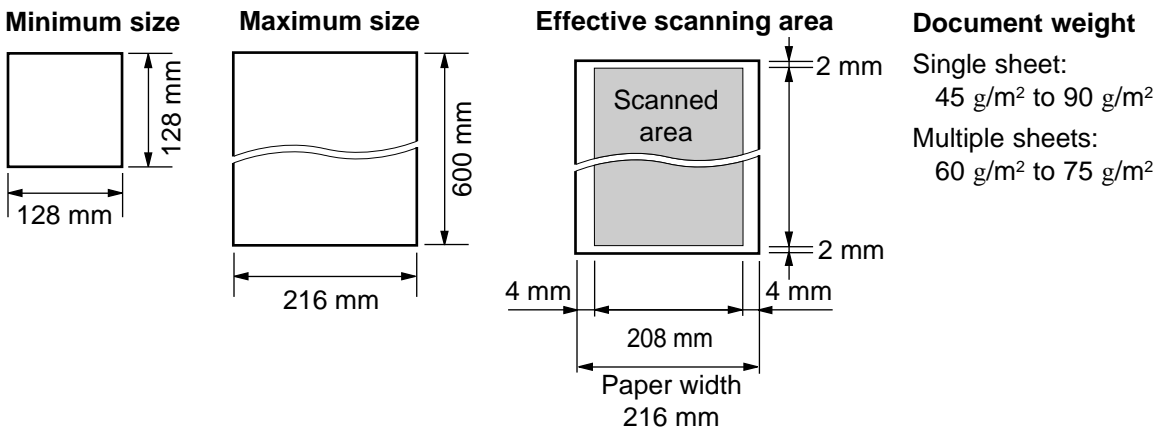

Note:

- Remove clips, staples or other similar fasteners.
- Check that ink, paste or correction fluid has dried.
- Do not send the following types of documents: (Use copies for fax transmission.)
 - Chemically treated paper such as carbon or carbonless duplicating paper
 - Electrostatically charged paper
 - Badly curled, creased or torn paper
 - Paper with a coated surface
 - Paper with a faint image
 - Paper with printing on the opposite side that can be seen through the front (i.e. newspaper)
- To transmit the document(s) with a width of less than standard letter size (216 mm), we recommend using a copy machine to copy the original document onto letter-sized paper, then transmit the copied document.

Sending Faxes

Sending a fax using the directory

Before using this feature, program the desired names and telephone numbers into the directory (p. 28, 29).

- 1 Adjust the width of the document guides to the size of the document.
- 2 Insert the document (up to 10 pages) **FACE DOWN** until a single beep is heard and the unit grasps the document.

Display: STANDARD
PRESS NAVI. [+ -]

- 3 If necessary, press **+** or **-** repeatedly to select the desired resolution (p. 40).

- 4 Press **▶**.

DIRECTORY [+ -]
<MAILBOX>▶

- 5 Press **+** or **-** until the desired item is displayed.

Example: Sam
1789653

- For further details about using the directory, see page 32.

- 6 Press **FAX/START**.

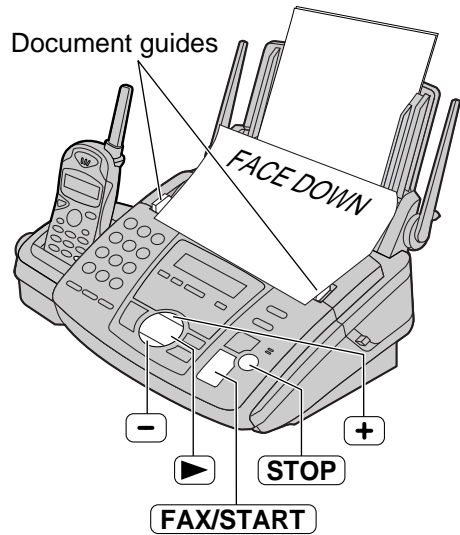

Fax auto redial

If the line is busy or if there is no answer, the unit will automatically redial the number up to 2 times.

- This feature is also available for delayed transmission (feature #25 on page 72).
- During redial, the following will be displayed.

Display: WAITING REDIAL

- To cancel redialing, press **STOP**.

If your unit does not send a fax

- Confirm the stored telephone number on the display and check that the number dialled is answered by the other party's machine (p. 32).
- The connecting tone will be heard during dialling to tell you the status of the other party's machine (feature #76 on page 77).

Broadcast transmission

This feature is useful for sending the same document to selected parties (up to 20 items). First program the items, then see page 45 for transmission.

- To send to selected parties only once, see page 45.

Programming items into the broadcast memory

- 1 Press **MENU** repeatedly until the following is displayed.

Display:

DIRECTORY SET NAVI. =* BROAD=#

- 2 Press **▣** to select "BROAD".

Display:

DIR= [00] NAVI. [+ -] & SET

- 3 Press **+** or **-** until the desired item is displayed.

Example:

MIKE 987-654-3210

- 4 Press **SET**.

Example:

DIR=MIKE [01] STORE:PRESS SET

- To program other items, repeat steps 3 and 4 (up to 20 items).

- 5 Press **SET** to exit the program.

Display:

REGISTERED

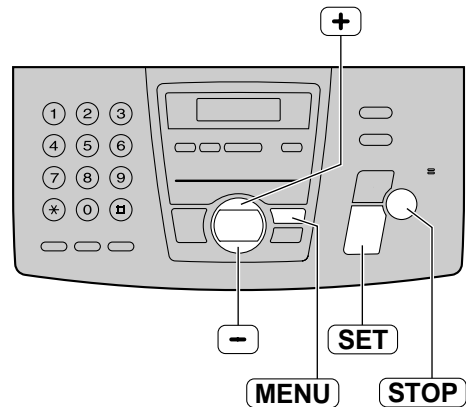

Note:

- If you program the wrong item, press **STOP** after step 4 to erase the item.
- Confirm the stored items by printing a broadcast programming list (p. 90).

Sending Faxes

Adding a new item into the broadcast memory

- 1** Press **[▶]**.
• Confirm that there are no documents in the document entrance.

Display:

DIRECTORY [+ -] <MAILBOX>▶

- 2** Press **[+]** or **[-]** until the following is displayed.

<BROADCAST> EDIT:PRESS MENU

- 3** Press **[MENU]**.

BROADCAST ADD=* DELETE=#

- 4** Press **[*]** to select "ADD".

- 5** Press **[+]** or **[-]** until the desired item you want to add is displayed.

Example:

Mary 584-372-4123

- 6** Press **[SET]**.

REGISTERED



Example:

Nikki 385-217-9365

- To add other items, repeat steps 5 and 6 (up to 20 items).

- 7** Press **[STOP]** to exit the program.

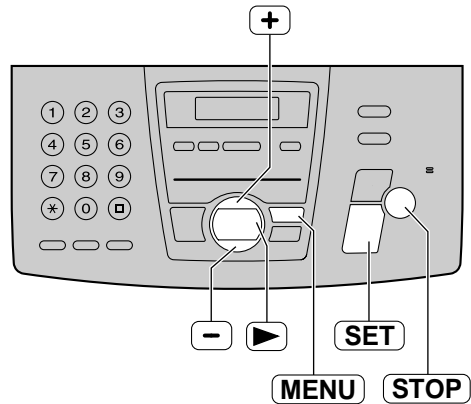

Erasing a stored item in the broadcast memory

- 1** Press **[▶]**.
• Confirm that there are no documents in the document entrance.

Display:

DIRECTORY [+ -] <MAILBOX>▶

- 2** Press **[+]** or **[-]** until the following is displayed.

<BROADCAST> EDIT:PRESS MENU

- 3** Press **[MENU]**.

BROADCAST ADD=* DELETE=#

- 4** Press **[#]** to select "DELETE".

- 5** Press **[+]** or **[-]** until the desired item you want to erase is displayed.

Example:

Dick 328-143-2968

- 6** Press **[SET]**.

DELETE OK? YES:SET/NO:STOP

- 7** Press **[SET]**.

DELETED



Example:

Bob 0123456

- To erase other items, repeat steps 5 to 7.

- 8** Press **[STOP]** to exit the program.

- To cancel erasing, press **[STOP]**.

Sending the same document to pre-programmed parties

- 1 Insert the document **FACE DOWN**.
 - If necessary, press **+** or **-** repeatedly to select the desired resolution (p. 40).

- 2 Press **▶**.

Display:

DIRECTORY [+ -] <MAILBOX>▶

- 3 Press **+** or **-** until the following is displayed.

<BROADCAST> SEND:PRESS SET

- 4 Press **SET**.
 - The document will be fed into the unit and scanned into memory. The unit will then transmit the data to each item, calling each number sequentially.
 - After transmission, the stored document will be erased automatically, and the unit will automatically print a broadcast sending report.

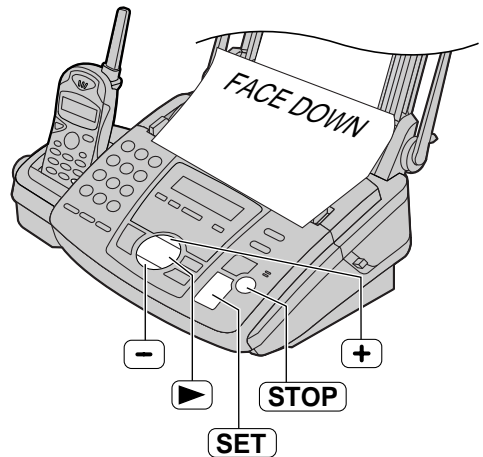

Note:

- If you select the "FINE", "SUPER FINE" or "PHOTO" resolution, the number of pages that the unit can transmit will decrease.
- If the document exceeds the memory capacity (p. 91), sending will be cancelled.
- If one of the items is busy or does not answer, it will be skipped. All skipped items will be redialled up to 2 times after all of the other items have been called.

To send to selected parties only once

You can also select the parties for each transmission.

1. Follow steps 1 and 2 above.
2. Press **+** or **-** until the following is displayed.

Display:

<ONE TIME BROAD> PRESS SET

3. Press **SET** to start programming the items you want to transmit.

DIR=	[00]
NAVI.[+ -]	& SET

4. Press **+** or **-** until the desired item you want to transmit is displayed.

Example:

Bill
6543210

5. Press **SET**.

Example:

DIR=Bill	[01]
SEND:PRESS	SET

- To program other items, repeat steps 4 and 5 (up to 20 items).
6. Press **SET** to start transmission to the programmed items.

To cancel the broadcast setting

1. Press **STOP** while the unit displays the following.

Display:

BROADCASTING

- The display will show the following.

SEND CANCELLED?
YES:SET/NO:STOP

2. Press **SET**.

Receiving Faxes

Setting the unit to receive faxes

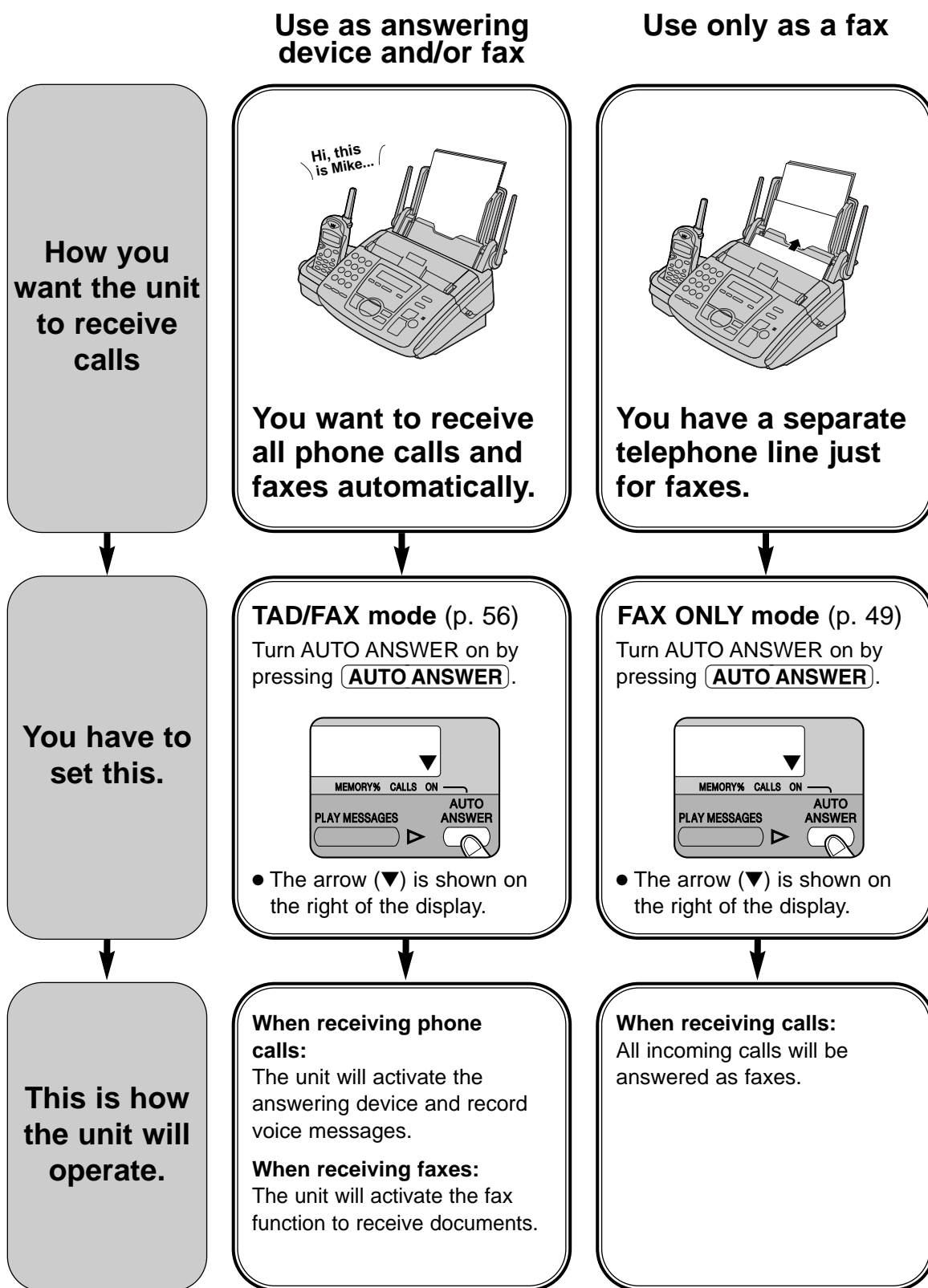

Use as telephone/ automatic fax

Fax receiving Phone call

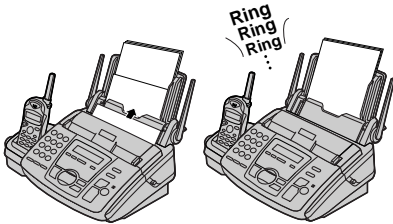

**You want to answer
the phone call
yourself and receive
faxes without rings.**

Mostly phone calls



**You plan to answer
the calls yourself.**

Other option

Remote fax activation

You can also receive a fax using an extension telephone. While hearing a fax calling tone with an extension telephone, press ***9** (pre-selected fax activation code) to receive a fax (p. 52).

TEL/FAX mode (p. 50)

Turn AUTO ANSWER on by pressing **AUTO ANSWER**.

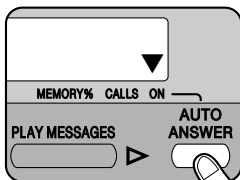

- The arrow (▼) is shown on the right of the display.

TEL mode (p. 48)

Turn AUTO ANSWER off by pressing **AUTO ANSWER**.

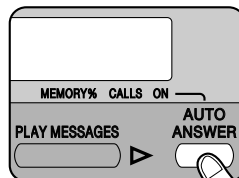

- The arrow (▼) is not shown on the right of the display.

When receiving phone calls:

The unit will ring.

When receiving faxes:

The unit will receive fax documents without ringing.

When receiving calls:

You have to answer all calls manually.

To receive a fax document, press **FAX/START** for each fax you are receiving.

Receiving Faxes

TEL mode (answering all calls manually)

Activating TEL mode

If the arrow (▼) is shown on the right of the display, turn it off by pressing **AUTO ANSWER**.

Display: TEL MODE ON

Receiving a fax using the base unit

1 When the unit rings, press **DIGITAL SP-PHONE** or lift the handset and press **TALK** to answer the call.

2 When:
— document reception is required,
— a fax calling tone (slow beep) is heard, or
— no sound is heard,
press **FAX/START**.

Display: CONNECTING.....

- The unit will start fax reception.

Receiving a fax using the handset

1 When the handset rings, press **TALK**.

2 When:
— document reception is required,
— a fax calling tone (slow beep) is heard, or
— no sound is heard,
press **FAX RECEIVE** until a single beep is heard.

- The unit will start fax reception.

To stop receiving

Press **STOP**.

Friendly reception feature

When you answer a call and hear a fax calling tone (slow beep), the unit will automatically start fax reception.

- If this feature is not required, set feature #46 to off (p. 75).

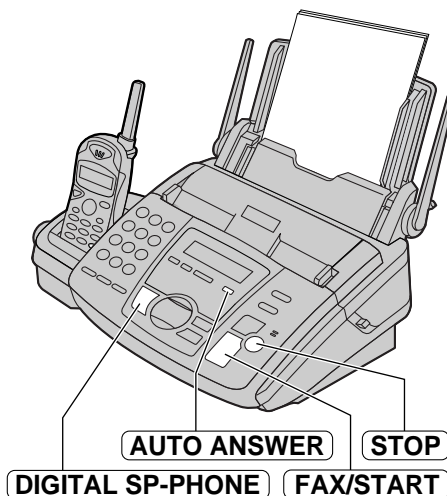

Note:

- If you do not answer the call within 10 rings, the unit will temporarily activate the answering device. The greeting message will then be played and the other party can then send a fax.
- Up to 30 sheets of printed paper can be held. Remove the printed paper before it exceeds 30 sheets.

Fax reception in memory

When a printing problem is detected, the unit will temporarily store the received document into memory.

While the document is in memory:

- the display will show an error message and the following alternately,

Display: FAX IN MEMORY

— slow beeps will sound if feature #44 is set to on (p. 74).

- Follow the instructions on pages 79 and 80 to solve the problem.
- For memory capacity, see page 91.

FAX ONLY mode ===== (all calls are received as faxes)

Activating FAX ONLY mode

1 Set feature #77 to "FAX ONLY" (p. 77).

2 If the arrow (▼) is not shown on the right of the display, turn it on by pressing **AUTO ANSWER**.

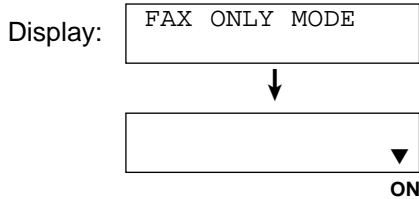

- When receiving calls, the unit will automatically answer all calls and only receive fax documents.

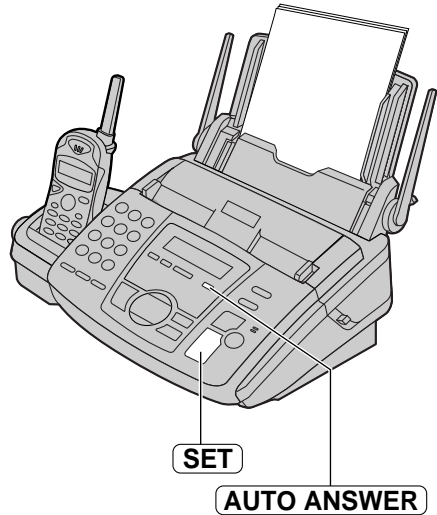

Note:

- The number of rings before a call is answered in FAX ONLY mode can be changed (feature #06 on page 70).
- This mode should not be used with a telephone line which is used for both phone calls and faxes. Fax communication will be attempted even if someone is trying to call you. We recommend the following setup:

Example:

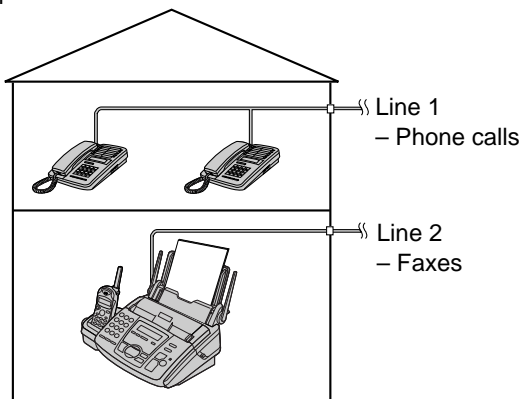

Only a fax machine is connected.

Receiving Faxes

TEL/FAX mode (receiving phone calls with ring signals and faxes without ring signals when you are near the unit)

Use this mode when you are situated near the fax machine, and want to receive faxes without the unit ringing. When a call is received, the fax machine will work as follows. To set TEL/FAX mode, see below.

A call is received.

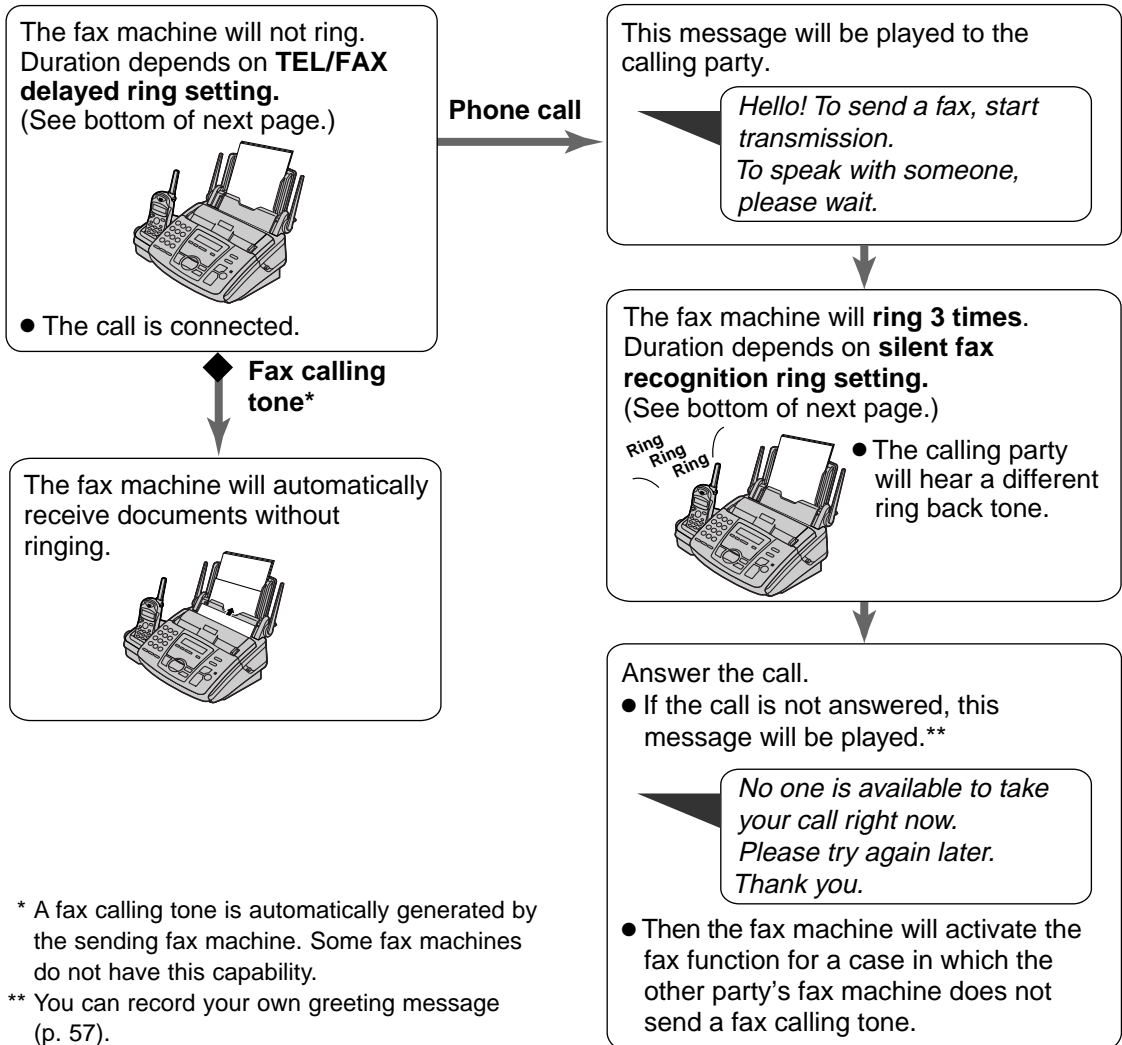

* A fax calling tone is automatically generated by the sending fax machine. Some fax machines do not have this capability.

** You can record your own greeting message (p. 57).

Note:

- The base unit will display the following when a call is received.

Display:
INCOMING CALL

- The ringer should be on (p. 23).
- If the ring detection (p. 53) is set and a different ring pattern is received, the unit will not receive

To set TEL/FAX mode

1. Set feature #77 to "TEL/FAX" (p. 77).
2. If the arrow (▼) is not shown on the right of the display, turn it on by pressing

AUTO ANSWER.

Display:

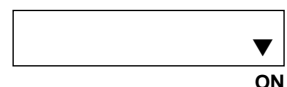

When an extension telephone is connected

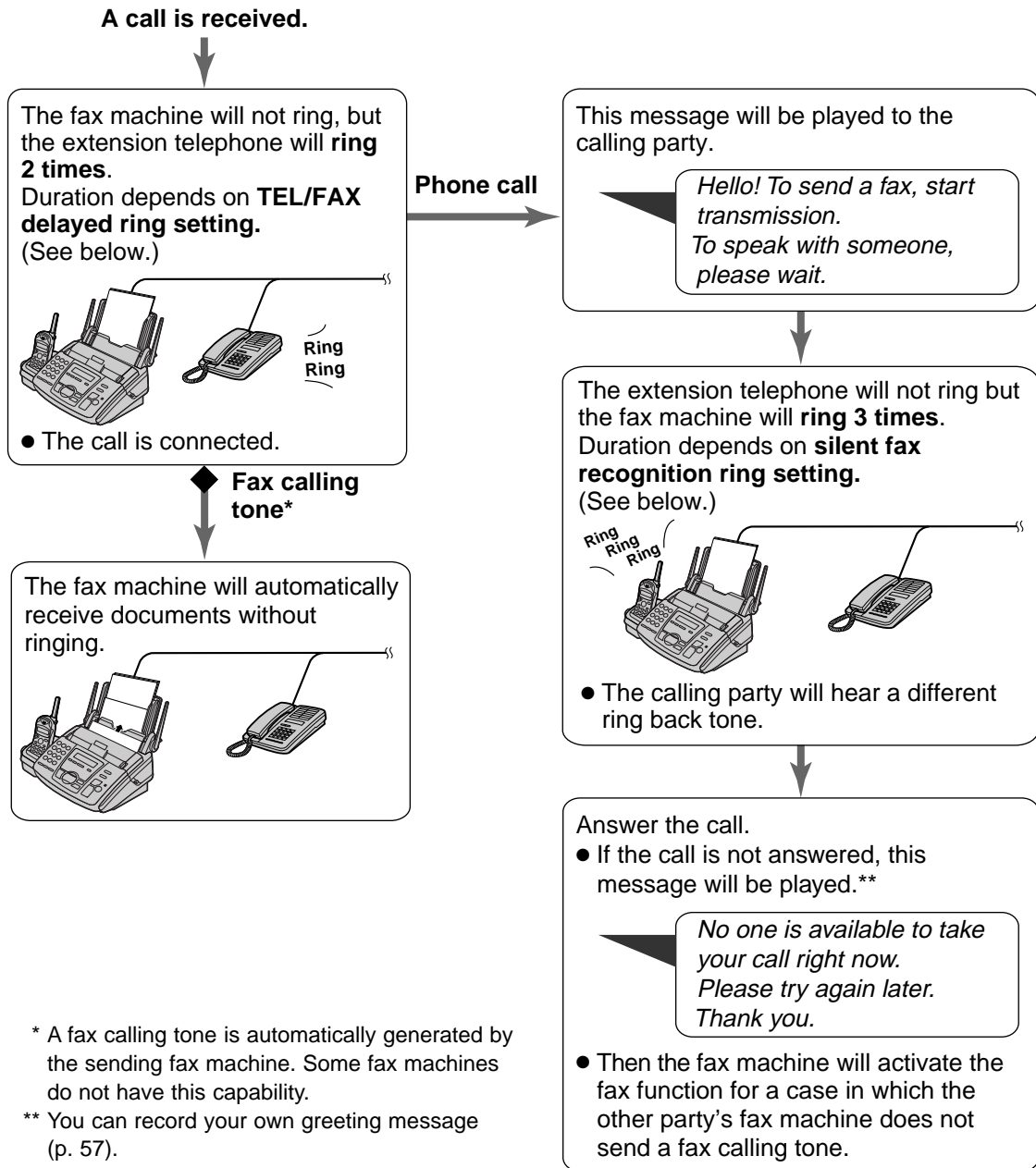

* A fax calling tone is automatically generated by the sending fax machine. Some fax machines do not have this capability.

** You can record your own greeting message (p. 57).

TEL/FAX delayed ring setting

The number of rings generated before the fax machine answers depends on the setting of feature #78 on page 77. The fax machine will not generate an audible ring during this time.

Silent fax recognition ring setting

The fax machine generates audible rings to indicate that it is receiving a phone call. The number of rings generated depends on the setting of feature #30 on page 73. This signal will not ring on an extension telephone.

Receiving Faxes

Extension telephone

If you use the fax machine with an extension telephone, you can receive fax documents using the extension telephone. You do not have to press **FAX/START** on the fax machine.

Important:

- Use a touch tone telephone as the extension telephone and enter the fax activation code **firmly**.

- 1** When the extension telephone rings, lift the handset of the extension telephone.
- 2** When:
 - document reception is required,
 - a fax calling tone (slow beep) is heard, or
 - no sound is heard,press ***9** (pre-selected fax activation code) **firmly**.
- 3** Hang up the handset.
 - The fax machine will start reception.

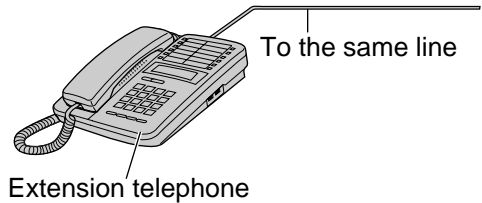

Note:

- You can change the fax activation code in feature #41 (p. 74).

Pager call - when the unit receives a fax or voice message

This feature allows your unit to call your pager when your unit receives a fax document or an incoming voice message.

- 1** Press **MENU**.
Display:

```
SYSTEM SET UP  
PRESS NAVI. [ < > ]
```
- 2** Press **#**, then **70**.

```
PAGER CALL  
MODE=OFF [ ± ]
```
- 3** Press **+** or **-** to select "ON".

```
PAGER CALL  
MODE=ON [ ± ]
```

 - If this feature is not required, select "OFF".

- 4** Press **SET**.
- 5** Enter your pager number.
 - You can enter a total of 46 digits and/or pauses.

Example:

1 202 555 1234PP12345678PP5555#

Your pager number

Pauses

Your pager access code, if required.

Message you want displayed on your pager.

- 6** Press **SET**.
 - The unit will dial the stored number.

```
PAGER TEST
```
- 7** Check that your pager received the pager test call.
- 8** Press **DIGITAL SP-PHONE**.

When your pager receives a pager call

Your pager will display the message you entered in step 5. (For example: 5555)

Receiving Faxes / Distinctive Ring

Receive polling (retrieving a fax placed on another fax machine)

This feature allows you to retrieve a document from another compatible machine. Therefore you pay for the call.

Make sure that no documents are fed into your unit and that the other party's machine is ready for your call.

- 1 Press **MENU** repeatedly until the following is displayed.

Display:

POLLING PRESS SET

- 2 Press **SET**.

- 3 Dial the fax number.

Example:

FAX=3331111

- 4 Press **SET**.

CONNECTING.....

- The unit will start reception.

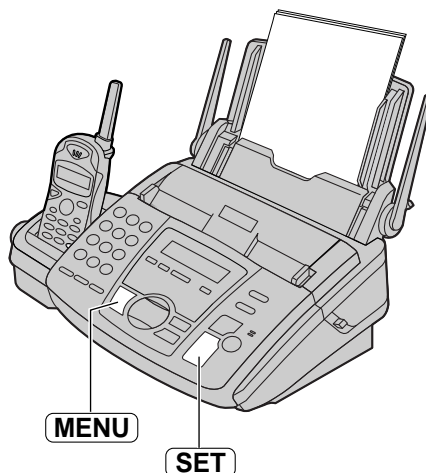

Using with the ring detection feature

This feature is only for use if you subscribe to a distinctive ring pattern service from your telephone company. For more information on the availability of this service in your area, please contact your telephone company before setting this feature on your unit.

In Australia, this service is called "Fax Stream Duet".

In New Zealand, this service is called "FaxAbility".

When you subscribe to Distinctive Ring Service, your telephone company will assign you a new fax number and will also tell you the assigned ring pattern. Please complete the following setup on your fax machine to identify the assigned ring pattern.

- 1 Press **MENU**.

Display:

SYSTEM SET UP PRESS NAVI. [◀ ▶]

- 2 Press **+**, then **3** **1**.

RING DETECTION MODE=OFF [±]

- 3 Press **+** or **-** to select the ring pattern assigned by the telephone company.

- A: Standard ring (one long ring)
- B: Double ring (two short rings)
- C: Triple ring (short-long-short-rings)
- D: Other triple ring (short-short-long rings)
- OFF: Turns off the feature (**default setting**).

- 4 Press **SET**.

SETUP ITEM []

- 5 Press **MENU**.

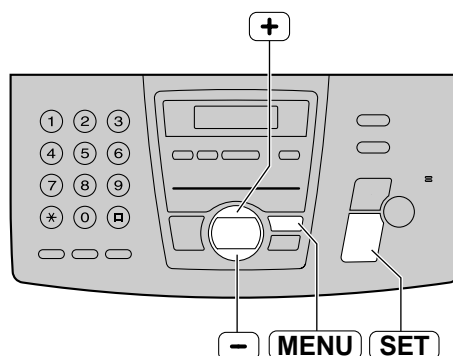

Note:

- Once you have programmed the assigned ring pattern into the fax machine, turn AUTO ANSWER off so that the fax machine is in TEL mode.
- In TEL mode, the fax machine will recognize incoming faxes on the first ring pattern and answer automatically. For phone calls, the fax machine will ring as a normal call.

Copying

Making a copy

The unit can make single or multiple copies (up to 50).

1 Adjust the width of the document guides to the size of the document.

2 Insert the document (up to 10 pages) **FACE DOWN** until a single beep is heard and the unit grasps the document.

Display: STANDARD
PRESS NAVI. [+ -]

- If necessary, press **[+]** or **[-]** repeatedly to select the desired resolution (see below).

3 Press **[COPY]**.

NUMBER=1
COPY:PRESS START



NUMBER=1
OR PRESS NAVI. ▶

- If necessary, enter the number of copies (up to 50).

4 Press **[START]**.

- The unit will start copying.

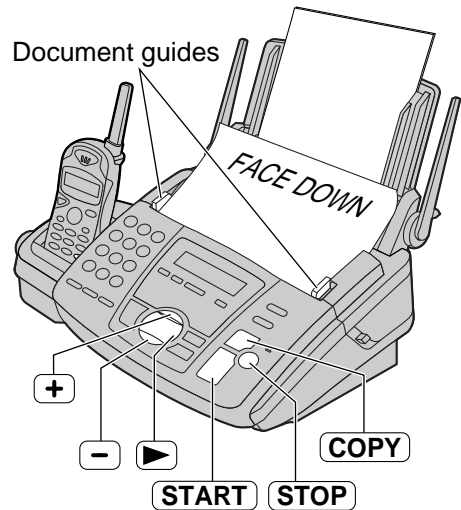

Note:

- Any transmittable document can be copied (p. 41).

To select the resolution

Select the desired resolution according to the type of document.

- **FINE**: For printed or typewritten originals with small printing.
- **SUPER FINE**: For originals with very small printing.
- **PHOTO**: For originals containing photographs, shaded drawings, etc.
- If you select “STANDARD”, copying will be done using “FINE” mode.
- You can also select the resolution after pressing **[COPY]** in step 3.

1. Press **[▶]** 3 times.

Display: STANDARD [+ -]
<NUMBER> ▶

2. Press **[+]** or **[-]** repeatedly to select the desired resolution.

Quick scan feature

This feature is helpful when you want to copy the document, then take it for other uses. To use this feature, activate feature #34 on page 73.

- The document will be fed into the unit and scanned into memory. The unit will then print the data.

If the document exceeds the memory capacity (p. 91), copying will be cancelled and this feature will be turned off automatically.

To stop copying

Press **[STOP]**.

To enlarge a document

1. Press **[▶]** after step 3 on page 54.

Display: ZOOM 100% [+ -]
<COLLATE>▶

2. Press **[+]** to select "150%" or "200%", then press **[START]**.
 - The unit will only enlarge the centremost part of the document, printing it on two pages.

Example of a 150% enlarged copy

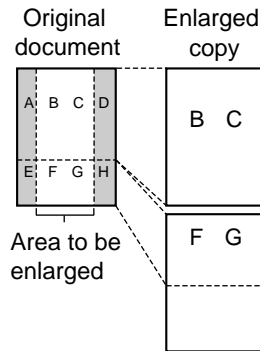

Example of a 200% enlarged copy

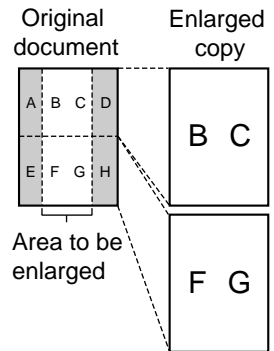

To reduce a document

1. Press **[▶]** after step 3 on page 54.

Display: ZOOM 100% [+ -]
<COLLATE>▶

2. Press **[-]** to select "92%", "86%" or "72%", then press **[START]**.
 - See the right table for the recommended reduction rates.

Setting	Recording paper	Original document
100% (default)	A4	A4, Letter
92%	A4	A4
86%	A4	A4
72%	A4	Legal

Note:

- If the appropriate reduction rate is not selected, the document may be divided and the top of the second sheet will be deleted.
- If the image at the bottom of the document is not copied when you copy a document as long as the recording paper, try 92% or 86%.

Letter = 216 mm x 279 mm
 Legal = 216 mm x 356 mm
 A4 = 210 mm x 297 mm

To collate multiple copies

The unit can collate multiple copies in the same order as the original document pages.

1. Press **[▶]** 2 times after step 3 on page 54.

Display: COLLATE OFF [+ -]
<RESOLUTION>▶

2. Press **[+]** or **[-]** repeatedly until the following is displayed.

COLLATE ON [+ -]
<RESOLUTION>▶

3. Press **[START]**.

Note:

- The unit will store the documents into memory while collating the copies. If memory becomes full while storing, the unit will only print out the stored pages.
- After copying, the collating feature will turn off automatically.

Example: Making two copies of a 4-page original document

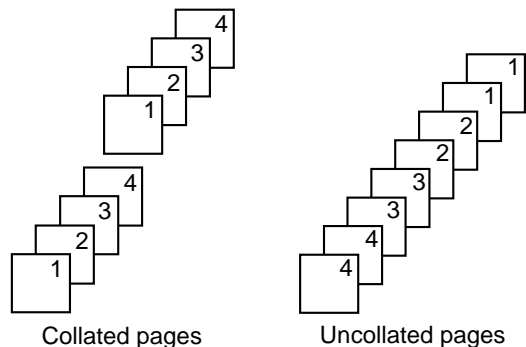

TAD/FAX mode (receiving phone calls and faxes automatically)

When TAD/FAX mode is set, the unit will work as a fax machine and/or answering device. If a fax tone is detected, the unit will automatically receive the fax. If a phone call is detected, the answering device will play a greeting message and the caller can leave a voice message.

Setting up the voice and fax message reception

- 1 Make sure that feature #77 is set to "TAD/FAX" (p. 77).
- 2 If the arrow (▼) is not shown on the right of the display, turn it on by pressing **AUTO ANSWER**.

Display:

- The unit will play the pre-recorded greeting message.
- The remaining time for recording incoming messages will be displayed.

Example:

- You can change the speaker volume. Press **+** or **-** while listening to the greeting message.

Note:

- The incoming message recording time can be changed (feature #10 on page 71).
- When the remaining time is low, erase unnecessary messages (p. 59). For the voice memory capacity of incoming messages, see page 91.
- While an incoming call is being recorded, you can monitor it through the speaker. If this feature is not required, set feature #67 to off (p. 76).

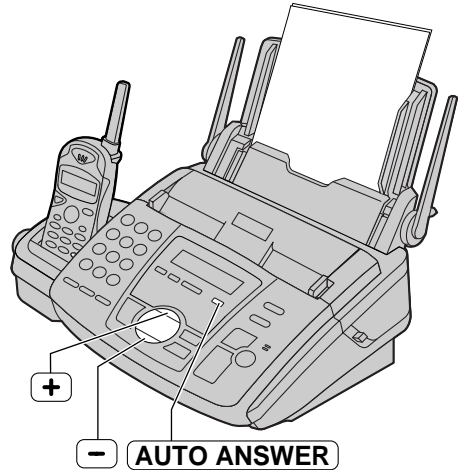

Ring setting in TAD/FAX mode

You can choose from 2, 3, 4, 5, 6, 7, 8, 9, TOLL SAVER and RINGER OFF.

This setting can be changed by feature #06 on page 70.

TOLL SAVER: When you call the unit from a remote location, the number of rings will tell you if there are any new voice messages. If the unit answers on the 2nd ring, there is at least one new recorded message. If the unit answers on the 4th ring, there are no new recorded messages. To save the toll charges for the call, hang up immediately when you hear the 3rd ring. The 3rd ring indicates that there are no new recorded messages.

RINGER OFF: The unit will answer without ringing.

Recording your own greeting messages

You can record your own greeting messages for TAD/FAX and TEL/FAX modes. When receiving a call, your own greeting message will be played instead of the pre-recorded message. The recording time will be limited to 16 seconds. We recommend you record your message within 12 seconds to make it easier to receive faxes.

Suggested messages:

- TAD/FAX greeting message: *"This is (your name, business and/or telephone number). We are unable to answer right now. To send a fax, start transmission. To leave a message, speak after the beep. Thank you."*
- TEL/FAX greeting message: *"This is (your name, business and/or telephone number). We are unable to answer right now. Please try again later. Thank you."*

1 Select the desired mode (TAD/FAX or TEL/FAX) where you want to record a greeting message (feature #77 on page 77).

2 Press **RECORD** 2 times.

- The display will show the following according to your selection in step 1.

TAD/FAX mode:

TAD GREETING PRESS SET

TEL/FAX mode:

TEL/FAX GREETING PRESS SET

3 Press **SET**.

- A long beep will sound.

4 Speak clearly about 20 cm (8 inches) away from the microphone.

- The display will show the remaining recording time.

TAD/FAX mode:

TAD	REC.	16s
-----	------	-----

TEL/FAX mode:

T/F	REC.	16s
-----	------	-----

5 When finished recording, press **STOP**.

- The unit will repeat your message. Adjust the volume using **+** or **-**.

Note:

- You can choose 60 seconds for your own TAD/FAX greeting message (feature #54 on page 75).
 - If you change to 60 seconds, we recommend that you tell the caller in your own TAD/FAX greeting message to press *9 before starting fax transmission.
 - If you change to 16 seconds from 60 seconds, your own recorded TAD/FAX greeting message will be deleted. When receiving a call, the pre-recorded message will be played.

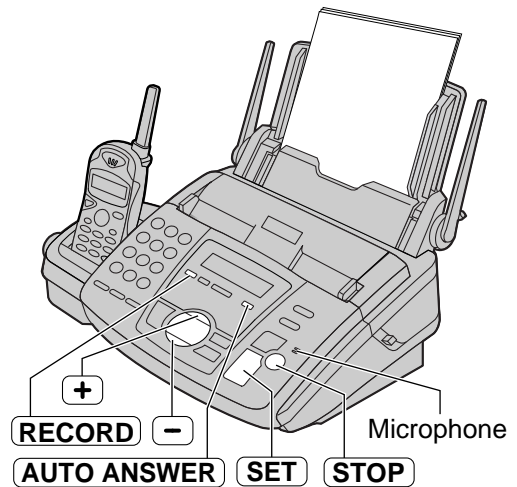

Checking the greeting messages

1. Select the desired mode (TAD/FAX or TEL/FAX) for the greeting message you want to listen to (feature #77 on page 77).
2. If the arrow (▼) is not shown on the right of the display, turn it on by pressing **AUTO ANSWER**.

If the arrow (▼) is shown on the right of the display, turn it off once then on again.

- The display will show the following according to your selection in step 1.

TAD/FAX mode:

TAD/FAX MODE

TEL/FAX mode:

TEL/FAX MODE

- The unit will play the greeting message.

Greeting / Memo Message

Erasing your own recorded greeting messages

1 Select the desired mode (TAD/FAX or TEL/FAX) for the greeting message you want to erase (feature #77 on page 77).

2 Press **ERASE** 2 times.
• The display will show the following according to your selection in step 1.

TAD/FAX mode:

TAD GREETING PRESS SET

TEL/FAX mode:

TEL/FAX GREETING PRESS SET

3 Press **SET**.

ERASE GREETING? YES : SET / NO : STOP
--

• To cancel erasing, press **STOP**.

4 Press **SET**.

GREETING ERASED

• When receiving a call, the pre-recorded greeting message will be played.

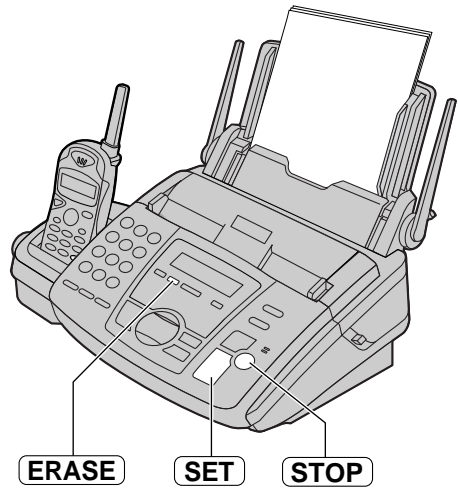

Leaving a message for others or yourself

To leave a private message for yourself or someone else, you can record a voice memo. This memo can be played back later, either directly or remotely.

1 Press **RECORD**.

Display:

MEMO MESSAGE PRESS SET

2 Press **SET**.
• A long beep will sound.

MEMO RECORDING

3 Speak clearly about 20 cm (8 inches) away from the microphone.

4 When finished recording, press **STOP**.

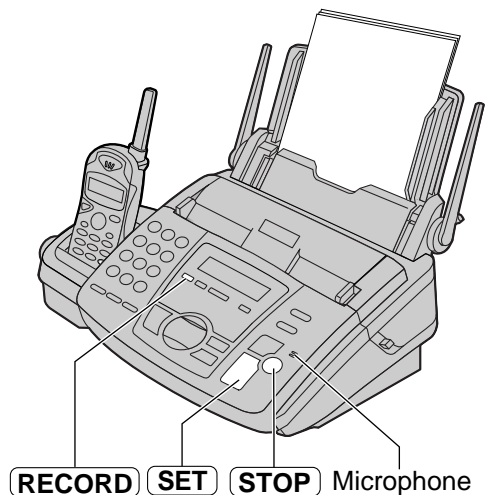

Listening to recorded messages using the base unit

When the unit has recorded new voice messages:

- the PLAY MESSAGES indicator will flash,
- the call counter will show the total number of recorded messages, and
- slow beeps will sound if the message alert feature is activated (feature #42 on page 74).

Example: 
Call counter

Press **PLAY MESSAGES**.

- Only the new recorded messages will be played.
- Adjust the speaker volume using **+** or **-**.
- After playing back all of the new messages, the PLAY MESSAGES indicator will stop flashing but will remain lit up.
If you press **PLAY MESSAGES** at this time, all the recorded messages will be played.

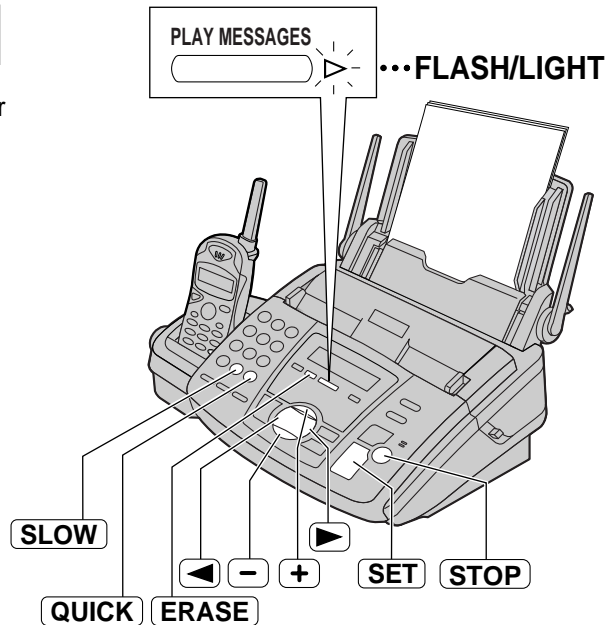

To repeat a message

Press **◀** while listening to the message.

- If you press **◀** within 5 seconds of the beginning of the message, the previous message will be played.
- To play back a specific message, press **◀** or **▶** and search for the message you want to listen to.

To skip a message

Press **▶** to play the next message.

To stop playback

Press **STOP**.

- If you press **PLAY MESSAGES** within 1 minute, the unit will resume playing the rest of the messages.

Voice time/day stamp

During playback, a synthesised voice will announce the time and day of the week that each message was recorded.

To change the playback speed

Press **QUICK** to play messages at one and a half times the original speed.

Press **SLOW** to play messages at half the original speed.

- To return to the original speed, press **QUICK** or **SLOW** again during quick or slow playback.

To erase a specific message

Press **ERASE** while listening to the message you want to erase.

To erase all the messages

Check that you have listened to all of the recorded messages.

1. Press **ERASE**.

Display: 

2. Press **SET**.

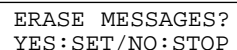

3. Press **SET**.

- Messages recorded in voice mailbox will not be erased.

Incoming Messages

Listening to recorded messages using the handset

1 Press **PLAYBACK**.

Example: Remote operation

- The voice guide will tell you the number of new messages and they will be played automatically.

Voice guide example:

3 new messages.

- **To repeat only the new messages:**
Press **4**.
- **To listen to all the messages:**
Press **5**.

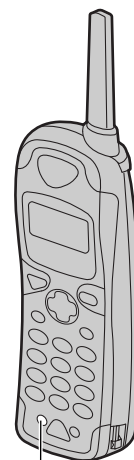

PLAYBACK

2 Press **PLAYBACK** to end the operation.

When there are no new messages

The voice guide will be heard.

Voice guide example:

No new messages.

Press **5** or wait 4 seconds to listen to all the messages.

When voice memory is full

The voice guide will be heard after playing the messages.

Voice guide example:

Sorry, no more memory.
Please erase unnecessary messages.

Erase some or all of the messages.

To repeat a message

Press **1** while listening to the message.

- If you press **1** within 5 seconds of the beginning of the message, the previous message will be played.

To skip a message

Press **2** to play the next message.

To erase a specific message

Press ***4** while listening to the message you want to erase.

Voice guide example:

The message has been erased.

- A long beep will sound. The unit will then play back the next message.

To erase all the messages

Press ***5** to erase all the messages.

Voice guide example:

All messages have been erased.

- A long beep will sound.

To turn AUTO ANSWER on or off

To turn AUTO ANSWER on (TAD/FAX mode), press **7**.

To turn AUTO ANSWER off (TEL mode), press **9**.

Operating from a remote location

The following operations can be performed from a remote location using a touch tone telephone. **Program the remote operation ID (feature #11 on page 71) and set the unit to TAD/FAX mode before going out (p. 56).**

Dial key	Remote command	Page	Dial key	Remote command	Page
0	Skips the greeting message	63	*4	Erases a specific message	63
1	Repeats a message	62	*5	Erases all messages	63
2	Skips a message	62	80	Changes to TEL mode	63
4	New message playback	62	81	Turns ON message transfer	63
5	All message playback	62	82	Turns OFF message transfer	63
6	Room monitor	63	83	Turns ON pager call	63
7	Re-records a greeting message	63	84	Turns OFF pager call	63
9	Stops re-recording of a greeting message	63			

Remote operation card

Please cut out and carry this card for assistance when using the remote operation.

Mailbox Remote Operation

- Recording a message in a mailbox:**
 1. Call your unit.
 2. Press * and the mailbox no. (1 or 2).
 3. Leave a message.
- Retrieving messages from a mailbox:**
 1. Call your unit.
 2. Press * and the mailbox no. (1 or 2).
 3. Enter the mailbox password □□□.
 4. Press the remote command key (see the reverse side).
 - 81, 82, 83 and 84 cannot be used.

Fold here

Notice of Remote Operation

- The remote operation is available only from a touch tone telephone when the unit is in TAD/FAX mode.
- When the unit is in TEL mode, call your unit and wait for 10 rings. The answering device will temporarily answer the line. Enter the remote operation ID during the greeting message. The unit will switch to TAD/FAX mode.
- When you press a key, press firmly.
- To send a document, press *9. When a fax tone is heard, start transmission.

Remote Operation

Listening to recorded messages

1 Call your unit from a remote touch tone telephone.

2 Enter the remote operation ID during TAD/FAX greeting playback.

When there are new messages

The voice guide will tell you the number of new messages and they will be played automatically.

Voice guide example:

3 new messages.

- **To repeat a message:**

Press **1**.

If you press **1** within 5 seconds of the beginning of a message, the previous message will be played.

- **To skip a message:**

Press **2**.

- **To repeat only the new messages:**

Press **4**.

- **To listen to all the messages:**

Press **5**.

When there are no new messages

No new messages.

Press **5** or wait for 4 seconds to listen to all the messages.

When voice memory is full

*Sorry, no more memory.
Please erase unnecessary messages.*

Erase some or all of the messages (p. 63).

Answering Device Remote Operation

1. Call your unit.
2. Enter the remote operation ID during the greeting message.
 - The new messages will be played automatically.
 - If there are no new messages, wait for 4 seconds. All the messages will be played back.
3. Press the remote command key(s) within 10 seconds.

Key	Remote command
0	Skips the greeting message
1	Repeats a message
2	Skips a message

Key	Remote command
4	New message playback
5	All message playback
6	Room monitor
7	Re-records a greeting message
9	Stops re-recording of a greeting message
* 4	Erases a specific message
* 5	Erases all messages
8 0	Changes to TEL mode
8 1	Turns ON message transfer
8 2	Turns OFF message transfer
8 3	Turns ON pager call
8 4	Turns OFF pager call

Other remote operations

■ Erasing a specific message

Press **[*]4** while listening to the message you want to erase.

Voice guide example:

The message has been erased.

- A long beep will sound. The unit will then play back the next message.

■ Erasing all the messages

Press **[*]5** to erase all the messages.

All messages have been erased.

- A long beep will sound.

■ Monitoring the room (Australian users only)

Press **[6]** to monitor the sound for about 30 seconds in the room where the unit is installed.

- After 30 seconds, a beep sounds. To continue monitoring, press **[6]** again within 10 seconds.

■ Recording a marker message

You can leave an additional message.

1. Wait for the voice guide.

All messages have been played.

2. Wait about 10 seconds.

Please leave your name and message after the beep.

3. Leave a message after the beep.

■ Re-recording a greeting message

You can change the contents of the greeting messages for TAD/FAX mode.

1. Press **[7]** to start recording.
 - A long beep will sound.
2. Speak clearly up to 16 seconds.
 - If you pause for over 2 seconds, 6 beeps will sound and the recording will stop. Repeat from step 1 within 10 seconds.
3. When finished recording, press **[9]**.
 - The new greeting message will be played.

■ Skipping the greeting message

Press **[0]** during the greeting message playback.

- The unit will skip the rest of the greeting message.

■ Turning the message transfer on or off

You must program a transfer telephone number beforehand (feature #60 on page 76).

Press **[8]1** to turn ON the message transfer.

*Message transfer is set.
Transfer phone number is 123...*

Press **[8]2** to turn OFF the message transfer.

Message transfer is off.

- If a transfer telephone number is not programmed, you cannot turn this feature ON.

Transfer phone number is not set.

■ Turning the pager call on or off

You must program a pager number beforehand (feature #70 on page 77).

Press **[8]3** to turn ON the pager call.

*Pager call is set.
Pager number is 098765432.*

Press **[8]4** to turn OFF the pager call.

Pager call is off.

- If a pager number is not programmed, you cannot turn this feature ON.

Pager number is not set.

■ Changing the receive mode

Press **[8]0** to change the receive mode from TAD/FAX to TEL.

- You cannot return to TAD/FAX mode in the same call. To return to TAD/FAX mode, see below.

■ Returning to TAD/FAX mode

1. Call your unit and wait for 10 rings.
 - The answering device will temporarily answer the call.
2. Enter the remote operation ID during the greeting message.
 - Your unit will switch to TAD/FAX mode.



How callers can leave you private messages

This unit has two mailbox memories. Your caller can leave a private message in a specific mailbox. Only the person who knows the password can retrieve a message from a mailbox. This feature is useful when you share this unit with other people.

To use a mailbox

1. Record your own TAD/FAX greeting message (p. 57).
Suggested message: *"This is (your name). We are unable to answer right now. To send a fax, start transmission. To leave a message, speak after the beep. To leave a private message, press  and the desired mailbox number 1 or 2. Thank you."*
2. Record your own mailbox greeting message if necessary (p. 65).
Suggested message: *"This is (personal name). Please leave your name and message after the beep."*
3. Change the mailbox password if necessary.
 - For mailbox 1 password, see feature #51 on page 75.
 - For mailbox 2 password, see feature #52 on page 75.
4. Set the unit to TAD/FAX mode (p. 56).

How incoming messages are recorded in a mailbox

- 1 Call your unit from a remote touch tone telephone.
 - The TAD/FAX greeting message will be played.
- 2 Press  and the desired mailbox number ( or ).
 - A mailbox greeting message will be played.
- 3 After the beep, leave a message.

Note:

- If the caller does not enter the mailbox number in step 2, the message will be recorded in the common memory.

Recording your own mailbox greeting messages

The recording time is limited to 16 seconds for each mailbox.

Suggested message: "This is (personal name). Please leave your name and message after the beep."

1 Press **MENU**.

Display:

SYSTEM SET UP PRESS NAVI. [◀ ▶]

2 For mailbox 1:
Press **☎**, then **5 5**.

BOX1 GREETING CHECK [±]

For mailbox 2:
Press **☎**, then **5 6**.

BOX2 GREETING CHECK [±]

3 Press **+** or **-** to select "RECORD".

Example:

BOX1 GREETING RECORD [±]

4 Press **SET**.

Example:

BOX1 REC. 16s

5 Speak clearly about 20 cm (8 inches) away from the microphone.

- The display will show the remaining recording time.

Example:

BOX1 REC. 15s

6 When finished recording, press **STOP**.

- The unit will repeat your message. Adjust the volume using **+** or **-**.

7 Press **MENU**.

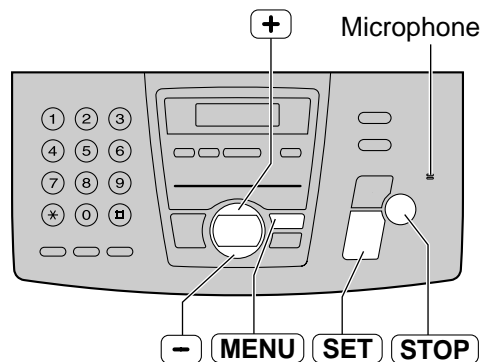

To check the mailbox greeting message

1. For mailbox 1
Press **MENU**, **☎ 5 5**.

For mailbox 2
Press **MENU**, **☎ 5 6**.

2. Press **+** or **-** to select "CHECK".

3. Press **SET**.
• The unit will play the message.

4. Press **MENU**.

To erase your own mailbox greeting message

1. For mailbox 1
Press **MENU**, **☎ 5 5**.

For mailbox 2
Press **MENU**, **☎ 5 6**.

2. Press **+** or **-** to select "ERASE".

3. Press **SET**.
• Your own message will be erased.

4. Press **MENU**.

Voice Mailbox

Listening to recorded messages using the base unit

1 Press **▶** 2 times.

Display: MAILBOX [+ -]

2 Press **+** or **-** until the desired mailbox number is displayed.

Example: NEW MESSAGES
MAILBOX2 [±] 02

↓
PRESS
REC/ERASE/PLAY

3 Press **PLAY MESSAGES**.

If you have programmed your own mailbox password, enter it.

PASSWORD=

- Only the new recorded messages will be played.
- If there are no new messages, the unit will play back all the recorded messages.

4 Press **STOP** to end the operation.

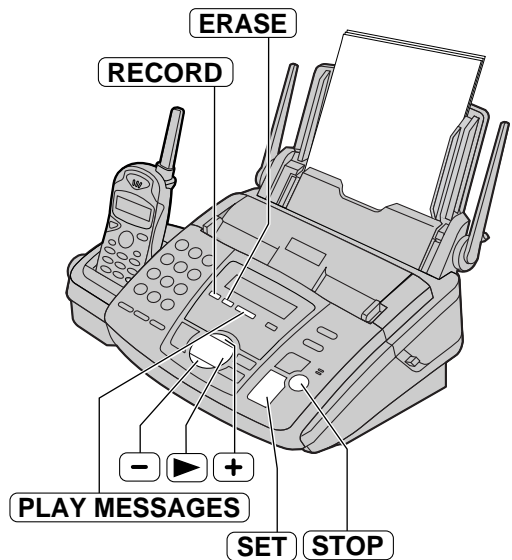

Note:

- The following features can be used during playback. See page 59 for details.
 - To repeat a message
 - To skip a message
 - To stop playback
 - To change the playback speed
 - To erase a specific message

To record a memo message into a mailbox

1. Press **▶** 2 times.

Display: MAILBOX [+ -]

2. Press **+** or **-** until the desired mailbox number is displayed.

Example: MAILBOX1 [±] 00

↓
PRESS
REC/ERASE/PLAY

3. Press **RECORD**.

- A long beep will sound.

Example: BOX1 RECORDING

4. Speak clearly about 20 cm (8 inches) away from the microphone.

5. When finished recording, press **STOP**.

To erase all the messages in a mailbox

1. Press **▶** 2 times.

2. Press **+** or **-** until the desired mailbox number is displayed.

Example: MAILBOX1 [±] 01

↓
PRESS
REC/ERASE/PLAY

3. Press **ERASE**.

BOX1 ERASE OK?
YES: SET/NO: STOP

4. Press **SET**.

Listening to recorded messages using the handset

1 Press **PLAYBACK**.

Example: Remote operation

2 For mailbox 1:

Press ***1**.

For mailbox 2:

Press ***2**.

3 Enter the mailbox password (default setting "555").

- The voice guide will tell you the number of new messages and they will be played automatically.

Voice guide example:

3 new messages.

- **To repeat only the new messages:**

Press **4**.

- **To listen to all the messages:**

Press **5**.

4 Press **PLAYBACK** to end the operation.

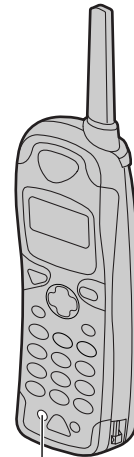

PLAYBACK

Note:

- The following features can be used during playback. See page 60 for details.
 - To repeat a message
 - To skip a message
 - To erase a specific message
 - To erase all the messages
- For the following, see page 60:
 - When there are no new recorded messages.
 - When voice memory is full.

Listening to recorded messages from a remote location

1 Call your unit from a remote touch tone telephone.

2 Press ***** and the desired mailbox number (**1** or **2**) during TAD/FAX greeting playback.

- If you have recorded your own mailbox greeting message, it will be played.

3 Enter the mailbox password (default setting "555").

- If you have programmed your own mailbox password, enter it instead of "555".

Note:

- For details on remote operation, see pages 61–63. **81**, **82**, **83**, and **84** cannot be used.

To listen to messages in another memory after playback

Press ***** and **0** (for the common memory), then enter the remote operation ID.

or

Press ***** and the desired mailbox number (**1** or **2**), then enter the mailbox password.

Transferring recorded messages to another telephone

This feature allows your unit to call a designated telephone number each time an incoming voice message is recorded. You can retrieve the transferred message during the same call using the remote operation.

To use this feature, program the transfer telephone number first (feature #60 on page 76) and set the unit to TAD/FAX mode.

1. An incoming voice message is recorded in your unit.
2. Your unit calls the transfer telephone number.
3. Answer the call with the transfer telephone.
4. Your unit will play the transfer greeting message.
 - This message can be changed (see below).
5. Enter the remote operation ID (feature #11 on page 71).
6. Retrieve the message using the remote operation (p. 61–63).

Pre-recorded message:

*This is a telephone answering system.
Please enter your remote ID for remote operation.*

Recording your own transfer greeting message

The recording time is limited to 16 seconds.

Suggested message: "This is a transferred message from (your name, business and/or telephone number). Please enter your remote ID for remote operation."

- 1 Press **MENU**.

Display: SYSTEM SET UP
PRESS NAVI. [◀ ▶]

- 2 Press **⏏**, then **6** **1**.

TRNS-GREETING
CHECK [±]

- 3 Press **+** or **-** to select "RECORD".

TRNS-GREETING
RECORD [±]

- 4 Press **SET**.

TRNS REC. 16s

- 5 Speak clearly about 20 cm (8 inches) away from the microphone.

- The display will show the remaining recording time.

Example: TRNS REC. 15s

- 6 When finished recording, press **STOP**.
 - The unit will repeat your message. Adjust the volume using **+** or **-**.

- 7 Press **MENU**.

To check the transfer greeting message

1. Press **MENU**, **⏏** **6** **1**.
2. Press **+** or **-** to select "CHECK".
3. Press **SET**.
 - The unit will play the message.
4. Press **MENU**.

To erase your own transfer greeting message

1. Press **MENU**, **⏏** **6** **1**.
2. Press **+** or **-** to select "ERASE".
3. Press **SET**.
 - Your own message will be erased.
4. Press **MENU**.
 - When transferring a call, the pre-recorded transfer greeting message will be played.

Programming

The unit provides various programming features. Program the desired settings by referring to the programming tables (p. 70–77).

General programming method

1 Press **MENU**.

Display:

SYSTEM SET UP PRESS NAVI. [◀ ▶]

2 Select the feature you wish to program.

For basic features (p. 70, 71):

Press **◀** or **▶** until the desired feature is displayed.

For advanced features (p. 71–77):

Press **◀** or **▶** until the following is displayed:

ADVANCED MODE PRESS SET

then press **SET** and press **◀** or **▶** until the desired feature is displayed.

- The current setting of the feature will be displayed.

3 Press **+** or **-** until the desired setting is displayed.

- This step may be slightly different depending on the feature.

4 Press **SET**.

- The setting you selected is set, and the next feature will be displayed.

5 To exit programming, press **MENU**.

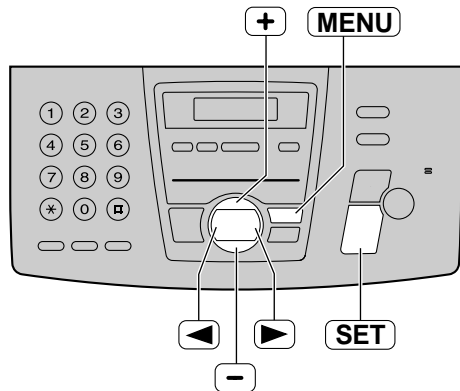

Programming by entering the program code number directly

You can select a feature by directly entering the program code (# and 2-digit number) instead of using **◀** or **▶** in step 2.

1. Press **MENU**.
 2. Press **#** and the 2-digit code number.
 3. Follow steps 3 to 5 above.
- See programming tables for code numbers (p. 70–77).

To cancel programming

Press **MENU** to exit the program.

Features Summary

Basic features

How to set menu options

1. Press **MENU**.
2. Press **◀** or **▶** until the desired feature is displayed.
3. Press **+** or **-** until the desired setting is displayed.
4. Press **SET**.
5. Press **MENU**.

Note:

- Step 3 may be slightly different depending on the feature.
- See page 69 for more details.

Programming table

Code	Feature & Display	Settings	How the unit operates
#01	Setting the date and time <div style="border: 1px solid black; padding: 2px; width: fit-content;">SET DATE & TIME PRESS SET</div>	mm/dd/yy hh:mm	See page 17 for details.
#02	Setting your logo <div style="border: 1px solid black; padding: 2px; width: fit-content;">YOUR LOGO PRESS SET</div>	(Up to 30 characters)	See page 18 for details.
#03	Setting your facsimile telephone number <div style="border: 1px solid black; padding: 2px; width: fit-content;">YOUR FAX NO. PRESS SET</div>	(Up to 20 digits)	See page 20 for details.
#04	Printing the sending report <div style="border: 1px solid black; padding: 2px; width: fit-content;">SENDING REPORT MODE=ERROR [±]</div> To print and check the sending report for fax transmission results (p. 41).	ERROR	"ERROR": The sending report will be printed only when fax transmission fails. "ON": The sending report will be printed out after every transmission.
		ON	
		OFF	
#06	Changing the ring setting in TAD/FAX mode <div style="border: 1px solid black; padding: 2px; width: fit-content;">TAD RING COUNT RINGS=2 [±]</div> To change the number of rings before the unit answers a call in TAD/FAX mode.	2, 3, 4, 5, 6, 7, 8, 9	This setting can be changed when the unit is in TAD/FAX mode. See page 56 for details.
		TOLL SAVER	
		RINGER OFF	
	Changing the ring setting in FAX ONLY mode <div style="border: 1px solid black; padding: 2px; width: fit-content;">FAX RING COUNT RINGS=2 [±]</div> To change the number of rings before the unit answers a call in FAX ONLY mode.	2, 3, 4, 5, 6, 7, 8, 9	This setting can be changed when the unit is in FAX ONLY mode (p. 49).

(The default setting is in bold type.)

Features Summary

Code	Feature & Display	Settings	How the unit operates
#10	Changing the incoming message recording time <div style="border: 1px solid black; padding: 2px; width: fit-content;"> RECORDING TIME MODE=VOX [±] </div>	VOX	“VOX”: Unlimited “1-9”: 1 minute to 9 minutes
		1, 2, 3, 4, 5, 6, 7, 8, 9	
#11	Setting the remote operation ID <div style="border: 1px solid black; padding: 2px; width: fit-content;"> REMOTE TAD ID ID=111 </div>	ID = 222	<ol style="list-style-type: none"> 1. Follow steps 1 and 2 on page 68. 2. Enter any 3-digit number except a number using 0 or 7. 3. Press (SET). 4. Press (MENU).
#13	Setting the dialling mode (For Australian users only) <div style="border: 1px solid black; padding: 2px; width: fit-content;"> DIALLING MODE MODE=TONE [±] </div> <p>If you cannot dial, change the setting depending on your telephone line service.</p>	TONE	“TONE”: For tone dial service. “PULSE”: For rotary pulse dial service.
		PULSE	
#17	Setting the ringer pattern <div style="border: 1px solid black; padding: 2px; width: fit-content;"> RINGER PATTERN MODE=A [±] </div>	A	You can select the ringer pattern. The selected ringer pattern will sound during setting.
		B	
		C	

(The default setting is in bold type.)

Features Summary

Advanced features

How to set menu options

1. Press **MENU**.
2. Press **◀** or **▶** until the following is displayed:

```

ADVANCED MODE
PRESS SET
    
```

then press **SET** and press **◀** or **▶** until the desired feature is displayed.

3. Press **+** or **-** until the desired setting is displayed.
4. Press **SET**.
5. Press **MENU**.

Note:

- Step 3 may be slightly different depending on the feature.
- See page 69 for more details.

Programming table

Code	Feature & Display	Settings	How the unit operates
#22	Setting the journal report to print automatically <pre>AUTO JOURNAL MODE=ON [±]</pre>	ON	"ON": The unit will print the journal report automatically after every 30 new fax communications (p. 41).
		OFF	
#23	Sending document overseas <pre>OVERSEAS MODE MODE=OFF [±]</pre> If you have difficulty sending an overseas fax, activate this feature before starting transmission. This feature makes sending documents easier as the transmission speed is slowed down.	ON	After transmission, the unit will turn off automatically. <ul style="list-style-type: none"> • This feature is not available for broadcast transmission. • The calling charge may be higher.
		OFF	
#25	Sending a fax at a specific time <pre>DELAYED SEND MODE=OFF [±]</pre> This feature allows you to take advantage of low-cost calling hours offered by your telephone company. <ul style="list-style-type: none"> • The setting can be reserved to take place up to 24 hours in advance. 	ON / fax no. / hh:mm	To send a document: <ol style="list-style-type: none"> 1. Insert the document. 2. Follow steps 1 and 2 above. 3. Press + or - to select "ON". 4. Press SET. 5. Enter the fax number. 6. Press SET. 7. Enter the transmission start time. Press * to select "AM" or "PM". 8. Press SET. 9. Press MENU. <ul style="list-style-type: none"> • To cancel after programming, press STOP then SET.
		OFF	
#26	Setting the Caller ID list to print automatically <pre>AUTO CALL. LIST MODE=ON [±]</pre>	ON	"ON": The unit will print the Caller ID list automatically after every 30 new calls (p. 31).
		OFF	

(The default setting is in bold type.)

Features Summary

Code	Feature & Display	Settings	How the unit operates															
#30	Changing the silent fax recognition ring setting <div style="border: 1px solid black; padding: 2px; width: fit-content;">SILENT FAX RING RINGS=3 [±]</div> To change the number of rings when the unit detects a phone call in TEL/FAX mode.	3, 4, 5, 6, 7, 8, 9	See pages 50 and 51 for details.															
				#31	Setting the Distinctive Ring pattern <div style="border: 1px solid black; padding: 2px; width: fit-content;">RING DETECTION MODE=OFF [±]</div>	ON OFF	See page 53 for details.											
#34	Setting the quick scan <div style="border: 1px solid black; padding: 2px; width: fit-content;">QUICK SCAN MODE=OFF [±]</div> To scan the document into memory before sending/copying. This is helpful when you want to remove the document for other uses.	ON OFF	"ON": The unit will store the documents first and release them. • If the document exceeds the memory capacity (p. 91), sending/copying will be cancelled and this feature will be turned off automatically.															
				#36	Receiving other size documents <div style="border: 1px solid black; padding: 2px; width: fit-content;">RCV REDUCTION MODE=92% [±]</div> If the size of the document sent by the other party is as large as, or larger than the recording paper, the unit can reduce and print the document. Select the desired reduction rate.	100% 92% 86% 72%	<table border="1" style="width: 100%; border-collapse: collapse; text-align: center;"> <thead> <tr> <th>Setting</th> <th>Recording paper</th> <th>Original document</th> </tr> </thead> <tbody> <tr> <td>100%</td> <td>A4</td> <td>Letter</td> </tr> <tr> <td>92%</td> <td>A4</td> <td>A4</td> </tr> <tr> <td>86%</td> <td>A4</td> <td>A4</td> </tr> <tr> <td>72%</td> <td>A4</td> <td>Legal</td> </tr> </tbody> </table>	Setting	Recording paper	Original document	100%	A4	Letter	92%	A4	A4	86%	A4
Setting	Recording paper	Original document																
100%	A4	Letter																
92%	A4	A4																
86%	A4	A4																
72%	A4	Legal																
#39	Changing the display contrast <div style="border: 1px solid black; padding: 2px; width: fit-content;">LCD CONTRAST MODE=NORMAL [±]</div>	NORMAL DARKER	"NORMAL": For normal contrast "DARKER": Used when the display contrast is too light.															

(The default setting is in bold type.)

Features Summary

Advanced features (cont.)

How to set menu options

1. Press **MENU**.
2. Press **◀** or **▶** until the following is displayed:

```
ADVANCED MODE
PRESS SET
```

then press **SET** and press **◀** or **▶** until the desired feature is displayed.

3. Press **+** or **-** until the desired setting is displayed.
4. Press **SET**.
5. Press **MENU**.

Note:

- Step 3 may be slightly different depending on the feature.
- See page 69 for more details.

Programming table (cont.)

Code	Feature & Display	Settings	How the unit operates
#41	Changing the fax activation code <div style="border: 1px solid black; padding: 2px; width: fit-content;"> FAX ACTIVATION MODE=ON [±] </div> If you use an extension telephone and wish to use it to receive a fax, activate this feature, and enter the code (p. 52).	ON / CODE=*9	1. Follow steps 1 and 2 above. 2. Press + or - to select "ON". 3. Press SET . 4. Enter your code from 2 to 4 digits, using 0–9 and * . 5. Press SET . 6. Press MENU . • Do not enter "0000".
		OFF	
#42	Setting the message alert <div style="border: 1px solid black; padding: 2px; width: fit-content;"> MESSAGE ALERT MODE=OFF [±] </div> To alert you with beeps when a new voice message is recorded.	ON	If you hear slow beeps, press PLAY MESSAGES or PLAYBACK and listen to recorded messages (p. 59, 60). The beeps will stop.
		OFF	
#43	Setting the recording time alert <div style="border: 1px solid black; padding: 2px; width: fit-content;"> REC. TIME ALERT MODE=OFF [±] </div> To alert you with beeps when there is less than 60 seconds of remaining recording time.	ON	If you hear slow beeps, erase the recorded messages (p. 59, 60, 66). The beeps will stop.
		OFF	
#44	Setting the memory reception alert <div style="border: 1px solid black; padding: 2px; width: fit-content;"> RECEIVE ALERT MODE=ON [±] </div> To alert you with a beeping sound when a document which has been received is stored into memory due to some existing problem.	ON	If you are alerted by a slow beeping sound, clear the printing problem and make sure the unit is supplied with enough paper to print the stored document. The beeps will stop.
		OFF	

(The default setting is in bold type.)

Features Summary

Code	Feature & Display	Settings	How the unit operates
#46	Setting the friendly reception <div style="border: 1px solid black; padding: 2px; width: fit-content;">FRIENDLY RCV MODE=ON [±]</div> To receive a fax automatically when you answer a call and hear a fax calling tone (slow beep).	ON	"ON": You do not have to press FAX/START for fax reception.
		OFF	
#47	Setting the fax voice guidance <div style="border: 1px solid black; padding: 2px; width: fit-content;">FAX GUIDANCE MODE=ON [±]</div> If you wish to hear the voice guidance (see right) at each fax transmission/reception, set this feature to "ON". <ul style="list-style-type: none"> To hear the voice guidance only when fax transmission/reception fails, select "ERROR". 	ON	Voice guidance examples: "Start transmission." "Transmission is complete." "Transmission has failed." "Transmission has been interrupted." "Start reception." etc.
		OFF	
		ERROR	
#51	Setting the mailbox 1 password <div style="border: 1px solid black; padding: 2px; width: fit-content;">BOX1 PASSWORD ID=</div> If you wish to prevent other users from retrieving messages, program a password for mailbox 1.	ID=555	<ol style="list-style-type: none"> Follow steps 1 and 2 on page 74. Enter a 3-digit number except a number using digits 0 or 7. Press SET. Press MENU.
#52	Setting the mailbox 2 password <div style="border: 1px solid black; padding: 2px; width: fit-content;">BOX2 PASSWORD ID=</div> If you wish to prevent other users from retrieving messages, program a password for mailbox 2.	ID=555	<ol style="list-style-type: none"> Follow steps 1 and 2 on page 74. Enter a 3-digit number except a number using digits 0 or 7. Press SET. Press MENU.
#54	Changing the recording time for your own TAD/FAX greeting message <div style="border: 1px solid black; padding: 2px; width: fit-content;">GREETING TIME MODE=16s [±]</div>	16s	"16s": Up to 16 seconds "60s": Up to 60 seconds <ul style="list-style-type: none"> See page 57 for details.
		60s	
#55	Greeting message for mailbox 1 (checking, recording or erasing) <div style="border: 1px solid black; padding: 2px; width: fit-content;">BOX1 GREETING CHECK [±]</div>	CHECK	See page 65 for details.
		RECORD	
		ERASE	
#56	Greeting message for mailbox 2 (checking, recording or erasing) <div style="border: 1px solid black; padding: 2px; width: fit-content;">BOX2 GREETING CHECK [±]</div>	CHECK	See page 65 for details.
		RECORD	
		ERASE	

(The default setting is in bold type.)

Features Summary

Advanced features (cont.)

How to set menu options

1. Press **MENU**.
2. Press **◀** or **▶** until the following is displayed:

```
ADVANCED MODE
PRESS SET
```

then press **SET** and press **◀** or **▶** until the desired feature is displayed.

3. Press **+** or **-** until the desired setting is displayed.
4. Press **SET**.
5. Press **MENU**.

Note:

- Step 3 may be slightly different depending on the feature.
- See page 69 for more details.

Programming table (cont.)

Code	Feature & Display	Settings	How the unit operates
#58	Setting the original mode <pre>ORIGINAL MODE=NORMAL [±]</pre> To send or copy a document with faint or dark writing, set this feature before starting transmission or copying.	NORMAL	"NORMAL": Used for normal writing. "LIGHT": Used for faint writing. "DARKER": Used for dark writing. • This feature will return to the normal mode after transmission or copying.
		LIGHT	
		DARKER	
#60	Setting the message transfer <pre>MESSAGE TRANS. MODE=OFF [±]</pre> To transfer a recorded incoming message to another telephone (p. 68).	ON	<ol style="list-style-type: none"> 1. Follow steps 1 and 2 above. 2. Press + or - to select "ON". 3. Press SET. 4. Enter the transfer telephone number. 5. Press SET. 6. Press MENU. • This feature can be turned on/off from a remote location (p. 63).
		OFF	
#61	Transfer greeting message (checking, recording or erasing) <pre>TRNS-GREETING CHECK [±]</pre>	CHECK	See page 68 for details.
		RECORD	
		ERASE	
#67	Setting the incoming message monitor <pre>ICM MONITOR MODE=ON [±]</pre> To hear an incoming message (ICM) from the speaker when the answering device is recording the message.	ON	If you select "OFF", you cannot monitor the incoming message.
		OFF	

(The default setting is in bold type.)

Features Summary

Code	Feature & Display	Settings	How the unit operates
#70	Calling your pager <div style="border: 1px solid black; padding: 2px; width: fit-content;">PAGER CALL MODE=OFF [±]</div> If you have a pager and wish to know when your unit receives a fax or an incoming message, activate this feature.	ON	See page 52 for details.
		OFF	
#74	Setting the locale where you use this unit <div style="border: 1px solid black; padding: 2px; width: fit-content;">LOCALE =AUSTRALIA [±]</div> This setting must match your locale.	AUSTRALIA	"AUSTRALIA": To use in Australia "NEW ZEALAND": To use in New Zealand
		NEW ZEALAND	
#76	Setting the connecting tone <div style="border: 1px solid black; padding: 2px; width: fit-content;">CONNECTING TONE MODE=ON [±]</div> If you often have trouble when sending a fax, this feature allows you to hear connecting tones: fax tone, ring back tone and busy tone.	ON	You can confirm the status of the other party's machine. <ul style="list-style-type: none"> • If the ring back tone continues, the other party's machine may not be a facsimile or may have run out of paper. Check with the other party. • The connecting tone volume cannot be adjusted.
		OFF	
#77	Changing the receiving mode in the AUTO ANSWER setting <div style="border: 1px solid black; padding: 2px; width: fit-content;">AUTO ANSWER MODE=TAD/FAX [±]</div>	TAD/FAX	"TAD/FAX": Telephone Answering Device/Facsimile mode (p. 56) "FAX ONLY": Facsimile only mode (p. 49) "TEL/FAX": Telephone/Facsimile mode (p. 50, 51)
		FAX ONLY	
		TEL/FAX	
#78	Changing the TEL/FAX delayed ring setting <div style="border: 1px solid black; padding: 2px; width: fit-content;">TEL/FAX RING RINGS=2 [±]</div> If you use an extension telephone in TEL/FAX mode, select the desired number of rings of the extension telephone.	2, 3, 4, 5, 6, 7, 8, 9	See pages 50 and 51 for details.
#80	Resetting advanced features to their default settings <div style="border: 1px solid black; padding: 2px; width: fit-content;">SET DEFAULT RESET=NO [±]</div>	YES	1. Follow steps 1 and 2 on page 76. 2. Press + or - to select "YES". 3. Press SET . 4. Press SET again. 5. Press MENU .
		NO	

(The default setting is in bold type.)

Error Messages

Reports

If your unit cannot send a fax, check the following:

- the number you dialled is correct,
- the other party's machine is a facsimile.

If the problem remains, correct it by following the communication message printed on the sending and journal reports (p. 41).

COMMUNICATION ERROR

(CODE: 40–42, 46–52, 58, 65, 68, 72, FF)

- A transmission or reception error occurred. Try again or check with the other party.

COMMUNICATION ERROR

(CODE: 43, 44)

- A line problem occurred. Connect the telephone line cord to a different jack and try again.
- An overseas transmission error occurred. Try using the overseas mode of feature #23 (p. 72).

DOCUMENT JAMMED

- The document is jammed. Remove the jammed document (p. 87).

ERROR-NOT YOUR UNIT

(CODE: 54, 59, 70)

- A transmission or reception error occurred because of a problem with the other party's fax machine. Check with the other party.

MEMORY FULL

- The document was not received due to memory being full.

NO DOCUMENT

- The document was not fed into the unit properly. Reinsert the document and try again.

OTHER FAX NOT RESPONDING

- The other party's fax machine is busy or has run out of recording paper. Try again.
- The document was not fed properly. Reinsert the document and try again.
- The other party's fax machine rings too many times. Send the fax manually (p. 40).
- The other party's machine is not a facsimile. Check with the other party.
- The number you dialled is not in service.

PRESSED THE STOP KEY

- **STOP** was pressed and fax communication was cancelled.

OK

- Fax communication was successful.

Display

If the unit detects a problem, one or more of the following messages will appear on the display.

Base unit

Display message	Cause & solution
CALL SERVICE CALL SERVICE2	<ul style="list-style-type: none"> There is something wrong with the unit. Contact our service personnel.
CHECK DOCUMENT	<ul style="list-style-type: none"> The document was not fed into the unit properly. Reinsert the document. If misfeeding occurs frequently, clean the document feeder rollers (p. 86) and try again.
CHECK MEMORY	<ul style="list-style-type: none"> The memory (telephone numbers, parameters, etc.) has been erased. Re-program.
CHECK PAPER	<ul style="list-style-type: none"> The recording paper is not installed or the unit has run out of paper. Install paper and press SET to clear the message. The recording paper is not fed into the unit properly. Reinstall paper (p. 15) and press SET to clear the message. The recording paper has jammed near the recording paper entrance. Clear the jammed paper (p. 86) and press SET to clear the message. Do not install folded or heavily curled paper.
COVER OPEN ↑ CHECK FILM	<ul style="list-style-type: none"> The covers are open. Close them. The ink film is empty. Replace the ink film with a new one (p. 13). The ink film is not installed. Install it (p. 13). The ink film is slack. Tighten it (see step 7 on page 14).
DIRECTORY FULL	<ul style="list-style-type: none"> There is no space to store new items in the directory. Erase unnecessary items (p. 31).
FAX IN MEMORY	<ul style="list-style-type: none"> The unit has a document in memory. See the other displayed message instructions to print out the document.
FAX MEMORY FULL	<ul style="list-style-type: none"> The memory is full of received documents due to a lack of recording paper or a recording paper jam. Install paper or clear the jammed paper. When performing memory transmission, the document being stored exceeds the memory capacity of the unit. Transmit the entire document manually.
MEMORY FULL	<ul style="list-style-type: none"> When making a copy, the document being stored exceeds the memory capacity of the unit. Press STOP to clear the message. Divide the document into sections.
MESSAGE FULL	<ul style="list-style-type: none"> There is no room left in memory to record a voice message. Erase unnecessary messages (p. 59, 60, 66).

(continued)

Error Messages

Display message	Cause & solution
MODEM ERROR	<ul style="list-style-type: none"> There is something wrong with the modem circuit. Contact our service personnel.
NO FAX REPLY	<ul style="list-style-type: none"> The other party's fax machine is busy or has run out of recording paper. Try again.
PAPER JAMMED	<ul style="list-style-type: none"> A recording paper jam occurred. Clear the jammed paper (p. 86).
PLEASE WAIT	<ul style="list-style-type: none"> The unit is checking that there is no slack on the ink film. Wait for a moment while the check completes.
REDIAL TIME OUT	<ul style="list-style-type: none"> The other party's fax machine is busy or has run out of recording paper. Try again.
REMOVE DOCUMENT	<ul style="list-style-type: none"> The document is jammed. Remove the jammed document (p. 87). Attempted to transmit a document longer than 600 mm. Press STOP to remove the document. Divide the document into two or more sheets and try again.
TRANSMIT ERROR	<ul style="list-style-type: none"> A transmission error occurred. Try again.
UNIT OVERHEATED	<ul style="list-style-type: none"> The unit is too hot. Let the unit cool down.

Handset

Display message	Cause & solution
Directory full	<ul style="list-style-type: none"> There is no space to store new items in the directory. Erase unnecessary items (p. 31).
No link to base. Place on cradle and try again.	<ul style="list-style-type: none"> The handset has lost communication with the base unit. Move closer and try again. Lay the handset on the base unit and try again. The power cord is disconnected. Plug in the power cord.
Not available	<ul style="list-style-type: none"> ▶, RECALL/PLAYBACK or INTERCOM/CLR was pressed while the base unit was in use.
Please lift up and try again	<ul style="list-style-type: none"> ▼, ▲, ◀ or ▶ was pressed while the handset was on the base unit. Lift the handset and press the button again.
Save error	<ul style="list-style-type: none"> While programming, the handset has lost communication with the base unit. Move closer to the base unit.

When a function does not work, check here before requesting help

General

I cannot make and receive calls.

- The power cord or telephone line cord is not connected. Check the connections (p. 16).
- If you used a splitter to connect the unit, remove the splitter and connect the unit to the wall jack directly. If the unit operates properly, check the splitter.

I cannot make calls.

- The dialling mode setting is wrong. Change the setting of feature #13 (p. 69) (Australian users only).

The unit does not work.

- Disconnect the unit from the telephone line and connect the line to a known working telephone. If the working telephone operates properly, contact our service personnel to have the unit repaired. If the working telephone does not operate properly, contact your telephone company.

The unit does not ring.

- The ringer volume is set to off. Adjust it (p. 23).
- The ring setting of feature #06 is set to "RINGER OFF". Change to another ring setting (p. 70).

The unit displays the following though the paper is inserted.

CHECK PAPER

- The paper is inserted halfway. Insert it correctly (p. 15) and press **SET** to clear the message.

(continued)

The other party complains they only hear a fax tone and cannot talk.

- FAX ONLY mode is set. Tell the other party the number is only used for faxes.
- Change to TAD/FAX mode (p. 56), TEL mode (p. 48) or TEL/FAX mode (p. 50).
- If you use a distinctive ring service, turn AUTO ANSWER off so that the fax machine is in TEL mode.
- If you use a distinctive ring service, make sure you have set the same ring pattern assigned by the telephone company (p. 53).

The **REDIAL/PAUSE** button does not function properly.

- If this button is pressed during dialling, a pause will be inserted. If pressed immediately after a dial tone is obtained, the last number dialled will be redialled.

The receiving mode does not function properly.

- A Distinctive Ring pattern of feature #31 is set (p. 53).
- TEL/FAX mode is set (p. 50, 51).

During programming, I cannot enter the code, ID number or password.

- All or part of the numbers are the same. Change the number: feature #11 (p. 71), #41 (p. 74), #51 and #52 (p. 75).

The ink film runs out quickly.

- The HELP printing function, copy function, and reports also use ink film.

(continued)

General (cont.)

The unit beeps.

- Recording paper or ink film has run out. Press **(STOP)** to stop the beeps and install paper/ink film.

Whenever I try to retrieve my voice mail messages, the retrieval is interrupted by the fax tone.

- You are probably entering * 98 or * 99 to retrieve your messages. * 9 is the default setting for the fax activation code. If you use a voice mail service, set the fax activation feature to off or reprogram the activation code (feature #41 on page 74).

The speakerphone is not working.

- Use the speakerphone in a quiet room.
- If you have difficulty hearing the other party, adjust the volume using **(+)** or **(-)**.

The **(LOCATOR/INTERCOM)** button does not function.

- The handset is too far from the base unit.
- The handset is engaged in an outside call.

While having an intercom call, a series of tones are heard.

- Someone is calling you from outside. Press **(TALK)** or **(DIGITAL SP-PHONE)** to answer the outside call. The intercom call will be terminated.

Cordless handset

The handset does not work.

- Make sure that the battery is installed correctly (p. 87).
- Charge the battery fully (p. 22).
- Clean the charge contacts and charge again (p. 22).

The handset does not ring.

- The ringer volume is set to off. Press **(▲)** in step 4 on page 23.

(continued)

The display shows the following and an alarm tone sounds when I press **(TALK)**, **(INTERCOM/CLR)** or **(RECALL/PLAYBACK)**.

No link to base.
Place on cradle
and try again.

- The handset is too far from the base unit. Move closer and try again.
- Lay the handset on the base unit and try again.
- The power cord is disconnected. Plug in the power cord.

Static, sound cuts in/out, fades.

Interference from other electrical units.

- Locate the handset and the base unit away from other electrical appliances.
- Move closer to the base unit.
- Press **(CH)** to select a clear channel.
- Raise the base unit antennas.

The handset stops working while being used.

- Place the handset on the base unit, and disconnect the power cord to reset the unit. Connect the power cord, and try again.

I cannot store a name and telephone number in the directory.

- You cannot store a name and number while the unit is in the talk or intercom mode.
- Do not pause for over 60 seconds while storing.

While storing a name and telephone number in the directory, the handset starts to ring.

- To answer a call, press **(TALK)**. The program will be cancelled. Store the name and number again.

I cannot redial by pressing

(REDIAL/PAUSE).

- If the last number dialled was more than 32 digits long, the number will not be redialled.

(continued)

Cordless handset (cont.)

The handset beeps intermittently and/or the following is displayed.

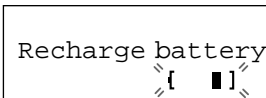

- Charge the battery fully (p. 22).

I charged the battery fully, but the following is still displayed:

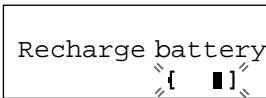



- Clean the charge contacts and charge again (p. 22).
- It is time to replace the battery (p. 87).

I cannot receive documents by pressing **FAX RECEIVE** on the handset.

- Press **FAX RECEIVE** until a single beep is heard.
- The memory is full of received documents due to a lack of recording paper or a recording paper jam. Install paper or clear the jammed paper.

The handset display is blank.

- The handset is in the standby mode. Press  or  to turn the display on.

The handset display is still blank after pressing , ,  or .

- Charge the battery fully (p. 22).

The handset display goes to the standby mode while viewing the caller information.

- Do not pause for over 60 seconds while searching.
- **DIGITAL SP-PHONE** was pressed.

Fax – sending

I cannot send documents.

- The other party's fax machine is busy or has run out of recording paper. Try again.
- The other party's machine is not a facsimile. Check with the other party.
- The other party's fax machine rings too many times. Send the fax manually (p. 40).

(continued)

The other party complains that letters on their received document are distorted or not clear.

- If your line has special telephone services such as call waiting, the service may have been activated during fax transmission. Connect the unit to a line that does not have these services.
- The extension telephone on the same line is off the hook. Hang up the extension telephone and try again.
- Try copying the document. If the copied image is clear, there may be something wrong with the other party's machine.

The other party complains that dirty patterns or black lines appear on their received document.

- The glass or rollers are dirty. Clean them (p. 88).

I cannot send a fax overseas.

- Use the overseas transmission mode of feature #23 (p. 72).
- Add two pauses at the end of the telephone number or dial manually.

Fax – receiving

I cannot receive documents.

- When you have a single telephone line and subscribe to a telephone company's voice mail service, you must also subscribe to the Distinctive Ring Service (p. 53).

I cannot receive documents automatically.

- The receiving mode is set to TEL mode. Set to TAD/FAX mode (p. 56), FAX ONLY mode (p. 49) or TEL/FAX mode (p. 50).
- The time taken to answer the call is too long. Decrease the number of rings: feature #06 (p. 70), #30 (p. 73) and #78 (p. 77).
- The greeting message is too long. Shorten the message (p. 57).

(continued)

Fax – receiving (cont.)

The display shows the following, but faxes are not received.

CONNECTING.....

- The incoming call is not a fax. Change the receiving mode to TEL mode (p. 48) or TAD/FAX mode (p. 56).

A blank sheet is ejected.

- If a blank sheet is ejected after the received document is printed out, the receiving reduction rate is not programmed correctly. Program the proper rate in feature #36 (p. 73).
- The other party placed the document in their fax machine the wrong way. Check with the other party.

A white line or a dirty pattern appears on your recording paper.

- The glass or rollers are dirty. Clean them (p. 88).

The printing quality is poor.

- The other party sent a faint document. Ask them to send a clearer copy of the document.
- The thermal head is dirty. Clean it (p. 89).
- Some paper has instructions recommending which side to print on. Try turning the paper over.
- You may have used paper with a cotton and/or fibre content that is over 20%, such as letterhead or resume paper.

I cannot receive documents by pressing **FAX RECEIVE** on the handset.

- Press **FAX RECEIVE** until a single beep is heard.
- The memory is full of received documents due to a lack of recording paper or a recording paper jam. Install paper or clear the jammed paper.

The other party complains that they cannot send a document.

- The memory is full of received documents due to a lack of recording paper or a recording paper jam. Install paper (p. 15) or clear the jammed paper (p. 86).

Receiving mode

I cannot select the desired receiving mode.

- If you want to set TAD/FAX, FAX ONLY or TEL/FAX mode:
 - select the desired mode using feature #77 (p. 77), and
 - press **AUTO ANSWER** to turn ON the arrow (▼) located on the right of the display.

Display:



- If you want to set TEL mode:
 - press **AUTO ANSWER** to turn OFF the arrow (▼) located on the right of the display.

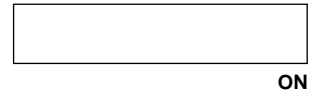

The other party complains that they cannot send a document.

- The unit is not in AUTO ANSWER mode. Press **AUTO ANSWER** to turn ON the arrow (▼) located on the right of the display.

Copying

The unit does not make a copy.

- You cannot make a copy during programming. Make the copy after programming or stop programming.

A black line, a white line or a dirty pattern appears on the copied document.

- The glass or rollers are dirty. Clean them (p. 88).

The copied image is distorted.

- The thermal head is dirty. Clean it (p. 88).

(continued)

Copying (cont.)

The printing quality is poor.

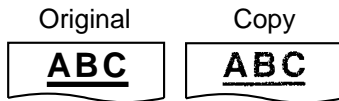

- Some paper has instructions recommending which side to print on. Try turning the paper over.
- You may have used paper with a cotton and/or fibre content that is over 20%, such as letterhead or resume paper.

Answering device

I cannot retrieve recorded messages from a remote location.

- Press the remote operation ID correctly and firmly (p. 62).

Messages in the mailbox do not play back.

- The mailbox password is wrong. Enter the correct password.
 - For mailbox 1 password, see feature #51 on page 75.
 - For mailbox 2 password, see feature #52 on page 75.

(continued)

The other party complains that they cannot leave a voice message.

- The memory is full. Erase unnecessary messages (p. 59, 60, 66).

While operating the answering device from the handset, a series of tones is heard.

- Someone is calling you from outside. Press **TALK** to answer the outside call. The remote operation will be terminated.

I cannot operate the answering device with the handset.

- Someone is operating the answering device.
- You are too far from the base unit. Move closer to the base unit.

Note for Australian users:

- Panasonic Australia operates a toll free Customer Care Centre. Please call 132600 for assistance. or visit the website [www.panasonic <http://www.panasonic.com.au>](http://www.panasonic.com.au)

Note for New Zealand users:

- Panasonic New Zealand operates a toll free Customer Support Centre. Please call 0800-Panasonic (0800-726276) for assistance.

If a power failure occurs

- The unit will not function.
- The unit is not designed for making emergency telephone calls when the power fails. Alternative arrangements should be made for access to emergency services.
- Fax transmission and reception will be interrupted.
- If the delayed transmission (feature #25 on page 72) is programmed and the start time is passed during a power failure, transmission will be attempted soon after power is restored.
- If any fax documents are stored in the memory, they will be lost. When power is restored, a power down report will be printed out stating which contents in the memory have been erased.

Recording paper jam

If the unit does not eject any recording paper during fax reception or copying, the recording paper has jammed and the display will show the following.

Display: PAPER JAMMED

1 Open the front cover by pulling up the centre part.

2 Push the back cover open button (green) on the right side of the unit.

OR

Push the back cover open lever (green) inside of the unit.

3 Open the back cover.

4 Remove the jammed recording paper.

5 Turn the "T" shaped gear (blue) in the direction of the arrow.

- Make sure that the ink film is wrapped around the blue core at least once.

Correct

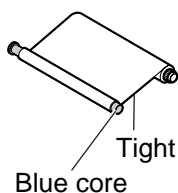

Incorrect

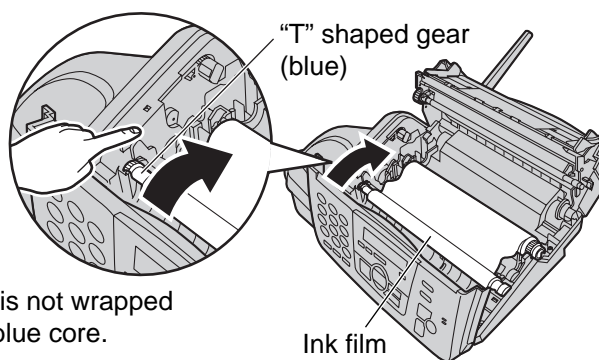
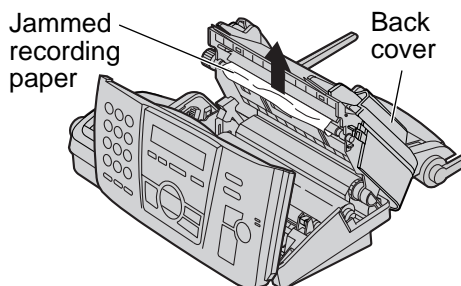
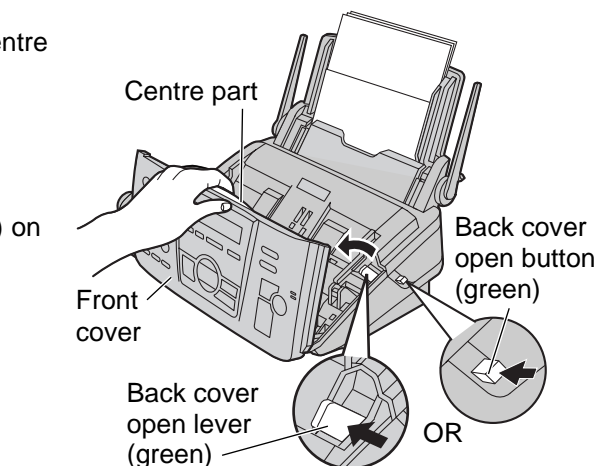
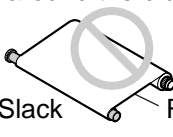
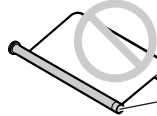

6 Close the back cover securely by pushing down on the dotted area at both ends (①). Close the front cover securely (②).

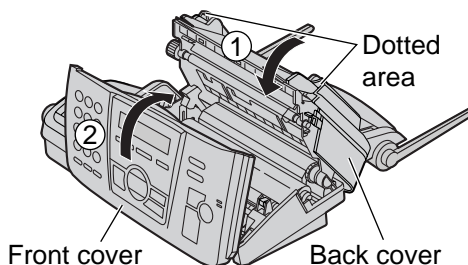

Document jams – sending

If the unit does not release the document during feeding, remove the jammed document as follows:

- 1 Open the front cover by pulling up the centre part.
- 2 Remove the jammed document carefully.
- 3 Close the front cover securely.

Note:

- Do not pull out the jammed paper forcibly before opening the front cover.

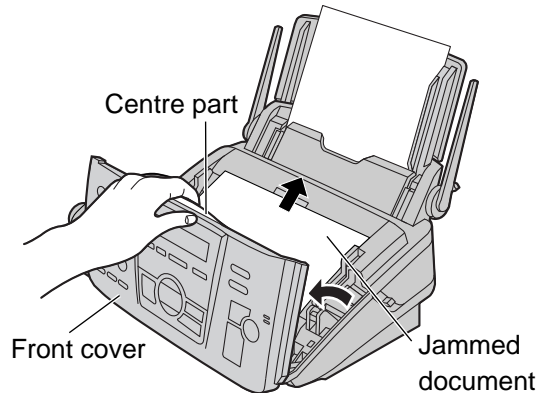

Replacing the handset battery

Replace the battery with a new **Panasonic rechargeable battery Model No. P-P510**. See page 10 for accessory information.

To prevent memory loss, replace the battery within 3 minutes.

- 1 **Carefully** insert a flat metal object in the slot, and push forward to release the lock. Remove the handset cover off the handset.
- 2 Disconnect the battery connector and remove the used battery.
- 3 Connect the battery connector of the new battery, and insert the battery into the handset. Place the battery leads inside the groove.
- 4 Replace the handset cover on the handset.
 - Be sure to charge the new battery for about **6 hours** before use (p. 22).

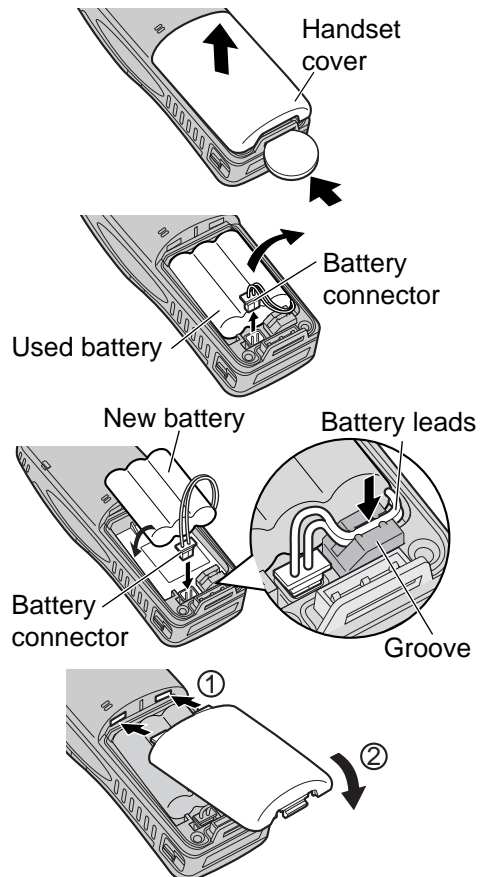

Cleaning

Document feeder

If misfeeding occurs frequently or if dirty patterns or black bands appear on a transmitted document or on the original of a copied document, clean the document feeder.

- 1** Disconnect the power cord and the telephone line cord.
- 2** Open the front cover by pulling up the centre part.
- 3** Clean the document feeder rollers and rubber flap with a cloth moistened with isopropyl rubbing alcohol, and let all parts dry thoroughly.
- 4** Clean the glass with a soft and dry cloth.
- 5** Close the front cover securely.
- 6** Connect the power cord and the telephone line cord.

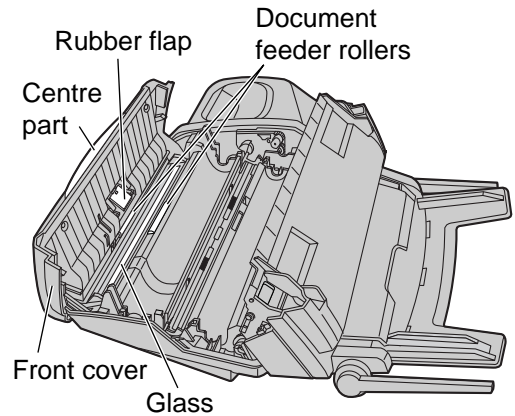
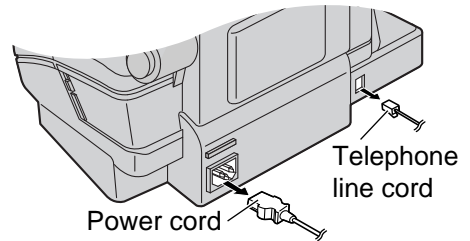

Caution:

- Do not use paper products, such as paper towels or tissues, to clean the inside of the unit.

Thermal head

If dirty patterns or black or white bands appear on a copied or received document, check whether there is dust on the thermal head and clean the thermal head to remove the dust.

- 1** Disconnect the power cord and the telephone line cord.
- 2** Open the front cover by pulling up the centre part.
- 3** Open the back cover by pushing the back cover open button (green) or pushing the back cover open lever (green).
- 4** Clean the thermal head with a cloth moistened with isopropyl rubbing alcohol, and let it dry thoroughly.
 - Do not touch the black sheets on the thermal head.
- 5** Close the back cover securely by pushing down on the dotted area at both ends. Close the front cover securely.
- 6** Connect the power cord and the telephone line cord.

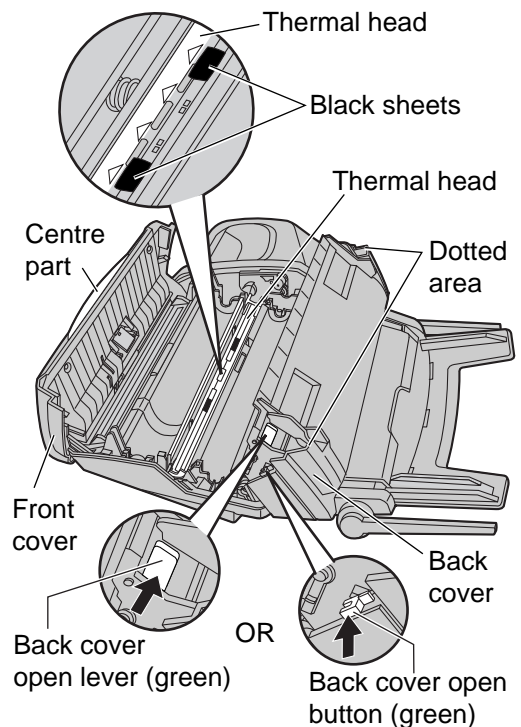

Caution:

- To prevent a malfunction due to static electricity, do not use a dry cloth and do not touch the thermal head directly.

Printed Reports

Reference lists and reports

You can print out the following lists and reports for your reference.

Setup list: provides you with the current settings of the basic and advanced programming features (p. 70–77).

Telephone number list: provides you with names and telephone numbers which are stored in the directory.

Journal report: keeps records of fax transmission and reception. This report will be printed automatically after every 30 fax communications (p. 41).

Printer test list: allows you to check the print quality of your unit. If the test print has a dirty pattern, or blurred points or lines, clean the thermal head (p. 88).

Broadcast programming list: provides you with items which are stored in the broadcast feature (p. 43).

Caller ID list: keeps records of the last 30 callers after subscribing to a Caller ID service. This report will be printed automatically after every 30 callers (p. 33).

1 Press **MENU** repeatedly until the following is displayed.

Display:

PRINT REPORT PRESS NAVI. [◀ ▶]

2 Press **◀** or **▶** until the desired item is displayed.

SETUP LIST PRESS SET

TEL NO. LIST PRESS SET

JOURNAL REPORT PRESS SET

PRINTER TEST PRESS SET

BROADCAST LIST PRESS SET

CALLER ID LIST PRESS SET

3 Press **SET** to start printing.

PRINTING

- To stop printing, press **STOP**.
- After printing, the printed item will be displayed.

4 Press **MENU**.

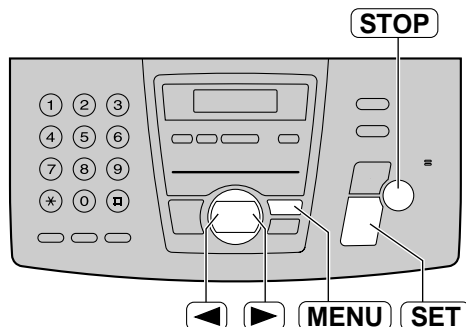

Technical data about this product

■ Base unit

Applicable lines:	Public Switched Telephone Network
Document size:	Max. 216 mm in width / Max. 600 mm in length
Effective scanning width:	208 mm
Effective printing width:	202 mm
Transmission time*:	Approx. 9 s/page (Original mode)**
Scanning density:	Horizontal: 8 pels/mm Vertical: 3.85 lines/mm –STANDARD 7.7 lines/mm –FINE/PHOTO 15.4 lines/mm –SUPER FINE
Halftone level:	64-level
Scanner type:	Contact Image Sensor (CIS)
Printer type:	Thermal Transfer on plain paper
Data compression system:	Modified Huffman (MH), Modified READ (MR), Modified Modified READ (MMR)
Modem speed:	14,400 / 12,000 / 9,600 / 7,200 / 4,800 / 2,400 bps; Automatic Fallback
Operating environment:	5 °C – 35 °C (41 °F – 95 °F), 20% – 80% RH (Relative Humidity)
Dimensions (H x W x D):	Approx. 199 mm x 384 mm x 282 mm
Mass (Weight):	Approx. 3.3 kg
Power consumption:	Standby: Approx. 8.5 W Transmission: Approx. 22 W Reception: Approx. 43 W (When receiving a 20% black document) Copy: Approx. 45 W (When copying a 20% black document) Maximum: Approx. 127 W (When copying a 100% black document)
Power supply:	220–240 V AC, 50/60 Hz
Fax memory capacity:	Approx. 25 pages of memory transmission Approx. 28 pages of memory reception (Based on the ITU-T No. 1 Test Chart in standard resolution.)
Voice memory capacity***:	Approx. 18 minutes of recording time including greeting messages

■ Handset

Operating environment:	5 °C – 35 °C (41 °F – 95 °F), 20% – 80% RH (Relative Humidity)
Dimensions (H x W x D):	Approx. 37 mm x 58 mm x 237 mm
Mass (Weight):	Approx. 228 g
Power supply:	Ni-Cd battery (3.6 V, 850 mAh)
Frequency:	2.4015 – 2.4705 GHz (24 channels)
Security codes:	1,000,000

- * Transmission speed depends upon the contents of the pages, resolution, telephone line conditions and capability of the other party's machine.
- ** Transmission speed is based upon the ITU-T No. 1 Test Chart and original mode.
If the capability of the other party's machine is inferior to your unit, the transmission time may be longer.
- *** Recording time may be reduced by the calling party's background noise.

Note:

- Any details given in these instructions are subject to change without notice.
- The pictures and illustrations in these instructions may vary slightly from the actual product.

ITU-T No. 1 Test Chart

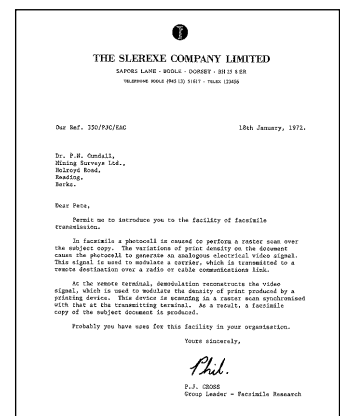

Specifications

■ Paper specifications

Recording paper size: A4: 210 mm x 297 mm

Note:

- Do not use the following types of paper:
 - Paper with a cotton and/or fibre content that is over 20%, such as letterhead paper or paper used for resumes.
 - Extremely smooth or shiny paper, or paper that is highly textured.
 - Coated, damaged or wrinkled paper.
 - Paper with irregularities, such as tabs or staples.
 - Paper which has dust, lint or oil stains.
 - Paper that will melt, vaporize, discolour, scorch or emit dangerous fumes, near 200 °C (392 °F), such as vellum paper. These materials may transfer onto the fusing roller and cause damage.
 - Moist paper.
- Some paper only accepts print on one side. Try using the other side of the paper if you are not happy with the print quality or if misfeeding occurs.
- For proper feeding and best print quality, we recommend using long-grained paper.
- Do not use paper of different types or thickness at the same time. This may cause a paper jam.
- Avoid double-sided printing.
- Do not use paper printed from this unit for double-sided printing with other copiers or printers. This may cause a paper jam.
- To avoid curling, do not open paper packs until you are ready to use the paper. Store unused paper in the original packaging, in a cool and dry location.

Program index

Basic features

Code Feature name

#01	Date and time	17
#02	Your logo.....	18
#03	Your facsimile telephone number	20
#04	Sending report	41, 70
#06	TAD/FAX ring setting	56, 70
#06	FAX ring setting	70
#10	Recording time for an incoming message	71
#11	Remote operation ID	71
#13	Dialling mode (for Australian users only).....	71
#17	Ringer pattern.....	23, 71

Advanced features

Code Feature name

#22	Journal report	41, 72
#23	Overseas mode	72
#25	Delayed transmission	72
#26	Caller ID list	33, 72
#30	Silent fax ring setting.....	50, 51, 73
#31	Ring detection.....	53
#34	Quick scan.....	41, 54, 73

Advanced features (cont.)

Code Feature name

#36	Receiving reduction	73
#39	Display contrast	73
#41	Remote fax activation code	52, 74
#42	Message alert	74
#43	Recording time alert	74
#44	Fax receiving alert	74
#46	Friendly reception	48, 75
#47	Fax voice guidance.....	75
#51	Mailbox 1 password.....	75
#52	Mailbox 2 password.....	75
#54	Greeting time	75
#55	Mailbox 1 greeting	65
#56	Mailbox 2 greeting	65
#58	Original mode	76
#60	Message transfer	68, 76
#61	Message transfer greeting message ..	76
#67	Incoming message monitor	76
#70	Pager call.....	52
#76	Connecting tone	77
#77	Auto answer.....	77
#78	TEL/FAX ring setting	50, 51, 77
#80	Reset advanced features.....	77

Index

- A** Accessories10
 - (A4 paper guide)15
 - (Belt clip)21
 - (Paper tray)15Advanced features72–77Alert
 - (Memory reception)(Feature #44) .74
 - (Message)(Feature #42)74
 - (Recording time)(Feature #43) . . .74Auto Answer setting (Feature #77) . . .77
- B** Basic features70, 71Battery
 - (Charging)22
 - (Life)22
 - (Replacing)87Broadcast transmission43Buttons
 - (AUTO ANSWER)48–50, 56
 - (CH)24
 - (CLR)36
 - (Delete)19
 - (DIGITAL SP-PHONE)24, 39
 - (ERASE)58, 59
 - (EXIT)34
 - (FAX RECEIVE)48
 - (HELP)11
 - (Insert)19
 - (INTERCOM)26, 27
 - (LOCATOR/INTERCOM) . . .26, 27
 - (QUICK)59
 - (REDIAL)40
 - (SEARCH)35
 - (SLOW)59
- C** Call counter59Caller ID33
 - (Calling back)34, 35
 - (Storing)38Caller ID list (Feature #26) . . .33, 72Caller's recording time (Feature #10) .71Character table19, 28Cleaning88Communication messages78Connecting tone (Feature #76) . . .77Connections16Copy54
 - (Collation)55
 - (Enlarge)55
 - (Reduce)55
- D** Date and time (Feature #01) . . .17, 70Delayed transmission (Feature #25) . .72Dialling mode (Feature #13)71Directory
 - (Making a phone call)32
 - (Selecting characters)19, 28
 - (Sending faxes)42
 - (Storing)28, 29Display
 - (Contrast)(Feature #39)73
 - (Error messages)79, 80Distinctive ring service
 - (Feature #31)52, 73Document size41
- E** Error messages78–80Extension telephone51, 52
- F** Facsimile telephone number
 - (Feature #03)20, 70Fax activation code
 - (Feature #41)52, 74Fax auto redial42FAX ONLY mode49Fax receiving46, 47Fax voice guidance (Feature #47) 41, 75Friendly reception (Feature #46) .48, 75
- G** Greeting message
 - (Message transfer)(Feature #61) .68, 76
 - (TAD/FAX)56–58
 - (TEL/FAX)50, 51, 57, 58
 - (Voice mailbox)(Feature #55, #56) . 65, 75
- H** Handset locator26Headset21Help11
- I** Incoming message monitor
 - (Feature #67)76Ink film13, 14
- J** Jams
 - (Document)87
 - (Paper)86Journal report (Feature #22) . . .41, 72
- L** Logo (Feature #02)18, 70
- M** Memory reception48Message alert (Feature #42)74Message transfer (Feature #60) . .68, 76

- O** Original mode (Feature #58)76
- Overseas mode (Feature #23)72
- P** Pager call (Feature #70)52, 77
- Power failure85
- Q** Quick scan (Feature #34) . . .41, 54, 73
- R** Receive polling53
- Receiving alert (Feature #44)74
- Receiving reduction (Feature #36) . . .73
- Receiving setting46, 47
- Recording
 - (Greeting message)57, 65, 68
 - (Memo message)58, 66
- Recording paper15
- Recording paper size92
- Recording time alert (Feature #43) . .74
- Recording time for TAD/FAX greeting message (Feature #54)75
- Remote operation card61, 62
- Remote operation ID (Feature #11) . .71
- Reports
 - (Broadcast programming)90
 - (Broadcast sending)45
 - (Caller ID)33, 90
 - (Journal)41, 90
 - (Power down)85
 - (Printer test)90
 - (Sending)41
 - (Setup)90
 - (Telephone number)90
- Reset (Feature #80)77
- Resolution40, 54
- Ring detection (Feature #31)53, 73
- Ring setting
 - (FAX ONLY)(Feature #06)70
 - (Silent fax)(Feature #30)73
 - (TAD/FAX)(Feature #06)70
 - (TEL/FAX)(Feature #78)77
- Ringer pattern (Feature #17)23, 71
- S** Sending
 - (Broadcast)45
 - (Directory)42
 - (From memory)41
 - (Manually)40
- Sending report (Feature #04)41, 70
- Set default (Feature #80)77
- Storing
 - (Broadcast)43
 - (Directory)28, 29
- T** TAD/FAX mode56
- TEL mode48
- TEL/FAX mode50
- Toll saver56
- V** Voice contact39
- Voice mailbox64
- Voice mailbox password
 - (Feature #51, #52)66, 67, 75
- Voice time/day stamp59
- Volume23

Kyushu Matsushita Electric Co., Ltd.

1-62, 4-chome, Minoshima, Hakata-ku, Fukuoka 812-8531, Japan

PFQX1652ZA WM1201ST0

Free Manuals Download Website

<http://myh66.com>

<http://usermanuals.us>

<http://www.somanuals.com>

<http://www.4manuals.cc>

<http://www.manual-lib.com>

<http://www.404manual.com>

<http://www.luxmanual.com>

<http://aubethermostatmanual.com>

Golf course search by state

<http://golfingnear.com>

Email search by domain

<http://emailbydomain.com>

Auto manuals search

<http://auto.somanuals.com>

TV manuals search

<http://tv.somanuals.com>