

Panasonic®

High Speed Laser Fax with Copier Function

Operating Instructions

Model No. **KX-FL501C**



Please read these Operating Instructions before using the unit and save for future reference.

For assistance, please call
1-800-300-4644 or visit us at
www.panasonic.ca

PFQX1493ZA BM1100MN0

Thank you for purchasing a Panasonic facsimile.

You can select English or French for the language.

The display will be in the selected language. The default setting is “ENGLISH”. If you want to change the setting to “FRENCH”, see feature #48 on page 57.

For your future reference

Date of purchase

Serial number

(found on the rear of the unit)

Dealer's name and address

Dealer's telephone number

Caution:

- Do not rub or use an eraser on the printed side of recording paper, as the print may smear.

Copyright:

This manual is copyrighted by Kyushu Matsushita Electric Co., Ltd. (KME) and its licensee. Under the copyright laws, this manual may not be reproduced in any form, in whole or part, without the prior written consent of KME and its licensee.

© Kyushu Matsushita Electric Co., Ltd. 2000

Important safety instructions

When using this unit, basic safety precautions should always be followed to reduce the risk of fire, electric shock, or personal injury.

1. Read and understand all instructions.
2. Follow all warnings and instructions marked on this unit.
3. Unplug this unit from power outlets before cleaning. Do not use liquid or aerosol cleaners. Use a damp cloth for cleaning.
4. Do not use this unit near water, for example near a bathtub, wash bowl, kitchen sink, or the like.
5. Place the unit securely on a stable surface. Serious damage and/or injury may result if the unit falls.
6. Do not cover slots and openings on the unit. They are provided for ventilation and protection against overheating. Never place the unit near radiators, or in a place where proper ventilation is not provided.
7. Use only the power source marked on the unit. If you are not sure of the type of power supplied to your home, consult your dealer or local power company.
8. For safety purposes this unit is equipped with a grounded plug. If you do not have this type of outlet, please have one installed. Do not use any type of adaptor plug to defeat this safety feature.
9. Do not place objects on the power cord. Install the unit where no one can step or trip on the cord.
10. Do not overload wall outlets and extension cords. This can result in the risk of fire or electric shock.
11. Never push any objects through slots in this unit. This may result in the risk of fire or electric shock. Never spill any liquid on the unit.
12. To reduce the risk of electric shock, do not disassemble this unit. Take the unit to an authorized service centre when service is required. Opening or removing covers may expose you to dangerous voltages or other risks. Incorrect reassembly can cause electric shock when the unit is subsequently used.
13. Unplug this unit from the wall outlet and refer servicing to an authorized service centre when the following conditions occur:
 - A. When the power supply cord or plug is damaged or frayed.
 - B. If liquid has been spilled into the unit.
 - C. If the unit has been exposed to rain or water.
 - D. If the unit does not work normally by following the operating instructions. Adjust only controls covered by the operating instructions. Improper adjustment may require extensive work by an authorized service centre.
 - E. If the unit has been dropped or physically damaged.
 - F. If the unit exhibits a distinct change in performance.
14. During thunderstorms, avoid using telephones except cordless types. There may be a remote risk of an electric shock from lightning.
15. Do not use this unit to report a gas leak, when in the vicinity of the leak.

SAVE THESE INSTRUCTIONS

Safety instructions

CAUTION:

Laser radiation

- The printer of this unit utilizes a laser. Use of controls or adjustments or performance of procedures other than those specified herein may result in hazardous radiation exposure.

DANGER-Invisible laser radiation when open and interlock defeated.
AVOID DIRECT EXPOSURE TO BEAM.
DANGER-RADIATION LASER INVISIBLE LORSQUE OUVERT ET DISPOSITIF DE VERROUILLAGE HORS SERVICE.
ÉVITER TOUTE EXPOSITION AU FAISCEAU.

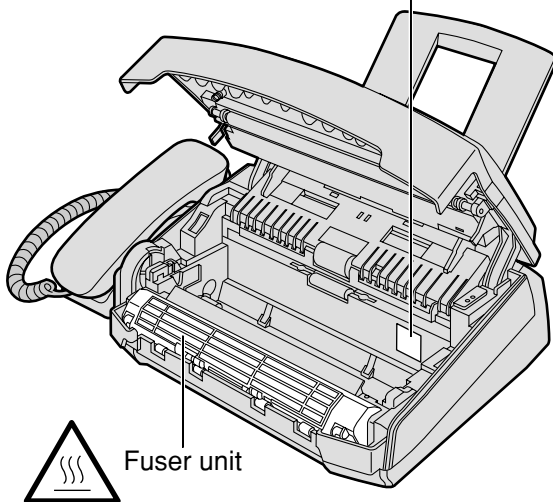

Fuser unit

- The fuser unit gets hot. Do not touch it.

Toner cartridge

- Be careful of the following when you handle the toner cartridge.
 - If you ingest any toner, drink several glasses of water to dilute your stomach contents, and seek immediate medical treatment.
 - If any toner comes into contact with your eyes, flush them thoroughly with water, and seek medical treatment.
 - If any toner comes into contact with your skin, wash the area thoroughly with soap and water.

Drum unit

- Read the instructions on pages 12 and 13 before you begin installation of the drum unit. After you have read them, open the drum unit protection bag. The drum unit contains a photosensitive drum. Exposing it to light may damage the drum. Once you have opened the protection bag:
 - Do not expose the drum unit to light for more than 5 minutes.
 - Do not touch or scratch the green drum surface.
 - Do not place the drum unit near dust or dirt, or in a high humidity area.
 - Do not expose the drum unit to direct sunlight.

Safety instructions

CAUTION:

Installation

- Never install telephone wiring during a lightning storm.
- Never install telephone jacks in wet locations unless the jack is specifically designed for wet locations.
- Never touch uninsulated telephone wires or terminals unless the telephone line has been disconnected at the network interface.
- Use caution when installing or modifying telephone lines.

WARNING:

- To prevent the risk of fire or electrical shock, do not expose this product to rain or any type of moisture.

OTHER INFORMATION:

- Keep the unit away from electrical noise generating devices, such as fluorescent lamps and motors.
- The unit should be kept free from dust, high temperature and vibration.
- The unit should not be exposed to direct sunlight.
- Do not place heavy objects on top of this unit.
- Do not touch the plug with wet hands.

Table of Contents

Initial Preparation

Accessories	Included accessories	8
	Accessory information	8
Help Button	Help function	9
Finding the Controls	Overview	10
	Location	11
Setup	Toner cartridge and drum unit	12
	Paper tray, document stacker and paper stacker	14
	Recording paper	15
	Connections	16
	Date and time, your logo and facsimile telephone number	17
Volumes	Adjusting volumes	21

Telephone

Automatic Dialing	Storing names and telephone numbers in ONE-TOUCH DIAL	22
	Storing names and telephone numbers in SPEED DIRECTOR	23
	Editing and erasing a stored name and number	24
	Making a voice call using ONE-TOUCH DIAL and SPEED DIRECTOR	26
Call Display	Call Display service from your phone company	27
	Viewing and calling back using caller information	28
	Confirming caller information using the Caller's list	29
	Storing caller information in ONE-TOUCH DIAL and SPEED DIRECTOR	30
Voice Contact	Talking to the other party after fax transmission or reception	31

Fax

Sending Faxes	Sending a fax manually	32
	Sending a fax using ONE-TOUCH DIAL and SPEED DIRECTOR	33
	Documents you can send	34
	Reports for confirmation	35
	Broadcast transmission	36
Receiving Faxes	Setting the unit to receive faxes	40
	TEL mode (answering all calls manually)	42
	FAX ONLY mode (all calls are received as faxes)	43
	Using the unit with an answering machine	44
	TEL/FAX mode (receiving voice calls with rings and fax calls without rings when you are near the unit)	46
	Using with an answering machine and computer	48
	Extension telephone	48
	Pager call - when the unit receives a fax	49

Copy

Copying	Making a copy	50
	Convenient way to make a copy	50

Programmable Features

Features	Programming.	52
Summary	Basic features	53
	Advanced features.	55

Help





Error Messages	Reports.	60
	Display	61
Operations	When a function does not work, check here before requesting help	63
	If a power failure occurs	67
Replacement	Replacing the toner cartridge and the drum unit	68
Jams	Recording paper jam.	70
	Document jams - sending	72
	No feeding or multiple feeding occurs while sending	72
Cleaning	Cleaning the inside of the unit.	73

General Information

Printed Reports	Reference lists and reports	75
Warranty	Limited warranty	76
Important Information	Important information	77
Specifications	Technical data about this product	78
Index	Index.	80

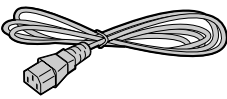
Accessories

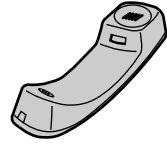
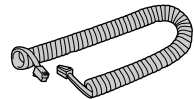
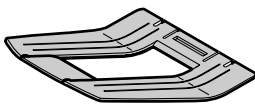
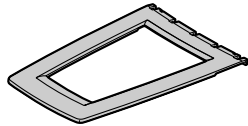
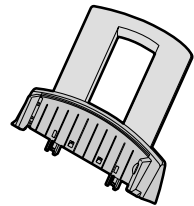
Included accessories

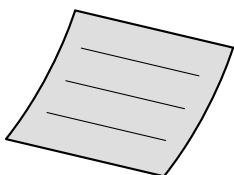
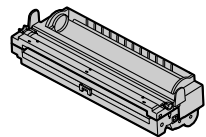
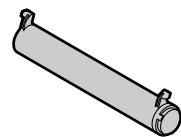
Power cord.....1  Part No. PFJA1030Z	Telephone line cord...1  Part No. PQJA10075Z	Handset.....1  Part No. PFJXE0805Z	Handset cord.....1  Part No. PFJA1029Z
Paper stacker.....1  Part No. PFZX1FL501M	Document stacker ...1  Part No. PFKS1055Z	Paper tray1  Part No. PFZXFL501M	Operating instructions...1  Part No. PFQX1493Z
Quick Start Sheet1  Part No. PFQW1457Z	Drum unit.....1 	Toner cartridge.....1 (complementary starter toner cartridge)  <p>This cartridge can print approx. 800 sheets of letter size paper with a 5% image area. Refer to image area on page 79. Please purchase a replacement toner cartridge Model No. KX-FA76A for continuous use of your unit.</p>	

- If any item is missing or damaged, check with the place of purchase.
- The part numbers listed above are subject to change without notice.
- Save the original carton and packing materials for future shipping and transportation of the unit.

Accessory information

Model No.	Item	Usage	Specifications
KX-FA76A	Toner cartridge	For replacement. See page 68.	See page 79.
KX-FA77A	Drum unit	For replacement. See page 68.	See page 79.

For ordering information, please contact your local Panasonic dealer.

Help function

You can print a quick reference for assistance as follows.

1 Press **HELP**.

Display:

2 Rotate **SPEED DIRECTOR** until the desired item is displayed.

1. How to set the date, time, your logo and fax number.

2. How to program the features.

3. How to store names in the SPEED DIRECTOR directory and how to dial them.

4. Help with problems sending/receiving faxes.

5. How to use the copier function.

6. Frequently asked questions and answers.

7. Explanation of error messages shown on the display.

8. List of available reports.

9. How to use the Call Display service.

3 Press **SET**.

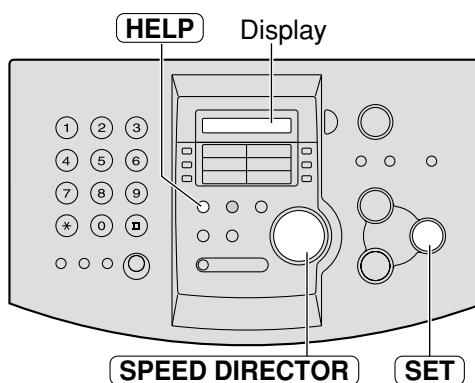

Finding the Controls

Overview

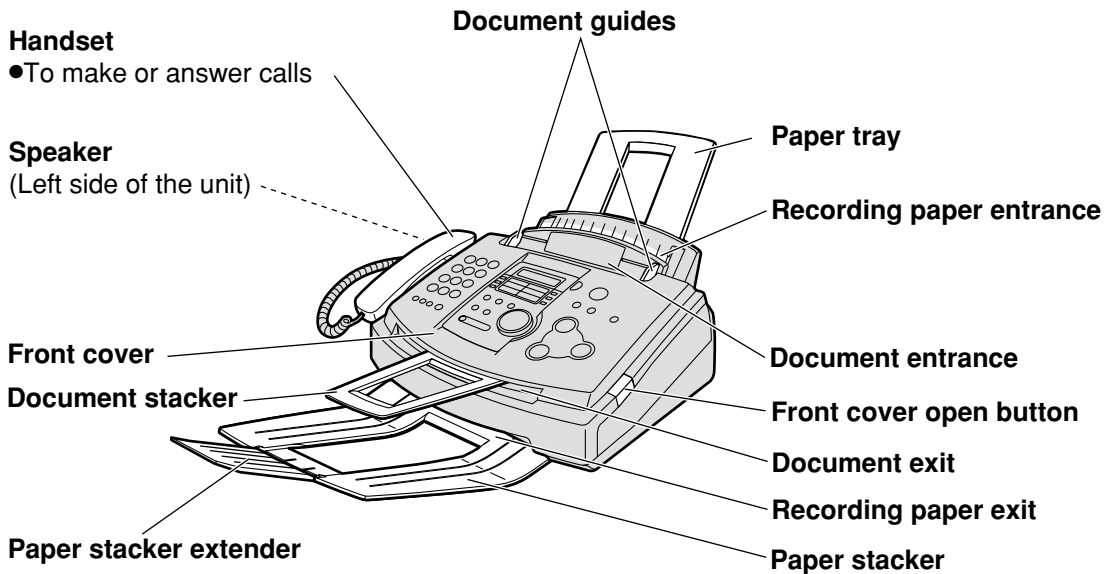

*The document stacker and paper stacker may not be shown in all illustrations.

Location

Dial keypad

Display

FUNCTION PROGRAM

MEMORY%

1	2	3
4	5	6
7	8	9
*	0	□

REDIAL / PAUSE **HANDSET MUTE** **FLASH** **MONITOR**

HELP **PRINT** **SEARCH** **NAME/TEL.NO.** **NAME** **PROGRAM** **MENU** **STOP** **STOP**

BACK SPEED DIRECTOR

AUTO ANSWER **COLLATE** **RESOLUTION** **QUICK SCAN START** **COPY ZOOM VOLUME** **COPY START** **FAX START**

- To turn on/off AUTO ANSWER (p. 40, 41).
- To make a collated copy (p. 51).
- To use ONE-TOUCH DIAL (p. 22, 26, 33).
- To transmit to multiple stations (p. 36, 39).
- To print a quick reference (p. 9).
- To store a scanned document into memory, and then send it (p. 32).
- To adjust volumes (p. 21).
- To select an enlargement or reduction rate in copy mode (p. 51).
- To select a resolution (p. 32, 50).
- To dial without lifting the handset.
- To access special telephone services such as call waiting or transferring an extension call.
- To mute your voice to the other party during conversation. Press this button again to resume conversation.
- To redial the last number dialed.
- To insert a pause during dialing.
- To change from pulse to tone temporarily during dialing when your line has rotary pulse services.
- To use Call Display service (p. 28–30).
- To store or edit names and telephone numbers (p. 22–25).
- To search for a stored name (p. 26, 33).
- To select the features or feature settings during programming (p. 52).
- To confirm a stored telephone number (p. 26).
- To initiate or exit programming.
- To initiate fax transmission or reception.
- To store a setting during programming.
- To initiate copying (p. 50).
- To stop an operation or cancel programming.
- To select stations 6–10 for ONE-TOUCH DIAL (p. 22, 26, 33).

Setup

Toner cartridge and drum unit

Caution:

- Read the instructions below before you begin installation. After you have read them, open the drum unit protection bag. The drum unit contains a photosensitive drum. Exposing it to light may damage the drum. Once you have opened the protection bag:
 - Do not expose the drum unit to light for more than 5 minutes.
 - Do not touch or scratch the green drum surface.
 - Do not place the drum unit near dust or dirt, or in a high humidity area.
 - Do not expose the drum unit to direct sunlight.

- 1** Remove the toner cartridge and drum unit from the protection bags. Peel off the seal from the toner cartridge (①). Remove the protection bar from the drum unit (②).

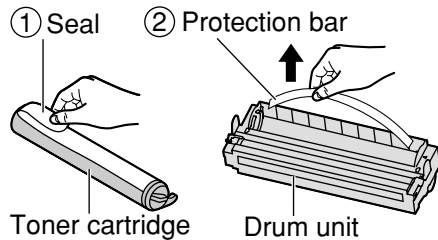

- 2** With Panasonic face up on the toner cartridge, match the red arrows on the cartridge and the drum unit.

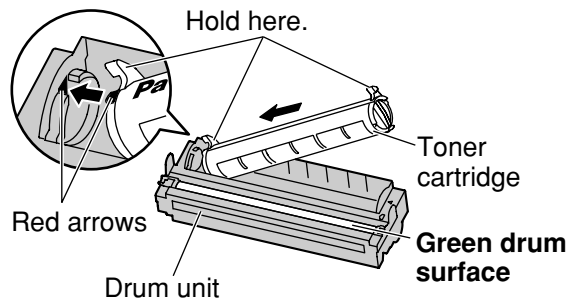

- 3** Slide the tab of the toner cartridge into the slot of the drum unit.

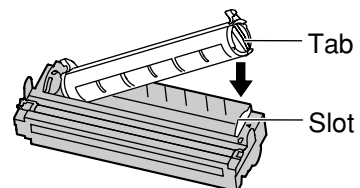

- 4a** Hold right side of the toner cartridge under the lip on the drum unit and...

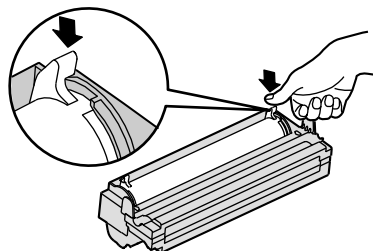

- 4b** turn the two levers on the toner cartridge with firm pressure.

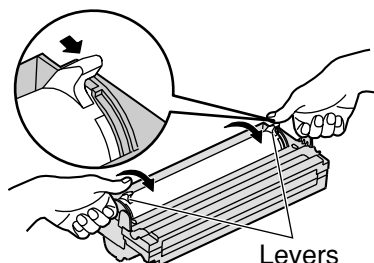

- 5** The toner cartridge is installed when the triangles match.

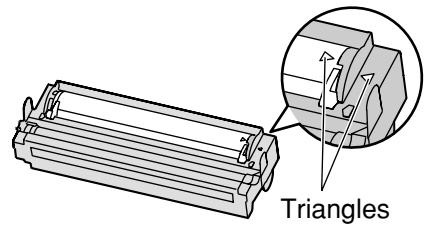

- 6** Tap on the toner cartridge several times to allow the toner to fall into the drum unit. Grab the tabs, and shake the drum and toner unit horizontally several times.

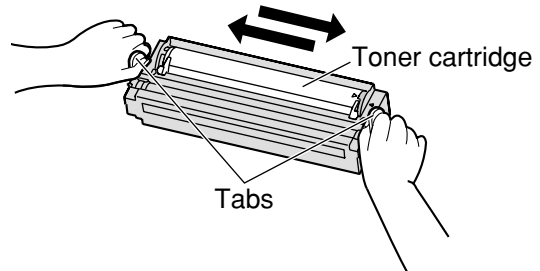

- 7** Push the front cover open button then open the front cover.

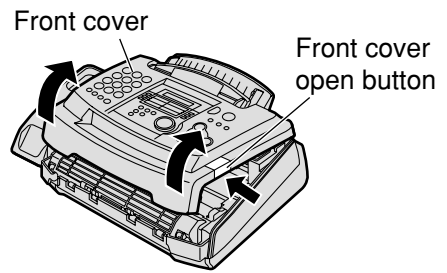

- 8** Install the drum and toner unit by holding the tabs.

- If the lower glass is dirty, clean it with a soft, dry cloth.

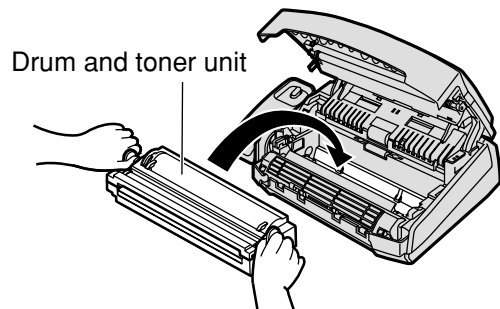
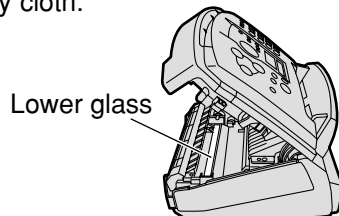

- 9** Close the front cover, until locked, by pushing down on both sides.

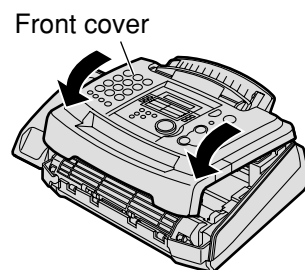

Toner save feature

- If you want to save on toner consumption, set the toner save setting to on (feature #79 on page 59). The toner cartridge will last approx. 40% longer. This feature may reduce print quality.

Setup

Paper tray, document stacker and paper stacker

Paper tray

Insert the paper tray into the two slots on the back of the unit (①).

Let it lean back until it clicks into place (②).

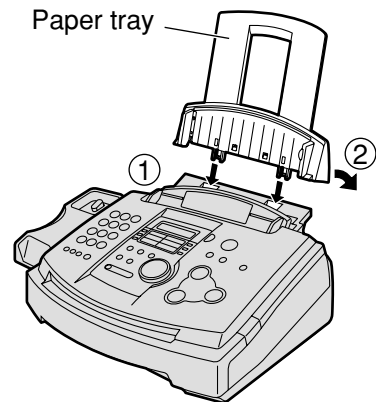

Document stacker

Align with the ribs on the document exit (①).

Pull the document stacker forward gently until it clicks into place (②).

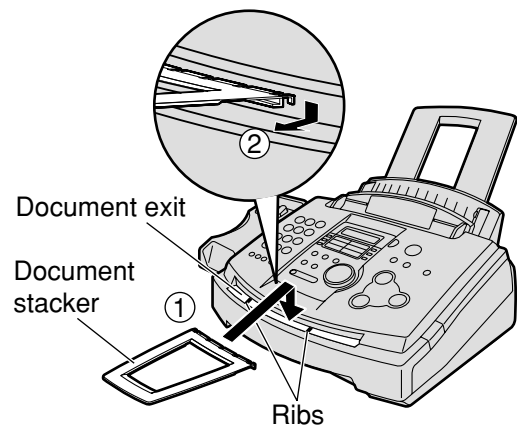

Paper stacker

Line up the slots in the paper stacker with the pegs on the bottom of the unit, then slide until locked.

Open the paper stacker extender when you use legal size paper.

- The paper stacker can hold approx. 100 sheets of printed paper. Remove the printed paper before the paper stacker becomes full.

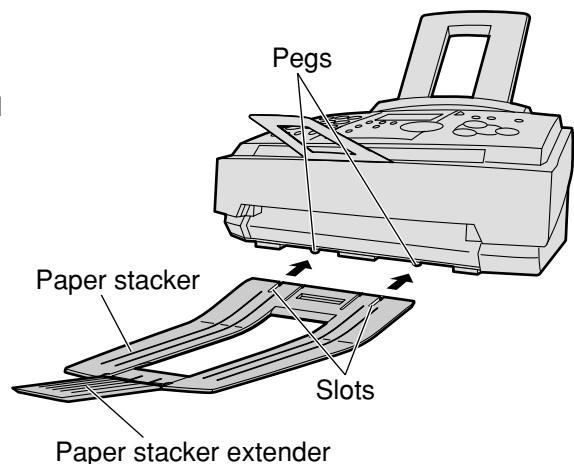

Note for installation:

- Do not place the unit in an area where the paper tray may be obstructed by a wall, etc.
- Document and recording paper will be ejected from the front of the unit. Do not place anything in front of the unit.

Recording paper

Letter or legal size recording paper can be loaded. The unit can hold up to 150 sheets of 60 g/m² to 75 g/m² (16 lb. to 20 lb.) paper or 120 sheets of 90 g/m² (24 lb.) paper.

- The unit is set for letter size paper by default. If you want to use legal size paper, change the setting (feature #16 on page 54).

- 1 Fan the stack of paper to prevent a paper jam.
- 2 Insert the paper into the recording paper entrance.
 - The paper should not be over the tab.
 - If the paper is not inserted correctly, readjust the paper, or the paper may jam.

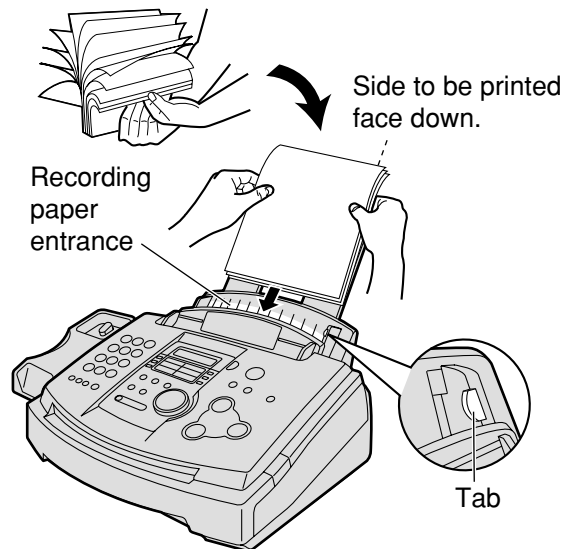
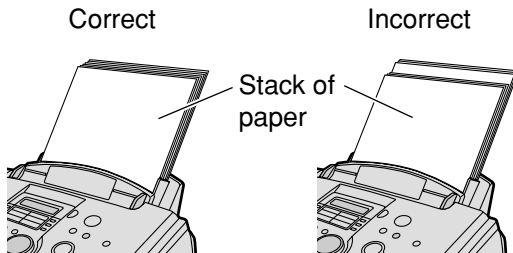

Note for recording paper:

- Avoid using paper with a cotton and/or fiber content that is over 20%, such as letterhead paper or paper used for resumes.
- Do not use different types or thicknesses of paper at the same time. This may cause a paper jam.
- Avoid extremely smooth or shiny paper that is highly textured.
- Avoid paper that is coated, damaged or wrinkled.

Note:

- Avoid double-sided printing.
- Do not use paper printed from this unit for double-sided printing with other copiers or printers, or the paper may jam.
- Some paper only accepts print on one side. Try using the other side of paper if you are not happy with the print quality.

Adding paper

1. Remove all of the installed paper.
2. Add paper to the removed paper and straighten.
3. Fan the stack of paper.
4. Insert the paper into the recording paper entrance.

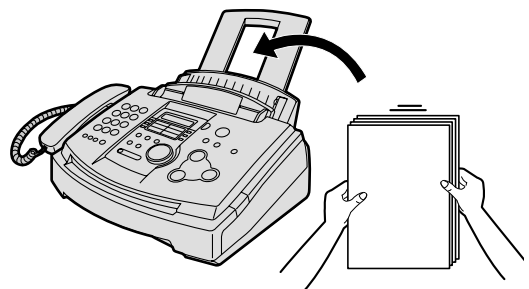

Setup

Connections

- 1 Connect the handset cord.
- 2 Connect the telephone line cord.
- 3 Connect the power cord.
 - When the power is turned on for the first time, the unit will print some basic information.

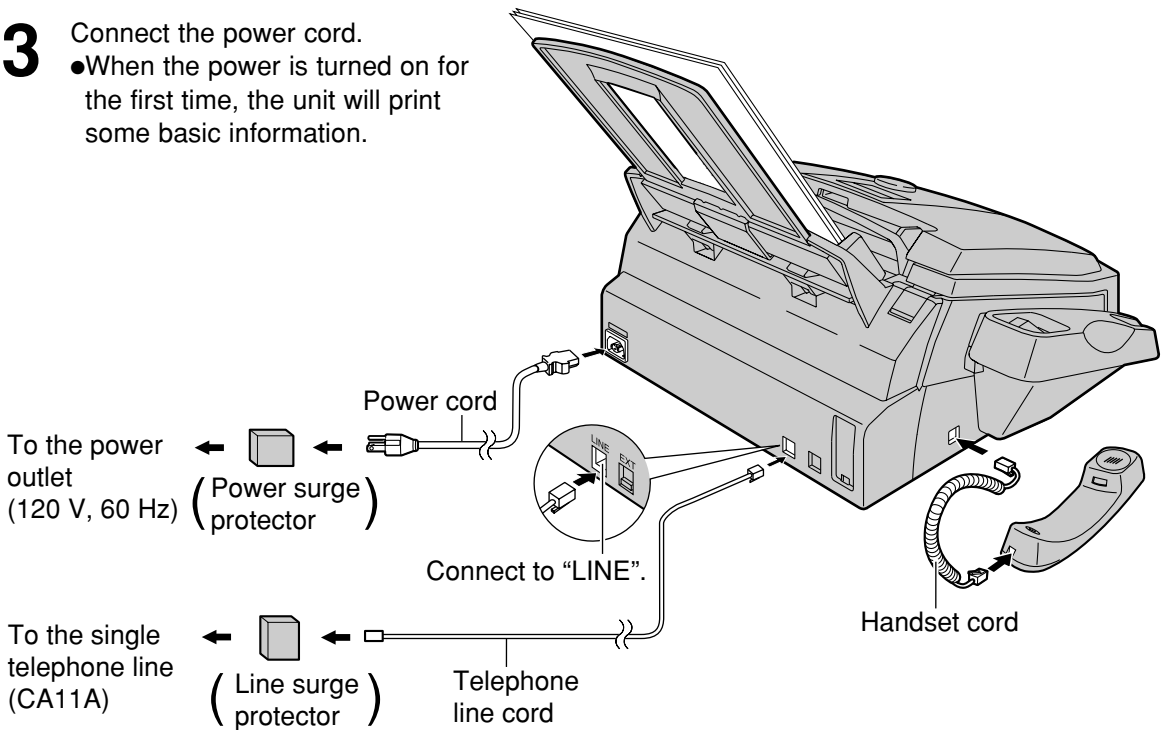

Caution:

- When you operate this product, the power outlet should be near the product and easily accessible.

Note:

- The warranty does not cover damage due to power line surges or lightning. For additional equipment protection, we recommend the use of a surge protector. For further details, contact our service personnel.
- If you want to connect an answering machine to the unit, see page 44.

Date and time, your logo and facsimile telephone number

You should program the date and time, your logo and facsimile telephone number. This information will be printed on each page transmitted from your unit.

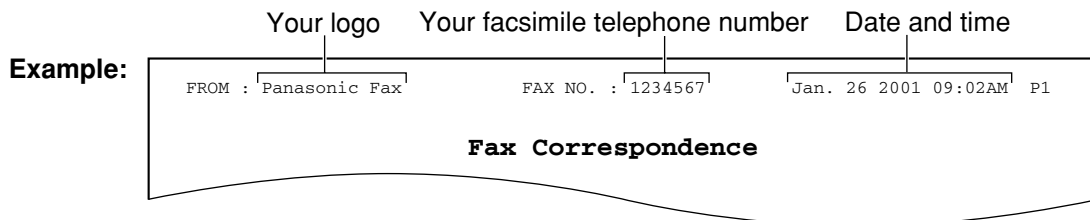

Setting the date and time

1 Press **MENU** .
 Display: SYSTEM SET UP

2 Press **⏏**, then **0 1** .
 SET DATE & TIME

3 Press **SET** .
 Example: M:01/D:01/Y:01
 Cursor

4 Enter the correct month/day/year by selecting 2 digits for each, using the dial keypad.
Example: Aug. 10, 2001
 Press **08 10 01** .
 M:08/D:10/Y:01

5 Press **SET** .
 Example: TIME: 12:00AM

6 Enter the correct hour/minute by selecting 2 digits for each, using the dial keypad.
 Press ***** to select "AM" or "PM".
Example: 3:15PM
 1. Press **03 15** .
 TIME: 03:15AM
 2. Press ***** until "PM" is displayed.
 TIME: 03:15PM

7 Press **SET** .
 SETUP ITEM []

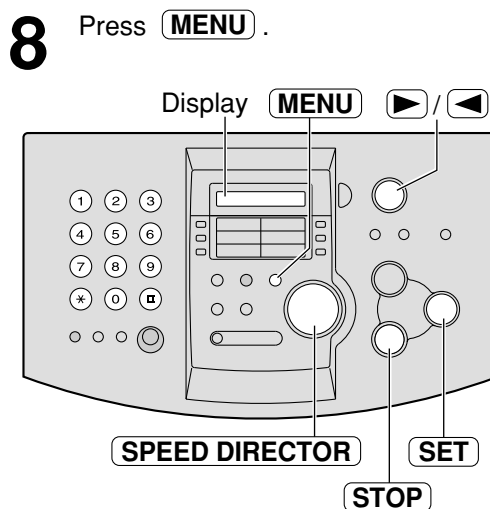

Note:

- You can enter the number by rotating **SPEED DIRECTOR** in steps 4 and 6. In this case, press **▶** to move the cursor.
- If you select "FRENCH" for the language (feature #48 on page 57), the time is set using a 24 hour clock (military time).
Example: 15:15
 Press **15 15** .
- The accuracy of the clock is approximately ±60 seconds a month.

To correct a mistake

- Press **▶** or **◀** to move the cursor to the incorrect number, and make the correction.
- If you press **STOP** while programming, the display will return to the previous one.

Setup

Setting your logo

The logo can be your company, division or name.

1 Press **MENU** .
Display: SYSTEM SET UP

2 Press **⇠** , then **0 2** .
YOUR LOGO

3 Press **SET** .
LOGO=

4 Enter your logo, up to 30 characters, using the dial keypad. See the next page for details.
Example: "Bill"

1. Press **2** twice.

LOGO=B
Cursor

2. Press **4** six times.

LOGO=Bi

3. Press **5** six times.

LOGO=Bi

4. Press **▶** to move the cursor to the next space and press **5** six times.

LOGO=Bill

5 Press **SET** .
SETUP ITEM []

6 Press **MENU** .

Note:

- You can enter your logo by rotating **SPEED DIRECTOR** (see the next page).

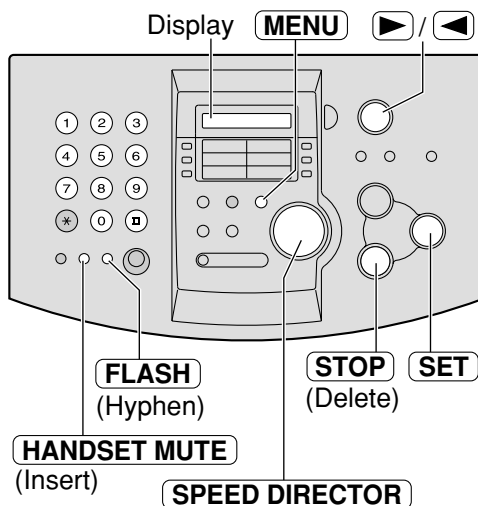

To change capital or lower case letters

Pressing the **⇠** key will change to capital or lower case alternatively.

1. Press **2** twice.

Display: LOGO=B

2. Press **4** three times.

LOGO=Bi

3. Press **⇠** .

LOGO=Bi

4. Press **5** three times.

LOGO=Bi

To correct a mistake

- Press **▶** or **◀** to move the cursor to the incorrect character, and make the correction.

To delete a character

- Move the cursor to the character you want to delete and press **STOP** .

To insert a character

1. Press **▶** or **◀** to move the cursor to the position to the right of where you want to insert the character.
2. Press **HANDSET MUTE (Insert)** to insert a space and enter the character.

To select characters with the dial keypad

Pressing the dial keys will select a character as shown below.

Keys	Characters
①	1 [] { } + - / = , . _ ` : ; ?
②	A B C a b c 2
③	D E F d e f 3
④	G H I g h i 4
⑤	J K L j k l 5
⑥	M N O m n o 6
⑦	P Q R S p q r s 7
⑧	T U V t u v 8
⑨	W X Y Z w x y z 9
⑩	0 () < > ! " # \$ % & ¥ * @ ^ ' →
⊞	To change capital or lower case letter.
FLASH	Hyphen button (To insert a hyphen.)
HANDSET MUTE	Insert button (To insert one character or one space.)
STOP	Delete button (To delete a character.)
▶	▶ key (To move the cursor to the right.) To enter another character using the same number key, move the cursor to the next space.
◀	◀ key (To move the cursor to the left.)

To select characters using SPEED DIRECTOR

Instead of pressing the dial keys, you can select characters using SPEED DIRECTOR.

1. Rotate **SPEED DIRECTOR** until the desired character is displayed.
2. Press ▶ to move the cursor to the next space.
 - The character displayed in step 1 is inserted.
3. Return to step 1 to enter the next character.

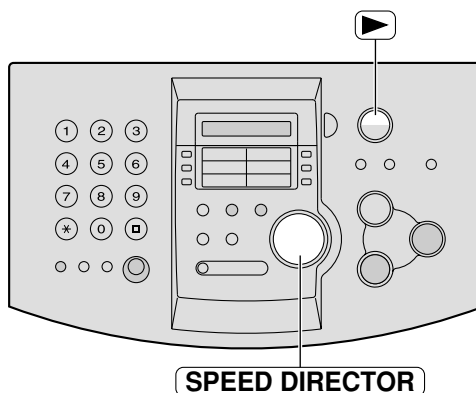

Display order of characters

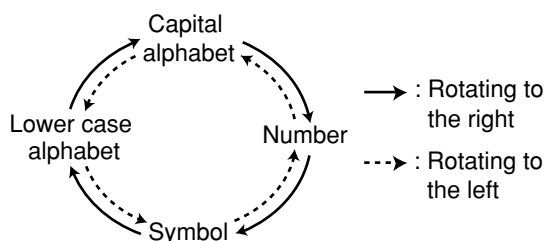

Setup

Setting your facsimile telephone number

1 Press **MENU**.
Display:

2 Press **▣**, then **0 3**.

3 Press **SET**.

4 Enter your facsimile telephone number, up to 20 digits, using the dial keypad.
Example:

5 Press **SET**.

6 Press **MENU**.

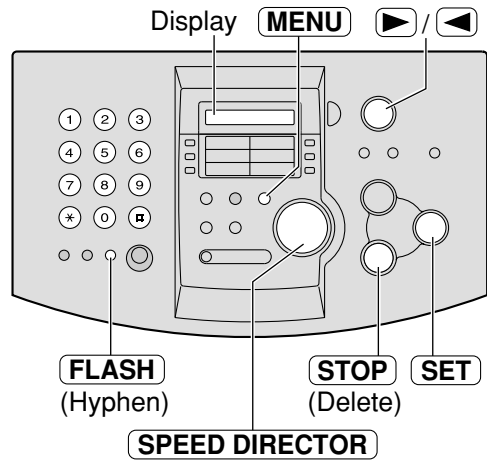

Note:

- You can enter your facsimile telephone number by rotating **SPEED DIRECTOR**. If you use **SPEED DIRECTOR**, press **▶** to move the cursor.
- The ***** button replaces the digit with a "+" and the **▣** button replaces it with a space.
Example (using the dial keypad): +234 5678
Press *** 2 3 4 ▣ 5 6 7 8**.
- To enter a hyphen in a telephone number, press **FLASH** (Hyphen).

To correct a mistake

- Press **▶** or **◀** to move the cursor to the incorrect number, and make the correction.



To delete a number

- Move the cursor to the number you want to delete and press **STOP**.

Adjusting volumes

Ringer volume

4 levels (high/middle/low/off) are available.

While the unit is idle, press  or .

• If any documents are in the document entrance, you cannot adjust the ringer volume. Confirm that there are no documents in the entrance.

■ To turn the ringer off:

1. Press  repeatedly until the following message is displayed.

Display:

RINGER OFF= OK?



YES : SET / NO : STOP

2. Press **SET**.

• To turn the ringer back on, press .

■ While the ringer volume is set to off:

The display will show the following message.

RINGER OFF

When a call is received, the unit will not ring and will display the following.

INCOMING CALL

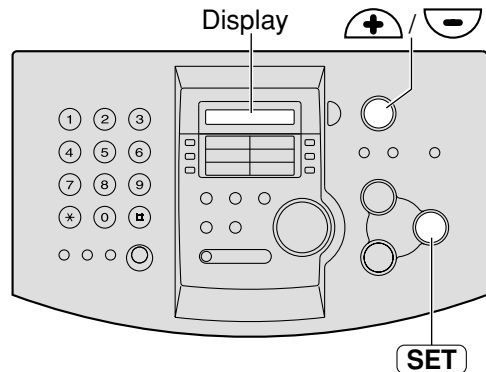



Melody ringer

- You can select one of the four melodies instead of the bell. Change the setting (feature #17 on page 54). The melody you selected will sound when the unit receives a call.



Handset receiver volume

5 levels (high to low) are available.

While using the handset, press  or .

Monitor volume

8 levels (high to low) are available.

While using the monitor, press  or .

Automatic Dialing

Storing names and telephone numbers in ONE-TOUCH DIAL

For rapid access to frequently dialed numbers, the unit provides 10 stations of ONE-TOUCH DIAL keys.

- ONE-TOUCH DIAL 1 to 3 can be alternatively used as broadcast keys (p. 36).

1 Press **DIRECTORY PROGRAM** .

Display:
↑

2 For ONE-TOUCH DIAL 1–3:
Press one of the ONE-TOUCH DIAL keys.

Press **SET** to go to the next prompt.

For ONE-TOUCH DIAL 4–5:
Press one of the ONE-TOUCH DIAL keys.

For ONE-TOUCH DIAL 6–10:
Press **LOWER**, then press one of the ONE-TOUCH DIAL keys.

3 Enter the name, up to 10 characters (see page 19 for instructions).

Example:

4 Press **SET** .

Example:

5 Enter the telephone number, up to 30 digits, using the dial keypad.

Example:

- If you want to enter a hyphen, press **FLASH** .

6 Press **SET** .

↓

↑

- To program other stations, repeat steps 2 to 6.

7 Press **STOP** to exit the program.

- If you press **DIRECTORY PROGRAM** instead of **STOP**, you can print the one-touch label card (see right).

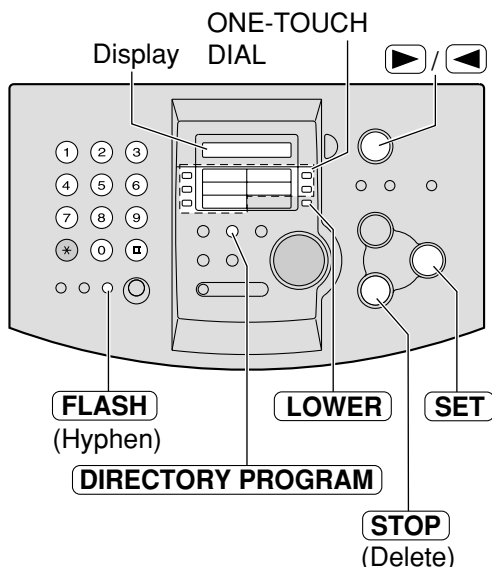

Helpful hint:

- You can confirm the stored items on the display (p. 26) or on the telephone number list (p. 75).

Note:

- A hyphen or a space entered in a telephone number counts as two digits.

To correct a mistake

- Press **▶** or **◀** to move the cursor to the incorrect character/number, and make the correction.

To delete a character/number

- Move the cursor to the character/number you want to delete, and press **STOP** .

To print the one-touch label card with stored names

Press **DIRECTORY PROGRAM** in step 7.

Display:
↓

Press **SET** to start printing.

- Put the card in the ONE-TOUCH DIAL location.

Storing names and telephone numbers in SPEED DIRECTOR

For rapid access to frequently dialed numbers, the unit provides a SPEED DIRECTOR directory (100 stations).

1 Press **DIRECTORY PROGRAM** .
Display:
↓

2 Rotate **SPEED DIRECTOR** until the following is displayed.

3 Enter the name, up to 10 characters (see page 19 for instructions).
Example:

4 Press **SET** .

5 Enter the telephone number, up to 30 digits, using the dial keypad.
Example:

•If you want to enter a hyphen, press **FLASH** .

6 Press **SET** .

↓

•To program other items, repeat steps 3 to 6.

7 Press **DIRECTORY PROGRAM** to exit the program.

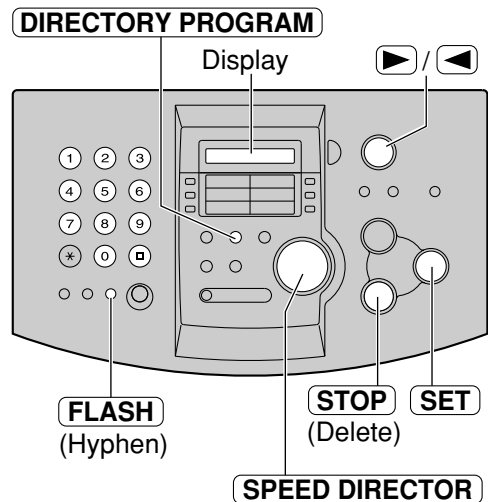

Helpful hint:

- You can confirm the stored items on the display (p. 26) or on the telephone number list (p. 75).

Note:

- When the following message is displayed in step 6, you can store only 5 more items.

Display:

- If there is no space to store new stations, the following message is displayed in step 1.

Erase unnecessary stations (p. 25).

- A hyphen or a space entered in a telephone number counts as two digits.

To correct a mistake

- Press **▶** or **◀** to move the cursor to the incorrect character/number, and make the correction.

To delete a character/number

- Move the cursor to the character/number you want to delete, and press **STOP** .

Automatic Dialing

Editing and erasing a stored name and number ==

Editing a stored name and number

You can edit a name or number stored in ONE-TOUCH DIAL and SPEED DIRECTOR.

- 1** Rotate **SPEED DIRECTOR** until the desired name is displayed.

Example:

Mary	<S01>
------	-------

means the station number
for ONE-TOUCH DIAL

- 2** Press **DIRECTORY PROGRAM**.

EDIT=* DELETE=#

- 3** Press ***** to select "EDIT".

NAME=Mary

- If you do not need to edit the name, skip to step 5.

- 4** Edit the name (see page 19 for instructions).

- 5** Press **SET**.

Example:

<S01>=0123456

- If you do not need to edit the telephone number, skip to step 7.

- 6** Edit the telephone number. For further details, see page 23.

- 7** Press **SET**.

REGISTERED

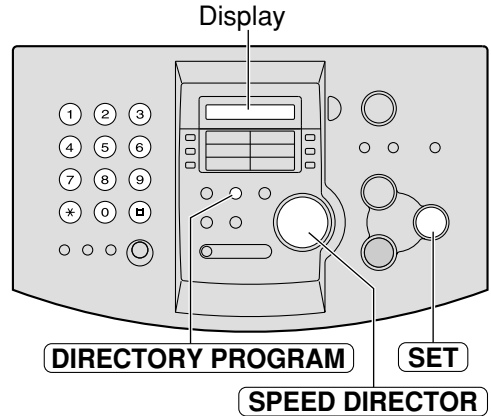

Erasing a stored station and item

You can erase ONE-TOUCH DIAL station and SPEED DIRECTOR item.

- 1** Rotate **SPEED DIRECTOR** until the desired name is displayed.

Example:

Mary	<S01>
------	-------

- 2** Press **DIRECTORY PROGRAM** .

EDIT=* DELETE=#

- 3** Press **[#]** to select "DELETE".

DELETE OK?



YES : SET/NO : STOP

- To cancel erasing, press **STOP** .

- 4** Press **SET** .

DELETED

- The stored name and number are deleted.

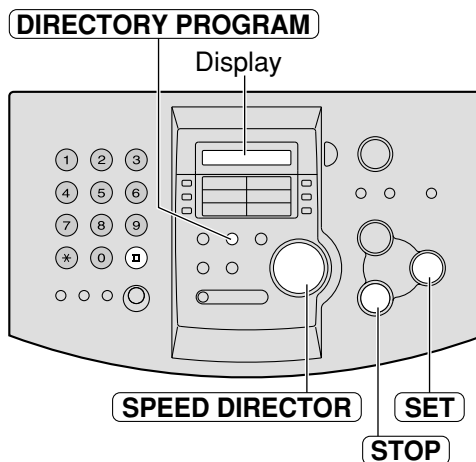

Automatic Dialing

Making a voice call using ONE-TOUCH DIAL and SPEED DIRECTOR

Before using this feature, program the desired names and telephone numbers into ONE-TOUCH DIAL and SPEED DIRECTOR (p. 22, 23).

Using ONE-TOUCH DIAL

- 1** Press **MONITOR** or lift the handset.

Display:

- Confirm that there are no documents in the document entrance.

- 2** For ONE-TOUCH DIAL 1–5:
Press the desired ONE-TOUCH DIAL key.

For ONE-TOUCH DIAL 6–10:
Press **LOWER**, then press the desired ONE-TOUCH DIAL key.

Example:

- The unit will start dialing automatically.

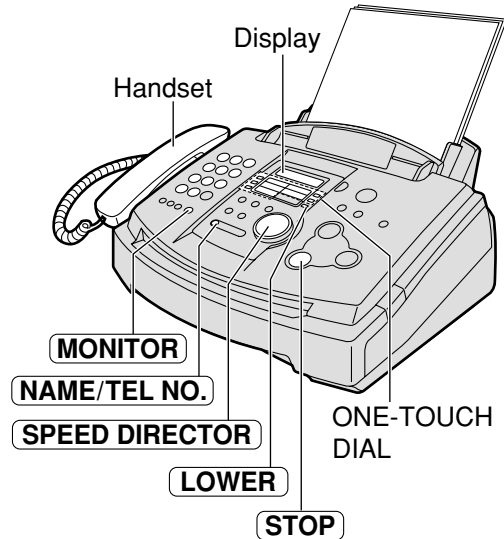

Using SPEED DIRECTOR

- 1** Rotate **SPEED DIRECTOR** until the desired name is displayed.

Example:

- If the desired name has not been stored, press **STOP** and dial the number manually.

- 2** Press **MONITOR** or lift the handset.
• The unit will start dialing automatically.

To confirm the stored telephone number on the display

1. Rotate **SPEED DIRECTOR** until the desired name is displayed.

Example:

means the station number for ONE-TOUCH DIAL

2. Press **NAME/TEL NO.**.

- To stop the confirmation, press **STOP**.
- To make a call, press **MONITOR** or lift the handset.

To search for a name by initial

Example: "Lisa"

1. Rotate **SPEED DIRECTOR** until any name is displayed.

Example:

2. Press **5** repeatedly until any name with the initial "L" is displayed (see the character table on page 19).

3. Rotate **SPEED DIRECTOR** to the right until "Lisa" is displayed.

- To stop the search, press **STOP**.
- To make a call, press **MONITOR** or lift the handset.

Note:

- When you want to search for symbols (not letters or numbers), press ***** in step 2.

Call Display service from your phone company ==

This unit is compatible with the Call Display service offered by your local telephone company. To use this feature, you must subscribe to the Call Display service.

Set the following ring count settings to 2 or more rings beforehand.

- FAX ring count (feature #06 on page 53)
- TEL/FAX ring count (feature #78 on page 59)

How Caller information is displayed

The calling party's name or telephone number will be displayed after the first ring. You then have the option of whether or not to answer the call depending on the caller.

Example:

Chris Horner

The unit will automatically store the caller information (name, telephone number and the time of the call). You can view the caller information (see the next page) and print the Caller's list (p. 29).

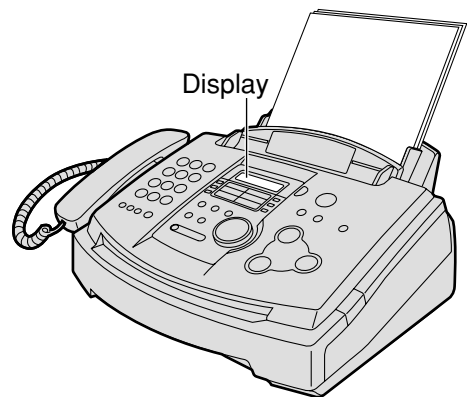

Note:

- If the unit is connected to a PBX (Private Branch Exchange) system, you may not receive the caller information. Consult your PBX supplier.
- If the unit cannot receive caller information, the unit will show the following.

UNAVAIL NAME & NO

The caller dialed from an area which does not provide Call Display service.

PRIVATE CALLER

The caller requested not to send caller information.

LONG DISTANCE

The caller made a long distance call.

Call Display

Viewing and calling back using caller information

You can easily view caller information and call back.

Important:

- Calling back will not be available in the following cases.
 - The telephone number includes data other than numbers (i.e. * or #).
 - The caller information does not include a telephone number.

1 Press **CALL DISPLAY SEARCH**.

Example (2 new calls are received):

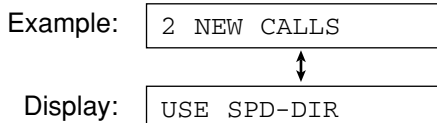

2 Rotate **SPEED DIRECTOR** to the right (clockwise).

- The display will show the most recent caller's name.
- If you rotate to the left, the display will show the reviewed calls.
- To stop viewing, press **STOP**.

3 Press **MONITOR** or lift the handset to make a call.

- The unit will start dialing automatically.
- To send a fax – insert the document FACE DOWN and press **FAX START**.

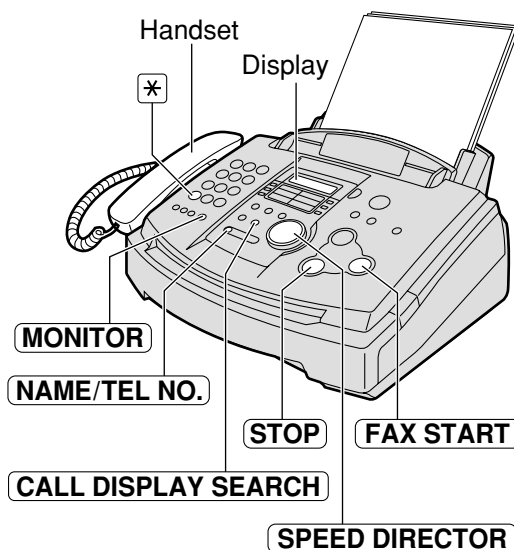

To display the caller's telephone number and the date/time of the call

Press **NAME/TEL NO.** repeatedly in step 2.

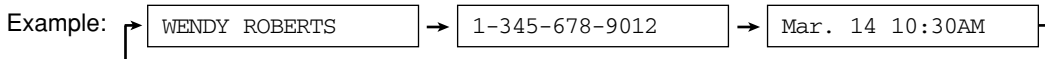

To edit the telephone number for calling back

Press ***** repeatedly in step 2.

Each time you press *****, the telephone number will be changed as follows.

1. – – ("1" added)
2. (area code omitted)
3. –
4. – ("1" added and area code omitted)

- You can change the area code if it is wrong by pressing the correct number using the dial keypad.

Display while viewing

<input type="text" value="NO NAME RCVD"/>	When the unit could not receive a name.
<input type="text" value="END OF NEW CALL"/>	After the last new call has been displayed.
<input type="text" value="END"/>	After all calls have been displayed.
<input type="text" value="NO CALLER DATA"/>	When no calls have been received.

Confirming caller information using the Caller's list

The unit will store information for the most recent 30 callers.

—To print manually, see below.

—To print automatically after every 30 new calls, activate feature #26 (p. 56).

Sample of a Caller's list

CALLER'S LIST / LISTE DES DEMANDEURS						Mar. 20 2001 09:19AM
YOUR LOGO / VOTRE LOGOTYPE :						
YOUR FAX NO. / VOTRE NUMÉRO DE FAX :						
NO.	NAME	TELEPHONE NUMBER	TIME OF CALL	ANSWER	STATUS	
NO	NOM	NUMÉRO TÉLÉPHONE	HEURE DES APPELS	PRISE	ÉTAT	
01	WENDY ROBERTS	1-345-678-9012	Mar. 14 10:30AM	FAX	!	
02	ALLAN STONE	1-456-789-0123	Mar. 13 08:35AM	FAX	*	
03	MIKE TIMAR	1-987-654-3210	Mar. 11 09:35AM	TEL		

- If you select "FRENCH" for the language (feature #48 on page 57), the time is shown using a 24 hour clock (military time).

Printing and erasing the Caller's list

- 1 Press **CALL DISPLAY PRINT** to start printing.

Display: PRINTING

- The display will show the following after printing.

ALL ERASE OK?
↑↓
YES:SET/NO:STOP

- 2 Press **STOP** to exit the program, or press **SET** to erase all of the stored caller information.

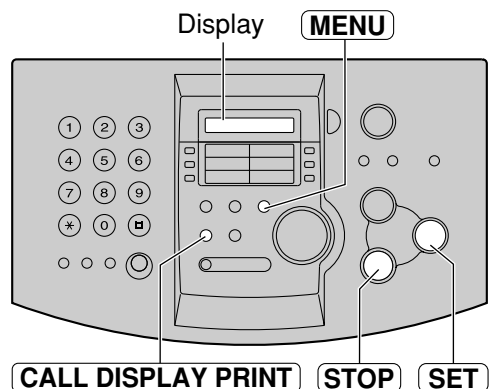

To erase caller information without printing

1. Press **MENU** three times.

Display: CALLER SET UP

4. Press **SET**.

ERASE COMPLETED

2. Press **SET**.

CALL LIST ERASE

5. Press **STOP** to exit the program.

3. Press **SET**.

ALL ERASE OK?

- To cancel erasing, press **STOP**, then **MENU**.

Call Display

Storing caller information in ONE-TOUCH DIAL and SPEED DIRECTOR

Important:

- This feature is not available in the following cases.
 - The telephone number includes data other than numbers (i.e. * or #).
 - The caller information does not include a telephone number.

1 Press **CALL DISPLAY SEARCH**.

Example: 2 NEW CALLS



Display: USE SPD-DIR

2 Rotate **SPEED DIRECTOR** until the name you want to store is displayed.

Example: WENDY ROBERTS

3 Press **DIRECTORY PROGRAM**.

PRESS STATION



OR USE SPD-DIR

4 For **ONE-TOUCH DIAL 1-3**:
Press the desired ONE-TOUCH DIAL key.

DIAL MODE 1 2

Press **SET**.

Example: NAME=WENDY ROBE

Press **SET**.

Example: <S02>=1345678901

For **ONE-TOUCH DIAL 4-5**:
Press the desired ONE-TOUCH DIAL key.

NAME=WENDY ROBE

Press **SET**.

<S04>=1345678901

For **ONE-TOUCH DIAL 6-10**:
Press **LOWER**, then press the desired ONE-TOUCH DIAL key.

NAME=WENDY ROBE

Press **SET**.

<S06>=1345678901

For **SPEED DIRECTOR**:

Rotate **SPEED DIRECTOR**.

NAME=WENDY ROBE

Press **SET**.

NO.=1345678901

5 Press **SET**.

REGISTERED

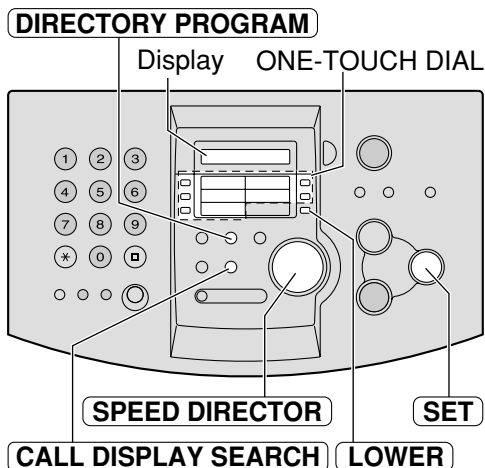

Note:

- You can confirm the stored items on the display (p. 26) or on the telephone number list (p. 75).
- You can only store a name of up to 10 characters long.
- To edit a name and number, see page 24.
- If you enter a new item into ONE-TOUCH DIAL, the previous entry will be overwritten.
- If you use ONE-TOUCH DIAL 1-3 as a broadcast station, you cannot store caller information.
- If the SPEED DIRECTOR directory is full, you cannot store caller information.

Talking to the other party after fax transmission or reception

You can talk to the other party after a fax message is completed. This will save the added expense and time of making another call.

This feature only works when the other party's fax machine is equipped with a voice contact feature.

Initiating voice contact

- 1 Press **MONITOR** while transmitting or receiving documents.

Display: VOICE STANDBY

- Your unit will call the other party with a distinctive ring.
- When the other party answers, your unit will emit a distinctive ring.

- 2 Lift the handset to start talking.

Note:

- If you initiate voice contact during transmission, the unit will call you with a distinctive ring after all of the documents have been transmitted.
- If you initiate voice contact during reception, the unit will call you with a distinctive ring after the current page of the document has been received.

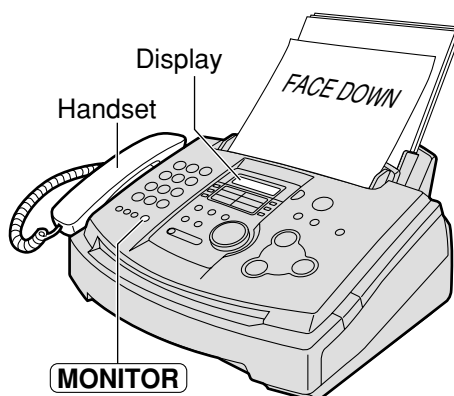

Receiving a request for voice contact

- 1 If the other party initiates voice contact, your unit will sound a distinctive ring and the following will be displayed.

PLEASE PICK UP

- 2 Lift the handset within 10 seconds of the distinctive ring to start talking.

Note:

- If you do not answer within 10 seconds of the distinctive ring, the line will be disconnected.

Sending Faxes

Sending a fax manually

- 1 Adjust the width of the document guides to the size of the document.
- 2 Insert the document (up to 15 pages) **FACE DOWN** until the unit grabs the document and a single beep is heard.

Display:

- 3 If necessary, press **RESOLUTION** repeatedly to select the desired setting (see below).

- 4 Press **MONITOR** or lift the handset.

- 5 Dial the fax number.

Example:

- 6 **When the fax tone is heard:**
Press **FAX START**, and replace the handset if you are using it.

OR

When the other party answers your call:

Using the handset, ask them to press their start button. When the fax tone is heard, press **FAX START** and replace the handset.

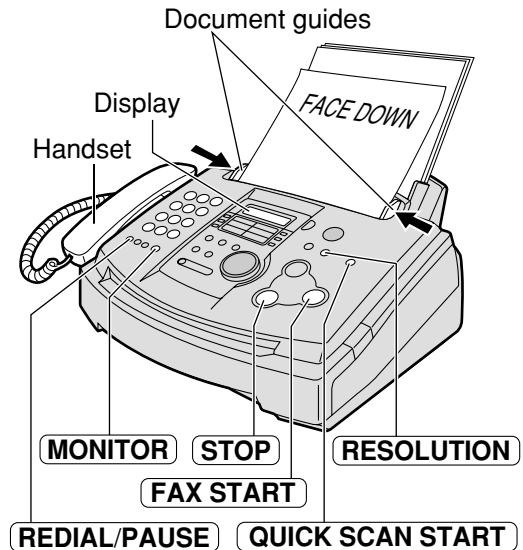

To select the resolution

Select the desired resolution according to the type of document.

STANDARD: For printed or typewritten originals with normal-sized characters.

FINE: For originals with small printing.

SUPER FINE: For originals with minute printing.

PHOTO: For originals containing photograph.

PHOTO WITH TEXT: For originals containing photograph and text.

- Using the "FINE", "SUPER FINE", "PHOTO" or "PHOTO WITH TEXT" setting will increase transmission time.
- If the resolution setting is changed during feeding, it will be effective from the next sheet.
- The "SUPER FINE" resolution only works with other compatible fax machines.

To stop transmission

Press **STOP**.

To redial the last number

Press **REDIAL/PAUSE**.

- If the line is busy, the unit will automatically redial the number up to 2 times.
- During redial, the following will be displayed.

Display:

- To cancel redialing, press **STOP**.

Convenient way to send a fax

You can dial the fax number first before inserting the document. This is convenient if the other party's number is indicated on the document.

1. Enter the fax number.
 - The handset must be on the cradle.
2. Insert the document.
3. Press **FAX START**.

Sending from memory

You can press **QUICK SCAN START** instead of **FAX START** to scan the document into memory before sending. After storing, the unit will transmit the document.

- If the document exceeds the memory capacity (p. 78), sending will be cancelled.

Sending a fax using ONE-TOUCH DIAL and SPEED DIRECTOR

Before using this feature, program the desired names and telephone numbers into ONE-TOUCH DIAL and SPEED DIRECTOR (p. 22, 23).

- 1 Adjust the width of the document guides to the size of the document.
- 2 Insert the document (up to 15 pages) FACE DOWN until the unit grabs the document and a single beep is heard.

Display:

- 3 If necessary, press **RESOLUTION** repeatedly to select the desired setting (p. 32).
- 4 Enter the fax number.
Using ONE-TOUCH DIAL 1–5:
Press the desired ONE-TOUCH DIAL key.
Using ONE-TOUCH DIAL 6–10:
Press **LOWER**, then press the desired ONE-TOUCH DIAL key.

Using SPEED DIRECTOR:
Display the desired name and press **FAX START**.

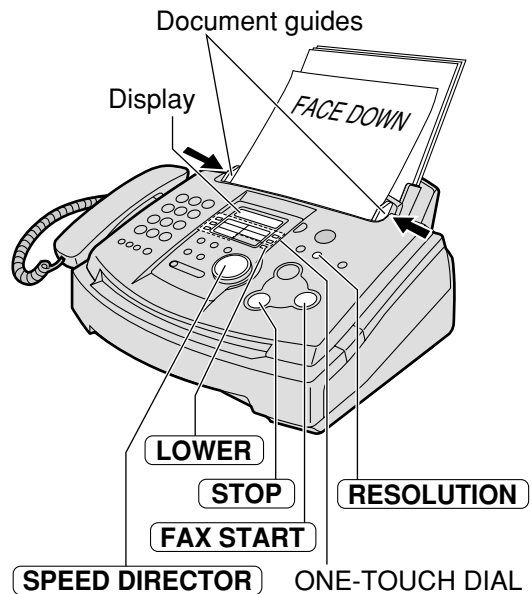

Fax auto redial

If the line is busy or if there is no answer, the unit will automatically redial the number up to 2 times.

- This feature is also available for delayed transmission (feature #25 on page 55).
- During redial, the following will be displayed.

Display:

- To cancel redialing, press **STOP**.

If your unit does not send a fax

- Confirm the stored telephone number on the display and check that the number dialed is answered by the other party's machine (p. 26).
- The connecting tone will be heard during dialing to tell you the status of the other party's machine (feature #76 on page 58).

Sending Faxes

Documents you can send

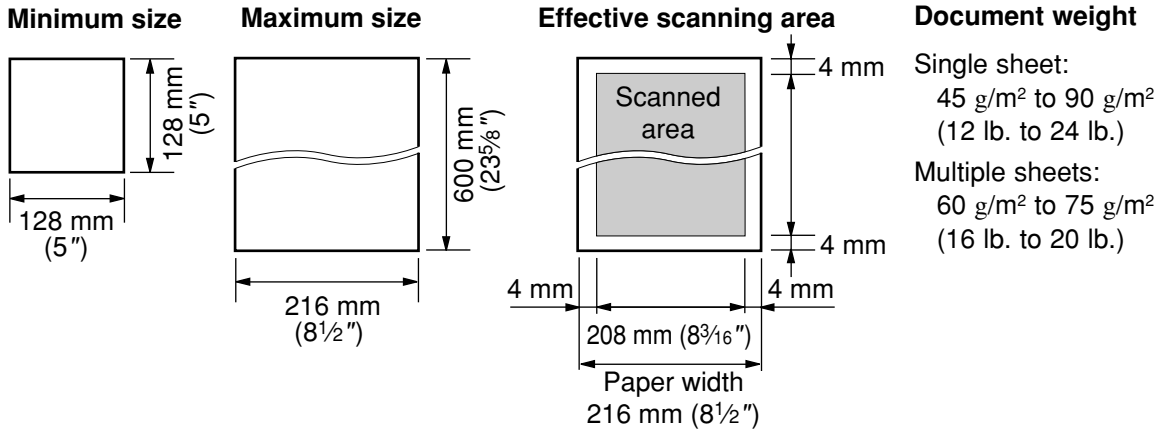

Note:

- Remove clips, staples or other similar fasteners.
- Check that ink, paste or correction fluid has dried.
- Do not send the following types of documents. Use copies for fax transmission.
 - Chemically treated paper such as carbon or carbonless duplicating paper
 - Electrostatically charged paper
 - Heavily curled, creased or torn paper
 - Paper with a coated surface
 - Paper with a faint image
 - Paper with printing on the opposite side that can be seen through the front (e.g. newspaper)

To transmit more than 15 pages at a time

- Insert the first 15 pages of the document. Add the extra pages (up to 15) before the last page is fed into the unit.

Reports for confirmation

To confirm the communication results, the following reports are available.

Sending report

This report will provide you with a printed record of transmission results. To use this feature, activate feature #04 (p. 53).

Sample of a sending report

SENDING REPORT / RELEVÉ D'ENVOI		Mar. 20 2001 09:19AM					
YOUR LOGO / VOTRE LOGOTYPE :							
YOUR FAX NO. / VOTRE NUMÉRO DE FAX :							
NO.	OTHER FACSIMILE	START TIME	USAGE TIME	MODE	PAGES	RESULT	*CODE
NO	CORRESPONDANT	HEURE DÉBUT	DURÉE	MODE	PAGES	RÉSULTAT	
01	2345678	Mar.20 09:18AM	00'51	SND	00	COMMUNICATION ERROR	43

Communication message (p. 60) Error code message (p. 60)

Note:

- If you select "FRENCH" for the language (feature #48 on page 57), the time is shown using a 24 hour clock (military time).

Journal report

The unit stores the 30 most recent fax communication results. When a new communication occurs, the oldest communication result will be erased.

—To print manually, see page 75.

—To print automatically after every 30 new fax communications, activate feature #22 (p. 55).

Sample of a journal report

JOURNAL / REGISTRE DES COMMUNICATIONS		Mar. 25 2001 11:22AM					
YOUR LOGO / VOTRE LOGOTYPE :							
YOUR FAX NO. / VOTRE NUMÉRO DE FAX :							
NO.	OTHER FACSIMILE	START TIME	USAGE TIME	MODE	PAGES	RESULT	*CODE
NO	CORRESPONDANT	HEURE DÉBUT	DURÉE	MODE	PAGES	RÉSULTAT	
01	3332222	Mar.21 07:14AM	00'45	SND	01	OK	
02	9998765	Mar.21 08:17AM	00'58	RCV	02	OK	
03	John	Mar.21 09:18AM	00'48	RCV	01	OK	
04	555556677	Mar.22 10:35AM	02'45	SND	03	COMMUNICATION ERROR	43
05			02'50	SND	05	OK	
06				RCV	03	OK	

Communication message (p. 60) Error code message (p. 60)

Note:

- If you select "FRENCH" for the language (feature #48 on page 57), the time is shown using a 24 hour clock (military time).

Sending Faxes

Broadcast transmission

This feature is useful for sending the same document often to selected parties (up to 20 stations). First program the stations, then see page 39 for transmission.

- The broadcast function utilizes ONE-TOUCH DIAL 1–3. The one-touch dial function will be cancelled.
- BROADCAST key 1 and 2 can accept ONE-TOUCH DIAL and SPEED DIRECTOR entries.
MANUAL BROADCAST key can also accept manual dialing entries.

Programming the stations

1 Press **DIRECTORY PROGRAM**.

Display:

↑↓

2 For **BROADCAST 1–2**:
Press the desired **BROADCAST** key.

Rotate **SPEED DIRECTOR** to select "BROADCAST".
Example:

For **MANUAL BROADCAST**:
Press **MANUAL BROAD**.

Rotate **SPEED DIRECTOR** to select "MANUAL BROAD".

3 Press **SET**.

4 Enter stations.
Using **ONE-TOUCH DIAL 1–5**:
Press the desired ONE-TOUCH DIAL key.
Example:

Using **ONE-TOUCH DIAL 6–10**:
Press **LOWER**, then press the desired ONE-TOUCH DIAL key.
Example:

Using **SPEED DIRECTOR**:
Display the desired name and press **SET**.
Example:
↓

Using the dial keypad (only for MANUAL BROAD):
Enter the fax number and press **SET**.

Example:
↓

- To enter other stations, repeat this step (up to 20 stations).

5 Press **SET** after programming all of the desired stations.

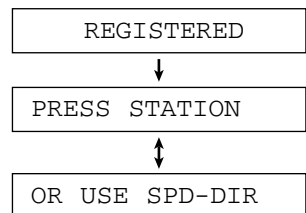

- To program another broadcast key, repeat steps 2 to 5.

6 Press **STOP** to exit the program.

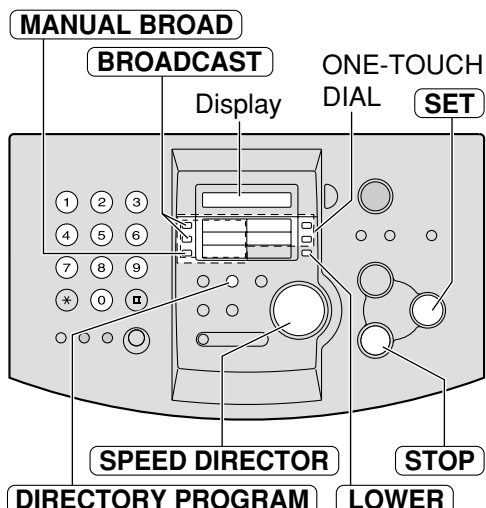

Note:

- If you enter the wrong station, press **STOP** after step 4 to erase the station.
- Confirm the stored items by printing a broadcast programming list (p. 75).

Adding a new station

- 1** Rotate **SPEED DIRECTOR** until the desired key name is displayed.

Example:

- 2** Press **DIRECTORY PROGRAM** .

- 3** Press ***** to select "ADD".

- 4** Rotate **SPEED DIRECTOR** until the desired name you want to add is displayed (only using SPEED DIRECTOR is available).

Example
(SPEED DIRECTOR):

Example
(ONE-TOUCH DIAL-2):

- 5** Press **SET** .



Example:

- To add other stations, repeat steps 4 and 5 (up to 20 stations).

- 6** Press **DIRECTORY PROGRAM** to exit the program.

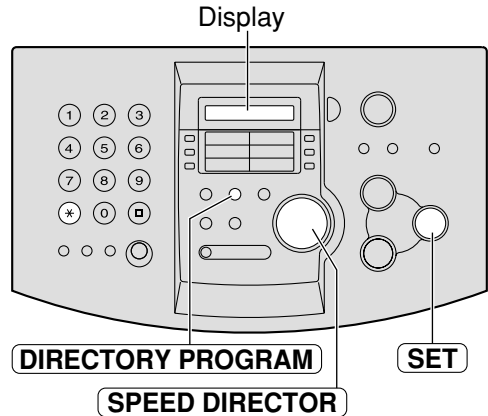

Sending Faxes

Erasing a stored station

- 1** Rotate **SPEED DIRECTOR** until the desired key name is displayed.

Example:

- 2** Press **DIRECTORY PROGRAM** .

- 3** Press **#** to select "DELETE".

- 4** Rotate **SPEED DIRECTOR** until the desired station you want to erase is displayed.

Example
(SPEED DIRECTOR):

Example
(ONE-TOUCH DIAL-3):

- To cancel erasing, press **STOP** .

- 5** Press **SET** .



- 6** Press **SET** .



Example:

- To delete other stations, repeat steps 4 to 6.

- 7** Press **DIRECTORY PROGRAM** to exit the program.

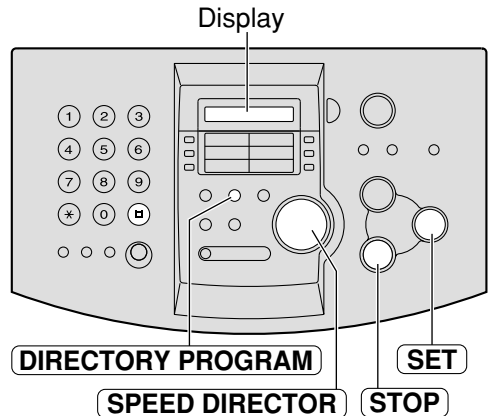

Sending the same document to pre-programmed parties

- 1** Insert the document **FACE DOWN**.
 - If necessary, press **RESOLUTION** repeatedly to select the desired setting (p. 32).
- 2** Press the desired **BROADCAST** (1–2) or **MANUAL BROAD**.
 - You can also use **SPEED DIRECTOR**. Display the desired key name, and press **FAX START**.

Example: <BROADCAST1>

- The document will be fed into the unit and scanned into memory. The unit will then transmit the data to each station, calling each number sequentially.
- After transmission, the stored document will be erased automatically, and the unit will automatically print a broadcast sending report (see below).

Note:

- If one of the stations is busy or does not answer, the station will be skipped. All skipped stations will be redialed up to 2 times after all of the other stations have been called.

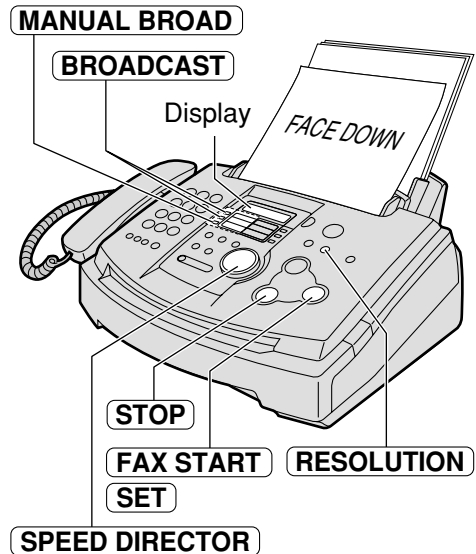

To cancel the broadcast setting

1. Press **STOP** while the unit displays the following message.

Display: BROADCASTING

- The display will show the following.

SEND CANCELLED?



YES: SET/NO: STOP

2. Press **SET**.

Sample of a broadcast sending report

BROADCAST REPORT 1 / RAPPORT D'ENVOI MULTIPOSTES 1					
					Mar. 10 2001 09:36AM
			YOUR LOGO / VOTRE LOGOTYPE :		
			YOUR FAX NO. / VOTRE NUMÉRO DE FAX :		
NO.	OTHER FACSIMILE NO CORRESPONDANT	START TIME HEURE DÉBUT	USAGE TIME DURÉE	PAGES PAGES	RESULT RÉSULTAT
01	Mike	Mar.10 09:31AM	01'10	02	OK
02	Peter	Mar.10 09:33AM	01'08	02	OK
03	Sam	Mar.10 09:34AM	01'09	02	OK
04	Kim	Mar.10 09:35AM	01'10	02	OK
TOTAL			004'37	008	

Note:

- If you select "FRENCH" for the language (feature #48 on page 57), the time is shown using a 24 hour clock (military time).

Receiving Faxes

Setting the unit to receive faxes

Use only as a fax

With answering machine

How you want the unit to receive calls

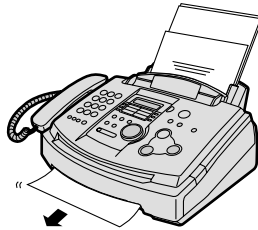

You have a separate telephone line just for faxes.

External telephone answering machine (not included)

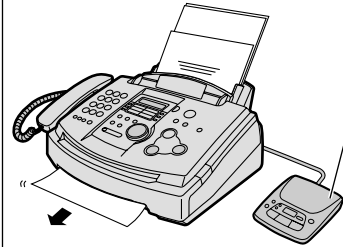

You want to use the fax machine with an answering machine.

You have to set this.

FAX ONLY mode (p. 43)

Turn AUTO ANSWER on by pressing **AUTO ANSWER**.

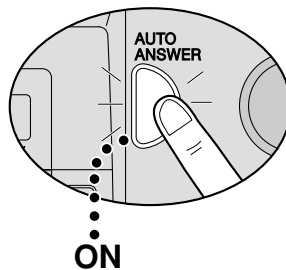

Activating an answering machine (p. 44)

Connect an external telephone answering machine and set the ring count of the answering machine to less than 4.

- Set the ring count in FAX ONLY mode of the fax machine to "5 EXT.TAM", if you use with AUTO ANSWER on.

This is how the unit will operate.

When receiving calls:
All incoming calls will be answered as faxes.

When receiving voice calls:
The answering machine will record voice messages.

When receiving fax calls:
The fax machine will disconnect the answering machine and receive documents.

Voice mail service (Distinctive Ring)

2-number example

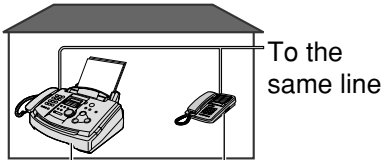

Facsimile No. (555-1333) Telephone No. (555-1111)

You need to subscribe to Distinctive Ring Service.

Mostly voice calls

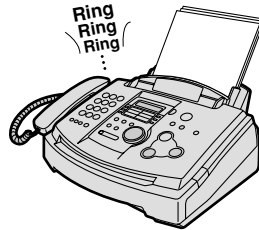

You plan to answer the calls yourself.

Other options

With a PC

If you have a computer attached to the same telephone line, see page 48.

TEL/FAX mode

If you are near the unit and want to use it to receive voice calls yourself and fax calls automatically, see pages 46 and 47.

Remote fax activation

You can also receive a fax using an extension telephone. While hearing a fax calling tone with an extension telephone, press ***9** (pre-selected fax activation code) to receive a fax (p. 48).

Setting the Distinctive Ring pattern (feature #31 on page 56)

Select the same ring pattern assigned to the facsimile number.

- A: Standard ring (one long ring)
- B: Double ring (two short rings)
- C: Triple ring (short-long-short rings)
- D: Other triple ring (short-short-long rings)

TEL mode (p. 42)

Turn AUTO ANSWER off by pressing **AUTO ANSWER**.

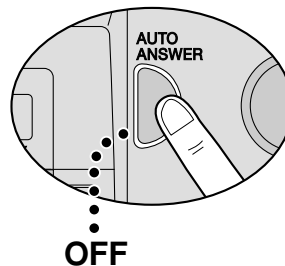

When the fax machine detects a call matching the selected Distinctive Ring pattern: The fax machine will activate the fax function.

When the fax machine detects other ring patterns: The fax machine will operate based on the AUTO ANSWER setting.

When receiving calls:

You have to answer all calls manually.

To receive a fax document, press **FAX START** for each fax call.

Receiving Faxes

TEL mode (answering all calls manually)

Activating TEL mode

If the AUTO ANSWER light is on, turn it off by pressing **AUTO ANSWER**.

Display: TEL MODE

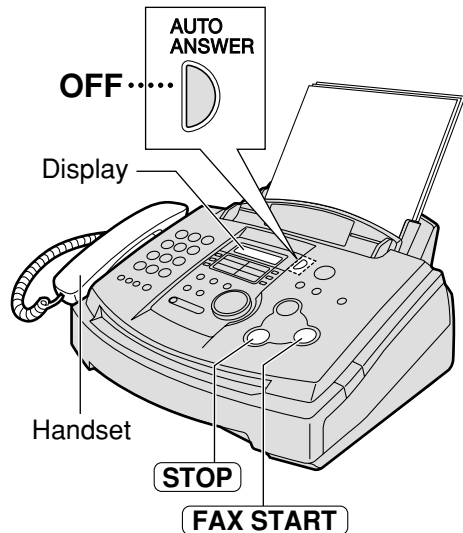

Receiving a fax manually

- 1 When the unit rings, lift the handset to answer the call.
- 2 When:
 - document reception is required,
 - a fax calling tone (slow beep) is heard, or
 - no sound is heard,press **FAX START**.

CONNECTING.....

- 3 Replace the handset.
 - The unit will start fax reception.

Note:

- If you do not answer the call within 10 rings, the unit will temporarily switch to fax reception and the caller can send a document.

To stop receiving

Press **STOP**.

Friendly reception feature

When you answer a call and hear a fax calling tone (slow beep), the unit will automatically start fax reception.

- If this feature is not required, set feature #46 to off (p. 57).

Auto reduction feature

If the other party sends a document that is longer than your recording paper, your unit will reduce the receiving document to the proper size and print it. If you want to print the original size, set feature #37 to off (p. 56).

Fax reception in memory

When a printing problem is detected, the unit will temporarily store the received document into memory.

While the document is in memory:

- the display will show an error message and the following message alternately,

Display: FAX IN MEMORY

- slow beeps will sound if feature #44 is set to on (p. 57).

- Follow the instructions on pages 61 and 62 to solve the problem.
- For memory capacity, see page 78.

FAX ONLY mode (all calls are received as faxes)

Activating FAX ONLY mode

- 1 Set feature #77 to "FAX ONLY" (p. 59).
- 2 If the AUTO ANSWER light is off, turn it on by pressing **AUTO ANSWER**.
 - The display will show the number of rings before the unit answers a call in FAX ONLY mode.

Display: PICKUP & RCV FAX



Example: AFTER 3 RINGS 72

- 3 If you wish to change the ring count setting, rotate **SPEED DIRECTOR** until the desired number is displayed, and press **SET**.
 - When receiving calls, the unit will automatically answer all calls and only receive fax documents.

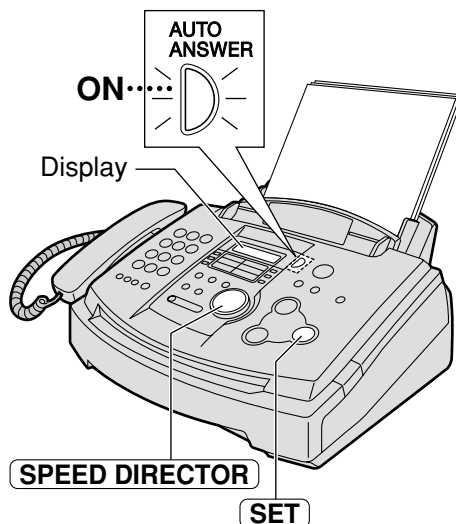

Note:

- If the AUTO ANSWER light is already on and you wish to change the ring count, turn it off once then on again by pressing **AUTO ANSWER** and follow the instructions in step 3.
- This mode should not be used with a telephone line which is used for both voice and fax calls. Fax communication will be attempted even if someone is trying to call you.

If you have a telephone line just for faxes, we recommend the following setup.

Example: One telephone line is used for voice calls and a separate telephone line for faxes.

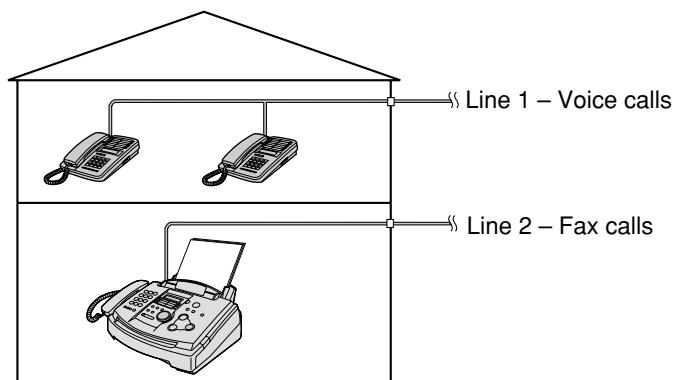

Only a fax machine is connected.

Receiving Faxes

Using the unit with an answering machine

Setting up the fax machine and an answering machine

- 1 Connect the answering machine.

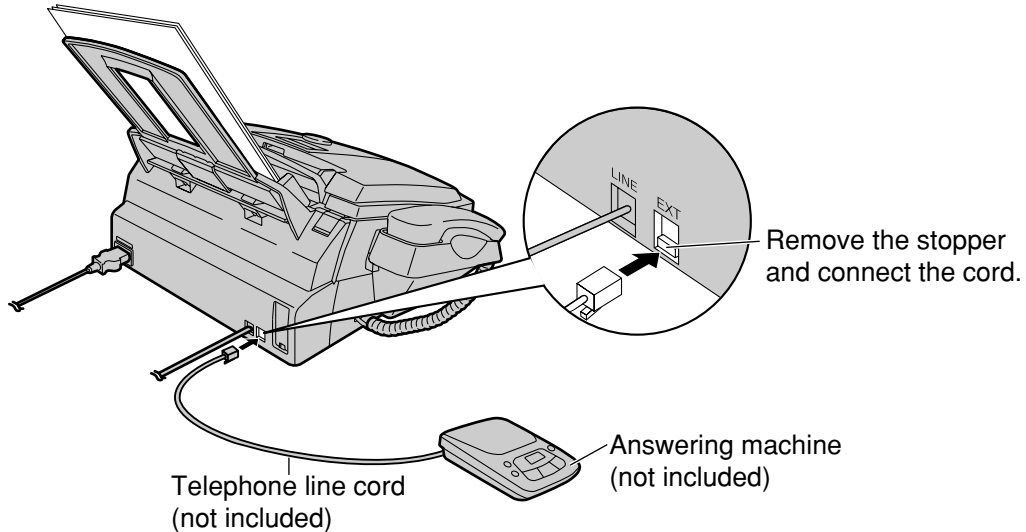

- 2 Set the number of rings on the answering machine to less than 4.
 - This will allow the answering machine to answer the call first.
- 3 Record a greeting message on the answering machine.

Example: *"This is (your name, business and/or telephone number). We are unable to answer the phone right now. To send a fax, start transmission. To leave a message, please speak after the beep. Thank you."*

 - We recommend you record your message around 10 seconds long and not to pause for more than 4 seconds during the message. Otherwise, both machines will not function correctly.
- 4 Activate the answering machine.
- 5 Set the receive mode of the fax machine to TEL mode (p. 42) or FAX ONLY mode (p. 43).
 - If you set to FAX ONLY mode, **set the ring count in FAX ONLY mode to "5 EXT.TAM" (feature #06 on page 53)**. Using FAX ONLY mode will allow you to receive faxes if the answering machine is full.
- 6 Check the remote access code of the answering machine and program the same code into the remote operation ID of the fax machine. See feature #12 on page 54.

How the fax machine and answering machine work

Receiving voice calls

The answering machine will record voice messages automatically.

Receiving fax calls

The fax machine will receive documents automatically when the machine detects a fax calling tone.

Receiving a voice message and fax document in one call

The answering machine will record the voice message first. The fax machine will then be activated by the caller's request and will receive the document.

Note:

- Every time the fax machine receives a document, a silent pause or fax tone may be recorded on the answering machine.

Receiving a voice message and fax document in one call

The caller can leave a voice message and send a fax document during the same call. Inform the caller of the following procedure beforehand.

1. The caller calls your fax machine.
 - The answering machine will answer the call.
2. The caller can leave a message after the greeting message.
3. The caller presses (pre-selected fax activation code).
 - The fax machine will activate the fax function.
4. The caller presses the start button to send a document.

Note:

- The fax activation code can be changed in feature #41 (p. 57).
- If the wrong fax activation code is entered, the caller must wait at least 5 seconds to reenter the correct code.

Receiving Faxes

TEL/FAX mode (receiving voice calls with rings and fax calls without rings when you are near the unit)

Use this mode when you are always near the fax machine, and want to receive faxes without the unit ringing. When a call is received, the fax machine will work as follows. To set TEL/FAX mode, see below.

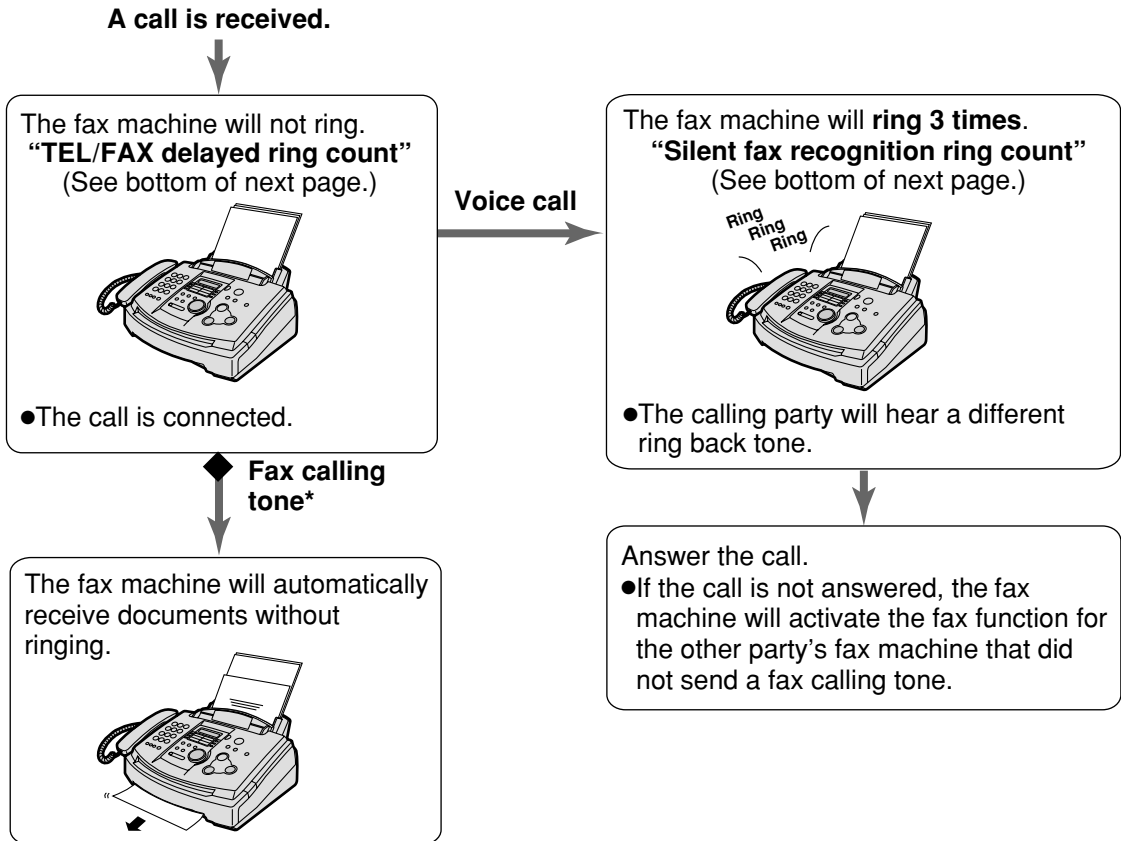

* A fax calling tone is automatically generated by the sending fax machine. Some fax machines do not have this capability.

Note:

- The fax machine will display the following when a call is received.

Display:

- The ringer should be on (p. 21).

To set TEL/FAX mode

1. Set feature #77 to "TEL/FAX" (p. 59).
2. If the AUTO ANSWER light is off, turn it on by pressing .

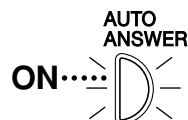

When an extension telephone is connected

A call is received.

The fax machine will not ring, but the extension telephone will **ring twice**.
“TEL/FAX delayed ring count”
(See below.)

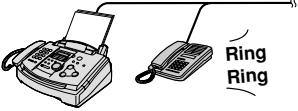

- The call is connected.

Voice call

The extension telephone will not ring, but the fax machine will **ring 3 times**.
“Silent fax recognition ring count”
(See below.)

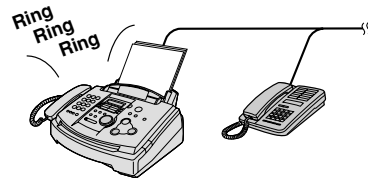

- The calling party will hear a different ring back tone.

You can answer the call with the extension telephone.**

1. Lift the handset.
2. Enter *** 0** (default code) while the ring back tone is heard.
 - The code number can be changed in feature #49 (p. 58).

The fax machine will automatically receive documents without ringing.

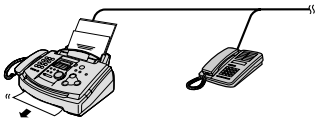

* A fax calling tone is automatically generated by the sending fax machine. Some fax machines do not have this capability.

** This feature may not function depending on the type of an extension telephone. If the fax machine activates the fax function, press **STOP** on the fax machine in step 2 to talk with the calling party.

Answer the call.

- If the call is not answered, the fax machine will activate the fax function for the other party's fax machine that did not send a fax calling tone.

TEL/FAX delayed ring count

The number of rings generated before the fax machine answers depends on the setting of feature #78 on page 59. The fax machine will not generate an audible ring during this time.

Silent fax recognition ring count

The fax machine generates audible rings to indicate that it is receiving a voice call. The number of rings generated depends on the setting of feature #30 on page 56. This signal will not ring at an extension telephone.

Receiving Faxes

Using with an answering machine and computer

We recommend that you always connect the fax machine directly to the wall jack.

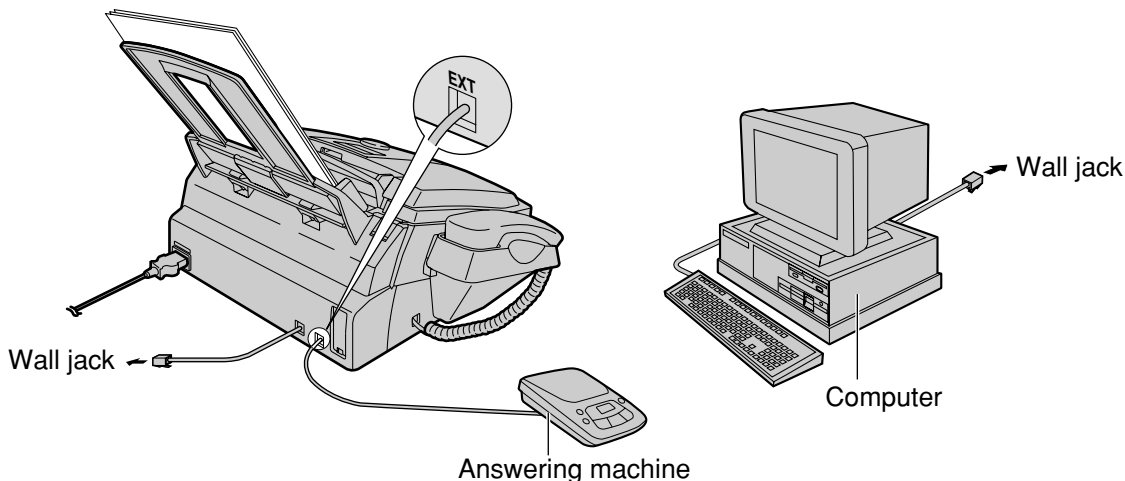

Note:

- Set the fax machine to TEL mode.
- The device which has the shortest ring count will answer a call first.
- If you use your computer as an answering machine, connect the telephone line cord from the EXT jack to the computer.

Extension telephone

If you use the fax machine with an extension telephone, you can receive fax documents using the extension telephone. You do not have to press **FAX START** on the fax machine.

Important:

- Use a touch tone telephone as the extension telephone and enter the fax activation code **firmly**.

1 When the extension telephone rings, lift the handset of the extension telephone.

2 When:
—document reception is required,
—a fax calling tone (slow beep) is heard, or
—no sound is heard,
press *** 9** (pre-selected fax activation code) **firmly**.

3 Hang up the handset.
•The fax machine will start reception.

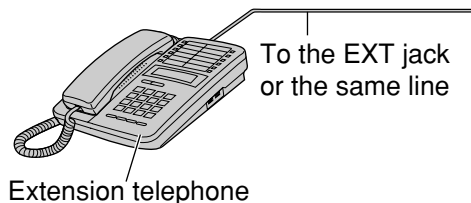

Note:

- You can change the fax activation code in feature #41 (p. 57).

Copying

Making a copy

The unit can make single or multiple copies (up to 99).

- 1 Adjust the width of the document guides to the size of the document.
- 2 Insert the document (up to 15 pages) **FACE DOWN** until the unit grabs the document and a single beep is heard.

Display:

- Make sure the handset is on the cradle.

- 3 Press **COPY START** .

- If necessary, enter the number of copies (up to 99).

- 4 Press **COPY START** .

- The unit will start copying.

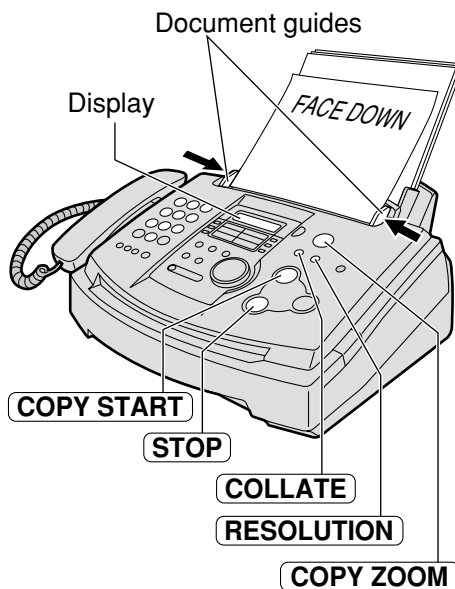

Note:

- Any transmittable document can be copied (p. 34).

To stop copying

Press **STOP** .

Convenient way to make a copy

The following settings are available before you start copying.

- Resolution
- Reduction/enlargement rate
- Collation (sort)

To select the resolution according to the type of document

Press **RESOLUTION** repeatedly to select the desired setting.

FINE: For printed or typewritten originals with small printing.

SUPER FINE: For originals with minute printing.

PHOTO: For originals containing photograph.

PHOTO WITH TEXT: For originals containing photograph and text.

- If you select "STANDARD", copying will be done using "FINE" mode.

Display while copying

Features Summary

Programming

The unit provides various programming features. Program the desired settings by referring to the programming tables (p. 53–59).

General programming method

1 Press **MENU**.

Display: SYSTEM SET UP

2 Select the feature you wish to program.

■ **For basic features** (p. 53, 54):

Rotate **SPEED DIRECTOR** until the desired feature is displayed.

■ **For advanced features** (p. 55–59):

Rotate **SPEED DIRECTOR** until the following is displayed.

ADVANCED MODE

Press **SET** and rotate

SPEED DIRECTOR until the desired feature is displayed.

3 Press **SET**.

● The current setting of the feature will be displayed.

4 Rotate **SPEED DIRECTOR** until the desired setting is displayed.

● This step may be slightly different depending on the feature.

5 Press **SET**.

● The setting you selected is set, and the next feature will be displayed.

6 To exit programming, press **MENU**.

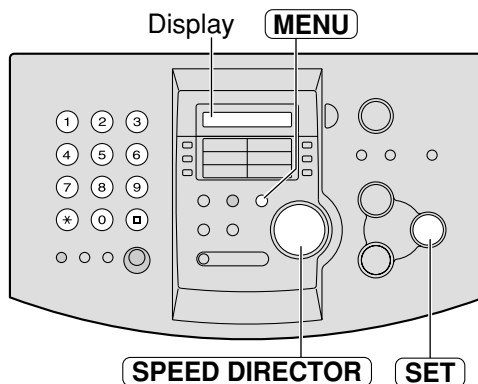

Programming by entering the program code number directly

You can select a feature by directly entering the program code (# and 2-digit number) instead of using **SPEED DIRECTOR**.

1. Press **MENU**.

2. Press **#** and the 2-digit code number.

3. Follow steps 3 to 6 above.

● See programming tables for code numbers (p. 53–59).

To cancel programming

Press **MENU** to exit the program.

Basic features

Programming table

Code	Display & Feature	Settings	How the unit operates
#01	<div style="border: 1px solid black; padding: 2px; display: inline-block;">SET DATE & TIME</div> To set the date and time.	mm/dd/yy hh:mm (2 digits for each entry)	See page 17 for details.
#02	<div style="border: 1px solid black; padding: 2px; display: inline-block;">YOUR LOGO</div> To set your logo.	(Up to 30 characters)	See page 18 for details.
#03	<div style="border: 1px solid black; padding: 2px; display: inline-block;">YOUR FAX NO.</div> To set your facsimile telephone number.	(Up to 20 digits)	See page 20 for details.
#04	<div style="border: 1px solid black; padding: 2px; display: inline-block;">SENDING REPORT</div> To print and check the sending report for fax transmission results (p. 35).	ERROR	"ERROR": The sending report will be printed only when fax transmission fails. "ON": The sending report will be printed out after every transmission.
		ON	
		OFF	
#06	<div style="border: 1px solid black; padding: 2px; display: inline-block;">FAX RING COUNT</div> To change the number of rings before the unit answers a call in FAX ONLY mode.	1, 2, 3 , 4, 5 EXT.TAM	This setting is also available after activating FAX ONLY mode (p. 43). If you are using the unit with an answering machine, set to "5 EXT.TAM" (p. 44).

(The default setting is in bold type.)

Features Summary

Basic features (cont.)

How to set menu options

1. Press **MENU** .
2. Rotate **SPEED DIRECTOR** until the desired feature is displayed.
3. Press **SET** .
4. Rotate **SPEED DIRECTOR** until the desired setting is displayed.
5. Press **SET** .
6. Press **MENU** .

Note:

- Step 4 may be slightly different depending on the feature.
- See page 52 for more details.

Programming table (cont.)

Code	Display & Feature	Settings	How the unit operates
#12	<div style="border: 1px solid black; padding: 2px; display: inline-block;">REMOTE TAM ACT.</div> If you are using the unit with an answering machine, activate this feature, and set the remote activation ID to secure the remote operation for the answering machine.	ON / ID=11	To select "ON" and enter ID: 1. Press MENU . 2. Rotate SPEED DIRECTOR and select this feature. 3. Press SET . 4. Rotate SPEED DIRECTOR to select "ON". 5. Press SET . 6. Enter your ID from 1 to 5 digits, using 0–9, * and #. 7. Press SET . 8. Press MENU .
		OFF	
#13	<div style="border: 1px solid black; padding: 2px; display: inline-block;">DIALING MODE</div> If you cannot dial, change the setting depending on your telephone line service.	TONE	"TONE": For tone dial service. "PULSE": For rotary pulse dial service.
		PULSE	
#16	<div style="border: 1px solid black; padding: 2px; display: inline-block;">PAPER SIZE</div> To set the recording paper size.	LETTER	"LETTER": Letter size paper. "LEGAL": Legal size paper.
		LEGAL	
#17	<div style="border: 1px solid black; padding: 2px; display: inline-block;">MELODY RINGER</div> To set the ring melody.	BELL	You can select the bell or the melody. The selected bell or melody will sound while setting.
		MELODY (A, B, C, D)	

(The default setting is in bold type.)

Advanced features

How to set menu options

1. Press **MENU** .
2. Rotate **SPEED DIRECTOR** until the following is displayed.

Display: ADVANCED MODE

Press **SET** and rotate **SPEED DIRECTOR** until the desired feature is displayed.

3. Press **SET** .

4. Rotate **SPEED DIRECTOR** until the desired setting is displayed.

5. Press **SET** .

6. Press **MENU** .

Note:

- Step 4 may be slightly different depending on the feature.
- See page 52 for more details.

Programming table

Code	Display & Feature	Settings	How the unit operates
#22	<div style="border: 1px solid black; padding: 2px; display: inline-block;">AUTO JOURNAL</div> To print the journal report automatically for fax communications.	ON	"ON": The unit will print the journal report automatically after every 30 new fax communications (p. 35).
		OFF	
#23	<div style="border: 1px solid black; padding: 2px; display: inline-block;">OVERSEAS MODE</div> If you have difficulty sending an overseas fax, activate this feature before starting transmission. This feature makes sending documents easier as the transmission speed is slowed down.	NEXT FAX	"NEXT FAX": This setting is effective only for the next attempted fax transmission. After transmission, the unit will return to the previous setting. "ERROR": When the previous fax transmission fails and you redial the same number. ● This feature is not available for broadcast transmission. ● The calling charge may be higher.
		ERROR	
		OFF	
#25	<div style="border: 1px solid black; padding: 2px; display: inline-block;">DELAYED SEND</div> To send a fax automatically at a specified time. This allows you to take advantage of low-cost calling hours offered by your telephone company. ● The setting can be reserved to take place up to 24 hours in advance.	ON / fax no. / hh:mm ON	To send a document: 1. Insert the document. 2. Follow steps 1–3 above. 3. Rotate SPEED DIRECTOR to select "ON". 4. Press SET . 5. Enter the fax number. 6. Press SET . 7. Enter the transmission start time. Press * to select "AM" or "PM". 8. Press SET . 9. Press MENU . ● To cancel after programming, press STOP then SET .
		OFF	

(The default setting is in bold type.)

Features Summary

Advanced features (cont.)

How to set menu options

1. Press **MENU**.
2. Rotate **SPEED DIRECTOR** until the following is displayed.
 Display: ADVANCED MODE
 Press **SET** and rotate **SPEED DIRECTOR** until the desired feature is displayed.
3. Press **SET**.
4. Rotate **SPEED DIRECTOR** until the desired setting is displayed.
5. Press **SET**.
6. Press **MENU**.

Note:

- Step 4 may be slightly different depending on the feature.
- See page 52 for more details.

Programming table (cont.)

Code	Display & Feature	Settings	How the unit operates
#26	<div style="border: 1px solid black; padding: 2px; display: inline-block;">AUTO CALL. LIST</div> To print the Caller's list automatically.	ON	"ON": The unit will print the Caller's list automatically after every 30 new calls (p. 29).
		OFF	
#30	<div style="border: 1px solid black; padding: 2px; display: inline-block;">SILENT FAX RING</div> To change the number of rings when the unit detects a voice call in TEL/FAX mode.	3, 4, 5, 6	See pages 46 and 47 for details.
#31	<div style="border: 1px solid black; padding: 2px; display: inline-block;">RING DETECTION</div> If you subscribe to a Distinctive Ring Service from your telephone company, activate this feature. This feature is also required for voice mail service.	A, B, C, D	Select the ring pattern to be assigned to the facsimile number. A: Standard ring (one long ring) B: Double ring (two short rings) C: Triple ring (short-long-short rings) D: Other triple ring (short-short-long rings) ● If you activate this feature, the unit will print an information list. ● For more information about telephone services, contact your telephone company.
		OFF	
#37	<div style="border: 1px solid black; padding: 2px; display: inline-block;">AUTO REDUCTION</div> To receive a fax document that is longer than your recording paper.	ON	"ON": The unit will fit a received document onto your recording paper. "OFF": The unit will print the original size.
		OFF	

(The default setting is in bold type.)

Features Summary

Code	Display & Feature	Settings	How the unit operates
#39	<div style="border: 1px solid black; padding: 2px; display: inline-block;">LCD CONTRAST</div> To adjust the display contrast.	NORMAL	"NORMAL": For normal contrast "DARKER": Used when the display contrast is too light.
		DARKER	
#40	<div style="border: 1px solid black; padding: 2px; display: inline-block;">SILENT DETECT.</div> If you use the unit with an answering machine and wish to receive faxes from older model fax machines, activate this feature.	ON	<ul style="list-style-type: none"> ● If the other party's fax machine does not send a fax calling tone, select "ON". The unit detects a silent pause and activates the fax function. ● If you use an answering machine to give greeting messages and record incoming messages on a single cassette tape, select "OFF".
		OFF	
#41	<div style="border: 1px solid black; padding: 2px; display: inline-block;">FAX ACTIVATION</div> If you use an extension telephone and wish to use it to receive a fax, activate this feature, and enter the code (p. 48). <ul style="list-style-type: none"> ● This code is also used to receive a voice message and a fax in the same call (p. 45). 	ON / CODE= * 9	<ol style="list-style-type: none"> 1. Follow steps 1–3 on page 56. 2. Rotate SPEED DIRECTOR to select "ON". 3. Press SET. 4. Enter your code from 2 to 4 digits, using 0–9 and *. 5. Press SET. 6. Press MENU. <ul style="list-style-type: none"> ● Do not enter "0000".
		OFF	
#44	<div style="border: 1px solid black; padding: 2px; display: inline-block;">RECEIVE ALERT</div> To alert you with beeps when a received document is stored into memory due to a problem.	ON	If you hear slow beeps, clear the printing problem or supply paper to print the stored document. The beeps will stop.
		OFF	
#46	<div style="border: 1px solid black; padding: 2px; display: inline-block;">FRIENDLY RCV</div> To receive a fax automatically when you answer a call and hear a fax calling tone (slow beep).	ON	"ON": You do not have to press FAX START for fax reception.
		OFF	
#48	<div style="border: 1px solid black; padding: 2px; display: inline-block;">LANGUAGE</div> To select either English or French for the display messages.	ENGLISH	"ENGLISH": English is used. "FRENCH": French is used.
		FRENCH	

(The default setting is in bold type.)

Features Summary

Advanced features (cont.)

How to set menu options

1. Press **MENU**.
2. Rotate **SPEED DIRECTOR** until the following is displayed.
 Display: ADVANCED MODE
 Press **SET** and rotate **SPEED DIRECTOR** until the desired feature is displayed.
3. Press **SET**.
4. Rotate **SPEED DIRECTOR** until the desired setting is displayed.
5. Press **SET**.
6. Press **MENU**.

Note:

- Step 4 may be slightly different depending on the feature.
- See page 52 for more details.

Programming table (cont.)

Code	Display & Feature	Settings	How the unit operates
#49	<div style="border: 1px solid black; padding: 2px; display: inline-block;">AUTO DISCONNECT</div> To answer a call with an extension telephone in TEL/FAX mode (p. 47).	ON / CODE= * 0	1. Follow steps 1–3 above. 2. Rotate SPEED DIRECTOR to select "ON". 3. Press SET . 4. Enter your code from 2 to 4 digits, using 0–9 and *. 5. Press SET . 6. Press MENU .
		OFF	
#68	<div style="border: 1px solid black; padding: 2px; display: inline-block;">ECM SELECTION</div> ECM stands for Error Correction Mode. To send a fax even if there is static interference on the telephone line.	ON	This feature is available when the transmitting/receiving stations are ECM compatible. ● If documents are in memory, clear them before making the setting (p. 42).
		OFF	
#70	<div style="border: 1px solid black; padding: 2px; display: inline-block;">FAX PAGER CALL</div> If you have a pager and wish to know when your unit receives a fax, activate this feature.	ON	See page 49 for details.
		OFF	
#76	<div style="border: 1px solid black; padding: 2px; display: inline-block;">CONNECTING TONE</div> If you often have trouble when sending a fax, this feature allows you to hear connecting tones: fax tone, ring back tone and busy tone.	ON	You can confirm the status of the other party's machine. ● If the ring back tone continues, the other party's machine may not be a facsimile or may have run out of paper. Check with the other party. ● The connecting tone volume cannot be adjusted.
		OFF	

(The default setting is in bold type.)

Features Summary

Code	Display & Feature	Settings	How the unit operates
#77	<div style="border: 1px solid black; padding: 2px; display: inline-block;">AUTO ANSWER</div> To change the receive mode in the AUTO ANSWER setting.	FAX ONLY	"FAX ONLY": Facsimile only mode (p. 43)
		TEL/FAX	"TEL/FAX": Telephone/Facsimile mode (p. 46, 47)
#78	<div style="border: 1px solid black; padding: 2px; display: inline-block;">TEL/FAX RING</div> If you use an extension telephone in TEL/FAX mode, select the desired number of rings of the extension telephone.	1, 2, 3, 4	See pages 46 and 47 for details.
#79	<div style="border: 1px solid black; padding: 2px; display: inline-block;">TONER SAVE</div> To save on toner consumption.	ON	"ON": The toner cartridge will last longer.
		OFF	●This feature may reduce print quality.
#80	<div style="border: 1px solid black; padding: 2px; display: inline-block;">SET DEFAULT</div> To reset the advanced features, except the language setting (feature #48 on page 57), to their default settings.	YES	1. Follow steps 1–3 on page 58. 2. Rotate SPEED DIRECTOR to select "YES". 3. Press SET . 4. Press SET again. 5. Press MENU .
		NO	

(The default setting is in bold type.)

Error Messages

Reports

If your unit cannot send a fax, check the following:

- the number you dialed is correct,
- the other party's machine is a facsimile.

If the problem remains, correct it by following the communication message printed on the sending and journal reports (p. 35).

Communication message	Error code	Cause & solution
COMMUNICATION ERROR	40–42 46–52 58, 65 68, 72 FF	●A transmission or reception error occurred. Try again or check with the other party.
	43 44	●A line problem occurred. Connect the telephone line cord to a different jack and try again. ●An overseas transmission error occurred. Try using the overseas mode of feature #23 (p. 55).
DOCUMENT JAMMED	—	●The document is jammed. Remove the jammed document (p. 72).
ERROR-NOT YOUR UNIT	54 59 70	●A transmission or reception error occurred because of a problem with the other party's fax machine. Check with the other party.
MEMORY FULL	—	●The document was not received due to memory being full.
NO DOCUMENT	—	●The document was not fed into the unit properly. Reinsert the document and try again.
OTHER FAX NOT RESPOND	—	●The other party's fax machine is busy or has run out of recording paper. Try again. ●The document was not fed properly. Reinsert the document and try again. ●The other party's fax machine rings too many times. Send the fax manually – dial the number, confirm the fax tone, and press FAX START . ●The other party's machine is not a facsimile. Check with the other party. ●The number you dialed is not in service.
PRESSED THE STOP KEY	—	● STOP was pressed and fax communication was cancelled.
THE COVER WAS OPENED	—	●The front cover was opened. Close it and try again.
OK	—	●Fax communication was successful.

Display

If the unit detects a problem, one or more of the following messages will appear on the display.

Display message	Cause & solution
CALL SERVICE	●There is something wrong with the unit. Contact our service personnel.
CHANGE DRUM	●There is something wrong with the drum unit. Replace the drum unit and the other cartridge (p. 68, 69).
CHECK DOCUMENT	●The document was not fed into the unit properly. Reinsert the document. If misfeeding occurs frequently, clean the document feeder rollers (p. 73) and try again. If the problem remains, adjust the feeder pressure (p. 72).
CHECK DRUM	●The drum unit was not inserted properly. Reinsert it correctly (p. 12, 13).
CHECK MEMORY	●Memory (telephone numbers, parameters, etc.) has been erased. Re-program.
COVER OPEN	●The front cover is open. Close it.
FAILED PICK UP	●Recording paper was not fed into the unit properly. Reinsert the recording paper (p. 71).
FAX IN MEMORY	●The unit has a document in memory. See the other displayed message instructions to print out the document.
FAX MEMORY FULL	●Memory is full of received documents due to a lack of recording paper or a recording paper jam. Install paper or clear the jammed paper. ●When performing memory transmission, the document being stored exceeds the memory capacity of the unit. Transmit the entire document manually.
MEMORY FULL	●When making a copy, the document being stored exceeds the memory capacity of the unit. Press (STOP) to clear the message. Divide the document into sections.
MODEM ERROR	●There is something wrong with the modem circuit. Contact our service personnel.

(continued)

Error Messages

Display message	Cause & solution
NO FAX REPLY	<ul style="list-style-type: none"> ●The other party's fax machine is busy or has run out of recording paper. Try again.
OUT OF PAPER	<ul style="list-style-type: none"> ●Recording paper is not installed or the unit has run out of paper. Install paper (p. 15). ●Recording paper is not fed into the unit properly. Reinstall paper (p. 15).
PAPER JAMMED	<ul style="list-style-type: none"> ●A recording paper jam occurred. Clear the jammed paper (p. 70, 71).
PLEASE WAIT	<ul style="list-style-type: none"> ●The unit is warming up. Wait for a while.
REDIAL TIME OUT	<ul style="list-style-type: none"> ●The other party's fax machine is busy or has run out of recording paper. Try again.
REMOVE DOCUMENT	<ul style="list-style-type: none"> ●The document is jammed. Remove the jammed document (p. 72). ●Attempted to transmit a document longer than 600 mm (23⁵/₈"). Press STOP to remove the document. Divide the document into two or more sheets and try again.
SPD-DIR FULL	<ul style="list-style-type: none"> ●There is no space to store new stations in the SPEED DIRECTOR directory. Erase unnecessary stations (p. 25).
TONER EMPTY	<ul style="list-style-type: none"> ●The toner cartridge is empty. Replace the toner cartridge (p. 68, 69).
TONER LOW	<ul style="list-style-type: none"> ●The remaining toner is low. Replace the toner cartridge as soon as possible (p. 68, 69). We recommend you replace the drum unit every third time you replace the toner cartridge. To check the drum life and quality, please print the printer test list (p. 75).
TRANSMIT ERROR	<ul style="list-style-type: none"> ●A transmission error occurred. Try again.
WRONG PAPER	<ul style="list-style-type: none"> ●The unit printed on paper which is shorter than letter size paper. To prevent the drum unit from becoming dirty, use letter or legal size paper.

When a function does not work, check here before requesting help

General

Problem	Cause & solution
I cannot make and receive calls.	<ul style="list-style-type: none">●The power cord or telephone line cord is not connected. Check the connections (p. 16).●If you used a splitter to connect the unit, remove the splitter and connect the unit to the wall jack directly. If the unit operates properly, check the splitter.
I cannot make calls.	<ul style="list-style-type: none">●The dialing mode setting is wrong. Change the setting of feature #13 (p. 54).
The unit does not work.	<ul style="list-style-type: none">●Disconnect the unit from the telephone line and connect the line to a known working telephone. If the working telephone operates properly, contact our service personnel to have the unit repaired. If the working telephone does not operate properly, contact your telephone company.
The unit does not ring.	<ul style="list-style-type: none">●The ringer volume is set to off. Adjust it (p. 21).
The other party complains they only hear a fax tone and cannot talk.	<ul style="list-style-type: none">●FAX ONLY mode is set. Tell the other party the number is only used for faxes.●Change to TEL mode (p. 42) or TEL/FAX mode (p. 46).
The REDIAL/PAUSE button does not function properly.	<ul style="list-style-type: none">●If this button is pressed during dialing, a pause will be inserted. If pressed immediately after a dial tone is obtained, the last number dialed will be redialed.
The receive mode does not function properly.	<ul style="list-style-type: none">●A Distinctive Ring pattern of feature #31 is set (p. 56).●TEL/FAX mode is set (p. 46, 47).
During programming, I cannot enter the code or ID number.	<ul style="list-style-type: none">●All or part of the numbers are the same. Change the code or ID number of features #12 (p. 54), #41 (p. 57) and #49 (p. 58).
The unit beeps.	<ul style="list-style-type: none">●Recording paper has run out. Press STOP to stop the beeps and install paper.

Operations

Fax – sending

Problem	Cause & solution
I cannot send documents.	<ul style="list-style-type: none"> ●The telephone line cord is connected to the EXT jack on the unit. Connect to the LINE jack (p. 16). ●The other party's fax machine is busy or has run out of recording paper. Try again. ●The other party's machine is not a facsimile. Check with the other party. ●The other party's fax machine rings too many times. Send the fax manually – dial the number, confirm the fax tone, then press FAX START .
The other party complains that letters on their received document are distorted or not clear.	<ul style="list-style-type: none"> ●If your line has special telephone services such as call waiting, the service may have been activated during fax transmission. Connect the unit to a line that does not have these services. ●The extension telephone on the same line is off the hook. Hang up the extension telephone and try again. ●Try copying the document. If the copied image is clear, there may be something wrong with the other party's machine.
The other party complains that dirty patterns or black lines appear on their received document.	<ul style="list-style-type: none"> ●The glass or rollers are dirty. Clean them (p. 73, 74).
I cannot make an international fax call.	<ul style="list-style-type: none"> ●Use the overseas transmission mode of feature #23 (p. 55). ●Add two pauses at the end of the telephone number or dial manually.

Fax – receiving

Problem	Cause & solution
I cannot receive documents.	<ul style="list-style-type: none"> ●The telephone line cord is connected to the EXT jack on the unit. Connect to the LINE jack (p. 16).
I cannot receive documents automatically.	<ul style="list-style-type: none"> ●The receive mode is set to TEL mode. Set to FAX ONLY mode (p. 43) or TEL/FAX mode (p. 46). ●The time taken to answer the call is too long. Decrease the number of rings of features #06 (p. 53), #30 (p. 56) and #78 (p. 59).
The display shows the following message, but faxes are not received. <div style="border: 1px solid black; padding: 2px; display: inline-block;">CONNECTING</div>	<ul style="list-style-type: none"> ●The incoming call is not a fax. Change the receive mode to TEL mode (p. 42).
A blank sheet is ejected.	<ul style="list-style-type: none"> ●The other party placed the document in their fax machine the wrong way. Check with the other party.
A white line or a dirty pattern appears on your recording paper.	<ul style="list-style-type: none"> ●The glass or rollers are dirty. Clean them (p. 73, 74).

(continued)

Fax – receiving (cont.)

Problem	Cause & solution
The printing quality is poor.	<ul style="list-style-type: none"> •The other party sent a faint document. Ask them to send a clearer copy of the document. •Some paper has instructions recommending which side to print on. Try turning the paper over. •You may have used paper with a cotton and/or fiber content that is over 20%, such as letterhead or resume paper. •The remaining toner is low. Replace the toner cartridge (p. 68, 69). •We recommend you replace the drum unit every third time you replace the toner cartridge (p. 68, 69). To check the drum life and quality, please print the printer test list (p. 75). •The toner save mode of feature #79 is on (p. 59).

Receive mode

Problem	Cause & solution
I cannot select the desired receive mode.	<ul style="list-style-type: none"> •If you want to set FAX ONLY or TEL/FAX mode: <ul style="list-style-type: none"> —select the desired mode using feature #77 (p. 59), and —press AUTO ANSWER to turn on the AUTO ANSWER light. •If you want to set TEL mode: <ul style="list-style-type: none"> —press AUTO ANSWER to turn off the AUTO ANSWER light.
The other party complains that they cannot send a document.	<ul style="list-style-type: none"> •The unit is not in AUTO ANSWER mode. Press AUTO ANSWER to turn on the AUTO ANSWER light.

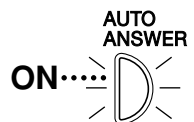
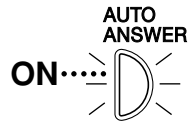

Copying

Problem	Cause & solution
The unit does not make a copy.	<ul style="list-style-type: none"> •You cannot make a copy during programming. Make the copy after programming or stop programming.
A black line, a white line or a dirty pattern appears on the copied document.	<ul style="list-style-type: none"> •The glass or rollers are dirty. Clean them (p. 73, 74).
The printing quality is poor.	<ul style="list-style-type: none"> •Some paper has instructions recommending which side to print on. Try turning the paper over. •You may have used paper with a cotton and/or fiber content that is over 20%, such as letterhead or resume paper. •The remaining toner is low. Replace the toner cartridge (p. 68, 69). •We recommend you replace the drum unit every third time you replace the toner cartridge (p. 68, 69). To check the drum life and quality, please print the printer test list (p. 75). •The toner save mode of feature #79 is on (p. 59).

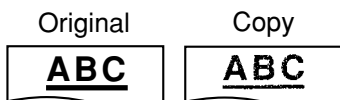

Operations

Using an answering machine

Problem	Cause & solution
I cannot receive documents automatically.	<ul style="list-style-type: none">●Your greeting message on the answering machine is too long. Shorten the message (up to 10 seconds).●The answering machine rings too many times. Set to 1 or 2 rings.
I cannot receive voice messages.	<ul style="list-style-type: none">●Check if the answering machine is turned on and connected to the fax machine properly (p. 44).●Set the number of rings on the answering machine to 1 or 2.
I cannot retrieve recorded voice messages on the answering machine from a remote location.	<ul style="list-style-type: none">●You did not program your remote access code in your fax machine correctly. Program the same code that is programmed on the answering machine to the fax machine with feature #12 (p. 54).
I pressed the remote access code to access the answering machine remotely, but the line was disconnected.	<ul style="list-style-type: none">●The code may include “#” which is used for certain features provided by telephone companies. Change the code on the answering machine to another number which does not include “#”. Also change the code of the fax machine with feature #12 (p. 54).
Callers complain that they cannot send a document.	<ul style="list-style-type: none">●Your answering machine has run out of recording tape. Rewind the tape to record messages.●You set the answering machine to only give a greeting message.

If a power failure occurs

- The unit will not function.
- Fax transmission and reception will be interrupted.
- If delayed transmission of feature #25 (p. 55) is programmed and the start time has passed during a power failure, transmission will be attempted soon after power is restored.
- If fax documents are stored in memory, they will be lost. When power is restored, a power down report will be printed out stating which contents in memory have been erased.

Sample of a power down report

```
POWER DOWN REPORT / RAPPORT DE PANNE DE COURANT

POWER DOWN AT:/ COUPURE           :Jan. 05 2001 04:30AM
RESTARTED AT:/ RÉTABLISSEMENT:Jan. 05 2001 04:31AM

YOUR LOGO / VOTRE LOGOTYPE       :
YOUR FAX NO. / VOTRE NUMÉRO DE FAX :
```

<< WARNING >>
CONTENTS HAVE BEEN CLEARED DUE TO POWER DOWN.
FOR ADDITIONAL INFORMATION, PLEASE SEE THE JOURNAL REPORT.

<< AVIS >>
LES DONNÉES ONT ÉTÉ EFFACÉES SUITE À UNE PANNE DE COURANT.
POUR PLUS D'INFORMATIONS, VOIR LE REGISTRE DES COMMUNICATIONS
(JOURNAL).

NO.	OTHER FACSIMILE	MODE	PAGES	FUNCTION
NO	CORRESPONDANT	MODE	PAGES	FONCTION
01	<FAX # NOT AVAIL.>	RCV	01	MEMORY RECEIVE

Note:

- If you select "FRENCH" for the language (feature #48 on page 57), the time is shown using a 24 hour clock (military time).

Replacement

Replacing the toner cartridge and the drum unit

■When the display shows the following message, replace the toner cartridge.

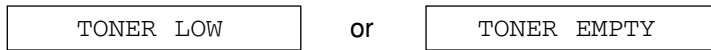

■We recommend you replace the drum unit every third time you replace the toner cartridge.
To check the drum life and quality, please print the printer test list (p. 75).

Model No. KX-FA76A toner cartridge and **Model No. KX-FA77A drum unit** are available for replacement (p. 8).

Caution:

●The drum unit contains a photosensitive drum. Exposing it to light may damage the drum.

Once you have opened the protection bag:

- Do not expose the drum unit to light for more than 5 minutes.
- Do not touch or scratch the green drum surface.
- Do not place the drum unit near dust or dirt, or in a high humidity area.
- Do not expose the drum unit to direct sunlight.

●Do not unplug the fax machine to prevent loss of fax documents in memory.

●Do not pour any toner into the toner cartridge.

1 Remove the new toner cartridge from the protection bag. Peel off the seal from the toner cartridge.

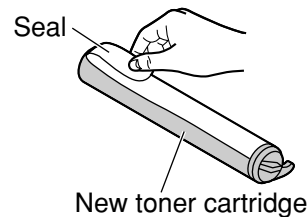

2 Push the front cover open button then open the front cover.



Caution:
The fuser unit gets hot.
Do not touch it.

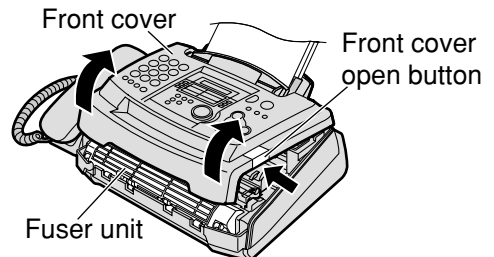

3 Tap on the used toner cartridge several times to allow the remaining toner to fall into the drum unit. Remove the drum and toner unit by holding the two tabs.

●If you replace the toner cartridge and the drum unit at the same time, skip to step 6.

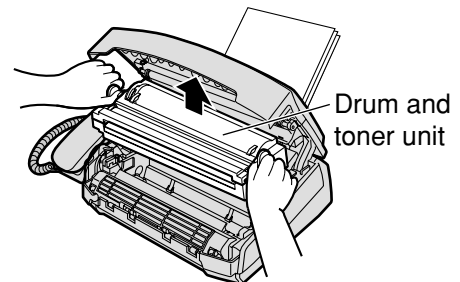

4 Turn the two levers on the used toner cartridge firmly.

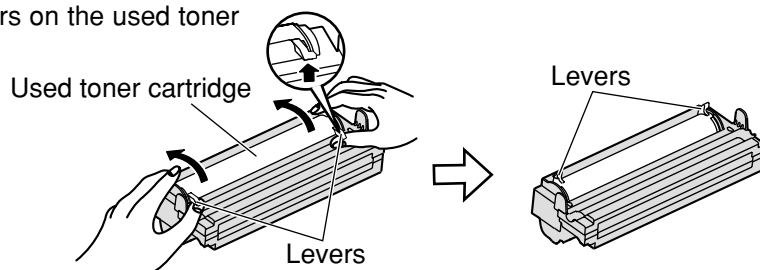

Replacement

5 Pull up the right edge of the used toner cartridge (①). Remove the cartridge from the drum unit (②).

- The toner may stick to the cartridge and the drum unit. Be careful when handling. See page 4 for details.
- Do not drop the toner on the green drum surface.
- Put the used toner cartridge into the protection bag.

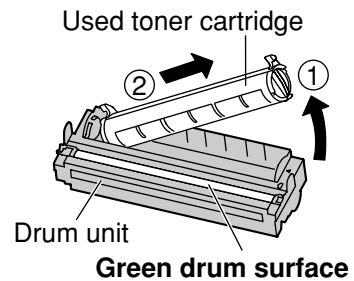

6 If you replace the drum unit at the same time, remove the new drum unit from the protection bag. Remove the protection bar from the drum unit.

With Panasonic face up on the toner cartridge, match the red arrows on the cartridge and the drum unit.

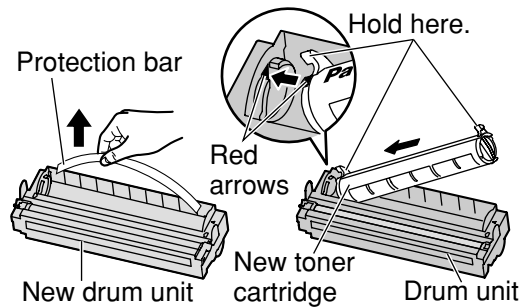

7 Slide the tab of the toner cartridge into the slot of the drum unit.

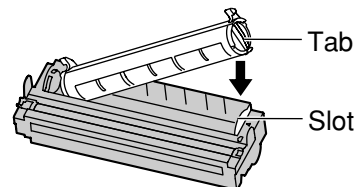

8a Hold right side of the toner cartridge under the lip on the drum unit and...

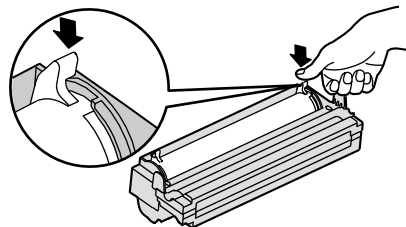

8b turn the two levers on the toner cartridge with firm pressure.

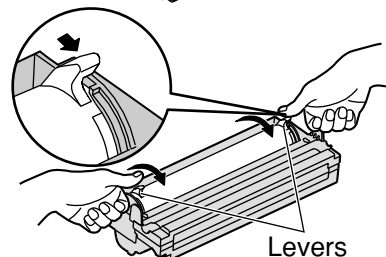

9 The toner cartridge is installed when the triangles match.

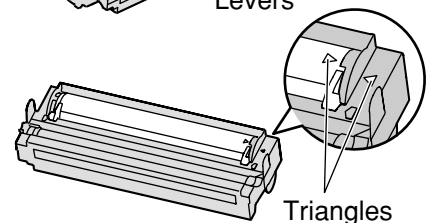

10 Tap on the toner cartridge several times to allow the toner to fall into the drum unit. Grab the tabs, and shake the drum and toner unit horizontally several times.

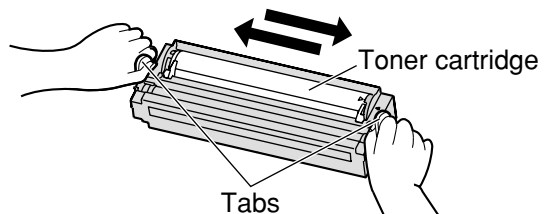

Replacement / Jams

11 Install the drum and toner unit by holding the tabs.

- If the lower glass is dirty, clean it with a soft, dry cloth.

Lower glass

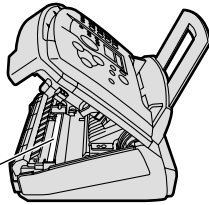

Drum and toner unit

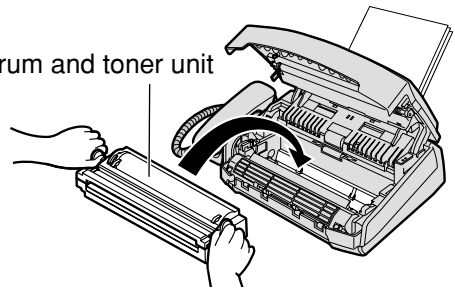

12 Close the front cover, until locked, by pushing down on both sides.

Waste disposal method

- Waste material may be dumped or incinerated under conditions which meet all country and local environmental regulations.

Front cover

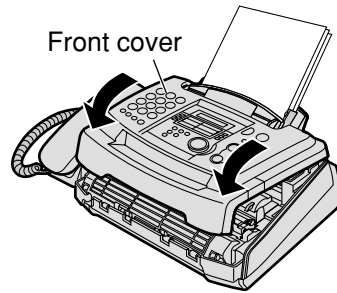

Recording paper jam

When the recording paper has jammed in the unit

The display will show the following message.

PAPER JAMMED

1 Push the front cover open button then open the front cover.



Caution:
The fuser unit gets hot.
Do not touch it.

Front cover

Front cover open button

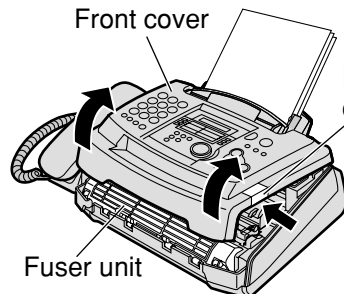

Fuser unit

2 When the recording paper has jammed near the drum and toner unit:

Remove the jammed paper by pulling it toward you.

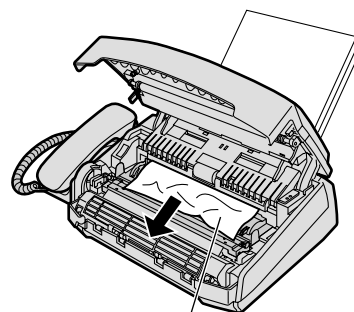

Jammed paper

When the recording paper has jammed near the recording paper exit:

Remove the jammed paper by pulling it toward you.

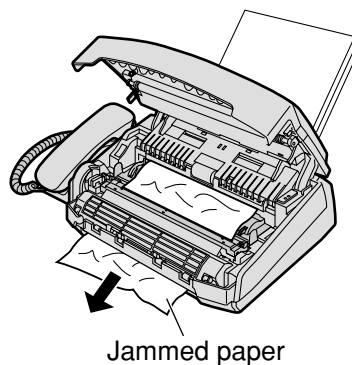

- 3** Close the front cover, until locked, by pushing down on both sides.

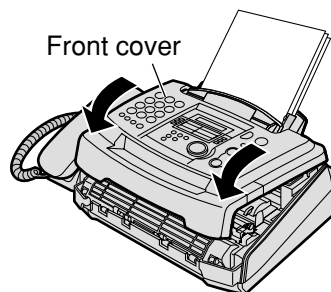

- 4** Remove the recording paper. Straighten and reinsert it into the recording paper entrance.



When the recording paper was not fed into the unit properly

The display will show the following message.

FAILED PICK UP

Remove the recording paper. Straighten and reinsert it into the recording paper entrance.

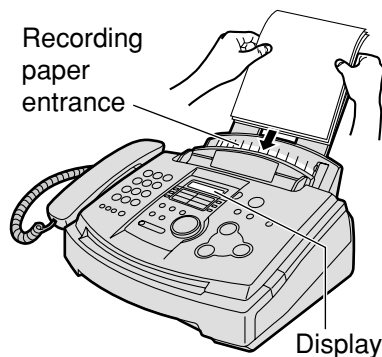

Document jams - sending

- 1 Push the front cover open button then open the front cover.



Caution:
The fuser unit gets hot.
Do not touch it.

- 2 Pull down the middle guide while holding the front cover.

- 3 Remove the jammed document carefully.

- 4 Lift the middle guide firmly.

- 5 Close the front cover, until locked, by pushing down on both sides.

Note:

- Do not pull out the jammed document forcibly before opening the front cover.

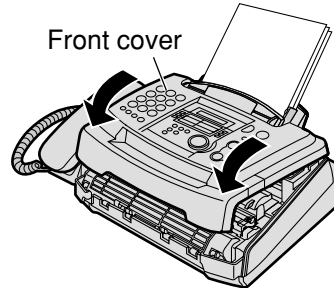
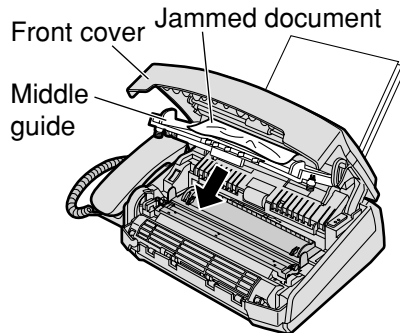
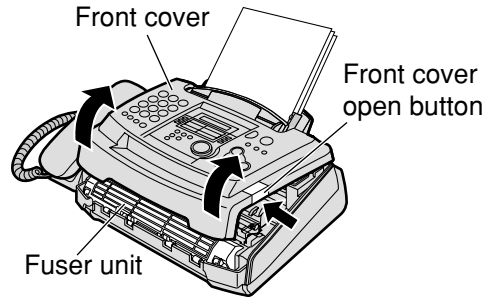
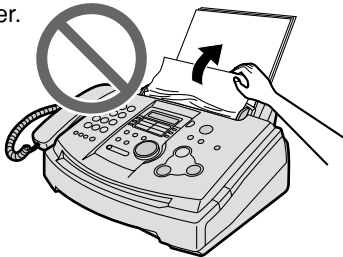

No feeding or multiple feeding occurs while sending

If no feeding or multiple feeding occurs frequently, adjust the feeder pressure.

Shift the position of the green lever by using a stick like instrument with a pointed end.

Left: When documents do not feed.

Centre: Standard position (pre-selected)

Right: When documents multi-feed.

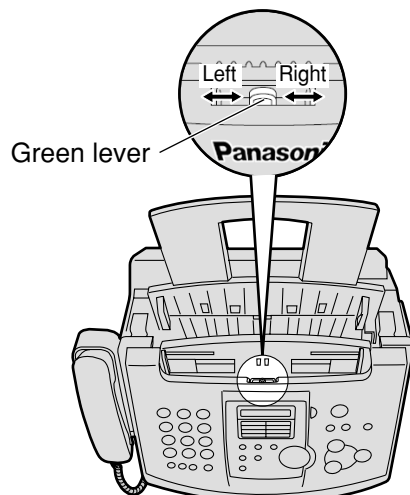

Cleaning the inside of the unit

If any of the following problems occurs, clean the inside of the unit:

- If misfeeding of your original occurs frequently.
- If a black line, a white line or a dirty pattern appears on your recording paper, on your original, or on the fax document received by the other party.

Caution:

●Be careful in handling the toner drum unit.

See the caution for the drum unit on page 68 for details.

●Do not use paper products, such as paper towels or tissues, to clean the inside of the unit.

- 1** Disconnect the power cord and the telephone line cord.

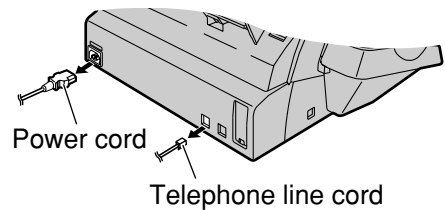

- 2** Push the front cover open button then open the front cover.



Caution:
The fuser unit gets hot.
Do not touch it.

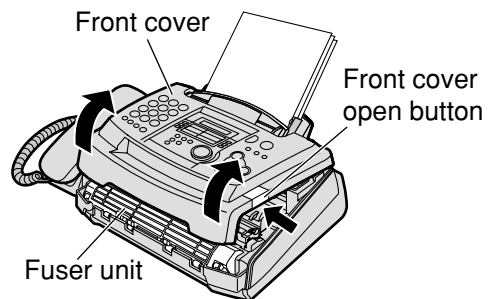

- 3** Pull down the middle guide while holding the front cover.

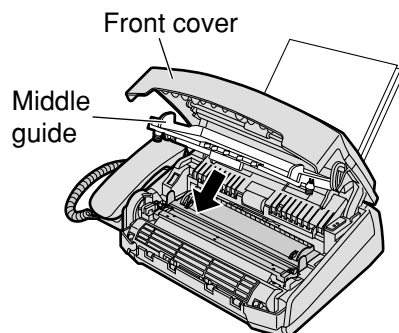

- 4** Clean the document feeder rollers with a cloth moistened with isopropyl rubbing alcohol, and let all parts dry thoroughly.

Clean the upper glass with a soft, dry cloth.

- 5** Lift the middle guide firmly.

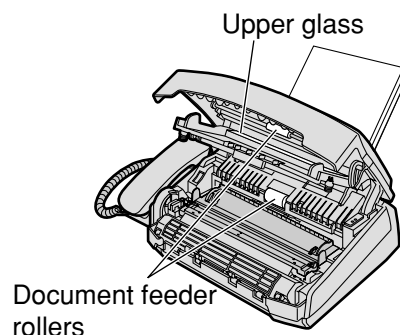

(Continued)

Cleaning

- 6** Remove the drum and toner unit by holding the two tabs.

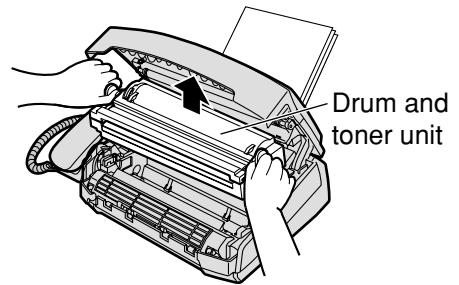

- 7** Clean the lower glass with a soft, dry cloth.

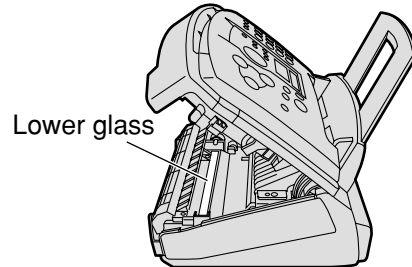

- 8** Reinstall the drum and toner unit by holding the tabs.

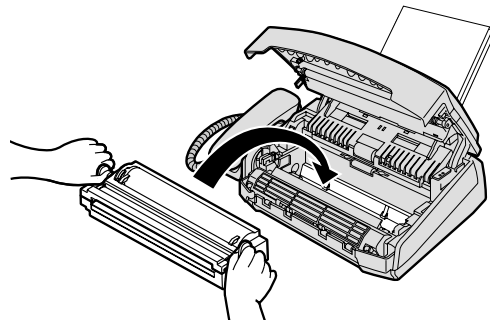

- 9** Close the front cover, until locked, by pushing down on both sides.

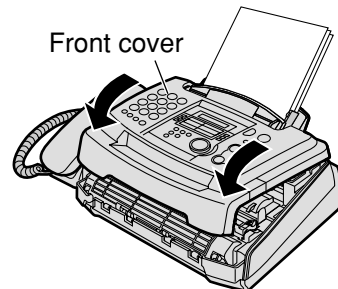

- 10** Reconnect the power cord and the telephone line cord.

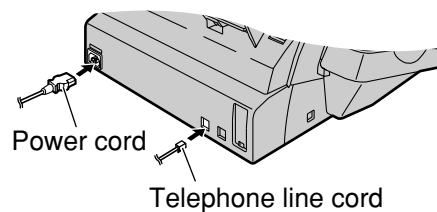

Reference lists and reports

You can print out the following lists and reports for your reference.

Setup list: provides you with the current settings of the basic and advanced programming features (p. 53–59).

Telephone number list: provides you with names and telephone numbers which are stored in ONE-TOUCH DIAL and SPEED DIRECTOR.

Journal report: keeps records of fax transmission and reception. This report will be printed automatically after every 30 fax communications (p. 35).

Broadcast programming list: provides you with items which are stored in the broadcast feature (p. 36).

Printer test list: allows you to check the print quality of your unit. If the test print has a dirty pattern, or blurred points or lines, clean the inside of the unit (p. 73, 74). If printing quality is still poor, replace the toner cartridge and drum unit.

One-touch label card: provides you with names which are stored in the ONE-TOUCH DIAL keys (p. 22). You can put the card in the one-touch dial location.

1 Press **MENU** two times.

Display:

2 Rotate **SPEED DIRECTOR** until the desired item is displayed.

3 Press **SET** to start printing.

- To stop printing, press **STOP**.
- After printing, the printed item will be displayed.

4 Press **MENU**.

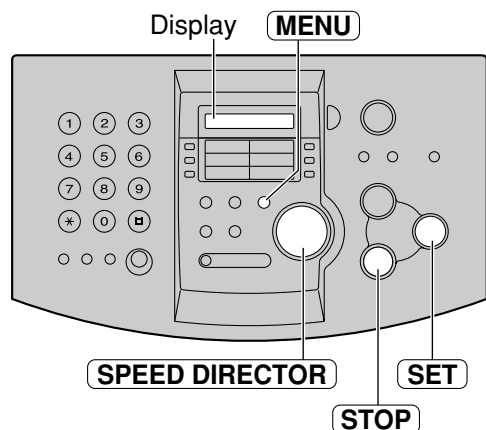

Warranty

Panasonic Canada Inc.

5770 Ambler Drive, Mississauga, Ontario L4W 2T3

PANASONIC PRODUCT – LIMITED WARRANTY

Panasonic Canada Inc. warrants this product to be free from defects in material and workmanship and agrees to remedy any such defect for a period as stated below from the date of original purchase.

Facsimile Product – One (1) year, parts and labour

LIMITATIONS AND EXCLUSIONS

This warranty does not apply to products purchased outside Canada or to any product which has been improperly installed, subjected to usage for which the product was not designed, misused or abused, damaged during shipping, or which has been altered or repaired in any way that affects the reliability or detracts from the performance, nor does it cover any product which is used commercially. Dry cell batteries, toner cartridge / drum unit and ink / print cartridges are also excluded from coverage under this warranty. Rechargeable batteries are warranted for ninety (90) days from date of original purchase.

This warranty is extended to the original end user purchaser only. A purchase receipt or other proof of date of original purchase is required before warranty service is performed.

THIS EXPRESS, LIMITED WARRANTY IS IN LIEU OF ALL OTHER WARRANTIES, EXPRESS OR IMPLIED, EXCLUDING ANY IMPLIED WARRANTIES OF MERCHANTABILITY OR FITNESS FOR A PARTICULAR PURPOSE.

IN NO EVENT WILL PANASONIC CANADA INC. BE LIABLE FOR ANY SPECIAL, INDIRECT OR CONSEQUENTIAL DAMAGES.

In certain instances, some jurisdictions do not allow the exclusion or limitation of incidental or consequential damages, or the exclusion of implied warranties, so the above limitations and exclusions may not be applicable.

WARRANTY SERVICE

For product operation and information assistance, please contact your Dealer or our Customer Care Centre at: Telephone #: (905) 624-5505 Fax #: (905) 238-2360 Web: www.panasonic.ca

For product repairs, please contact one of the following:

- Your Dealer who will inform you of an authorized Servicentre nearest you.
- Our Customer Care Centre at (905) 624-5505 or www.panasonic.ca
- A Panasonic Factory Servicentre listed below:

Richmond, British Columbia

Panasonic Canada Inc.
13131 Bathgate Place
Richmond, BC V6V 1Z3
Tel: (604) 278-4211
Fax: (604) 278-5627

Calgary, Alberta

Panasonic Canada Inc.
6835-8th St. N. E.
Calgary, AB T2E 7H7
Tel: (403) 295-3955
Fax: (403) 274-5493

Mississauga, Ontario

Panasonic Canada Inc.
5770 Ambler Dr.
Mississauga, ON
L4W 2T3
Tel: (905) 624-8447
Fax: (905) 238-2418

Lachine, Québec

Panasonic Canada Inc.
3075, rue Louis A. Amos
Lachine, QC H8T 1C4
Tel: (514) 633-8684
Fax: (514) 633-8020

CUSTOMER'S RECORD: _____

Customer Name: _____

Model Number: _____

Serial Number: _____

Date of Purchase: _____

Dealer's Name: _____

Address: _____

Phone Number: _____

IF YOU SHIP THE PRODUCT TO A SERVICENTRE

Carefully pack and send prepaid, adequately insured and preferably in the original carton. Include details of the defect claimed, and proof of date of original purchase.

Important information

SAFETY PRECAUTIONS

This unit may only be connected to electrical outlets that supply 120 V AC.

NOTICE:

The Industry Canada label identifies certified equipment. This certification means that the equipment meets certain telecommunications network protective, operational and safety requirements. The Department does not guarantee the equipment will operate to the user's satisfaction.

Before installing this equipment, users should ensure that it is permissible to be connected to the facilities of the local telecommunications company. The equipment must also be installed using an acceptable method of connection. The customer should be aware that compliance with the above conditions may not prevent degradation of service in some situations.

Repairs to certified equipment should be made by an authorized Canadian maintenance facility designated by the supplier. Any repairs or alterations made by the user to this equipment, or equipment malfunctions, may give the telecommunications company cause to request the user to disconnect the equipment.

Users should ensure, for their own protection, that the electrical ground connections of the power utility, telephone lines and internal metallic water pipe system, if present, are connected together. This precaution may be particularly important in rural areas.

CAUTION:

Users should not attempt to make such connections themselves, but should contact the appropriate electric inspection authority, or electrician, as appropriate.

NOTICE:

The **Ringer Equivalence Number (REN)** assigned to each terminal device provides an indication of the maximum number of terminals allowed to be connected to a telephone interface. The termination on an interface may consist of any combination of devices subject only to the requirement that the sum of the Ringer Equivalence Numbers of all the devices does not exceed 5.

The Ringer Equivalence of This Unit:
(found on the rear of the unit)

Specifications

Technical data about this product

Applicable Lines:	Public Switched Telephone Network
Document Size:	Max. 216 mm (8½") in width / Max. 600 mm (23⅝") in length
Effective Scanning Width:	208 mm (8⅜")
Recording Paper Size:	Letter: 216 mm x 279 mm (8½" x 11") Legal: 216 mm x 356 mm (8½" x 14")
Effective Printing Width:	208 mm (8⅜")
Transmission Time*:	Approx. 8 s/page (ECM-MMR)**
Scanning Density:	Horizontal: 8 pels/mm (203 pels/inch) Vertical: 3.85 lines/mm (98 lines/inch) –STANDARD 7.7 lines/mm (196 lines/inch) –FINE/PHOTO/PHOTO WITH TEXT 15.4 lines/mm (392 lines/inch) –SUPER FINE
Halftone Level:	64-level
Scanner Type:	Contact Image Sensor (CIS)
Printer Type:	Laser Beam Printer
Data Compression System:	Modified Huffman (MH), Modified READ (MR), Modified Modified READ (MMR)
Modem Speed:	14,400 / 12,000 / 9,600 / 7,200 / 4,800 / 2,400 bps; Automatic Fallback
Operating Environment:	10 °C – 32.5 °C (50 °F – 90.5 °F), 20 % – 80 % RH (Relative Humidity)
Dimensions (H x W x D):	190 mm x 417 mm x 345 mm (7½" x 16⅝" x 13⅝")
Weight:	Approx. 6.5 kg (14.3 lb.)
Power Consumption:	Standby: Approx. 5 W Transmission: Approx. 25 W Reception: Approx. 200 W Copy: Approx. 200 W Maximum: Approx. 560 W (When the fuser unit turns on)
Power Supply:	120 V AC, 60 Hz
Memory Capacity:	Fax memory: Approx. 120 pages of memory transmission Approx. 170 pages of memory reception (Based on the ITU-T No. 1 Test Chart in standard resolution.)
Laser diode properties:	Laser output: Max. 5 mW Wave length: 760 nm – 800 nm Emission duration: Continuous
Print Speed:	10 ppm (pages per minute)
Printing Resolution:	600 x 600 dpi

* Transmission speed depends upon the contents of the pages, resolution, telephone line conditions and capability of the other party's machine.

** Transmission speed is based upon the ITU-T No. 1 Test Chart and original mode.

If the capability of the other party's machine is inferior to your unit, the transmission time may be longer.

ITU-T No. 1 Test Chart

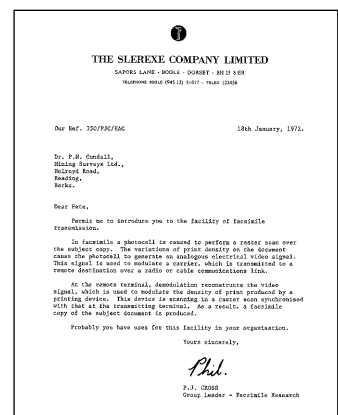

Toner life

Model No. KX-FA76A toner cartridge can print approx. 2,000 sheets of letter size paper with a 5% image area. Toner life depends on the amount of content in a received, copied or printed document. The following is the approximate relationship between image area and toner life for Model No. KX-FA76A toner cartridge. Toner life varies in actual usage.

5% image area

Specifications	
Main unit specifications	
1. Applicable Lines:	Public switched telephone network
2. Compatibility:	ITU-TS G3
3. Effective Scanning Width:	Max. 206mm
4. Recording Paper Size:	Letter: 216 x 279mm Legal: 216 x 356mm
5. Effective Printing Width:	206mm
6. Transmission Time:	Approx. 18sec/page (3 Normal mode, H) / Approx. 17sec/page (3 Original mode, H) / Approx. 15sec/page (3 Original mode, H)
7. Fax Redial Times:	Up to 31 times
8. Telephone Redial Times:	Up to 31 times
9. Scanning Density:	Horizontal: 3.85 lines/mm-Standard mode Vertical: 3.85 lines/mm-Standard mode 7.71 lines/mm-Fine or HalfTone mode
10. Scanner Type:	Contact image sensor

10% image area

Specifications	
Main unit specifications	
1. Applicable Lines:	Public switched telephone network
2. Compatibility:	ITU-TS G3
3. Effective Scanning Width:	Max. 206mm
4. Recording Paper Size:	Letter: 216 x 279mm Legal: 216 x 356mm
5. Effective Printing Width:	206mm
6. Transmission Time:	Approx. 30sec/page (3 Normal mode, H) / Approx. 27sec/page (3 Original mode, H) / Approx. 15sec/page (3 Original mode, H)
7. Fax Redial Times:	Up to 31 times
8. Telephone Redial Times:	Up to 31 times
9. Scanning Density:	Horizontal: 3.85 lines/mm-Standard mode Vertical: 3.85 lines/mm-Standard mode 7.71 lines/mm-Fine or HalfTone mode
10. Scanner Type:	Contact image sensor
11. Printer Type:	Electrophotographic LED array printer
12. Data Compression System:	Modified Huffman (MH), Modified READ (MR)
13. Modem Speed:	9600/7200/4800/2400bps, Automatic FallBack
14. Operating Environment:	10-32.5 C 20-80%RH
15. Dimensions (H x W x D):	271 x 442 x 489mm
16. Mass (Net/A):	Approx. 1.2kg
17. Power Consumption:	Standby: 12-40W Transmission: 17-40W Reception: 13-40W Copy: 24-30W Maximum: 60W
*Transmission Time: Transmission time apply to test data using ITU-TS No. 1 test chart (standard) for same mode at maximum speed and may vary in actual usage.	

15% image area

Specifications	
Main unit specifications	
1. Applicable Lines:	Public switched telephone network
2. Compatibility:	ITU-TS G3
3. Effective Scanning Width:	Max. 206mm
4. Recording Paper Size:	Letter: 216 x 279mm Legal: 216 x 356mm
5. Effective Printing Width:	206mm
6. Transmission Time:	Approx. 30sec/page (3 Normal mode, H) / Approx. 27sec/page (3 Original mode, H) / Approx. 15sec/page (3 Original mode, H)
7. Fax Redial Times:	Up to 31 times
8. Telephone Redial Times:	Up to 31 times
9. Scanning Density:	Horizontal: 3.85 lines/mm-Standard mode Vertical: 3.85 lines/mm-Standard mode 7.71 lines/mm-Fine or HalfTone mode
10. Scanner Type:	Contact image sensor
11. Printer Type:	Electrophotographic LED array printer
12. Data Compression System:	Modified Huffman (MH), Modified READ (MR)
13. Modem Speed:	9600/7200/4800/2400bps, Automatic FallBack
14. Operating Environment:	10-32.5 C 20-80%RH
15. Dimensions (H x W x D):	271 x 442 x 489mm
16. Mass (Net/A):	Approx. 1.2kg
17. Power Consumption:	Standby: 12-40W Transmission: 17-40W Reception: 13-40W Copy: 24-30W Maximum: 60W
*Transmission Time: Transmission time apply to test data using ITU-TS No. 1 test chart (standard) for same mode at maximum speed and may vary in actual usage.	
*Cutting Dimensions: 1. Cut with sharp blade, no paper dust flying out. 2. Cut edge conditions: Not to exceed 100µ. 3. Curl: Not allowed curl toward side to be assembled. 4. Marking: Polyimide material, moisture proof resin with appr. *The specifications are subject to change without notice.	

Toner life for KX-FA76A

sheets 2,000

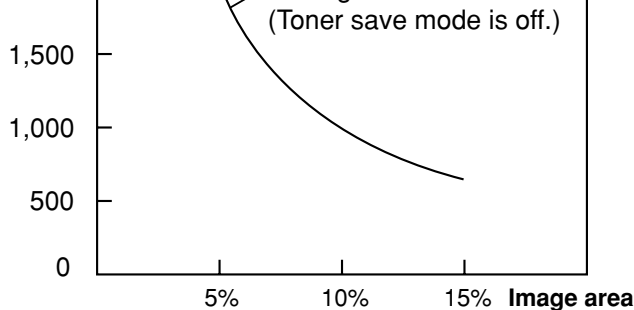

Note:

- The image area changes with the depth, thickness and size of the characters.
- If you change the toner save setting to on, the toner cartridge will last approx. 40% longer.

Drum life

The included drum unit or Model No. KX-FA77A can print approx. 6,000 sheets of letter size paper regardless of the content of the image area.

Note:

- Any details given in these instructions are subject to change without notice.
- The pictures and illustrations in these instructions may vary slightly from the actual product.

Index

- A** Accessories8
- Advanced features55–59
- Answering machine44
- AUTO ANSWER button42, 43, 46
- Auto Answer setting (Feature #77) ...59
- Auto disconnection (Feature #49) ...58
- Auto reduction (Feature #37)42, 56
- B** Basic features53, 54
- BROADCAST keys36, 39
- Broadcast sending report39
- Broadcast transmission36
- C** Call Display27
 - (Calling back)28
 - (Storing into directory)30
- CALL DISPLAY PRINT button29
- CALL DISPLAY SEARCH button .28, 30
- Caller's list (Feature #26)29, 56
- Character table19
- Cleaning73, 74
- COLLATE button51
- Communication messages60
- Connecting tone (Feature #76)58
- Connections16, 48
- Copy50
- Copy reduction/enlargement51
- COPY ZOOM button51
- D** Date and time (Feature #01)17
- Delayed transmission (Feature #25) .55
- Delete button19
- Dialing mode (Feature #13)54
- DIRECTORY PROGRAM button .22, 23
- Display
 - (Contrast)(Feature #39)57
 - (Error messages)61, 62
- Distinctive ring service
 - (Feature #31)56
- Document jam72
- Document size34
- Document stacker14
- Drum life79
- Drum unit12, 68
- E** Error correction mode (Feature #68) .58
- Error messages60–62
- Extension telephone47, 48
- F** Facsimile telephone number
 - (Feature #03)20
- Fax activation code
 - (Feature #41)45, 48, 57
- Fax auto redial33
- FAX ONLY mode43
- Fax receiving40, 41
- Fax ring count (Feature #06)53
- Feeder pressure72
- Friendly reception (Feature #46) .42, 57
- H** Handset receiver volume21
- HELP button9
- Hyphen button19
- I** Insert button19
- J** Jams70–72
- Journal report (Feature #22) ...35, 75
- L** Language (Feature #48)57
- List
 - (Broadcast programming)75
 - (Broadcast sending)39
 - (Journal)35, 75
 - (One-touch label)22, 75
 - (Power down)67
 - (Printer test)75
 - (Sending)35
 - (Setup)75
 - (Telephone number)75
- Logo (Feature #02)18
- LOWER key22, 26, 33
- M** MANUAL BROAD button36
- Melody ring (Feature #17)21, 54
- Memory reception42
- MONITOR button32
- Monitor volume21
- N** NAME/TEL NO. key26, 28
- O** One-touch dial
 - (Card)22, 75
 - (Making a voice call)26
 - (Sending faxes)33
 - (Storing)22
- Overseas mode (Feature #23)55

- P**
 - Pager call (Feature #70)49, 58
 - Paper jam70
 - Paper size (Feature #16)54
 - Paper stacker14
 - Paper tray14
 - Power down report67
 - Power failure67
 - Power supply78
- Q**
 - QUICK SCAN START button32
- R**
 - Receiving alert (Feature #44)57
 - Receiving setting40, 41
 - Recording paper15
 - Recording paper size78
 - REDIAL button32
 - Remote activation ID (Feature #12) . .54
 - Report
 - (Broadcast sending)39
 - (Journal)35, 75
 - (Sending)35
 - Reset (Feature #80)59
 - RESOLUTION button32, 50
 - Ring count
 - (FAX ONLY)(Feature #06)53
 - (Silent fax)(Feature #30)56
 - (TEL/FAX)(Feature #78)59
 - Ring detection (Feature #31)56
 - Ringer volume21
- S**
 - Sending
 - (Broadcast)39
 - (From memory)32
 - (Manually)32
 - (One-touch dial)33
 - (SPEED DIRECTOR)33
 - Sending report (Feature #04)35, 53
 - Set default (Feature #80)59
 - Silent detection (Feature #40)57
 - Silent fax recognition ring
 - (Feature #30)46, 47, 56
 - Specifications78
 - SPEED DIRECTOR
 - (Making a voice call)26
 - (Selecting characters)19
 - (Sending faxes)33
 - (Storing)23
- Storing**
 - (Broadcast key)36
 - (One-touch dial)22
 - (SPEED DIRECTOR)23
- T**
 - TEL mode42
 - TEL/FAX delayed ring count
 - (Feature #78)46, 47, 59
 - TEL/FAX mode46
 - Toner cartridge12, 68
 - Toner life79
 - Toner save (Feature #79)13, 59
 - Transmission
 - (Broadcast)39
 - (From memory)32
 - (Manually)32
 - (One-touch dial)33
 - (SPEED DIRECTOR)33
- V**
 - Voice contact31
 - VOLUME button21

Panasonic Canada Inc.

5770 Ambler Drive, Mississauga, Ontario L4W 2T3

www.panasonic.ca

Free Manuals Download Website

<http://myh66.com>

<http://usermanuals.us>

<http://www.somanuals.com>

<http://www.4manuals.cc>

<http://www.manual-lib.com>

<http://www.404manual.com>

<http://www.luxmanual.com>

<http://aubethermostatmanual.com>

Golf course search by state

<http://golfingnear.com>

Email search by domain

<http://emailbydomain.com>

Auto manuals search

<http://auto.somanuals.com>

TV manuals search

<http://tv.somanuals.com>