

Panasonic®

Operating Instructions

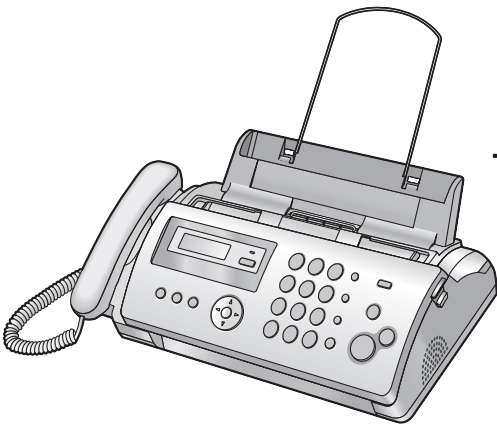

Compact Plain Paper Fax and Copier

Model No. **KX-FP205**



FOR FAX ADVANTAGE ASSISTANCE:

— REFER TO

www.panasonic.com/helpfax

for customers in the U.S.A. or Puerto Rico

— E-MAIL TO

consumer_fax@us.panasonic.com

for customers in the U.S.A. or Puerto Rico

— PHONE CALL

1-800-HELP-FAX (1-800-435-7329)

Please read these Operating Instructions before using the unit and save for future reference.

This unit is compatible with Caller ID. To use this feature, you must subscribe to the appropriate service of your service provider.

This model is designed to be used only in the U.S.A.

Thank you for purchasing a Panasonic fax machine.

Things you should keep a record of

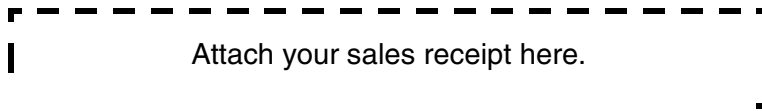

For your future reference

Date of purchase
Serial number (found on the rear of the unit)
Dealer's name and address
Dealer's telephone number

Caution:

- The Telephone Consumer Protection Act of 1991 makes it unlawful for any person to use a computer or other electronic device, including fax machines, to send any message unless such message clearly contains in a margin at the top or bottom of each transmitted page or on the first page of the transmission, the date and time it is sent and an identification of the business or other entity, or other individual sending the message and the telephone number of the sending machine or such business, other entity, or individual. (The telephone number provided may not be a 900 number or any other number for which charges exceed local or long-distance transmission charges.) In order to program this information into your fax machine, you should complete the instructions on page 14 to page 15.
- Note that the images of copied or received documents will remain on the used ink film. Use discretion when disposing of the used ink film.
- Do not rub or use an eraser on the printed side of recording paper, as the print may smear.

Energy Star:

- As an ENERGY STAR® Partner, Panasonic has determined that this product meets the ENERGY STAR guidelines for energy efficiency. ENERGY STAR is a U.S. registered mark.



Trademarks:

- Hammermill is a registered trademark of INTERNATIONAL PAPER in the United States and/or other countries.
- All other trademarks identified herein are the property of their respective owners.

Copyright:

- This material is copyrighted by Panasonic Communications Co., Ltd., and may be reproduced for internal use only. All other reproduction, in whole or in part, is prohibited without the written consent of Panasonic Communications Co., Ltd.

© 2006 Panasonic Communications Co., Ltd. All Rights Reserved.

Important safety instructions

When using this unit, basic safety precautions should always be followed to reduce the risk of fire, electric shock, or personal injury.

1. Read and understand all instructions.
2. Follow all warnings and instructions marked on this unit.
3. Unplug this unit from power outlets before cleaning. Do not use liquid or aerosol cleaners.
4. Do not use this unit near water, for example near a bathtub, wash bowl, kitchen sink, etc.
5. Place the unit securely on a stable surface. Serious damage and/or injury may result if the unit falls.
6. Do not cover slots and openings on the unit. They are provided for ventilation and protection against overheating. Never place the unit near radiators, or in a place where proper ventilation is not provided.
7. Use only the power source marked on the unit. If you are not sure of the type of power supplied to your home, consult your dealer or local power company.
8. For safety purposes this unit is equipped with a grounded plug. If you do not have this type of outlet, please have one installed. Do not defeat this safety feature by tampering with the plug.
9. Do not place objects on the power cord. Install the unit where no one can step or trip on the cord.
10. Do not overload power outlets and extension cords. This can result in the risk of fire or electric shock.
11. Never push any objects through slots in this unit. This may result in the risk of fire or electric shock. Never spill any liquid on the unit.
12. To reduce the risk of electric shock, do not disassemble this unit. Take the unit to an authorized service center when service is required. Opening or removing covers may expose you to dangerous voltages or other risks. Incorrect reassembly can cause electric shock when the unit is subsequently used.
13. Unplug this unit from power outlets and refer servicing to an authorized service center when the following conditions occur:
 - A. When the power cord is damaged or frayed.
 - B. If liquid has been spilled into the unit.
 - C. If the unit has been exposed to rain or water.
 - D. If the unit does not work normally by following the operating instructions. Adjust only controls covered by the operating instructions. Improper adjustment may require extensive work by an authorized service center.
 - E. If the unit has been dropped or physically damaged.
 - F. If the unit exhibits a distinct change in performance.
14. During thunderstorms, avoid using telephones except cordless types. There may be a remote risk of an electric shock from lightning.

15. Do not use this unit to report a gas leak, when in the vicinity of the leak.

SAVE THESE INSTRUCTIONS

CAUTION:

Installation

- Never install telephone wiring during a lightning storm.
- Never install telephone jacks in wet locations unless the jack is specifically designed for wet locations.
- Never touch uninsulated telephone wires or terminals unless the telephone line has been disconnected at the network interface.
- Use caution when installing or modifying telephone lines.
- Do not touch the plug with wet hands.

WARNING:

- To prevent the risk of fire or electrical shock, do not expose this product to rain or any type of moisture.
- Unplug this unit from power outlets if it emits smoke, an abnormal smell or makes unusual noise. These conditions can cause fire or electric shock. Confirm that smoke has stopped and contact an authorized service center.

For best performance

Environment

- Keep the unit away from electrical noise generating devices, such as fluorescent lamps and motors.
- The unit should be kept free from dust, high temperature and vibration.
- The unit should not be exposed to direct sunlight.
- Do not place heavy objects on top of the unit.
- When you leave the unit unused for a long period of time, unplug this unit from power outlet.
- The unit should be kept away from heat sources such as heaters, kitchen stoves, etc. Damp basements should also be avoided.

Routine care

- Wipe the outer surface of the unit with a soft cloth. Do not use benzine, thinner, or any abrasive powder.

1. Introduction and Installation

Accessories

- 1.1 Included accessories 6
- 1.2 Accessory information 6

Finding the Controls

- 1.3 Button descriptions 7
- 1.4 Overview 8

Installation

- 1.5 Ink film 8
- 1.6 Handset cord 10
- 1.7 Paper tray 10
- 1.8 Paper support 10
- 1.9 Recording paper 11

2. Preparation

Connections and Setup

- 2.1 Connections 12
- 2.2 Quick Setup 13

Help Button

- 2.3 Help function 13

Volume

- 2.4 Adjusting volume 13

Initial Programming

- 2.5 Date and time 14
- 2.6 Your logo 14
- 2.7 Your fax number 15

3. Telephone

Automatic Dialing

- 3.1 Storing names and telephone numbers into the phonebook 16
- 3.2 Making a phone call using the phonebook .. 16
- 3.3 Editing a stored item 16
- 3.4 Erasing a stored item 16
- 3.5 One touch dial 16

Caller ID

- 3.6 Caller ID service 17
- 3.7 Viewing and calling back 18
- 3.8 Caller ID number auto edit feature 18
- 3.9 Erasing caller information 18
- 3.10 Storing caller information into the phonebook 19

4. Fax

Sending Faxes

- 4.1 Sending a fax manually 20
- 4.2 Document requirements 21
- 4.3 Sending a fax using the phonebook and one touch dial 21
- 4.4 Broadcast transmission 22

Receiving Faxes

- 4.5 Selecting the way to use your fax machine . 23
- 4.6 Receiving a fax manually – Auto answer OFF 24

- 4.7 Receiving a fax automatically – Auto answer ON 24
- 4.8 Using the unit with an answering machine ... 25
- 4.9 Junk fax prohibitor (preventing fax reception from undesired callers) 26

5. Distinctive Ring

Distinctive Ring

- 5.1 Distinctive Ring service 27
- 5.2 Using two or more phone numbers on a single telephone line 27
- 5.3 Using three or more phone numbers on a single telephone line 27
- 5.4 Programming the ring pattern assigned for fax 27

6. Copy

Copying

- 6.1 Making a copy 28

7. Programmable Features

Features Summary

- 7.1 Programming 30
- 7.2 Basic features 31
- 7.3 Advanced features 32

8. Help

Error Messages

- 8.1 Error messages – Reports 36
- 8.2 Error messages – Display 37

Troubleshooting

- 8.3 When a function does not work, check here 38

9. Maintenance

Jams

- 9.1 Recording paper jams 43
- 9.2 Document jams 44

Cleaning

- 9.3 Document feeder/recording paper feeder/ scanner glass cleaning 45
- 9.4 Thermal head cleaning 46

10. General Information

Printed Reports

- 10.1 Reference lists and reports 47

Specifications

- 10.2 Specifications 47

FCC and Other Information

- 10.3 FCC and Other Information 49

Limited Warranty

- 10.4 Limited Warranty 51

Customer Services

- 10.5 Customer Services directory 53

11. Index

11.1 Index..... 54

1.1 Included accessories

- ① Telephone line cord
(PFJA02B002Y)*¹



- ② Handset
(PFJXN0341Z)*¹



- ③ Handset cord
(PQJA212M)*¹

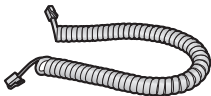

- ④ Paper tray
(PFKS1147Z2)*¹

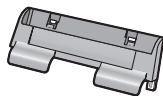

- ⑤ Paper support
(PFUS1704Z)*¹



- ⑥ Starter ink film
(10 meters long)



- ⑦ Operating instructions
(PFQX2559Z)*¹



- ⑧ Quick installation guide
(PFQW2492Z)*¹

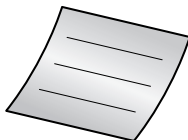

- ⑨ A4 paper guide
(PFKR1103Z2)*^{1*2}



*1 Part numbers are subject to change without notice.

*2 No need to install when using letter size paper.

Note:

- If any items are missing or damaged, contact the place of purchase.
- Save the original carton and packing materials for future shipping and transportation of the unit.

1.2 Accessory information

Accessories for this unit can be ordered online, by fax, or by telephone.

- **Replacement film*¹ (Model No./Part No. KX-FA91):** 25 m (82') × 2 rolls (Each roll will print about 80 letter-sized pages.)

*¹ To ensure the unit operates properly, we recommend using the Panasonic replacement film. **The ink film is not reusable. Do not rewind and use the ink film again.**

To place an order online (for customers in the U.S.A. ONLY)

Visit our web site:

<http://www.panasonic.com/kx-fa91>

- For questions regarding online orders:
E-mail: direct@us.panasonic.com
Telephone: 1-866-888-2929

To place an order by fax

Fax: 1-800-237-9080

Include:

- your name, shipping address and telephone number
- credit card type, number, expiration date and your signature
- part number and quantity

To place an order by telephone

Telephone: 1-800-332-5368

(Monday - Friday 9 am to 8 pm, EST.)

1.3 Button descriptions

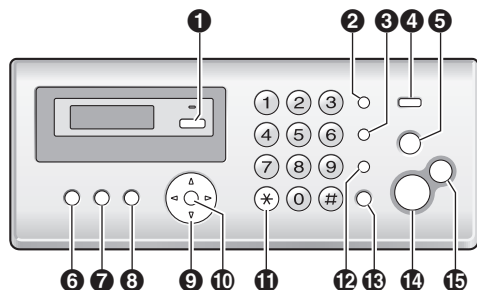

- 1 [AUTO ANSWER]**
- To turn the auto answer setting ON/OFF (page 24).
- 2 [REDIAL][PAUSE]**
- To redial the last number dialed.
 - To insert a pause during dialing.
- 3 [FLASH]**
- To access special telephone services or for transferring extension calls.
 - The flash time can be changed (feature #72 on page 34).
- 4 [CALLER ID]**
- To use Caller ID features (page 17).
- 5 [STOP]**
- To stop an operation or programming session.
 - To erase a character/number (page 14). Press and hold to erase all characters/numbers.
- 6 [BROADCAST]**
- To transmit a document to multiple parties (page 22).
- 7 [HELP]**
- To print helpful information for reference purposes (page 13).
- 8 [MENU]**
- To start or exit programming.
- 9 [PHONEBOOK][VOLUME]**
- To adjust volume (page 13).
 - To search for a stored item (page 16, 21).
- 10 [SET]**
- To store a setting during programming.
- 11 [TONE]**
- To change from pulse to tone temporarily during dialing when your line has rotary pulse service. You can also use tone dial service by changing feature #13 on page 31.
- 12 [MUTE]**
- To mute your voice during a conversation. Press again to resume the conversation.
- 13 [MONITOR]**
- To initiate dialing without lifting the handset.

When you press **[MONITOR]** during receiving a call, you will be able to hear the other party, but the other party will not be able to hear you.

- 14 [FAX START]**
- To send or receive a fax.
- 15 [COPY]**
- To copy a document (page 28).

1.4 Overview

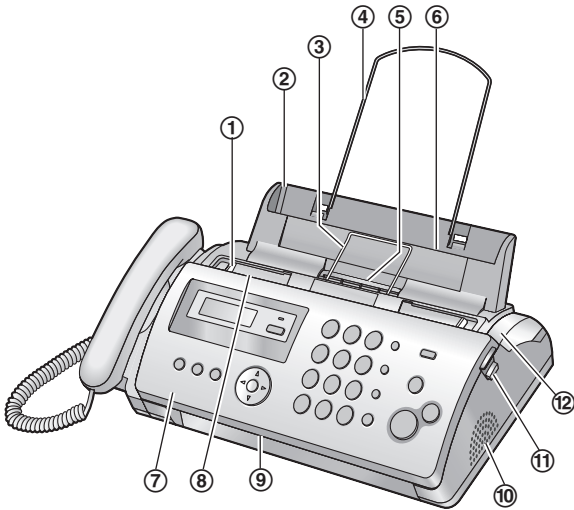

- ① Document guides
- ② Paper tray
- ③ Metal recording paper guide
- ④ Paper support
- ⑤ Recording paper exit
- ⑥ Recording paper entrance
- ⑦ Front cover
- ⑧ Document entrance
- ⑨ Document exit
- ⑩ Speaker
- ⑪ Green button (Back cover release button)
- ⑫ Back cover

Removing the shipping tape

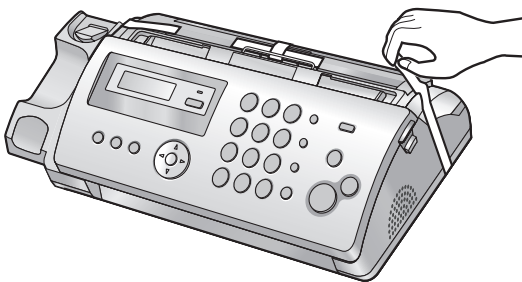

1.5 Ink film

The included film roll is a starter ink film.

- 1 Open the front cover.

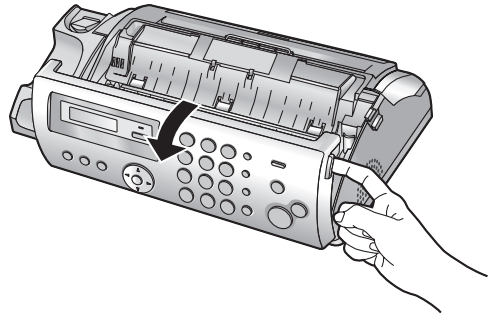

- 2 Release the back cover by pushing the green button (①).

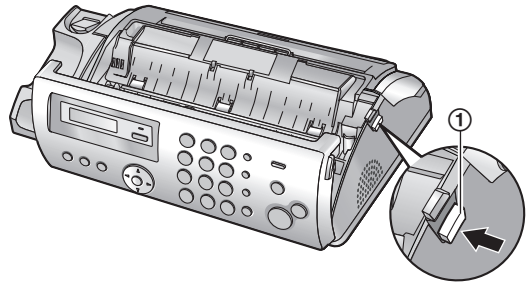

- 3 Open the back cover.

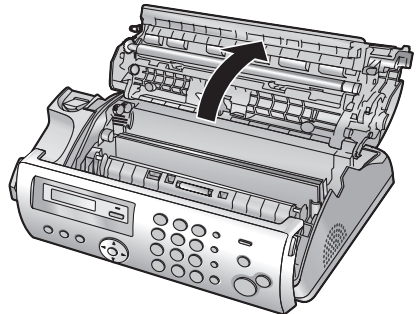

- 4 Insert the blue gear of the ink film roll into the front left slot of the unit (②) and the white gear of the ink film roll into the rear left slot of the unit (③).
 - The ink film is safe to touch and will not rub off on your hands like carbon paper.

- Make sure the blue gear (2) and white gear (3) are installed as shown.

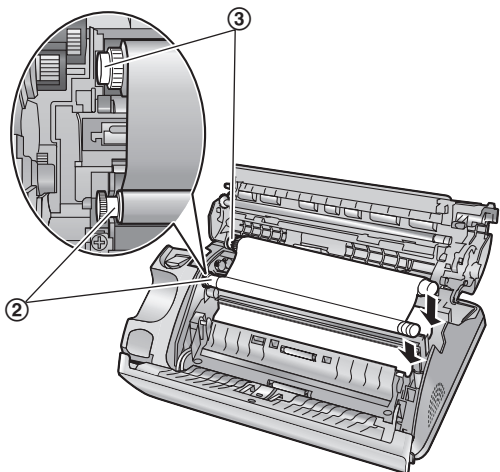

- 5 Turn the blue gear (4) in the direction of the arrow until the ink film is tight (5) and at least one layer of ink film is wrapped around the blue core (6).

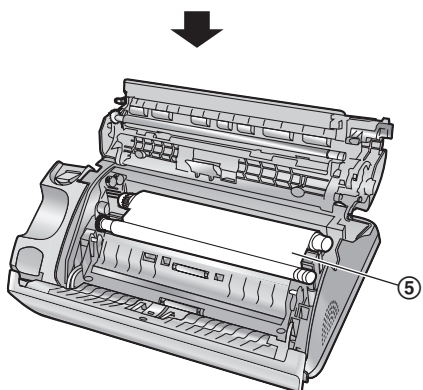
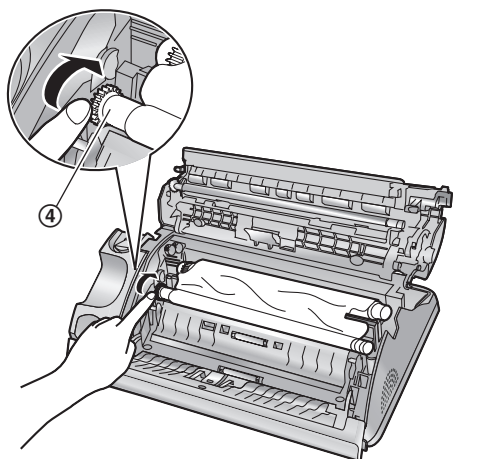

Correct

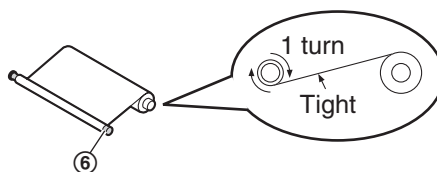

Incorrect

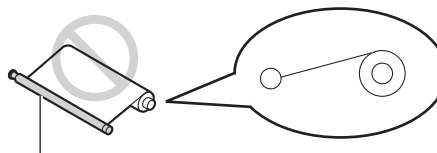

No ink film is wrapped around the blue core.

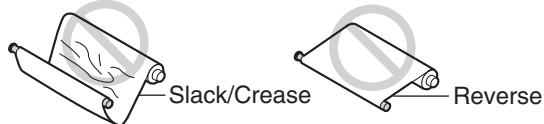

- 6 Close the back cover securely by pushing down on the dotted area at both ends (7).

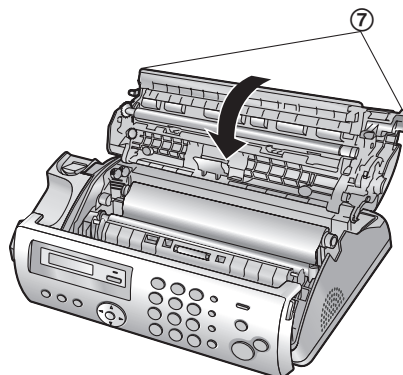

- 7 Close the front cover securely.

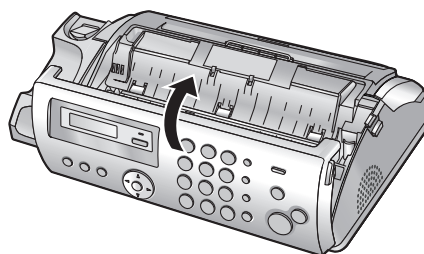

1.6 Handset cord

Connect the handset cord (①).



1.7 Paper tray

Pull up the metal recording paper guide (①), then install the paper tray (②).

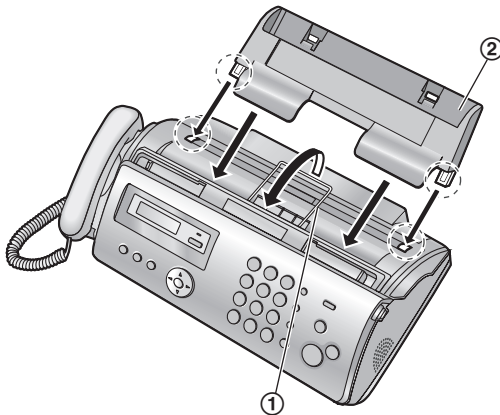

- Make sure the arrows on the paper tray and the unit match.

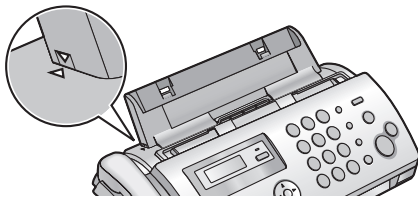

To use A4 size paper

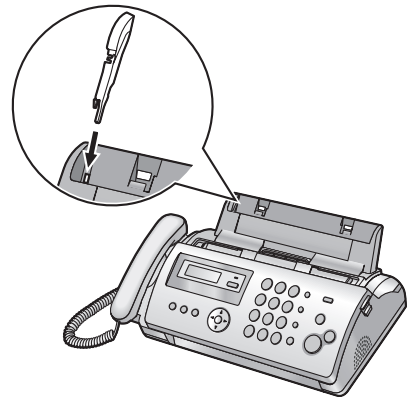

Note:

- When you use letter paper, you do not need to install the A4 paper guide.
- Change the recording paper size to “A4” (feature #16 on page 31).
- When you do not use the A4 paper guide, you can attach it to the back of the paper tray for storage.

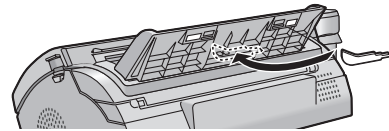

1.8 Paper support

Hold open the paper support (①), then insert the ends into the holes on the paper tray (②).

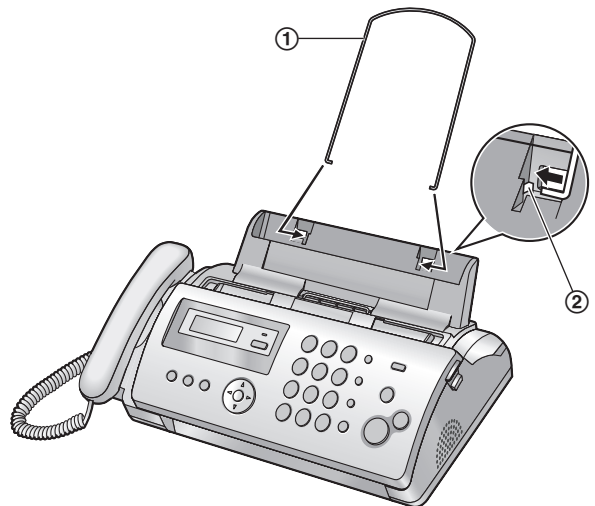

1.9 Recording paper

The unit can hold up to 20 sheets of 60 g/m² to 90 g/m² (16 lb. to 24 lb.) paper.

Please refer to page 48 for more information on recording paper.

For superior results, we recommend Hammermill® Jet Print paper.

- 1 Fan the paper to prevent paper jams.

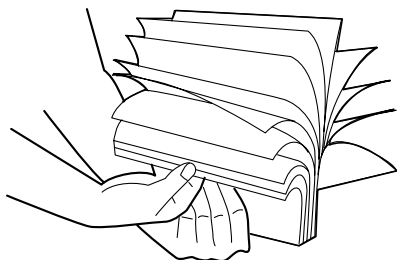

- 2 Insert the paper gently, print-side down (①).
 - Do not force the paper into the paper tray.

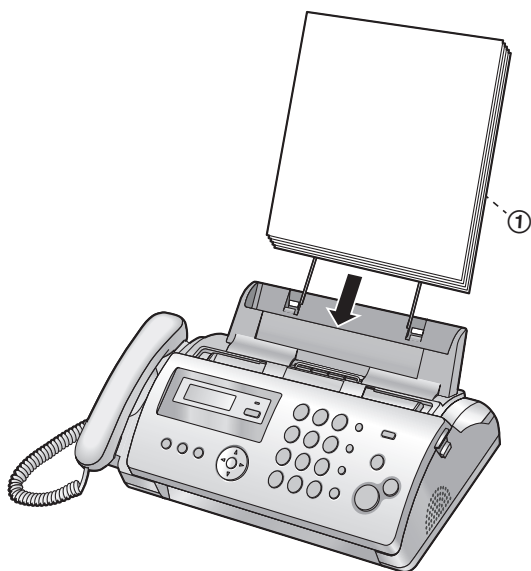

- If the paper is not inserted correctly, remove all of the installed paper, and re-install it gently. Otherwise the paper may jam.

Correct

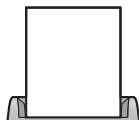

Slant



Note:

- Remove all of the installed paper before adding paper.

2.1 Connections

Caution:

- When you operate this product, the power outlet should be near the product and easily accessible.
- ① Telephone line cord
 - Connect to a single telephone line jack (RJ11).
 - ② Power cord
 - Connect to a power outlet (120 V, 60 Hz).
 - ③ [EXT] jack
 - You can connect an answering machine or a telephone. Remove the stopper if attached.
 - ④ Answering machine (not included)

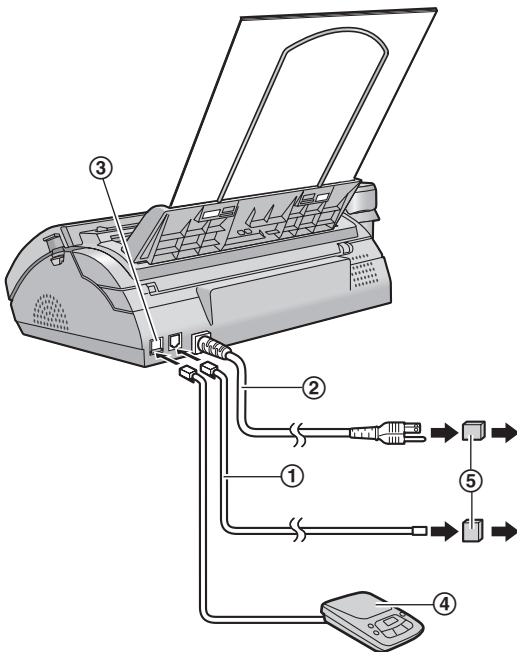

Note:

- To avoid malfunction, do not position the fax machine near appliances such as TVs or speakers which generate an intense magnetic field.
- If any other device is connected to the same telephone line, this unit may disturb the network condition of the device.

Using surge protectors

- The warranty does not cover damage due to power line surges or lightning. For additional protection, we recommend using surge protectors (⑥).

If the fax machine shares a single telephone line with a DSL service

Fax transmission/reception may be disturbed, noise interference may be heard during telephone conversations, or Caller ID (page 17) may not function properly. A filter to prevent this is provided by your

provider. Please attach the filter (⑥) to the telephone line cord of the unit.

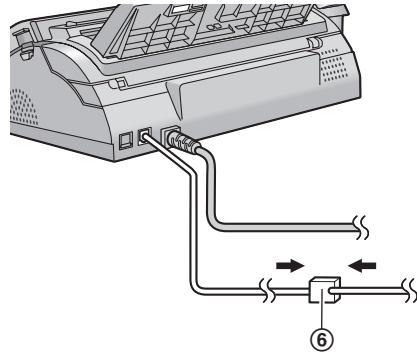

2.2 Quick Setup

You can print out the quick fax setup guide and select the desired receiving mode depending on your situation.

- [1] "FAX ONLY" (default): Use only as a fax (page 24).
- [2] "DIST. RING": With the Distinctive Ring service (page 27).
- [3] "EXT. TAM": With an external telephone answering machine (page 25).
- [4] "TEL ONLY": Mostly phone calls (page 24).

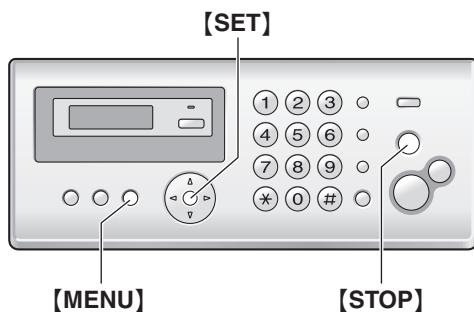

- 1 [MENU] → [#][0][0] → [SET]
- 2 Press [SET] again to print the quick fax setup guide.
 - If you do not wish to print it, press [STOP].
- 3 Press [1] to [4] to display the desired setting. → [SET] → [MENU]

2.3 Help function

The unit contains helpful information on the following topics which can be printed for reference purposes, as follows:

- "FILM ORDER SHEET"
- "BASIC SETTINGS"
- "FEATURE LIST"
- "FAX SND/RCV"
- "COPIER"
- "Q and A"
- "ERRORS"
- "REPORTS"
- "CALLER ID"

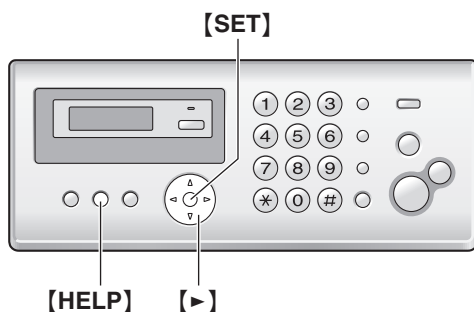

- 1 [HELP]
- 2 Press [▶] repeatedly to display the desired item. → [SET]

2.4 Adjusting volume

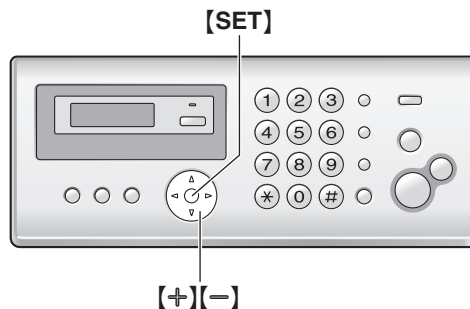

Ringer volume

While the unit is idle, press [+] or [-].

- If there are any documents in the document entrance, you cannot adjust the volume. Confirm that there are no documents in the entrance.

To turn the ringer OFF

Press [-] repeatedly to display "RINGER OFF= OK?". → [SET]

- The unit will not ring.
- To turn the ringer back ON, press [+].

Ringer tone

- You can select the ringer tone from one of 3 patterns (feature #17 on page 31).

Handset receiver volume

While using the handset, press [+] or [-].

Speaker volume

While using the monitor, press [+] or [-].

2.5 Date and time

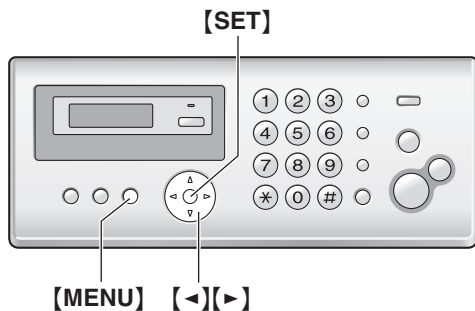

1 [MENU] → [#][0][1] → [SET]

M: 01/D: 01/Y: 06
TIME: 12:00AM

2 Enter the current month/date/year/hour/minute by selecting 2 digits for each.

Example: August 10, 2006 10:15 PM (12 hour clock format)

1. Press [0][8] [1][0] [0][6] [1][0] [1][5].

M: 08/D: 10/Y: 06
TIME: 10:15AM

2. Press [*] repeatedly to select "PM".

3 [SET]

4 Press [MENU] to exit.

Note:

- The other party's fax machine will print the date and time on the top of each page you send according to your unit's date and time setting.

To correct a mistake

Press [◀] or [▶] to move the cursor to the incorrect number, and make the correction.

If you have subscribed to a Caller ID service

The date and time will be automatically set according to the received caller information.

- If the time has not previously been set, Caller ID will not adjust the clock.
- You can turn this feature OFF (feature #33 on page 33).

2.6 Your logo

You can program your logo (name, company name, etc.) so that it appears on the top of each page sent.

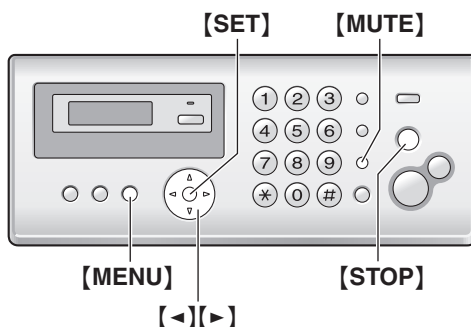

1 [MENU] → [#][0][2] → [SET]

LOGO=

2 Enter your logo, up to 30 characters. See the following character table for details. → [SET]

3 Press [MENU] to exit.

To select characters with the dial keypad

Keypad	Characters
[1]	& ' () , - . / 1
[2]	a b c A B C 2
[3]	d e f D E F 3
[4]	g h i G H I 4
[5]	j k l J K L 5
[6]	m n o M N O 6
[7]	p q r s P Q R S 7
[8]	t u v T U V 8
[9]	w x y z W X Y Z 9
[0]	0 (Space)
[*]	*
[#]	#
[MUTE]	To insert a space.
[STOP]	To delete a character.

Note:

- To enter a character that is located on the same dial key as the previously entered character, you must first press [▶] to move the cursor to the next space.

To enter your logo

Example: "BILL"

1. Press **[2]** 5 times.

LOGO=B

2. Press **[4]** 6 times.

LOGO=BI

3. Press **[5]** 6 times.

LOGO=BIL

4. Press **[▶]** to move the cursor to the next space and press **[5]** 6 times.

LOGO=BILL

To correct a mistake

Press **[◀]** or **[▶]** to move the cursor to the incorrect character, and make the correction.

- To erase all of the characters, press and hold **[STOP]**.

2.7 Your fax number

You can program your fax number so that it appears on the top of each page sent.

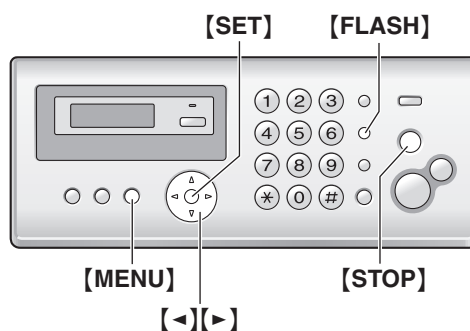

- 1 **[MENU]** → **[#][0][3]** → **[SET]**

NO. =

- 2 Enter your fax number, up to 20 digits.
 - To enter a "+", press **[*]**.
 - To enter a space, press **[#]**.
 - To enter a hyphen, press **[FLASH]**.
 - To erase a number, press **[STOP]**.

- 3 **[SET]**

- 4 Press **[MENU]** to exit.

To correct a mistake

Press **[◀]** or **[▶]** to move the cursor to the incorrect number, and make the correction.

- To erase all of the numbers, press and hold **[STOP]**.

3.1 Storing names and telephone numbers into the phonebook

The unit provides a phonebook (50 items).

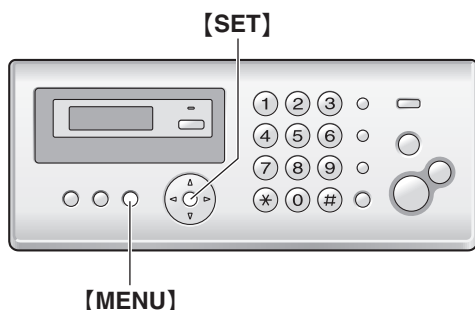

- 1 Press **[MENU]** repeatedly to display “PHONEBOOK SET”. → **[*]**
- 2 Enter the name, up to 16 characters (see page 14 for instructions). → **[SET]**
- 3 Enter the telephone number, up to 32 digits. → **[SET]**
 - To program other items, repeat steps 2 to 3.
- 4 **[MENU]**

Helpful hints:

- For your convenience, HELP-FAX (1-800-435-7329) has been stored in the phonebook. If you cannot solve a problem, call this number (page 16). If not needed, you can erase it (page 16).

3.2 Making a phone call using the phonebook

- 1 **[PHONEBOOK]**
- 2 Press **[+]** or **[-]** repeatedly to display the desired item.
- 3 Lift the handset.

To search for a name by initial

Example: “LISA”

- 1 **[PHONEBOOK]**
- 2 Press **[+]** or **[-]** to initiate the phonebook.
- 3 Press **[5]** repeatedly to display any name with the initial “L” (see the character table, page 14).
 - To search for symbols, press **[1]**, **[*]** or **[#]**.
- 4 Press **[-]** repeatedly to display “LISA”.
 - To stop the search, press **[STOP]**.
 - To dial the displayed number, lift the handset.

3.3 Editing a stored item

- 1 **[PHONEBOOK]**

- 2 Press **[+]** or **[-]** repeatedly to display the desired item. → **[MENU]**
- 3 **[*]**
 - If you do not need to edit the name, skip to step 5.
- 4 Edit the name. For further details, see the storing procedure on page 16.
- 5 **[SET]**
 - If you do not need to edit the telephone number, skip to step 7.
- 6 Edit the telephone number. For further details, see the storing procedure on page 16.
- 7 **[SET]**

3.4 Erasing a stored item

3.4.1 Erasing a specific item

1. **[PHONEBOOK]**
2. Press **[+]** or **[-]** repeatedly to display the desired item. → **[MENU]** → **[#]**
 - To cancel erasing, press **[STOP]**.
3. **[SET]**

3.4.2 Erasing all items

1. **[PHONEBOOK]** → **[MENU]**
2. Press **[+]** or **[-]** repeatedly to select “YES”. → **[SET]**
 - To cancel erasing, press **[STOP]**.
3. **[SET]**

3.5 One touch dial

Dial keys **[1]** to **[9]** can each be used as a one touch dial key, allowing you to dial a number from the phonebook by simply pressing a dial key.

3.5.1 Assigning an item to a one touch dial key

- 1 **[PHONEBOOK]**
- 2 Press **[+]** or **[-]** repeatedly to display the desired item. → **[MENU]** → **[0]**
- 3 Press **[+]** or **[-]** repeatedly to select a desired dial key.
 - When the dial key is already used as a one touch dial key, ✓ is displayed next to the dial key number. If you select this dial key, you can overwrite the previous assignment.
- 4 **[SET]** → **[SET]**
 - To program other items, repeat steps 2 to 4.
- 5 **[STOP]**

3.5.2 Making a call using a one touch dial key

- 1 Press and hold the desired one touch dial key ([1] to [9]).
 - You can view other one touch dial assignments by pressing [+] or [-].
- 2 Lift the handset.

3.5.3 Erasing a one touch dial assignment

- 1 Press and hold the desired one touch dial key ([1] to [9]). → [MENU]
 - To cancel erasing, press [STOP].
- 2 [SET]

Note:

- The number erased from a one touch dial key will not be deleted from the phonebook. To erase from the phonebook, see page 16.

3.6 Caller ID service

This unit is compatible with the Caller ID service offered by your local telephone company. To use this unit's Caller ID features, you must subscribe to a Caller ID service.

Make sure the following ring count is set to 2 or more rings beforehand.

- FAX ring count (feature #06 on page 31)
- The name display service may not be available in some areas. For further information, please contact your telephone company.

3.6.1 How Caller ID is displayed

The calling party's name or telephone number will be displayed after the 1st ring. You have the option of whether or not to answer the call.

The unit will automatically store caller information (name, telephone number, date and time of the call, the number of times called) from the 30 most recent callers. It is possible to view caller information one at a time on the display (page 18) or print the entire Caller ID list (page 47).

- When caller information is received and it matches a telephone number stored in the unit's phonebook, the stored name will be displayed.
- If the unit is connected to a PBX (Private Branch Exchange) system, caller information may not be received properly. Consult your PBX supplier.
- If the unit cannot receive caller information, the following will be displayed:
 - “OUT OF AREA”: The caller dialed from an area which does not provide Caller ID service.
 - “PRIVATE CALLER”: The caller requested not to send caller information.
 - “LONG DISTANCE”: The caller made a long distance call.

To confirm caller information using the Caller ID list

- To print manually, see page 47.
- To print automatically after every 30 new calls, activate feature #26 (page 32).

3.7 Viewing and calling back

The display will show the number of new calls in standby mode.

Example:

10 MISSED CALLS 10:59AM

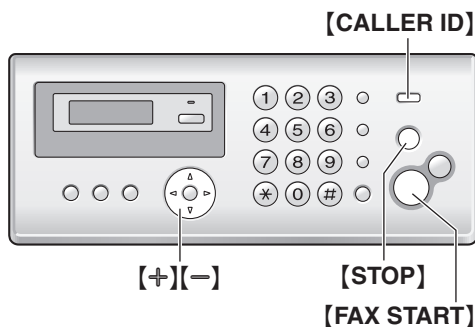

- 1 **[CALLER ID]**
- 2 Press **[−]** to search from the recently received caller information.
 - If you press **[+]**, the display order will be reversed.
- 3 Lift the handset to return the call.
 - To send a fax, insert the document FACE DOWN and press **[FAX START]**.

To change the way caller information is displayed

Press **[CALLER ID]** repeatedly after step 2.

Example:

SAM LEE 11:20A Jul.20 ✓
↓
1-134-567-8901 11:20A Jul.20 ✓

3.7.1 Symbols and operations for caller information

What “✓” means

“✓” on the display means the call has already been viewed or answered.

If the same person calls more than once

The number of times the same caller called (“×2” to “×9”) will be displayed. Only the date and time of the most recent call will be stored.

Example: The same person called 3 times.

SAM LEE 10:30P Jul.20 ×3

To stop viewing

Press **[STOP]**.

To edit a telephone number before calling back/storing

While displaying a desired caller information, press **[*]** repeatedly. Each time you press **[*]**, the telephone number will be changed as follows:

- 1 Local telephone number only (area code omitted)
- 2 Area code – Local telephone number
- 3 1 – Area code – Local telephone number (“1” added)
 - To return a call, lift the handset.
 - To store the number in the phonebook, follow from step 3 of the storing procedure on page 19.

3.8 Caller ID number auto edit feature

Once you call back an edited number, the unit can automatically edit other incoming phone numbers each time you receive a call.

For example, you can use this feature to set the unit to ignore the area code of callers in your area code, so that you can call these local numbers using caller information without dialing the area code.

To activate this feature, you must edit an item in the caller list, then call that number. After that, calls from that caller’s area code will be edited automatically.

The default setting is ON.

3.8.1 Turning ON the Caller ID number auto edit feature

- 1 **[MENU]** → **[#][7][5]**
- 2 Press **[1]** to select “ON”.
 - Press **[0]** to select “OFF”.
- 3 **[SET]** → **[MENU]**

Note:

- The unit can remember up to 4 area codes each to be edited. Phone numbers from the 4 most recently edited area codes will be automatically edited.
- This feature will not be activated until edited numbers are called back.
- If you move to another area, you can turn this feature OFF to erase previously edited area codes. To use this feature again, turn it ON and reprogram the area codes you want to edit once again.

3.9 Erasing caller information

3.9.1 Erasing all caller information

- 1 Press **[MENU]** repeatedly to display “CALLER SETUP”. → **[SET]**
 - “CALL LIST ERASE” will be displayed.
- 2 **[SET]**
 - To cancel erasing, press **[STOP]**, then **[MENU]**.
- 3 **[SET]** → **[STOP]**

3.9.2 Erasing specific caller information

- 1 [CALLER ID]
- 2 Press [+] or [-] repeatedly to display the desired item. → [◀] → [SET] → [STOP]

3.10 Storing caller information into the phonebook

- 1 [CALLER ID]
- 2 Press [+] or [-] repeatedly to display the desired item.
 - If the number requires editing, see page 18.
- 3 [MENU] → [SET] → [SET]

4.1 Sending a fax manually

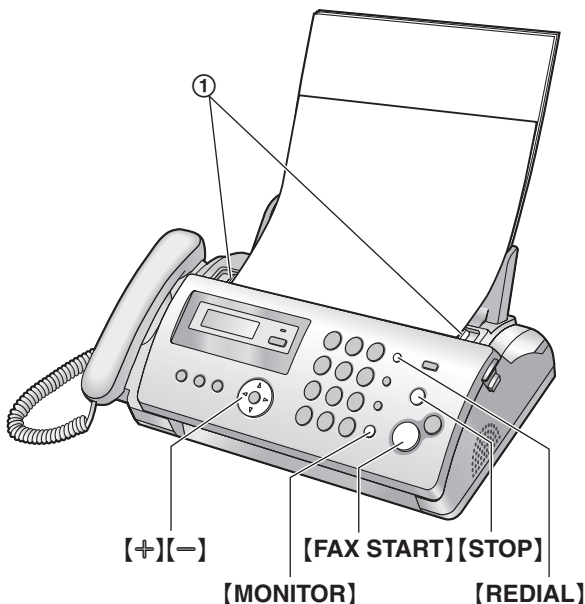

- 1 Adjust the width of the document guides (①) to fit the actual size of the document.
- 2 Insert the document (up to 10 pages) FACE DOWN until a single beep is heard and the unit grasps the document.
- 3 If necessary, press **[+]** or **[−]** repeatedly to select the desired resolution.
- 4 Press **[MONITOR]** or lift the handset.
- 5 Dial the fax number.
- 6 **When a fax tone is heard:**
Press **[FAX START]**.

When the other party answers your call:

Ask them to press their start button. When the fax tone is heard, press **[FAX START]**.

- If you pressed **[MONITOR]** in step 4, lift the handset before speaking.

To select the resolution

Select the desired resolution according to the character size.

- “**STANDARD**”: For normal-sized characters.
- “**FINE**”: For small-sized characters.
- “**SUPER FINE**”: For very small-sized characters.
- “**PHOTO**”: For photographs, shaded drawings, etc.
- Using the “**FINE**”, “**SUPER FINE**” and “**PHOTO**” settings will increase transmission time.

To redial the last number

[REDIAL] → **[FAX START]**

- If the line is busy, the unit will automatically redial the number.
- To cancel redialing, press **[STOP]**.

To send more than 10 pages at a time

Insert the first 10 pages of the document. Add the other pages (up to 10 at a time) on top of the previously inserted pages while the last page is being fed into the unit.

Pre-dialing a fax number

1. Enter the fax number.
2. Insert the document.
3. **[FAX START]**

Sending from memory (Quick scan feature)

To use this feature, activate feature #34 (page 33) beforehand.

1. Insert the document.
2. Enter the fax number. → **[FAX START]**
 - If the document exceeds the memory capacity, transmission will be canceled and this feature will be turned OFF automatically. You must send the entire document manually.
 - This feature cannot be used if the handset is in use or **[MONITOR]** is pressed.

To stop sending

Press **[STOP]**.

Printing a confirmation report

A confirmation report provides you with a printed record of transmission results (errors, etc.). To print confirmation reports, make sure feature #04 is activated (page 31). The default setting is “**ERROR**”. For an explanation of error messages, see page 36.

Printing a journal report

A journal report provides you with a printed record of the 30 most recent fax transmissions and receptions. To print it manually, see page 47. To print it automatically after every 30 new fax transmissions and receptions, make sure feature #22 is activated (page 32). For an explanation of error messages, see page 36.

4.2 Document requirements

Minimum document size

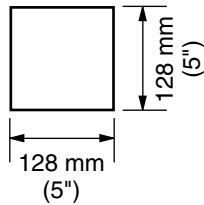

Maximum document size

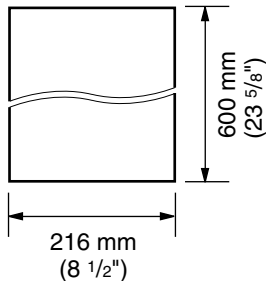

Effective scanning area

- Shaded area will be scanned.

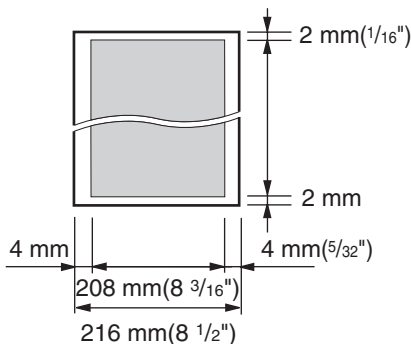

Document weight

- Single sheet:
45 g/m² to 90 g/m² (12 lb. to 24 lb.)
- Multiple sheets:
60 g/m² to 80 g/m² (16 lb. to 21 lb.)

Note:

- Remove clips, staples or other fasteners.
- Do not send the following types of documents: (Make a copy of the document using another copier and send the copy.)
 - Chemically treated paper such as carbon or carbonless duplicating paper
 - Electrostatically charged paper
 - Badly curled, creased or torn paper
 - Paper with a coated surface
 - Paper with a faint image
 - Paper with printing on the opposite side that can be seen through the other side, such as newsprint

- Check that ink, paste or correction fluid has dried completely.
- To send a document with a width of less than 210 mm (8 1/4"), we recommend using a copy machine to copy the original document onto A4 or letter-sized paper, then sending the copied document.

4.3 Sending a fax using the phonebook and one touch dial

Before using this feature, store the desired names and telephone numbers into the phonebook (page 16) and one touch dial (page 16).

- 1 Adjust the width of the document guides to fit the actual size of the document.
- 2 Insert the document (up to 10 pages) FACE DOWN until a single beep is heard and the unit grasps the document.
- 3 If necessary, press **[+]** or **[-]** repeatedly to select the desired resolution (page 20).

4 Using the phonebook:

1. **[PHONEBOOK]**
2. Press **[+]** or **[-]** repeatedly to display the desired item. → **[FAX START]**

Using one touch dial:

1. Press and hold the desired one touch dial key (**[1]** to **[9]**).
 - You can view other one touch dial assignments by pressing **[+]** or **[-]**.
2. **[FAX START]**

Fax auto redial

If the line is busy or if there is no answer, the unit will automatically redial the number.

- To cancel redialing, press **[STOP]**.

4.4 Broadcast transmission

By storing the phonebook items (page 16) into the broadcast memory, you can send the same document to multiple parties (up to 20). Your programmed items will remain in the broadcast memory, allowing frequent re-use.

4.4.1 Programming items into the broadcast memory

- 1 Press **[MENU]** repeatedly to display “**BROADCAST SET**”. → **[⇄]**
- 2 Press **[+]** or **[-]** repeatedly to display the desired item. → **[SET]**
 - The number in brackets indicates the number of registered items.
 - If you have programmed the wrong item, press **[STOP]** to erase the item.
 - To program other items, repeat step 2 (up to 20 items).
- 3 **[SET]**

4.4.2 Adding a new item into the broadcast memory

- 1 **[PHONEBOOK]**
- 2 Press **[+]** or **[-]** repeatedly to display “**<BROADCAST>**”. → **[MENU]** → **[*]**
- 3 Press **[+]** or **[-]** repeatedly to display the desired item. → **[SET]**
 - To add other items, repeat step 3 (up to 20 items).
- 4 **[STOP]**

4.4.3 Erasing a stored item from the broadcast memory

- 1 **[PHONEBOOK]**
- 2 Press **[+]** or **[-]** repeatedly to display “**<BROADCAST>**”. → **[MENU]** → **[⇄]**
- 3 Press **[+]** or **[-]** repeatedly to display the desired item you want to erase.
 - To cancel erasing, press **[STOP]**.
- 4 **[SET]** → **[SET]** → **[STOP]**

4.4.4 Sending the same document to pre-programmed parties

- 1 Insert the document **FACE DOWN**.
- 2 If necessary, press **[+]** or **[-]** repeatedly to select the desired resolution (page 20).
- 3 **[BROADCAST]**
 - After transmission, the unit will automatically print a report (**Broadcast sending report**).

Note:

- If you select “**FINE**”, “**SUPER FINE**” or “**PHOTO**” resolution, the number of pages that the unit can send will decrease.
- If the document exceeds the memory capacity, transmission will be canceled.
- If a party is busy or does not answer, it will be skipped and redialed later.

To send the same document to a one-time group of items

1. Insert the document. → **[PHONEBOOK]**
2. Press **[+]** or **[-]** repeatedly to display “**<ONE TIME BROAD>**”. → **[SET]**
3. Press **[+]** or **[-]** repeatedly to display the desired party. → **[SET]**
 - If you have programmed the wrong item, press **[STOP]** to erase the item.
 - To program other parties, repeat step 3 (up to 20 items).
4. Press **[FAX START]** to start transmission to the programmed parties.

To cancel broadcast transmission

Press **[STOP]** repeatedly to display “**SEND CANCELED?**”. → **[SET]**

4.5 Selecting the way to use your fax machine

Depending on your situation, select the way you prefer to use your fax machine.

- Use only as a fax (FAX ONLY mode)
- Use mostly as a telephone (TEL mode)
- Use with answering machine

Note:

- See page 13 for quick setup.

4.5.1 Use only as a fax (FAX ONLY mode)

Your situation

You have a separate telephone line just for faxes.

Setup

Set the fax machine to FAX ONLY mode (page 24) by pressing **[AUTO ANSWER]** repeatedly.

- The **[AUTO ANSWER]** indicator turns ON.

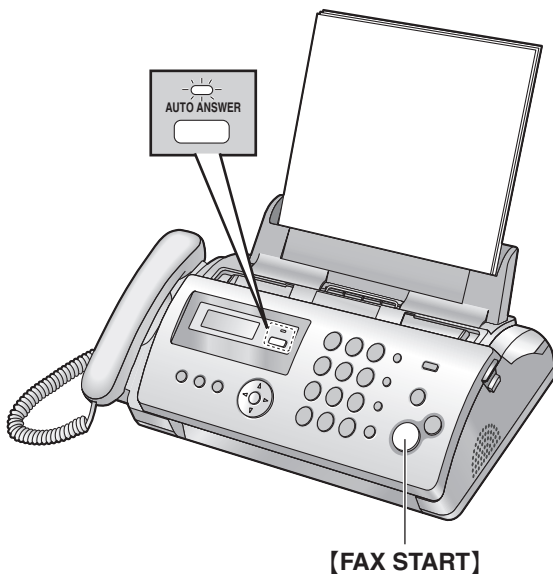

How faxes are received

All incoming calls will be answered as faxes.

4.5.2 Use mostly as a telephone (TEL mode)

Your situation

You want to answer calls by yourself. If a fax call is received, you must receive the fax manually.

Setup

Set the fax machine to TEL mode (page 24) by pressing **[AUTO ANSWER]** repeatedly.

- The **[AUTO ANSWER]** indicator turns OFF.



How to receive phone calls and faxes

You have to answer all calls manually.

To receive a fax, press **[FAX START]**.

4.5.3 Use with answering machine

Your situation

You want to use the fax machine with an answering machine.

Setup

Connect an external telephone answering machine (page 25) and set the ring count of the answering machine to less than 4.

- Set the ring count in FAX ONLY mode of the fax machine to "5 EXT. TAM" (feature #06 on page 31), if you use with auto answer ON.

How to receive calls

If the call is a phone call, the answering machine will record voice messages.

If a fax calling tone is detected, the fax machine will receive a fax automatically.

4.6 Receiving a fax manually – Auto answer OFF

Note:

- By default, the unit reduces the size of the received document to 92 % when printing (See feature #36 on page 33 for details).

4.6.1 Activating TEL mode

Set the fax machine to TEL mode by pressing **[AUTO ANSWER]** repeatedly to display “**TEL MODE**”.

- The **[AUTO ANSWER]** indicator turns OFF.



Note:

- If you do not answer the call within 10 rings, the unit will temporarily switch to fax reception. The other party can then send a fax.

How to receive phone calls and faxes

1. Lift the handset to answer the call.
2. When:
 - document reception is required,
 - a fax calling tone (slow beep) is heard, or
 - no sound is heard,press **[FAX START]**.
3. Replace the handset.

To stop receiving

Press **[STOP]**.

How to receive faxes with an extension telephone

1. When the extension telephone rings, lift the handset of the extension telephone.
2. When:

- document reception is required,
- a fax calling tone (slow beep) is heard, or
- no sound is heard,

press **[*][#][9]** (default fax activation code) **firmly**.

3. Replace the handset.

Note:

- To receive fax documents using the extension telephone, make sure remote fax activation is turned ON (feature #41 on page 34) beforehand. The default setting is ON.

4.7 Receiving a fax automatically – Auto answer ON

4.7.1 Activating FAX ONLY mode

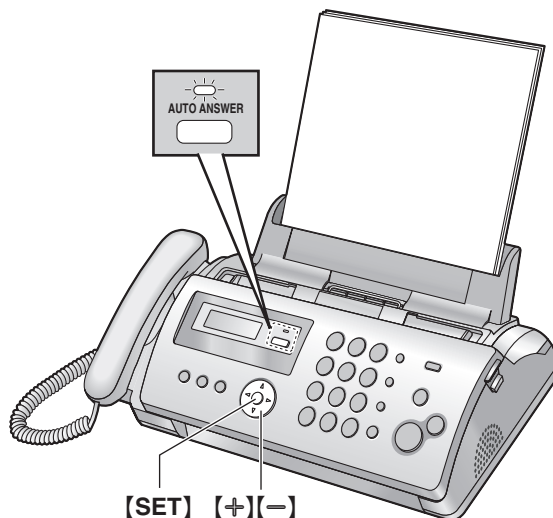

Press **[AUTO ANSWER]** repeatedly to display “**FAX ONLY MODE**”.

- The display will show the ring count in FAX ONLY mode. If you wish to change it, press **[+]** or **[-]** repeatedly to display the desired setting, and press **[SET]**. If you set to more than 3, receiving faxes may not be possible.
- The **[AUTO ANSWER]** indicator turns ON.

How faxes are received

When receiving calls, the unit will automatically answer all calls and only receive fax documents.

4.8 Using the unit with an answering machine

4.8.1 Setting up the unit and an answering machine

- 1 Connect the answering machine (①).
 - Answering machine is not included.
 - Remove the stopper (②) if attached.

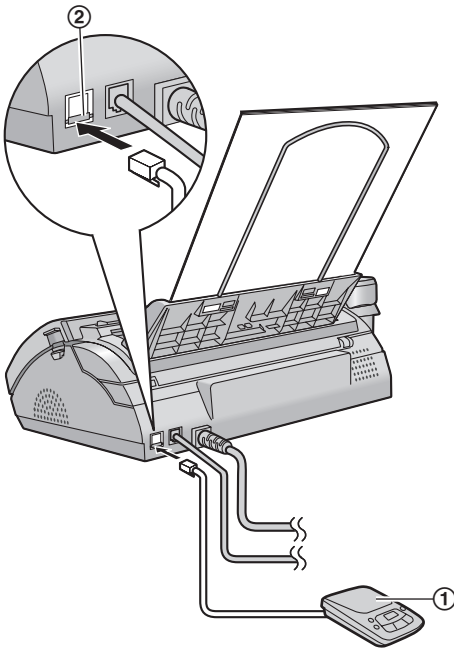

- 2 Set the number of rings on the answering machine to less than 4.
 - This will allow the answering machine to answer the call first.
- 3 Record a greeting message on the answering machine.
 - We recommend you record a message up to 10 seconds long, and not to pause for more than 4 seconds during the message. Otherwise, both machines will not function correctly.
- 4 Activate the answering machine.
- 5 Set the unit to the desired receiving mode (page 24).
 - If you set to FAX ONLY mode, **change the ring setting in FAX ONLY mode to "5 EXT. TAM" (feature #06 on page 31).**
- 6 Check all or part of the following are not the same:
 - the remote access code of the answering machine
 - the fax activation code (feature #41 on page 34)
 - remote access to Phone Companies Voice Mail (if you subscribed)

Note:

- If the call is a phone call, the answering machine will record voice messages.
If a fax calling tone is detected, the fax machine will receive a fax automatically.

Receiving a voice message and fax document in one call

The caller can leave a voice message and send a fax document during the same call. Inform the caller of the following procedure beforehand.

1. The caller calls your unit.
 - The answering device will answer the call.
2. The caller can leave a message after the greeting message.
3. The caller presses **[*][#][9]** (pre-selected fax activation code).
 - The unit will activate the fax function.
4. The caller presses the start button to send a document.

Note:

- To use this feature, make sure remote fax activation is turned ON (Feature #41 on page 34). The fax activation code can also be changed.
- If there is no room left in memory of your answering machine, the unit may not be able to receive documents. See the operating instructions of the answering machine and erase unnecessary messages.

4.9 Junk fax prohibitor (preventing fax reception from undesired callers)

If you subscribe to Caller ID service (page 17), this feature prevents fax reception from calls that do not show caller information.

Additionally, the fax machine will not accept faxes originated from numbers that match the one on a programmable junk fax prohibitor list.

Important:

- This feature does not work when manual reception is performed.

4.9.1 Activating the junk fax prohibitor

- 1 Press **[MENU]** repeatedly to display “**JUNK FAX PROH.**” → **[▶]**
- 2 Press **[+]** or **[-]** repeatedly to select “**ON**”. → **[SET]**
- 3 Press **[MENU]** to exit the program.

4.9.2 Storing undesired callers

You can register up to 10 undesired numbers from the Caller ID list (page 17) if you do not wish to receive faxes from them.

- 1 Press **[MENU]** repeatedly to display “**JUNK FAX PROH.**”.
- 2 Press **[▶]** repeatedly to display “**JUNK LIST SET**”. → **[SET]**
- 3 Press **[+]** or **[-]** repeatedly to display the item you wish to prevent the fax reception from. → **[SET]**
- 4 Press **[STOP]** to exit the program.

To display the junk fax prohibitor list

1. Press **[MENU]** repeatedly to display “**JUNK FAX PROH.**”.
2. Press **[▶]** repeatedly to display “**JUNK LIST DISP.**”. → **[SET]**
3. Press **[+]** or **[-]** to display the item.
4. Press **[MENU]** to exit the program.

To print the junk fax prohibitor list

1. Press **[MENU]** repeatedly to display “**JUNK FAX PROH.**”.
2. Press **[▶]** repeatedly to display “**JUNK LIST PRINT**”. → **[SET]**
3. Press **[MENU]** to exit the list.

To erase an item from the junk fax prohibitor list

1. Press **[MENU]** repeatedly to display “**JUNK FAX PROH.**”.

2. Press **[▶]** repeatedly to display “**JUNK LIST DISP.**”. → **[SET]**
3. Press **[+]** or **[-]** repeatedly to display the desired item. → **[◀]**
 - To cancel erasing, press **[STOP]**, then press **[MENU]**.
4. **[SET]** → **[MENU]**

5.1 Distinctive Ring service

When a call is made to one of your phone numbers, the telephone company sends a ring pattern to your telephone line to indicate which number the call is intended for. By setting up this unit for Distinctive Ring, you can make the fax machine automatically start fax reception when a call comes to the fax number.

To use this service, you must subscribe to the Distinctive Ring service offered by your local telephone company. Confirm your local telephone company for availability.

5.2 Using two or more phone numbers on a single telephone line

5.2.1 Activating the Distinctive Ring feature

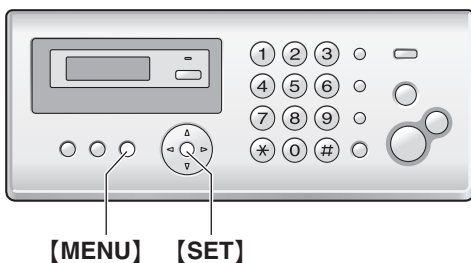

- 1 **[MENU]** → **[*][3][1]**
- 2 Press **[1]** to select "ON".
 - Press **[0]** to select "OFF".
- 3 **[SET]**
 - The **[AUTO ANSWER]** indicator turns ON.
- 4 **[MENU]**

Note:

- While the Distinctive Ring feature is activated, you cannot change the receiving mode.

How phone calls and faxes are received

If the incoming call is for the fax number, the fax machine will ring with the assigned ring pattern and automatically start fax reception.

If the incoming call is for the phone number, the fax machine will keep on ringing.

- If an external telephone answering machine is connected, set the ring count of the answering machine to more than 2.





5.3 Using three or more phone numbers on a single telephone line

You may wish to use three or more phone numbers for a single telephone line. In order to distinguish which number the call was addressed to, a different ring pattern must be assigned for each number.

Example: Using three phone numbers

Telephone number	Ring pattern	Use
012 1234	Standard ring	Personal
012 5678	Double ring	Business
012 9876	Triple ring	Fax

To use one phone number for the fax, program the ring pattern assigned for the fax in feature #32 (page 27). In the example, the ring pattern assigned for fax is a triple ring, so you should program "c" (triple ring).

Ring pattern	Selection
Standard ring (one long ring)  1st ring 2nd ring	[1] "A"
Double ring (two short rings)  1st ring 2nd ring	[2] "B"
Triple ring (short-long-short rings)  1st ring 2nd ring	[3] "C"
Other triple ring (short-short-long rings)  1st ring 2nd ring	[4] "D"

Note:

- The default setting is **[5]** "B-D". The fax will respond to all calls with ring tone patterns "B", "C" and "D".

5.4 Programming the ring pattern assigned for fax

- 1 Set feature #31 to "ON" (page 27).
- 2 **[MENU]** → **[*][3][2]**
- 3 Press **[1]** to **[5]** to select the ring pattern assigned for fax. → **[SET]** → **[MENU]**

6.1 Making a copy

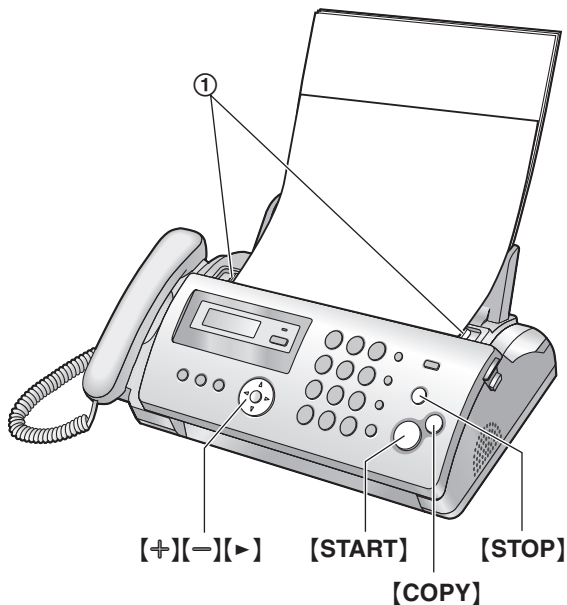

- 1 Adjust the width of the document guides (①) to fit the actual size of the document.
- 2 Insert the document (up to 10 pages) FACE DOWN until a single beep is heard and the unit grasps the document.
- 3 If necessary, press **[+]** or **[-]** repeatedly to select the desired resolution.
 - If you select “**STANDARD**”, copying will be performed using “**FINE**” mode.
- 4 **[COPY]**
 - If necessary, enter the number of copies (up to 20).
- 5 Press **[START]**, or wait for 15 seconds.
 - The unit will start copying.

Note:

- Any document which can be sent as a fax can also be copied (page 21).

To select the resolution

Select the desired resolution according to the character size.

- “**FINE**”: For small-sized characters.
- “**SUPER FINE**”: For very small-sized characters.
- “**PHOTO**”: For photographs, shaded drawings, etc.

Copying from memory (Quick scan feature)

This feature is helpful when you want to copy the document, then remove it for other uses. To use this feature, activate feature #34 (page 33) beforehand. The default setting is OFF.

- If the document exceeds the memory capacity, copying of the exceeded document will be canceled and this feature will be turned OFF automatically.

To stop copying

Press **[STOP]**.

6.1.1 More copying features

To enlarge a document

1. Insert the document.
2. **[COPY]** → **[>]**
3. Press **[+]** repeatedly to select “150%” or “200%”. → **[START]**
 - The unit will enlarge the center of the upper part of the document. To make an enlarged copy of the bottom of the document, turn the document around, and then make a copy.

Example: 150 % enlarged copy

Original document

Enlarged copy

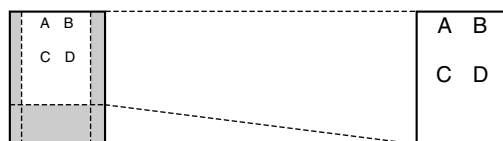

To reduce a document

1. Insert the document.
2. **[COPY]** → **[>]**
3. Press **[-]** repeatedly to select “92%”, “86%” or “72%”, then press **[START]**.

Setting	Recording paper size	Original document size
“100%” (default)	Letter	Letter
	A4	A4, Letter
“92%”	Letter	A4
“86%”	Letter	A4
“72%”	Letter	Legal
	A4	Legal

Note:

- If the image at the bottom of the document is not copied when you copy a document that is the same length as the recording paper, try 92 % or 86 %.

To collate multiple copies

The unit can collate multiple copies in the same order as the original document pages.

1. Insert the document.
2. **[COPY]**
3. Enter the number of copies (up to 20).
4. Press **[>]** 2 times to display “**COLLATE OFF**”.

5. Press **[+]** or **[-]** repeatedly to display “**COLLATE ON**”. → **[START]**

Example: Making 2 copies of a 4-page original document

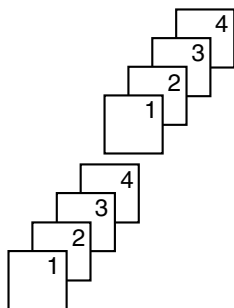

Collated pages

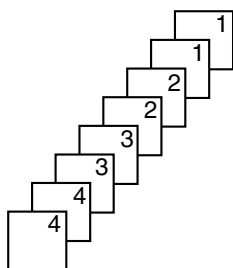

Uncollated pages

Note:

- The unit will store the documents into memory while collating the copies. If memory becomes full while storing, the unit will only print out the stored pages.

7.1 Programming



[MENU] **[SET]**

- 1 [MENU]**
- 2** Press **[#]** and the 2-digit code.
- 3** Press the desired command to display the desired setting.
 - This step may be slightly different depending on the feature.
- 4 [SET]**
- 5** To exit programming, press **[MENU]**.

7.2 Basic features

Feature	Feature code	Selection
Setting the quick setup	【#】[0][0]	<p>[1] "FAX ONLY" (default)</p> <p>[2] "DIST. RING"</p> <p>[3] "EXT. TAM"</p> <p>[4] "TEL ONLY"</p> <p>See page 13 for details.</p>
Setting the date and time	【#】[0][1]	Enter the date and time using the dial keypad. See page 14 for details.
Setting your logo	【#】[0][2]	Enter your logo using the dial keypad. See page 14 for details.
Setting your fax number	【#】[0][3]	Enter your fax number using the dial keypad. See page 15 for details.
Printing a confirmation report	【#】[0][4]	<p>[0] "OFF": Confirmation reports will not be printed.</p> <p>[1] "ON": A confirmation report will be printed after every fax transmission.</p> <p>[2] "ERROR" (default): A confirmation report will be printed only when a fax transmission fails.</p>
Changing the ring count in FAX ONLY mode	【#】[0][6]	<p>[1] "1"</p> <p>[2] "2"</p> <p>[3] "3" (default)</p> <p>[4] "4"</p> <p>[5] "5 EXT. TAM" (External Telephone Answering Machine)</p>
Setting the dialing mode	【#】[1][3]	<p>If you cannot make calls, change this setting according to your telephone line service.</p> <p>[1] "PULSE": For rotary pulse dial service.</p> <p>[2] "TONE" (default): For tone dial service.</p>
Setting the recording paper size	【#】[1][6]	<p>[1] "LETTER" (default): Letter size paper.</p> <p>[2] "A4": A4 size paper.</p>
Setting the ringer tone	【#】[1][7]	<p>[1] "TONE 1" (default)</p> <p>[2] "TONE 2"</p> <p>[3] "TONE 3"</p>

7.3 Advanced features

Feature	Feature code	Selection
Setting the journal report to print automatically	[*][2][2]	<p>[0] “OFF”: The unit will not print a journal report, but will keep a record of the last 30 fax transmissions and receptions.</p> <p>[1] “ON” (default): The unit will print a journal report automatically after every 30 new fax transmissions and receptions (page 20).</p>
Sending documents overseas	[*][2][3]	<p>If you cannot send a fax overseas even if the number is correct and the line is connected, activate this feature before sending the fax.</p> <p>This feature improves the reliability by reducing the transmission speed.</p> <p>[0] “OFF”: Deactivates this feature.</p> <p>[1] “NEXT FAX”: This setting is effective only for the next attempted fax transmission. After transmission, the unit will return to the previous setting.</p> <p>[2] “ERROR” (default): When the previous fax transmission fails and you wish to re-send the document.</p> <p>Note:</p> <ul style="list-style-type: none"> • Calling charges may be higher than usual.
Sending a fax at a specified time	[*][2][5]	<p>This feature allows you to take advantage of low-cost calling hours offered by your telephone company. This feature can be set up to 24 hours in advance of the desired time.</p> <p>[0] “OFF” (default)</p> <p>[1] “ON”</p> <p>To send a document:</p> <ol style="list-style-type: none"> 1. Insert the document. 2. If necessary, press [+] or [-] repeatedly to select the desired resolution (page 20). 3. [MENU] → [*][2][5] 4. Press [1] to select “ON”. → [SET] 5. Enter the fax number. → [SET] 6. Enter the transmission start time. <ul style="list-style-type: none"> • Press [*] repeatedly to select “AM” or “PM”. 7. [SET] → [MENU] <p>Note:</p> <ul style="list-style-type: none"> • To cancel after programming, press [STOP] then [SET].
Setting the Caller ID list to print automatically	[*][2][6]	<p>[0] “OFF” (default): The Caller ID list will not be printed automatically, but the unit will keep a record of the information for the last 30 different callers.</p> <p>[1] “ON”: The Caller ID list will be printed automatically each time the unit logs 30 different callers (page 17).</p>
Activating the Distinctive Ring feature	[*][3][1]	<p>[0] “OFF” (default)</p> <p>[1] “ON”</p> <p>See page 27 for details.</p>
Setting the ring pattern for fax (Distinctive Ring feature)	[*][3][2]	<p>[1] “A”</p> <p>[2] “B”</p> <p>[3] “C”</p> <p>[4] “D”</p> <p>[5] “B-D” (default)</p> <p>See page 27 for details.</p>

Feature	Feature code	Selection																			
Setting the time adjustment	[F3][3]	Using this feature, the unit's date and time setting will be automatically adjusted when caller information is received. [0] "MANUAL" : Deactivates this features. [1] "AUTO" (default): The date and time setting will be automatically adjusted.																			
Setting the quick scan	[F3][4]	This feature is helpful when you want to remove the document for other uses, because the unit will release the document before sending or copying. [0] "OFF" (default): Deactivates this feature. [1] "ON" : The unit will scan the document and store it into memory first, then the unit will start sending or copying the documents. Note: <ul style="list-style-type: none"> If the document exceeds the memory capacity, sending of the whole document or copying of the exceeded document will be canceled and this feature will be turned OFF automatically. 																			
Receiving oversized documents	[F3][6]	If the size of the document sent by the other party is as large as or larger than the recording paper, the unit can reduce the document and print it. Select the desired reduction rate. [1] "72%" [2] "86%" [3] "92%" (default) [4] "100%" <table border="1" data-bbox="635 929 1273 1271"> <thead> <tr> <th>Setting</th> <th>Recording paper size</th> <th>Original document size</th> </tr> </thead> <tbody> <tr> <td>"100%"</td> <td>A4</td> <td>Letter</td> </tr> <tr> <td rowspan="2">"92%" (default)</td> <td>Letter</td> <td>Letter</td> </tr> <tr> <td>A4</td> <td>A4</td> </tr> <tr> <td>"86%"</td> <td>Letter</td> <td>A4</td> </tr> <tr> <td rowspan="2">"72%"</td> <td>Letter</td> <td>Legal</td> </tr> <tr> <td>A4</td> <td>Legal</td> </tr> </tbody> </table> Note: <ul style="list-style-type: none"> The information of the sending party is printed on the top of each page. Therefore, even if the original document is the same size as the recording paper, the document will be divided into 2 sheets when printed at "100%". Select "92%" to print on 1 sheet. 	Setting	Recording paper size	Original document size	"100%"	A4	Letter	"92%" (default)	Letter	Letter	A4	A4	"86%"	Letter	A4	"72%"	Letter	Legal	A4	Legal
Setting	Recording paper size	Original document size																			
"100%"	A4	Letter																			
"92%" (default)	Letter	Letter																			
	A4	A4																			
"86%"	Letter	A4																			
"72%"	Letter	Legal																			
	A4	Legal																			
Changing the LCD display contrast	[F3][9]	[1] "NORMAL" (default) [2] "DARKER"																			

7. Programmable Features

Feature	Feature code	Selection
Changing the fax activation code	[*][4][1]	<p>If you wish to use an extension telephone (page 24) to receive faxes, activate this feature and program the activation code.</p> <p>[0] "OFF" [1] "ON" (default)</p> <ol style="list-style-type: none"> [MENU] → [*][4][1] Press [1] to select "ON". → [SET] Enter your code from 2 to 4 digits, using 0-9, [*] and [#]. <ul style="list-style-type: none"> The default code is *#9. [SET] → [MENU]
Setting the memory reception alert	[*][4][4]	<p>To alert you with a beeping sound when a received fax document is stored into memory due to some existing problem.</p> <p>[0] "OFF": Deactivates this feature. [1] "ON" (default): You will hear a beeping sound.</p> <p>Note:</p> <ul style="list-style-type: none"> The slow beeps will continue until you clear the printing problem and make sure the unit is supplied with enough paper to print the stored document.
Setting friendly reception	[*][4][6]	<p>To receive a fax automatically when you answer a call and hear a fax calling tone (slow beep).</p> <p>[0] "OFF": You have to press [FAX START] for fax reception. [1] "ON" (default): You do not have to press [FAX START] for fax reception.</p>
Setting flash time	[*][7][2]	<p>The flash time depends on your telephone exchange or host PBX.</p> <p>[1] "700ms" (default) [2] "600ms" [3] "400ms" [4] "300ms" [5] "250ms" [6] "110ms" [7] "100ms" [8] "90ms"</p> <p>Note:</p> <ul style="list-style-type: none"> If the unit is connected via a PBX, this setting may need to be changed in order for PBX functions (transferring a call, etc.) to work correctly. Consult your PBX supplier for the correct setting.
Setting the Caller ID number auto edit feature	[*][7][5]	<p>[0] "OFF" [1] "ON" (default)</p> <p>See page 18 for details.</p>
Setting the connecting tone	[*][7][6]	<p>If you often have trouble when sending faxes, this feature allows you to hear connecting tones: fax tone, ring back tone and busy tone. You can use those tones to confirm the status of the other party's machine.</p> <p>[0] "OFF": Deactivates this feature. [1] "ON" (default): You will hear connecting tones.</p> <p>Note:</p> <ul style="list-style-type: none"> If the ring back tone continues, the other party's machine may not be a fax machine or may have run out of paper. Check with the other party. The connecting tone volume cannot be adjusted.

Feature	Feature code	Selection
Resetting advanced features to their default settings	[#][8][0]	[0] “NO” (default) [1] “YES” To reset the advanced features: 1. [MENU] → [#][8][0] 2. Press [1] to select “YES”. → [SET] → [SET] → [MENU]

8.1 Error messages – Reports

If a problem occurs during fax transmission or reception, one of the following messages will be printed on the confirmation and journal reports (page 20).

Message	Code	Cause & Solution
COMMUNICATION ERROR	40-42 46-72 FF	<ul style="list-style-type: none"> ● A transmission or reception error occurred. Try again or check with the other party.
	43 44	<ul style="list-style-type: none"> ● A line problem occurred. Connect the telephone line cord to a different jack and try again. ● An overseas transmission error occurred. Try using the overseas mode (feature #23 on page 32).
DOCUMENT JAMMED	-----	<ul style="list-style-type: none"> ● Remove the jammed document (page 44).
ERROR-NOT YOUR UNIT	53 54 59 70	<ul style="list-style-type: none"> ● A transmission or reception error occurred because of a problem with the other party's fax machine. Check with the other party.
JUNK FAX PROH. REJECT	-----	<ul style="list-style-type: none"> ● The junk fax prohibitor feature of this unit rejected fax reception.
MEMORY FULL	-----	<ul style="list-style-type: none"> ● The memory is full of received documents due to a lack of recording paper, a lack of ink film or a recording paper jam. Install paper (page 11), install ink film (page 8) or remove the jammed paper (page 43).
NO DOCUMENT	-----	<ul style="list-style-type: none"> ● The document was not fed into the unit properly. Re-insert the document and try again.
OTHER FAX NOT RESPONDING	-----	<ul style="list-style-type: none"> ● The other party's fax machine is busy or has run out of recording paper. Try again. ● The other party's fax machine rang too many times. Send the fax manually (page 20). ● The other party's machine is not a fax machine. Check with the other party. ● The number you dialed is not in service.
PRESSED THE STOP KEY	-----	<ul style="list-style-type: none"> ● [STOP] was pressed, and fax transmission or reception was canceled.
OK	-----	<ul style="list-style-type: none"> ● Fax transmission or reception was successful.

8.2 Error messages – Display

If the unit detects a problem, one or more of the following messages will appear on the display.

Display	Cause & Solution
“BACK COVER OPEN”	<ul style="list-style-type: none"> The back cover is open. Close the back cover firmly.
“CALL SERVICE”	<ul style="list-style-type: none"> There is something wrong with the unit. Contact our service personnel.
“CHECK DOCUMENT”	<ul style="list-style-type: none"> The document was not fed into the unit properly. Re-insert the document. If misfeeding occurs frequently, clean the document feeder rollers (page 45) and try again. The document is longer than 600 mm (23⁵/₈"). Press [STOP] to remove the document. Divide the document into two or more sheets, and try again.
“CHECK FILM”	<ul style="list-style-type: none"> The ink film is empty. Replace the ink film with a new one (page 8). The ink film is not installed. Install it (page 8). The ink film is slack or creased. Tighten it (see step 5 on page 9).
“CHECK MEMORY”	<ul style="list-style-type: none"> The memory (telephone numbers, parameters, etc.) has been erased. Re-program.
“CHECK PAPER”	<ul style="list-style-type: none"> The recording paper is not installed or the unit has run out of paper. Install paper and press [SET] to clear the message. The recording paper was not fed into the unit properly (page 44). Re-install paper (page 11) and press [SET] to clear the message. The recording paper has jammed near the recording paper entrance. Remove the jammed paper (page 43) and press [SET] to clear the message.
“FAX IN MEMORY”	<ul style="list-style-type: none"> See the other displayed message instructions to print out the document. Received documents are stored in memory due to a lack of recording paper, a lack of ink film or a recording paper jam. Install paper (page 11), install ink film (page 8) or remove the jammed paper (page 43). You will lose all faxes in memory if the power is removed. Check with power connected.
“FAX MEMORY FULL”	<ul style="list-style-type: none"> The memory is full of received documents due to a lack of recording paper, a lack of ink film or a recording paper jam. Install paper (page 11), install ink film (page 8) or remove the jammed paper (page 43). You will lose all faxes in memory if the power is removed. Check with power connected. When performing memory transmission, the document being stored exceeded the memory capacity of the unit. Send the entire document manually.
“FILM EMPTY BUY DIRECT FROM” “www.panasonic.com/kx- fa91”	<ul style="list-style-type: none"> The ink film is empty. Replace the ink film with a new one (page 8). To place an order via the Internet, or to check for special offers, visit our web site: http://www.panasonic.com/kx-fa91 The ink film is slack. Tighten it (see step 5 on page 9) and install again. The fax machine is positioned near appliances such as TVs or speakers which generate an intense magnetic field.
“FILM NEAR EMPTY BUY DIRECT FROM” “www.panasonic.com/kx- fa91” “TO PRINT ORDER PRESS HELP”	<ul style="list-style-type: none"> The remaining ink film is low. Prepare a new ink film (page 6). To print the film order sheet, press [HELP], then [SET]. To place an order via the Internet, or to check for special offers, visit our web site: http://www.panasonic.com/kx-fa91
“MEMORY FULL”	<ul style="list-style-type: none"> When making a copy, the document being stored exceeded the memory capacity of the unit. Press [STOP] to clear the message. Divide the document into sections.

Display	Cause & Solution
“MODEM ERROR”	<ul style="list-style-type: none"> There is something wrong with the unit's modem. Contact our service personnel.
“NO FAX REPLY”	<ul style="list-style-type: none"> The other party's fax machine is busy or has run out of recording paper. Try again.
“OPEN CABINET CHECK FILM SLACK” “OPEN CABINET CHECK FILM TYPE”	<ul style="list-style-type: none"> Please use genuine Panasonic replacement film (page 6). The ink film is slack. Tighten it (see step 5 on page 9). The fax machine is positioned near appliances such as TVs or speakers which generate an intense magnetic field.
“PAPER JAMMED”	<ul style="list-style-type: none"> A recording paper jam occurred. Remove the jammed paper (page 43). You forced the recording paper into the paper tray too strongly. Remove all of the installed paper, and re-install it gently.
“PHONEBOOK FULL”	<ul style="list-style-type: none"> There is no space to store new items in the phonebook. Erase unnecessary items (page 16).
“PLEASE WAIT”	<ul style="list-style-type: none"> The unit is checking that there is no slack or crease in the ink film. Wait for a moment while the check is completed.
“REDIAL TIME OUT”	<ul style="list-style-type: none"> The other party's fax machine is busy or has run out of recording paper. Try again.
“REMOVE DOCUMENT”	<ul style="list-style-type: none"> The document is jammed. Remove the jammed document (page 44). Press [STOP] to eject the jammed paper.
“TRANSMIT ERROR”	<ul style="list-style-type: none"> A transmission error occurred. Try again. If you send a fax overseas, try the following: <ul style="list-style-type: none"> Use the overseas transmission mode (feature #23 on page 32). Add 2 pauses at the end of the telephone number or dial manually.
“UNIT OVERHEATED”	<ul style="list-style-type: none"> The unit is too hot. Stop using the unit for a while and let the unit cool down.

8.3 When a function does not work, check here

8.3.1 Initial settings

Problem	Cause & Solution
I cannot hear a dial tone.	<ul style="list-style-type: none"> The telephone line cord is connected to the [EXT] jack on the unit. Connect to the [LINE] jack (page 12). If you used a splitter/coupler to connect the unit, remove the splitter/coupler and connect the unit to the wall jack directly. If the unit operates properly, check the splitter/coupler. Disconnect the unit from the telephone line and connect a known working telephone. If the working telephone operates properly, contact our service personnel to have the unit repaired. If the working telephone does not operate properly, contact your telephone company. The power cord or telephone line cord is not connected. Check the connections. If you have connected the fax machine through a computer modem, connect the fax machine directly to a telephone line jack.
I cannot make calls.	<ul style="list-style-type: none"> The dialing mode setting may be wrong. Change the setting (feature #13 on page 31).
The unit does not work.	<ul style="list-style-type: none"> Check the connections (page 12).
The unit does not ring.	<ul style="list-style-type: none"> The ringer volume is turned OFF. Adjust it (page 13).

8.3.2 General

Problem	Cause & Solution
The unit displays “PAPER JAMMED” even though paper is installed.	<ul style="list-style-type: none"> ● You forced the recording paper into the paper tray too strongly. Remove all of the installed paper, and re-install it gently.
The unit displays “CHECK PAPER” even though paper is inserted.	<ul style="list-style-type: none"> ● The paper is inserted halfway. Insert it correctly (page 44) and press [SET] to clear the message.
The other party complains they only hear a fax tone and cannot talk.	<ul style="list-style-type: none"> ● FAX ONLY mode is set. Tell the other party the number is only used for faxes. ● Change the receiving mode to TEL mode (page 24). ● If you use a Distinctive Ring service, make sure you have set the same ring pattern assigned by the telephone company (page 27).
[REDIAL] or [PAUSE] does not function properly.	<ul style="list-style-type: none"> ● If this button is pressed during dialing, a pause will be inserted. If pressed immediately after a dial tone is obtained, the last number dialed will be redialed.
The receiving mode does not function properly.	<ul style="list-style-type: none"> ● Distinctive Ring is set (feature #31 on page 27).
The ink film runs out quickly.	<ul style="list-style-type: none"> ● Even if there are only a few sentences, every page that comes out of the machine is considered a full page. ● Turn OFF the following features: <ul style="list-style-type: none"> – confirmation report: feature #04 on page 31. – journal report: feature #22 on page 32. – Caller ID list: feature #26 on page 32.
The unit beeps.	<ul style="list-style-type: none"> ● The memory reception alert of feature #44 is ON (page 34), and the unit has a document in memory. Press [STOP] to stop the beeps, then see the displayed message instructions to solve the problem.
Whenever I try to retrieve my voice mail messages, I am interrupted by the fax tone.	<ul style="list-style-type: none"> ● You are probably entering [*][#][9]. This is the default setting for the fax activation code. If you use a voice mail service, turn the fax activation feature OFF or reprogram the activation code (feature #41 on page 34).
The unit does not display the caller’s name and/or telephone number.	<ul style="list-style-type: none"> ● You need to subscribe to a Caller ID service. ● Other telephone equipment may be interfering with your phone. Disconnect it and try again. ● Other electrical appliances connected to the same outlet may be interfering with the Caller ID information. ● Telephone line noise may be affecting the Caller ID information. ● The caller requested not to send his/her information (page 17).
The display exits the Caller ID List while viewing caller information.	<ul style="list-style-type: none"> ● Do not pause for over 3 minutes while viewing.

8.3.3 Fax – sending

Problem	Cause & Solution
I cannot send documents.	<ul style="list-style-type: none"> • The telephone line cord is connected to the [EXT] jack on the unit. Connect to the [LINE] jack (page 12). • The other party's fax machine is busy or has run out of recording paper. Try again. • The other party's machine is not a fax machine. Check with the other party. • The other party's fax machine failed to answer the fax automatically. Send the fax manually (page 20). • The memory is full of received documents and the quick scan (feature #34 on page 33) is ON. Turn this feature OFF, and send the fax again.
I cannot send a fax overseas.	<ul style="list-style-type: none"> • Use the overseas transmission mode (feature #23 on page 32). • Add two pauses at the end of the telephone number or dial manually.
The other party complains that letters on their received document are distorted or not clear.	<ul style="list-style-type: none"> • If your line has special telephone services such as call waiting, the service may have been activated during fax transmission. Connect the unit to a line that does not have these services. • An extension telephone on the same line is occupying the line. Hang up the extension telephone and try again. • Try copying the document with this unit. If the copied image is clear, there may be something wrong with the other party's machine.
The other party complains that black lines, white lines or smudges appear on their received document.	<ul style="list-style-type: none"> • The scanner glass or rollers are dirty with correction fluid, etc. Clean them (page 45). Please do not insert a document before correction fluid has dried completely.
Documents frequently misfeed.	<ul style="list-style-type: none"> • Clean the document feeder rollers, recording paper feeder and rubber flap (page 45).



8.3.4 Fax – receiving

Problem	Cause & Solution
I cannot receive documents.	<ul style="list-style-type: none"> • The telephone line cord is connected to the [EXT] jack on the unit. Connect to the [LINE] jack (page 12). • You may have subscribed to a voice mail service due to service packs offered by your telephone company. Fax reception may not be possible when voice mail is activated so we recommend you to: <ul style="list-style-type: none"> – contact your telephone company and request to deactivate voice mail service, or – subscribe to a Distinctive Ring service (page 27). • The ink film is empty. Replace the ink film with a new one (page 8).
I cannot receive documents automatically.	<ul style="list-style-type: none"> • The receiving mode is set to TEL mode. Change the receiving mode to FAX ONLY mode (page 24). • The time taken to answer the call is too long. Decrease the number of rings in feature #06 (page 31). • Make sure that the Distinctive Ring of feature #31 is set properly (page 27). If you do not subscribe to the Distinctive Ring service offered by your local telephone company, this feature should be OFF.
The display shows "CONNECTING", but faxes are not received.	<ul style="list-style-type: none"> • The receiving mode is set to FAX ONLY mode and the incoming call is not a fax. Change the receiving mode to TEL mode (page 24).

Problem	Cause & Solution
A blank sheet is ejected.	<ul style="list-style-type: none"> ● If a blank sheet is ejected after the received document is printed out, the size of the document sent by the other party is as large as, or larger than, the recording paper, and the receiving reduction rate is not programmed correctly. Program the proper rate in feature #36 (page 33). ● The other party placed the document in their fax machine facing the wrong way. Check with the other party.
The printing quality is poor.	<p>Please do not reuse the ink film! Please use genuine Panasonic replacement film. Refer to page 6 for further details.</p> <ul style="list-style-type: none"> ● The thermal head is dirty. Clean it (page 46). ● If documents can be copied properly, the unit is working normally. The other party may have sent a faint document or there may be something wrong with the other party's machine. Ask them to send a clearer copy of the document or to check their fax machine. ● Some paper has instructions recommending which side to print on. Try turning the recording paper over. ● You may have used paper with cotton and/or fiber content that is over 20%, such as letterhead or resume paper. We recommend smooth paper such as "Hammermill Jet Print" for clearer printing.
Recording paper frequently misfeeds.	<ul style="list-style-type: none"> ● Clean the document feeder rollers, recording paper feeder and rubber flap (page 45).
Letters on the received document are distorted.	<ul style="list-style-type: none"> ● If your line has special telephone services such as call waiting, the service may have been activated during fax reception. Connect the unit to a line that does not have these services.
I cannot receive documents by pressing [*][#][9] on an extension telephone.	<ul style="list-style-type: none"> ● You must set remote fax activation to ON (feature #41 on page 34) beforehand. ● You may have changed the remote fax activation code from [*][#][9] (default setting). Verify the remote fax activation code (feature #41 on page 34). ● The memory is full of received documents due to a lack of recording paper, a lack of ink film or a recording paper jam. Install paper (page 11), install ink film (page 8) or remove the jammed paper (page 43).
The other party complains that they cannot send a document.	<ul style="list-style-type: none"> ● The receiving mode is set to TEL mode. Receive the document manually (page 24) or change the receiving mode to FAX ONLY mode (page 24). ● The memory is full of received documents due to a lack of recording paper, a lack of ink film or a recording paper jam. Install paper (page 11), install ink film (page 8) or remove the jammed paper (page 43).
I cannot select the desired receiving mode.	<ul style="list-style-type: none"> ● If you want to set FAX ONLY mode: <ul style="list-style-type: none"> – press [AUTO ANSWER] repeatedly until "FAX ONLY MODE" is displayed. ● If you want to set TEL mode: <ul style="list-style-type: none"> – press [AUTO ANSWER] repeatedly until "TEL MODE" is displayed. ● The Distinctive Ring of feature #31 is activated (page 27).

8.3.5 Copying

Problem	Cause & Solution
The unit will not make a copy.	<ul style="list-style-type: none"> ● The ink film is empty. Replace the ink film with a new one (page 8). ● You cannot make a copy during programming. ● You cannot make a copy during a telephone conversation.

Problem	Cause & Solution
A black line, white line or smudge appears on the copied document.	<ul style="list-style-type: none"> The scanner glass or rollers are dirty with correction fluid, etc. Clean them (page 45). Please do not insert a document before correction fluid has dried completely.
The copied image is distorted.	<ul style="list-style-type: none"> Adjust the width of the document guides to fit the actual size of the document.
The printing quality is poor. Original  Copy 	Please do not reuse the ink film! Please use genuine Panasonic replacement film. Refer to page 6 for further details. <ul style="list-style-type: none"> The thermal head is dirty. Clean it (page 46). Some paper has instructions recommending which side to print on. Try turning the recording paper over. You may have used paper with a cotton and/or fiber content that is over 20%, such as letterhead or resume paper. We recommend smooth paper such as "Hammermill Jet Print" for clearer printing.
Documents or recording paper frequently misfeed.	<ul style="list-style-type: none"> Clean the document feeder rollers, recording paper feeder and rubber flap (page 45).

8.3.6 Using an answering machine

Problem	Cause & Solution
I cannot receive documents automatically.	<ul style="list-style-type: none"> Your greeting message on the answering machine is too long. Shorten the message. Record a message up to 10 seconds long. The answering machine rings too many times. Set to 1 or 2 rings.
I cannot receive voice messages.	<ul style="list-style-type: none"> Check if the answering machine is turned ON and connected to the unit properly (page 25). Set the number of rings on the answering machine to 1 or 2.
I pressed the remote access code to access the answering machine remotely, but the line was disconnected.	<ul style="list-style-type: none"> The code may include "#" which is used for certain features provided by telephone companies. Change the code on the answering machine to another number which does not include "#".
Callers complain that they cannot send a document.	<ul style="list-style-type: none"> There is no room left in memory of your answering machine to record voice messages. See the operating instructions of the answering machine and erase unnecessary messages. You set the answering machine to only give a greeting message.

8.3.7 If a power failure occurs

- The unit will not function.
- The unit is not designed for making emergency telephone calls when the power fails. Alternative arrangements should be made for access to emergency services.
- Fax transmission and reception will be interrupted.
- If delayed transmission (feature #25 on page 32) is programmed and a power failure prevents the document from being sent at the set time, the document will be sent after power is restored.
- If any fax documents are stored in the memory, they will be lost. When power is restored, a power down report will be printed stating which documents in memory have been erased.

9.1 Recording paper jams

9.1.1 When the recording paper has jammed in the unit

The display will show the following.

PAPER JAMMED

Important:

- Remove the recording paper, then remove the paper tray beforehand, otherwise the paper may misfeed or jam.

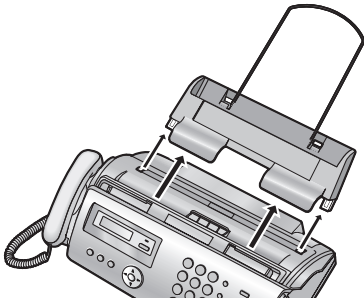

- Open the front cover (1), push the green button (2), then open the back cover (3).

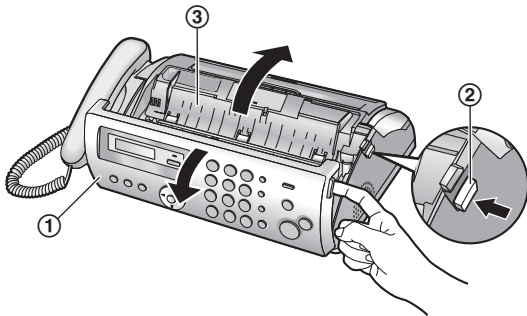

- Remove the jammed recording paper (4).

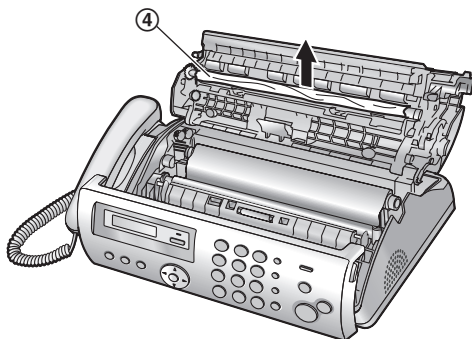

- Turn the blue gear (5) in the direction of the arrow until the ink film is tight (6) and at least one layer of ink film is wrapped around the blue core (7).

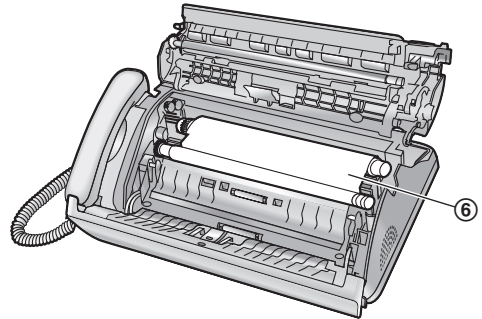
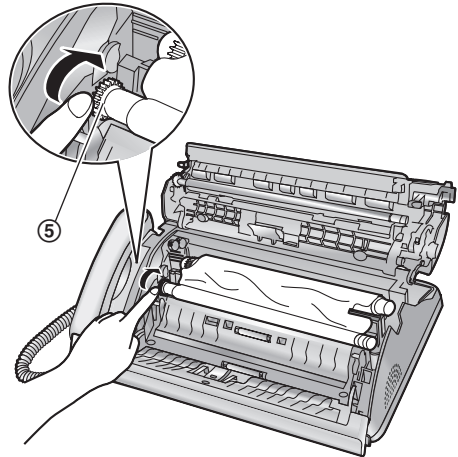

Correct

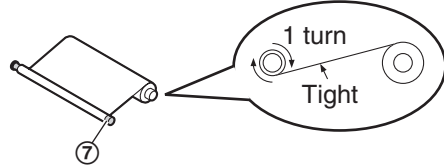

Incorrect

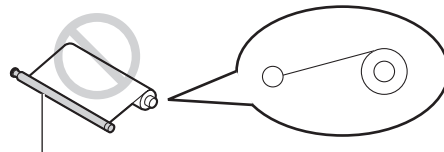

9. Maintenance

- 4 Close the back cover securely by pushing down on the dotted area at both ends (⑧), then close the front cover securely (⑨).

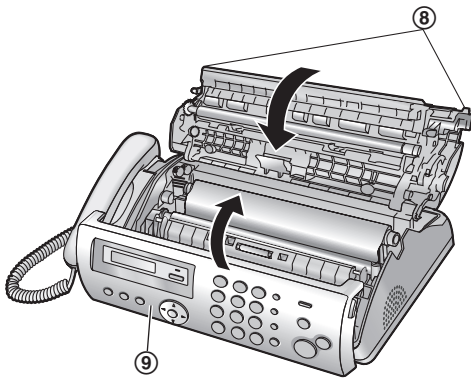

- 5 Install the paper tray (page 10), then insert the recording paper gently (page 11).

9.1.2 When the recording paper was not fed into the unit properly

The display will show the following.

CHECK PAPER

Remove the recording paper and straighten. Insert the paper, then press **[SET]** to clear the message.



9.2 Document jams

- 1 Open the front cover. Remove the jammed document carefully (①).

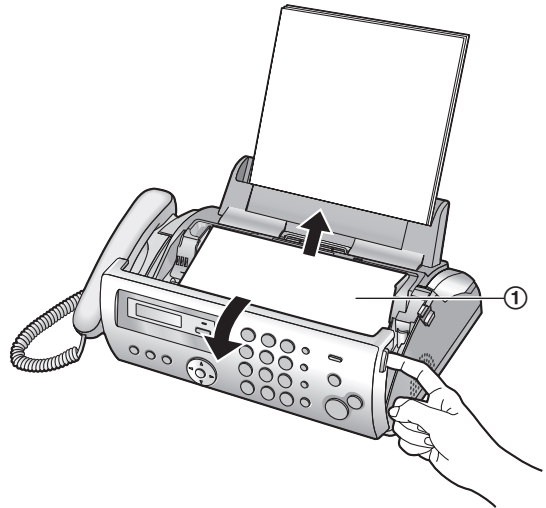

- 2 Close the front cover securely.

Note:

- Do not pull out the jammed paper forcibly before opening the front cover.

9.3 Document feeder/recording paper feeder/scanner glass cleaning

Clean the document feeder/recording paper feeder/scanner glass when:

- Documents or recording paper frequently misfeed.
- Smudges or black/white lines appear on the original document when sending or copying.

Important:

- Remove the recording paper, then remove the paper tray beforehand, otherwise the paper may misfeed or jam.

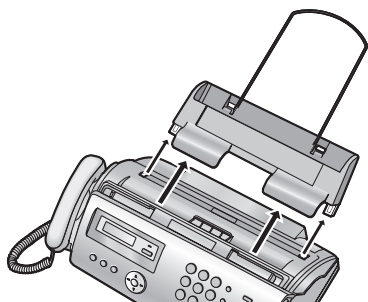

- 1 Disconnect the power cord and the telephone line cord.
- 2 Open the front cover (1), push the green button (2), then open the back cover (3).

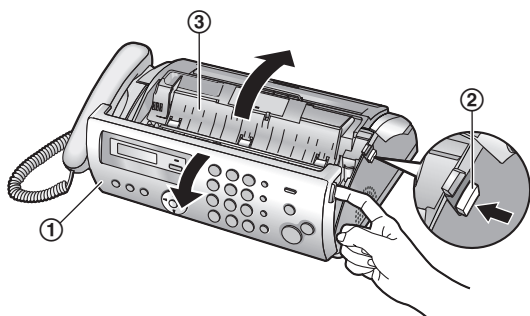

- 3 Clean the document feeder rollers (4) and rubber flap (5) with a cloth moistened with isopropyl rubbing alcohol, and let all parts dry thoroughly. Clean the scanner glass (6) with a soft, dry cloth.

Caution:

- Do not use paper products, such as paper towels or tissues.

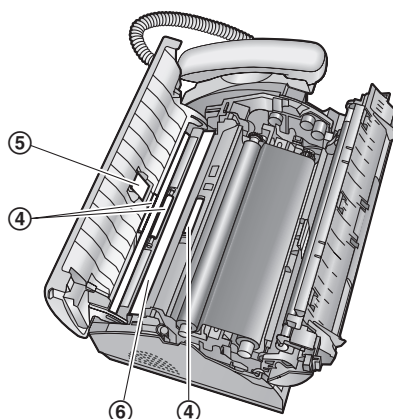

- 4 Clean the recording paper feeder roller (7) with a cloth moistened with isopropyl rubbing alcohol, and let all parts dry thoroughly.

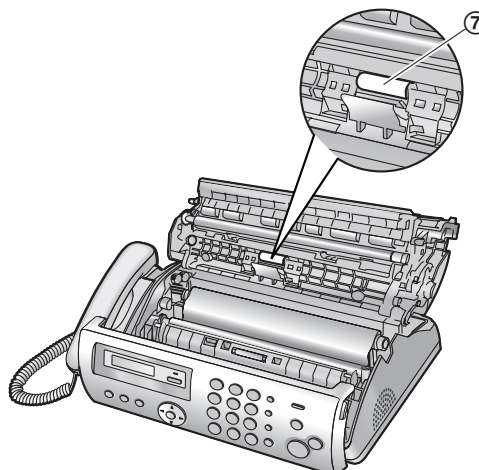

- 5 Close the back cover securely by pushing down on the dotted area at both ends (8), then close the front cover securely (9).

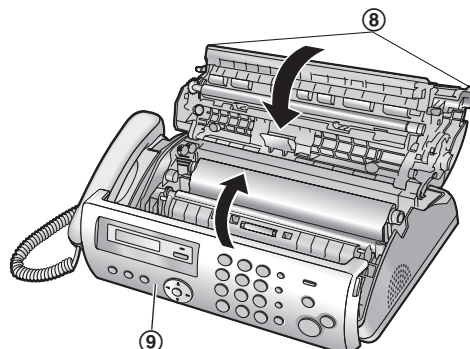

- 6 Install the paper tray (page 10), then insert the recording paper gently (page 11).
- 7 Connect the power cord and the telephone line cord.

9.4 Thermal head cleaning

If smudges or black/white lines appear on a copied/received document, check whether there is dust on the thermal head. Clean the thermal head to remove the dust.

Important:

- Remove the recording paper, then remove the paper tray beforehand, otherwise the paper may misfeed or jam.

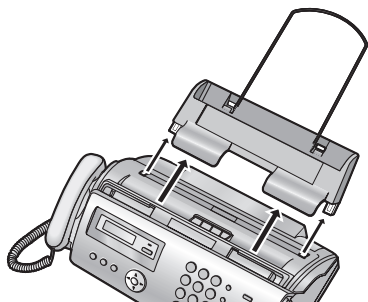

- 1 Disconnect the power cord and the telephone line cord.
- 2 Open the front cover (1), push the green button (2), then open the back cover (3).

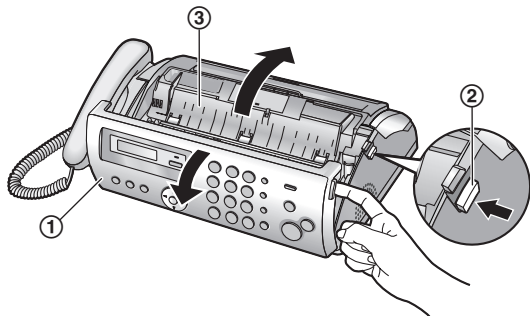

- 3 Remove the ink film (4).

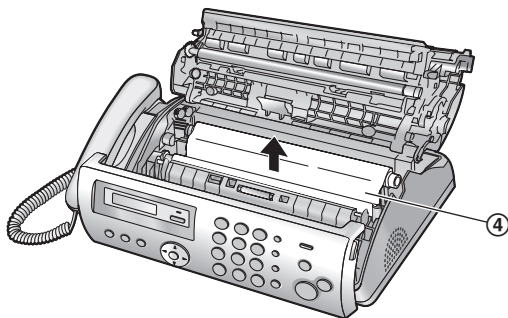

- 4 Clean the thermal head (5) with a cloth moistened with isopropyl rubbing alcohol, and let it dry thoroughly.

Caution:

- To prevent a malfunction due to static electricity, do not use a dry cloth and do not touch the thermal head directly.

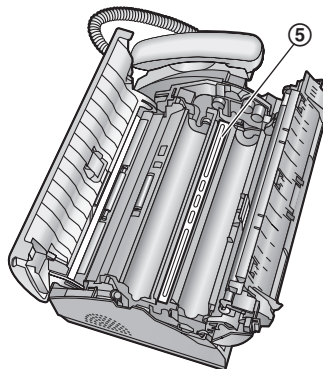

- 5 Re-install the ink film and close the covers (see step 4 to 7 on page 8).
- 6 Install the paper tray (page 10), then insert the recording paper gently (page 11).
- 7 Connect the power cord and the telephone line cord.

10.1 Reference lists and reports

You can print out the following lists and reports for your reference:

- "SETUP LIST"
- "PHONEBOOK LIST"
- "JOURNAL REPORT"
- "PRINTER TEST"
 - If the test print has a smudges, blurred points or lines, clean the thermal head (page 46).
- "BROADCAST LIST"
- "CALLER ID LIST"

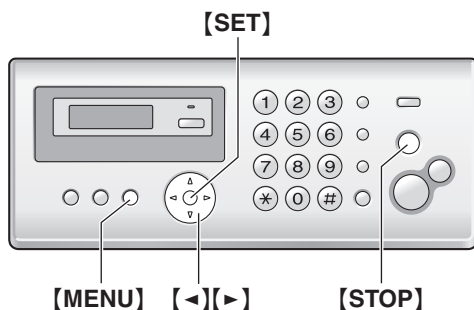

- 1 Press **[MENU]** repeatedly to display "PRINT REPORT".
- 2 Press **[←]** or **[→]** repeatedly to display the desired item. → **[SET]**
 - To stop printing, press **[STOP]**.
- 3 **[MENU]**

10.2 Specifications

■ Applicable lines:

Public Switched Telephone Network

■ Document size:

Max. 216 mm (8¹/₂") in width, Max. 600 mm (23⁵/₈") in length

■ Effective scanning width:

208 mm (8³/₁₆")

■ Effective printing width:

Letter: 208 mm (8³/₁₆")

A4: 202 mm (7¹⁵/₁₆")

■ Transmission speed*1:

Approx. 15 s/page*2

■ Scanning density:

Horizontal: 8 pels/mm (203 pels/inch)

Vertical: 3.85 lines/mm (98 lines/inch) (standard resolution)

7.7 lines/mm (196 lines/inch) (fine/photo resolution)

15.4 lines/mm (392 lines/inch) (super fine resolution)

■ Photo resolution:

64 levels

■ Scanner type:

Contact Image Sensor

■ Printer type:

Thermal Transfer on plain paper

■ Data compression system:

Modified Huffman (MH), Modified READ (MR)

■ Modem speed:

9,600 / 7,200 / 4,800 / 2,400 bps; Automatic Fallback

■ Operating environment:

5 °C – 35 °C (41 °F – 95 °F), 20 % – 80 % RH (Relative Humidity)

■ Dimensions:

Approx. height 106 mm × width 356 mm × depth 200 mm (4³/₁₆" × 14" × 7⁷/₈")

■ Mass (Weight):

Approx. 2.7 kg (5.9 lb.)

■ Power consumption:

Standby: Approx. 1.2 W

Transmission: Approx. 15 W

Reception: Approx. 40 W (When receiving a 20 % black document)

Copy: Approx. 40 W (When copying a 20 % black document)

Maximum: Approx. 135 W (When copying a 100 % black document)

■ Power supply:

120 V AC, 60 Hz

■ Fax memory capacity*3:

Transmission: Approx. 25 pages

Reception: Approx. 28 pages

10. General Information

(Based on the ITU-T No. 1 Test Chart in standard resolution.)

- *1 Transmission speed depends on the contents of the pages, resolution, telephone line conditions and capability of the other party's machine.
- *2 Transmission speed is based on the ITU-T No. 1 Test Chart with original mode. If the capability of the other party's machine is inferior to your unit, the transmission time may be longer.
- *3 If an error occurs during fax reception, such as a paper jam or if the recording paper runs out, the fax and subsequent faxes will be retained in memory.

Note:

- The accuracy of the clock is approximately ± 60 seconds a month.

ITU-T No. 1 Test Chart

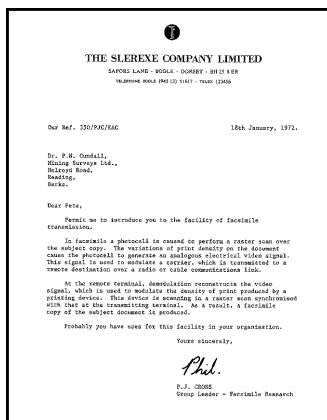

Note:

- Design and specifications are subject to change without notice.
- The pictures and illustrations in these instructions may vary slightly from the actual product.

Recording paper specifications

Recording paper size:

Letter: 216 mm \times 279 mm ($8\frac{1}{2}$ " \times 11")

A4: 210 mm \times 297 mm ($8\frac{1}{4}$ " \times $11\frac{11}{16}$ ")

Recording paper weight:

60 g/m² to 90 g/m² (16 lb. to 24 lb.)

Note for recording paper:

- Do not use the following types of paper:
 - Paper with cotton and/or fiber content that is over 20 %, such as letterhead paper or paper used for resumes
 - Extremely smooth or shiny paper, or paper that is highly textured
 - Coated, damaged or wrinkled paper
 - Paper with foreign objects attached, such as tabs or staples
 - Paper which has dust, lint or oil stains

- Paper that will melt, vaporize, discolor, scorch or emit dangerous fumes near 200 °C (392 °F), such as vellum paper. These materials may transfer onto the fusing roller and cause damage.
- Moist paper
- Some paper only accepts print on one side. Try using the other side of the paper if you are not happy with the print quality or if misfeeding occurs.
- For proper paper feeding and best print quality, we recommend using long-grained paper.
- Do not use paper of different types or thickness at the same time. This may cause paper jams.
- Avoid double-sided printing.
- Do not use paper printed from this unit for double-sided printing with other copiers or printers. This may cause paper jams.
- To avoid curling, do not open paper packs until you are ready to use the paper. Store unused paper in the original packaging, in a cool and dry location.

10.3 FCC and Other Information

This equipment complies with Part 68 of the FCC rules and the requirements adopted by the ACTA. On the rear of this equipment is a label that contains, among other information, a product identifier in the format US:ACJ-----.

If requested, this number must be provided to the telephone company.

- Registration No(found on the rear of the unit)
- Ringer Equivalence No. (REN)
.....(found on the rear of the unit)

A plug and jack used to connect this equipment to the premises wiring and telephone network must comply with the applicable FCC Part 68 rules and requirements adopted by the ACTA. A compliant telephone cord and modular plug is provided with this product. It is designed to be connected to a compatible modular jack that is also compliant.

The REN is used to determine the number of devices that may be connected to a telephone line. Excessive RENs on a telephone line may result in the devices not ringing in response to an incoming call. In most but not all areas, the sum of RENs should not exceed five (5.0). To be certain of the number of devices that may be connected to a line, as determined by the total RENs, contact the local telephone company. For products approved after July 23, 2001, the REN for this product is part of the product identifier that has the format US:AAAEQ##TXXXX. The digits represented by ## are the REN without a decimal point (e.g., 03 is a REN of 0.3).

If this equipment causes harm to the telephone network, the telephone company will notify you in advance that temporary discontinuance of service may be required. But if advance notice isn't practical, the telephone company will notify the customer as soon as possible. Also, you will be advised of your right to file a complaint with the FCC if you believe it is necessary.

The telephone company may make changes in its facilities, equipment, operations or procedures that could affect the operation of the equipment. If this happens the telephone company will provide advance notice in order for you to make necessary modifications to maintain uninterrupted service.

If trouble is experienced with this equipment, for repair or warranty information, please contact a Factory Servicenter or other Authorized Servicer. If the equipment is causing harm to the telephone network, the telephone company may request that you disconnect the equipment until the problem is resolved.

Connection to party line service is subject to state tariffs. Contact the state public utility commission, public service commission or corporation commission for information.

If your home has specially wired alarm equipment connected to the telephone line, ensure the installation of this equipment does not disable your alarm equipment. If you have questions about what will disable alarm equipment, consult your telephone company or a qualified installer.

This equipment is hearing aid compatible as defined by the FCC in 47 CFR Section 68.316.

WHEN PROGRAMMING EMERGENCY NUMBERS AND/OR MAKING TEST CALLS TO EMERGENCY NUMBERS:

- 1) Remain on the line and briefly explain to the dispatcher the reason for the call.
- 2) Perform such activities in the off-peak hours, such as early morning or late evenings.

This device complies with Part 15 of the FCC Rules. Operation is subject to the following two conditions:

- (1) This device may not cause harmful interference, and
- (2) this device must accept any interference received, including interference that may cause undesired operation.

CAUTION:

Any changes or modifications not expressly approved by the party responsible for compliance could void the user's authority to operate this device.

NOTE:

This equipment has been tested and found to comply with the limits for a Class B digital device, pursuant to Part 15 of the FCC Rules. These limits are designed to provide reasonable protection against harmful interference in a residential installation. This equipment generates, uses, and can radiate radio frequency energy and, if not installed and used in accordance with the instructions, may cause harmful interference to radio communications. However, there is no guarantee that interference will not occur in a particular installation. If this equipment does cause harmful interference to radio or television reception, which can be determined by turning the equipment off and on, the user is encouraged to try to correct the interference by one or more of the following measures:

- Reorient or relocate the receiving antenna.
- Increase the separation between the equipment and receiver.
- Connect the equipment into an outlet on a circuit different from that to which the receiver is connected.
- Consult the dealer or an experienced radio/TV technician for help.

10.4 Limited Warranty

PANASONIC CONSUMER ELECTRONICS COMPANY,
DIVISION OF PANASONIC CORPORATION OF
NORTH AMERICA
One Panasonic Way, Secaucus, New Jersey 07094

PANASONIC PUERTO RICO, INC.
San Gabriel Industrial Park,
Ave. 65 de Infantería, Km. 9.5,
Carolina, Puerto Rico 00985

Panasonic Facsimile Product Limited Warranty

Limited Warranty Coverage

If your product does not work properly because of a defect in materials or workmanship, Panasonic Consumer Electronics Company or Panasonic Puerto Rico, Inc. (collectively referred to as “the warrantor”) will, for the length of the period indicated on the chart below, which starts with the date of original purchase (“Limited Warranty period”), at its option either (a) repair your product with new or refurbished parts, or (b) replace it with a new or a refurbished product. The decision to repair or replace will be made by the warrantor.

FAX categories	Parts	Labor
Thermal Transfer Facsimile	6 Months	6 Months
Laser Facsimile	1 (one) Year	1 (one) Year

Batteries, antennas, ink film, toner cartridge, drum unit, and ink cartridge (as may be applicable), and cosmetic parts (cabinet) are not warranted under this Limited Warranty.

During the “Labor” Limited Warranty period there will be no charge for labor. During the “Parts” Limited Warranty period, there will be no charge for parts. You must carry-in or mail-in your product during the Limited Warranty period. This Limited Warranty only applies to products purchased and serviced in the United States or Puerto Rico. This Limited Warranty is extended only to the original purchaser and only covers products purchased as new. A purchase receipt or other proof of the original purchase date is required for Limited Warranty service.

Carry-In or Mail-In Service

For Carry-In or Mail-In Service in the United States call 1-800-HELP-FAX (1-800-435-7329)
For assistance in Puerto Rico call Panasonic Puerto Rico, Inc. (787)-750-4300 or fax (787)-768-2910.

Limited Warranty Limits And Exclusions

This Limited Warranty ONLY COVERS failures due to defects in materials or workmanship, and DOES NOT COVER normal wear and tear or cosmetic damage. The Limited Warranty ALSO DOES NOT COVER damages which occurred in shipment, or failures which are caused by products not supplied by the warrantor such as non Panasonic ink film, toner cartridge or drum unit, or failures which result from accidents, misuse, abuse, neglect, bug infestation, mishandling, misapplication, alteration, faulty installation, set-up adjustments, signal reception problems, misadjustment of consumer controls, improper maintenance, power line surge, improper voltage supply, lightning damage, modification, or commercial use (such as in a hotel, office, restaurant, or other business), rental use of the product, service by anyone other than a Factory Servicenter or other Authorized Servicer, or damage that is attributable to acts of God.

THERE ARE NO EXPRESS WARRANTIES EXCEPT AS LISTED UNDER “LIMITED WARRANTY COVERAGE”. THE WARRANTOR IS NOT LIABLE FOR INCIDENTAL OR CONSEQUENTIAL DAMAGES RESULTING FROM THE USE OF THIS PRODUCT, OR ARISING OUT OF ANY BREACH OF THIS LIMITED WARRANTY. (As examples, this excludes damages for lost time, cost of having someone remove or re-install an installed unit if applicable, or travel to and from the servicer. The items listed are not exclusive, but are for illustration only.) **ALL EXPRESS AND IMPLIED WARRANTIES, INCLUDING THE WARRANTY OF MERCHANTABILITY, ARE LIMITED TO THE PERIOD OF THE LIMITED WARRANTY.**

10. General Information

Some states do not allow the exclusion or limitation of incidental or consequential damages, or limitations on how long an implied Limited Warranty lasts, so the exclusions may not apply to you.

This Limited Warranty gives you specific legal rights and you may also have other rights which vary from state to state. If a problem with this product develops during or after the Limited Warranty period, you may contact your dealer or Servicenter. If the problem is not handled to your satisfaction, then write to the warrantor's Consumer Affairs Department at the addresses listed for the warrantor.

PARTS AND SERVICE WHICH ARE NOT COVERED BY THIS LIMITED WARRANTY ARE YOUR RESPONSIBILITY.

For In Limited Warranty product service

- Call toll-free 1-800-HELP-FAX (1-800-435-7329) for the location of an authorized servicenter.

For out of Limited Warranty technical and troubleshooting support: Panasonic offers two value based, cost effective, solutions:

1. Panasonic Continued Services 900 fee based support: 1-900-FAX-HELP (1-900-329-4357)

This exceptional service is charged directly to your telephone bill at only \$2.49 per minute.

2. Panasonic Premier Service Club (PPSC): 1-800-435-7329

PPSC provides toll free troubleshooting support at only \$7.99 for a one time sampler or \$23.95 for a one year or 5 call membership. These services are billed directly to your major credit card.

When you ship the product

- Carefully pack your unit, preferably in the original carton.
- Attach a letter, detailing the symptom or problem, to the outside of the carton.
- Send the unit to an authorized servicenter, prepaid and adequately insured.
- Do not send your unit to the Panasonic Consumer Electronics Company or to any executive or regional sales office. These locations do not repair consumer products.

Both of these comprehensive programs provide real time, live agent support for customers who are not eligible for coverage under the limited warranty.

Terms and prices are subject to change without notice.

10.5 Customer Services directory

Customer Services Directory

Obtain Product Information and Operating Assistance; locate your nearest Dealer or Servicenter; purchase Parts and Accessories; or make Customer Service and Literature requests by visiting our Web Site at:

<http://www.panasonic.com/consumersupport>

or E-mail us via:

consumer_fax@us.panasonic.com

Contact:

For in Limited Warranty programming and Troubleshooting Support:

Fax Advantage assistance and Service Location finder: 1-800-HELP-FAX (435-7329)

For out of Limited Warranty technical and troubleshooting support:

Panasonic offers two value based, cost effective, solutions:

1. Panasonic Continued Services 900 fee based support: 1 900 FAX HELP (1 900 329 4357)
This exceptional service is charged directly to your telephone bill at only \$2.49 per minute.

2. Panasonic Premier Service Club (PPSC): 1 800 435 7329

PPSC provides toll free troubleshooting support at only \$7.99 for a one time sampler or \$23.95 for a one year or 5 call membership. These services are billed directly to your major credit card.

Both of these comprehensive programs provide real time, live agent support for customers who are not eligible for coverage under the limited warranty. Terms and prices are subject to change without notice.

For hearing or speech impaired TTY users, TTY: 1-877-833-8855

Accessory Purchases

Purchase Parts, Accessories and Instruction Books online for all Panasonic Products by visiting our Web Site at:

<http://www.pasc.panasonic.com>

or, send your request by E-mail to:

npcparts@us.panasonic.com

You may also contact us directly at:

1-800-332-5368 (Phone) 1-800-237-9080 (Fax Only) (Monday - Friday 9 am to 8 pm, EST.)

Panasonic Services Company

20421 84th Avenue South, Kent, WA 98032

(We Accept Visa, MasterCard, Discover Card, American Express, and Personal Checks)

For hearing or speech impaired TTY users, TTY: 1-866-605-1277

Service in Puerto Rico

Panasonic Puerto Rico, Inc.

San Gabriel Industrial Park, Ave. 65 de Infantería, Km. 9.5, Carolina, Puerto Rico 00985

Phone (787) 750-4300 Fax (787) 768-2910 (Monday - Friday 8:30 am to 4:30 pm, EST.)

11.1 Index

- # #00 Quick Setup: 13
- #01 Date and time: 14
- #02 Your logo: 14
- #03 Your fax number: 15
- #04 Confirmation report: 20
- #06 FAX ring count: 31
- #13 Dialing mode: 31
- #16 Paper size: 31
- #17 Ringer tone: 31
- #22 Automatic journal report: 20
- #23 Overseas mode: 32
- #25 Delayed send: 32
- #26 Automatic Caller ID list: 32
- #31 Distinctive Ring: 27
- #32 Fax ring pattern: 27
- #33 Time adjustment: 33
- #34 Quick scan: 20, 28
- #36 Receiving reduction: 33
- #39 LCD display contrast: 33
- #41 Fax activation code: 34
- #44 Memory reception alert: 34
- #46 Friendly reception: 34
- #72 Flash time: 34
- #75 Caller ID number auto edit: 18
- #76 Connecting tone: 34
- #80 Set default: 35
- A** Accessories: 6
 - A4 paper guide: 10
 - Paper support: 10
 - Paper tray: 10
 - Advanced features: 32
- B** Basic features: 31
 - BROADCAST LIST: 47
 - Broadcast transmission: 22
 - Button description: 7
- C** Caller ID
 - Calling back: 18
 - Storing: 19
 - CALLER ID LIST (Feature #26): 17, 47
 - Caller ID number auto edit feature (Feature #75): 18
 - Character table: 14
 - Cleaning: 45
 - Confirmation report (Feature #04): 20
 - Connecting tone (Feature #76): 34
 - Connections: 12
 - Copy: 28
 - Collation: 28
 - Enlarge/Reduce: 28
- D** Date and time (Feature #01): 14
 - Delayed transmission (Feature #25): 32
 - Dialing mode (Feature #13): 31
 - Display
 - Contrast (Feature #39): 33
 - Error messages: 37
 - Distinctive Ring service (Feature #31): 27
- Document size: 21
- E** Error messages: 36
 - Extension telephone: 24
- F** Fax activation code (Feature #41): 34
 - Fax number (Feature #03): 15
 - FAX ONLY mode: 23, 24
 - Flash time (Feature #72): 34
 - Friendly reception (Feature #46): 34
- H** Help: 13
 - BASIC SETTINGS: 13
 - CALLER ID: 13
 - COPIER: 13
 - ERRORS: 13
 - FAX SND/RCV: 13
 - FEATURE LIST: 13
 - FILM ORDER SHEET: 13
 - Q and A: 13
 - REPORTS: 13
- I** Ink film: 8
- J** Jams
 - Document: 44
 - Recording paper: 43
- JOURNAL REPORT (Feature #22): 20, 47
- Junk fax prohibitor: 26
- L** Logo (Feature #02): 14
- O** One touch: 16
 - Overseas mode (Feature #23): 32
- P** Paper size (Feature #16): 31
 - Phonebook
 - Making a phone call: 16
 - Sending faxes: 21
 - Storing: 16
 - PHONEBOOK LIST: 47
 - Power failure: 42
 - PRINTER TEST: 47
 - Programming: 30
- Q** Quick scan (Feature #34): 20, 28
 - Quick Setup (Feature #00): 13
- R** Receiving alert (Feature #44): 34
 - Receiving faxes
 - Automatically: 24
 - Manually: 24
 - Receiving reduction (Feature #36): 33
 - Recording paper: 11, 48
 - Redialing: 20, 21
 - Reports
 - Broadcast programming: 47
 - Broadcast sending: 22
 - Caller ID: 47
 - Confirmation: 20
 - Journal: 20, 47
 - Phonebook: 47
 - Power down: 42
 - Printer test: 47
 - Setup: 47

- Reset (Feature #80): 35
- Resolution: 28
- Ring count
 - FAX ONLY (Feature #06): 31
- Ringer tone (Feature #17): 31
- Ring pattern for Distinctive Ring (Feature #32): 27
- S** Sending faxes
 - Broadcast: 22
 - From memory: 20
 - Manually: 20
 - One touch: 21
 - Phonebook: 21
- SETUP LIST: 47
- Storing
 - Broadcast: 22
 - One touch: 16
 - Phonebook: 16
- T** TEL mode: 23, 24
- Time adjustment (Feature #33): 33
- V** Volume: 13

Panasonic
KX-FP205
Proof of Purchase

Panasonic FAX ADVANTAGE PROGRAM

*Free peace of mind,
direct from Panasonic*

NO EXTRA COST



- **6-month limited warranty¹: parts, labor, and toll-free help line²**
- **Free replacement³ and repair program**

The Panasonic Fax Advantage Consumer Service Program.

Panasonic knows that if your fax machine is not up and running, neither is your business. That's why we created the Panasonic Fax Advantage Program. Included at no extra cost with the purchase of a new and unused Panasonic Fax Machine (along with included handset), the Fax Advantage Program can provide a free replacement unit³ if your original unit is in need of repair.

Here's how it works:

1. If you have a problem with your fax that you purchased new and unused while it is covered by the period of limited warranty¹, call our toll-free help-line at 1-800-HELP-FAX².
2. Talk to one of our technical experts to diagnose your problem over the phone.
3. If repairs are necessary and you are entitled to service under the terms and conditions of the limited warranty⁴, we will send a refurbished replacement unit to you by Ground service delivery. The shipping method is upgradable for an extra charge.

A second option available under our limited warranty is to mail-in or carry-in your fax to one of our Regional Service centers, where the unit will be repaired and returned to you.

Instructions:

If you choose to receive a replacement unit under the Fax Advantage Program, Panasonic will provide a replacement unit which will be completely refurbished, quality-tested by Panasonic technicians and individually hand-inspected before it is shipped to you. You will keep the replacement unit and send the original unit to us in the replacement unit's box. Contact the shipper who will pick up the unit at no charge to you, should it be determined that you are entitled to warranty service. A proof-of-purchase must be included with the returned product. Any unit that is replaced by Panasonic and not shipped with proper proof-of-purchase by you will be subject to a minimum \$100.00 charge. The original unit must be properly packaged in the same manner as the replacement unit, utilizing the packing materials provided. Damage due to improper or inadequate packing will be charged to you as an out-of-warranty cost.

If our 1-800-HELP-FAX technicians determine that your unit may be an "out-of-box failure"⁵, we will attempt to provide you with a factory-new replacement unit⁶. You must ship a copy of your receipt with your original unit to verify that you purchased the unit within 10 days prior to your 1-800-HELP-FAX call.

Requirements:

You must give our technicians a valid credit card number (Discover, VISA, Master Card, or American Express/Optima). Product that is not returned to Panasonic by 10 business days after shipment of the replacement product will be charged to your credit card account at Panasonic's Suggested Retail Price (see dealer for details). If your original unit is not eligible for warranty service, your card will be charged for the non-warranty repair of the unit at Panasonic's current rate for parts and labor and for any shipping charges associated with this program. If you do not wish to pay out-of-warranty repair costs, you will be responsible for returning the replacement unit to Panasonic and for paying all shipping charges associated with this program including the delivery of the replacement product to you, shipment of the problem unit to Panasonic, shipment of the replacement unit back to Panasonic and the return of your original unit back to you. Credit status will be verified prior to sending the replacement product.

1. See dealer for limited warranty details.
2. After the fax advantage program, contact our Continued Services Technical Support Line at 1-900-FAX-HELP (1-900-329-4357), for fee based technical support.
3. Replacement unit is refurbished.
4. Replacement program is only available in the 50 United States, is subject to termination at any time without advance notice, and does not cover optional accessories.
5. "Out-of-box failure" is an inoperable unit that was purchased no more than 10 days prior to your 1-800-HELP-FAX call, and would otherwise qualify for warranty service under the terms and conditions of the limited warranty.
6. Panasonic reserves the right to send a refurbished unit.

**Panasonic Consumer Electronics
Company, Division of Panasonic
Corporation of North America**

One Panasonic Way, Secaucus,
New Jersey 07094

Panasonic Puerto Rico, Inc.

San Gabriel Industrial Park,
Ave. 65 de Infantería, Km. 9.5,
Carolina, Puerto Rico 00985



FP205

PFQX2559ZA

CM0306DT0

Free Manuals Download Website

<http://myh66.com>

<http://usermanuals.us>

<http://www.somanuals.com>

<http://www.4manuals.cc>

<http://www.manual-lib.com>

<http://www.404manual.com>

<http://www.luxmanual.com>

<http://aubethermostatmanual.com>

Golf course search by state

<http://golfingnear.com>

Email search by domain

<http://emailbydomain.com>

Auto manuals search

<http://auto.somanuals.com>

TV manuals search

<http://tv.somanuals.com>