

Facsimile

Quick Reference Guide

Model No. **KX-PW95CL**
KX-PW95CW



KX-PW95CL

Thank you for purchasing a Panasonic facsimile.

Table of Contents

Finding the controls	2
Installations and connections	4
Setting the date and time	7
Setting your facsimile telephone number	7
Setting your logo	8
Character input and command key table	9
Automatic dialing on the main unit.....	10
Automatic dialing on the portable handset	12
Intercom between the main unit and portable handset	13
Sending faxes	14
Receiving faxes	15
Operating the built-in answering device	16
Individual e-mail services	18
Specifications.....	Back cover

- This guide explains some basic features and operations, but not all of them. For further details, see the Japanese operating instructions.
- This product is designed for use in Japan.
Panasonic cannot provide service for this product if used outside Japan.
- Any details given in this guide are subject to change without notice.

Finding the controls

Main unit (control panel)

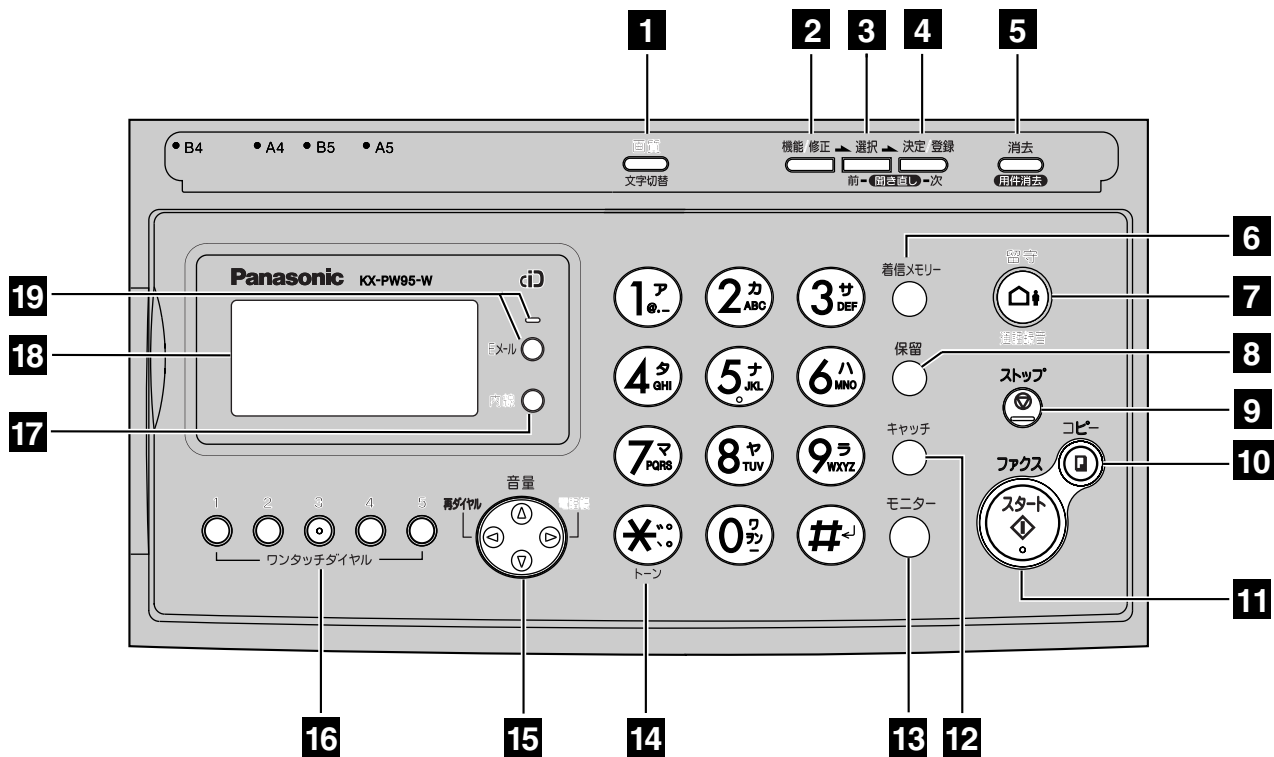

1 Resolution button selects the resolution when faxing or copying.

Character Input Mode button

2 Function button initiates programming.
Edit button

3 Select button selects feature settings.
Previous Replay button

—plays back recorded messages.
—returns to the previous message while listening to a recorded message.

4 Set/Register button stores a parameter.
Next Replay button

—plays back recorded messages.
—skips to the next message while listening to a recorded message.

5 Erase button

6 Call Memory button starts a search in the Number Display log.
(For caller ID display service users.)

7 Auto Answer button & indicator
—light on: answering device activated.
—light off: used as a regular telephone.
Record button records telephone calls.

8 Hold button

9 Stop button

10 Copy button starts copying.

11 Start/Fax button starts faxing.

12 Flash button

(For call waiting service users.)

13 Monitor button

14 Tone button switches to tone dialing.

15 Volume/Redial/Phonebook/Addressbook key

 To adjust the volume.

 To redial the phone numbers in the redial list. The last 10 phone numbers dialed are stored in memory.

 To use the phonebook and the addressbook.

16 One-touch dial buttons

17 Intercom button

18 Liquid crystal display

19 E-Mail button & indicator

Finding the controls

Portable handset



How to use  **key**

 電話帳 To use the phonebook.

 再ダイヤル To redial the phone numbers in the redial list. The last 10 phone numbers dialed are stored in memory. To insert a pause.

 音量 To adjust the volume.



 外線 To make/answer calls.

 文字切替
 内線 To page the main unit. To change the character input mode.

 切 To end a call. To end or exit from editing or other operations.

 保留 To put a call on hold. To start a search in the Number Display log. (For caller ID display service users.)

 着信メモリー To adjust the receiver volume.

 クリアー
 キヤッチ To clear letters/numbers. For call waiting service users.

 ファクス To receive faxes.

 スピーカーホン To use the speakerphone.

 増設 Used when installing additional portable handsets.

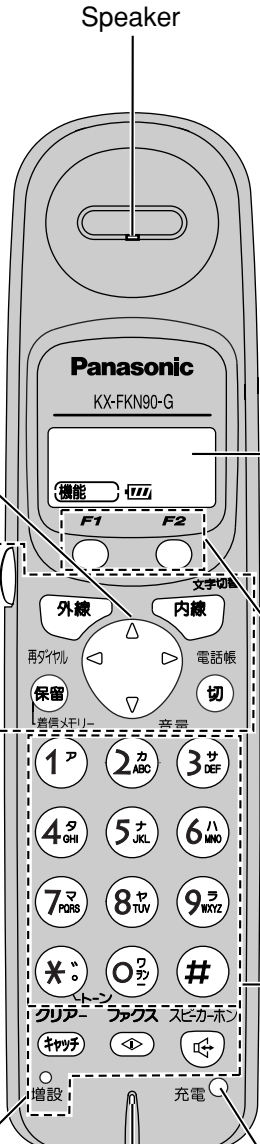

LCD (with back light)

Displays battery strength, telephone numbers etc.

①
コキ1



機能登録 1/4 修正

② ③ ②

① Portable handset number
② Function menu that is controlled by **F1** or **F2**.
③ Battery strength

How to use **F1** **F2** buttons

F1 **F2**

 and  buttons refer to the function displayed on the bottom of the display. They function differently depending on the mode.

Dial buttons

 トーン Tone button
To switch to Tone dialing mode.

 # Sharp button

Charge indicator

Charging Red
Full Off

Installations and connections

Installing the ink film

- 1** Open the control panel.

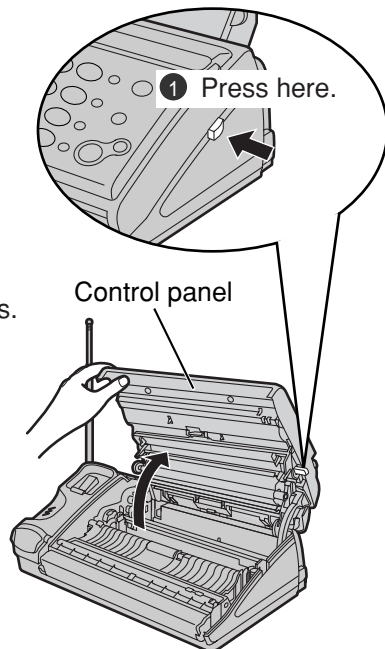

- 2** Open the control panel until it locks.

- 2** Insert the ink film.

Find the "T" shaped gear (blue).

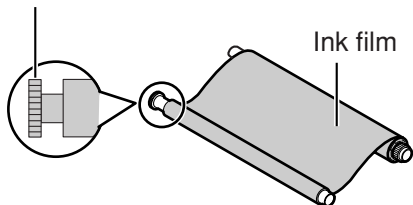

- 1** Insert the blue core into the right slot of the main unit.

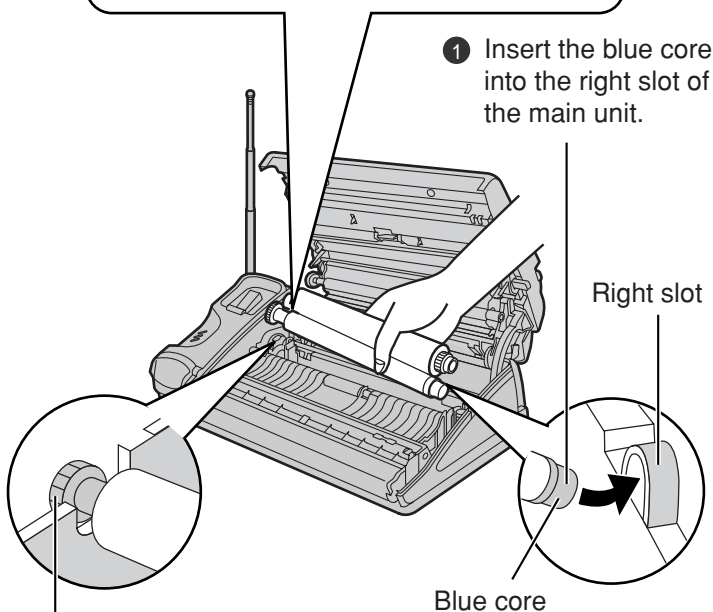

- 2** Insert the "T" shaped gear (blue) into the left slot of the main unit.

- 3** Insert the white core into the slots.

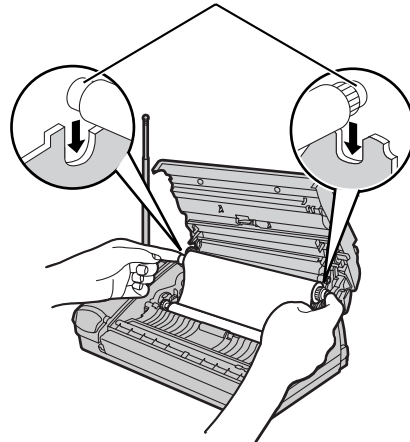

- 3** If the ink film is slack, tighten it by winding the "T" shaped gear.

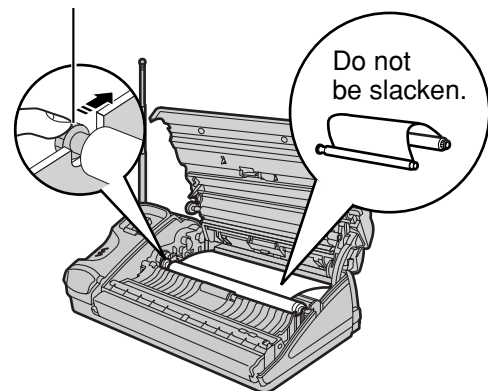

- 4** Close the control panel until it locks.

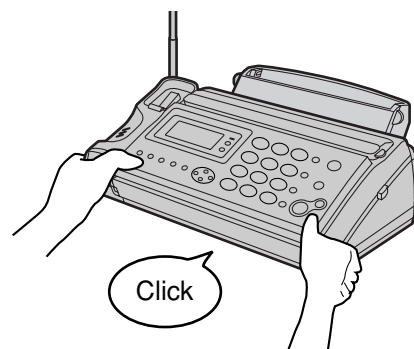

- When the unit runs out of ink film, the following message will be displayed.

フィルムガ ナクナリマシタ
ユウカンシテクタ サイ U23

フィルムガ ナクナリマシタ
ヒンパ ン: KX-FAN141

Install a new ink film.

Replacement ink film:

KX-FAN141 (50 m) ¥1400

• As of January 2004.

• Tax not included.

Installations and connections

Installing recording paper (A4 size)

1 Install the recording paper tray.

- ① Separate the recording paper cover from the recording paper tray.

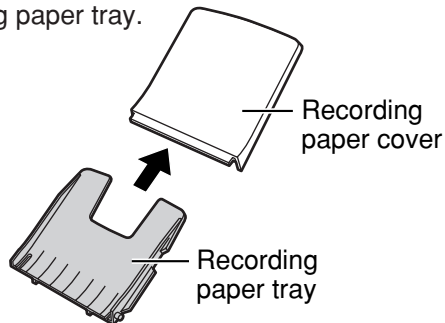

- ② Insert the left tab on the recording paper tray into the left slot of the main unit.

- ③ Insert the right tab into the right slot of the main unit.

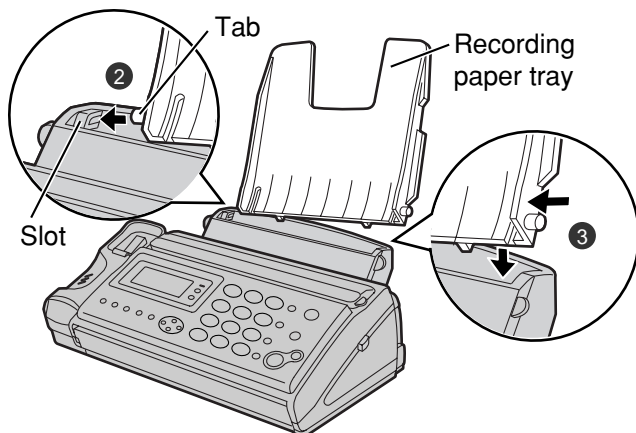

2 Insert the recording paper into the recording paper tray.

- ① Open the paper entrance cover until it locks.

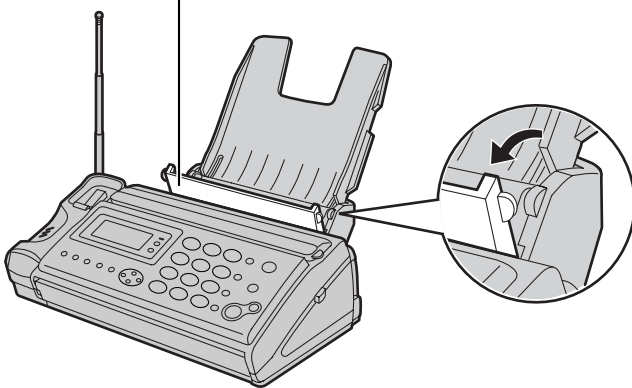

- ② Fan the stack of recording paper (A4 size).

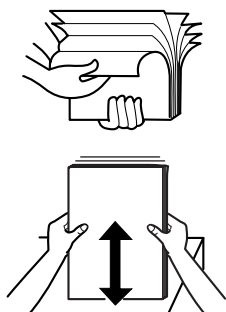

- ③ Insert the recording paper into the recording paper tray. (Up to 30 sheets)

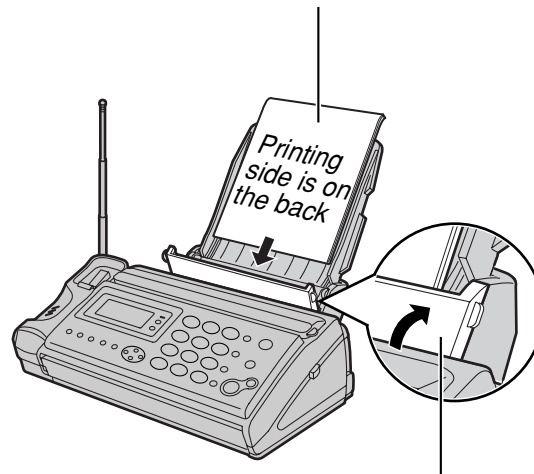

- ④ Close the paper entrance cover by leaning it back.

3 Install the recording paper cover on the recording paper tray by sliding it down from the top.

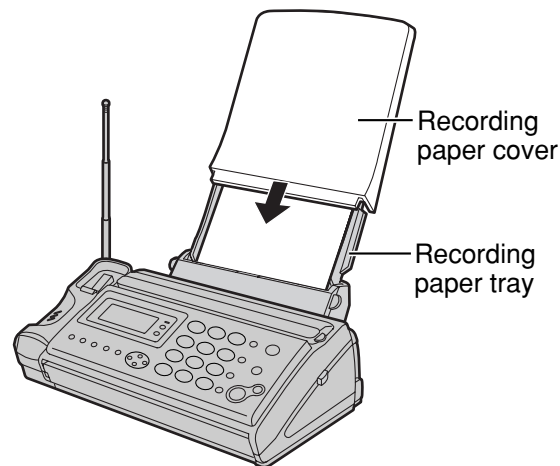

• To add paper

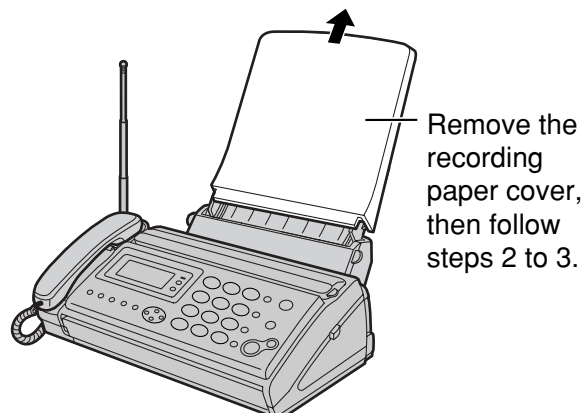

Installations and connections

Connecting the main unit

- 1 Connect the cord and place the handset on the main unit.
 - 2 Raise the antenna.
 - 3 Connect the telephone line cord (Supplied accessory).
 - 4 Connect the power cord.
-
- Click
- Click
- Click
- Click
- Click
- Handset
- Telephone line cord
- Wall jack
- Power outlet (AC 100V)
- Power cord

After the Power On...

This unit will automatically select the dialing mode (Tone/Pulse).

Setting up the portable handset

- 1 Charge the battery in the charger for 10 hours.
 - 2 Charge the battery in the charger for 10 hours.
 - 3 Charge the battery in the charger for 10 hours.
- After your Panasonic battery is fully charged, it will last up to about 7 hours of conversation.
-
- Charger
- Power outlet (AC 100 V)
- AC adaptor
- Plug
- Battery
- Connector
- Battery cover
- Click
- Click
- Click

Charge indicator 
-lights red: while charging.
-lights off: charging completed.

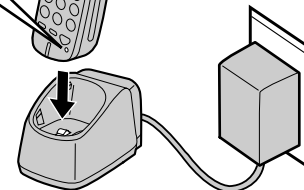

Setting the date and time

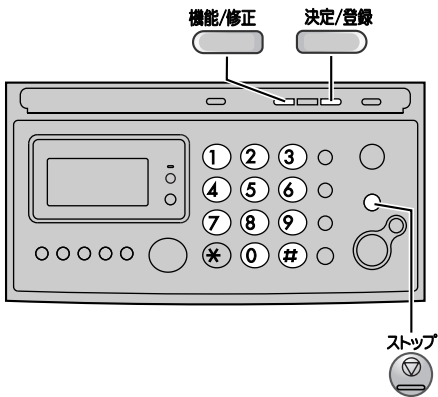

1 Open the document cover and press **機能/修正** (Function/Edit).

キノウ トウロク モード
[センタク] オス

2 Press **# 0 0 1**.

Example : 2004年06月01日
20:10
Cursor

3 Enter the correct year/month/day.
Example: October 1, 2004

Press **2 0 0 4 1 0 0 1**.

2004年10月01日
20:10

4 Enter the correct hour/minute in a 24-hour clock entry.
Example: 15:45 (3:45 PM)

Press **1 5 4 5**.

2004年10月01日
15:45

5 Press **決定/登録** (Set/Register).

トウロク シマシタ



2004年10月01日
15:45

6 Press **ストップ** (Stop).

Example : 10月 1日 15:45
ヨウケン ロクオン 00ケン

Setting your facsimile telephone number

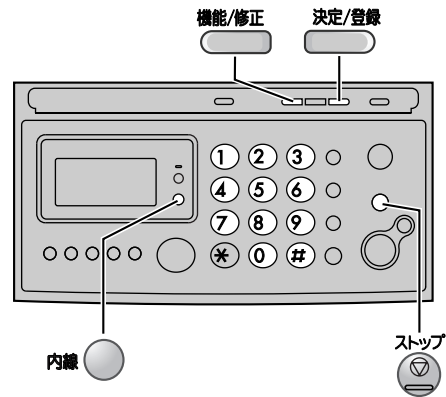

1 Open the document cover and press **機能/修正** (Function/Edit).

キノウ トウロク モード
[センタク] オス

2 Press **# 0 0 4**.

アナタノテ`ソウハ`ソコ`ウ?
TEL=.....
Cursor

3 Enter your facsimile telephone number, up to 20 digits.
Example: 098 765 43..

アナタノテ`ソウハ`ソコ`ウ?
TEL=8,765,43..

The **内線** (Space) button replaces the digit with a space.

4 Press **決定/登録** (Set/Register).

トウロク シマシタ



アナタノテ`ソウハ`ソコ`ウ?
TEL=098 765 43

5 Press **ストップ** (Stop).

Example : 10月 1日 15:45
ヨウケン ロクオン 00ケン

Setting your logo

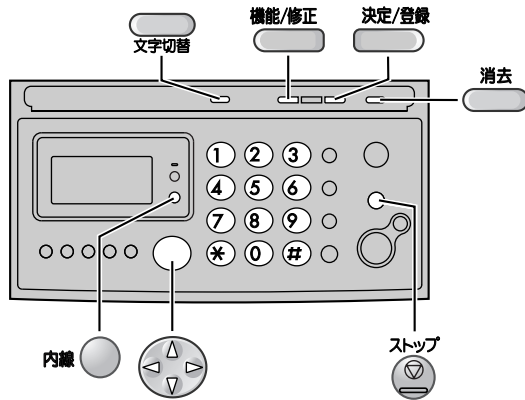

1 Open the document cover and press **機能/修正** (Function/Edit).

キノウ トウロク モード
[センタク] オス

2 Press **# 0 0 2**.

アナタノナマイ?
Cursor

3 Enter your logo, up to 30 characters, using the dial keypad.

- To enter English characters easily, press **文字切替** (Character input mode) repeatedly and select “英” (English and sign input mode).
- For details, see the table on page 9 for instructions.

Example: Micah

1. Press **6** once.

アナタノナマイ?
M
Cursor

2. Press **4** six times.

アナタノナマイ?
Mi

3. Press **2** six times.

アナタノナマイ?
Mic

4. Press **方向キー** to move the cursor to the next space and press **2** four times.

アナタノナマイ?
Mic a

5. Press **4** five times.

アナタノナマイ?
Micah

4 Press **決定/登録** (Set/Register).

トウロク シマシタ











アナタノナマイ?
Micah



5 Press **ストップ** (Stop).

Example : 10月 1日 15:45
ヨウケン ロクオン 00ケン

Character input and command key table

Pressing the dial keys will select a character as shown below.

Character		Katakana	English	Numbers
Display of the main unit		カナ	英	数
Display of the portable handset		[カナ]	[AB]	[12]
Dial key				
(Main unit)	(Portable handset)			
①	①	アイウエオアイウエオ	@ . _ - & \$ ¥ % + = ~ ^	1
②	②	カキクケコ	A B C a b c	2
③	③	サシスセソ	D E F d e f	3
④	④	タチツテトツ	G H I g h i	4
⑤	⑤	ナニヌネノ	J K L j k l	5
⑥	⑥	ハヒフヘホ	M N O m n o	6
⑦	⑦	マミムメモ	P Q R S p q r s	7
⑧	⑧	ヤユヨヤユヨ	T U V t u v	8
⑨	⑨	ラリルレロ	W X Y Z w x y z	9
⑩	⑩	ワヲンー!? ()	! ? / - * # , ; : . ' " () [] { } 「 」	0
✳	✳	ゝ っ っ っ	ゝ っ	
Command keys		 (Main unit),  (Portable handset)	Used to change the character input mode.	
		 (Main unit),  (Portable handset)	Used to move the cursor to the left and right.	
		 (Main unit),  (Portable handset)	Used to delete a character.	
		 (Main unit),  (Portable handset)	Used to insert a space.	

- When entering e-mail address, the small letters are displayed before the capital letters.
- When entering e-mail address, you can not enter the following symbols: 
- When entering e-mail message, pressing  enables you to begin the new line. (“” is displayed.)
- The characters on the display are somewhat different from those shown in the character input and command key table.

Automatic dialing on the main unit

Storing telephone numbers in the one-touch dial

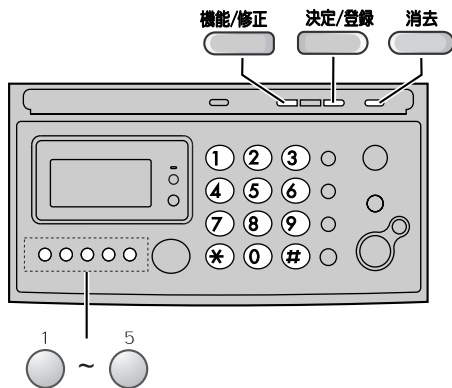

1 Press **機能/修正** (Function/Edit).

2 Press the desired one-touch dial button (1 to 5).
Example: one-touch dial 1

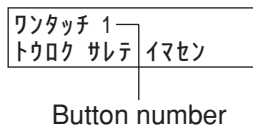

3 Enter the telephone number, up to 30 digits.
• To correct a mistake, press **消去** (Clear).

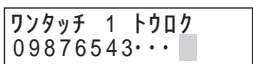

4 Press **決定/登録** (Set/Register).

Making a voice call using the one-touch dial

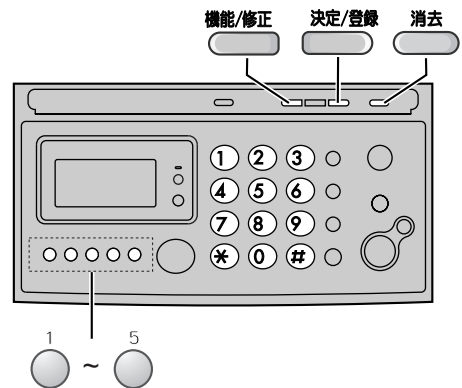

1 Press the desired one-touch dial button (1 to 5).
• The unit will start dialing.

2 When the other party answers, lift the handset.

Editing a stored number in the one-touch dial

1 Press **機能/修正** (Function/Edit).

2 Press the desired one-touch dial button (1 to 5).

3 Edit the telephone number.

4 Press **決定/登録** (Set/Register).

Erasing a stored number in the one-touch dial

1 Press **機能/修正** (Function/Edit).

2 Press the desired one-touch dial button (1 to 5).

3 Press and hold **消去** (Erase) until the telephone number has been erased.

4 Press **決定/登録** (Set/Register).

Automatic dialing on the main unit

Storing names and telephone numbers in the phonebook

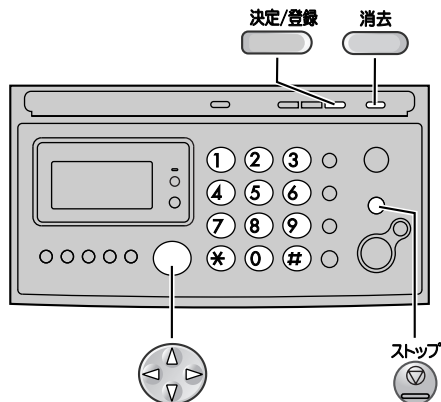

1 Press  (Phonebook).

トウロク ハ [ケッテイ]オス
ケンサク ハ []オス

2 Press  (Set/Register).

- “XXX” shows the remaining station numbers you can store.

テ`ソワチョウ アキXXXケン

- You can program up to 100 stations, including 4 pre-programmed stations.

3 Enter the name, up to 12 characters (see the table on page 9 for instructions).

4 Press  (Set/Register).

5 Enter the telephone number, up to 30 digits.
• To correct a mistake, press  (Clear).

6 Press  (Set/Register).

- To program other items, repeat steps 3 to 6.

7 Press  (Stop) to exit the program.

Making a voice call using the phonebook

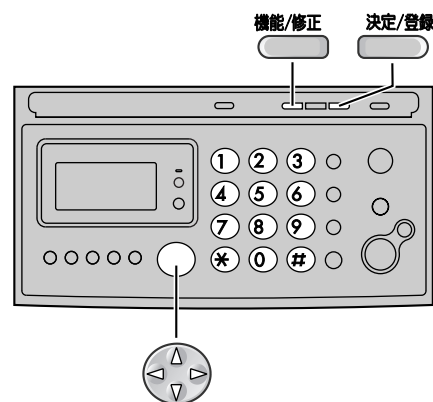

1 Press  (Phonebook).

2 Press  (Search button) repeatedly until the desired name is displayed.

3 Lift the handset.

Editing a stored name or number in the phonebook

1 Press  (Phonebook).

2 Press  (Search button) repeatedly until the desired name is displayed.

3 Press  (Function/Edit).

4 Edit the name (see the table on page 9 for instructions).
• If you do not need to edit the name, skip to step 5.

5 Press  (Set/Register).

6 Edit the telephone number.
• If you do not need to edit the telephone number, skip to step 7.

7 Press  (Set/Register).

Automatic dialing on the portable handset

Storing names and telephone numbers in the phonebook

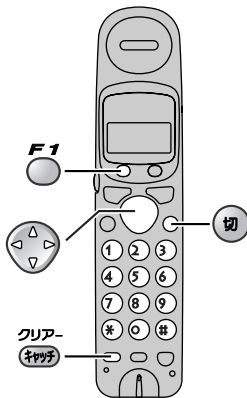

1 Press (Phonebook).

テ`ンワチヨウ ケンサク
ナマエ? [カナ]



ケンサクハ
[]オス

2 Press (Register).

- “XXX” shows the remaining station numbers you can store.
- You can program up to 100 stations, including 4 pre-programmed stations.

テ`ンワチヨウ トウロク
アキ xxxケン



ナマエ? [カナ]

3 Enter the name, up to 12 characters (see the table on page 9 for instructions).

4 Press (Register).

5 Enter the telephone number, up to 30 digits.

- To correct a mistake, press (Clear).

6 Press (Register).

- To program other items, repeat steps 3 to 6.

7 Press (Off) to exit the program.

Making a voice call using the phonebook

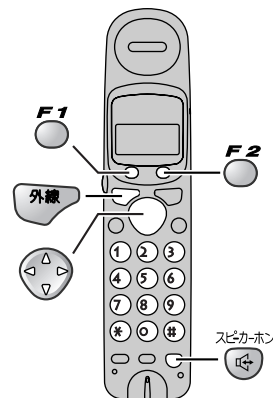

1 Press (Phonebook).

2 Press (Search button) repeatedly until the desired name is displayed.

3 Press (Talk) or press (Speakerphone).

Editing a stored name or number in the phonebook

1 Press (Phonebook).

2 Press (Search button) repeatedly until the desired name is displayed.

3 Press (Edit).

4 Press .

5 Edit the name (see the table on page 9 for instructions).
• If you do not need to edit the name, skip to step 6.

6 Press (Register).

7 Enter the correct telephone number.
• If you do not need to edit the telephone number, skip to step 8.

8 Press (Register).

Intercom between the main unit and portable handset

An intercom is available between the main unit and portable handset.

Using the main unit:

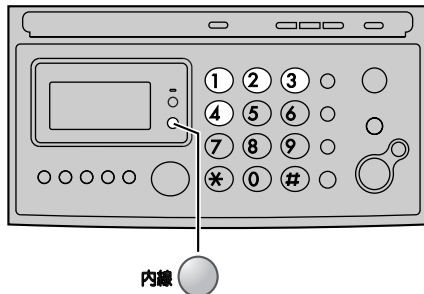

1 ■ For single portable handset users

- ① Lift the handset.

ハンコウ?

- ② Press **内線** (Intercom).

コキ1 ヨビタシチュウ

■ For multiple portable handset users

- ① Lift the handset.
② Press **内線** (Intercom).
③ Press the portable handset number (① to ④) which you want to call.

ナイセン ハンコウ
[12..]オス

2 Start talking.

コキ1 ナイセンツウワ チュウ

3 Replace the handset to end the intercom call.

Using the portable handset:

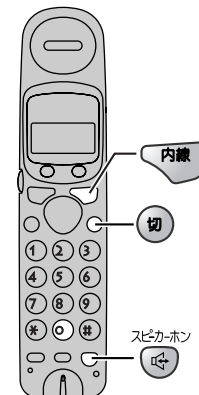

1 ■ For single portable handset users

- Press **内線** (Intercom).

■ For multiple portable handset users

- Press **内線** (Intercom), then press ① .

2 Start talking.

- You can switch to the speakerphone by pressing **スピーカーホン** (Speakerphone).



ナイセンツウワ チュウ

3 Press **切** (Off) to end the intercom call.

Sending faxes

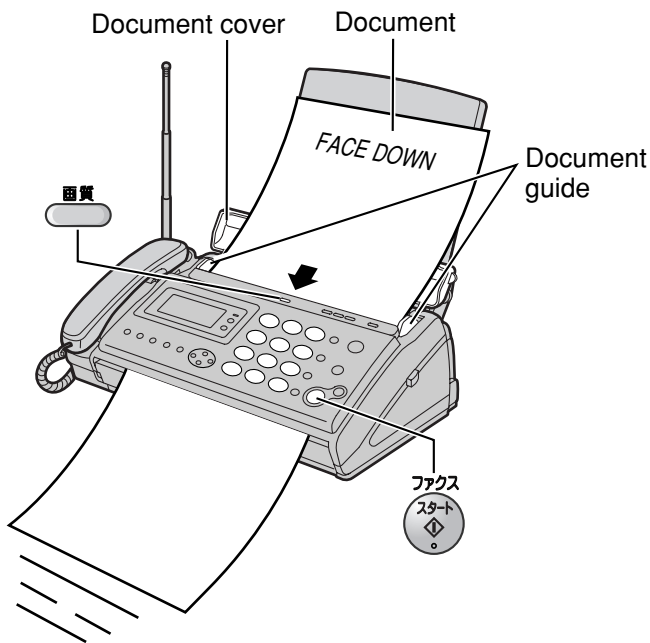
Sending a fax manually





- 1 Open the document cover, and adjust the width of the document guides to the size of the document.
- 2 Insert the document (up to 5 pages) FACE DOWN until a single beep is heard.
- 3 If necessary, press  (Resolution) repeatedly to select the desired setting (see below).
- 4 Dial the fax number.
- 5 Press  (Fax).
 - The unit will start fax transmission.

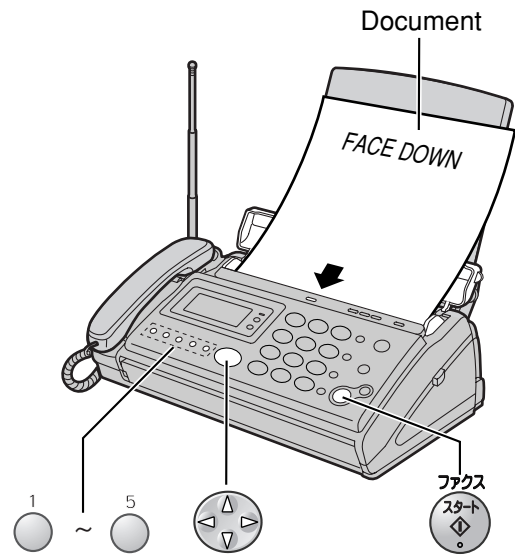

Sending a fax using automatic dialing



Using the one-touch dial

- 1 Insert the document (up to 5 pages) FACE DOWN until a single beep is heard.
- 2 Press the desired one-touch dial button ( to ).
 - The unit will start fax transmission.

Using the phonebook

- 1 Insert the document (up to 5 pages) FACE DOWN until a single beep is heard.
- 2 Press  (Phonebook).
- 3 Press  (Search button) repeatedly until the desired name is displayed.
- 4 Press  (Fax).
 - The unit will start fax transmission.

To select the resolution

Select the desired resolution according to the type of document, by pressing  (Resolution).

 (Standard) for printed or typewritten originals with normal-sized characters.

 (Fine) for originals with minute printing.

 (Photo) for originals containing photographs.

Receiving faxes

Receiving a fax manually (AUTO ANSWER off)

Using the main unit:

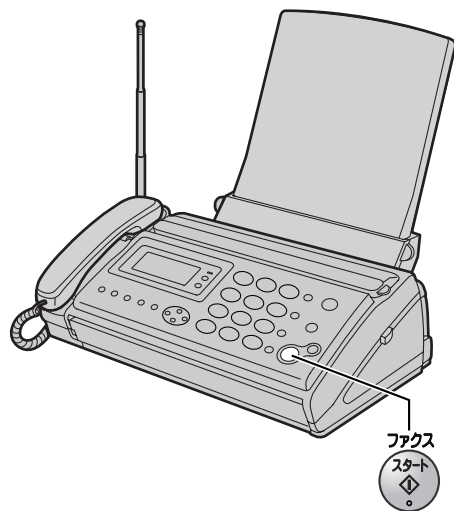



1 When you hear a ring, lift the handset to answer the call.

2 When:
– document reception is required,
– a fax calling tone (slow beep) is heard, or
– no sound is heard,
press  (Fax), then replace the handset.
• The unit will start fax reception.

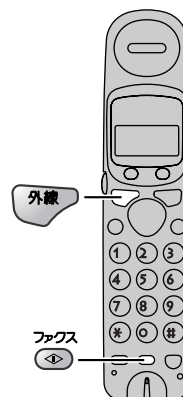
Using the portable handset:



1 When you hear a ring, lift the portable handset from the charger to answer the call.
• If the portable handset is not set on the charger, press  (Talk).

2 When:
–document reception is required,
–a fax calling tone (slow beep) is heard, or
–no sound is heard,
press  (Fax reception) until a single beep is heard.
• The main unit will start fax reception.

Receiving faxes

Receiving a fax automatically (AUTO ANSWER on)

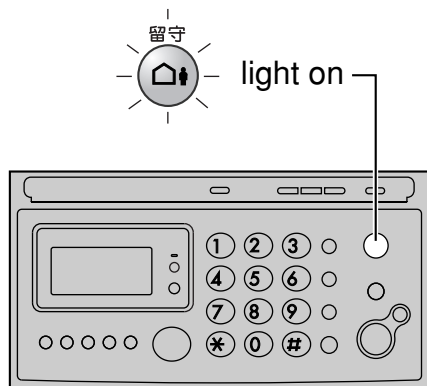

1 If the (Auto answer) light is off, turn it on by pressing .

2 When receiving a call, the unit will receive a fax document or record a voice message automatically depending on the caller's request.

Operating the built-in answering device

Recording your own greeting message

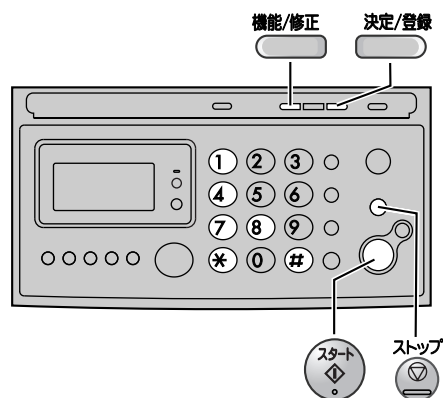

You can record your own greeting message. When receiving a call, it will be played to callers instead of the pre-recorded Japanese greeting message.

1 Press (Function/Edit).

2 Press .

シ* サク オウトウ ロクオン
[ケッテイ] オス

3 Press (Set/Register).

4 Lift the handset.

5 Press (Start) and speak your greeting message, up to 16 seconds, to the handset.

6 Press (Stop) and replace the handset.
• Your greeting message will be played back automatically.

Erasing your own greeting message

1 Press (Function/Edit).

2 Press .

シ* サク オウトウ ショウキョ
[ケッテイ] オス

3 Press (Set/Register).

4 Press .

• The pre-recorded Japanese greeting message will be played when you receive a call.

Operating the built-in answering device

Activating the answering device

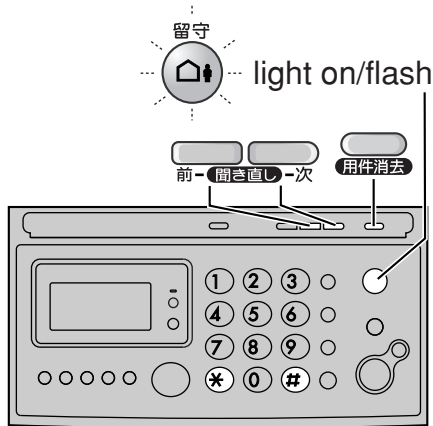

- 1 Turn the (Auto answer) light on by pressing .
- 2 When receiving a call, a greeting message will be played and the unit will record a voice message.
 - To record your own greeting message, see page 16.

Listening to recorded messages

When new messages are recorded, the (Auto answer) light will flash.

Press to listen to recorded messages.

After the messages are played back, the following will be displayed.

- To erase the messages, press . サイセイシタヨウケンショウキヨ
入ル=* シナイ=#
- To save the messages, press .

Listening to all of the recorded messages

Press or (Replay).

After the messages are played back, the following will be displayed.

- To erase the messages, press . サイセイシタヨウケンショウキヨ
入ル=* シナイ=#
- To save the messages, press .

Erasing a specific message

Press (Erase) while listening to the message you want to erase, then press .

Erasing all of the recorded messages

- 1 Press (Erase).

スヘ* テ ショウキヨシマスカ?
ハイ=* イイエ=#

- 2 Press .

Operating the answering device from a remote location

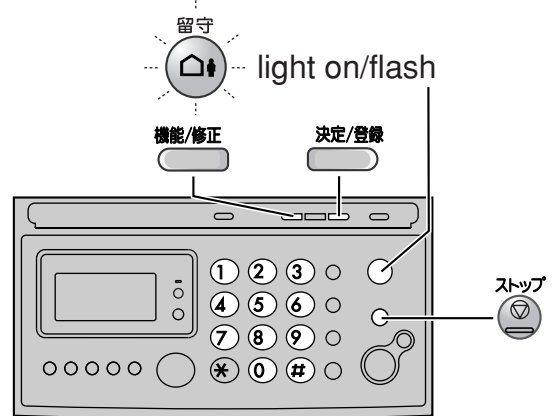

Preparation: Programming the remote operation ID

1. Press (Function/Edit).
2. Press .
3. Enter any 4-digit number (remote operation ID) except * or #.
Example : アソシヨウ No. = 1234
[4ケタ, トウロク] オス
4. Press (Set/Register).
5. Press (Stop).

Operation: Listening to a recorded message from a remote location

Turn the (Auto answer) light on before you go out. Remote operations are available only from a touch tone telephone.

1. Call your unit.
2. Enter the remote operation ID during the greeting message.
3. Press or wait 4 seconds.
 - Only the new recorded messages will be played back.
 - To listen to all the recorded messages, press after the new messages have been played back.

Individual e-mail services

Using the e-mail services

Panasonic Communications Co., Ltd. (hereafter called "PCC") offers individual information services, such as e-mail.

Your fax machine with e-mail features will enable you to send an e-mail to another party's personal computer (PC) or another e-mail fax machine anywhere in the world through the Internet. Also, you will be able to receive an e-mail from them.

To access the Internet using your fax machine,

- you need a credit card (VISA, JCB or MASTER as of January 2004) and
- have to subscribe to individual information services offered by PCC beforehand.

The application fee including call charges will be charged to your Credit Card.

Important:

- If your fax machine is connected to a home telephone system or a private branch exchange (PBX) system, these services are not available.

Application fee and call charges

PCC information services	Registration fee	¥500
	Information Service fee (Call charge included)	¥20/minute (8 am-11 pm) ¥18.5/minute (11 pm-8 am)

- As of January 2004.
- Tax not included.

PCC information services

The following services are available with your fax machine. The information service fee including the call charge will be applied.

- E-mail reception and printing (page 20)
- Text e-mail sending (page 21)
- Fax e-mail sending (page 22)
- Others

Note:

- PCC plans to add new information services and the information service fee is subject to change. PCC will announce them by e-mail to its customers.
- For the PC user to view your fax e-mail sent from your fax machine, the following PC software will be required.
 - E-mail software that can read the MIME format
 - TIFF viewer software

Individual e-mail services

Subscribing to PCC information services

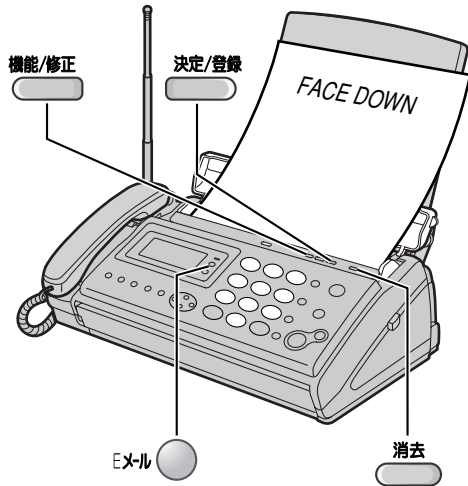

1 Fill in the included application form.

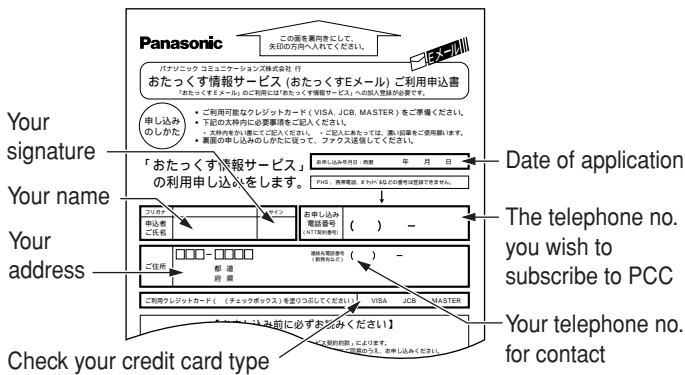

2 Press **機能/修正** (Function/Correct), then press **Eメール** (E-mail).

3 Press **決定/登録** (Set/Register).

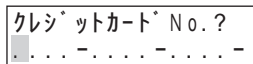

4 Enter your 16-digit credit card number.

- To correct a mistake, press **消去** (Clear).

5 Press **決定/登録** (Set/Register).

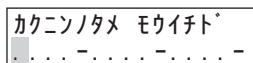

6 Enter your credit card number again, then press **決定/登録** (Set/Register).

7 Enter the valid date of your credit card.

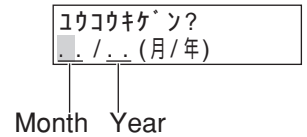

8 Press **決定/登録** (Set/Register).

9 Insert the application form FACE DOWN.

10 Press **決定/登録** (Set/Register).

- The unit will start fax transmission.

11 After approx. 5 minutes, the unit will ring, and a data communication will start automatically between your unit and PCC.

- If you answer this call, hang up and wait for a while until the communication is completed.

12 When the communication is completed, a user registration form will be printed.

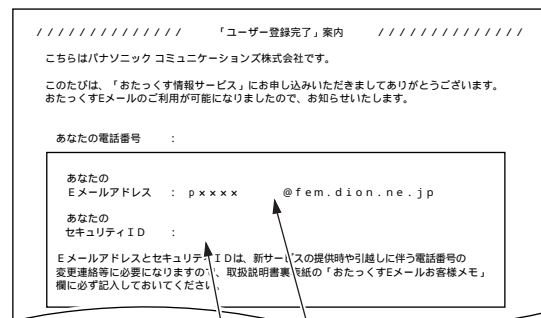

Your e-mail address
Your security ID code

- Please save the address and ID code for future reference.

13 Press **Eメール** (E-mail).

14 Press **決定/登録** (Set/Register).

- An information service guide will be printed.

Individual e-mail services

Receiving and printing an e-mail

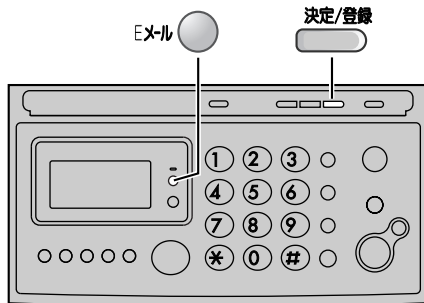

1 Press **Eメール** (E-mail) .

2 Press **決定/登録** (Set/Register).

- If there is an e-mail you have not viewed yet, the unit will print the received e-mail.
- If there is no e-mail, the following will be displayed.

ミシ ュジョンEメール 0ケン

The file formats recognized by your fax machine are:

- JPEG • ~. doc
 - TIFF • ~. xls
 - BMP • ~. ppt
 - TXT • ~. pdf
- (as of January 2004)

Individual e-mail services

Sending a text e-mail from the main unit

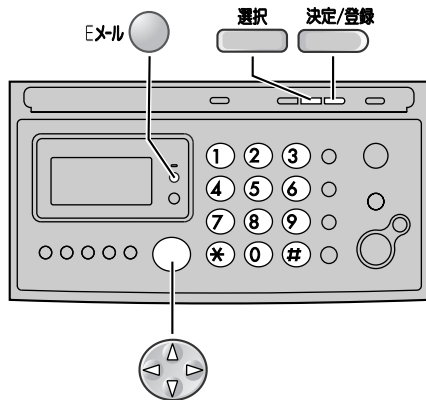

1 Press **Eメール** (E-mail).

2 Press **選択** (Select).

モシ* Eメール ソウジン
[ケッテイ] オス

3 Press **決定/登録** (Set/Register).

4 Enter the desired e-mail address (see the table on page 9 for instructions).

- You can enter the address of the last e-mail you sent by pressing **再ダイヤル** (Redial).

- You can select the desired address using the addressbook.

1. Press **電話帳** (Addressbook).

2. Press **再ダイヤル** (Search button) repeatedly until the desired name is displayed.

3. Press **決定/登録** (Set/Register).

To store an address, see page 23.

5 Press **決定/登録** (Set/Register).

6 Enter the title of your e-mail, up to 32 characters (see the table on page 9 for instructions).

- You can enter the title of the last e-mail you sent by pressing **再ダイヤル** (Redial).

7 Press **決定/登録** (Set/Register).

8 Enter your e-mail message, up to 200 characters (see the table on page 9 for instructions).

- You can enter the message of the last e-mail you sent by pressing **再ダイヤル** (Redial).

9 Press **決定/登録** (Set/Register).

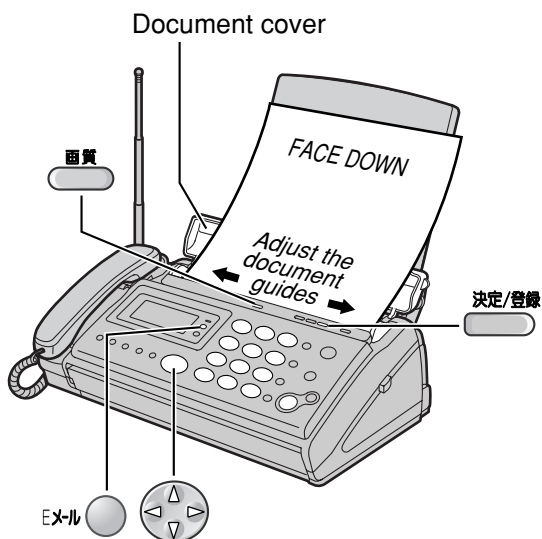

Sending a fax e-mail



1 Open the document cover, and adjust the width of the document guides to the size of the document.

2 Insert the document (up to 5 pages) FACE DOWN until a single beep is heard.

3 If necessary, press  (Resolution) repeatedly to select the desired setting (see page 14).

4 Press  (E-mail), then press  (Set/Register).

5 Enter the desired e-mail address (see the table on page 9 for instructions).

- You can enter the address of the last e-mail you sent by pressing  (Redial).

- You can select the desired address using the addressbook.

1. Press  (Addressbook).

2. Press  (Search button) repeatedly until the desired name is displayed.

3. Press  (Set/Register).

To store an address, see page 23.

6 Press  (Set/Register).

7 Enter the title of your fax e-mail, up to 32 characters (see the table on page 9 for instructions).

- You can enter the title of the last e-mail you sent by pressing  (Redial).

8 Press  (Set/Register).

Individual e-mail services

Storing names and e-mail addresses in the addressbook

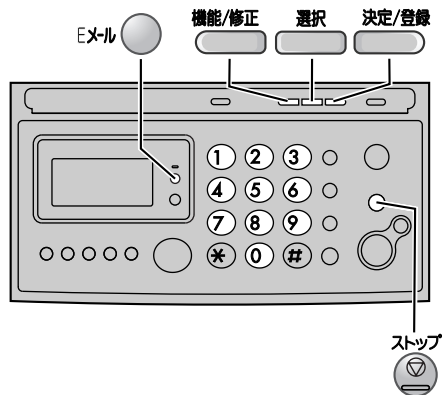

- 1 Press **機能/修正** (Function/Edit), then press **Eメール** (E-mail).
- 2 Press **選択** (Select) repeatedly until the following is displayed.

アドレス チョウ
[ケッテイ] オス
- 3 Press **決定/登録** (Set/Register) twice.
- 4 Enter the name, up to 12 characters (see the table on page 9 for instructions).
- 5 Press **決定/登録** (Set/Register).
- 6 Enter the e-mail address, up to 60 characters (see the table on page 9 for instructions).
- 7 Press **決定/登録** (Set/Register).
 - To program other items, repeat 4 to 7.
- 8 Press **ストップ** (Stop) to exit the program.

Editing a stored name or e-mail address in the addressbook

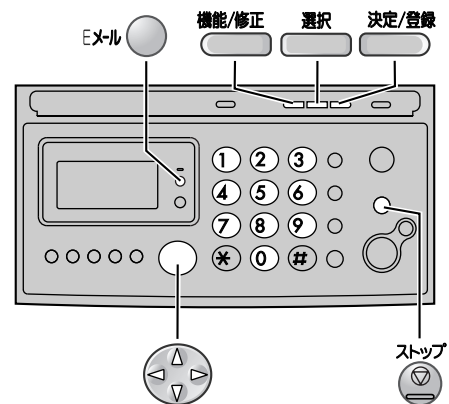

- 1 Press **機能/修正** (Function/Edit), then press **Eメール** (E-mail).
- 2 Press **選択** (Select) repeatedly until the following is displayed.

アドレス チョウ
[ケッテイ] オス
- 3 Press **決定/登録** (Set/Register).
- 4 Press **検索** (Search button) repeatedly until the desired name is displayed.
- 5 Press **機能/修正** (Function/Edit).
- 6 Edit the name (see the table on page 9 for instructions).
 - If you do not need to edit the name, skip to step 7.
- 7 Press **決定/登録** (Set/Register).
- 8 Edit the e-mail address (see the table on page 9 for instructions).
 - If you do not need to edit the e-mail address, skip to step 9.
- 9 Press **決定/登録** (Set/Register).
- 10 Press **ストップ** (Stop) to exit the program.

Specifications

KX-PW95CL KX-PW95CW	Main unit	Portable handset	Battery charger
Power supply	AC 100 V (50 Hz/60 Hz)	Ni-Cd battery (Part no. KX-FAN37) DC 2.4 V, 600 mAh	AC adaptor (Part no. PFAP1009) AC 100 V (50 Hz/60 Hz) DC 7.5 V, 100 mA
Power consumption	Transmission: Approx. 16 W Reception: Approx. 20 W Copy: Approx. 20 W Stand by: Approx. 0.6 W (When the F-net service is not in use.) Maximum(*1): Approx. 130 W		• Charging: Approx. 1.1 W • Stand by: Approx. 0.4 W
Dimensions (H x W x D)	Approx. 139 X 344 X 250 mm (without projections) Approx. 378 X 344 X 298 mm (recording paper tray installed, without projections)	Approx. 181 X 44 X 40 mm	Approx. 72 X 72 X 90 mm
Mass (Weight)	Approx. 3.7 kg (10 m ink film installed)	Approx. 170 g (battery installed)	Approx. 77 g
Operating environment	5 °C – 35 °C, 45 % – 85 % RH (Relative Humidity)		

KX-PW95CL KX-PW95CW	Main unit
Applicable line	Public Switch Telephone Network (Tone/Pulse), F-Net, NCC Lines
DC resistance	320 Ω (*2)
Compatibility	G3 compatible
Document size	B4-A5(Max.257 mm in width, Max. 800 mm in length)
Effective scanning size	252 mm (B4) 208 mm (A4)
Effective printing size	202 mm (A4 size plain paper)
Transmission time	Approx. 15 s/page (Original mode) (*3)
Modem speed	9,600 / 7,200 / 4,800 / 2,400 bps; Automatic fallback
Halftone level	64-level
Scanning density	Horizontal: 8 pels/mm Vertical : 7.7 lines/mm (Fine/Photo), 3.85 lines/mm (Standard)
Scanner type	Contact image sensor
Printer type	Thermal transfer printing on plain paper
Data compression system	Modified Huffman (MH), Original mode
Recording paper size	A4: 210 mm x 297 mm (Plain paper)
Answering device	Greeting message: Digital recording system (up to 16 sec) Pre-recording greeting message ICM Recording: Digital recording system (Approx. 18 min. in total) (*4)
Memory capacity	Max. Approx. 46 pages (Only receiving fax etc.) (*5) Max. Approx. 18 min. (Only Recording message) (*4)

*1 When copying a 100% black document.

*2 If you cannot make a call due to DC resistance, consult your dealer.

*3 Transmission speed is based on an A4-size document of 700 characters sent in standard resolution at 9,600 bps. The actual transmission speed depends upon the contents of the page, resolution, telephone line conditions and capability of the other party's machine.

*4 If there is a silent pause, the total recording time will be longer.

*5 The memory capacity is based on an A4-size document of 700 characters.

Free Manuals Download Website

<http://myh66.com>

<http://usermanuals.us>

<http://www.somanuals.com>

<http://www.4manuals.cc>

<http://www.manual-lib.com>

<http://www.404manual.com>

<http://www.luxmanual.com>

<http://aubethermostatmanual.com>

Golf course search by state

<http://golfingnear.com>

Email search by domain

<http://emailbydomain.com>

Auto manuals search

<http://auto.somanuals.com>

TV manuals search

<http://tv.somanuals.com>