

Panasonic

Telephone Answering System
with Facsimile

MODEL NO. **KX-F110**

Pulse-or-tone dialing capability

OPERATING INSTRUCTIONS



Please read before use.

FOR ASSISTANCE, CALL
1-800-CALL-FAX

Thank you for purchasing the Panasonic Telephone Answering System with Facsimile.

Before using the unit, please read these OPERATING INSTRUCTIONS.

You can then easily install, configure and operate the unit properly.

This unit combines multiple functions of Facsimile, Answering device and Telephone, so you can send and receive both voice-messages and documents on a single line.

Important information

If required by the telephone company, inform them of the following.

- FCC Registration No.: (found on the rear side of the unit)
- Ringer Equivalence: 0.2B
- The particular telephone line to which the equipment is connected.

The unit must not be connected to a coin operated line. If you are on a party line, check with your local telephone company.

Ringer Equivalence Number (REN):

This REN is useful in determining the quantity of devices you may connect to your telephone line and still have all of those devices ring when your telephone number is called. In most but not all areas, the sum of the REN's of all devices connected to one line should not exceed five (5.0). To be certain of the number of devices you may connect to your line, as determined by the REN, you should contact your local telephone company to determine the maximum REN for your calling area.

In the event that terminal equipment causes harm to the telephone network, the telephone company should notify the customer, if possible, that service may be stopped. However, where prior notice is impractical, the company may temporarily cease service providing that they:

- a) Promptly notify the customer.
- b) Give the customer an opportunity to correct the problem with their equipment.
- c) Inform the customer of the right to bring a complaint to the Federal Communication Commission pursuant to procedures set out in F.C.C. Rules and Regulations Subpart E of Part 68.

The Telephone Company may make changes in its communications facilities, equipment operations, or procedures where such action is reasonably required in the operation of its business and is not inconsistent with the rules and regulations in F.C.C. Part 68. If such changes can be reasonably expected to render any customer terminal equipment incompatible with telephone company communications facilities, or require modification or alteration of

such terminal equipment, or otherwise materially affect its use or performance, the customer shall be given adequate notice in writing, to allow the customer an opportunity to maintain uninterrupted service.

When programming emergency numbers and/or making test calls to emergency numbers:

1. Remain on the line and briefly explain to the dispatcher the reason for the call before hanging up.
2. Perform such activities in the off-peak hours; such as early morning or late evenings.

This telephone provides magnetic coupling to hearing aids.

WARNING:

TO PREVENT FIRE OR SHOCK HAZARD, DO NOT EXPOSE THIS PRODUCT TO RAIN OR ANY TYPE OF MOISTURE.

This equipment generates, uses, and can radiate radio frequency energy and if not installed and used in accordance with the instruction manual, may cause interference to radio communications. It has been tested and found to comply with the limits for a Class A computing device pursuant to Subpart J of Part 15 of FCC Rules, which are designed to provide reasonable protection against such interference when operated in a commercial environment. Operation of this equipment in a residential area is likely to cause interference in which case, the user at his own expense will be required to take whatever measures may be required to correct the interference.

Introduction

Multi-function system using one telephone line

General:

- Desk-top type
- Combined facsimile, answering device and integrated telephone
- Single telephone line operation
- Automatic facsimile/telephone switching
- Multi copier function
- Automatic paper cutter

Facsimile (FAX):

- CCITT G2/G3 compatibility
- Transmission time*: Approximately 15 seconds per page
- Automatic document feeder for up to 10 pages at a time
- One touch transmission with automatic dialer
- 16-level halftones
- Superb image quality
- Polling function
- Delayed transmission
- Network passcode communication
- Confidential communication
- Memory reception and transmission**
- Sends/receives 216 mm×600 mm (8½"×23⅝") pages at CCITT G2/G3
- Automatic fall back (9600/7200/4800/2400 bps)

*Transmission times apply to text data using CCITT No. 1 test chart, between same machine models at maximum modem speed. Transmission times vary in actual usage.

**Memory capacity (about 7 pages) applies to text data using CCITT No. 1 test chart in STANDARD resolution.

Telephone Answering Device (TAD):

- AUTO-LOGIC (One touch operation)
The unit automatically plays back all recorded messages and stops at the last message, then provides for answering the next call at the touch of a button.
- Time/day synthesized voice stamp
- Record 2-way telephone conversation
- Outgoing Message (OGM) stored on chip
- Remote control from touch tone telephone

Telephone System (TEL):

- Call monitor for on-hook dialing
- One touch dialing and speed dialing
- Automatic redialing
- Pulse-or-tone dialing capability

Speaking with the other party, and then transmitting/receiving a document

With the automatic facsimile/telephone switching feature, you can switch between facsimile and telephone functions on the same call. This means that even if you are in a telephone conversation and want to transmit/receive a document, you need only press the START/COPY button. Thereafter, facsimile transmission/reception can be performed automatically.

Three types of receiving modes

TAD/FAX mode:

When you wish to use the unit as a telephone answering device and a facsimile, select this mode. When a call is received during your absence, the unit records a voice-message and/or receives a document automatically depending on the caller's choice. In this mode, you also are able to speak with the other party and transmit/receive a document manually.

The unit automatically distinguishes between voice and fax calls.

- a) If the unit detects a fax tone during OGM, it will switch automatically to the fax mode.
- b) If the other party presses the asterisk (*) key during OGM or ICM recording mode, it will switch automatically to the fax mode.
- c) If the caller's voice is heard within 5 seconds of the end of the OGM, the unit functions as an answering device.

FAX mode:

When you wish to use the unit as a facsimile machine only, select this mode.

If someone calls you when you are in the FAX mode, a fax tone sounds and the person cannot talk to you. Please inform your callers that this is a fax only telephone number.

When in the FAX mode, you may still use the fax telephone to place outgoing voice calls.

TEL (Telephone) mode:

When you wish to use the unit as a standard telephone, select this mode. If you wish to receive the incoming fax during a telephone conversation, press the START/COPY button.

Table of contents

Important information	1
Introduction	2

Installation and Initial Preparation

Accessories	1-1
Installation connections	1-2
Location of controls	1-3
The buttons and indicators	1-5
Precaution	1-7
Micro cassette tape installation	1-8
Recording paper installation	1-9
Document feeder tray and receiving tray installation	1-11
Selector settings	1-13
Turning the POWER switch on	1-14
Recording an Outgoing Message (OGM)	1-15
Verifying your OGM	1-16
Suggested message	1-16
OGM backup	1-16
Re-recording OGM	1-16
User programming functions	1-17
Programming date and time	1-19
Programming your logo and fax telephone number identifiers	1-20
Preparation	1-20
Programming your logo and telephone number	1-21
Reference guide for the character keys	1-22
Programming phone numbers for automatic dialing	1-24
Programming phone numbers for one touch dialing	1-25
Programming phone numbers for speed dialing	1-27
Programming secret phone numbers	1-29
Listing the directory card	1-31

Basic Instructions

Facsimile

Before transmitting documents	2-1
Acceptable documents	2-1
Resolution and contrast	2-2
Transmitting documents	2-3
Manual transmission	2-3
Interrupting transmission	2-4
Adding extra pages	2-4
Transmitting documents using one touch dialing	2-5
Transmitting documents using speed dialing	2-6
Reserving transmission (XMT RESERVATION)	2-7
Setting the PAGE COUNTER and MESSAGE OUT	2-8
Receiving documents and/or voice-messages	2-9
Manual reception (Receiving documents during a conversation)	2-9
Automatic reception	2-10
Memory reception	2-11
Voice contact	2-12
Initiating voice contact	2-12
Receiving a request for voice contact	2-12
Transmitting documents to your unit	2-13
Leaving a message and transmitting documents on the same call	2-13
Transmitting documents with manual operation	2-14

Answering Device

Operating as an answering device	2-15
Setup of voice-message and document reception	2-16
Playing back recorded voice-messages	2-16
Voice time and day stamp	2-16
Recording after the messages you want to save	2-17
Monitoring incoming calls	2-17
Recording a memo message	2-18
Recording a 2-way conversation	2-19

Telephone and copy

Making and answering voice calls	2-20
Making calls	2-20
Redialing	2-20
Making voice calls using the automatic dialer	2-21
Answering voice calls	2-21
Making copies	2-22
Making copies	2-22

Advanced Instructions

Facsimile

Multi station transmission (MULTI XMT)	3-1
Polling	3-3
Being polled	3-3
Single station polling	3-4
Multi station polling	3-5
Turnaround polling	3-6
Setting the polling password	3-7
Delayed transmission/polling	3-8
Delayed single station transmission	3-8
Delayed multistation transmission	3-10
Delayed polling	3-11
Delayed turnaround polling	3-13
Memory transmission/polling	3-15
Memory transmission	3-15
Memory delayed transmission	3-17
Memory polling	3-18
Using the PRIORITY keys	3-19
Initial procedure for programming	3-20
Programming delayed single station transmission	3-21
Programming (delayed) multi transmission	3-22
Programming (delayed) single station polling	3-24
Programming (delayed) multi station polling	3-25
Programming (delayed) turnaround polling	3-27
Calling with PRIORITY keys	3-28
Confidential communications	3-30
Network communication	3-32
Using a passcode	3-33
Programming for network communication	3-35
Using network communication	3-37
Setting the REMOTE FAX ID	3-39
Transmitting a document with REMOTE FAX ID to your unit from a remote location	3-40

Answering Device

Operating as an answering device from a remote phone	3-41
Toll saver	3-41
Summary of remote control functions	3-41
Programming a REMOTE TAD ID number for remote operation	3-42
Message playback	3-43
Newly recorded messages playback (Memory playback)	3-43
Back space and skip forward	3-44

Recording a marker message	3-44
Resetting the tape for future messages	3-45
Room monitor	3-46
Re-recording an outgoing message	3-46
Skipping the OGM for ICM recording	3-47
Calling with privacy ring	3-48
Programming the PRIVACY RING ID	3-48
Calling with the privacy ring	3-49
Setting the auto receive timer	3-50

Telephone

Advanced dialing features	3-52
TONE button (Temporary tone dialing)	3-52
FLASH button	3-52
PAUSE button	3-52
Combination dialing	3-53

Printing Reports and Lists

Activity report (JOURNAL report)	4-1
Setting JOURNAL AUTO PRINT	4-2
Printing JOURNAL report manually	4-3
Individual transmission report (XMT REPORT)	4-4
Setting XMT REPORT	4-4
MULTI POLLING REPORT	4-5
MULTI TRANSMISSION REPORT	4-5
POWER DOWN REPORT	4-5
List of stored phone numbers (TELEPHONE NUMBER LIST) ..	4-6
SYSTEM SETUP LIST	4-7

System Programming Function

User programming functions	5-1
LOGO POSITION	5-1
MESSAGE OUT	5-2
FAX TX SPEED	5-3
FAX RX SPEED	5-3
AUTO STANDBY	5-4
TONE DETECT	5-4
MULTI COPY SORT	5-5
RECORDING TIME	5-5
CPC (Calling Party Control) MODE	5-6
TAD/FAX RING COUNT	5-6
FAX RING COUNT	5-7
TEST (PRINT/MOTOR)	5-7
SET DEFAULT	5-8
Service functions	5-9
Printing the SERVICE DATA LIST	5-9

Troubleshooting and Maintenance

Troubleshooting	6-1
Display messages	6-1
The ALARM indicator	6-2
Communication error code	6-2
General corrective measures	6-3
Paper jams	6-4
Maintenance	6-5
Cassette deck	6-5
Facsimile machine	6-6
Accessory order information	6-7
Specifications	6-7

Installation and Initial Preparation

Accessories

1. Carefully remove the unit from the packing carton.
2. Examine the unit for signs of shipping damage.
3. All of the necessary accessories, hardware, cords, etc., are packed with the unit. Make sure that you have removed all accessories before discarding the packing material.
4. Check that all of the accessories are included. If you are missing any item, consult your place of purchase.

Telephone line cord one

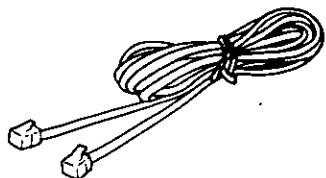

Handset..... one

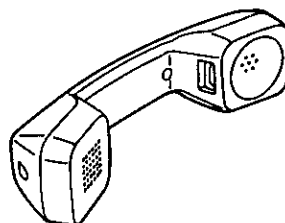

Micro cassette tape one

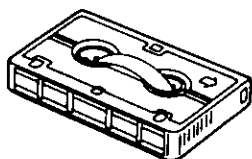

Handset cord..... one

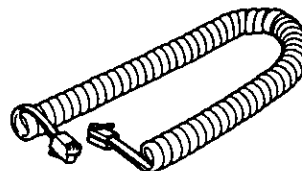

Document feeder tray one

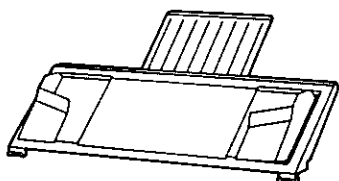

Recording paper..... one
216 mm x 15 m (8 1/2" x 49') roll

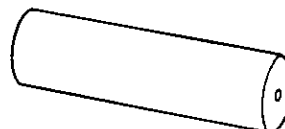

Receiving tray..... one

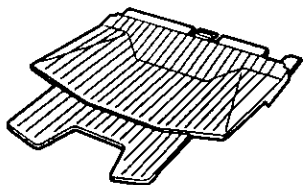

AC power cord one

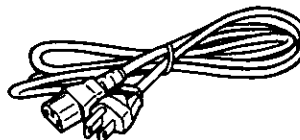

Diverter..... one

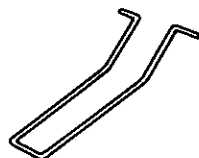

Print materials:

- Operating instructions
- Quick reference guide (English/Spanish)
- Quick reference card for tone remote control
- Fax correspondence sheet
- Registration card
- Speed dialer list

Installation connections

Connect the AC power cord, the telephone line cord and the handset cord as shown below. Then connect your unit to the AC outlet and the telephone line.

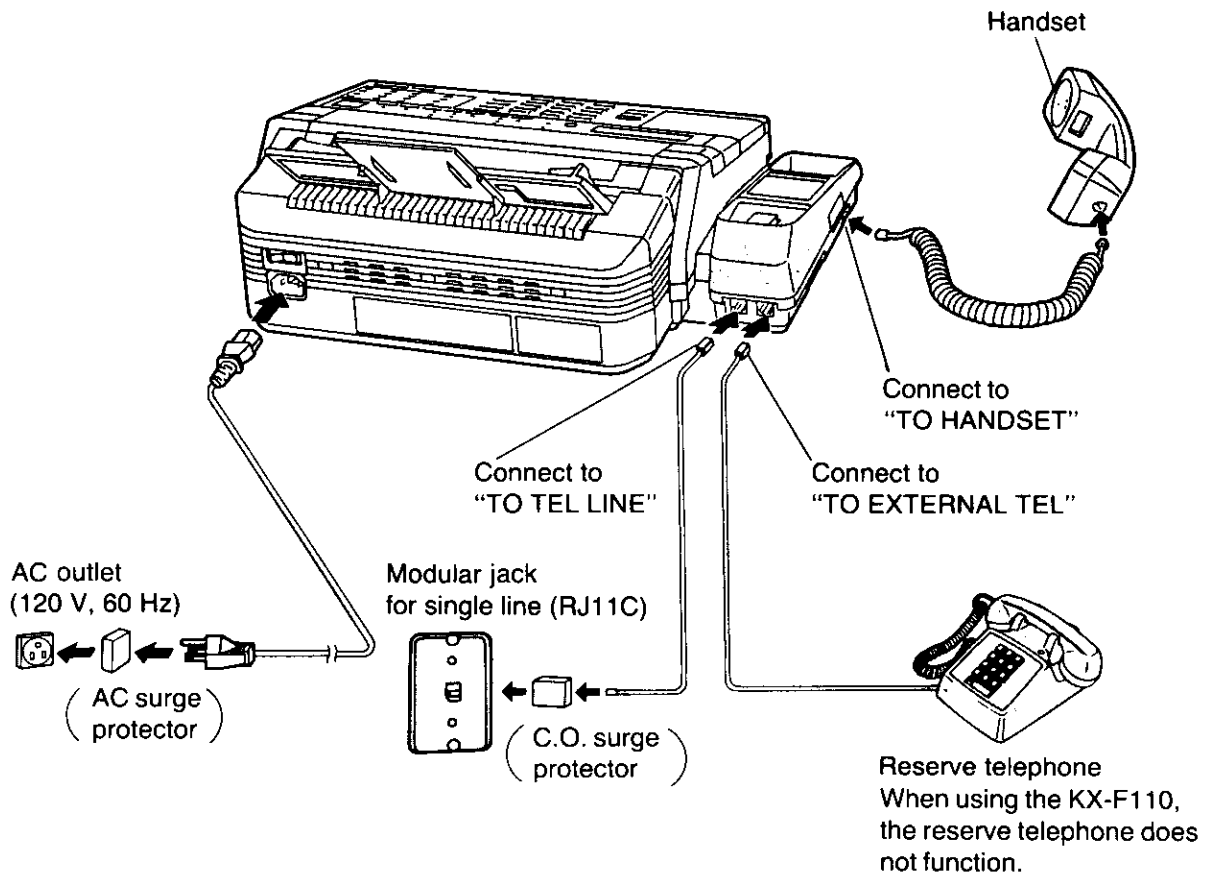

The unit including the telephone handset will not function during a power failure or power off. However, if you have a reserve telephone connected to the port of the "TO EXTERNAL TEL", you will still be able to make calls during a power failure or power off.

Avoid using the same AC outlet for the unit and other equipments. We recommend you to use an exclusive AC outlet to avoid interference from other equipment.

If you connect another extension to the same line that your unit is connected to, do not use another telephone during fax transmission and reception. It will affect image quality.

This unit is equipped with a 3-wire grounded type plug for safety. This plug will only fit into a grounding-type power outlet. If you are unable to insert the plug into your outlet, contact your electrician to replace your outlet.

In areas of frequent electrical storms and/or power failure, we recommend, for additional equipment protection, surge protectors such as TELESPIKE BLOK MODEL TSB (TRIPPE MFG. CO.), SPIKE BLOK MODEL SK6-0 (TRIPPE MFG. CO.), SUPER MAX (PANAMAX) or MP1 (ITW LINX).

Location of controls

Front view

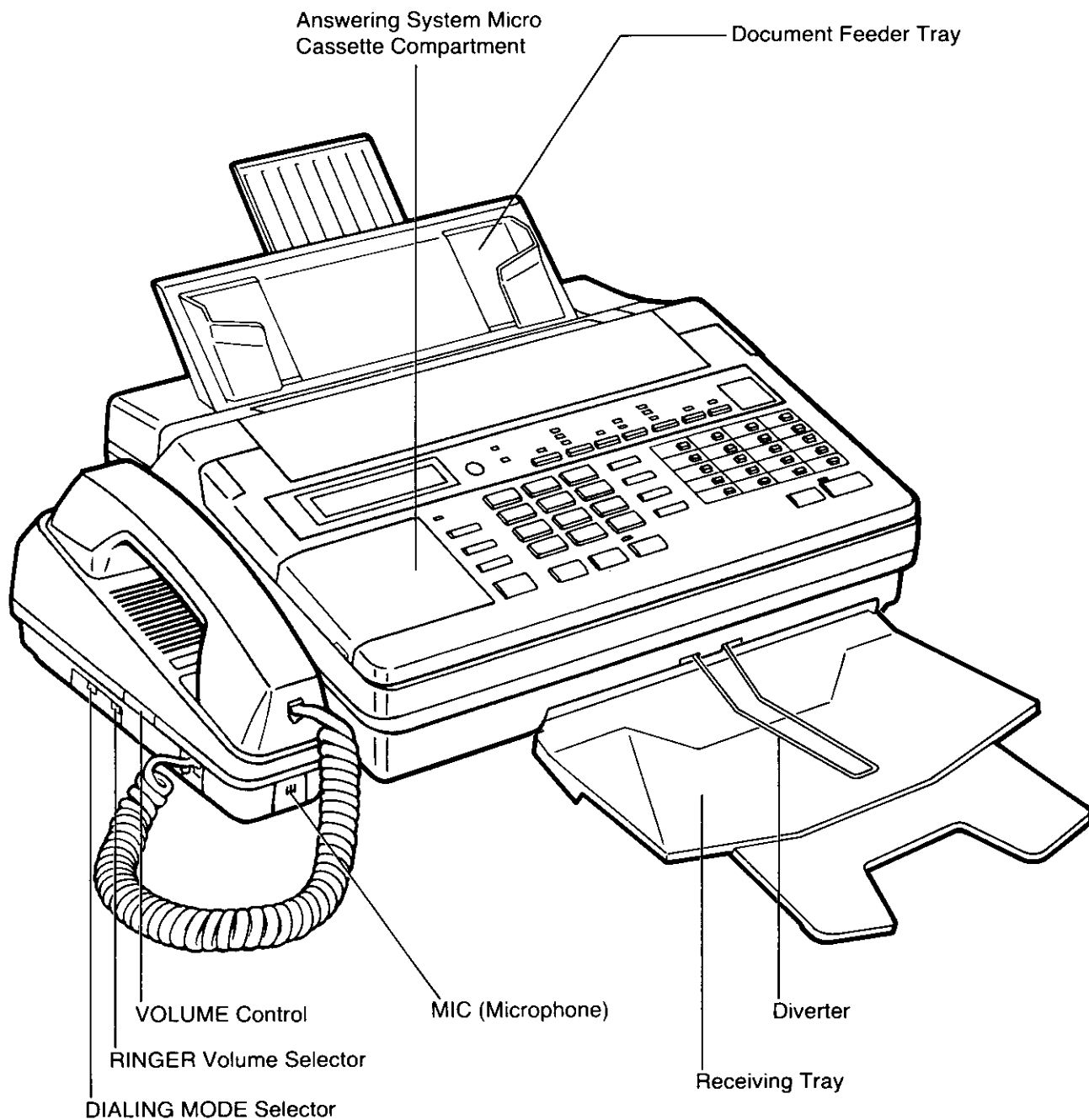

Rear view

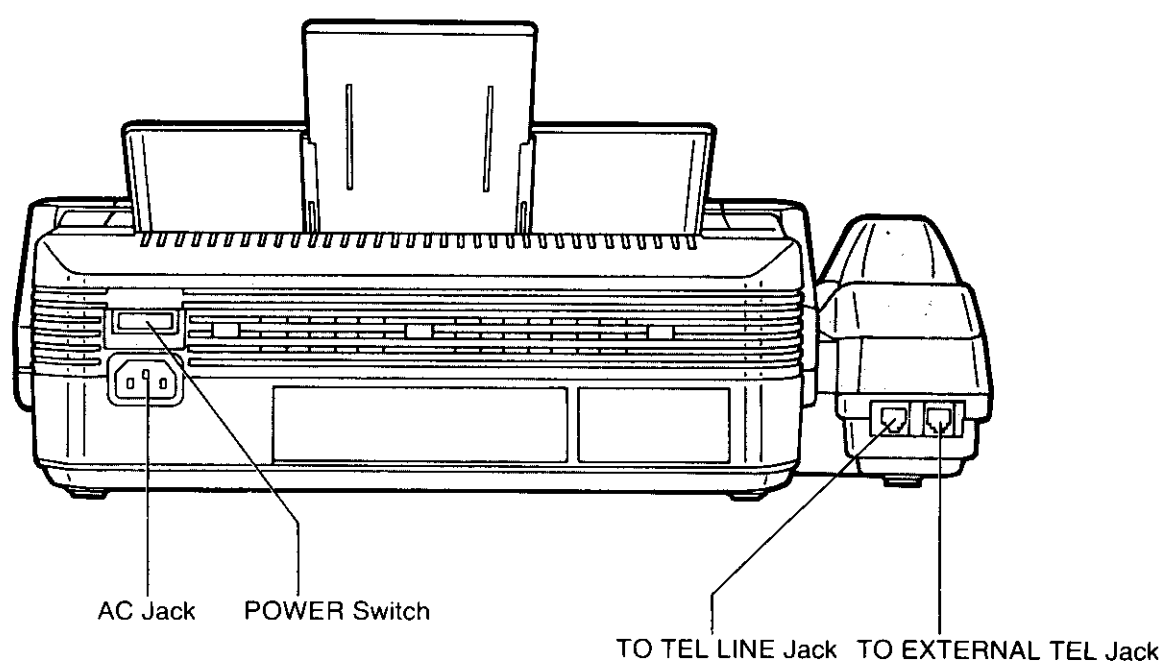

Side view

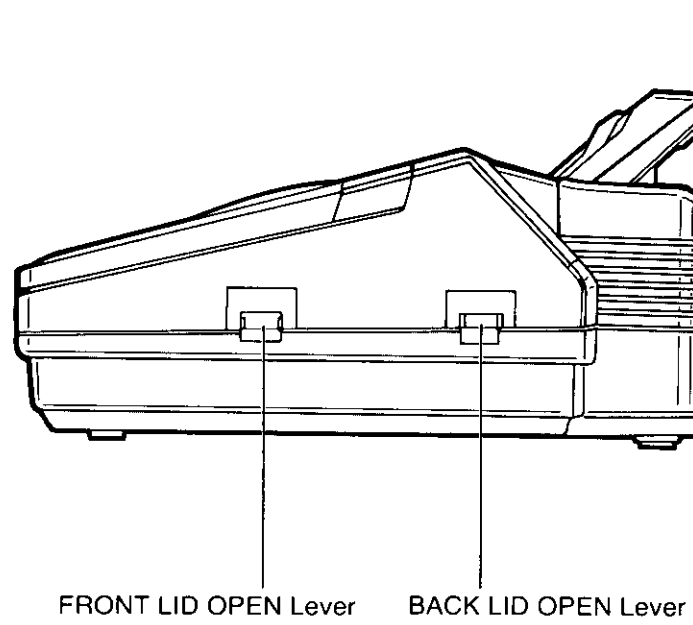

The buttons and indicators

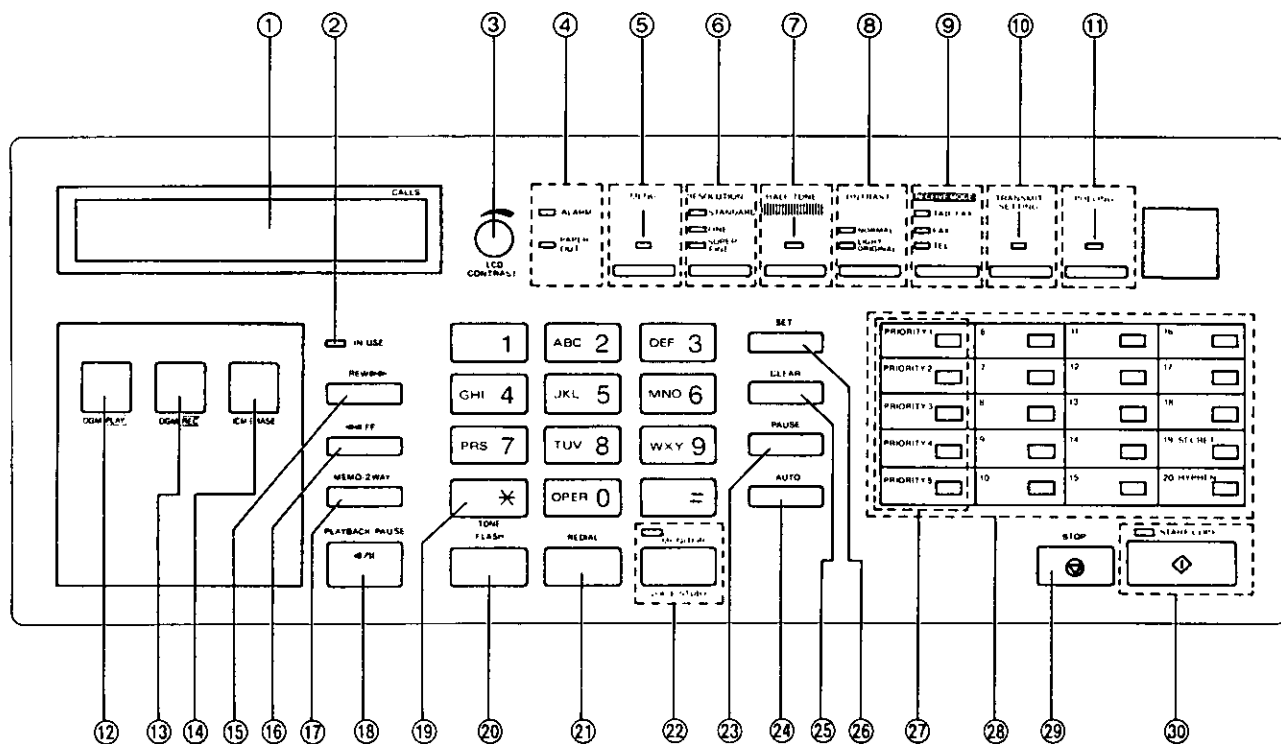

① LCD (Liquid Crystal Display)

② IN USE Indicator

The indicator lights or flashes when the answering device is in use.

③ LCD CONTRAST

Rotate to adjust to the best display intensity.

④ ALARM Indicator (Page 6-2)

The indicator lights when any trouble occurs.

PAPER OUT Indicator

The indicator lights when the recording paper roll is empty.

⑤ MENU Button (Page 1-18)

Used to start XMT (transmit) reservation, delayed communication, multi XMT, confidential communication, system setup, etc.

⑥ RESOLUTION Button and Indicators (Page 2-2)

Used to adjust scanning line density. The indicators light to show which setting you are using.

⑦ HALF TONE Button and Indicator (Page 2-2)

Press to send a document containing photographs, shaded drawings and the like. The indicator lights when this feature is on.

⑧ CONTRAST Button and Indicators (Page 2-2)

Used to set document contrast. The indicators light to show which setting you are using.

⑨ RECEIVING MODE Button and Indicators (Pages 2-9 and 2-10)

Used to select the desired receiving mode. The indicators light to show the mode in which the unit is set.

- ⑩ **TRANSMIT SETTING Button and Indicator (Page 2-8)**
Used to set the PAGE COUNTER and MESSAGE OUT.
- ⑪ **POLLING Button and Indicator (Page 3-3)**
Used for polling function. The indicator lights or flashes when this feature is on.
- ⑫ **OGM PLAY Button (Page 1-16)**
Used to replay your outgoing message.
- ⑬ **OGM REC Button (Page 1-15)**
Used to record your outgoing message.
- ⑭ **ICM ERASE Button (Page 2-15)**
Used to erase recorded incoming messages at high speed.
- ⑮ **REW (REWIND) Button (Page 2-15)**
Used to run the tape quickly backward to a desired point.
- ⑯ **FF (FAST FORWARD) Button (Page 2-15)**
Used to run the tape quickly forward to a desired point.
- ⑰ **MEMO/2WAY Button (Page 2-15)**
Used to start and stop recording of a memo message or a telephone conversation.
- ⑱ **PLAYBACK/PAUSE Button (Page 2-15)**
Used to play back recorded messages, or interrupt playback or FF/REW operation.
- ⑲ **STONE Button (Page 3-52)**
Used to change the dialing mode from pulse to tone during a dialing operation.
- ⑳ **FLASH Button (Page 3-52)**
Used to access some features of your host PBX.
- ㉑ **REDIAL Button (Page 2-20)**
Used to redial the last dialed number.
- ㉒ **MONITOR (VOICE STDBY) Button and Indicator (Page 2-12)**
Used for on-hook dialing and voice contact features. The indicator lights when these functions are on.
- ㉓ **PAUSE Button (Page 3-52)**
Used to insert a pause into a phone number during programming.
- ㉔ **AUTO Button (Page 1-24)**
Used for speed dialing.
- ㉕ **CLEAR Button (Page 1-24)**
Used to clear the previously entered parameters during programming.
- ㉖ **SET Button (Page 1-19)**
Used to store parameters during programming.
- ㉗ **PRIORITY Button (Page 3-19)**
Used to program a long dialing procedure (e.g. delayed communication) or used for one touch dialing.
- ㉘ **Direct Call Station Keys (Page 1-24)**
Used for one touch dialing.
- ㉙ **STOP Button (Page 2-4)**
Used to cancel transmission or copying operation.
- ㉚ **START/COPY Button and Indicator (Page 2-3)**
Used to start transmission and copy functions. The indicator lights when these functions are on.

Precaution

Keep the unit away from heating appliances such as radiators or air conditioning units.

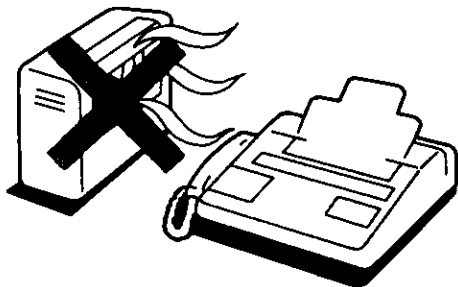

Keep the unit away from electrical noise generating devices such as fluorescent lamps and motors.

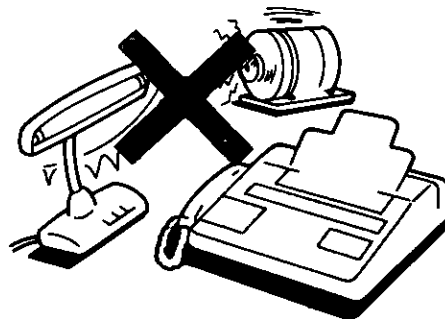

The unit and the cassette tape should not be exposed to direct sunlight.

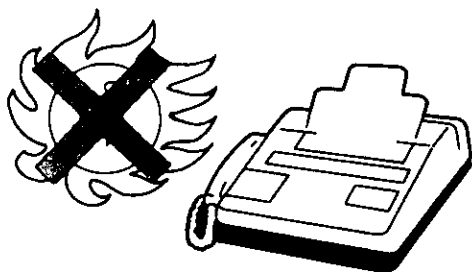

The unit and the cassette tape should be kept free from dust, moisture, high temperature and vibration.

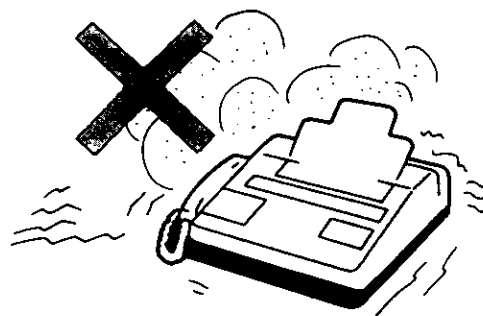

Do not use benzine, thinner, or the like, or any abrasive powder to clean the cabinet. Wipe it with a soft cloth.

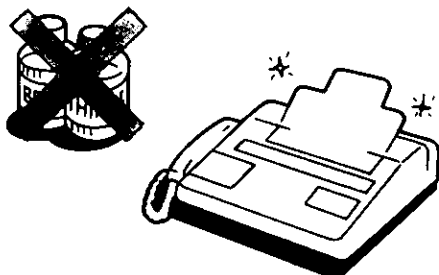

Do not place any covering over the unit while it is turned on.

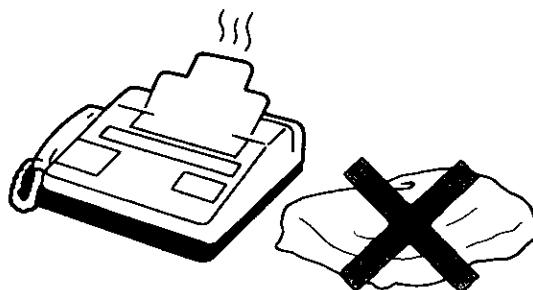

Micro cassette tape installation

To record your outgoing message, install a micro cassette tape first.

Open the compartment cover, then insert the tape into the cassette compartment by first pushing it in the direction of arrow "A" and then in the direction of arrow "B".

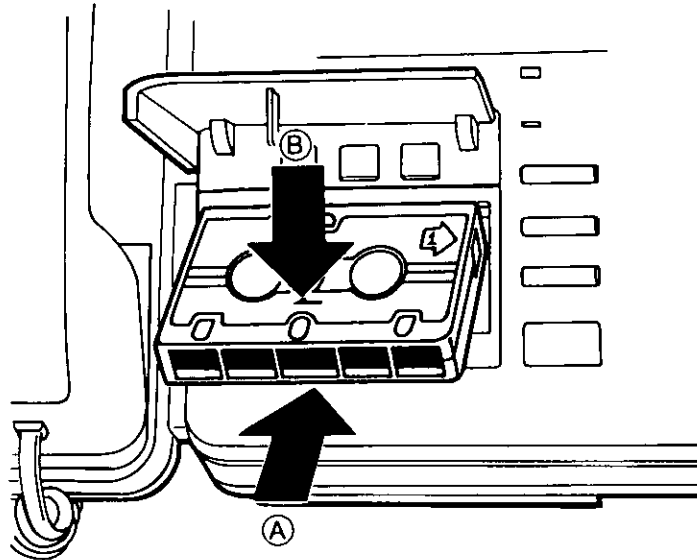

Cassette tape

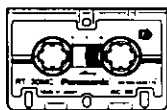
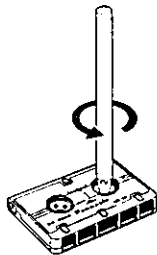

RT-MC30



RT-MC60

- Make sure that there is no slack in the tape. If there is any slack, remove it by rotating the tape reel with an instrument like a pencil, as shown.
- For optimum sound quality and performance, we recommend that you use the opposite side (side-2) after six months and replace the tape with a new one every year, assuming that the unit answers about ten calls a day.
- Never place a cassette tape near a magnetic source such as a magnet or a TV set, it may erase or distort the recorded message on the tape.
- Should the cassette tape break or become worn, replace it with a new cassette tape. We recommend using the Panasonic cassette tape RT-MC30 or RT-MC60.

Recording paper installation

Follow the steps below to install a new roll of recording paper.

Caution:

Use only the included roll or specified recording paper (Part No. KX-A106) for supplement, or else the print quality may be affected or excessive thermal head wear may occur.

- 1 Press the FRONT LID OPEN lever down to open the cover.

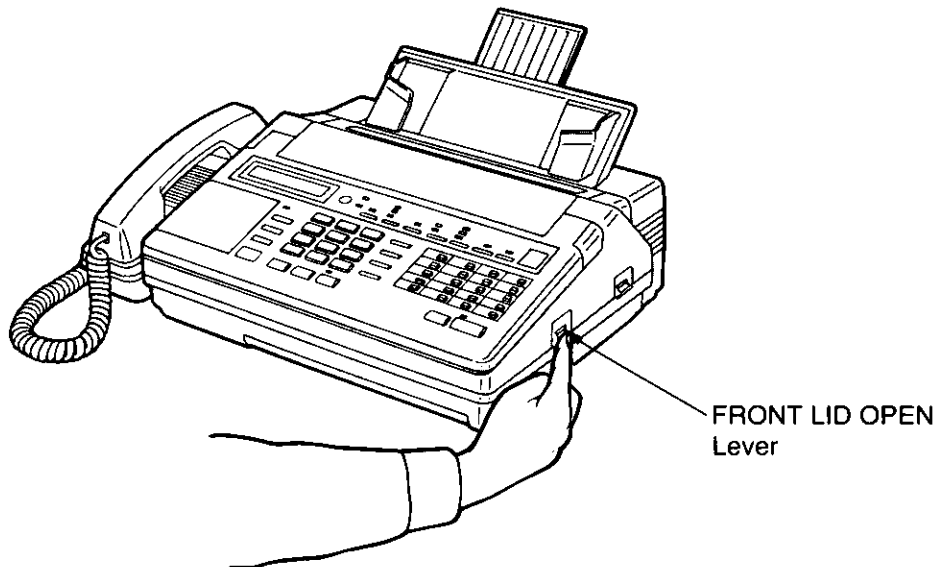

- 2 Place a recording paper roll into the paper compartment. Make sure that the shiny side of the paper is facing up and that there is no slack in the paper roll.

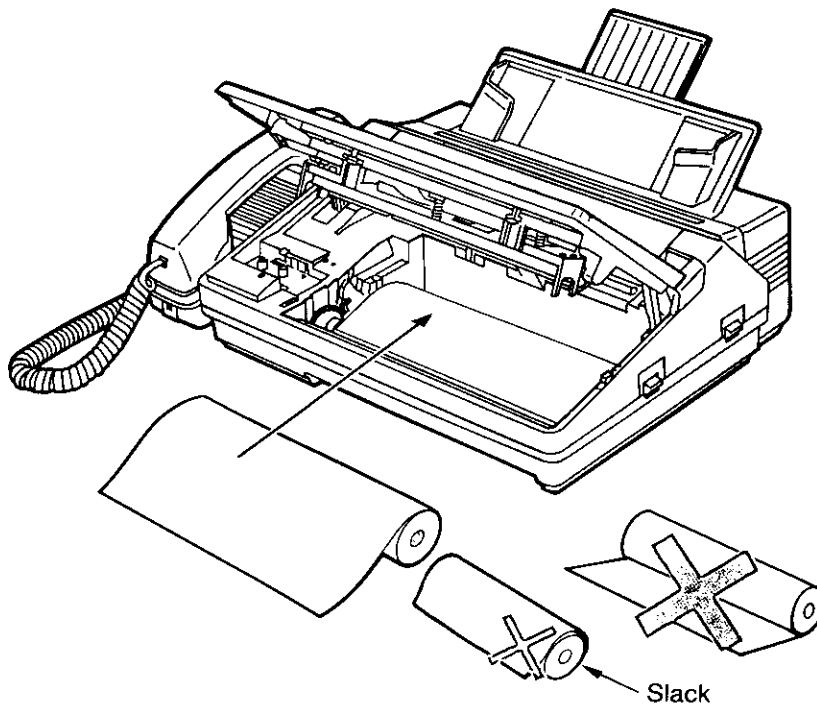

3 Insert the recording paper between the upper and the lower guide plates and pull the paper a few centimeters (one or two inches) out of the unit.

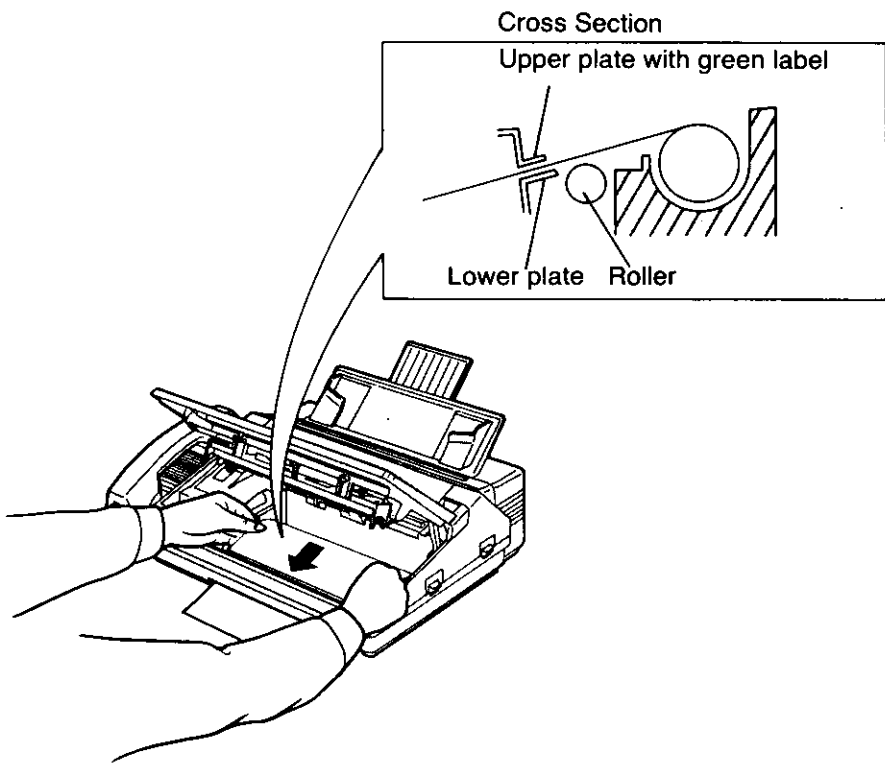

4 Close the cover carefully by pressing down on both ends gently.
If the unit is on, the recording paper will project slightly and be cut automatically.

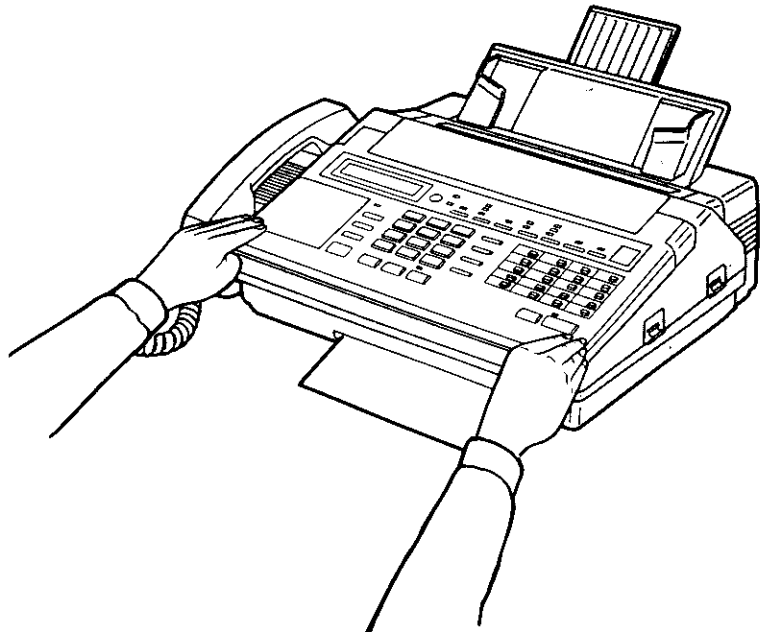

Document feeder tray and receiving tray installation

- 1 Insert the two tabs "A" of the tray into the two grooves on the unit.

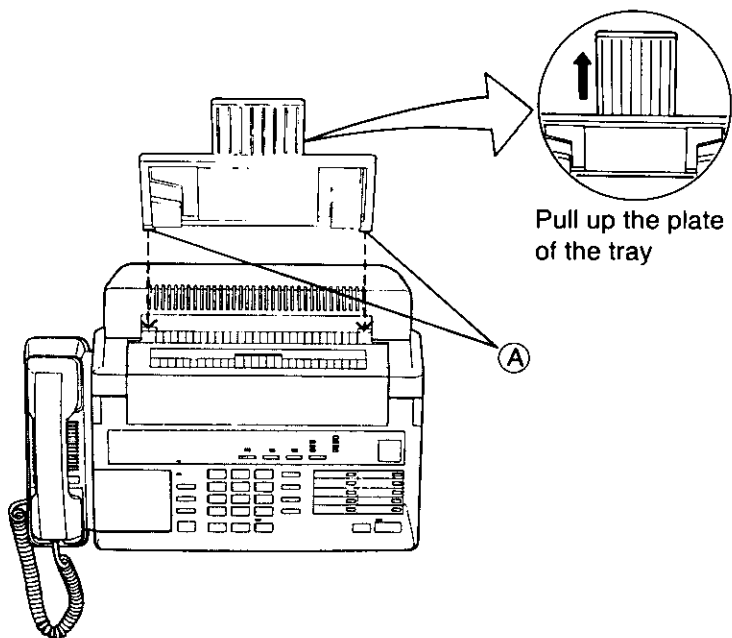

- 2 Press the tray ("B") back with both hands until the two fins "C" on the rear of the tray click into place.

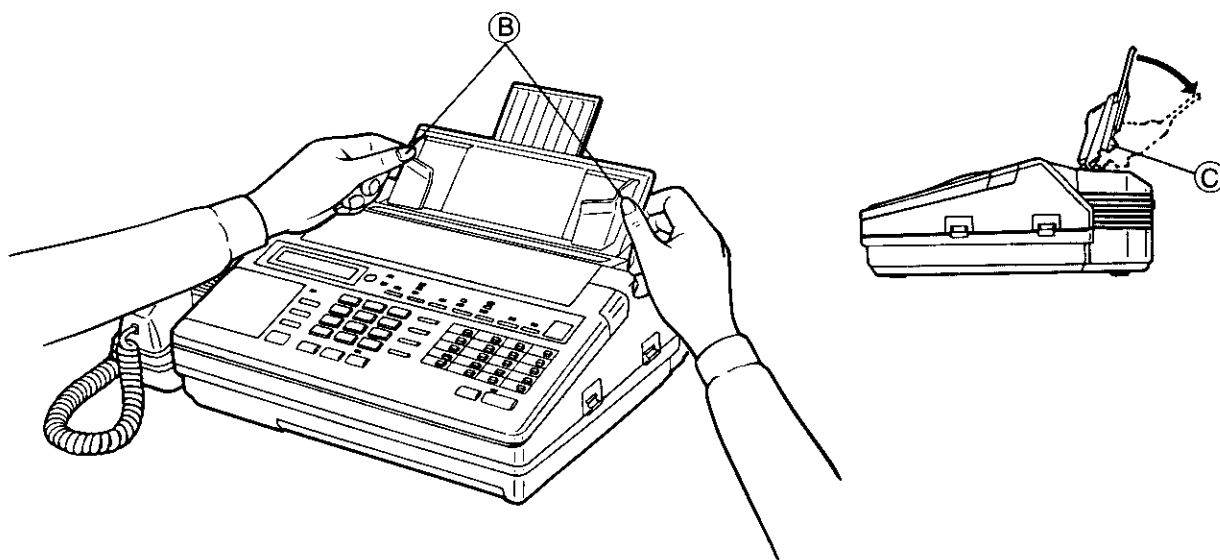

3 Insert the receiving tray. Pull the document plate "D" forward after inserting the receiving tray.

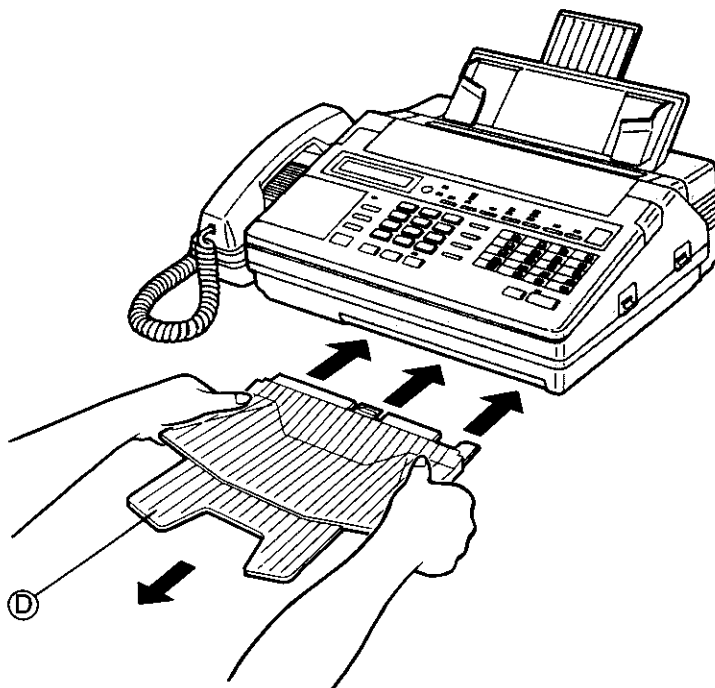

4 Fit the diverter as shown below.



Selector settings

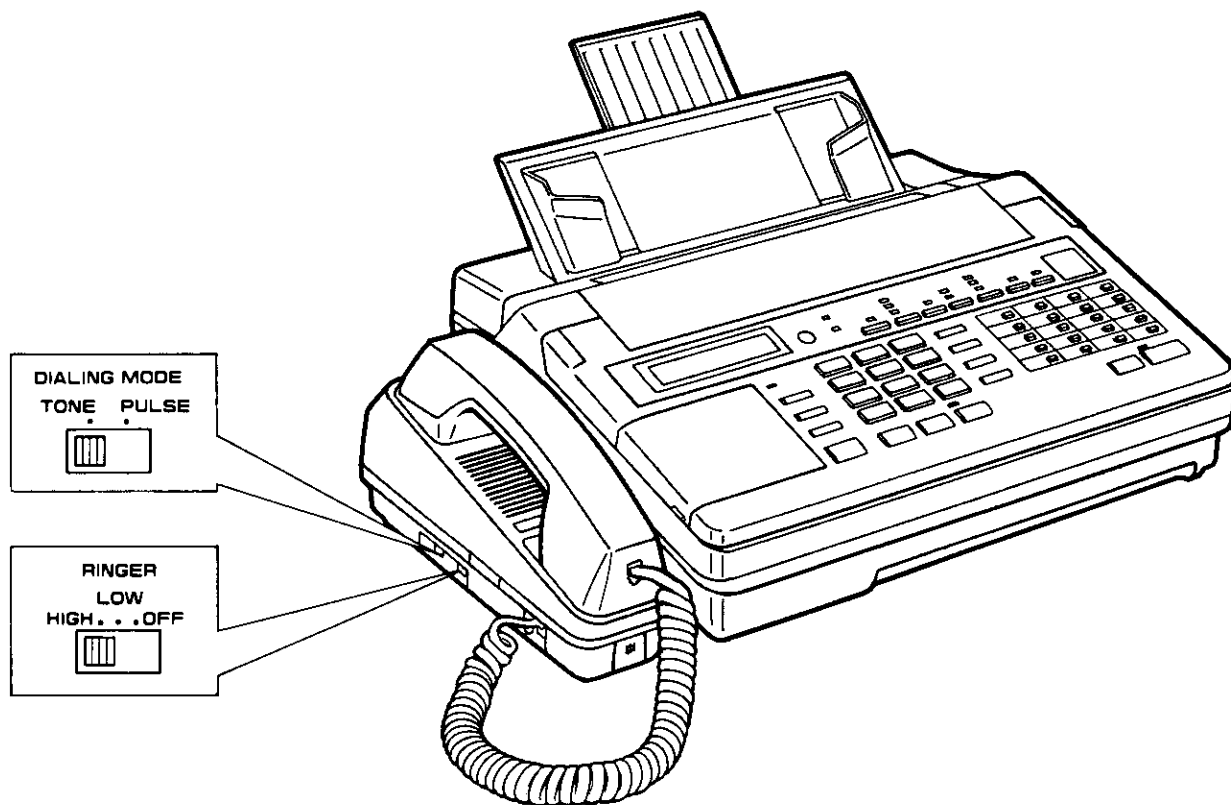

DIALING MODE Selector:

If your line has touch tone service, set the selector to "TONE". If your line has rotary pulse dial service, set to "PULSE".

RINGER Volume Selector:

HIGH: The ringing sound will be loud.
LOW: The ringing sound will be soft.
OFF: The unit will not ring.

Turning the POWER switch on

Before turning the POWER switch on, confirm the following:

1. The cassette tape and the recording paper are installed properly.
2. The handset is on the cradle.

Turn the POWER switch to the "ON (I)" position

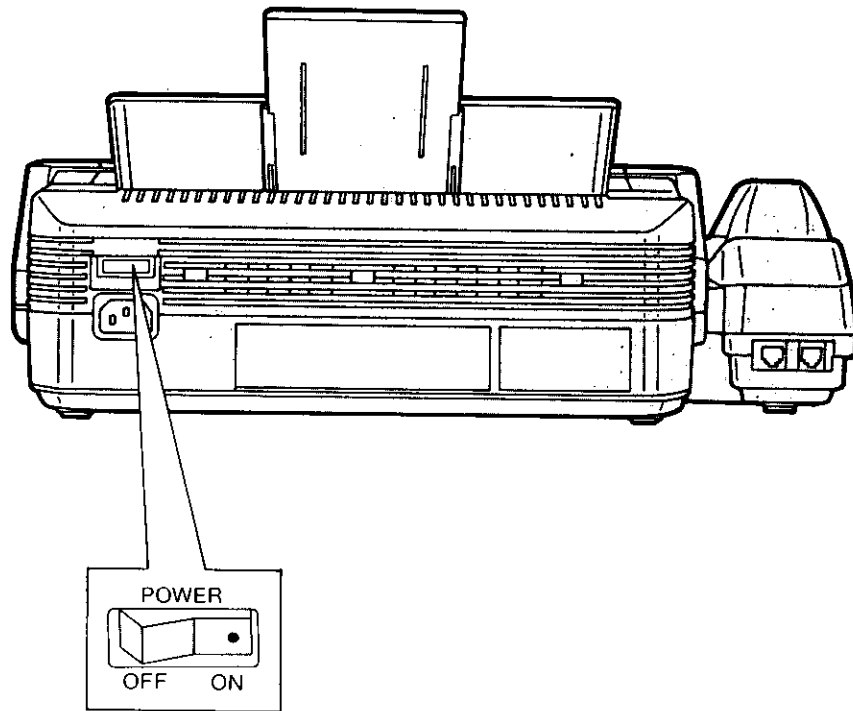

Note:

- When you use the unit for the first time, the display shows "RECORD OGM". Record your OGM. See page 1-15.

Recording an Outgoing Message (OGM)

The OGM tells the caller that you are out, and to leave a voice-message or to send a fax message. Before using your unit as both an answering device and a facsimile, you should first record your OGM. You can store a personal OGM up to 16 seconds on the voice-recordable microchip. Once recorded, the OGM will be automatically recorded on the micro cassette tape as a backup in case of power failure. Refer to "OGM backup" on page 1-16.

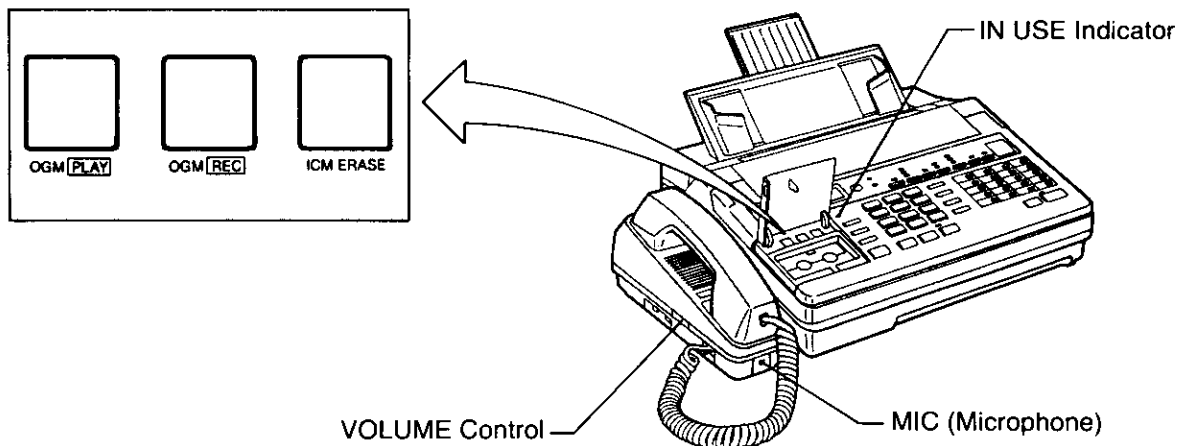

Make sure that the micro cassette tape is properly installed. (See page 1-8.)
The recording time is limited to 16 seconds.

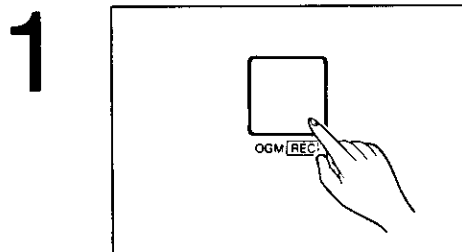

Press the OGM REC button until a long beep is heard, then release it.

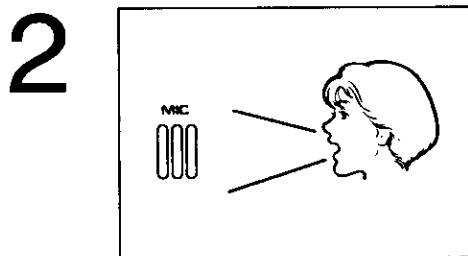
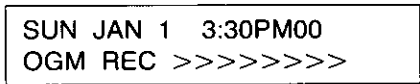

After the beep, speak immediately, clearly and loudly, toward the microphone from a distance of approximately 20 cm (8 inches).

For optimum performance, we recommend that you record your OGM within 12 seconds. If 16 seconds pass or a pause continues for more than 2 seconds, the unit will finish recording.

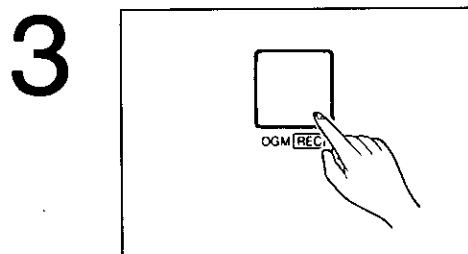

After recording, press the OGM REC button again.

The unit plays the stored OGM so that you can confirm your message. Adjust the VOLUME control to a suitable level. Refer to "OGM backup" on page 1-16.

Verifying your OGM

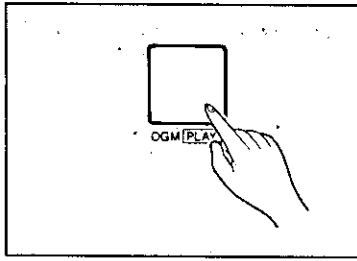

Press the OGM PLAY button.

The unit replays your OGM. If you want to change your OGM, perform the operation on page 1-15 again. The previous message will be automatically erased and a new message will be recorded.

Suggested message

Record your OGM referring to the examples below.

- *"This is (your name, business and/or telephone number). We are out right now. To send a fax, start transmission. To leave a message, speak after the long beep. Thank you."*
- *"This is (your name, business and/or telephone number). We are out right now. To send a fax, start transmission. To leave a message, speak for up to 1 minute after the long beep. Thank you."*

You can choose from two lengths of recording times for incoming messages. When the unit is in the "VOX" position, the recording time is unlimited, and when in the "1 MIN" position, the recording time is limited to 1 minute. The two examples above correspond to these two conditions.

The unit is preprogrammed to the "VOX" position. To change the recording time, see page 5-5.

OGM backup

After your OGM is recorded on the microchip memory, it is recorded onto the tape from the microchip as a backup.

SUN JAN 1 3:30PM 00 TAPE BACK UP

If a power failure takes place or the POWER switch is turned off, the OGM recorded on the microchip will be erased. However, after the power is restored, the unit will automatically re-record the OGM onto the microchip using the OGM recorded on the tape. You need not re-record your OGM.

Re-recording of OGM

When you replace the cassette tape with a new one or you use the opposite side (side-2), you have to record an OGM again.

User programming functions

The following functions are user selectable. The most probable choices have been preselected (default), but may be changed as needed.

To print out a list of the current settings of the program functions, press the MENU button 5 times, and then press "4" and "1".

Code	Function	Default	Reference
#01	SET DATE	(not entered)	Page 1-19
#02	YOUR LOGO	(not entered)	Pages 1-20~1-23
#04	YOUR TELEPHONE NUMBER	(not entered)	Pages 1-20~1-21
#05	FAX LOGO POSITION	OUT	Page 5-1
#06	REMOTE TAD ID	111	Page 3-42
#07	REMOTE FAX ID	OFF	Page 3-39
#08	PRIVACY RING ID	333	Page 3-48
#09	MESSAGE OUT	OFF	Pages 2-8 and 5-2
#10	JOURNAL AUTO PRINT	AUTO	Page 4-1
#11	PRINT XMT REPORT	OFF	Page 4-4
#12	NETWORK PASSCODE	0000	Page 3-35
#13	SEND PASSCODE	OFF	Page 3-35
#14	TX PASSCODE CHECK	OFF	Page 3-36
#15	RX PASSCODE CHECK	OFF	Page 3-36
#16	POLLING PASSWORD	0000	Page 3-7
#17	FAX TX SPEED	9600BPS	Page 5-3
#18	FAX RX SPEED	9600BPS	Page 5-3
#19	AUTO STANDBY	ON	Page 5-4
#20	TONE DETECT	OFF	Page 5-4
#25	MULTI COPY SORT	OFF	Page 5-5
#26	MEMORY XMT	OFF	Page 3-15
#27	MEMORY DELAYED XMT	OFF	Page 3-17
#28	MEMORY POLLING	OFF	Page 3-18
#30	RECORDING TIME	VOX	Page 5-5
#31	CPC MODE	A	Page 5-6
#32	TAD/FAX RING COUNT	1 (once)	Page 5-6
#33	FAX RING COUNT	1 (once)	Page 5-7
#34	AUTO RECEIVE TIMER	OFF	Page 3-50
#42	TEST [PRINTER OR MOTOR]		Pages 5-7~5-8
#50	SET DEFAULT	NO	Page 5-8
#9000*	SERVICE DATA SET UP		Page 5-9

For your convenience, please set the following functions at first.

- #01 SET DATE (Page 1-19)
- #02 YOUR LOGO (Pages 1-20~1-23)
- #04 YOUR TELEPHONE NUMBER (Pages 1-20~1-21)

Programming

To make a function change;

1. Press the MENU button 5 times.
The MENU indicator lights and the display shows;

PROGRAM[1.DATE 2.TEL
3.SYSTEM 4.REPORT]

2. Press "1" for programming date and time.

SET DATE [*=AM #=PM]
01 01 90 12:00AM MON]

-OR-

Press "2" for programming phone numbers.

SELECT AUTO OR
DIRECT CALL KEY

-OR-

Press "3" for programming systems .

2.ENTER YOUR LOGO
=

The display shows the next parameter each time you press the SET (or RECEIVE MODE) button. If you press the CLEAR (or RESOLUTION) button, the display shows the previous parameter.

You can select the desired function directly by pressing "#" and code number (01 through 50).

-OR-

Press "4" for printing reports and lists.

SELECT NO.[1.SYSTEM
2.TEL NO. 3.JOURNAL]

3. Press the MENU button again to end the operation.

Programming date and time

The date and time appear on the top line of all the documents you transmit and the fax communication reports such as JOURNAL report and TX report.

1

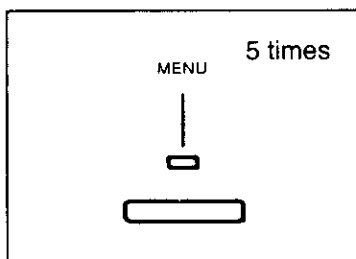

Press the MENU button 5 times.

```
PROGRAM[1.DATE 2.TEL
3.SYSTEM 4.REPORT]
```

2

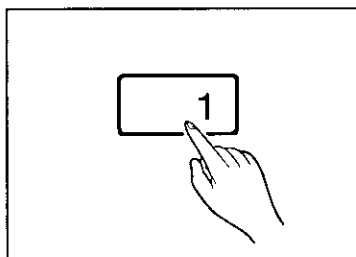

Press "1".

```
SET DATE [*=AM #=PM]
01 01 90 12:00AM MON
```

3

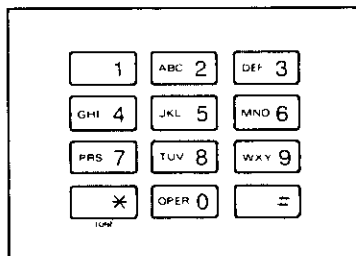

Enter the current month/date/year/hour/minute (2 digits each).
(Example: Feb.16 1990. 3:00PM.)

```
SET DATE [*=AM #=PM]
02 16 90 03:00PM FRI
```

Press "*" and "#" to select AM/PM mode.

4

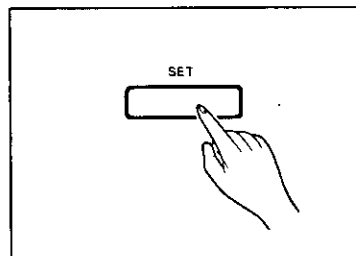

Press the SET button to store the program into memory.

5

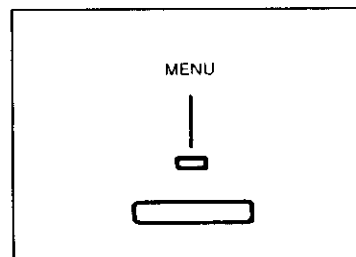

Press the MENU button to end the operation.

Programming your logo and fax telephone number identifiers

YOUR LOGO: The LOGO is used to identify fax documents sent by your unit. It may consist of alphanumeric letters and symbols. Usually the LOGO is a company, division or personal name in an abbreviated form. Your programmed LOGO will be printed on the top of all pages transmitted from your unit. Your printed LOGO can be up to 50 digits long.

YOUR TELEPHONE NUMBER: Your facsimile telephone number can be programmed into your unit. When you transmit a document, your programmed number will be printed on the top of all pages transmitted from your unit. The unit can hold your phone number up to 20 digits long. This gives the receiving party your fax number if he wishes to return a fax.

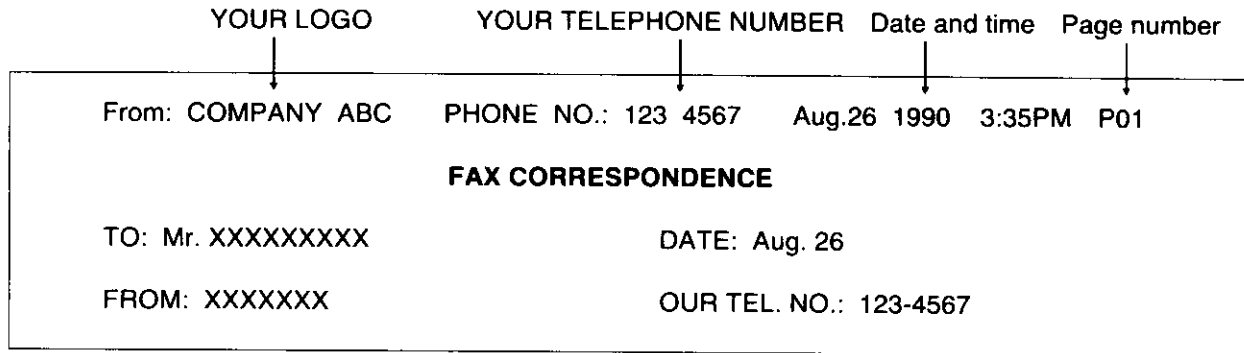

Preparation

Remove the cover with a pencil or similar object as shown.
Turn over the memory card, you will find the alphabet and symbol characters for each key on the memory card.

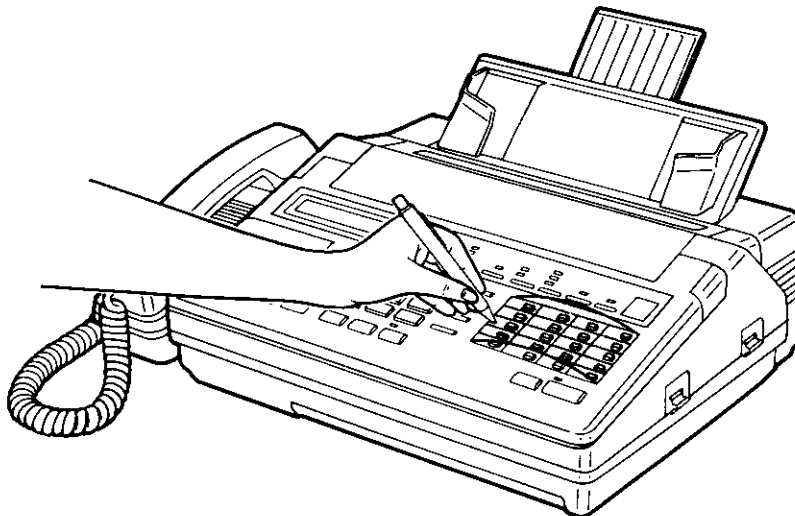

Programming your logo and telephone number

1

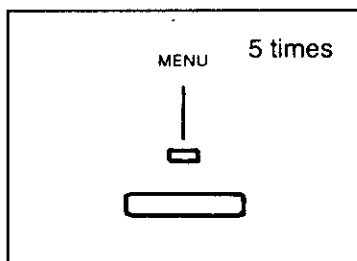

Press the MENU button 5 times.

PROGRAM[1.DATE 2.TEL
3.SYSTEM 4.REPORT].

2

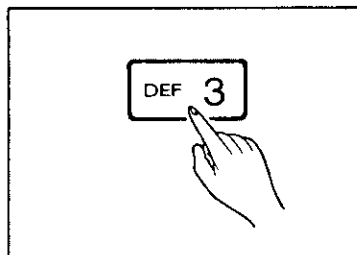

Press "3".

2.ENTER YOUR LOGO
=

3

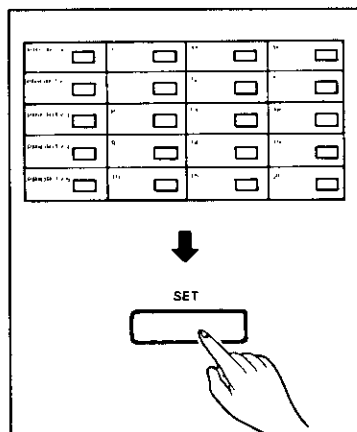

Enter your LOGO (up to 30 characters) by using the character and numeric keys, then press the SET button to store it. (See the next two pages for detailed description.)

Example: If the LOGO is ABC;
Press the "AaBbCc" key, the RIGHT arrow key, the "AaBbCc" key 3 times, the RIGHT arrow key and the "AaBbCc" key 5 times.

2.ENTER YOUR LOGO
=ABC

4.ENTER YOUR TEL NO.
=

4

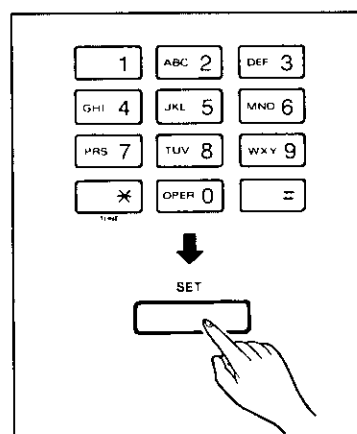

Enter your telephone number, then press the SET button to store.

Example: If the phone number is "123-4567",
press the "123", "#", and "4567".
The "#" provides a space.

4.ENTER YOUR TEL NO.
=123 4567

5.LOGO POSITION=OUT
[1.OUT 2.IN 3.OFF]

(See page 5-1.)

5

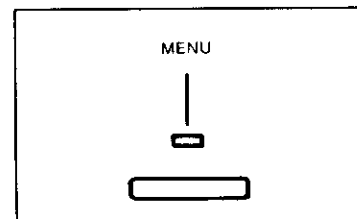

Press the MENU button to end the operation.

Reference guide for the character keys

When you program your LOGO, you can use the character (direct call station) keys on the memory card and "0" through "9", "*", and "#" on the dial keypad.

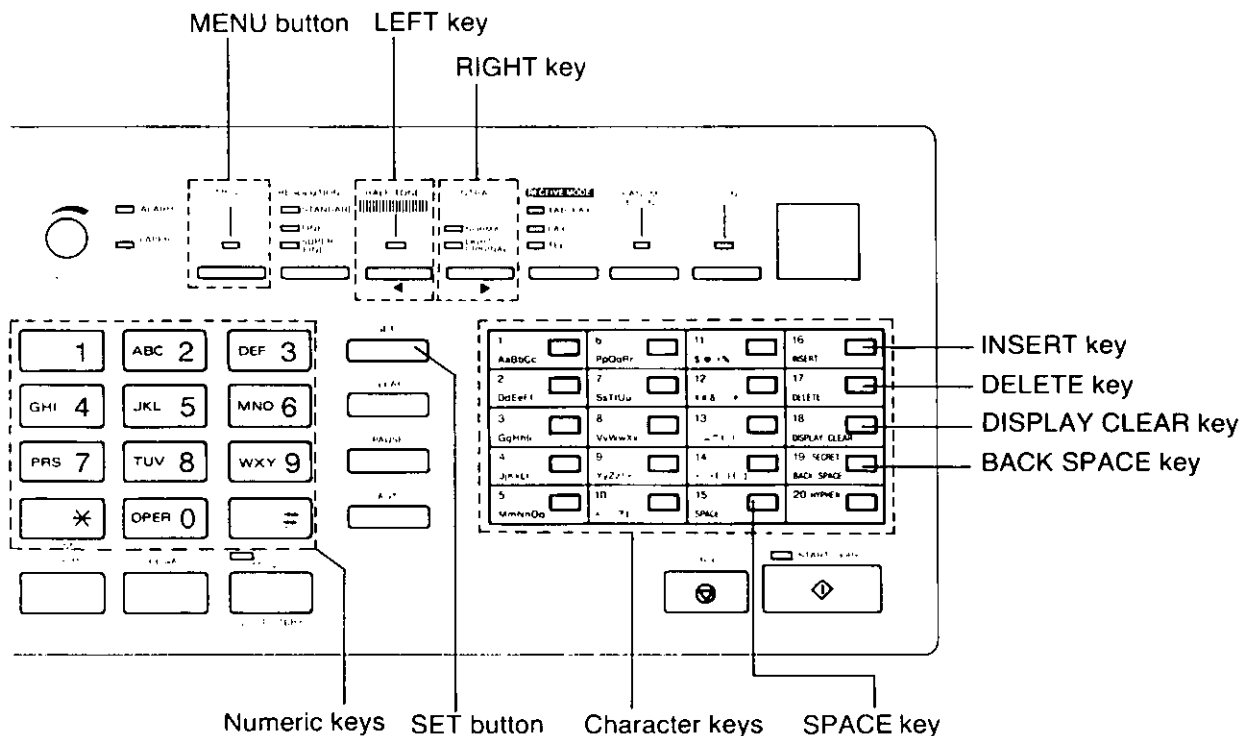

Character keys:

The character on the display is changed as follows each time you press this key.
 (For example: When you press the "AaBbCc" key, the display shows "A" → "a" → "B" → "b" → "C" → "c" → "A" → ...)

To enter a character and move to the next character, press the RIGHT arrow key (CONTRAST key) once. (Note the blue arrows under the top row of keys.)

Cursor arrow key (RIGHT):

The cursor is moved one space to the right each time you press this key.

Cursor arrow key (LEFT):

The cursor is moved one space to the left each time you press this key.

DISPLAY CLEAR key:

You can clear all the character.

SPACE key:

This key is used to replace one character to the space.

INSERT key:

This key is used to insert one character (or one space) in the programmed LOGO.

Example: Panaonic→Panasonic

- 1 Press the LEFT key repeatedly until the cursor is positioned on "o".

2. ENTER YOUR LOGO
=Panaonic

- 2 Press the INSERT key, then press the "SsTtUu" key twice to enter "s".

2. ENTER YOUR LOGO
=Panasonic

BACK SPACE key:

This key is used to delete one character to the left side of the cursor while it moves backward.

Example: Panasonic→Panasonic

- 1 Press the LEFT key repeatedly until the cursor is positioned on "n".

2. ENTER YOUR LOGO
=Panasonic

- 2 Press the BACK SPACE key.

2. ENTER YOUR LOGO
=Panasonic

DELETE key:

This key is used to delete one character from the programmed LOGO.

Example: Panassonic→Panasonic

- 1 Press the LEFT key repeatedly until the cursor is positioned on "s".

2. ENTER YOUR LOGO
=Panassonic

- 2 Press the DELETE key.

2. ENTER YOUR LOGO
=Panasonic

Programming phone numbers for automatic dialing

The unit's memory allows you to use both one touch dialing (up to 20 phone numbers) and speed dialing (up to 100 phone numbers) for rapid access to your most frequently dialed numbers.

Make sure first whether the DIALING MODE selector is set to TONE or PULSE mode, since the number will be stored in the mode that is set at the time of programming.

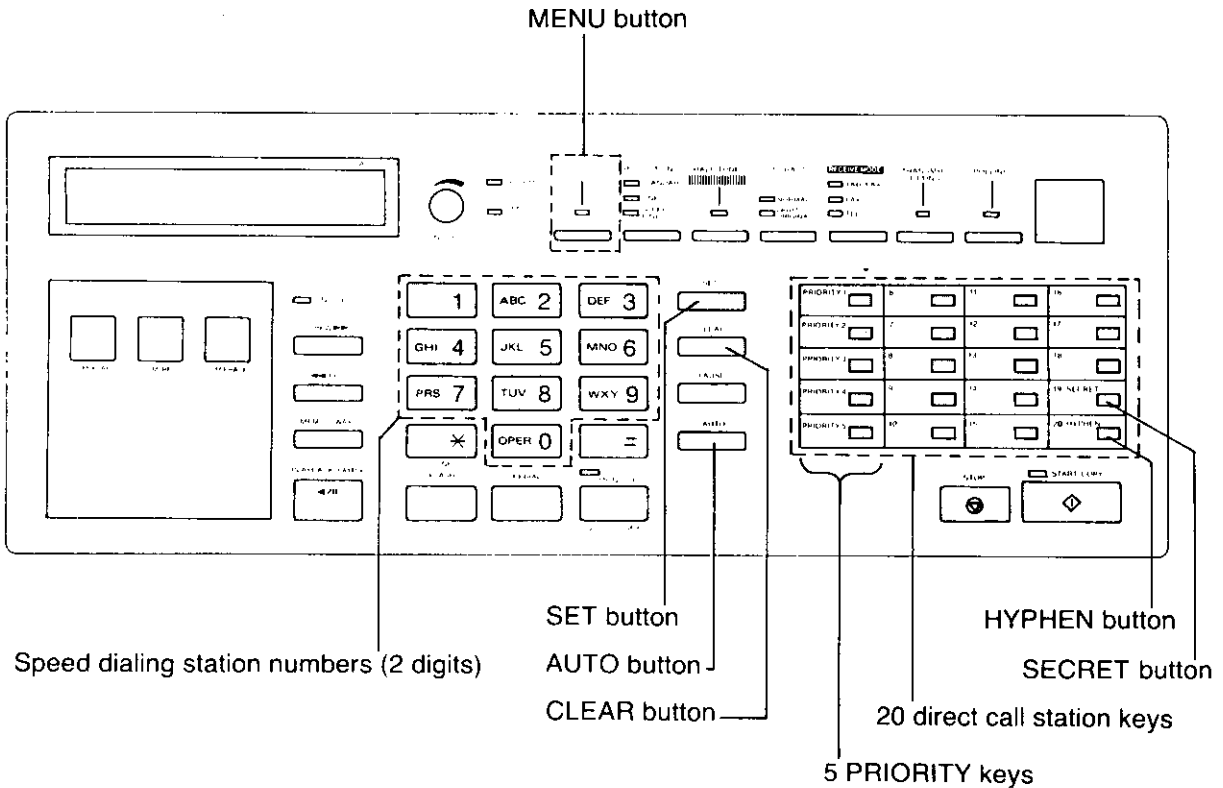

Programming phone numbers for one touch dialing

This unit is equipped with 20 direct call (one touch) stations including 5 PRIORITY keys (See page 3-19.), SECRET and HYPHEN keys, each of which can store a telephone number and a station name.

Each phone number can be programmed up to 30 digits long.

Each station name can be programmed up to 16 alphanumeric characters.

1

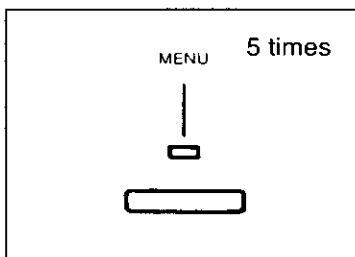

Press the MENU button 5 times.

PROGRAM[1.DATE 2.TEL
3.SYSTEM 4.REPORT]

2

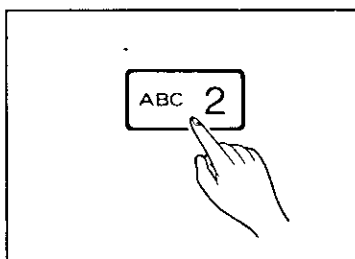

Press "2".

SELECT AUTO OR
DIRECT CALL KEY

3

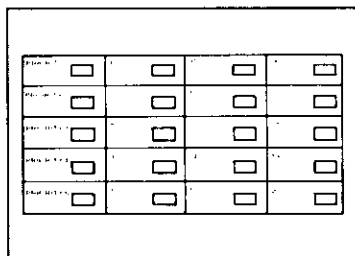

Press one of the direct call station keys where you want to store the phone number.

If you select key number's 1~5, you must press the SET button to get next prompt.

Example: Station number is 6.

ENTER PHONE NO.<S06>
=

4

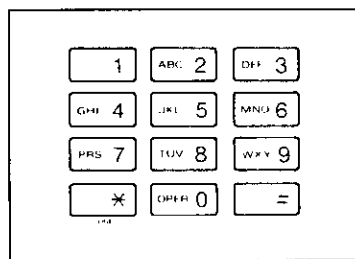

Enter the phone number.

Example: The phone number is 765-4321.

ENTER PHONE NO.<S06>
=7654321

If you want to insert a hyphen in the number, press the HYPHEN key during programming. HYPHEN is counted as 2 digits.

5

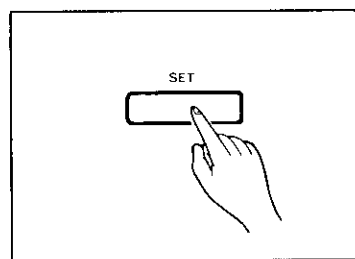

Press the SET button to store the program into memory.

ENTER NAME
=

6

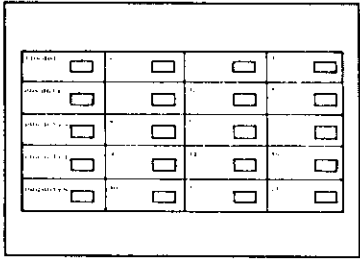

Enter the name associated with the direct call station by using the direct call station keys as character keys.

7

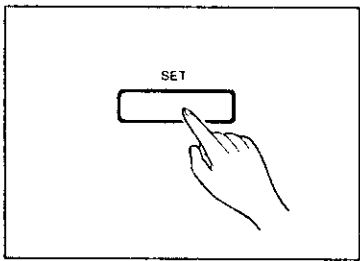

Press the SET button to store the program into memory.

SELECT AUTO OR DIRECT CALL KEY

To program other phone numbers, repeat steps 3 to 7.

8

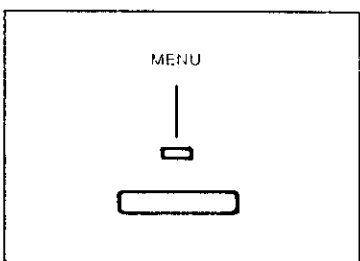

After programming all the numbers, press the MENU button to end the operation.

Note:

- Correcting an error while programming, press the CLEAR button, then correct input.
- To enter the station name, use the character (station) keys and the blue arrows under the top row of function keys and 0 through 9, # and *.
For further details, see page 1-22.

1 AaBbCc	6 PpQqRr	11 \$.@--%/	16 INSERT
2 DdEeFf	7 SsTtUu	12 ¥#&:~*	17 DELETE
3 GgHhIi	8 VvWwXx	13 ' , _ - ()	18 DISPLAY CLEAR
4 JjKkLl	9 YyZz!+	14 <> [] { }	19 SECRET BACK SPACE
5 MmNnOo	10 = " ' ? !	15 SPACE	20 HYPHEN

Programming phone numbers for speed dialing

This unit is equipped with 100 additional stations (00 through 99), each of which can store a telephone number and a station name.

Each phone number can be programmed up to 30 digits long.

Each station name can be programmed up to 16 alphanumeric characters.

1

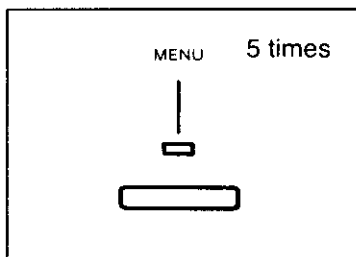

Press the MENU button 5 times.

PROGRAM[1.DATE 2.TEL
3.SYSTEM 4.REPORT]

2

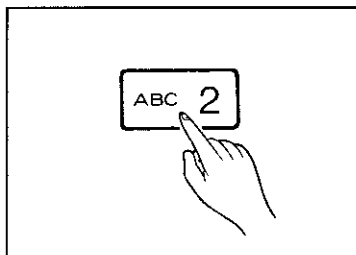

Press "2".

SELECT AUTO OR
DIRECT CALL KEY

3

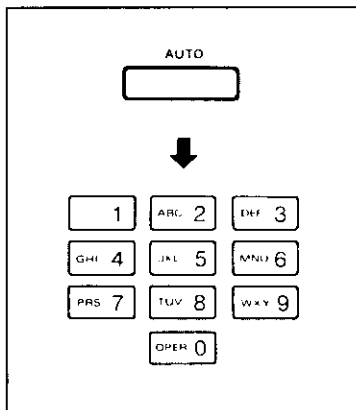

Press the AUTO button, then enter the speed dialing station number by selecting 2 digits (00 through 99).

ENTER PHONE NO.<A >
=

4

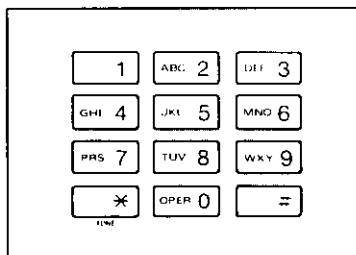

Enter the phone number by using the dial keypad.

Example: Station number is 00 and the phone number is 123-4567.

ENTER PHONE NO.<A00>
=1234567

If you want to insert a hyphen in the number, press the HYPHEN key during programming. HYPHEN is counted as 2 digits.

5

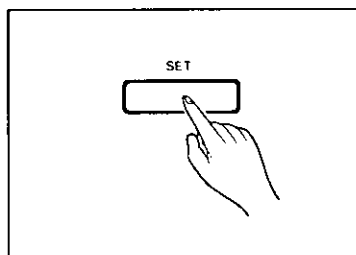

Press the SET button to store the program into memory.

ENTER NAME
=

6

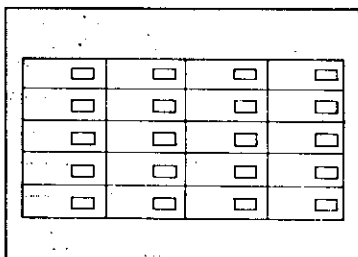

Enter the name associated with the speed dial station by using the direct call station keys as character keys.

7

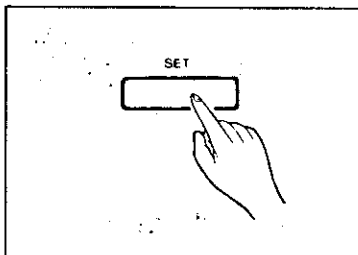

Press the SET button to store the program into memory.

SELECT AUTO OR
DIRECT CALL KEY

To program other phone numbers, repeat steps 3 to 7.

8

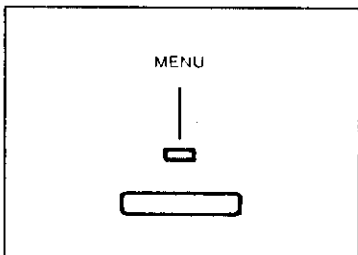

After programming all the numbers, press the MENU button to end the operation.

Note:

- Correcting an error while programming, press the CLEAR button, then correct input.
- To enter the station name, use the character (station) keys and the blue arrows under the top row of function keys and 0 through 9, # and *.
For further details, see page 1-22.

1 AaBbCc	6 PpQqRr	11 S.@-%/	16 INSERT
2 DdEeFf	7 SsTtUu	12 Y#&^*	17 DELETE
3 GgHhIi	8 VvWwXx	13 ' _ - ()	18 DISPLAY CLEAR
4 JjKkLl	9 YyZz!+	14 <> }	19 SECRET BACK SPACE
5 MmNnOo	10 = ' " , ? !	15 SPACE	20 HYPHEN

Programming secret phone numbers

This function is useful for keeping the whole or portion of a phone number secret. When you print out a list of the stored numbers, this number will not be printed.

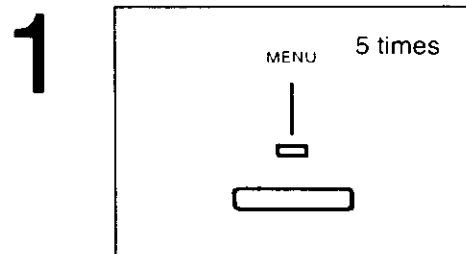

Press the MENU button 5 times.

PROGRAM[1.DATE 2.TEL
3.SYSTEM 4.REPORT]

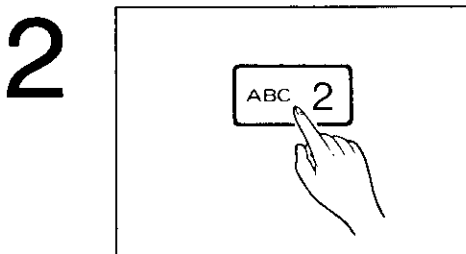

Press "2".

SELECT AUTO OR
DIRECT CALL KEY

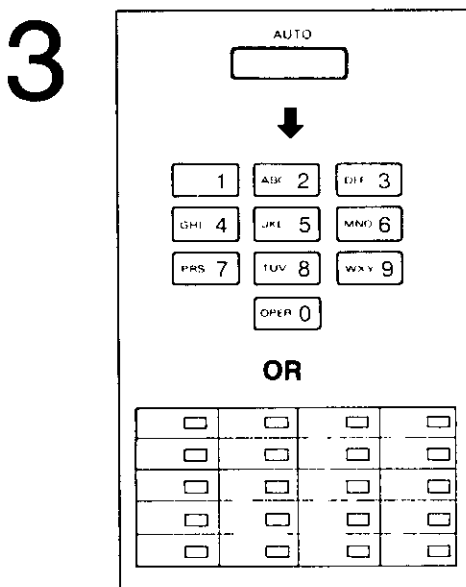

Press the AUTO button, then enter the speed dialing station number by selecting 2 digits (00 through 99).

ENTER PHONE NO.<A >
=

OR
Press one of the direct call station keys.

ENTER PHONE NO.<SXX>
=

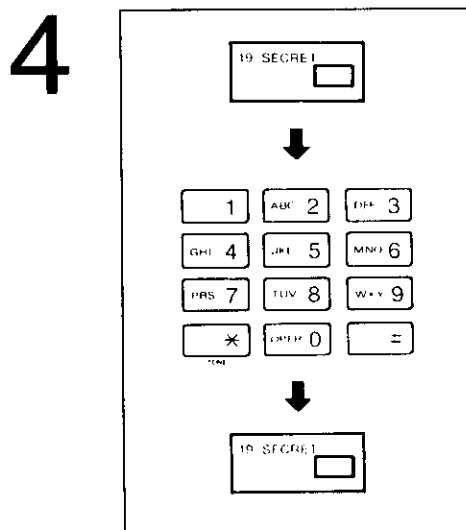

Enter the phone number.

Example: Station number is 00 and the phone number is 123-4567.
Press the SECRET key, "1234567", then press the SECRET key again.

ENTER PHONE NO.<A00>
[1234567]

Pressing the SECRET key once counts as 2 digits.

5

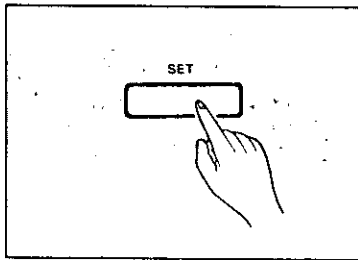

Press the SET button to store the program into memory.

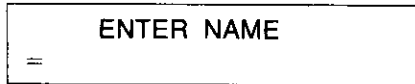

6

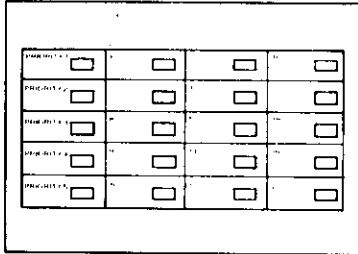

Enter the station name by using the direct call station keys as character keys.

7

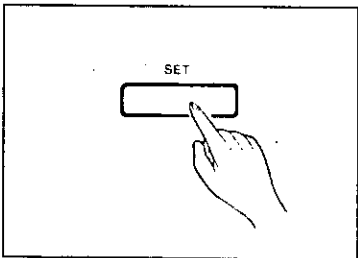

Press the SET button to store the program into memory.

To program other phone numbers, repeat steps 3 to 7.

8

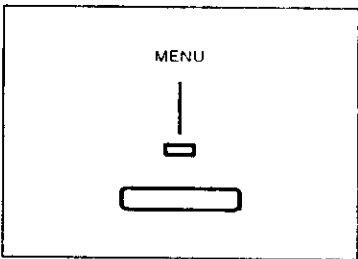

After programming all the numbers, press the MENU button to end the operation.

Note:

- To verify that all numbers were programmed correctly, press the MENU button 5 times, press "4" and then press "2" for telephone number report.

Listing the directory card

After programming remove the cover using an instrument with a pointed end, like a pen and turn over the memory card to its original side. Write in the names associated with the direct call station keys.

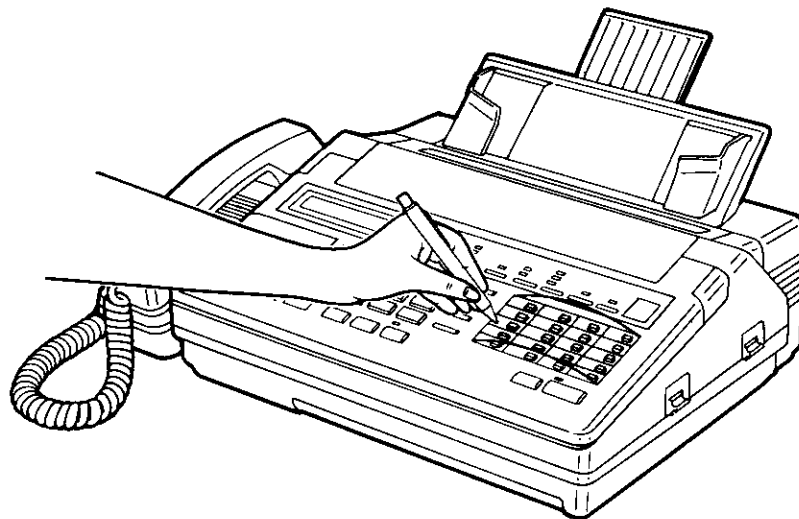

Basic Instructions

Before transmitting documents

Acceptable documents

The unit can transmit documents that meet the following conditions.

- Paper width should be 128 mm (5") to 216 mm (8½").
- Effective scanning width should be up to 208 mm (8¾").
- Paper weight should be 45 g/m² (12 pounds) to 90 g/m² (24 pounds).

Automatic document feeder:

- Up to 10 sheets of paper can be set in the document feeder tray at a time.
- Paper weight should be 60 g/m² (16 pounds) to 75 g/m² (20 pounds).
- Paper with a coated surface must not be used.

Maximum paper size

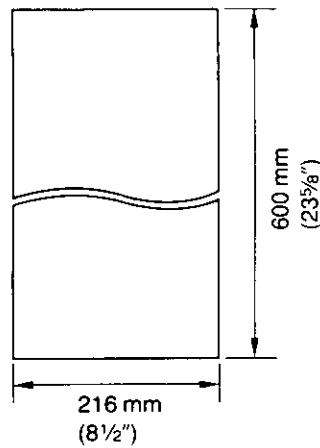

Minimum paper size

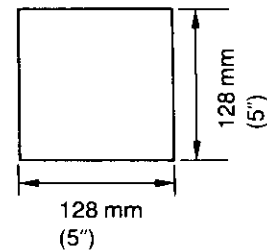

Effective scanning width

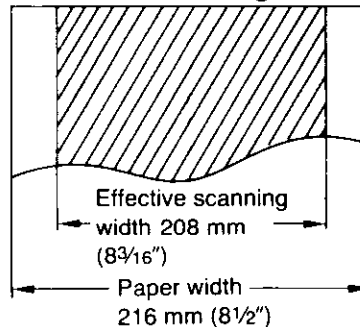

Do not use the following types of documents or it may jam. Make a copy of such documents and feed a copy into the unit.

- Paper with a chemically treated surface such as carbon paper or carbonless duplicating paper
- Heavily curled, creased or torn paper
- Paper with a coated surface
- Small-sized paper such as a slip or voucher
- Thin paper less than 45 g/m² (12 pounds)
- Thick paper over 90 g/m² (24 pounds)
- Paper with faint contrast between the print and the background
- Paper with printing on the reverse side that can be seen through from the front (e.g. newspaper)

Remove clips, staples or other similar objects from a document before feeding it into the unit. Make sure that any ink or paste on the document is completely dry before feeding it into the unit.

Note:

- A document whose length exceeds 600 mm (23⁵/₈") cannot be transmitted. When you feed such documents, the unit stops transmitting and a long beep will be heard. If this happens, press the STOP button and remove the document.
- If a document is electrostatically charged, the automatic document feeder may not function properly.

Resolution and contrast

You can set the following functions depending on the quality of an original. Set the functions before transmission or copying. If you set them during transmission, they will be effective from the next sheet transmitted.

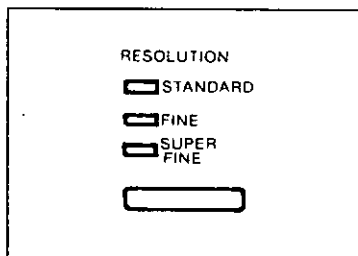

RESOLUTION:

STANDARD is suitable for printed or typewritten originals with normal-sized characters.
FINE is suitable for originals with small printing characters or detailed drawing.
SUPER FINE doubles the resolution of *FINE*.
(*SUPER FINE* only works between Panasonic compatible machines such as KX-F90, KX-F110, KX-F220, KX-F320, etc.)

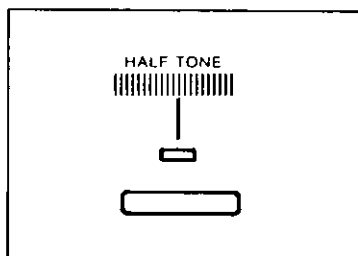

HALF TONE:

HALF TONE is useful when sending originals containing photographs, shaded drawings, etc. When you use this feature, *FINE* resolution is selected automatically.

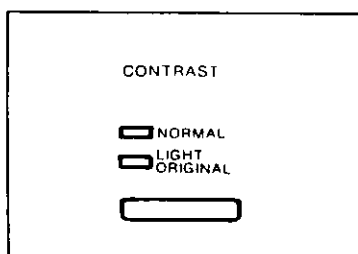

CONTRAST:

NORMAL is useful when transmitting or copying originals with normal print.
LIGHT ORIGINAL is useful when transmitting or copying originals with faint writing.

Transmitting documents

Manual transmission

1

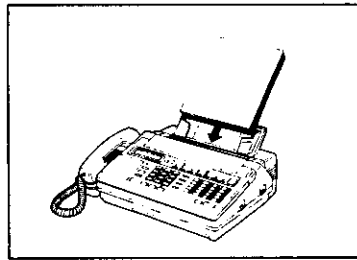

Insert the documents **FACE DOWN**.

The unit can accept up to 10 sheets of paper at a time.

2

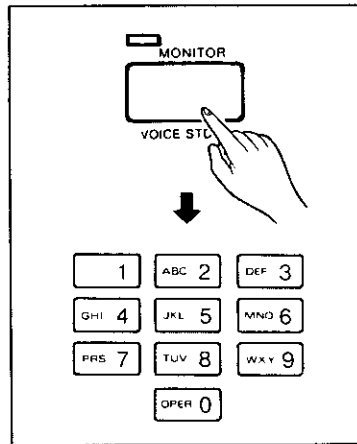

Press the **MONITOR** button or lift the handset, then dial the phone number.
(Example: 123-4567 is dialed.)

SUN JAN 1 3:00 PM 00
ENTER PHONE NUMBER

SUN JAN 1 3:00 PM 00
1234567

If the other party answers, lift the handset and ask them to receive the fax transmission.

3

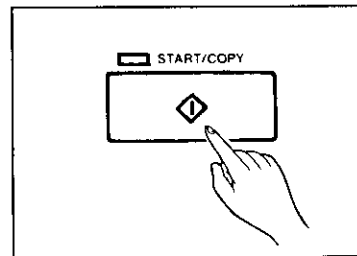

Press the **START/COPY** button when a fax tone is heard, then place the handset on the cradle.

The unit feeds and transmits the documents. The display shows the number of each page (00 through 99) during a fax transmission.

SENDING P1
TO:1234567

SUN JAN 1 3:00 PM 00
XX PAGES SENT OK

If you do not replace the handset, the unit will automatically call the other party after the transmission. For further details, see "Voice contact" on page 2-12.

Interrupting transmission

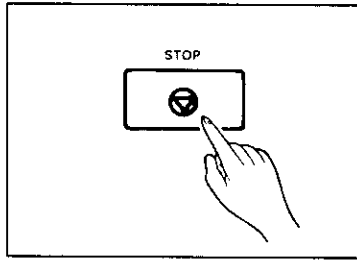

Press the STOP button

SUN JAN 1 3:00PM 00
USER STOPPED

The transmission is interrupted.

Adding extra pages

If you want to send 11 or more sheets at a time, insert the documents up to 10 sheets of paper first, and add the extra pages up to 10 sheets before the last page feeds into the unit.

Transmitting documents using one touch dialing

You can transmit documents using automatic dialer. Before using this feature, make sure that the desired telephone numbers have been stored into memory. For programming of phone numbers, see pages 1-24 to 1-30.

1

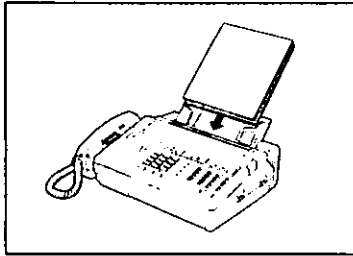

Insert the documents FACE DOWN.

2

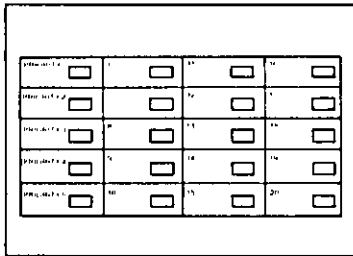

Press the desired direct call station key.
(Example: Direct call station 7 is dialed and its station name is PANASONIC.)

The unit dials and transmits the documents automatically.

DIALING <XMT>
TO:<S07>

DIALING <XMT>
TO: PANASONIC

SENDING P1
TO: PANASONIC

The station name appearing on the display may change according to the receiving machine's programming.

When the MEMORY XMT function is set to on, the documents are stored into memory first then the unit begins transmission. See page 3-15.

Automatic redialing:

If there is no answer or the line is busy, the unit will automatically redial the number up to 6 times within 10 minutes. To cancel automatic redialing, press the STOP button or the FLASH button.

Transmitting documents using speed dialing

You can transmit documents using automatic dialer. Before using this feature, make sure that the desired telephone numbers have been stored into memory. For programming of phone numbers, see pages 1-24 to 1-30.

1

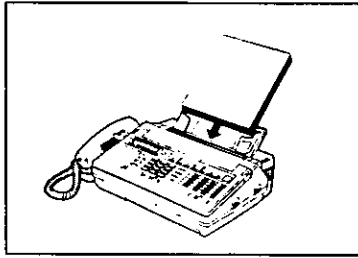

Insert the documents FACE DOWN.

2

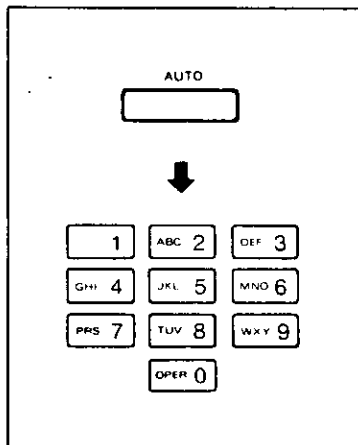

Press the AUTO button, then press the desired speed dial station number (00 through 99) by using the dial keypad.

(Example: Station 00 is dialed and its station name is PANASONIC.)

The unit dials and transmits the document automatically.

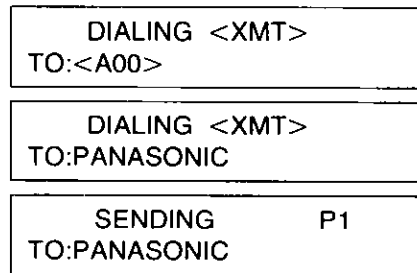

The station name appearing on the display may change according to the receiving machine's programming.

When the MEMORY XMT function is set to on, the documents are stored into memory first then the unit begins transmission. See page 3-15.

Automatic redialing:

If there is no answer or the line is busy, the unit will automatically redial the number up to 6 times within 10 minutes. To cancel automatic redialing, press the STOP button or the FLASH button.

Reserving transmission (XMT RESERVATION)

While the unit is receiving documents from one station, you can reserve transmission to another. The unit transmits the reserved documents automatically after the fax reception.

1

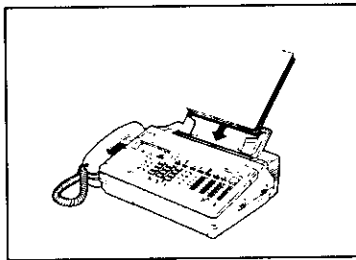

Insert the documents FACE DOWN during fax reception.

RECEIVING P 1
FROM: XXXXXXXX

2

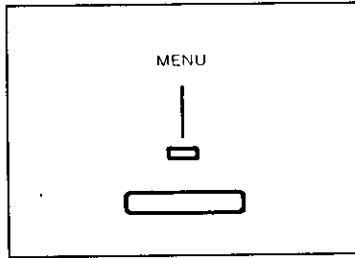

Press the MENU button.

XMT RESERVATION
ENTER PHONE NUMBER

3

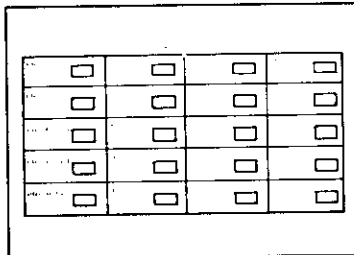

Enter the phone number.

Using the direct call station key:

Press the desired direct call station key.
(Example: Direct call station 7 is dialed.)

ENTER PHONE NUMBER
=<S07>

OR

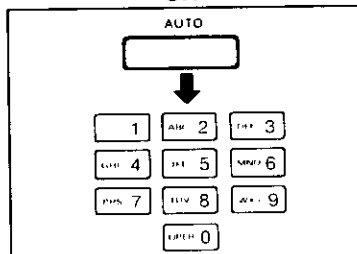

OR

Using the speed dial station:

Press the AUTO button, then press the desired speed dial station number (00 through 99).
(Example: Station 00 is dialed.)

ENTER PHONE NUMBER
=<A00>

OR

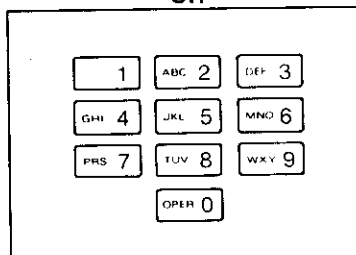

OR

Using a full number:

Enter the phone number by using the dial keypad.
(Example: 1234567 is dialed.)

ENTER PHONE NUMBER
=1234567

4

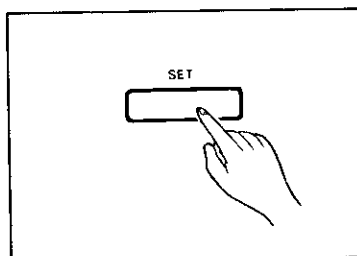

Press the SET button.

The unit will transmit documents automatically after reception has finished.

Setting the PAGE COUNTER and MESSAGE OUT

When you transmit a document, the total page number (PAGE COUNTER) and/or a special message (MESSAGE OUT) may be printed at the top of all pages transmitted.

1

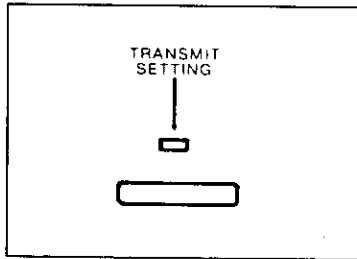

Insert the documents FACE DOWN, then press the TRANSMIT SETTING button.

SET NUMBER OF PAGES
TOTAL=0

2

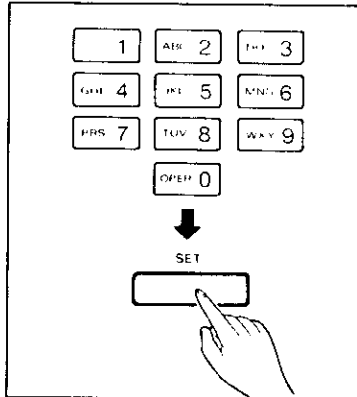

Enter the total number of pages, then press the SET button.

SET NUMBER OF PAGES
TOTAL=XX

MESSAGE OUT=OFF
[1.OFF 2.A 3.B 4.C]

3

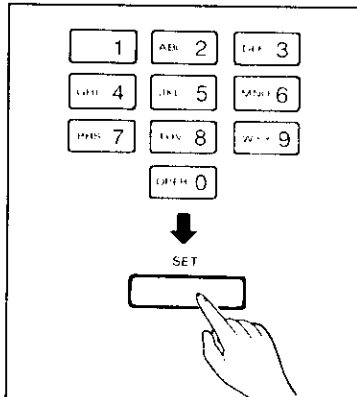

Press "1", "2", "3" or "4", then press the SET button.

Press "1": No message is printed.

Press "2": "CONFIDENTIAL" is printed.

Press "3": "IMMEDIATE REPLY REQUESTED" is printed.

Press "4": Your own message is printed.
(To program the message, see page 5-2.)

Example: Message A is printed.

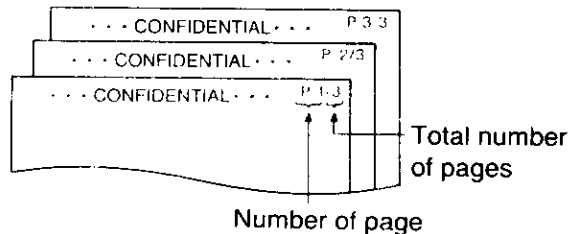

Note:

- Page counter and message out settings work for one transmission only and must be set each time they are required.

Receiving documents and/or voice-messages

Manual reception (Receiving documents during a conversation)

TEL (telephone) mode:

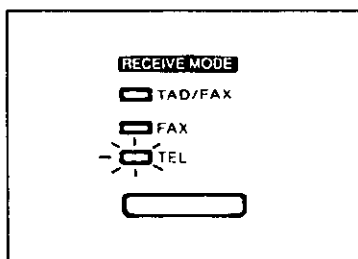

Select this mode when you use the unit as a standard telephone. The TEL indicator lights.

If an incoming call rings 15 times, the unit will switch to the TAD/FAX mode. This is to allow you to switch this setting remotely. (Remote turn on feature)

You can receive documents during a telephone conversation.

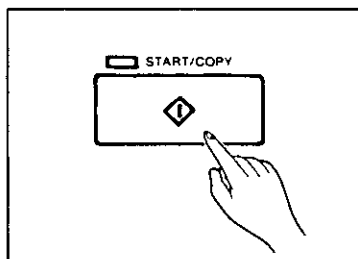

Press the START/COPY button to receive documents during a telephone conversation, and then place the handset on the cradle.

The unit receives documents and the line is automatically disconnected after reception has been completed.

If you do not replace the handset, the unit will automatically call the other party after receiving the current page, and no further documents will be received. See "Voice contact" on page 2-12.

Automatic reception

The unit can also receive documents and/or voice-messages automatically. The unit has two types of automatic receiving modes. To select the desired mode, press the RECEIVE MODE button.

TAD/FAX mode:

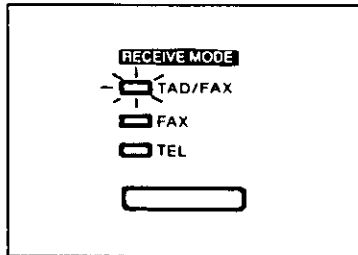

Select this mode when you use the unit as a telephone answering device and/or a facsimile machine. The TAD/FAX indicator lights.

When a call is received, the unit will automatically distinguish between voice and fax calls.

If the unit detects a fax tone during OGM or the caller's voice is not heard within 5 seconds of the end of the OGM, it switches to the fax mode and receives documents automatically.

If the unit detects the caller's voice, it starts recording the voice on the tape.

The unit can also receive a voice-message and fax documents on the same call. When the other party presses the asterisk (*) button after leaving his/her message in your unit, the unit switches to the fax mode and produces a fax tone for document reception. The caller should then press his start button and hang up his handset.

FAX mode:

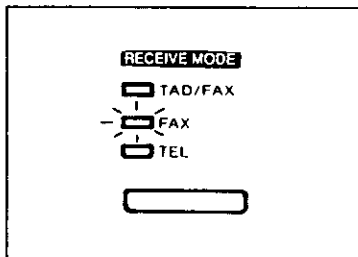

Select this mode when you use the unit only as a facsimile machine. The FAX indicator lights.

When a call is received, the unit receives documents automatically.

If someone calls you when your unit is in the FAX mode, he/she will hear the fax tone and cannot talk to you. You are still able to make outgoing voice calls.

Note:

- This unit will answer on the first ring by default. You can change the ring count according to the instructions found on pages 5-6 and 5-7. If you find difficulty in receiving facsimile from machines which have an automatic transmission feature, you will need to keep the ring count at one.
- Replace the paper roll with a new one;
 - when the red lines appear on both sides of the recording paper.
 - when the PAPER OUT indicator lights.
 - when the display shows "OUT OF PAPER".To install the paper roll, see page 1-9.

Memory reception

If the paper runs out after a reception, the next 7 pages of documents will be stored into memory until the paper roll is replaced.

*Memory capacity (up to 7 pages) applies to text data using CCITT No. 1 test chart in STANDARD resolution.

Note:

- If a power failure occurs or you turn the POWER switch off during memory reception, all stored documents are lost.
- Begin by transmitting the FAX CORRESPONDENCE sheet (provided) to several of your associates. This way, you can confirm that your unit is functioning correctly and inform them of the procedure for transmitting documents and/or recording voice-messages on your unit.

Voice contact

Initiating voice contact

If the other party's unit is equipped with a voice contact feature, you can initiate voice contact and notify the other party that you wish to speak after the transmission/reception is completed. This saves extra time and expense of making a subsequent telephone call to discuss information sent over the fax.

1

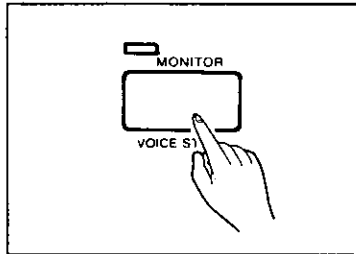

Press the MONITOR/VOICE STDBY button or lift the handset while transmitting or receiving the documents.

Once the fax transmission is completed, the other party's fax will emit a distinctive ring that indicates that you request a voice communication.

2

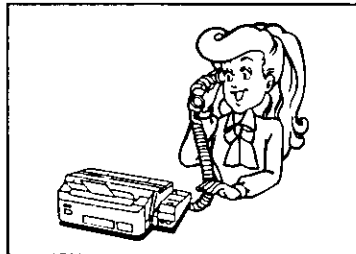

When the other party answers, start speaking using the handset.

If you initiate voice contact while transmitting documents, you can speak after all the documents have been transmitted.

If you initiate voice contact while receiving documents, you can speak after receiving the current page of the documents.

Receiving a request for voice contact

If the other party initiates voice contact during transmission or reception, your unit will emit a distinctive ring after the fax is completed.

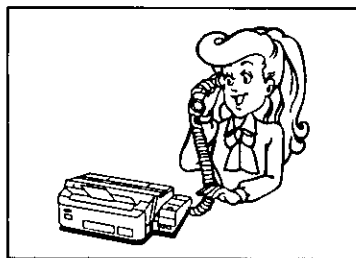

When the unit rings, lift the handset and start speaking.

Note:

If you do not answer within 10 seconds after hearing several rings indicating the request for voice contact, one of the followings occurs:

- When the unit is in the TAD/FAX mode, it plays back your OGM and records the voice-message on the tape.
- When the unit is in the FAX mode, the line is disconnected.
- When the unit is in the TEL mode, the line is disconnected.

Transmitting documents to your unit

Leaving a message and transmitting documents on the same call

When the unit is in the TAD/FAX mode, your caller can follow the steps below to leave a message and send documents.

From a touch tone phone:

1



Your caller may call your unit, and then leave you a message after the long beep following your OGM.

2

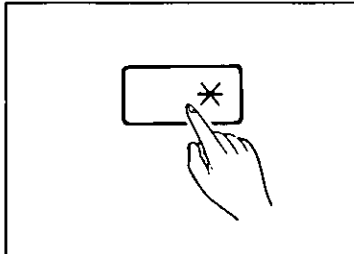

When their message is finished, they may press “*” to change the unit to the fax mode.

Start transmission upon hearing the fax tone.

From a rotary (pulse) phone:

If the calling facsimile machine has a voice contact function, your caller can leave a voice-message after transmitting documents to your facsimile.

1

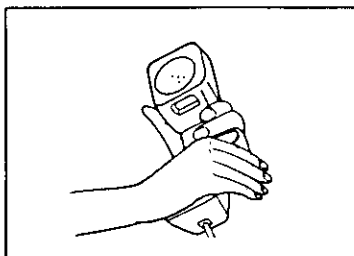

Your caller may call your unit, and then press the mute button or cover the mouthpiece of his/her handset to change the unit to the fax mode during the OGM.

Start transmission upon hearing the fax tone.

Make a call reservation (e.g. lift the handset) during transmission. The unit plays the OGM again.

2

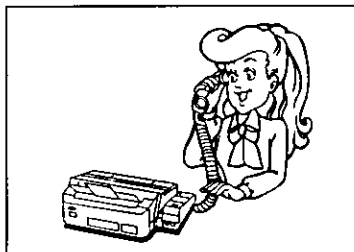

Leave a message after the long beep following the OGM.

Transmitting documents with manual operation

From a touch tone phone:

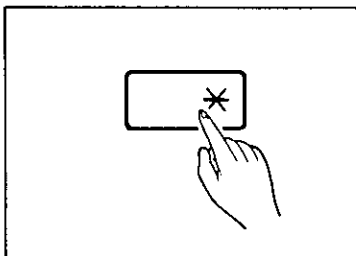

Your caller may call your unit, and then press “*” to change the unit to the fax mode.

Start transmission upon hearing the fax tone.

From a rotary (pulse) phone:

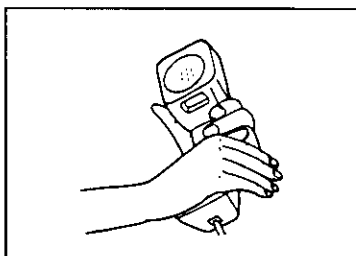

Your caller may call your unit, and then press the mute button or cover the mouthpiece of his/her handset to change the unit to the fax mode during the OGM.

Start transmission upon hearing the fax tone.

Operating as an answering device

The unit also works as an automatic telephone answering and recording system in the TAD/FAX mode.

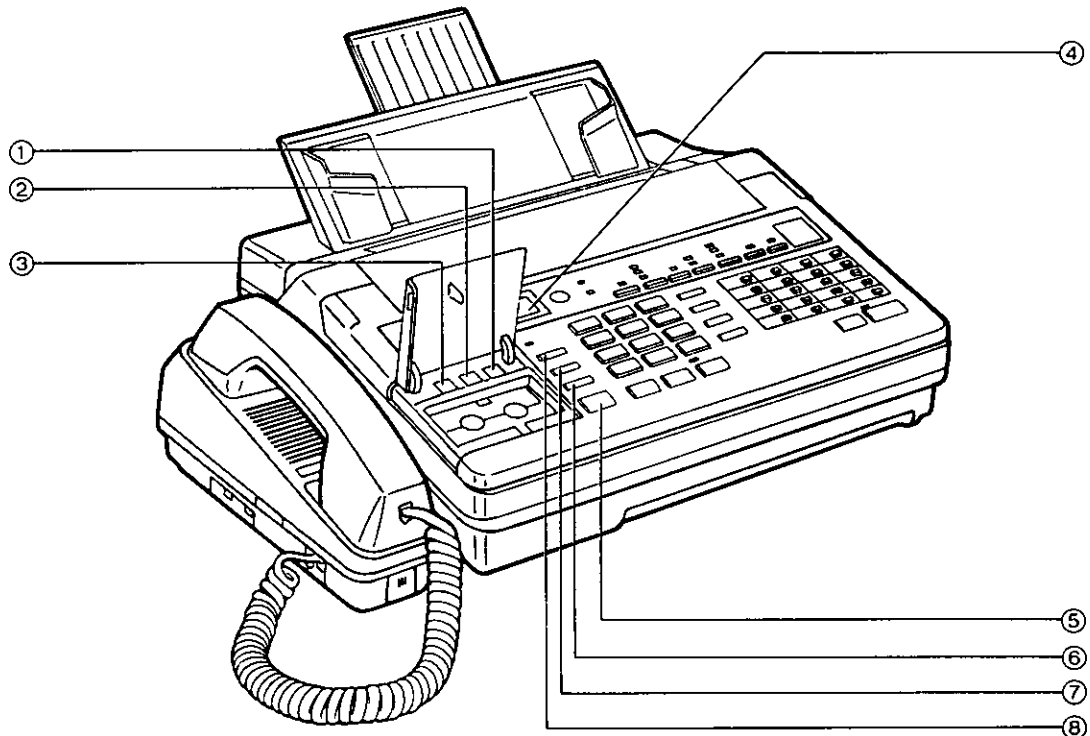

① Erasing recorded voice-messages:

After reviewing your messages, press the ICM ERASE button. The messages are erased while the tape is rewound.

The tape can be erased at high speed even if the record-prevention (knock-out) tabs have been removed.

② Recording your OGM:

See page 1-15.

③ Verifying your OGM:

See page 1-16.

④ LCD (Liquid Crystal Display):

The number of recorded incoming voice-messages are shown on the display and the TAD/FAX indicator flashes.

If the power supply has been interrupted the display shows “- -”.

⑤ Playing back recorded voice-messages:

Press the PLAYBACK/PAUSE button.

Stopping the tape (Pause mode):

Press the PLAYBACK/PAUSE button during playback mode. The tape pauses until you restart it by pressing the PLAYBACK/PAUSE button. The unit does not answer calls automatically while in the pause mode.

⑥ Recording a memo message:

See page 2-18.

Recording a 2-way conversation:

See page 2-19.

⑦ Forwarding the tape quickly:

Press the FF (Fast Forward) button.

⑧ Rewinding (Resetting) the tape quickly:

Press the REW (Rewind) button.

Setup of voice-message and document reception

1

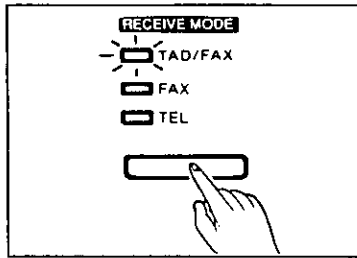

Press the RECEIVE MODE button until the TAD/FAX indicator lights.

2

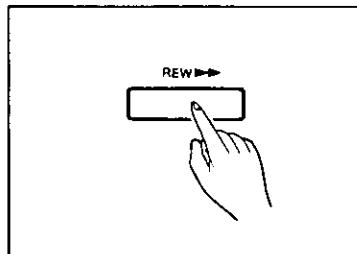

Press the REW button to record messages from the beginning of the tape.

When a call is received, the unit will automatically distinguish between voice and fax calls, and then it will function as an answering device and/or a facsimile.

Note:

- The recording time for incoming messages can be set to VOX (unlimited) or 1 MIN (1 minute). It is preset to VOX. To change the recording time, see page 5-5.

Playing back recorded voice-messages

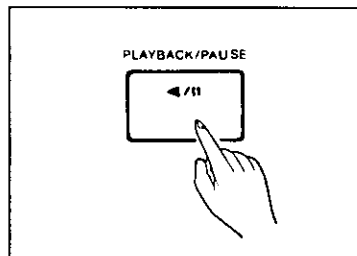

Press the PLAYBACK/PAUSE button.

```
SUN JAN 1 3:00PM 02  
ICM PLAYBACK <<<<<<
```

AUTO-LOGIC (One Touch Operation):

The unit plays all the recorded messages when the PLAYBACK/PAUSE button is pressed. At the end of the last message the tape stops, and 3 beeps are heard. After 7 seconds, the unit resets itself to the TAD/FAX mode. All calls are saved automatically.

Voice time and day stamp

When messages are received, a synthesized announcement of the day and time is recorded after the message.

Recording after the messages you want to save

New incoming messages will be automatically stored after the last message. If you wish to store incoming messages after your saved messages, perform the following steps.

1

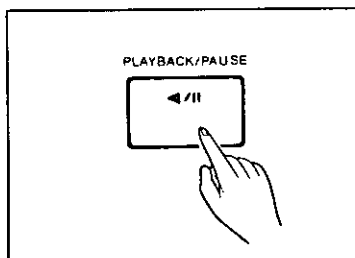

Press the PLAYBACK/PAUSE button to play back the tape to the end of the messages you want to save.

2

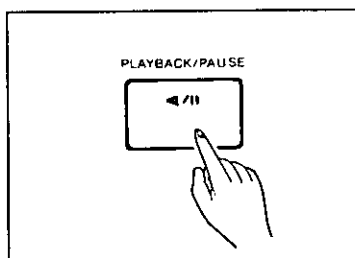

Press the PLAYBACK/PAUSE button again to stop the tape (Pause mode).

The IN USE indicator flashes.

3

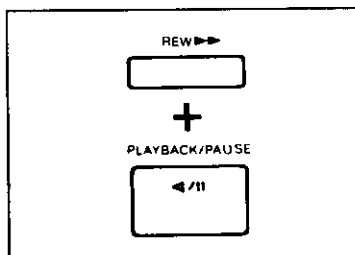

Press the REW and PLAYBACK/PAUSE button together.

New calls will be recorded after the messages you have saved.

Monitoring incoming calls

While an incoming message is being recorded, you can monitor it through the built-in speaker. Adjust the sound level using the VOLUME control.

SUN JAN 1 3:00PM 00
TAD ANSWERING

You can talk to the caller directly by simply lifting the handset. The unit stops recording automatically.

Recording a memo message

If you are going out and you want to leave a private message for someone, you can record a voice memo in the unit. This can then be played back either directly or remotely, exactly like any other incoming message.

1

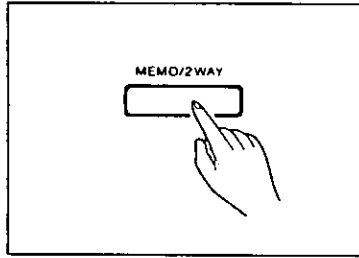

Press the MEMO/2WAY button until a beep is heard.

```
SUN JAN 1  3:00PM 00
MEMO      <<<<<<<
```

2

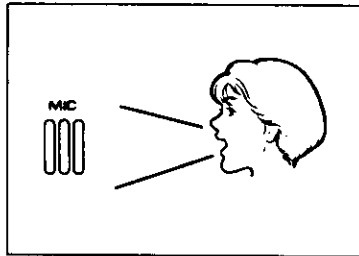

Speak toward the microphone from approximately 20 cm (8 inches) away.

3

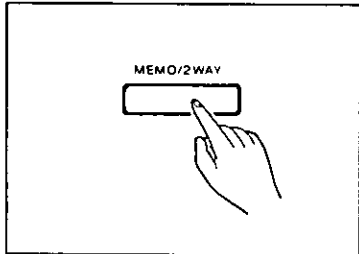

When the recording is finished, press the MEMO/2WAY button again.

The TAD/FAX indicator flashes and the call counter on the display increases by one.

```
SUN JAN 1  3:00PM 01
```

Recording a 2-way conversation

While speaking with someone on the telephone, you can record your conversation. Many states have imposed regulations on the manner in which 2-way telephone conversations may be recorded. Consult your local telephone company for further information.

1

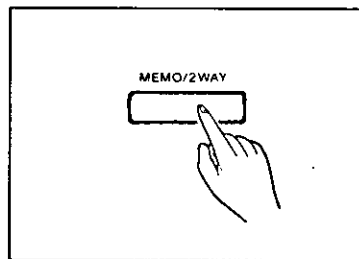

During your conversation, press the MEMO/2WAY button until a beep is heard.

SUN JAN 1 3:00PM 00
2WAY RECORDING

2

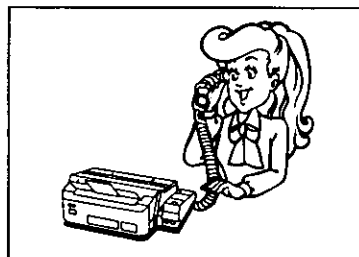

Continue your conversation.

A beep sounds every 15 seconds to notify the caller that the conversation is being recorded.

3

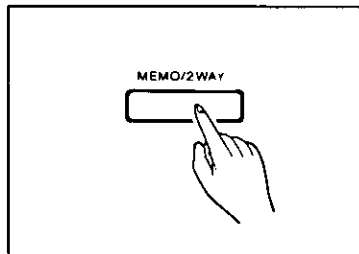

To stop recording, press the MEMO/2WAY button again.

The TAD/FAX indicator flashes and the call counter on the display increases by one.

SUN JAN 1 3:00PM 01

Making and answering voice calls

Making calls

Using the handset:

Lift the handset, then dial the phone number.

Using on-hook dialing:

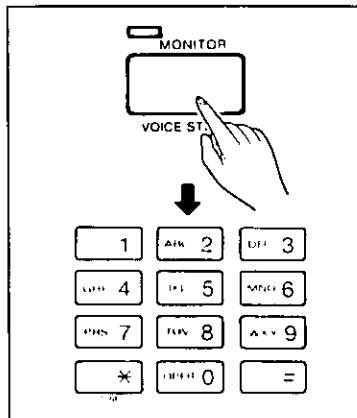

Press the MONITOR button, then dial the phone number.

When the other party answers your call, lift the handset and talk through it.

Redialing

If the line is busy or you wish to redial the last dialed number, you can redial by simply pressing the REDIAL button.

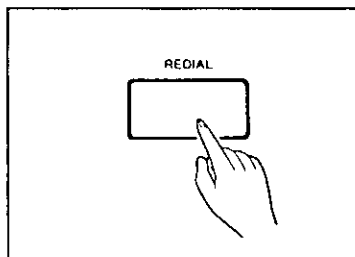

Using the handset:

Lift the handset, then press the REDIAL button.

The unit redials the last dialed number once.

Using on-hook dialing:

Press the MONITOR button, then press the REDIAL button.

If the line is busy, the unit redials the last dialed number automatically up to 15 times within 10 minutes.

During the interval between each redialing, the MONITOR indicator flashes and the display shows "WAITING TO REDIAL". To cancel automatic redialing, press the FLASH button.

Making voice calls using the automatic dialer

The unit's memory allows you to use both one touch dialing (up to 20 phone numbers) and speed dialing (up to 100 phone numbers) for rapid access to your most frequently called numbers. Before using these features, make sure that the desired telephone numbers have been stored into memory. See pages 1-24 to 1-30.

1

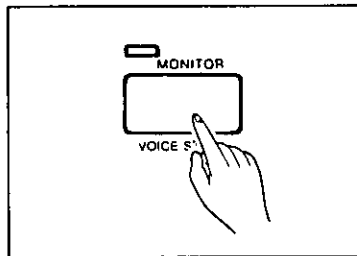

Press the MONITOR button or lift the handset.

2

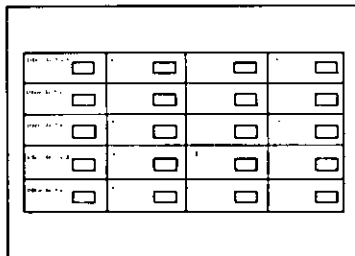

Using the direct call station key:
Press the desired direct call station key.

OR

OR

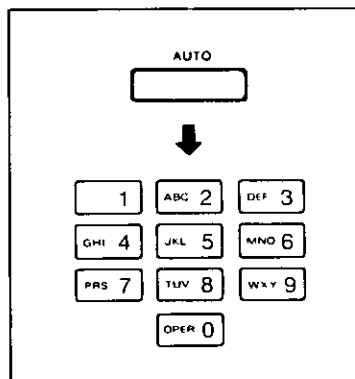

Using the speed dial station:
Press the AUTO button, then press the desired station number (00 through 99) by using the dial keypad.

Answering voice calls

When the phone rings, lift the handset to answer the call.

Making copies

Making copies

The unit can make single and multi copies. Any transmissible documents can be copied. The unit automatically selects the FINE resolution when copying, but you may select the SUPER FINE resolution.

1

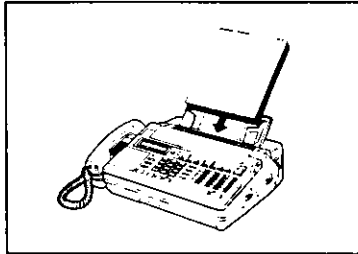

Insert the documents FACE DOWN.

2

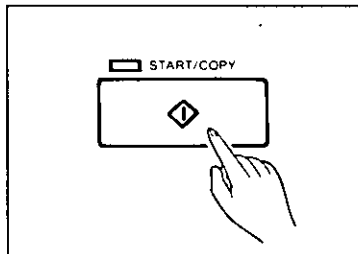

Press the START/COPY button.

ENTER NUMBER OF
COPIES = 1

3

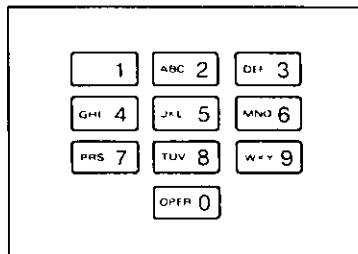

Enter number of copies.

ENTER NUMBER OF
COPIES = XX

If the MULTI COPY SORT function is set to on, the copies are sorted in the order that the documents are scanned. See page 5-5.

4

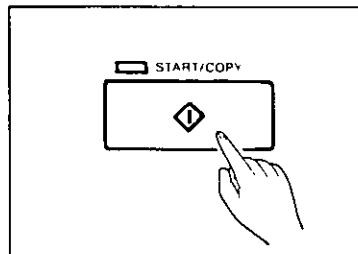

Press the START/COPY button again.

The unit feeds the documents, then starts copying.

Interrupting a copy:
Press the STOP button.

Advanced Instructions

Multi station transmission (MULTI XMT)

By using built-in memory, you can transmit documents to more than one station at a time (maximum 120 stations). This saves you the trouble of sending the same documents to each station one after another. Multistation transmission cannot be performed by dialing a full number. Before using this feature, make sure that the desired phone numbers have been programmed into memory. See pages 1-24 to 1-30.

The documents will be scanned into memory first when using this feature.

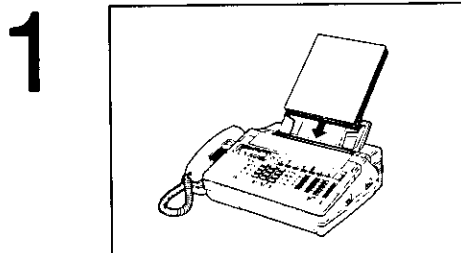

Insert the documents FACE DOWN.

The unit can store about 7 sheets into memory in STANDARD resolution.

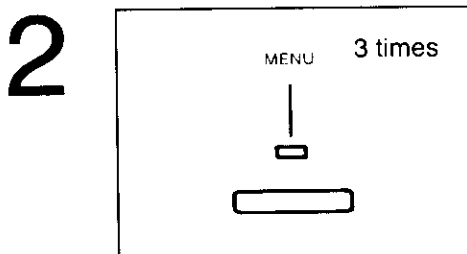

Press the MENU button 3 times.

MULTI XMT MODE
ENTER PHONE NUMBER

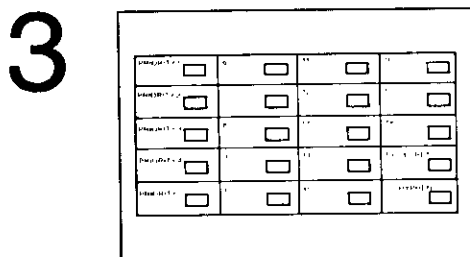

Enter the phone number.

Using one touch dialing:

Press the desired direct call station key.
(Example: Direct call station 7 is dialed.)

ENTER PHONE NUMBER
=<S07> [01]

OR

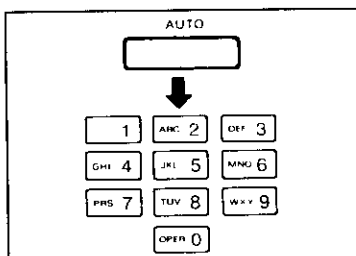

OR

Using speed dialing:

Press the AUTO button, then press the desired speed dial station number (00 through 99).
(Example: Station 00 is dialed.)

ENTER PHONE NUMBER
=<A00> [01]

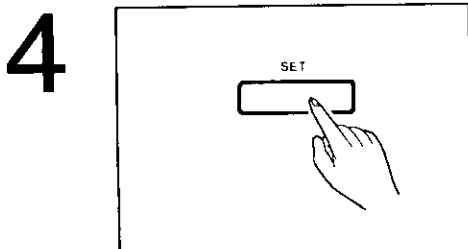

Press the SET button.

ENTER PHONE NUMBER
= [02]

To enter numbers in succession, repeat steps 3 to 4 (up to 120 stations).

5

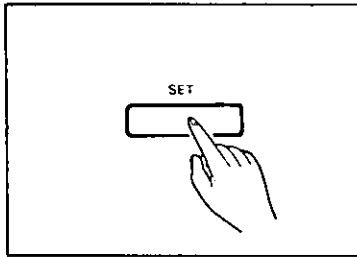

Press the SET button again.

PRESS
[START/COPY] KEY

6

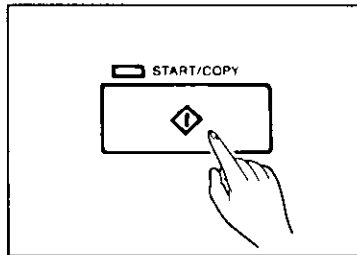

Press the START/COPY button.

The documents are fed into the unit and scanned into memory. The amount of memory used is shown as a percentage on the display. The unit then transmits the documents to each station, calling each number sequentially, one after another.

SUN JAN 1 3:00PM 00
PAGES=XX XX%

DIALING <MULTI XMT>
TO:<S07>

SENDING P1
TO:PANASONIC

To cancel a multi station transmission:

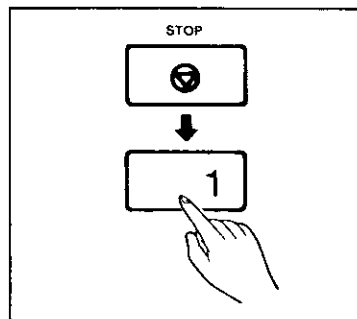

Press the STOP button.

CANCEL MULTI
XMT? [1. YES 2. NO]

Press "1" for cancel.

If you press the STOP button while dialing or transmitting, only displayed transaction is canceled.

Note:

- Memory capacity (about 7 pages) applies to text data using CCITT No. 1 test chart in STANDARD resolution. Please select STANDARD resolution when using multistation transmission. If you select FINE, SUPER FINE or HALF TONE resolution, the number of documents is decreased.
- When the percentage reaches over 99% while the documents are being scanned, the display shows "MEMORY FULL". The current page and any remaining pages will be canceled.
- If one of the stations is busy or does no answer, the station is skipped. The unit automatically dials the next selected station. All skipped station(s) is redialed 6 times after all other stations have been called.
- A MULTI TRANSMISSION REPORT is printed out after the transmission and let you know the result. See page 4-5.

Polling

Polling means that you call another facsimile machine (we call it "polled machine") to retrieve a document. Polling also lets you place documents in the unit that will be "retrieved" only at the request of a calling machine. The receiving unit incurs any long distance telephone charges since the polling unit initiates the call.

Being polled

In order to let other units poll your unit, you must set the documents in the document feeder tray of your unit.

1

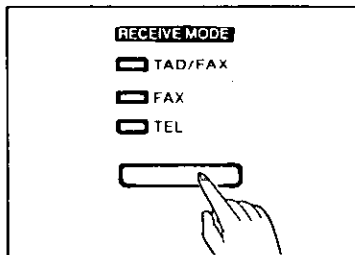

Set the unit to the TAD/FAX or FAX mode.

2

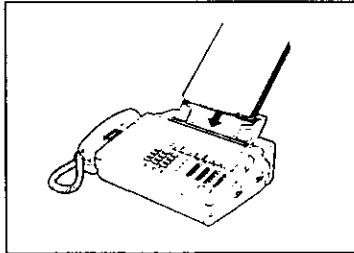

Insert the documents FACE DOWN.

The unit can accept up to 10 sheets at a time.

3

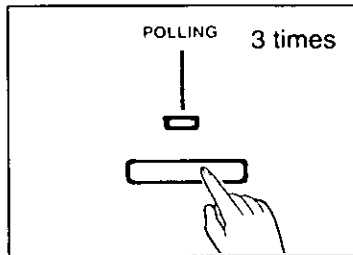

Press the POLLING button 3 times.

POLLED ? PRESS
[START/COPY] KEY

4

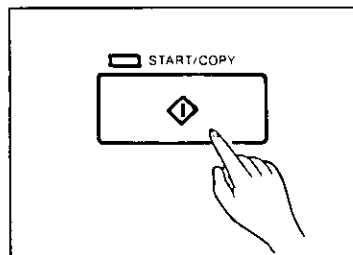

Press the START/COPY button.

SUN JAN 1 5:00AM 00
POLLED ON

The unit is now ready for being polled.

To cancel polled mode:

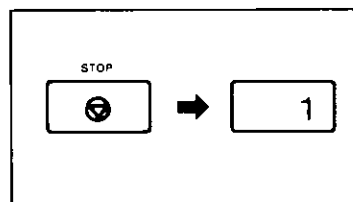

Press the STOP button.

CANCEL POLLED
MODE? [1.YES 2.NO]

Press "1".

Note:

- Automatic reception is still possible while the unit is in a polled mode.

Single station polling

The following procedure lets you poll one station.

To activate the polling, the other station must be prepared for your call.

1

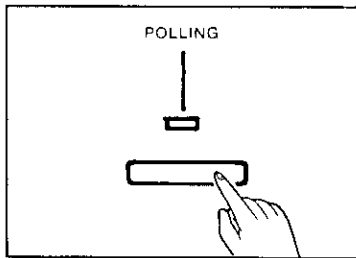

Press the POLLING button.

```
POLLING
ENTER PHONE NUMBER
```

2

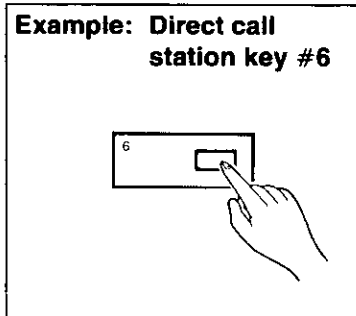

Enter the phone number you wish to poll using the direct call station key, the speed dial station or a full number.

(Example: Direct call station 6 is dialed.)

```
ENTER PHONE NUMBER
=<S06> [01]
```

3

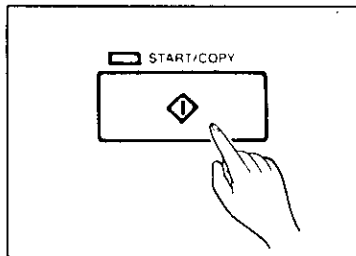

Press the START/COPY button.

Polling is then carried out.

```
DIALING <POLL>
TO:<S06>
```



```
POLLING P1
FROM:<S06>
```

Note:

- If the polled station is busy or there is no answer, the unit automatically redials the number up to 6 times within 10 minutes. If you receive or make another call during the automatic redial period, the redial is canceled.

Multi station polling

The unit can poll up to 120 stations in one operation. Polled stations must be selected with the direct call station keys and/or the speed dial stations.
 Before using this feature, make sure that the desired phone numbers have been programmed into memory. See pages 1-24 to 1-30.
 For successful polling, the polled stations also must have made preparations.

1

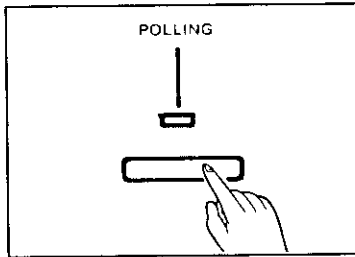

Press the POLLING button.

POLLING
 ENTER PHONE NUMBER

2

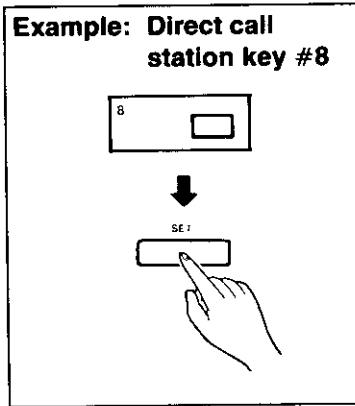

Enter the phone number you wish to poll using the direct call station key or the speed dial station, then press the SET button. (Example: Direct call station 8 is dialed.)

ENTER PHONE NUMBER
 =<S08> [01]

ENTER PHONE NUMBER
 = [02]

To enter numbers in succession, repeat this procedure.

3

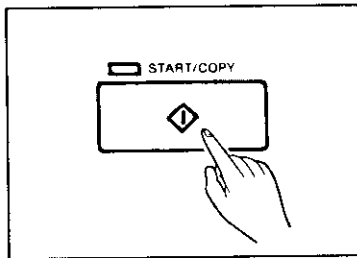

Press the START/COPY button.

Polling is then carried out.

DIALING<POLL>
 TO:<S06>



POLLING P1
 FROM:<S06>

To cancel a multi station polling:

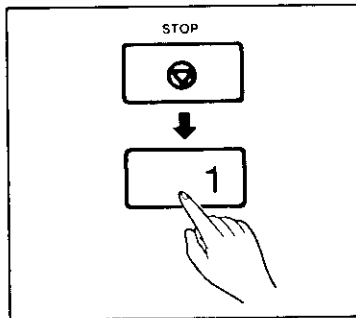

Press the STOP button.

CANCEL MULTI
 POLLING? [1. YES 2. NO]

Press "1" for cancel.

If you press the STOP button while dialing or transmitting, only displayed transaction is canceled.

Note:

- If one of the polled stations is busy or does not answer, the station is skipped. The unit automatically dials the next selected station. The skipped station(s) is redialed up to 6 times after all other selected stations have been called.
- A MULTI POLLING REPORT will be automatically printed out when polling ends. For further details, see page 4-6.

Turnaround polling

Turnaround polling allows you to send a document and poll a document during the same telephone call. First, the unit transmits the documents to the selected station, and then it retrieves documents set up to be polled from that station.

To activate the turnaround polling, the other station must be prepared for your call.

1

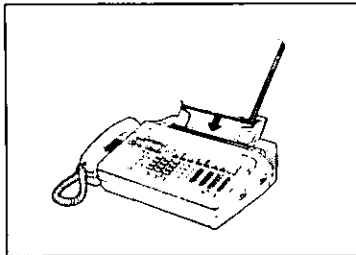

Insert the documents FACE DOWN.

2

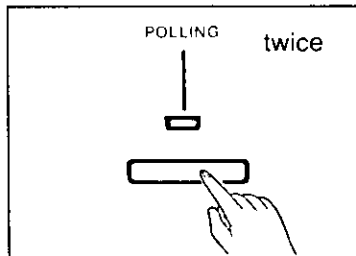

Press the POLLING button twice.

XMT&POLLING
ENTER PHONE NUMBER

3

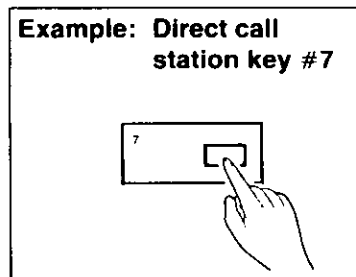

Enter the phone number using the direct call station key, the speed dial station or a full number. (Example: Direct call station #7 is dialed.)

ENTER PHONE NUMBER
=<S07>

4

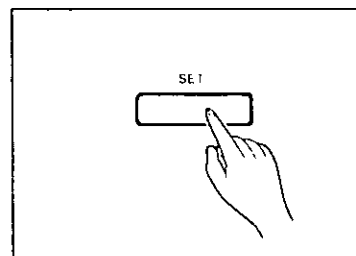

Press the SET button.

PRESS
[START/COPY] KEY

5

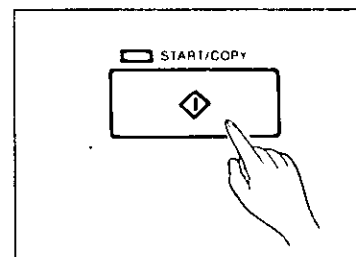

Press the START/COPY button.

The unit will start transmission.
After transmission, the unit automatically switches to the polling mode and polls the remote station.

Note:

- If the line is busy or there is no answer, the unit automatically redials the number up to 6 times within 10 minutes. If you receive or make another call during the automatic redial period, the redial is canceled.

Setting the polling password

In order to prevent an unauthorized machine from retrieving a confidential document during polling, you can program a unique code (password) into your unit. If the passwords in the polling unit and polled unit do not match, any transaction will not take place.

The polling password is only effective between Panasonic compatible facsimile machines (e.g. KX-F50, KX-F90, KX-F110, KX-F220, KX-F320).

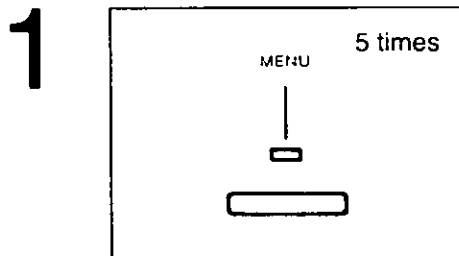

Press the MENU button 5 times.

PROGRAM[1.DATE 2.TEL
3.SYSTEM 4.REPORT]

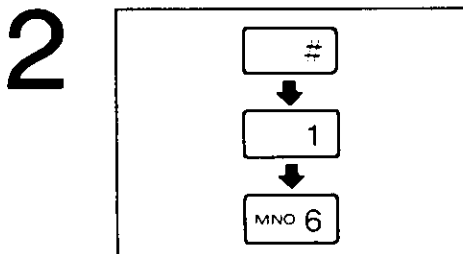

Press "#", then press "16" for POLLING
PASSWORD setting.

16.POLLING PASSWORD
=0000

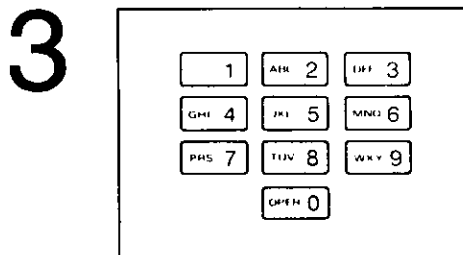

Enter your polling password of 4 digits using the
dial keypad.

You can choose among numbers "0001" through
"9999" as the password.

To correct an error while programming, press the
CLEAR button then correct input.

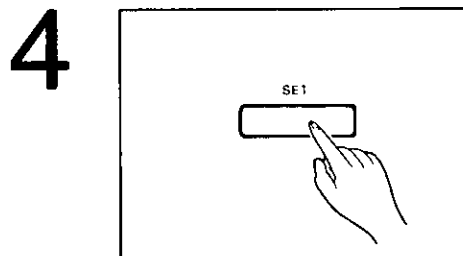

Press the SET button to store the selected
password into memory.

PROGRAM[1.DATE 2.TEL
3.SYSTEM 4.REPORT]

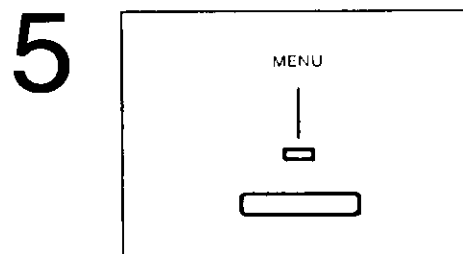

Press the MENU button to end the operation.

Note:

- If the polling password is set to "0000", the unit does not check the password sent by other facsimile machines. (This is the default setting.)

Delayed transmission/polling

This unit can send documents or poll another unit automatically at a specific time. This allows you to take advantage of low-cost calling hours given by some telephone companies. The unit provides you with three types of delayed operations; delayed transmission, delayed polling and delayed turnaround polling.

Note:

- A delayed operation can be reserved to take place within 24 hours in advance.

Delayed single station transmission

1

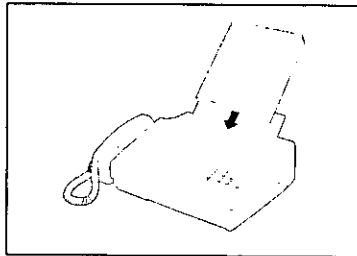

Insert the documents FACE DOWN.

2

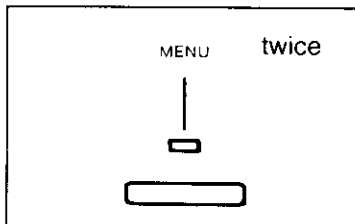

Press the MENU button twice.

DELAYED [1.OFF 2.XMT
3.POLL 4.XMT&POLL]

3

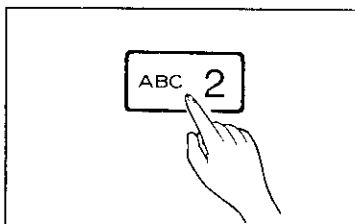

Press "2" for the delayed transmission setting.

ENTER PHONE NUMBER
= [01]

4

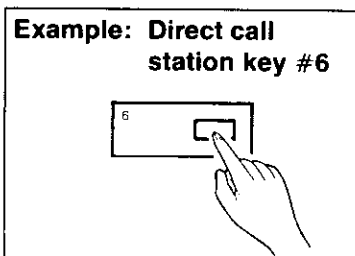

Enter the desired phone number using the direct call station key, the speed dial station or a full number.

(Example: Direct call station 6 is dialed.)

ENTER PHONE NUMBER
= <S06> [01]

5

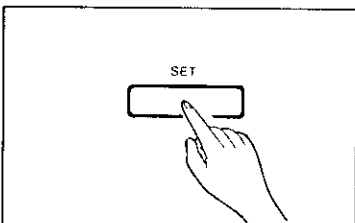

Press the SET button twice.

If entering phone number using a full number, press the SET button once.

SET START TIME
12:00AM [*=AM #=PM]

6

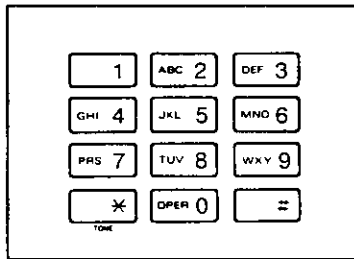

Enter the time at which the unit starts transmission. (Example: If the starting time is 11:00PM, press "1 1 0 0", then press "#".)

SET START TIME
11:00PM [*=AM #=PM]

7

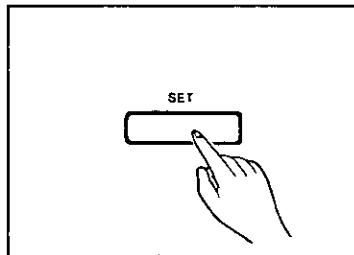

Press the SET button.

SUN JAN 1 3:30PM 00
XMT AT 11:00PM

The delayed transmission has been set.

To cancel the delayed transmission:

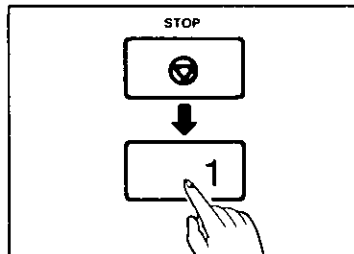

Press the STOP button.

CANCEL DELAYED
XMT? [1.YES 2.NO]

Then press "1".

Note:

- You can receive, transmit and copy documents while the delayed transmission is set. To copy or transmit documents after setting delayed transmission, remove documents from the tray and replace them when you have finished.
- If there is no answer or the line is busy during the delayed operation, the unit automatically redials the number up to 6 times within 10 minutes.
- Only one delayed transmission can be set. If you set another delayed transmission, delayed polling or delayed turnaround polling, the previous one is overridden.

Delayed multi station transmission

You can transmit a document to up to 120 stations in one operation by using direct call station keys and/or speed dial stations.

Before using this feature, perform steps 1 through 3 on page 3-8.

1

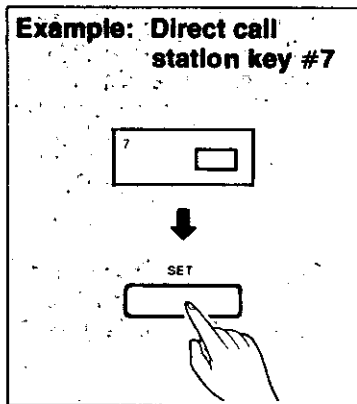

Enter the desired phone number using the direct call station key or the speed dial station, then press the SET button.
(Example: Direct call station 7 is dialed.)

ENTER PHONE NUMBER
=<S07> [01]

ENTER PHONE NUMBER
= [02]

To enter numbers in succession, repeat this procedure.

2

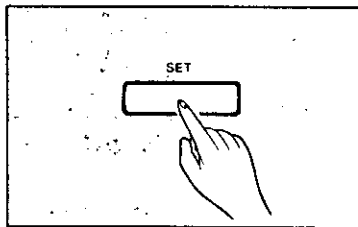

Press the SET button again.

SET START TIME
12:00AM [*=AM #=PM]

3

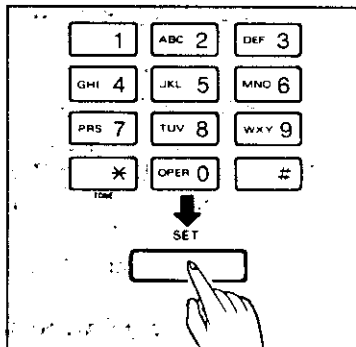

Enter the time at which the unit starts transmission. (Example: If the starting time is 11:00PM, press "1 1 0 0", then press "#".)

SET START TIME
11:00PM [*=AM #=PM]

Then press the SET button.

PRESS
[START/COPY] KEY

4

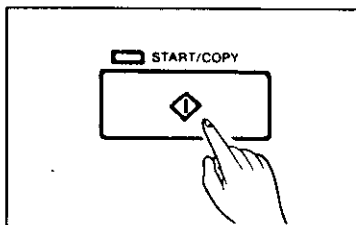

Press the START/COPY button.

SUN JAN 1 3:00 00
PAGE=01 XX%

The documents are fed into the unit to be stored into memory.

SUN JAN 1 3:00 00
XMT AT 11:00PM

Note:

- If there is no answer or the line is busy during the delayed operation, the unit automatically redials the number up to 6 times within 10 minutes.
- Only one delayed multistation transmission can be set. If you set another delayed multistation transmission, the previous one is overridden.

Delayed polling

You can poll up to 120 stations in one operation by using the direct call station keys and/or the speed dial stations. When you enter the phone number using a full number, only one station is acceptable.

1

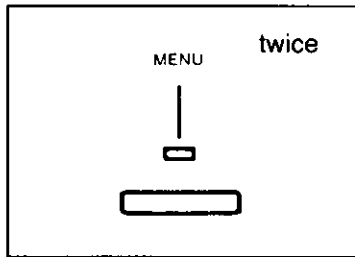

Press the MENU button twice.

DELAYED [1.OFF 2.XMT
3.POLL 4.XMT&POLL]

2

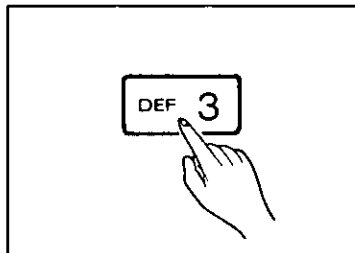

Press "3" for the delayed polling setting.

ENTER PHONE NUMBER
= [01]

3

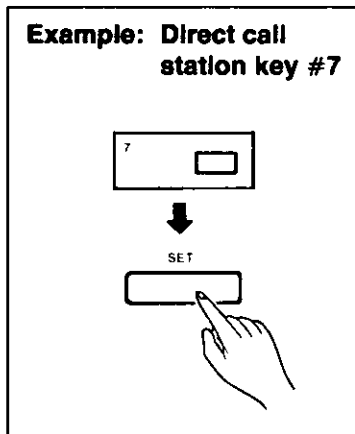

Enter the desired phone number using the direct call station key, the speed dial station or a full number.

(Example: Direct call station 7 is dialed.)

ENTER PHONE NUMBER
= <S07> [01]

Then press the SET button.

ENTER PHONE NUMBER
= [02]

If you wish to add more stations, repeat this procedure.

When entering the phone number by using a full number, only one station is acceptable.

4

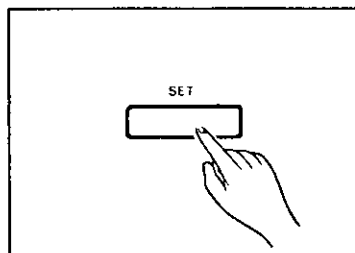

Press the SET button again if using the direct call station key or the speed dial station.

SET POLLING TIME
12:00AM [*=AM #=PM]

5

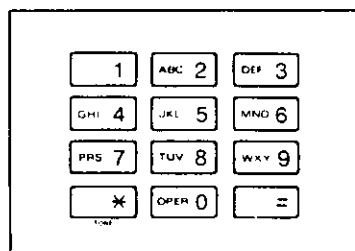

Enter the time at which the unit starts polling.

(Example: If the starting time is 11:00PM, press "1 1 0 0", then press "#".)

SET POLLING TIME
11:00PM [*=AM #=PM]

6

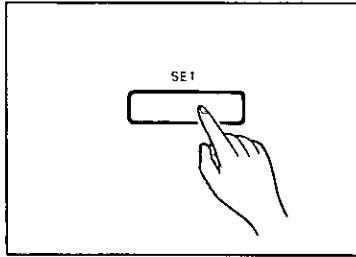

Press the SET button.

SUN JAN 1 3:00PM 00
POLLING AT 11:00PM

The delayed polling has been set.

To cancel delayed polling:

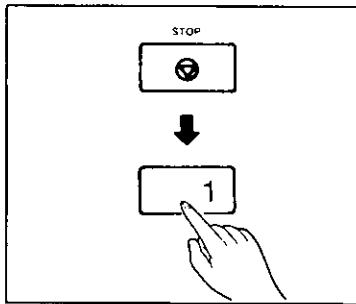

Press the STOP button.

CANCEL DELAYED
POLLING?[1.YES 2.NO]

Then press "1".

Note:

- You can receive, transmit and copy documents while the delayed polling feature is set.
- If there is no answer or the line is busy during the delayed operation, the unit automatically redials the number up to 6 times within 10 minutes.
- Only one delayed polling can be set. If you set another delayed polling, delayed turnaround polling or being polled, the previous one is overridden.

Delayed turnaround polling

You can transmit a document to the selected station then retrieve a document fed into the same station in one call at a preset time.

1

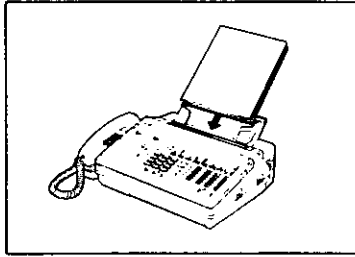

Insert the documents FACE DOWN.

2

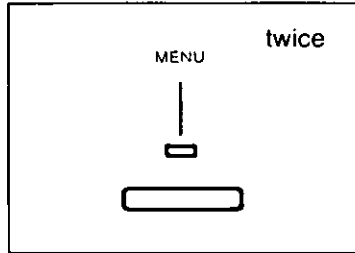

Press the MENU button twice.

DELAYED [1.OFF 2.XMT
3.POLL 4.XMT&POLL]

3

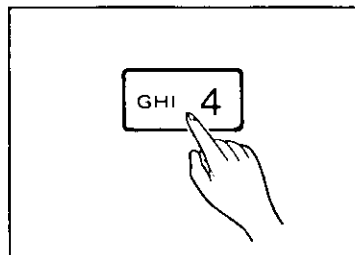

Press "4" for the delayed turnaround polling setting.

ENTER PHONE NUMBER

=

4

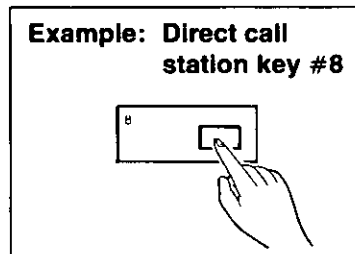

Enter the desired phone number using the direct call station key, the speed dial station or a full number.

(Example: Direct call station 8 is dialed.)

ENTER PHONE NUMBER

=<S08>

5

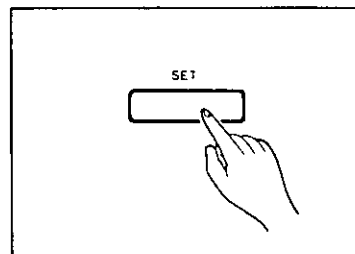

Press the SET button.

SET START TIME

12:00AM [*=AM #=PM]

6

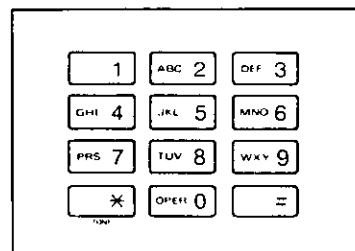

Enter the time when you wish to start turnaround polling. (Example: If the starting time is 11:00PM, press "1 1 0 0", then press "#".)

SET START TIME

11:00PM [*=AM #=PM]

7

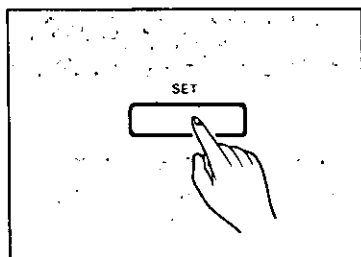

Press the SET button.

SUN JAN 1 3:00PM 00
XMT&POLL AT 11:00PM

The delayed turnaround polling has been set.

To cancel turnaround polling:

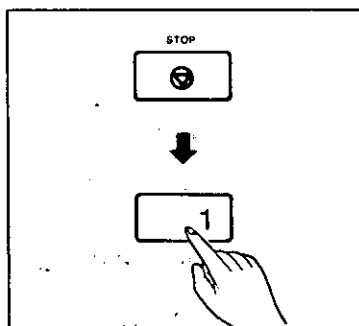

Press the STOP button.

CANCEL DELAYED
XMT&POLL?[1.YES 2.NO]

Then press "1".

Note:

- You can receive, transmit and copy a document while the delayed turnaround polling is set. To copy or transmit documents after setting delayed XMT&POLL, remove documents from the tray and replace them when you have finished.
- If there is no answer or the line is busy during the delayed operation, the unit automatically redials the number up to 6 times within 10 minutes.
- Only one delayed turnaround polling can be set. If you set another delayed turnaround polling, delayed polling or being polled, the previous one is overridden.

Memory transmission/polling

The unit can store the documents (about 7 pages*) into memory and then the unit transmits the stored documents either immediately or at a later time.

Please select STANDARD resolution when memory transmission is performed. If you select FINE or SUPER FINE resolution, the number of documents that can be stored into memory is decreased.

*Memory capacity (about 7 pages) applies to text data using CCITT No.1 test chart in STANDARD mode (Resolution).

Memory transmission

When using memory transmission, the unit scans the pages first into memory allowing you to walk a way with your originals before the actual transmission takes place.
The stored documents are erased automatically after transmission.

Setting

1

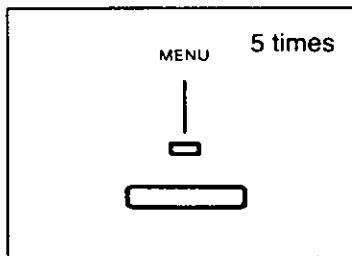

Press the MENU button 5 times.

PROGRAM[1.DATE 2.TEL
3.SYSTEM 4.REPORT]

2

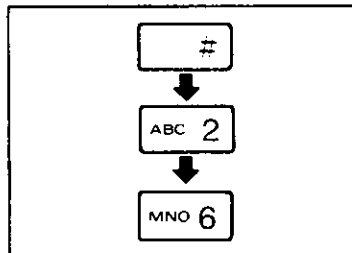

Press "#", then press "2".

26.MEMORY XMT=OFF
[1.OFF 2.ON]

3

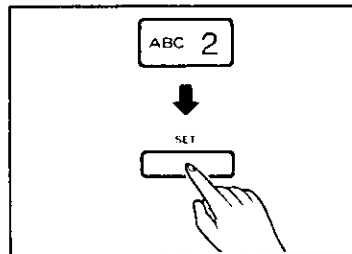

Press "2", then press the SET button.

26.MEMORY XMT=ON
[1.OFF 2.ON]

PROGRAM[1.DATE 2.TEL
3.SYSTEM 4.REPORT]

4

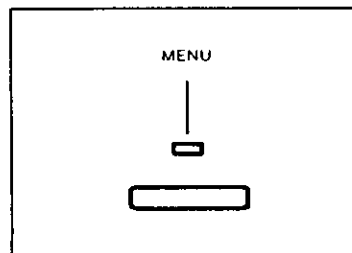

Press the MENU button to end the operation.

Operation

Example: Transmission to the station selected with a direct call station key.

1

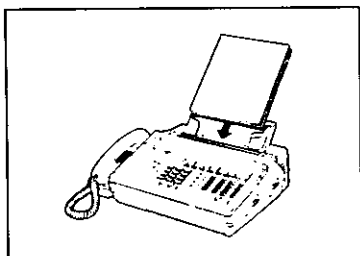

Insert the documents FACE DOWN.

2

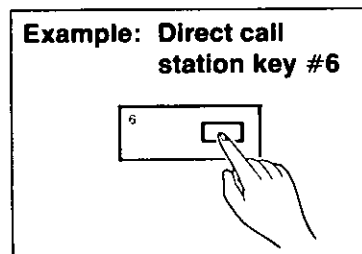

Press the desired direct call station key.
(Example: Direct call station 6 is dialed.)

The documents are stored into memory.
The display shows;

```
SUN JUN 1  5:50PM 00
PAGES=01      XX%
```



```
DIALING <XMT>
TO:<Panasonic>
```



```
SENDING      P1
TO:<Panasonic>
```



```
SUN JAN 1  5:51PM 00
7PAGES  SENT OK
```

The amount of memory used is shown as a percentage at the lower right corner of the display after each page is stored. When the percentage reaches over 99%, "MEMORY FULL" is displayed and the current page and any remaining pages will be canceled.

To cancel:
Press the STOP button.

```
SUN JAN 1  5:51PM 00
USER STOPPED
```

Note:

- If a power failure occurs, the stored documents are lost. A report will be printed stating that the contents have been cleared due to "power down".

Memory delayed transmission

You can store documents for later transmission or retention using Memory delayed transmission. This is useful when Delayed XMT or Delayed XMT&POLL is performed. The stored documents are erased automatically after transmission.

Setting

1

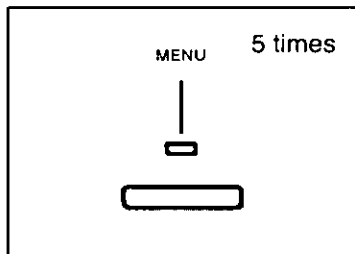

Press the MENU button 5 times.

PROGRAM[1.DATE 2.TEL
3.SYSTEM 4.REPORT]

2

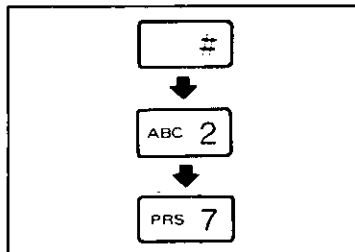

Press "#", then press "27".

27.MEMORY DELAYED
XMT=OFF [1.OFF 2.ON]

3

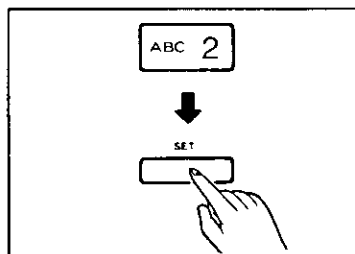

Press "2", then press the SET button.

27.MEMORY DELAYED
XMT=ON [1.OFF 2.ON]

PROGRAM[1.DATE 2.TEL
3.SYSTEM 4.REPORT]

4

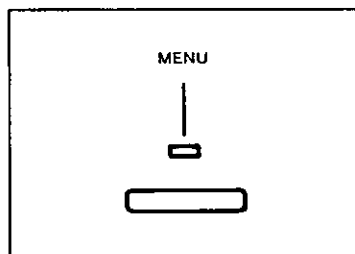

Press the MENU button to end the operation.

Operation

1. Perform steps 1 through 7 on pages 3-8 and 3-9.
2. Press the START/COPY button.
When the START/COPY button is pressed, the documents are scanned into memory.

Note:

- If a power failure occurs, the stored documents are lost. A report will be printed stating that the contents have been cleared due to "power down".

Memory polling

Being polled can be performed after your documents are stored into memory. You may store documents that are to be polled into memory. This eliminates someone removing documents from the feeder and forgetting to replace them.

Setting

1

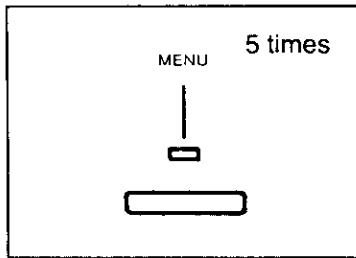

Press the MENU button 5 times.

PROGRAM[1.DATE 2.TEL
3.SYSTEM 4.REPORT]

2

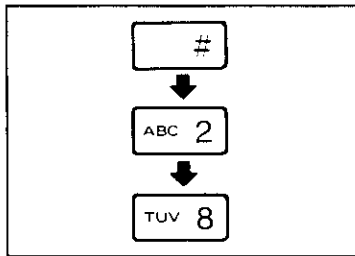

Press "#", then press "28".

28.MEMORY POLLING
=OFF [1.OFF 2.ON]

3

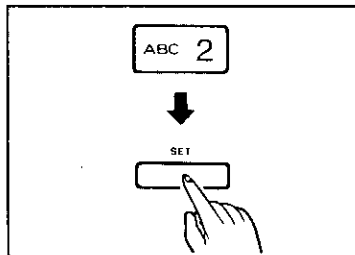

Press "2", then press the SET button.

28.MEMORY POLLING
=ON [1.OFF 2.ON]

PROGRAM[1.DATE 2.TEL
3.SYSTEM 4.REPORT]

4

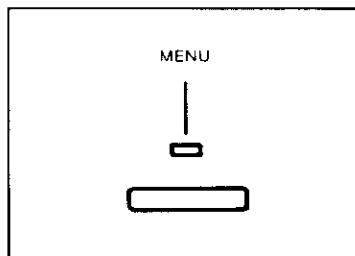

Press the MENU button to end the operation.

Operation

Do the same operation on page 3-3 (Being polled).
When the START/COPY button is pressed, the documents are scanned into memory.

Note:

- The stored documents have been kept in memory even after transmission. This is very useful when you need to transmit the same documents to several stations.
To erase the stored documents, press the STOP button, then press "1".
- If a power failure occurs, the stored documents are lost. A report will be printed stating that the contents have been cleared due to "power down".

Using the PRIORITY keys

The unit has 5 PRIORITY keys. Each key is used to program communication parameters and starting time as well as a phone number in a direct call station key. The programmed operation works automatically by just pressing the appropriate PRIORITY key. This is very useful when you perform the same functions frequently. You are able to set these keys once eliminating lengthy programming each time you perform a function.

The types of operations that can be set in a PRIORITY key include (1) delayed transmission, (2) (delayed) multi transmission, (3) (delayed) single station polling, (4) (delayed) multi station polling, (5) (delayed) turnaround polling.

Note:

- The PRIORITY keys can also be used as direct call station keys #1 to #5, but they cannot be used for two purposes. For example, if the direct call station key #1 has already been used for a number, it cannot be used as the PRIORITY key #1.
- You can print out the PRIORITY KEY LIST for confirmation after programming. (See page 4-6.)

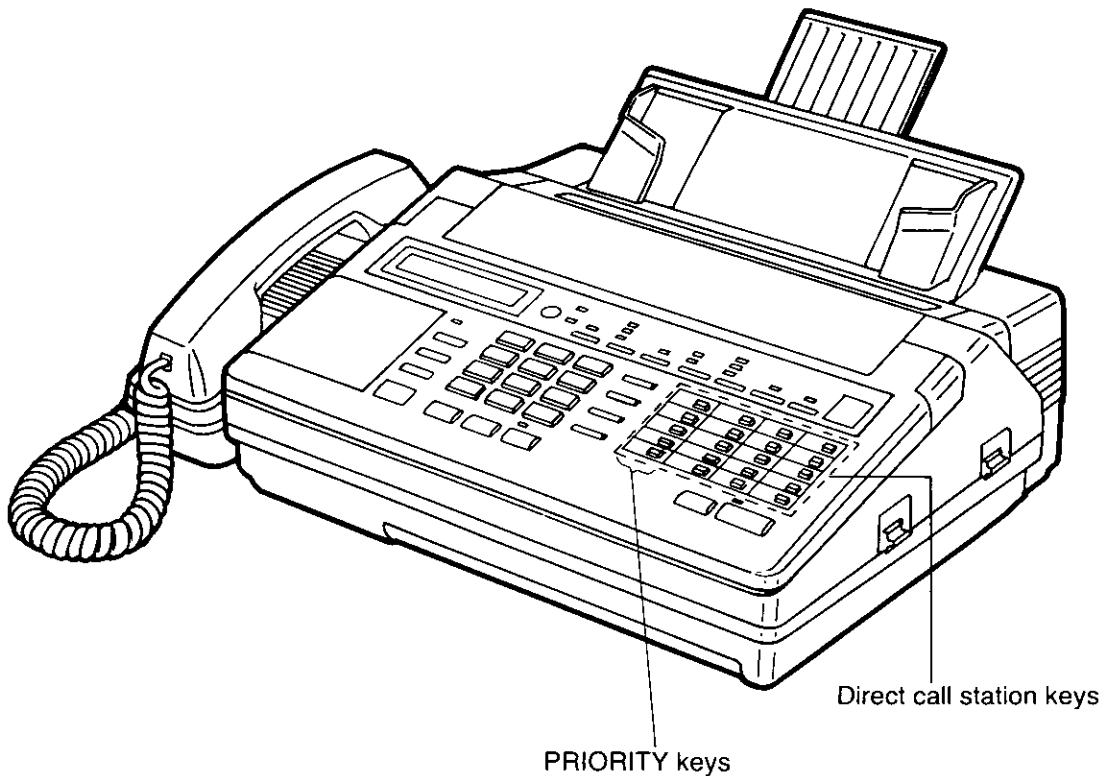

Initial procedure for programming

1

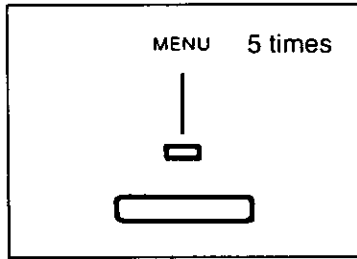

Press the MENU button 5 times.

PROGRAM[1.DATE 2.TEL
3.SYSTEM 4.REPORT]

2

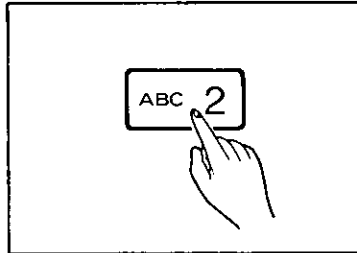

Press "2".

SELECT AUTO OR
DIRECT CALL KEY

3

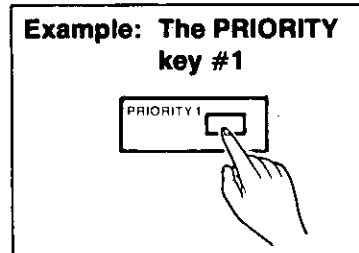

Press the desired PRIORITY key (#1 through #5) in which you wish to program.

(Example: The PRIORITY key 1 is pressed.)

PRIO.1 MODE=DIAL
[1.DIAL 2.PROG.]

4

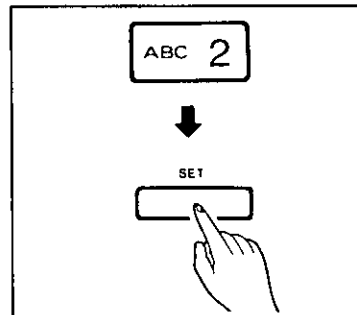

Press "2" for programming, then press the SET button.

MODE=XMT {1.XMT
2.POLL 3.XMT&POLL}

If you use this key as a direct call station key, press "1" instead of "2", then enter the phone number and station name. Refer to pages 1-25 and 1-26.

5

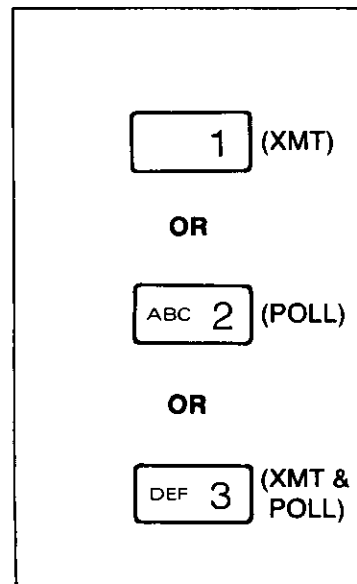

Press "1", "2" or "3" to select the desired mode.

Press "1" for transmission (XMT) mode.
(Go to page 3-21 for delayed transmission.)
(Go to page 3-22 for multi transmission.)

Press "2" for polling (POLL) mode.
(Go to page 3-24 for single station polling.)
(Go to page 3-25 for multi station polling.)

Press "3" for turnaround polling (XMT&POLL) mode.
(Go to page 3-27.)

Programming delayed single station transmission

Follow these steps after performing the initial procedure on page 3-20.

6

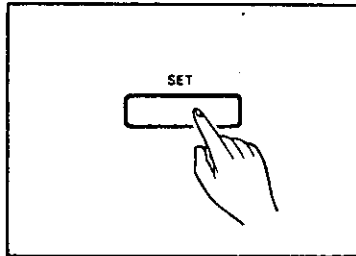

Press the SET button.

ENTER PHONE NUMBER
= [01]

7

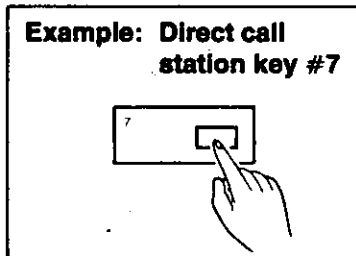

Enter the phone number using the direct call station key, the speed dial station or a full number. (Example: Direct call station 7 is dialed.)

ENTER PHONE NUMBER
=<S07> [01]

8

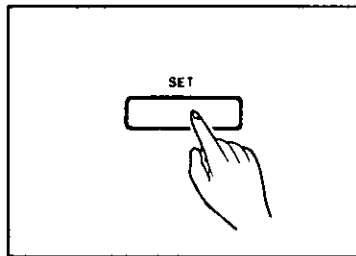

Press the SET button twice. When using a full number, press the SET button once.

DELAYED XMT=OFF
[1.OFF 2.ON]

9

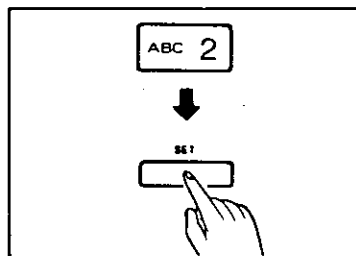

Press "2" to perform delayed XMT, then press the SET button.

SET START TIME
12:00AM [*=AM #=PM]

10

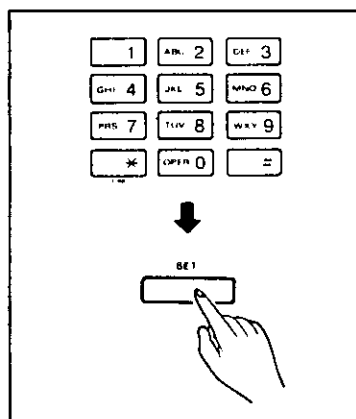

Enter the desired starting time using the dial keypad, then press the SET button. (For example: If the starting time is 11:00PM, press "1 1 0 0" and "#", then press the SET button.)

SET START TIME
11:00PM [*=AM #=PM]



SELECT AUTO OR
DIRECT CALL KEY

11

Press the MENU button to end the operation.

Advanced Instructions

Programming (delayed) multi transmission

Before programming multi transmission, the desired phone numbers must be stored to direct call station keys and/or speed dialing keys.

Follow these steps after performing the initial procedure on page 3-20.

6

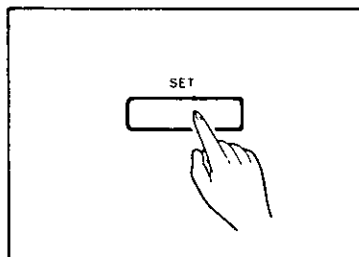

Press the SET button.

ENTER PHONE NUMBER
= [01]

7

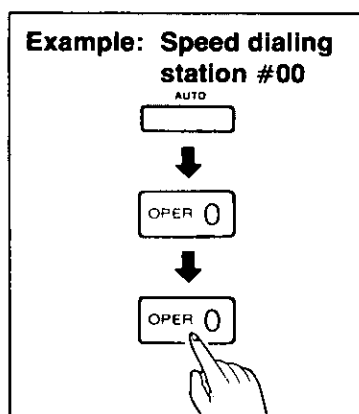

Enter the phone number using the direct call station key or the speed dial station.
(Example: Speed dial station 00 is dialed.)

ENTER PHONE NUMBER
=<A00> [01]

8

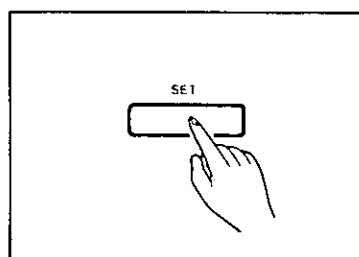

Press the SET button to store the phone number.

ENTER PHONE NUMBER
= [02]

To enter numbers in succession, repeat steps 7 and 8.

9

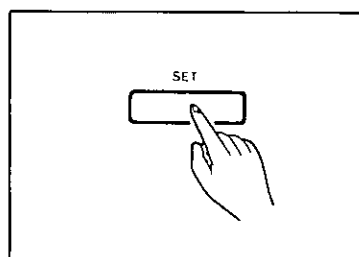

Press the SET button again.

DELAYED XMT=OFF
[1.OFF 2.ON]

10

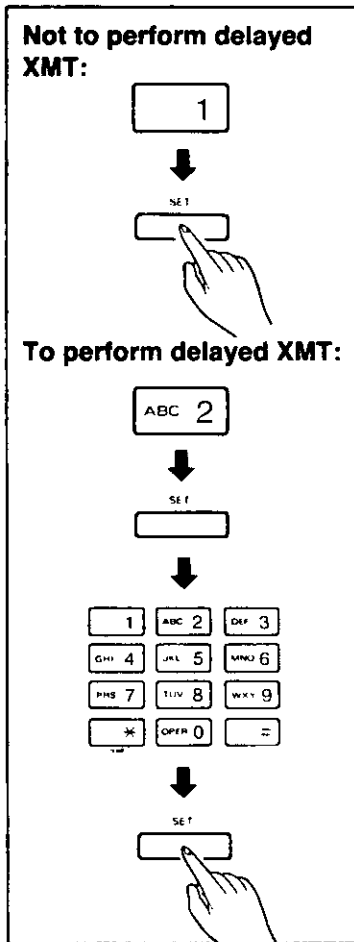

Select the desired mode.

If you do not want to perform delayed XMT:
Press "1", then press the SET button.

SELECT AUTO OR
DIRECT CALL KEY

If you want to perform delayed XMT:

1. Press "2", then press the SET button.

SET START TIME
12:00AM [*=AM #=PM]

2. Enter the desired starting time using the dial keypad. (Example: The start time is 11:00PM)

SET START TIME
11:00PM [*=AM #=PM]

3. Press the SET button.

SELECT AUTO OR
DIRECT CALL KEY

11

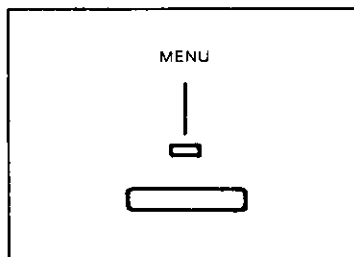

Press the MENU button to end the operation.

Programming (delayed) single station polling

Follow these steps after performing the initial procedure on page 3-20.

6

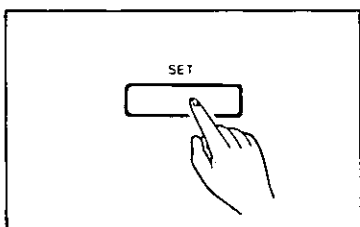

Press the SET button.

ENTER PHONE NUMBER
= [01]

7

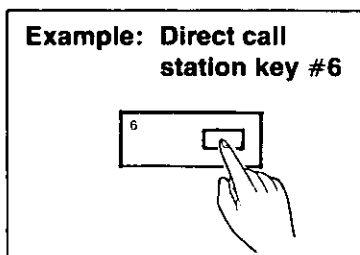

Enter the phone number using the direct call station key, the speed dial station or a full number. (Example: Direct call station 6 is dialed.)

ENTER PHONE NUMBER
=<S06> [01]

8

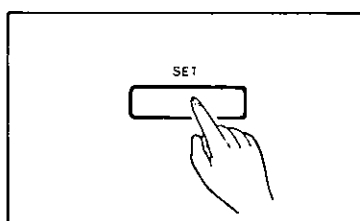

Press the SET button twice.

When using a full number, press the SET button once.

DELAYED XMT=OFF
[1.OFF 2.ON]

9

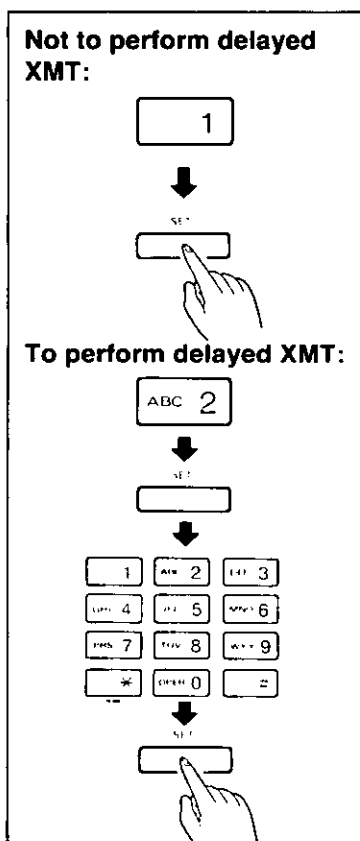

Select the desired mode.

If you do not want to perform delayed XMT:

Press "1", then press the SET button.

SELECT AUTO OR
DIRECT CALL KEY

If you want to perform delayed XMT:

1. Press "2", then press the SET button.

SET START TIME
12:00AM [*=AM #=PM]

2. Enter the desired starting time using the dial keypad. (Example: The start time is 11:00PM)

SET START TIME
11:00PM [*=AM #=PM]

3. Press the SET button.

SELECT AUTO OR
DIRECT CALL KEY

10

Press the MENU button to end the operation.

Advanced Instructions

Programming (delayed) multi station polling

Before programming multi polling, the desired phone numbers must be stored to the direct call station keys and/or the speed dialing keys.

Follow these steps after performing the initial procedure on page 3-20.

6

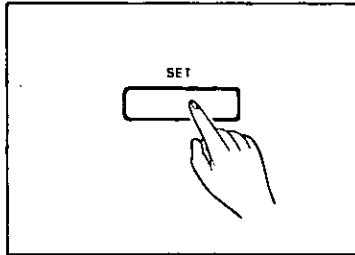

Press the SET button.

ENTER PHONE NUMBER
= [01]

7

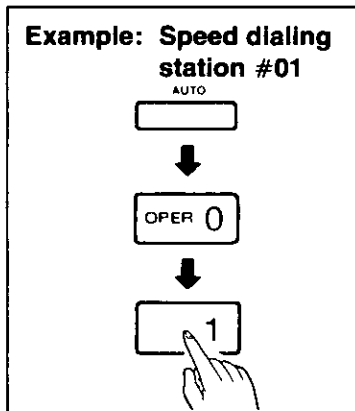

Enter the phone number using the direct call station key or the speed dial station.
(Example: Speed dial station 01 is dialed.)

ENTER PHONE NUMBER
=<A01> [01]

8

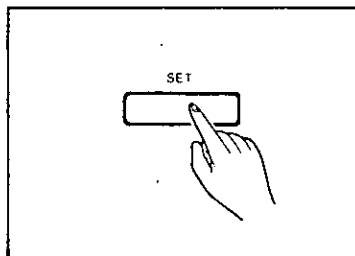

Press the SET button to store the phone number.

ENTER PHONE NUMBER
= [02]

To enter numbers in succession, repeat steps 7 and 8.

9

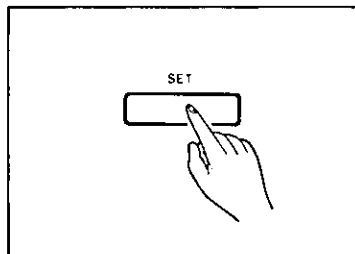

Press the SET button again.

DELAYED XMT=OFF
[1.OFF 2.ON]

10

Not to perform delayed polling:

1



SET



To perform delayed polling:

ABC 2



SET

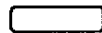

SET



Select the desired mode.

If you do not want to perform delayed polling:
Press "1", then press the SET button.

SELECT AUTO OR
DIRECT CALL KEY

If you want to perform delayed polling:
1. Press "2", then press the SET button.

SET START TIME
12:00AM [*=AM #=PM]

2. Enter the desired starting time using the dial keypad. (Example: The start time is 11:00PM)

SET START TIME
11:00PM [*=AM #=PM]

3. Press the SET button.

SELECT AUTO OR
DIRECT CALL KEY

11

MENU



Press the MENU button to end the operation.

Programming (delayed) turnaround polling

Follow these steps after performing the initial procedure on page 3-20.

6

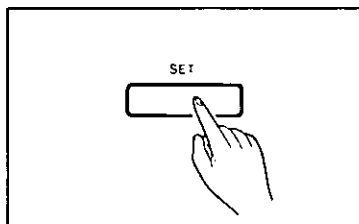

Press the SET button.

ENTER PHONE NUMBER
=

7

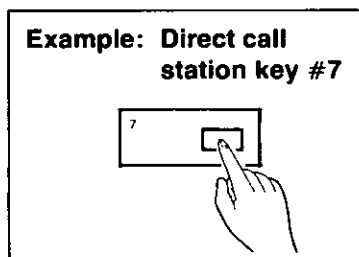

Enter the desired phone number using the direct call station key, the speed dial station or a full number.

(Example: Direct call station #7 is dialed.)

ENTER PHONE NUMBER
=<S07>

8

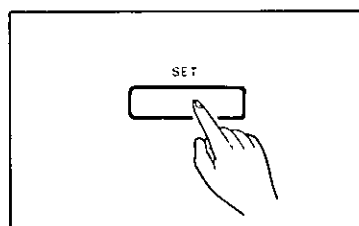

Press the SET button .

DELAYED XMT&POLL=OFF
[1.OFF 2.ON]

9

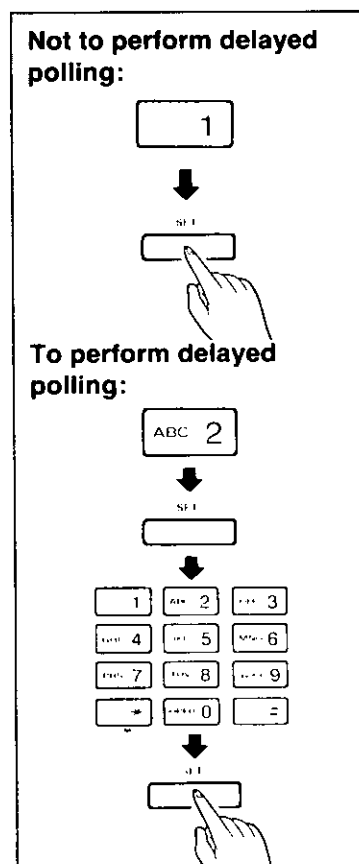

Select the desired mode.

If you do not want to perform delayed turnaround polling:

Press "1", then press the SET button.

SELECT AUTO OR
DIRECT CALL KEY

If you want to perform delayed turnaround polling:

1. Press "2", then press the SET button.

SET START TIME
12:00AM [*=AM #=PM]

2. Enter the desired starting time using the dial keypad.(Example: The start time is 11:00PM)

SET START TIME
11:00PM [*=AM #=PM]

3. Press the SET button.

SELECT AUTO OR
DIRECT CALL KEY

10

Press the MENU button to end the operation.

Calling with PRIORITY keys

MULTI XMT

1
2

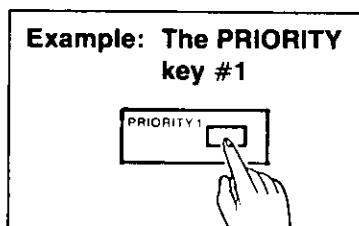

Insert the documents FACE DOWN.

Press the desired PRIORITY key.

The unit will scan the documents into memory and then transmit.

DIALING <MULTI XMT>
TO: PANASONIC

To cancel, press the STOP button.

SUN JAN 1 3:00PM 00
USER STOPPED

Delayed multi transmission:

When the programmed time comes, the unit starts transmission automatically.

SUN JAN 1 3:00PM 00
MULTI XMT AT 11:00PM

To cancel, press the STOP button, then press "1".

CANCEL DELAYED MULTI
XMT? [1.YES 2.NO]

If the line is busy the unit automatically redials the number up to 6 times within 10 minutes.

Delayed XMT

1
2

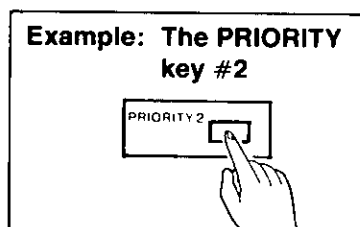

Insert the documents FACE DOWN.

Press the desired PRIORITY key.

When the programmed time comes, the unit starts transmitting automatically.

SUN JAN 1 3:00PM 00
XMT AT 11:00PM

To cancel, press the STOP button, then press "1".

CANCEL DELAYED
XMT? [1.YES 2.NO]

Note:

- Automatic and manual reception, transmission and copying functions can be used when delayed transmission is set. To copy another document, remove the documents from the tray and replace them when you have finished.

Polling

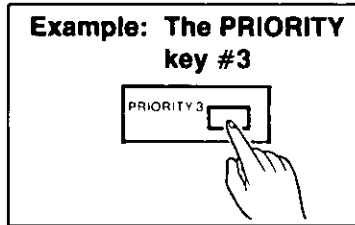

Press the desired PRIORITY key.

The unit starts polling.

```
DIALING <POLL>
TO: PANASONIC
```

To cancel, press the STOP button.

```
SUN JAN 1 3:00PM 00
USER STOPPED
```

Delayed polling:

When the programmed time comes, the unit starts polling automatically.

```
SUN JAN 1 3:00PM 00
POLLING AT 11:00PM
```

To cancel, press the STOP button, then press "1".

```
CANCEL DELAYED
POLLING?[1.YES 2.NO]
```

XMT&POLL

1
2

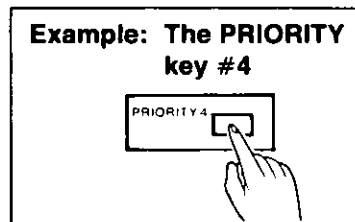

Insert the documents FACE DOWN.

Press the desired PRIORITY key.

The unit starts turnaround polling

```
DIALING <XMT&POLL>
TO: PANASONIC
```

To cancel, press the STOP button.

```
SUN JAN 1 3:00PM 00
USER STOPPED
```

Delayed turnaround polling:

When the programmed time comes, the unit starts turnaround polling automatically.

```
SUN JAN 1 3:00PM 00
XMT&POLL AT 11:00PM
```

To cancel, press the STOP button, then press "1".

```
CANCEL DELAYED XMT&
POLL?[1.YES 2.NO]
```

Confidential communications

This feature is a simple way to ensure that confidential information reaches the right person without anyone else seeing it. When you send a normal fax, it is printed out immediately by the receiving machine and anyone standing near the machine might see the fax message. When the confidential communication feature is used, however, the fax message is stored in the machine's internal memory instead of automatically printing and is printed only when the correct password is entered.

Entering a unique 4-digit password is required to activate this feature. Issue your password to the correct person with priority status.

This unit can only send confidential information to Panasonic compatible machines that have a confidential receiving feature. The unit cannot receive confidential information.

1

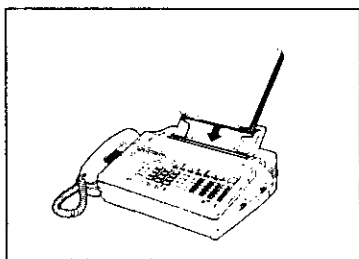

Insert the documents FACE DOWN.

2

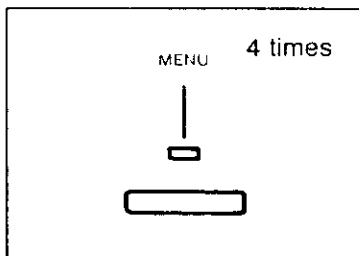

Press the MENU button 4 times.

CONFIDENTIAL
ENTER PHONE NUMBER

3

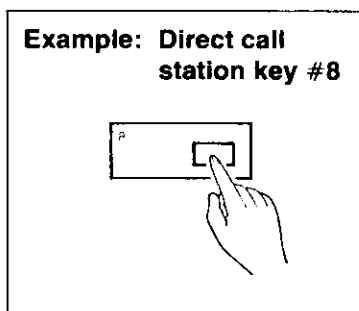

Enter the phone number using the direct call station key, the speed dial station or a full number. (Example: Direct call station 8 is dialed.)

ENTER PHONE NUMBER
=<S08>

4

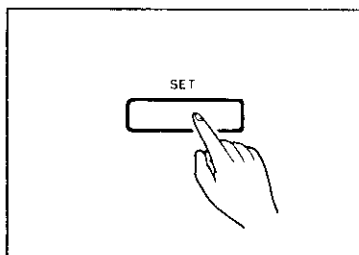

Press the SET button.

CONFIDENTIAL XMT
PASSWORD=0000

5

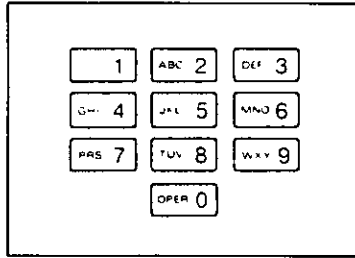

Enter the desired 4-digit password using the dial keypad.

(Example: The password is 1234.)

CONFIDENTIAL XMT
PASSWORD=1234

6

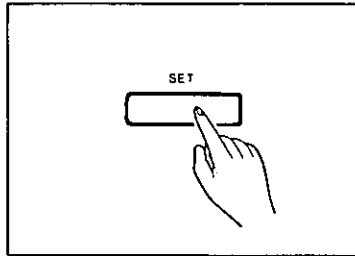

Press the SET button.

PRESS
[START/COPY] KEY

7

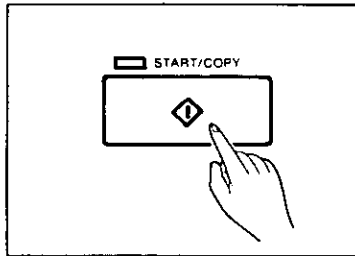

Press the START/COPY button.

The unit initiates dialing and transmission.

Note:

- If there is no answer or the line is busy, the unit redials the number up to 6 times automatically. To stop automatic redialing, press the STOP button.

Network communication

The network communication function with network passcode can eliminate fax transmission to unauthorized parties, and help to prevent reception from an unauthorized station.

This feature is effective to prevent "Junk mail" faxes since only those units with the same passcode can transmit to your unit.

When the network communication function is used, the identical network passcode of 4 digits must be programmed on both sides of the line. The unit checks the passcode before transmitting or receiving a document.

The unit provides two types of passcode check modes. They are TX (transmission) passcode check mode and RX (receiving) passcode check mode.

TX Passcode Check:

This function can be used when you wish to transmit a document only to authorized stations. If the passcode sent from the other Panasonic compatible machines does not match with the one programmed in your unit, transmission does not take place. (See page 3-36 for TX PASSCODE CHECK setting.)

RX Passcode Check:

This function can be used when you wish to receive a document only from an authorized station. If the passcode sent from the other Panasonic compatible machines does not match with the one programmed in your unit, reception does not take place. (See page 3-36 for RX PASSCODE CHECK setting.)

This feature is effective only between Panasonic compatible machines that have the same passcode.

Note:

The password for the polling function is not related to this network communication. They are independent functions.

Using a passcode

Before communication commences, check that your passcode and the other station's passcode are identical and that you set "SEND PASSCODE" to ON.

- **When you want to transmit a document to a designated station only (TX passcode check mode):**

Set "TX PASSCODE CHECK" to ON. (See Table 1 below.)

Function	Your unit	Other Panasonic compatible machines
SEND PASSCODE	ON	ON
TX PASSCODE CHECK	ON	ON/OFF
RX PASSCODE CHECK	OFF	ON/OFF

Table 1

SUN JAN 1 3:00PM 00
TX PASSCODE CHECK ON

Your unit transmits a document only when the correct passcode has been received.

- **When you want to receive a document from a designated station only (RX passcode check mode):**

Set "RX PASSCODE CHECK" to ON. (See Table 2 below.)

Function	Your unit	Other Panasonic compatible machines
SEND PASSCODE	ON	ON
TX PASSCODE CHECK	OFF	ON/OFF
RX PASSCODE CHECK	ON	ON/OFF

Table 2

SUN JAN 1 3:00PM 00
RX PASSCODE CHECK ON

Your unit receives a document only when the correct passcode has been received.

- When you want to send a document to and receive a document from a designated station.

(TX passcode check and RX passcode check mode):

Set both "TX PASSCODE CHECK" and "RX PASSCODE CHECK" to ON. (See Table 3 below.)

Function	Your unit	Other Panasonic compatible machines
SEND PASSCODE	ON	ON
TX PASSCODE CHECK	ON	ON/OFF
RX PASSCODE CHECK	ON	ON/OFF

Table 3



Your unit transmits and receives a document only when the correct passcode has been received.

- When you want to have facsimile communications within a designated group of people.

All the people in the group must set both "TX PASSCODE CHECK" and "RX PASSCODE CHECK" to ON. (See Table 4 below.)

Function	Your unit	Other Panasonic compatible machines
SEND PASSCODE	ON	ON
TX PASSCODE CHECK	ON	ON
RX PASSCODE CHECK	ON	ON

Table 4



Only people who share the identical passcode can transmit and receive documents with each other.

Programming for network communication

1

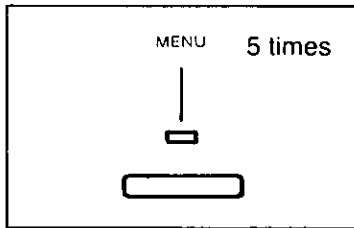

Press the MENU button 5 times.

PROGRAM[1.DATE 2.TEL
3.SYSTEM 4.REPORT]

Programming network passcode:

2

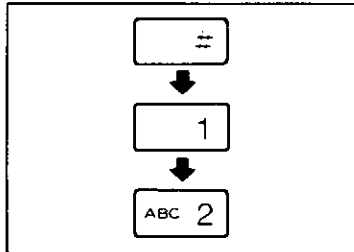

Press "#", then press "12" for the NETWORK PASSCODE setting.

12.NETWORK PASSCODE
=0000

3

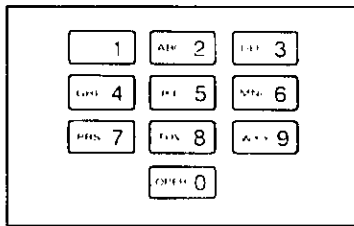

Enter the desired passcode of 4 digits using the dial keypad.

You can choose among numbers "0001" through "9999" as the network passcode.

To correct an error while programming, press the CLEAR button then correct input.

4

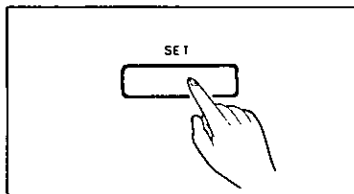

Press the SET button to store the program into memory.

PROGRAM[1.DATE 2.TEL
3.SYSTEM 4.REPORT]

Setting the send passcode to on:

5

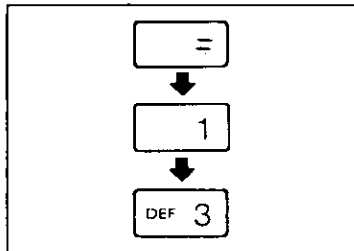

Press "#", then press "13" for the SEND PASSCODE setting.

13.SEND PASSCODE
=OFF [1.OFF 2.ON]

6

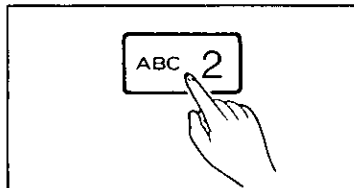

Press "2".

14.SEND PASSCODE
=ON [1.OFF 2.ON]

7

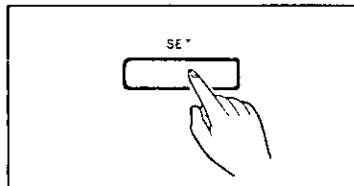

Press the SET button to store your selection into memory.

PROGRAM[1.DATE 2.TEL
3.SYSTEM 4.REPORT]

Turning the TX passcode check on:

8

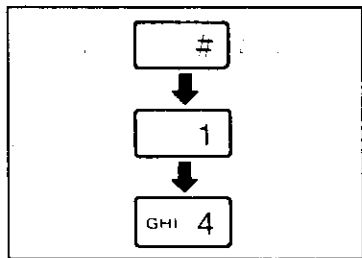

Press "#", then press "14" for the TX PASSCODE CHECK setting.

14.TX PASSCODE CHECK
=OFF [1.OFF 2.ON]

9

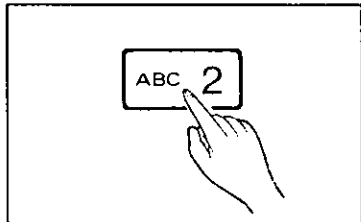

Press "2" to activate this function.

14.TX PASSCODE CHECK
=ON [1.OFF 2.ON]

10

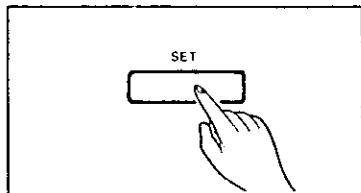

Press the SET button to store your selection into memory.

PROGRAM[1.DATE 2.TEL
3.SYSTEM 4.REPORT]

Turning the RX passcode check on:

11

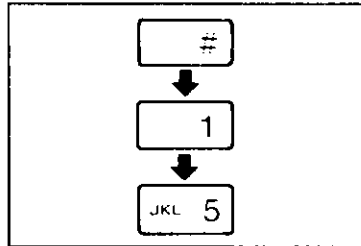

Press "#", then press "15" for the TX PASSCODE CHECK setting.

15.RX PASSCODE CHECK
=OFF [1.OFF 2.ON]

12

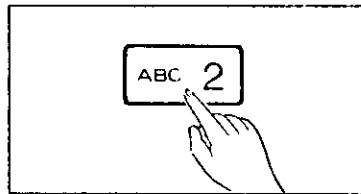

Press "2" to activate this function.

15.RX PASSCODE CHECK
=ON [1.OFF 2.ON]

13

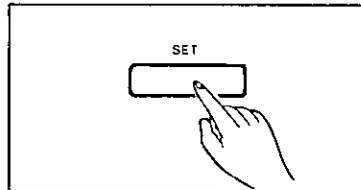

Press the SET button to store your selection into memory.

PROGRAM[1.DATE 2.TEL
3.SYSTEM 4.REPORT]

14

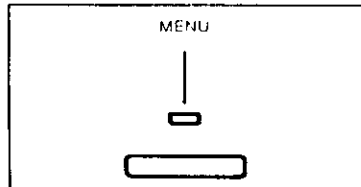

Press the MENU button to end the operation.

Using network communication

Network communication is activated with the MAIN PASSCODE. You can change the passcode temporarily or cancel the passcode temporarily by using the TRANSMIT SETTING button. This is useful when you need to transmit a document to a station with a different passcode or no passcode programmed.

Before using this feature, make sure that "SEND PASSCODE" or "TX PASSCODE CHECK" is set to ON.

Before performing transmitting operation, perform the following steps.

1

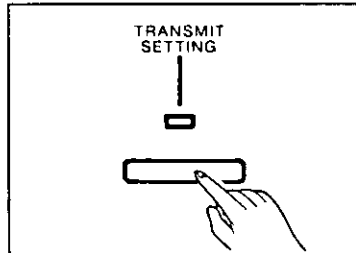

Press the TRANSMIT SETTING button.

PASSCODE=MAIN[*=MAIN
#=NONE OR 4 DIGITS]

2

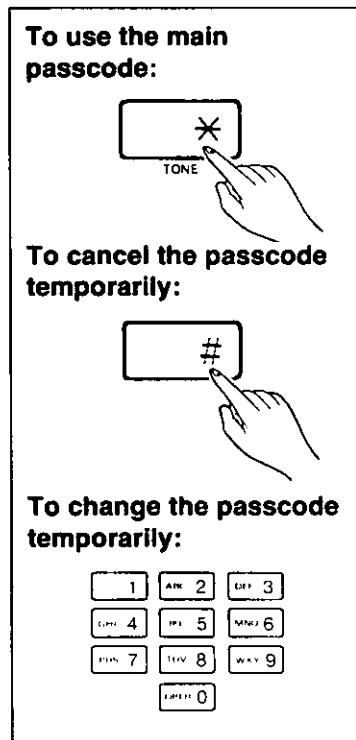

Select the desired mode.

Press "*" to send the main passcode (programmed passcode).

PASSCODE=MAIN[*=MAIN
#=NONE OR 4 DIGITS]

Press "#" to cancel the passcode.

PASSCODE=NONE[*=MAIN
#=NONE OR 4 DIGITS]

If you need to send a different passcode, enter the numbers using the dial keypad. (Example: The passcode is 5678.)

PASSCODE=5678[*=MAIN
#=NONE OR 4 DIGITS]

3

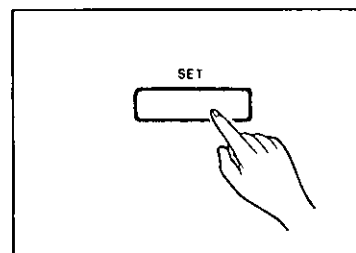

Press the SET button.

SET NUMBERS OF PAGES
TOTAL=0

4

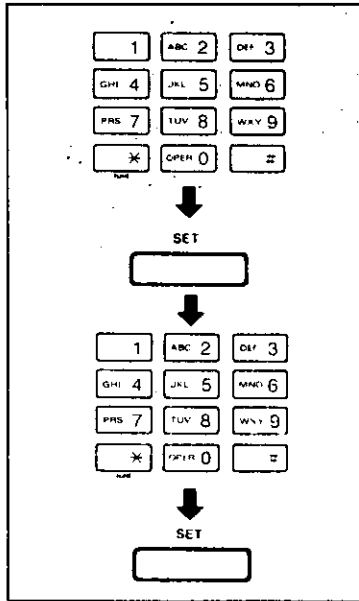

Enter the number of pages transmitted if you need, then press the SET button. (Refer to page 2-8.)

MESSAGE OUT=OFF
[1.OFF 2.A 3.B 4.C]

Press "1", "2", "3" or "4" to select the desired message, then press the SET button. (Refer to page 2-8.)

5

Perform a transmitting operation.

Setting the REMOTE FAX ID

The REMOTE FAX ID feature is designed to prevent unauthorized persons accessing your unit from a remote location. We recommend that you use a number that is different from your REMOTE TAD ID (page 3-42), to prevent accessing the answering machine. This feature is available only when transmitting using facsimile with a touch-tone phone.

The REMOTE FAX ID can be any number within the following ranges:

1 digit: 1 to 9 2 digits: 10 to 99
3 digits: 100 to 999 4 digits: 1000 to 9999

To set the REMOTE FAX ID:

1

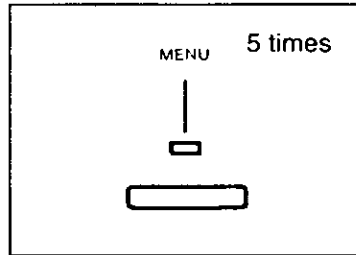

Press the MENU button 5 times.

PROGRAM[1.DATE 2.TEL
3.SYSTEM 4.REPORT]

2

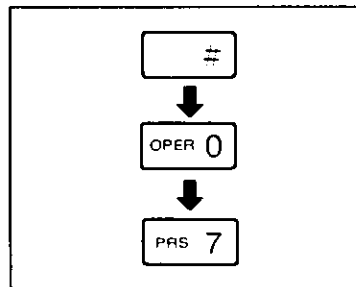

Press "#", then press "07".

7.REMOTE FAX ID=OFF
[1.OFF 2.ON]

3

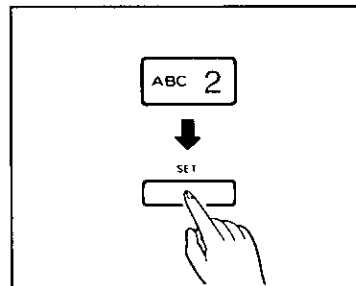

press "2", then press the SET button to set to ON.

ENTER YOUR REMOTE
FAX ID=2222

4

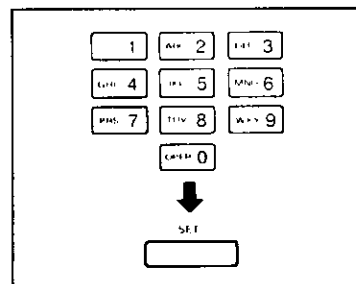

Enter the desired REMOTE FAX ID, then press the SET button.

(Example: The ID is 5678.)

ENTER YOUR REMOTE
FAX ID=5678

PROGRAM[1.DATE 2.TEL
3.SYSTEM 4.REPORT]

5

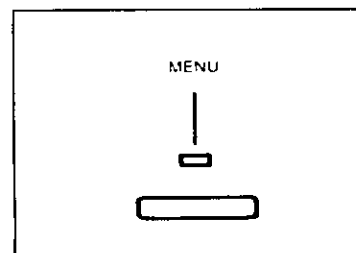

Press the MENU button to end the operation.

Transmitting a document with REMOTE FAX ID to your unit from a remote location

When your unit is in the TAD/FAX mode:

1

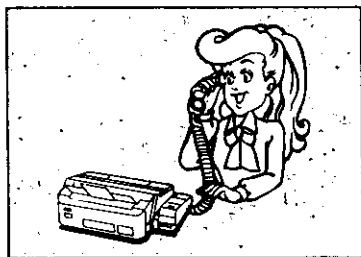

A caller may call your unit.

2

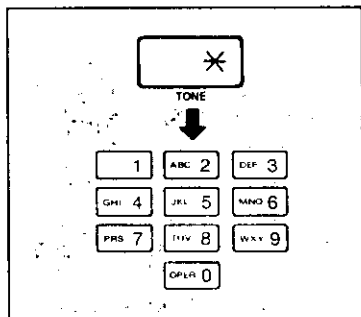

Press "*" while the OGM is playing.

Enter the REMOTE FAX ID when the long beep is heard.

3

Start transmission upon hearing the fax tone.

When your unit is in the FAX mode:

1

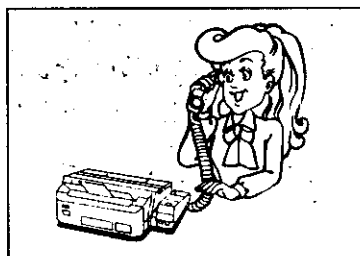

A caller may call your unit.

2

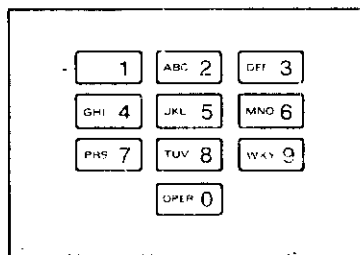

Enter the REMOTE FAX ID when the long beep is heard.

3

Start transmission upon hearing the fax tone.

Operating as an answering device from a remote phone

You can retrieve the incoming messages and re-record your outgoing message from a remote location with a touch tone telephone.

The following features are available on this unit.

- Message playback
- Newly recorded messages playback (Memory playback)
- Back space and skip forward
- Recording a marker message
- Resetting the tape for future messages
- Room monitor
- Re-recording the OGM (outgoing message)
- Skipping the OGM for ICM (incoming message) recording

These operations are available only in the TAD/FAX mode. If your unit is in the TEL mode, call your unit and wait for 15 rings. The unit will switch to the TAD/FAX mode.

Toll saver

When you call the unit from a remote location, the number of rings tells you if there are any new voice-messages.

If the unit answers on the 1st ring, there is at least one new message recorded.

If the unit answers on the 3rd ring, there are no new messages recorded.

Hang up immediately when you hear the 2nd ring. The 2nd ring indicates that there are no new messages. This will save you the toll charge for the call.

The toll saver function works only when TAD/FAX RING COUNT is set to the Toll Saver position. See page 5-6.

Summary of remote control functions

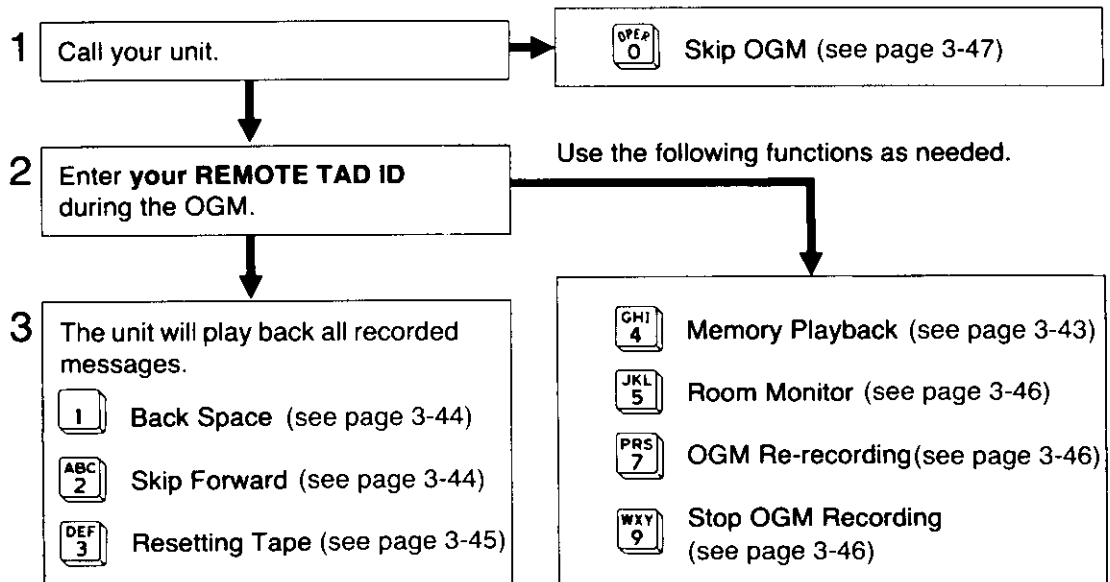

Programming a REMOTE TAD ID number for remote operation

The REMOTE TAD ID number prevents unauthorized persons from accessing your unit and listening to your messages. The REMOTE TAD ID is preset to 111. If you wish to change the number, you can choose any number of 3 digits except numbers including "0". You should also use a number that is different from the PRIVACY RING ID.

1

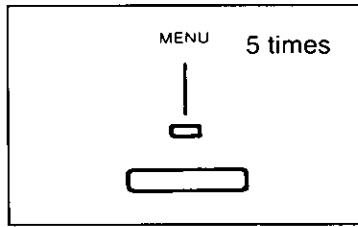

Press the MENU button 5 times.

PROGRAM[1.DATE 2.TEL
3.SYSTEM 4.REPORT]

2

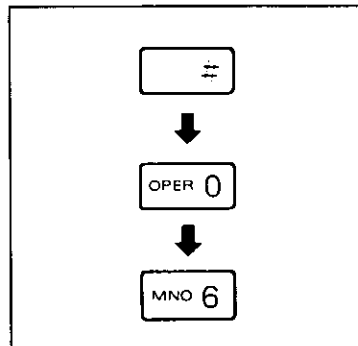

Press "#", then press "06" for the REMOTE TAD ID setting.

6.ENTER YOUR REMOTE
TAD ID=111

3

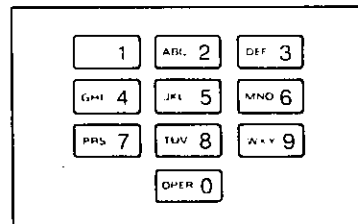

Enter the desired number for the REMOTE TAD ID using the dial keypad.

To correct an error while programming, press the CLEAR button then correct input.

4

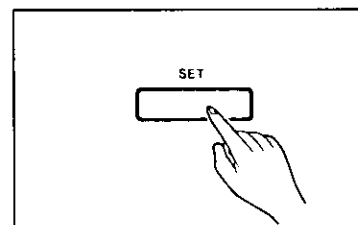

Press the SET button to store the program into memory.

PROGRAM[1.DATE 2.TEL
3.SYSTEM 4.REPORT]

5

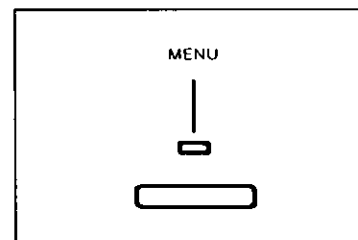

Press the MENU button to end the operation.

Note:

- We recommend that you do not use seven (7) as a code number, since this number is used as the OGM re-recording command for remote operations.

Message playback

You can listen to the recorded messages from a remote location.

1

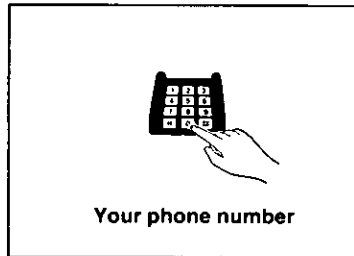

Call your unit.

2

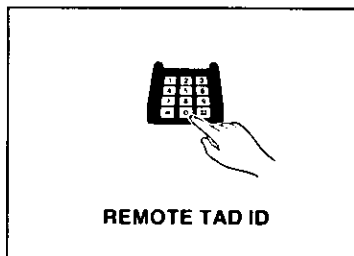

Dial your REMOTE TAD ID while the OGM is playing.

A long beep and a short beep(s) will sound. Short beep(s) indicate(s) the number of recorded message(s) up to 8 times. Even if 9 or more calls are recorded, a short beep sounds 8 times.

3

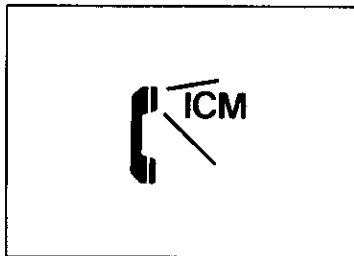

The unit rewinds the tape and plays back the message(s) recorded.

3 beeps will be heard indicating the end of the messages. After hanging up, all the recorded messages are saved and the unit is ready to record further messages.

Newly recorded messages playback (Memory playback)

It is possible to skip over the recorded messages you have already heard and to play back only new messages.

1

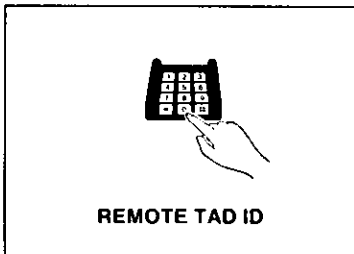

Call your unit, then dial your REMOTE TAD ID while the OGM is playing.

2

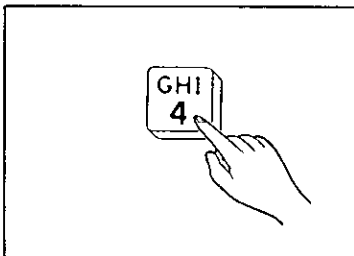

Press "4" immediately after hearing the beeps that indicate the number of recorded messages.

The unit plays back the new messages. Even during the playback of previously heard messages, you can skip them by pressing "4".

Back space and skip forward

While listening to the recorded messages, you can rewind or forward the tape.

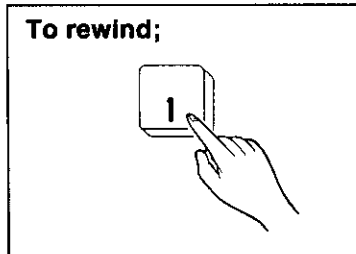

To rewind, press "1".

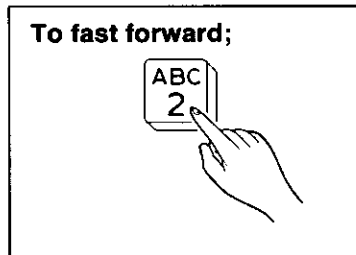

To fast forward, press "2".

Note:

- The maximum length of a message to be rewound or forwarded by one press is approximately 15 seconds. So you may have to press "1" or "2" several times to rewind or forward the tape to the desired position.

Recording a marker message

After playing back the recorded messages, you can leave an additional message on the same call. When replay is finished, wait for 3 beeps indicating the end of the last message. Then wait about 10 seconds for another 2 beeps indicating that the tape is ready for recording.

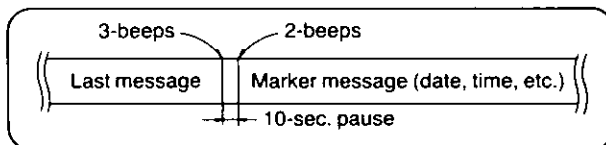

Leave your message after the last 2 beeps.

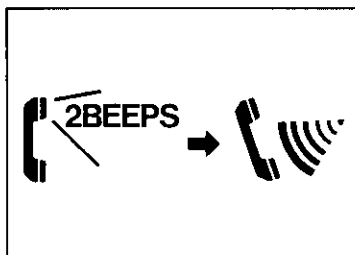

Hang up when finished. The marker message is recorded after the last message on the tape.

Resetting the tape for future messages

After listening to the recorded messages, you can reset the tape and record future messages from the beginning of the tape.

After all the messages have been played back or even while they are being played;

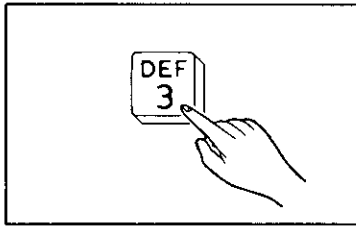

Press "3", then hang up.

The unit rewinds the tape to the beginning. Future messages will be recorded and the previously recorded messages are lost.

If you have used Memory Playback;

1

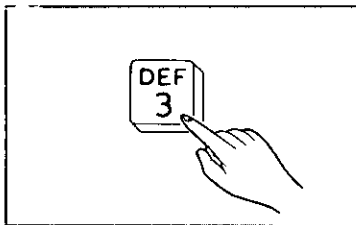

Press "3".

The unit rewinds the tape to the beginning of the newly recorded messages, then beeps.

2

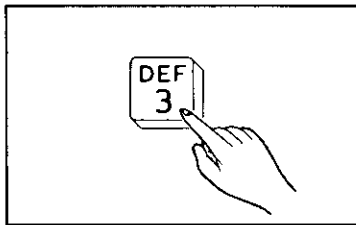

Press "3" again after hearing the beep.

The unit rewinds the tape to the beginning of the previously recorded messages.

If you have reset the tape by mistake;

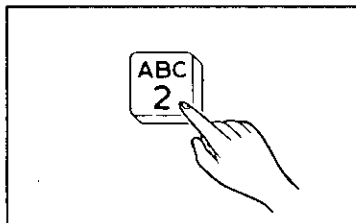

Press "2" after the tape has been reset.

One beep sounds.

The unit advances the tape to the end of the recorded messages.

Room monitor

You can monitor the sound in the room where the unit is installed for about 30 seconds.

1

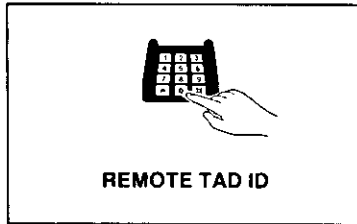

Call your unit, then dial your REMOTE TAD ID while the OGM is playing.

2

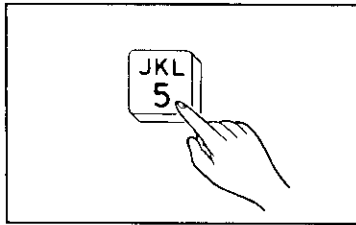

Press "5" to monitor the room sounds after hearing the beeps that indicate the number of recorded messages. You can hear the room sounds for 30 seconds after one beep. If you wish to continue monitoring, press "5" again within 10 seconds after hearing one beep.

Re-recording an outgoing message

You can change the content of your OGM from a remote telephone.

1

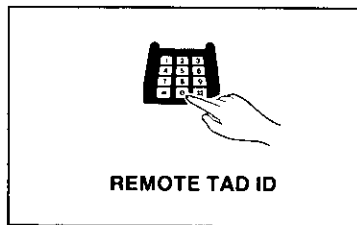

Call your unit, then dial your REMOTE TAD ID while the OGM is playing.

2

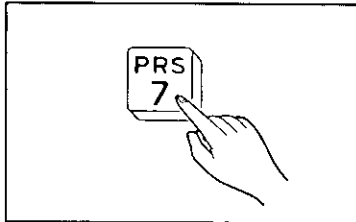

Press "7" to start re-recording after hearing the beeps that indicate the number of recorded messages.

3

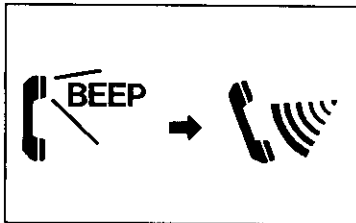

After hearing a long beep, speak clearly and loudly for up to 16 seconds.

4

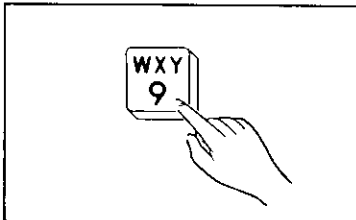

When you finish, press "9".

The new OGM is played to confirm the change.

Note:

- If you pause for over 2 seconds while recording, the unit beeps and stops the OGM recording. In this case, repeat from step 1 within 10 seconds.

Skipping the OGM for ICM recording

Callers can leave a message on your unit without listening to your OGM.

Instructions for caller:

Call your unit.

1

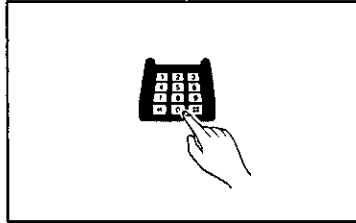

2

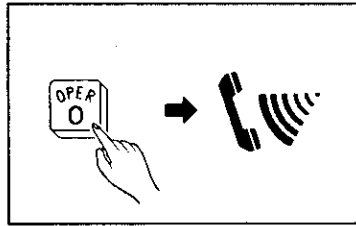

Press "0" while the OGM is playing.

After hearing a long beep, speak clearly and loudly to leave a message.

Call with privacy ring

This feature eliminates interruptions caused by unwanted calls. Only callers with a passcode can activate a distinctive tone during the playing of your OGM to notify you of a priority call. This feature only works when your unit is in the TAD/FAX mode.

Entering a unique 3-digit code is required to activate this feature. Issue your code to those callers with priority status. All other calls will be routed to the answering system, unless you pick up the handset.

The unit provides PRIVACY RING ID "333" as default setting. If you want to change the number, you can choose any number of 3 digits except numbers including "0". You should also use a number that is different from the REMOTE TAD ID.

Programming the PRIVACY RING ID

1

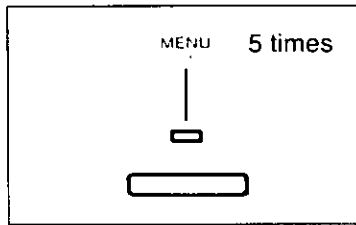

Press the MENU button 5 times.

PROGRAM[1.DATE 2.TEL
3.SYSTEM 4.REPORT]

2

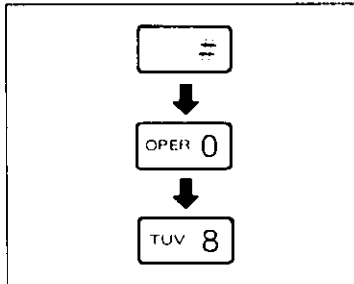

Press the "#", then press "08" for the PRIVACY RING ID setting.

8.PRIVACY RING ID
=333

3

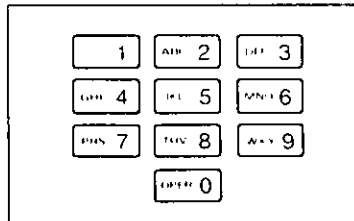

Enter the desired 3-digit number as the new PRIVACY RING ID using the dial keypad.

To correct an error while programming, press the CLEAR button then correct input.

4

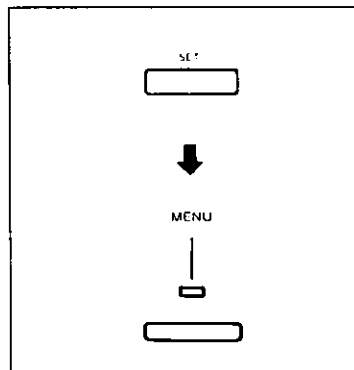

Press the SET button to store the program into memory.

PROGRAM[1.DATE 2.TEL
3.SYSTEM 4.REPORT]

Press the MENU button to end the operation.

Note:

- We recommend that you do not use seven (7) as a code number, since this number is used as the OGM re-recording command for remote operations.

Calling with the privacy ring code

1

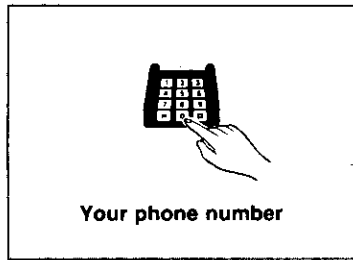

Call the unit with a touch tone telephone.

2



Enter the PRIVACY RING ID during the OGM or the ICM recording mode.

The unit rings with a distinctive tone for 30 seconds and goes into the ICM recording mode if nobody answers.

To repeat this process, press the ID number again during the ICM recording mode.

Setting the auto receive timer

This feature allows you to set the unit in the auto receiving mode (TAD/FAX or FAX) for the desired time automatically. For example, you may wish to use the unit in the TEL mode during the work days and switch to the TAD/FAX or FAX mode during the evenings. The TAD/FAX or FAX mode is automatically turned ON or OFF at the preprogrammed time. To activate this function, use AUTO RECEIVE TIMER in the programming functions.

1

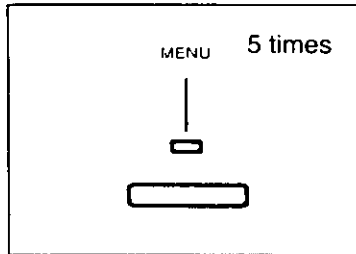

Press the MENU button 5 times.

PROGRAM[1.DATE 2.TEL
3.SYSTEM 4.REPORT]

2

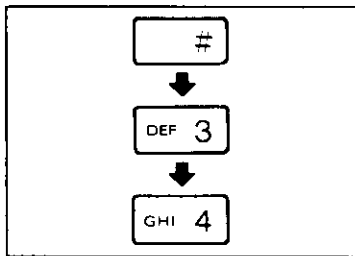

Press "#", then press "34" for the AUTO RECEIVE TIMER setting.

34.AUTO RCV TIMER
=OFF [1.OFF 2.ON]

3

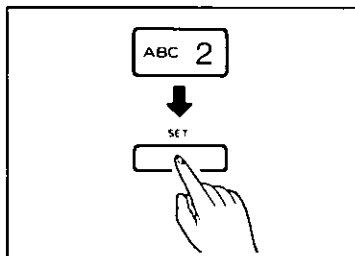

Press "2" to turn the auto receive timer on, then press the SET button.

AUTO RCV ON TIME
12:00AM [*=AM #=PM]

4

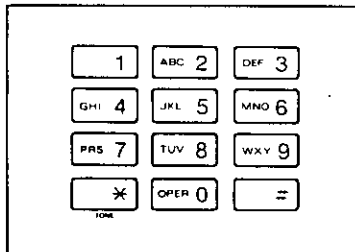

Enter the ON time by entering 4 digits.

Example: If the ON time is 5:00PM, press "0 5 0 0", then press "#" to select PM.

AUTO RCV ON TIME
05:00PM [*=AM #=PM]

To correct an error while programming, press the CLEAR button then correct input.

5

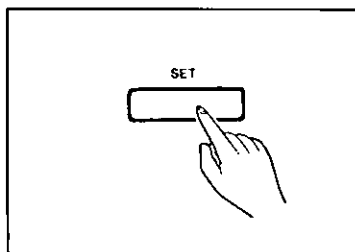

Press the SET button.

AUTO RCV=TAD/FAX
[1.TAD/FAX 2.FAX]

Please continue to the next page.

6

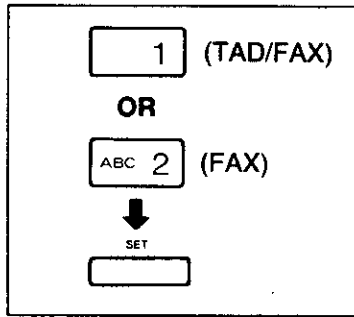

Press "1" or "2" to select the desired auto receiving mode, then press the SET button.

AUTO RCV OFF TIME
12:00AM [*=AM #=PM]

7

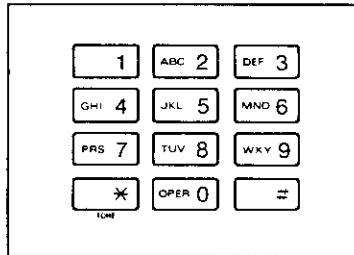

Enter the OFF time by entering 4 digits.

Example: If the OFF time is 9:00AM, press "0 9 0 0", then press "*" to select AM.

AUTO RCV OFF TIME
09:00AM [*=AM #=PM]

To correct an error while programming, press the CLEAR button, then correct input.

8

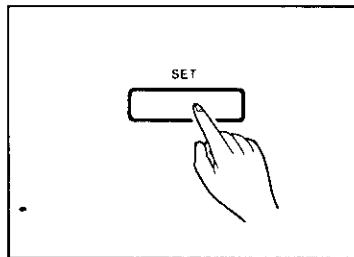

Press the SET button.

RCV MODE
[1.TEL 2.FAX]

9

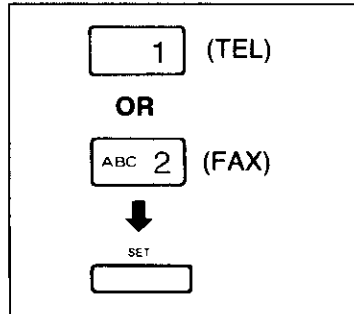

Press "1" or "2" to select the desired receiving mode after the auto receiving mode is turned off, then press the SET button.

PROGRAM[1.DATE 2.TEL
3.SYSTEM 4.REPORT]

10

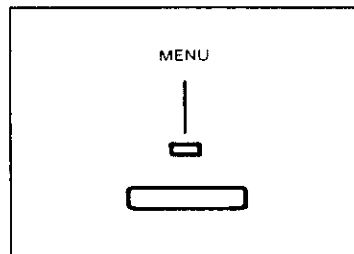

Press the MENU button to end the operation.

Advanced dialing features

TONE button (Temporary tone dialing)

This function is useful only when your line has a rotary pulse dial service. Pressing the TONE (*) button will allow you to change from pulse to tone mode during a dialing operation, and enter special tones and codes to operate the answering device, electronic banking services and other special services.

"TONE" can be programmed into memory with the telephone numbers.

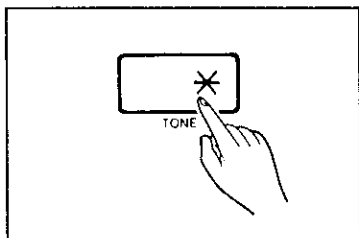

Press the TONE (*) button.

When you hang up, the unit automatically returns to pulse mode.

"TONE" can be stored into memory the same way as explained on pages 1-24 to 1-30.

Pressing the TONE button counts as 1 digit while programming.

FLASH button

The FLASH button is used to access special telephone services such as a call waiting and call forwarding.

For further details, please see a brochure issued by your telephone company.

Using the FLASH button:

(Example: Call waiting service)

1. If another party calls while you are hearing a conversation, you hear a tone.
2. Press the FLASH button.
The first conversation is placed on hold and you can answer the second call.
To speak to the first caller again, press the FLASH button again. The second caller is placed on hold.

- "FLASH" can be stored into memory the same way as explained on pages 1-24 to 1-30.
- Pressing the FLASH button counts as 1 digit while programming.

PAUSE button

The PAUSE button is used in a dial sequence to access an outside line. Pressing the PAUSE button makes a dialing delay.

Using the PAUSE button:

Example: Line access number 9

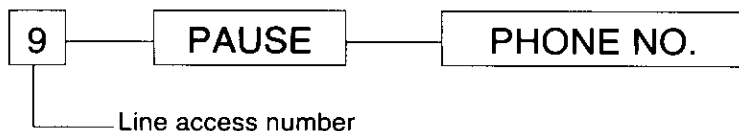

- "PAUSE" can be stored into memory the same way as explained on pages 1-24 to 1-30.
- Pressing the PAUSE button counts as 1 digit while programming.

Combination dialing

The following combination of dialing methods can be used.

- Manual dialing and automatic dialing
- Pulse and Tone dialing
- Plural memory stations

Printing Reports and Lists

Activity report (JOURNAL report)

You can obtain a record of the last 30 transactions (transmissions and receptions) automatically or manually. When the JOURNAL AUTO PRINT of the programming functions is set to "AUTO", the report will be printed automatically after every 30 transactions. After each 30 transactions, the report is cleared and the list begins again. It may also be printed on request.

This function has been preset to AUTO as the default.

These reports are useful for keeping records of telephone usage or verifying telephone long distance charges.

Print time: Hour:Minute AM/PM
 Print date: Month/Date/Year

Communication number (up to 30)

```

***** JOURNAL *****
*                                     JAN. 1. 1990  3:36AM
*
+-----+-----+-----+-----+-----+-----+-----+
+ No.   OTHER FACSIMILE   START TIME   USAGE TIME   TX PAGES   RX PAGES   RESULT
+-----+-----+-----+-----+-----+-----+-----+
+ 01    Panasonic A      JAN. 1  1:11AM  00'42      00        01    OK
+ 02    Panasonic A      JAN. 1  1:16AM  00'57      02        00    OK
+ 03    Panasonic A      JAN. 1  1:24AM  01'17      03        00    OK
+ 04    Panasonic B      JAN. 1  1:39AM  01'03      02        00    OK
+ 05    Panasonic C      JAN. 1  1:43AM  00'46      00        01    OK
+ 06    Panasonic C      JAN. 1  1:45AM  00'39      00        01    OK
+ 07    Panasonic B      JAN. 1  1:46AM  01'32      01        00    OK
+ 08    <A00>              JAN. 1  1:56AM  00'41      00        00    NG(04)
+ 09    <A00>              JAN. 1  1:57AM  01'01      01        00    OK
+ 10    123 4567          JAN. 1  1:59AM  01'11      00        02    OK
+ 11    Panasonic B      JAN. 1  2:07AM  00'35      01        00    OK
+ 12    111 2233          JAN. 1  2:08AM  00'40      01        00    OK
+ 13    123 4567          JAN. 1  2:15AM  01'50      02        00    OK
+ 14    111 2233          JAN. 1  2:17AM  01'41      03        00    OK
+ 15    <A00>              JAN. 1  2:19AM  01'15      02        00    OK
+ 16    123 4567          JAN. 1  2:20AM  00'52      01        00    OK
+ 17    123 4567          JAN. 1  2:21AM  01'11      00        02    OK
+ 18    Panasonic A      JAN. 1  2:51AM  01'28      03        00    OK
+ 19    Panasonic C      JAN. 1  2:55AM  01'06      00        02    NG(06)
+ 20    Panasonic C      JAN. 1  2:59AM  01'32      00        03    OK
+ 21    Panasonic A      JAN. 1  3:07AM  00'48      00        01    OK
+ 22    Panasonic B      JAN. 1  3:08AM  00'45      00        01    OK
+ 23    Panasonic C      JAN. 1  3:09AM  00'47      00        01    OK
+ 24    Panasonic A      JAN. 1  3:19AM  00'57      02        00    OK
+ 25    Panasonic B      JAN. 1  3:21AM  00'55      02        00    OK
+ 26    Panasonic C      JAN. 1  3:22AM  01'00      02        00    OK
+-----+-----+-----+-----+-----+-----+-----+
  
```

Number of pages transmitted successfully

Number of pages received successfully

Length of communication: Minutes' Seconds

Communication result: OK ... Successful communication
 Numeral following NG ... Error code

Dialed number or other party's name

Communication start time

Setting JOURNAL AUTO PRINT

When you set this mode to AUTO, the JOURNAL report is printed automatically when memory becomes full (after 30 transactions). The JOURNAL memory is then cleared. When you set this mode to MANUAL, the JOURNAL report data is stored until the memory becomes full. Once the memory is full, the oldest entry in the memory is deleted when a new transaction takes place.

1

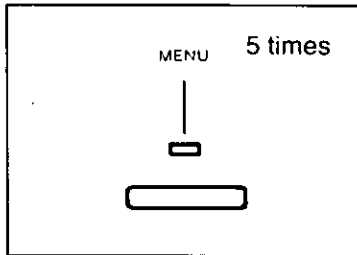

Press the MENU button 5 times.

PROGRAM[1.DATE 2.TEL
3.SYSTEM 4.REPORT]

2

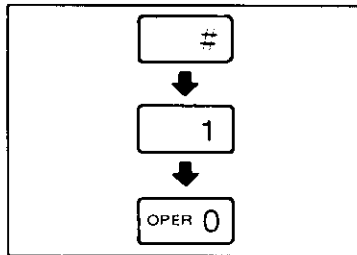

Press "#", then press "10" for JOURNAL AUTO PRINT setting.

10.JOURNAL=AUTO
[1.AUTO 2.MANUAL]

3

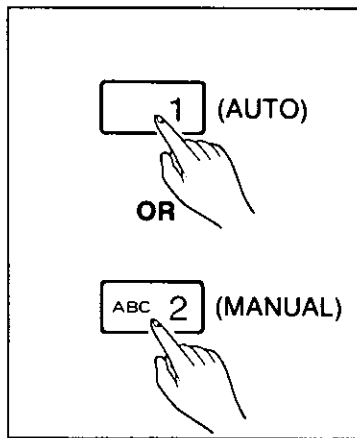

Press "1" or "2" to select the desired mode.

4

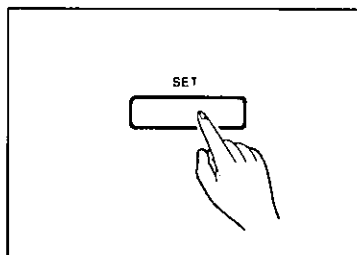

Press the SET button to store your selection into memory.

PROGRAM[1.DATE 2.TEL
3.SYSTEM 4.REPORT]

5

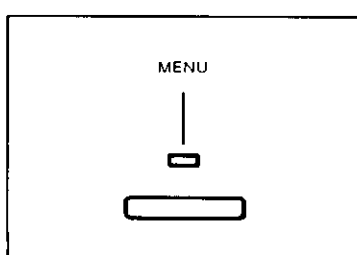

Press the MENU button to end the operation.

Printing JOURNAL report manually

You can print a report of the current JOURNAL upon request. This will not clear the report which will continue until 30 transactions are completed.

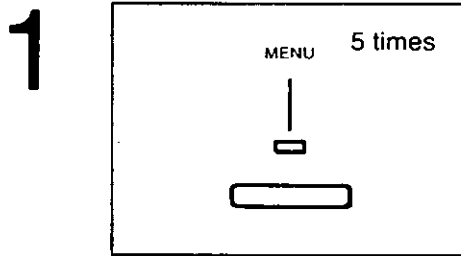

Press the MENU button 5 times.

```
PROGRAM[1.DATE 2.TEL  
3.SYSTEM 4.REPORT]
```

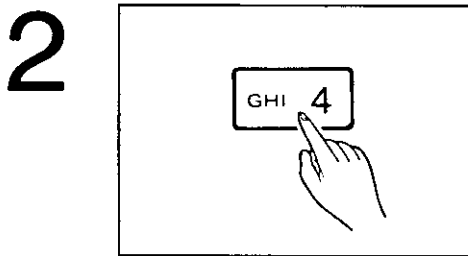

Press "4".

```
SELECT NO.[1.SYSTEM  
2.TEL NO. 3.JOURNAL]
```

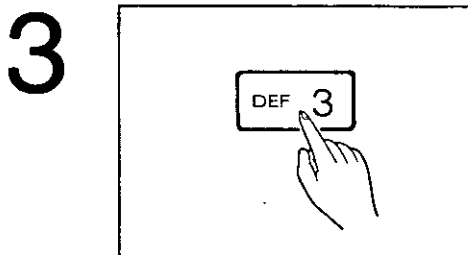

Press "3".

The unit starts printing.
If there have been no transactions, no JOURNAL will be printed.

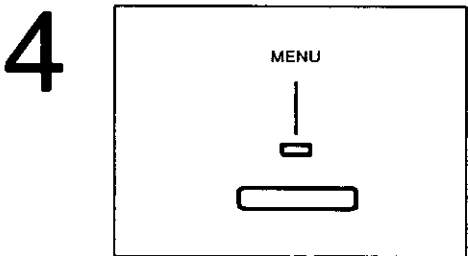

Press the MENU button to end the operation.

Individual transmission report (XMT REPORT)

Each time a document is transmitted, this function gives you a printed record of the transmission. This function has been preset to OFF as the default.

The following choices are available;

ON: The report is printed, indicating whether the transmission is successful or not.

ERROR: The report is printed only when transmission fails.

OFF: The report is not printed.

```
*****+ XMT REPORT *****
*
*
*  No.   OTHER FACSIMILE   START TIME   USAGE TIME   TX PAGES   RX PAGES   RESULT
*-----
*  01    Panasonic A      JAN. 1 5:08AM  00'38       01         00        OK
*
*
*
*
*
*
*
*
*
*
*****
```

Setting XMT REPORT

1

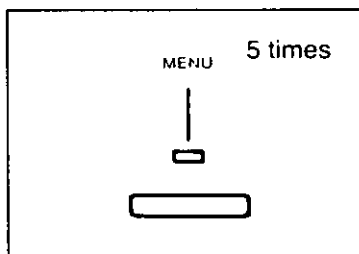

Press the MENU button 5 times.

PROGRAM[1.DATE 2.TEL
3.SYSTEM 4.REPORT]

2

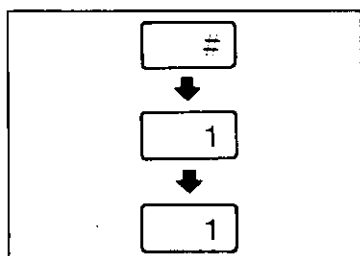

Press "#", then press "11" for PRINT XMT REPORT setting.

11.XMT REPORT=OFF
[1.OFF 2.ON 3.ERROR]

3

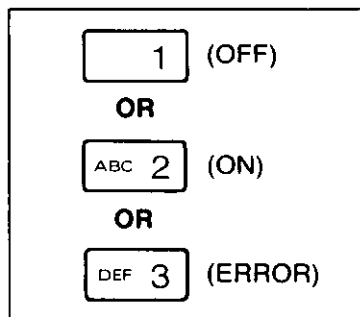

Press "1", "2" or "3" to select the desired mode.

4

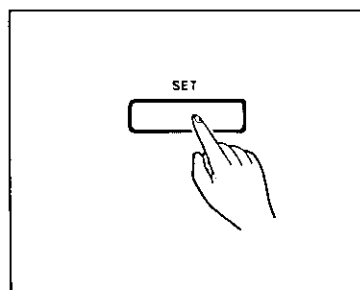

Press the SET button to store your selection into memory.

Press the MENU button to end the operation.

MULTI POLLING REPORT

When polling two or more units in one operation, the unit automatically prints a list of multi polling operations.

```
***** MULTI POLLING REPORT *****
*
*                                     JAN. 1. 1990  3:09AM
*
*-----*-----*-----*-----*-----*-----*-----*-----*-----*
*  NO.   KEY NO.   PHONE NO.   NAME           RX PAGES  RESULT
*-----*-----*-----*-----*-----*-----*-----*-----*
*  001   <506>    123-4567   SMITH           01        OK
*  002   <507>    144-4444   Panasonic C     01        OK
*  003   <508>    111-4444           01        OK
*-----*-----*-----*-----*-----*-----*-----*-----*
*****
```

MULTI TRANSMISSION REPORT

When transmitting a document to two or more units in one operation, the unit automatically prints a list of transmission operations.

```
***** MULTI TRANSMISSION REPORT *****
*
*                                     JAN. 1. 1990  3:23AM
*
*-----*-----*-----*-----*-----*-----*-----*-----*-----*
*  No.   OTHER FACSIMILE   START TIME   USAGE TIME   TX PAGES  RESULT
*-----*-----*-----*-----*-----*-----*-----*-----*
*  001   Panasonic A        JAN. 1  3:13AM  00'57       02        OK
*  002   Panasonic B        JAN. 1  3:21AM  00'55       02        OK
*  003   Panasonic C        JAN. 1  3:22AM  01'00       02        OK
*-----*-----*-----*-----*-----*-----*-----*-----*
*                                     TOTAL           02'52       06
*-----*-----*-----*-----*-----*-----*-----*-----*
*****
```

POWER DOWN REPORT

If a power failure takes place or the switch is turned off, the document information stored in the memory is lost and the power failure is printed out automatically after the power is turned on or the switch is on again.
The report is not printed out when there are no documents stored in the memory.

```
***** POWER DOWN REPORT *****
*
*                                     POWER DOWN AT:   JAN. 1. 1990  3:39 AM
*
*                                     RESTARTED AT:    JAN. 1. 1990  3:49 AM
*
*-----*-----*-----*-----*-----*-----*-----*-----*-----*
*  NO.   OTHER FACSIMILE   START TIME   TX PAGES  FUNCTION
*-----*-----*-----*-----*-----*-----*-----*-----*
*  01    <506>, <507>, <508>  3:39AM      02        DELAYED MULTI XMT
*-----*-----*-----*-----*-----*-----*-----*-----*
*
*                                     == ABOVE CONTENTS HAVE BEEN CLEARED DUE TO POWER DOWN ==
*-----*-----*-----*-----*-----*-----*-----*-----*
*****
```

Lists of stored phone numbers (TELEPHONE NUMBER LIST)

You can print a list of the numbers programmed for one touch dialing and speed dialing. Use this function to confirm that you have correctly stored phone numbers.

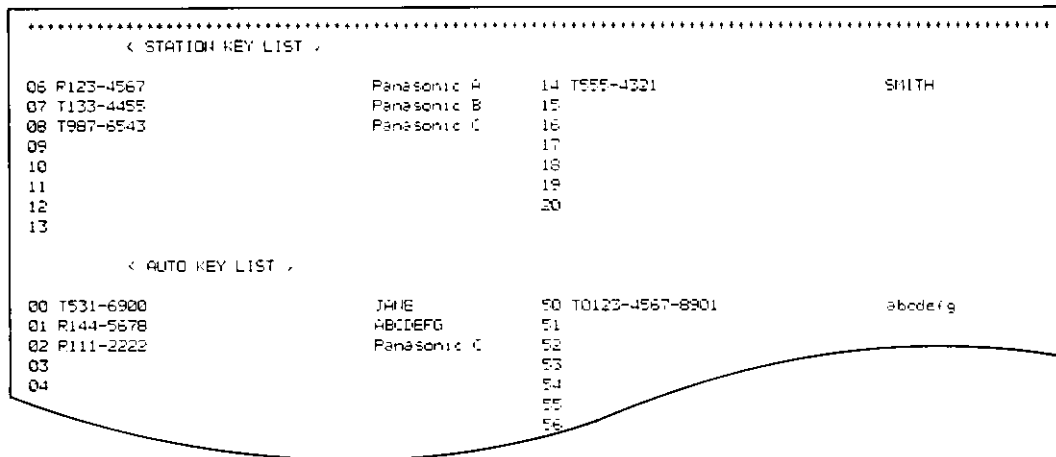
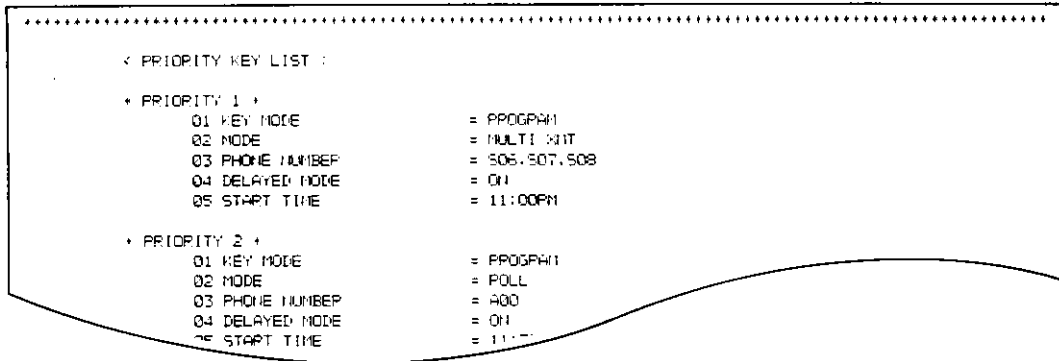

To obtain the TELEPHONE NUMBER LISTS:

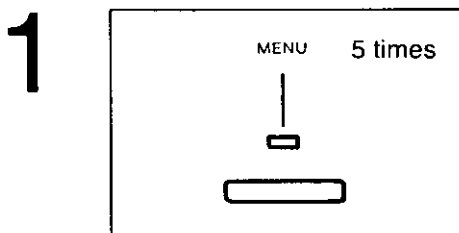

Press the MENU button 5 times.

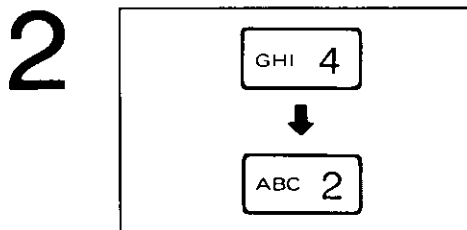

Press "4", then press "2".

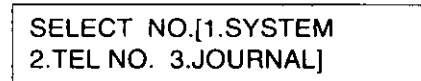

The unit starts printing.

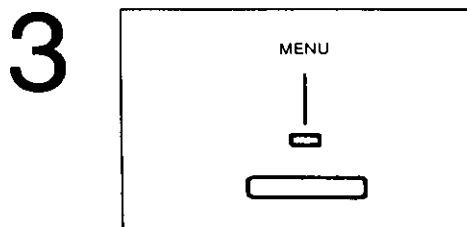

Press the MENU button to end the operation.

SYSTEM SETUP LIST

The SYSTEM SETUP LIST is useful when you confirm the current settings of the programming functions.

```

..... SYSTEM SETUP LIST .....
#01 1 1 90 04:25AM
#02 XDPF LOGO =
#04 XDPF TELEPHONE NUMBER =
#05 LOGO POSITION = OUT
#06 REMOTE TAD ID = 111
#07 REMOTE FAX ID = OFF
    REMOTE FAX ID NUMBER = 2222
#08 FAXING ID = 333
#09 MESSAGE OUT
    A = *** CONFIDENTIAL ***
    B = *** IMMEDIATE PERL. REQUESTED ***
    C =
#10 JOURNAL AUTO PRINT = AUTO
#11 PRINT INT REPORT = OFF
#12 NETWORK PASSCODE = 0000
#13 SEND PASSCODE = OFF
#14 TX PASSCODE CHECK = OFF
#15 RX PASSCODE CHECK = OFF
#16 POLLING PASSWORD = 0000
#17 FAX TX SPEED = 9600BPS
#18 FAX RX SPEED = 9600BPS
#19 AUTO STANDBY = ON
#20 TONE DETECT = OFF
#25 MULTI COPY SORT = OFF
#26 HENDRY INT = OFF
#27 HENDRY DELAYED INT = OFF
#28 HENDRY POLLING = OFF
#30 RECORDING TIME = NO
#31 CPC MODE = A
#32 TAD FAX PING CO = 1
#33 FAX PING CO = 1
#34 AUTO RECEIVE TIMEP = OFF
    AUTO RECEIVE ON TIME = 12:00AM MODE = TAD FAX
    AUTO RECEIVE OFF TIME = 12:00AM MODE = TEL
#42 TEST (PRINT OF MOTOR)
#50 SET DEFAULT = NO
#9000 *SERVICE DATA SET UP *
DELATED INT
    DELAYED MODE = OFF
    DOCUMENT = ADF
    PHONE NUMBER
  
```

To obtain the SYSTEM SETUP LIST:

1

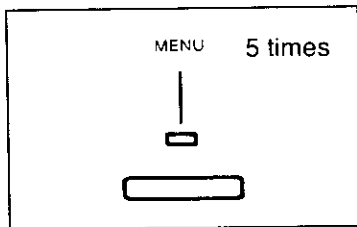

Press the MENU button 5 times.

PROGRAM[1.DATE 2.TEL
3.SYSTEM 4.REPORT]

2

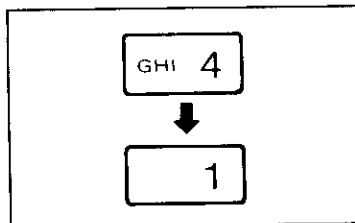

Press "4", then press "1".

SELECT NO.[1.SYSTEM
2.TEL NO. 3.JOURNAL]

The unit starts printing.

3

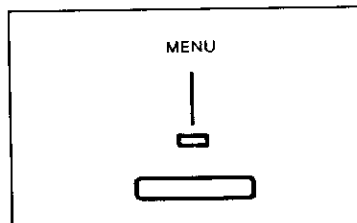

Press the MENU button to end the operation.

System Programming Functions

User programmable functions

LOGO POSITION

OUT: The LOGO is printed outside of the transmitted document's paper size. (Default)

IN: The LOGO is printed inside of the transmitted document's paper size.

OFF: The LOGO is not printed.

Operation

1

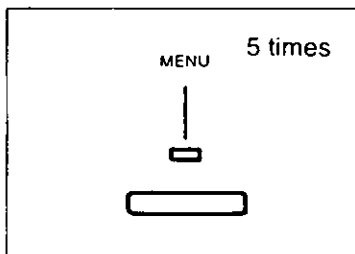

Press the MENU button 5 times.

PROGRAM[1.DATE 2.TEL
3.SYSTEM 4.REPORT]

2

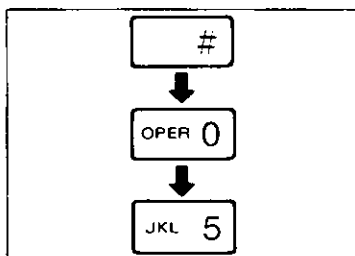

Press "#", then press "05" for the LOGO POSITION setting.

5.LOGO POSITION=OUT
[1.OUT 2.IN 3.OFF]

3

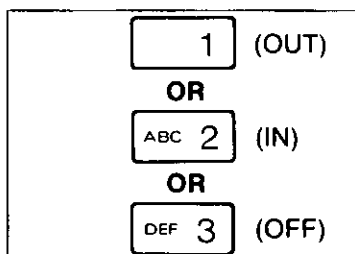

Press "1", "2" or "3" to select the desired mode.

4

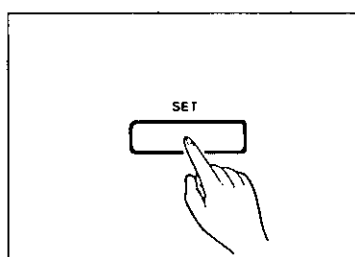

Press the SET button to store your selection.

PROGRAM[1.DATE 2.TEL
3.SYSTEM 4.REPORT]

5

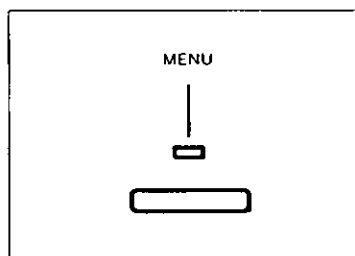

Press the MENU button to end the operation.

MESSAGE OUT

You can program your own message that will be printed at the top of all pages transmitted by your unit.

Example: Your own message is "URGENT!".

TO : PHONE NO. : 12 JAN. 1.1990 2:33AM P 1
FROM : Panasonic PHONE NO. : 987 6543

URGENT!

FAX CORRESPONDENCE

TO: _____ **DATE:** _____
FROM: _____ **OUR TEL. NO.:** _____

We would like to take this opportunity to intro
vice with facsimile

Programmed message

Operation

- 1 Press the MENU button 5 times.

PROGRAM[1.DATE 2.TEL
3.SYSTEM 4.REPORT]

- 2 Press "#", then press "09" for the MESSAGE OUT setting.

9.ENTER MESSAGE C
=

- 3 Enter the sentence you wish to have printed using the direct call station keys for up to 64 characters. For the usage of the direct call station keys, see pages 1-22 and 1-23. To correct an error while programming, press the CLEAR button then correct input.
- 4 Press the SET button.
- 5 Press the MENU button to end the operation.

Note:

- This message will be printed only when requested through the transmit setting function. (See page 2-8)

FAX TX SPEED

The unit automatically selects the optimum transmitting speed depending on the line condition and the type of the other facsimile unit. If you frequently experience problems such as transmission errors caused by poor line condition, set to "4800 BPS".

9600 BPS: Maximum speed of 9600 bits per second. (Default)

4800 BPS: Maximum speed of 4800 bits per second.

Operation

- 1 Press the MENU button 5 times.

```
PROGRAM[1.DATE 2.TEL  
3.SYSTEM 4.REPORT]
```

- 2 Press "#", then press "17" for the FAX TX SPEED setting.

```
17.TX SPEED=9600BPS  
[1.9600 2.4800]
```

- 3 Press "1" or "2" to select the desired mode.
- 4 Press the SET button.
- 5 Press the MENU button to end the operation.

FAX RX SPEED

The unit automatically selects the optimum receiving speed depending on the line condition and the type of the other facsimile unit. If you frequently experience problems such as reception errors caused by poor line condition, set to "4800 BPS".

9600 BPS: Maximum speed of 9600 bits per second. (Default)

4800 BPS: Maximum speed of 4800 bits per second.

Operation

- 1 Press the MENU button 5 times.

```
PROGRAM[1.DATE 2.TEL  
3.SYSTEM 4.REPORT]
```

- 2 Press "#", then press "18" for the FAX RX SPEED setting.

```
18.RX SPEED=9600BPS  
[1.9600 2.4800]
```

- 3 Press "1" or "2" to select the desired mode.
- 4 Press the SET button.
- 5 Press the MENU button to end the operation.

AUTO STANDBY

RESOLUTION, DOCUMENT CONTRAST and HALF TONE settings return to the following defaults after each transmission.

RESOLUTION: STANDARD
CONTRAST: NORMAL
HALF TONE: OFF (Indicator light is off.)

ON: These functions are enabled. (Default)

OFF: These functions are disabled.

- 1 Press the MENU button 5 times.

PROGRAM[1.DATE 2.TEL 3.SYSTEM 4.REPORT]
--

- 2 Press "#", then press "19" for the AUTO STANDBY setting.

19.AUTO STANDBY=ON [1.ON 2.OFF]

- 3 Press "1" or "2" to select the desired mode.
- 4 Press the SET button.
- 5 Press the MENU button to end the operation.

TONE DETECT

The unit automatically disconnects the line when it detects a busy tone after dialing in on-hook dialing mode.

OFF: The unit does not detect a busy tone. (Default)

ON: The unit detects a busy tone.

Operation

- 1 Press the MENU button 5 times.

PROGRAM[1.DATE 2.TEL 3.SYSTEM 4.REPORT]
--

- 2 Press "#", then press "20" for the TONE DETECT setting.

20.TONE DETECT=OFF [1.OFF 2.ON]

- 3 Press "1" or "2" to select the desired mode.
- 4 Press the SET button.
- 5 Press the MENU button to end the operation.

MULTI COPY SORT

The unit can sort the documents in order while copying.

OFF: The unit does not sort the documents in order. (Default)

ON: The unit sorts the documents in order.

Operation

- 1 Press the MENU button 5 times.

```
PROGRAM[1.DATE 2.TEL  
3.SYSTEM 4.REPORT]
```

- 2 Press "#", then press "25" for the MULTI COPY SORT setting.

```
25.MULTI COPY SORT  
=OFF [1.OFF 2.ON]
```

- 3 Press "1" or "2" to select the desired mode.
- 4 Press the SET button.
- 5 Press the MENU button to end the operation.

RECORDING TIME

The recording time for incoming messages (ICM) can be set to VOX (unlimited) or 1 MIN (1 minute).

VOX: The unit records an ICM as long as a caller speaks. (Default)

1 MIN: The unit records an ICM up to 1 minute per message.

Operation

- 1 Press the MENU button 5 times.

```
PROGRAM[1.DATE 2.TEL  
3.SYSTEM 4.REPORT]
```

- 2 Press "#", then press "30" for the RECORDING TIME setting.

```
30.RECORD TIME=VOX  
[1.VOX 2.1MIN]
```

- 3 Press "1" or "2" to select the desired mode.
- 4 Press the SET button.
- 5 Press the MENU button to end the operation.

CPC (Calling Party Control) MODE

Select the CPC mode "A" or "B" depending on your line condition.

- A:** Set to this mode if your line does not have special telephone services. (Default)
- B:** Set to this mode if your line has special telephone services such as call waiting and call forwarding. If some incoming messages are cut off in mode "A", set the mode to "B".

Operation

- 1 Press the MENU button 5 times.

PROGRAM[1.DATE 2.TEL
3.SYSTEM 4.REPORT]

- 2 Press the "#", then press "31" for the CPC MODE setting.

31.CPC MODE=A
[1.A 2.B]

- 3 Press "1" or "2" to select the desired mode.
- 4 Press the SET button.
- 5 Press the MENU button to end the operation.

TAD/FAX RING COUNT

This function is available only in the TAD/FAX mode when receiving a call.

If you find there is a difficulty in receiving from machines that have an automatic transmission feature, set TAD/FAX RING COUNT number to "1" (once).

- 0:** Toll Saver (See page 3-41.)
- 1:** The unit answers on the 1st ring. (Default)
- 2:** The unit answers on the 2nd ring.
- 3:** The unit answers on the 3rd ring.
- 4:** The unit answers on the 4th ring.

Operation

- 1 Press the MENU button 5 times.

PROGRAM[1.DATE 2.TEL
3.SYSTEM 4.REPORT]

- 2 Press the "#", then press "32" for the TAD/FAX RING COUNT setting.

32.TAD/FAX RING
COUNT=1

- 3 Press "0", "1", "2", "3" or "4" to select the desired mode.
- 4 Press the SET button.
- 5 Press the MENU button to end the operation.

FAX RING COUNT

This function is available only in the FAX mode when receiving a document. If you find there is difficulty in receiving from machines that have an automatic transmission feature, set FAX RING COUNT number to "1" (once).

- 1: The unit answers on the 1st ring. (Default)
- 2: The unit answers on the 2nd ring.
- 3: The unit answers on the 3rd ring.
- 4: The unit answers on the 4th ring.

Operation

- 1 Press the MENU button 5 times.

```
PROGRAM[1.DATE 2.TEL  
3.SYSTEM 4.REPORT]
```

- 2 Press the "#", then press "33" for the FAX RING COUNT setting.

```
33.FAX RING COUNT=1
```

- 3 Press "1", "2", "3" or "4" to select the desired mode.
- 4 Press the SET button.
- 5 Press the MENU button to end the operation.

TEST [PRINT/MOTOR]

Motor testing

You can check the motor of your unit as follows:

- 1 Insert a document on the document feeder tray.
- 2 Press the MENU button 5 times.

```
PROGRAM[1.DATE 2.TEL  
3.SYSTEM 4.REPORT]
```

- 3 Press "#", then press "42" for the TEST[PRINT/MOTOR] setting.

```
42.TEST=OFF [1.OFF  
2.PRINT 3.MOTOR]
```

- 4 Press "3", then press the SET button.

```
MOTOR TEST  
EXECUTING
```

- 5 Press the STOP button to stop the operation.
- 6 Press the MENU button to end the operation.

Printer testing

You can check the print quality of your unit by printing the test pattern. If the test pattern has any blurred points or lines or a dirty pattern, please clean the thermal head and rollers by following the instructions on page 6-6.

- 1 Press the MENU button 5 times.

```
PROGRAM [1.DATE 2.TEL  
3.SYSTEM 4.REPORT]
```

- 2 Press "#", then press "42" for the TEST[PRINT/MOTOR] setting.

```
42.TEST=OFF [1.OFF  
2.PRINT 3.MOTOR]
```

- 3 Press "2", then press the SET button.

```
PRINTER TEST  
EXECUTING
```

The unit prints the pattern as shown in Figure 1.

- 4 Press the MENU button to end the operation.

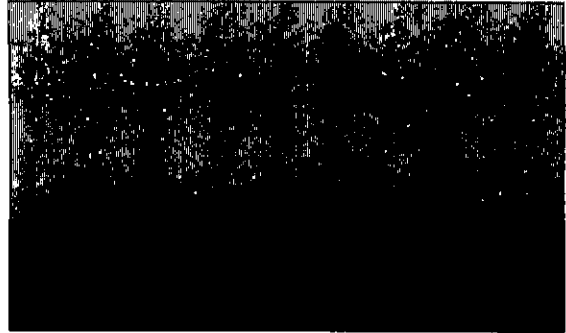

Figure 1 .

SET DEFAULT

This operation enables you to return the user programmable functions of #05 through #34 to their initial default settings. The function number #01 through #04 will not be erased.

Operation

- 1 Press the MENU button 5 times.

```
PROGRAM[1.DATE 2.TEL  
3.SYSTEM 4.REPORT]
```

- 2 Press the "#", then press "50" for the SET DEFAULT setting.

```
50.SET DEFAULT=NO  
[1.NO 2.YES]
```

- 3 Press "2", then press the SET button.

```
PARAMETER RESET OK?  
=NO [1.NO 2.YES]
```

- 4 Press "2", then press the SET button.

```
DEFAULT SETTING  
COMPLETED!
```

- 5 Press the MENU button to end the operation.

Service functions

The following service functions can be changed as the need arises. For further details, consult with your service center.

```
***** SERVICE DATA LIST *****
01 PAUSE TIME           = 05000ms
02 FLASH TIME          = 700ms
03 DIAL SPEED           = 10pps
10 VOX TIME            = 6sec
20 CED FREQ.           = 2100Hz
21 INTL MODE           = INTL
23 RX EQL.             = 1.8km
24 TX EQL.             = 1.8km
25 FAX MODE            = AUTO
26 MULTI COPY          = ON

SPECIAL SERVICE DATA SETTINGS
53 59 60 63 70 71 72 73 74 75 80 81 82 83 84
OFF ON ON 5 61 15 030 15 OFF OFF DETECT OFF ON ON ON

86 87 88 90 91 92 93 94 95 96 97
ON ON OFF 06 045 OUT 75 OFF 64 -10 OFF
*****
```

Printing the SERVICE DATA LIST

You can obtain a list of service functions (SERVICE DATA LIST).

- 1 Press the MENU button 5 times.

```
PROGRAM[1.DATE 2.TEL
3.SYSTEM 4.REPORT]
```

- 2 Press "#", "9", "0", "0", "0" and "*". The MENU indicator flashes and the display shows;

```
<SERVICE MODE>
[1.SETUP 2.TEST]
```

- 3 Press the START/COPY button to start printing.
- 4 Press the MENU button to end the operation.

Troubleshooting and Maintenance

Troubleshooting

Display messages

DISPLAY MESSAGES	CAUSE & REMEDY
CHECK COVER	<ul style="list-style-type: none">•The paper cover is open, close it.
CHECK DOCUMENT	<ul style="list-style-type: none">•The document has not fed properly. Reinsert the document.
CHECK ICM TAPE	<ul style="list-style-type: none">•The tape is broken or not installed. Install a new one.•Tape is full. Reset it or use the other side. When changing the tape, remember to record your OGM.
CHECK MEMORY	<ul style="list-style-type: none">•Memory (phone numbers, parameters, etc.) has been erased. Reprogram them.
RECORD OGM	<ul style="list-style-type: none">•OGM is not recorded. Record your OGM.
OUT OF PAPER	<ul style="list-style-type: none">•No recording paper. Replace it.
PAPER JAMMED	<ul style="list-style-type: none">•Recording paper jammed. Reinstall it.•Make sure that there is no slack in the recording paper.
POLLING ERROR	<ul style="list-style-type: none">•Polling password does not match. Set the same password as the other unit.•The polled station does not have the polled setting programmed.•The polling function can operate only between Panasonic compatible machines with the same protocol and password.
UNIT OVERHEATED, PLEASE WAIT	<ul style="list-style-type: none">•The unit is too hot. Leave it as it is and allow it to cool down.
REMOVE DOCUMENT	<ul style="list-style-type: none">•Document jammed. Open the paper cover and remove it.•Attempted to transmit a document longer than 600 mm (23⁵/₈"). Press the STOP button and remove it.
TX ERROR	<ul style="list-style-type: none">•Transmission error. Try again.•This display appears when your confidential or main passcode does not correspond to the other party.
MEMORY FULL	<ul style="list-style-type: none">•Document memory is full.

The ALARM indicator

PROBLEM	CAUSE & REMEDY
The indicator flashes after transmission.	<ul style="list-style-type: none"> •A transmission error has occurred. Try again.
The indicator lights.	<ul style="list-style-type: none"> •Confirm that the covers of the unit are closed firmly. •Your OGM is not recorded. See page 1-15.
The indicator lights during transmission.	<ul style="list-style-type: none"> •A document more than 600 mm (23$\frac{5}{8}$"") is being transmitted. •A document is jamming. Remove it. •Connect the unit to a line that does not have special telephone service such as call waiting.
The indicator lights during copying or receiving.	<ul style="list-style-type: none"> •The recording paper is jamming. Remove it.

Communication error code

The following error codes may appear following "NG" in the RESULT of JOURNAL, XMT REPORT, MULTI TRANSMISSION REPORT or MULTI POLLING REPORT.

ERROR CODE	CAUSE & REMEDY
01	Power supply overheating. Allow the unit to cool.
02	Interrupted transmission. Retry or check parameters.
03	Document jammed or not fed into the unit properly. Check document path. If a document is jammed, open the cover, then remove the document.
04	Transmission or reception error. Retry the operation.
05	Printing head overheating. Allow the unit to cool.
06	The unit is out of recording paper. Check recording paper.
07	The cover is open. Check cover latch.
08	Recording paper jammed. Re-install recording paper.
09	Network communication failed. Confirm that your passcode corresponds to that of the other unit.
10	Multi-polling communication failed.
11	Multi-polling or multi-transmission is canceled by the STOP button being pressed.

General corrective measures

Facsimile

PROBLEM	CAUSE & REMEDY
I cannot receive documents automatically.	<ul style="list-style-type: none">•Make sure that recording paper is installed properly.•Make sure the RECEIVE MODE of the unit is set to TAD/FAX or FAX mode and not to TEL mode.•Shorten your OGM, or ask the other party to press "*" (ASTERISK) to transmit a document.
Recording image is faint and I cannot read it well.	<ul style="list-style-type: none">•The sender transmitted a faint document.•Request him to transmit a more clear document (e.g. copied one) again.
The other party complains that the letters on the document are distorted.	<ul style="list-style-type: none">•If your line has special telephone service such as call waiting, it may have been activated during the fax reception. Connect the unit to a line that does not have such service.•Be sure another telephone is not connected to the same line as your unit.
The START/COPY indicator flashes for about 40 seconds after the unit receives a call automatically, but nothing is recorded.	<ul style="list-style-type: none">•The caller hangs up during or immediately after your OGM plays. This may occur if the disconnect signal is not transmitted from the telephone company's central office.
When I receive or copy a document that has a dark background or contains photographs, the unit produces a high pitched noise.	<ul style="list-style-type: none">•This is quite normal.
I cannot transmit a document to my own unit even after pressing "*".	<ul style="list-style-type: none">•The REMOTE FAX ID may be turned on. Enter your REMOTE FAX ID after pressing "*".
The unit does not operate properly.	<ul style="list-style-type: none">•Turn the POWER switch off, then turn it on again.
Problems when receiving international facsimiles.	<ul style="list-style-type: none">•Shorten your OGM to 10 seconds or less.•FAX RX SPEED may need to be set to 4800 bps. See page 5-3.

Answering Device & Telephone

PROBLEM	CAUSE & REMEDY
The Call Counter shows "--".	<ul style="list-style-type: none">•There has been a power failure. Confirm whether voice-messages are recorded on the tape or not.•The ICM tape was not rewound when the unit was turned on.
The unit does not work when any button is pressed.	<ul style="list-style-type: none">•Turn the POWER switch off, then turn it on again.
The unit has been set to the TAD/FAX mode, but no voice-messages have been recorded.	<ul style="list-style-type: none">•The tape is not installed properly or is broken (cut, worn out or twisted). Install the tape or replace it with a new one.
When the tape is played, the sound level is low or nothing can be heard.	<ul style="list-style-type: none">•Raise the sound level using the VOLUME control.•Clean the head of the cassette deck compartment. See page 6-5.
I have played back all the recorded messages and I want to record the next call after the last message.	<ul style="list-style-type: none">•Leave the unit as it is after hearing the messages.
I cannot retrieve recorded messages from a remote phone.	<ul style="list-style-type: none">•Make sure that you use your REMOTE TAD ID number correctly.•When you press your REMOTE TAD ID number, press the buttons firmly.
Some voice-messages have not been fully recorded.	<ul style="list-style-type: none">•Set the calling party control (CPC) to "B". See page 5-6.
When a caller hangs up after leaving a message, the tape does not stop.	<ul style="list-style-type: none">•VOX TIME should be set to 4 seconds. See page 5-9.
The unit does not ring.	<ul style="list-style-type: none">•Set the RINGER volume selector to the HIGH or LOW position.

Paper jams

Document jams:

Open the cover by pressing the BACK LID OPEN lever and clear the document that is causing problem.

Recording paper jams:

Open the cover by pressing the FRONT LID OPEN lever and remove the recording paper and re-install it properly. (See Recording paper installation on page 1-9.)

Maintenance

Be sure that the AC plug is disconnected from the outlet before performing any maintenance.

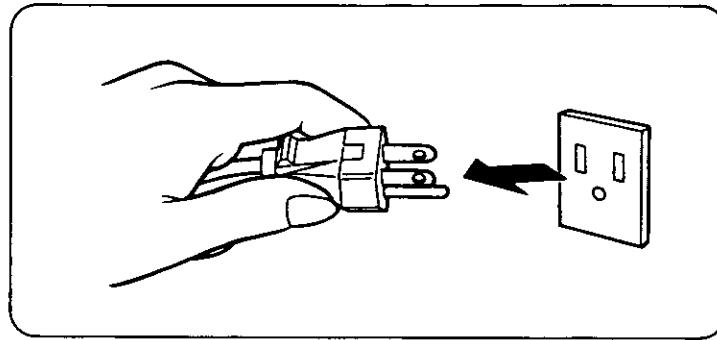

Cassette deck

Since the head and capstan assemblies are in contact with the tape, dirt and residue from the tape may easily adhere to these parts, causing distortion. Clean these parts periodically in the manner described below for the best sound quality.

Clean the head surfaces, pinch roller and capstan with a cotton swab.

If these surfaces are extremely dirty, wipe them with a cotton swab dampened with alcohol, then wipe them with a dry soft cloth.

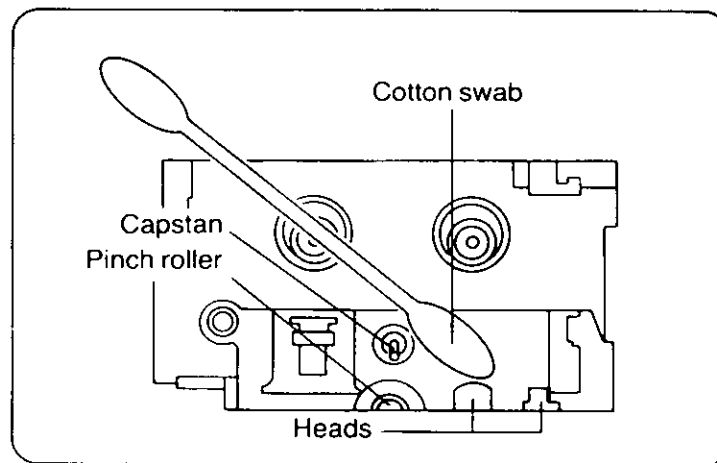

Note:

Do not bring magnetic or metal objects, such as screwdrivers, near the head assembly, as such objects could magnetize the heads.

Do not oil any part of the unit.

Facsimile machine

If a streak or a dirty pattern appears on a copied, transmitted or received document;

1. Clean the glass with a dry soft cloth.
2. Clean the paper rollers with a damp cloth then dry thoroughly to prevent the paper from jamming.

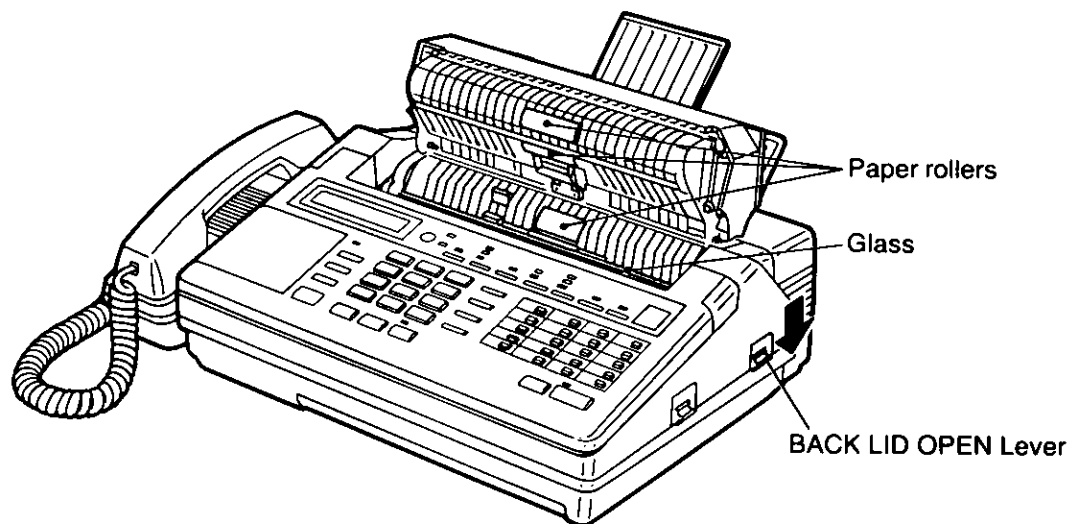

If you cannot get a clear copy after performing the above steps 1 and 2, clean the thermal head with a cloth moistened with denatured alcohol (alcohol without water), then dry thoroughly. To prevent malfunction due to static electricity, do not use a dry cloth and do not touch the thermal head with your finger directly.

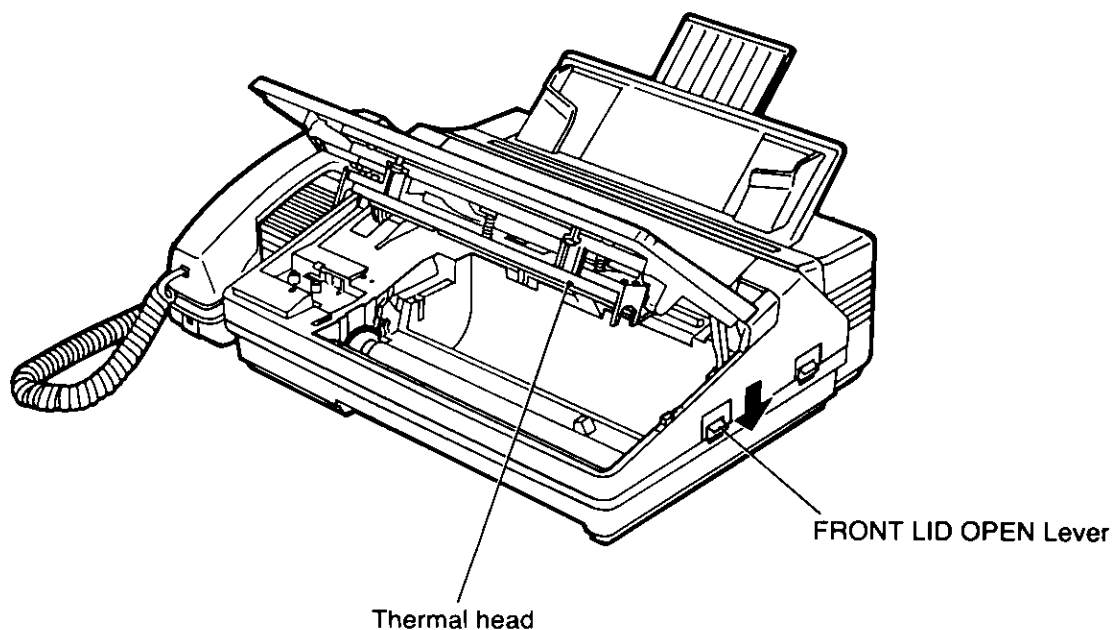

Accessory Order Information

Replacement parts and accessories are available through your local authorized parts distributor. For the authorized distributor in your area, call toll free: 1-800-545-2672.

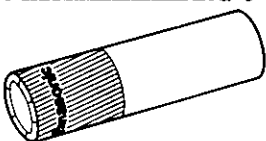
Part No.	Picture	Description	Comment
RT-MC30 RT-MC60		Micro Cassette Tape	For replacement
KX-A106		Recording Paper 216 mm×30 m roll (8½"×98' roll)	For supplement

Specifications

Type:	Desktop
Applicable Lines:	Public Switched Telephone Network
Compatibility:	CCITT G2/G3
Document Size:	Max. 216 mm (8½") in width, Max. 600 mm (23⅝") in length
Effective Scanning Width:	Max. 208 mm (8⅜")
Printing Paper Size:	216 mm (letter)×30 m roll (8½"×98' roll)
Effective Printing Width:	208 mm (8⅜")
Transmission Time*:	Approx. 30 sec/page (G3 Normal mode, MH) Approx. 17 sec/page (G3 Original mode, MH) Approx. 15 sec/page (G3 Normal mode, MR)
Scanning Density:	Horizontal 8 pels/mm (203 pels/inch) Vertical 3.85 lines/mm (98 lines/inch) Standard 7.7 lines/mm (196 lines/inch) Fine/Halftone 15.4 lines/mm (392 lines/inch) Superfine
Scanner Type:	CCD image sensor
Printer Type:	Thermal printing
Data Compression System:	Modified Huffman (MH), Modified Read (MR)
Modem Speed:	9600/7200/4800/2400 bps; Automatic Fallback, and G2
Automatic Document Feeder:	Max. 10 sheets
Temperature Range:	5°~35°C (41°~95°F)
Humidity Range:	45%~85%
Dimensions (H×W×D):	125×429×312 mm (4⅔×16⅞×12⅔")
Weight:	5.5 kg (12.12 lbs)
Power Consumption:	Approx. 65 W
Power Supply:	AC 120 V, 60 Hz

*Transmission Time: Transmission times apply to text data using CCITT No. 1 test chart, between same machine models at maximum modem speed. Transmission times vary in actual usage.

QUICK REFERENCE CARD

FOR TONE REMOTE CONTROL

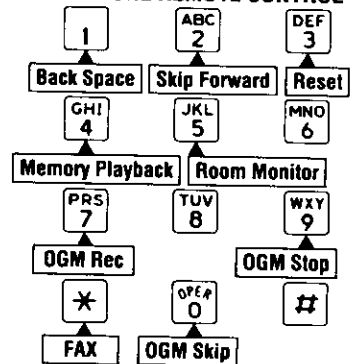

- To set the TAD/FAX mode, call your unit and wait for 15 rings. The unit will answer, then hang up.
- To send the document, press **0**. The "beep" (answering carrier tone) is heard. Then start transmission.

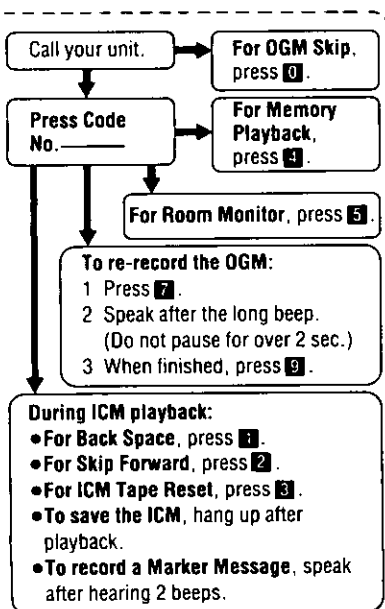

•When you press any button, press firmly.

For your future reference

SERIAL NO. _____ DATE OF PURCHASE _____
(found on the rear side of the unit)

PLACE OF PURCHASE _____

ADDRESS _____

© Matsushita Electric Industrial Co. Ltd.,
All rights reserved. Unauthorized
copying and distribution is a violation of law

Panasonic Company
Division of Matsushita Electric Corporation of America
One Panasonic Way, Secaucus, New Jersey 07094

Panasonic Sales Company ("PSC"),
Division of Matsushita Electric of Puerto Rico, Inc.
San Gabriel Industrial Park, 65th Infantry Avenue, KM 9.5, Carolina, P.R. 00630

Free Manuals Download Website

<http://myh66.com>

<http://usermanuals.us>

<http://www.somanuals.com>

<http://www.4manuals.cc>

<http://www.manual-lib.com>

<http://www.404manual.com>

<http://www.luxmanual.com>

<http://aubethermostatmanual.com>

Golf course search by state

<http://golfingnear.com>

Email search by domain

<http://emailbydomain.com>

Auto manuals search

<http://auto.somanuals.com>

TV manuals search

<http://tv.somanuals.com>