

Panasonic

Multi-Function
Laser FAX

Model No.

KX-FLM600AL
KX-FLM600NZ



To get started,
please read the
Quick Start section
(p. 8-15).

Initial Preparation

Telephone

Fax/Copy

PC Software

Help

General
Information

OPERATING INSTRUCTIONS

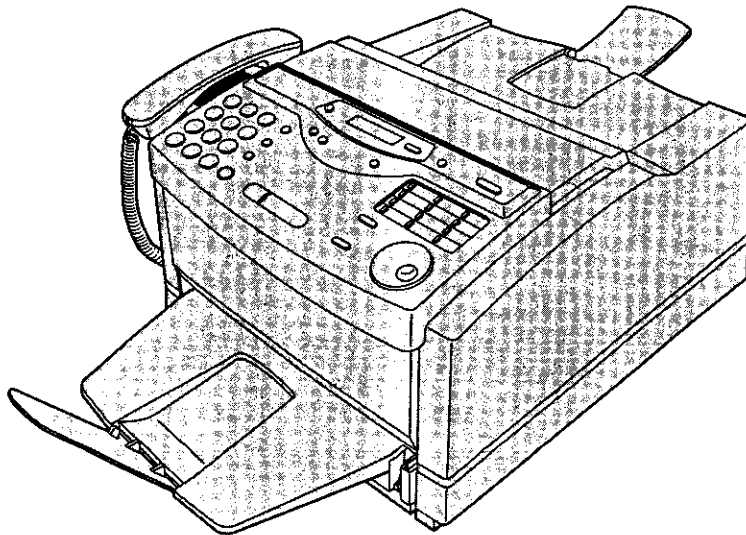

Please read these Operating Instructions
before using the unit and save for future
reference.

Thank you for purchasing a Panasonic facsimile.

Welcome to the world of Panasonic facsimiles.

This product combines facsimile, telephone, copier, scanner, PC Fax and printer features to provide you with more efficient office or home use. By utilizing these convenient features, you can maximize the effectiveness of this unit.

For future reference	
Date of purchase	Serial number (found on the rear of the unit)
Dealer's name and address	
Dealer's telephone number	

Use of this product in a country it was not designed for, may violate the laws of that country.
The KX-FLM600AL is only designed to work with the Australian network.
The KX-FLM600NZ is only designed to work with the New Zealand network.

Caution:

- When connecting the fax machine to your computer, use the included parallel cable for reliable data communications and compliance with EMI.

Note:

- A suffix "AL" or "NZ" in the model number is omitted in these instructions.

Trademarks

IBM is a registered trademark of International Business Machines Corporation.

Microsoft and Windows are registered trademarks of Microsoft Corporation in the United States and/or other countries.

Visioneer PaperPort is a registered trademark of Visioneer, Inc.

All other trademarks identified herein are the property of their respective owners.

Copyright:

This manual is copyrighted by Kyushu Matsushita Electric Co., Ltd. (KME) and its licensee. Under the copyright laws, this manual may not be reproduced in any form, in whole or part, without the prior written consent of KME and its licensee.

© Kyushu Matsushita Electric Co., Ltd. 1999

For Australian users

Warning:

- This equipment will be inoperable when mains power fails.
- When a failure occurs which results in the internal parts becoming accessible, disconnect the power supply cord immediately and return this unit to an authorized service center.
- Disconnect the telephone connection before disconnecting power connection prior to relocating the equipment, and reconnect the power first.
- To minimize the possibility of lightning damage, when you know that a thunderstorm is coming, we recommend that you:
 - A. Unplug the telephone line cord from the phone jack.
 - B. Unplug the power supply cord from the AC power outlet.
- No "000" or other calls can be made from this device during a mains power failure.

For New Zealand users

Warning:

- WHEN A FAILURE OCCURS WHICH RESULTS IN THE INTERNAL PARTS BECOMING ACCESSIBLE, DISCONNECT THE POWER SUPPLY CORD IMMEDIATELY AND RETURN THIS UNIT TO AN AUTHORIZED SERVICE CENTER.
- DISCONNECT THE TELECOM CONNECTION BEFORE DISCONNECTING THE POWER CONNECTION PRIOR TO RELOCATING THE EQUIPMENT, AND RECONNECT THE POWER FIRST.
- NO "111" OR OTHER CALLS CAN BE MADE FROM THIS DEVICE DURING A MAINS POWER FAILURE.

IMPORTANT NOTICE

Under power failure conditions, this telephone may not operate. Please ensure that a separate telephone, not dependent on local power, is available for emergency use.

Notice:

- The grant of a Telepermit for any item of terminal equipment indicates only that Telecom has accepted that the item complies with minimum conditions for connection to its network. It indicates no endorsement of the product by Telecom, nor does it provide any sort of warranty. Above all, it provides no assurance that any item will work correctly in all respects with another item of Telepermitted equipment of a different make or model, nor does it imply that any product is compatible with all of Telecom's network services.
- This device is equipped with pulse dialling while the Telecom standard is DTMF tone dialling. There is no guarantee that Telecom lines will always continue to support pulse dialling.
- Use of pulse dialling, when this equipment is connected to the same line as other equipment, may give rise to bell tinkle or noise and may also cause a false answer condition. Should such problems occur, the user should NOT contact Telecom Faults Service.
- This equipment shall not be set to make automatic calls to the Telecom "111" Emergency Service.
- This equipment should not be used under any circumstances which may constitute a nuisance to other Telecom customers.
- This equipment may not provide for the effective hand-over of a call to another device connected to the same line.
- Not all telephones will respond to incoming ringing when connected to the extension socket.
- The Message Center Software used with facsimile unit should be set in compliance with Telecom's PTC specification.

The software must be set within the following limits in order to ensure compliance with Telecom's requirements:

 1. Do not set the number of retries to more than 9.
 2. Do not set the retry interval to less than 25 seconds.
 3. Do not select pulse dialling.

Note that failure to set these parameters correctly may negate the user's rights under Telecom's Terms of Service.

Important safety instructions

When using this unit, basic safety precautions should always be followed to reduce the risk of fire, electric shock, or personal injury.

1. Read and understand all instructions.
2. Follow all warnings and instructions marked on this unit.
3. Unplug this unit from AC outlets before cleaning. Do not use liquid or aerosol cleaners. Use a damp cloth for cleaning.
4. Do not use this unit near water, for example near a bath tub, wash bowl, kitchen sink, or the like.
5. Place the unit securely on a stable surface. Serious damage and/or injury may result if the unit falls.
6. Do not cover slots and openings on the unit. They are provided for ventilation and protection against overheating. Never place the unit near radiators, or in a place where proper ventilation is not provided.
7. Use only the power source marked on the unit. If you are not sure of the type of power supplied to your home, consult your dealer or local power company.
8. For safety purposes this unit is equipped with a three prong grounded plug. If you do not have this type of outlet, please have one installed. Do not use any type of adaptor plug to defeat this safety feature.
9. Do not place objects on the power cord. Install the unit where no one can step or trip on the cord.
10. Do not overload wall outlets and extension cords. This can result in the risk of fire or electric shock.
11. Never push any objects through slots in this unit. This may result in the risk of fire or electric shock. Never spill any liquid on the unit.
12. To reduce the risk of electric shock, do not disassemble this unit. Take the unit to an authorized servicentre when service is required. Opening or removing covers may expose you to dangerous voltages or other risks. Incorrect reassembly can cause electric shock when the unit is subsequently used.
13. Unplug this unit from the wall outlet and refer servicing to an authorized servicentre when the following conditions occur:
 - A. When the power supply cord or plug is damaged or frayed.
 - B. If liquid has been spilled into the unit.
 - C. If the unit has been exposed to rain or water.
 - D. If the unit does not work normally by following the operating instructions. Adjust only controls covered by the operating instructions. Improper adjustment may require extensive work by an authorized servicentre.
 - E. If the unit has been dropped or physically damaged.
 - F. If the unit exhibits a distinct change in performance.
14. During thunderstorms, avoid using telephones except cordless types. There may be a remote risk of an electric shock from lightning.
15. Do not use this unit to report a gas leak, when in the vicinity of the leak.

SAVE THESE INSTRUCTIONS

INSTALLATION:

- Installation of telephone wiring and outlets must only be carried out by persons appropriately licensed.
- Never install telephone wiring during a lightning storm.
- Never install telephone jacks in wet locations unless the jack is specifically designed for wet locations.
- Never touch uninsulated telephone wires or terminals unless the telephone line has been disconnected at the network interface.
- Use caution when installing or modifying telephone lines.

WARNING:

- To prevent the risk of fire or electrical shock, do not expose this product to rain or any type of moisture.

CAUTION:

- This printer utilizes a laser. Use of controls or adjustments or performance of procedures other than those specified herein may result in hazardous radiation exposure.

OTHER INFORMATION:



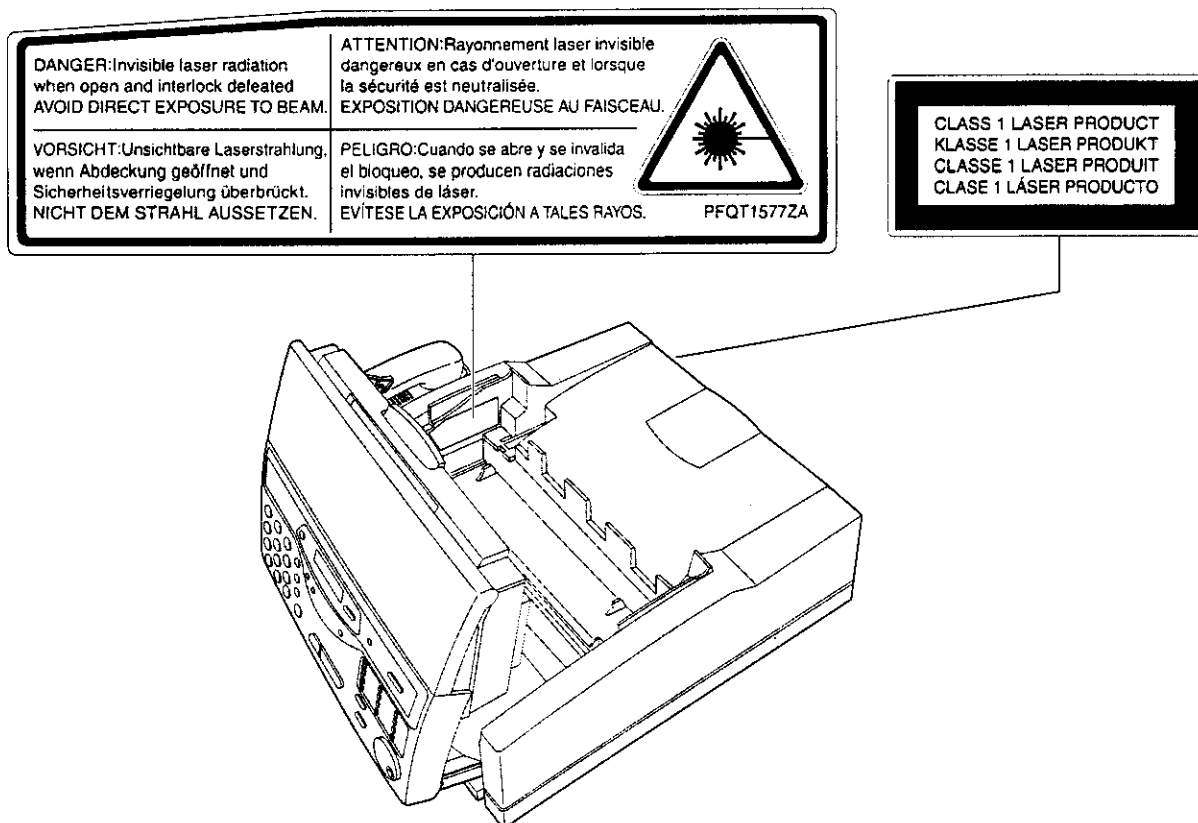

- Keep the unit away from electrical noise generating devices, such as fluorescent lamps and motors.
- The unit should be kept free from dust, high temperature and vibration.
- The unit should not be exposed to direct sunlight.
- Do not place heavy objects on top of this unit.
- Do not touch the plug with wet hands.

WASTE DISPOSAL METHOD:

- Waste material may be dumped or incinerated under conditions which meet all federal, provincial and local environmental regulations.

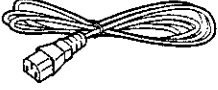

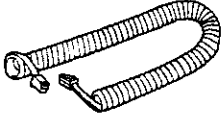
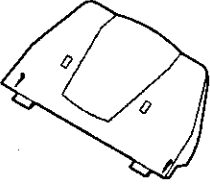
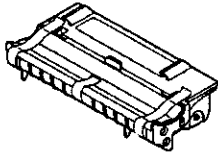
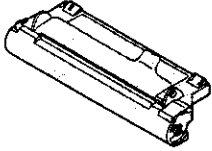
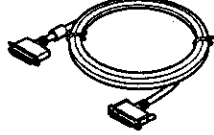
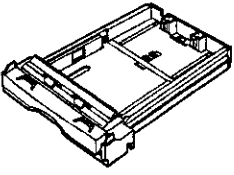
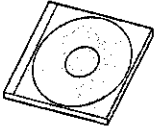
Included accessories

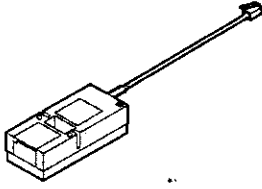
Power cord.....1 	Telephone line cord1 	Handset1 	Handset cord1 
Paper tray1 	Toner cartridge1 	Drum unit1 	Printer cable.....1 (Parallel cable) 
Paper cassette1  —The paper cassette is pre-installed.	Panasonic PC software for KX-FLM600 (CD-ROM)1 	Telephone plug1 (KX-FLM600AL only) 	Telephone cord adaptor.....1 (KX-FLM600NZ only) 

- If any items are missing or damaged, check with the place of purchase.
- Save the original carton and packing materials for future shipping and transporting of the unit.

Accessory order information

Model No.	Description	Specifications
KX-FA75A	Toner cartridge and drum unit	1 toner cartridge and 1 drum unit

Installation

Before installation (p. 22)

Remove the shipping tape.

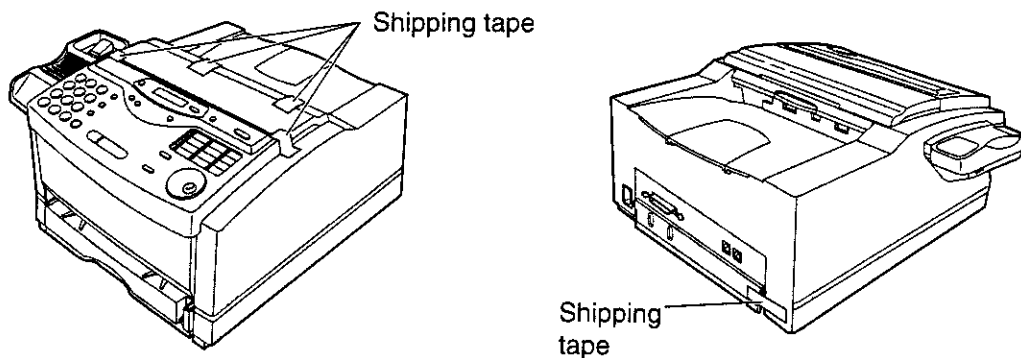

1 Toner cartridge (p. 22-24)

- A. Pull the top cover handle forward and open the top cover.
- B. Remove the protection cap attached to the cartridge.

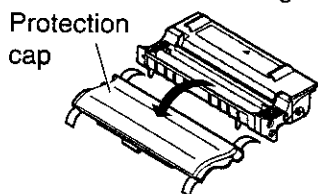

• Do not touch the roller.

- C. Rock the cartridge from side to side several times carefully.

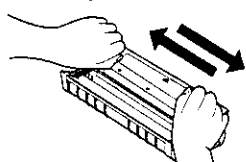

- D. Install the cartridge holding the two tabs.

Top cover handle

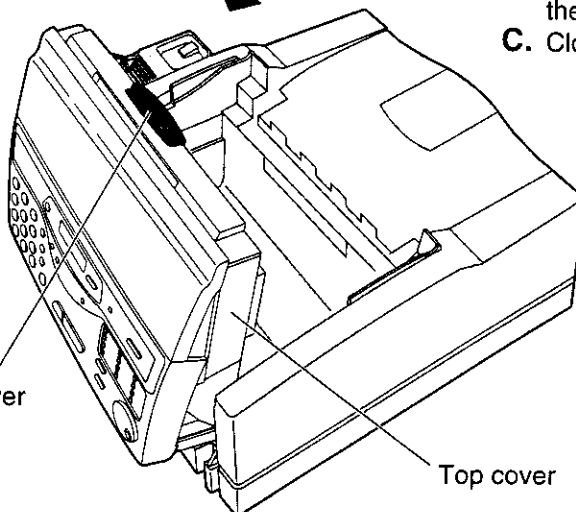
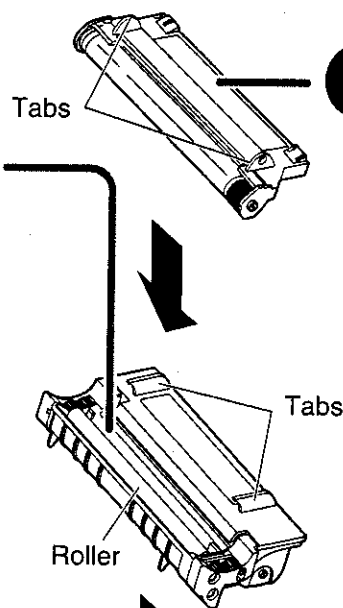

2 Drum unit (p. 22-24)

- A. Remove the protection cap and protection sheet attached to the drum unit.
 - Do not touch or scratch the green drum surface.
 - Do not expose the drum unit to light for more than 5 minutes.

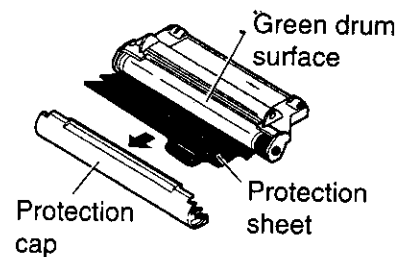

- B. Install the drum unit on the toner cartridge by holding the two tabs.
- C. Close the top cover.

3 Recording paper (p. 25, 26)

- A. Lift the paper cassette up slightly and pull it out of the unit.
- B. Fan the stack of paper to prevent a paper jam and place the paper in the paper cassette.
 - Put the side to be printed face up.
- C. Insert the paper cassette into the unit until it clicks into place.

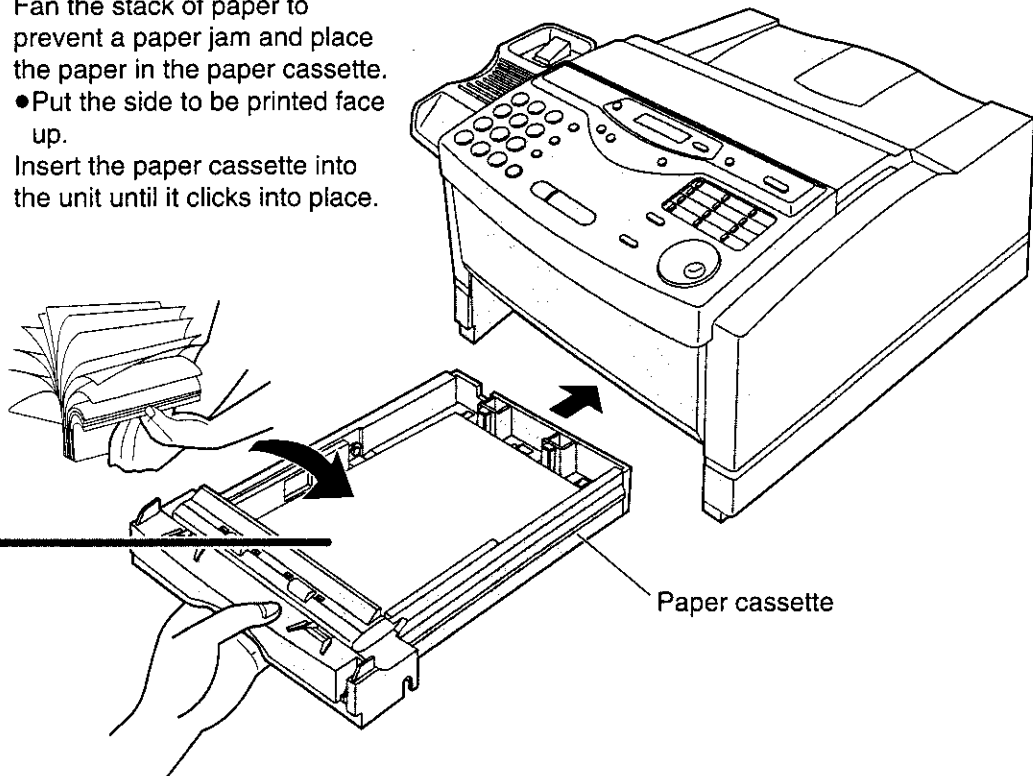

4 Paper tray and paper stacker (p. 27)

- A. Insert the two tabs of the paper tray into the slots on the paper cassette.
- B. Open the paper tray extender.
- C. Open the paper stacker.

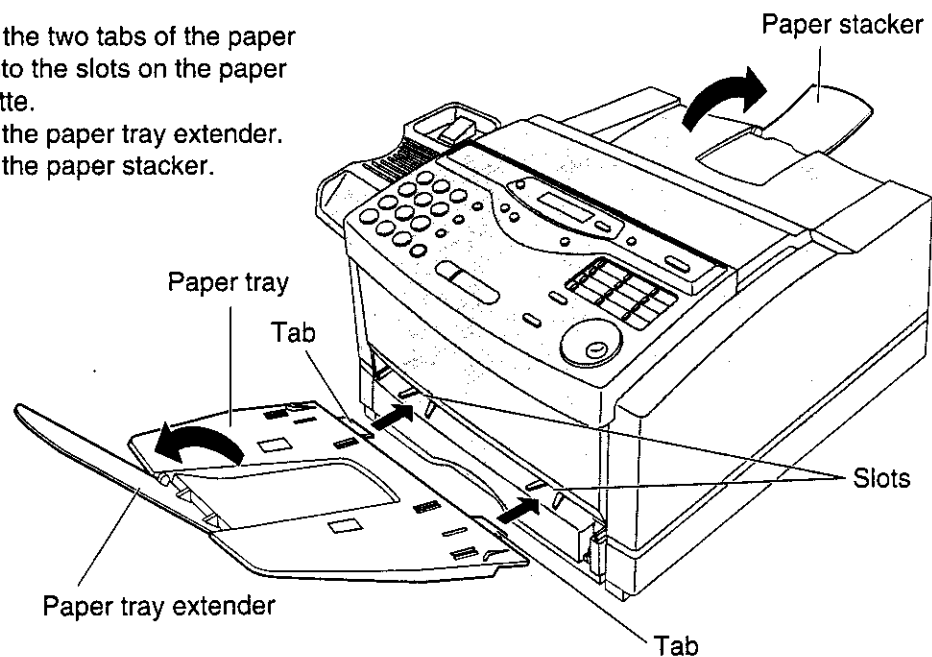

Connections

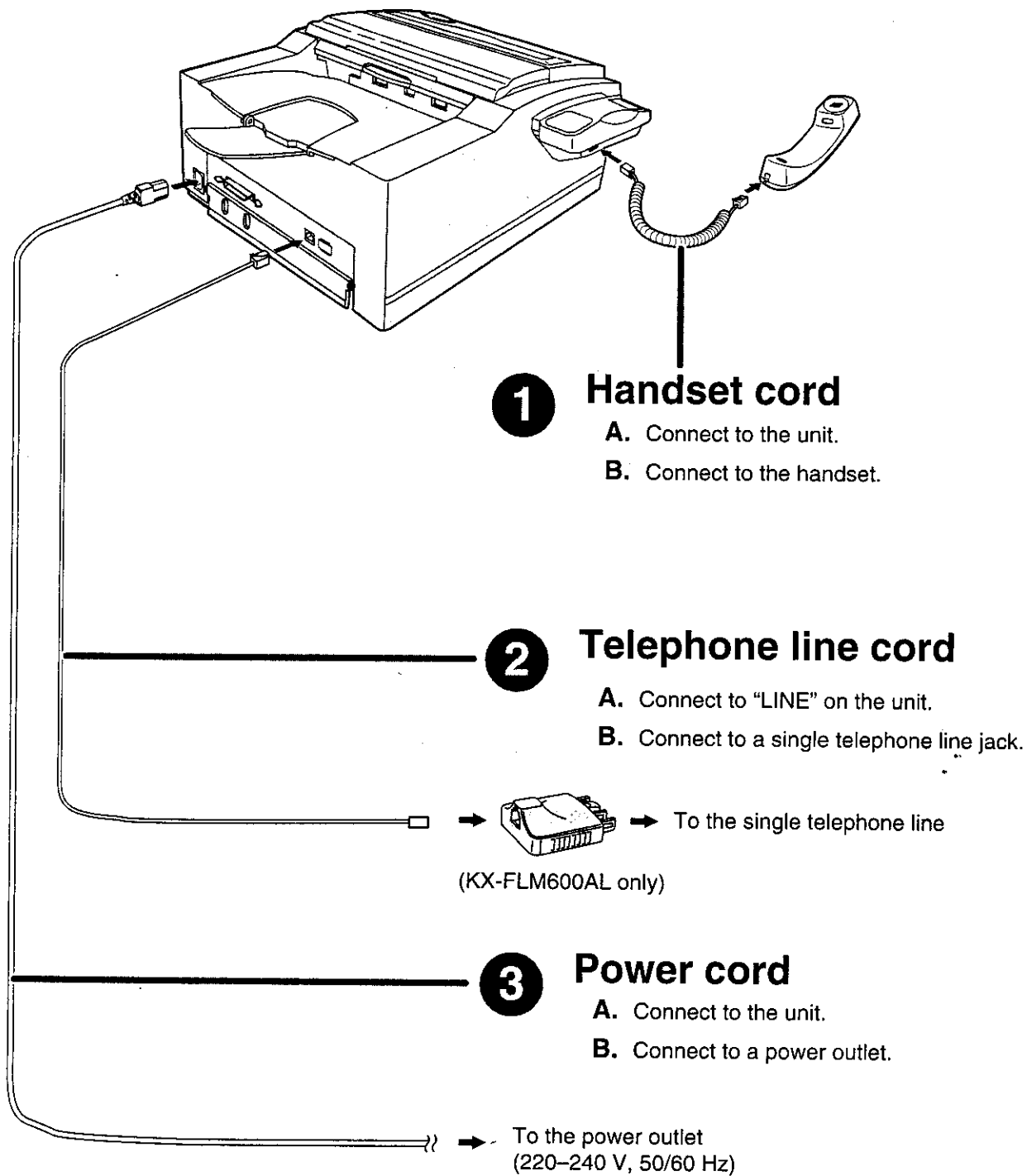

•For further details, see page 28.

Voice calls - making/answering

Voice calls - making

- 1** Lift the handset.
- 2** Dial the number.
- 3** When finished talking, replace the handset.

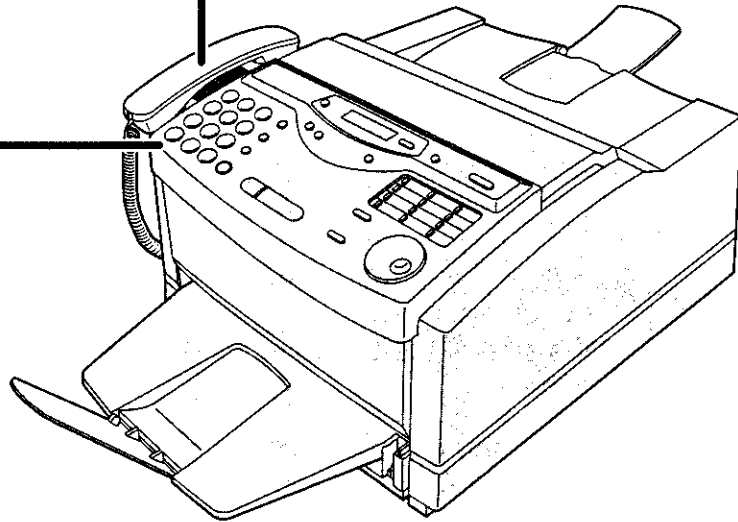

- For further details, see page 34.
- If you are having trouble, see page 112.

Voice calls - answering

- 1** When the unit rings, lift the handset.
- 2** When finished talking, replace the handset.

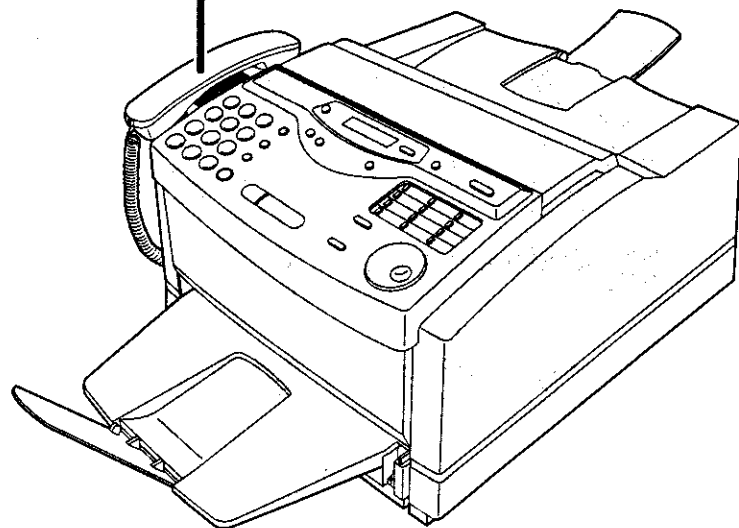

- For further details, see page 34.
- If you are having trouble, see page 112.

Faxes - sending/receiving

Faxes - sending

- 1 Open the document feeder tray.

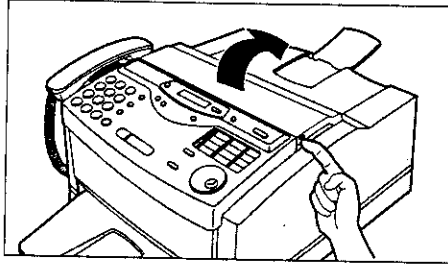

- 2 Adjust the width of the document guides to the size of the document.

- 3 Insert the document until the unit grabs the document and a single beep is heard.

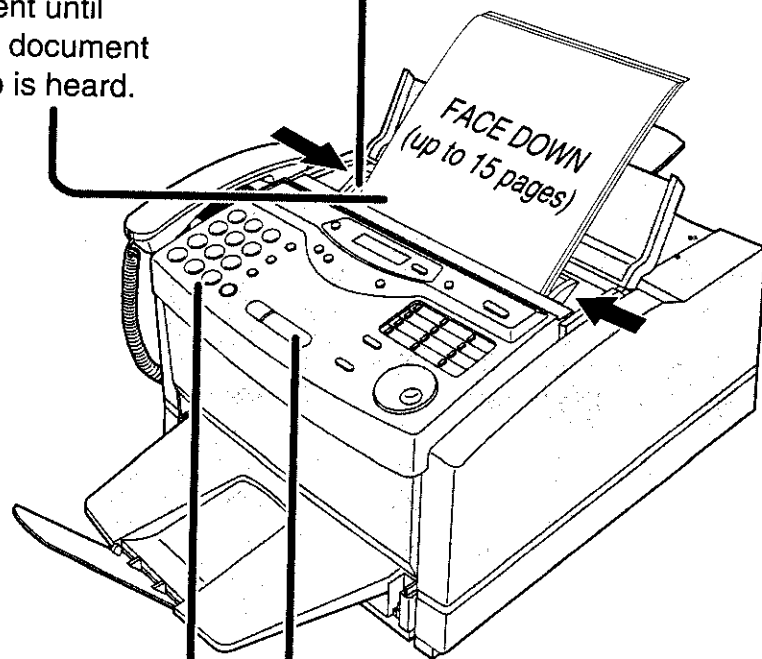

- 4 Dial the fax number.

- 5 Press **START/SET/COPY**.

Note:

- While scanning, do not move the pages which have already been ejected. A paper jam may occur. Allow the scanning process to finish before viewing documents.

- For further details, see page 43.
- If you are having trouble, see pages 112 and 113.

Faxes - receiving

- 1** When the unit rings, lift the handset.

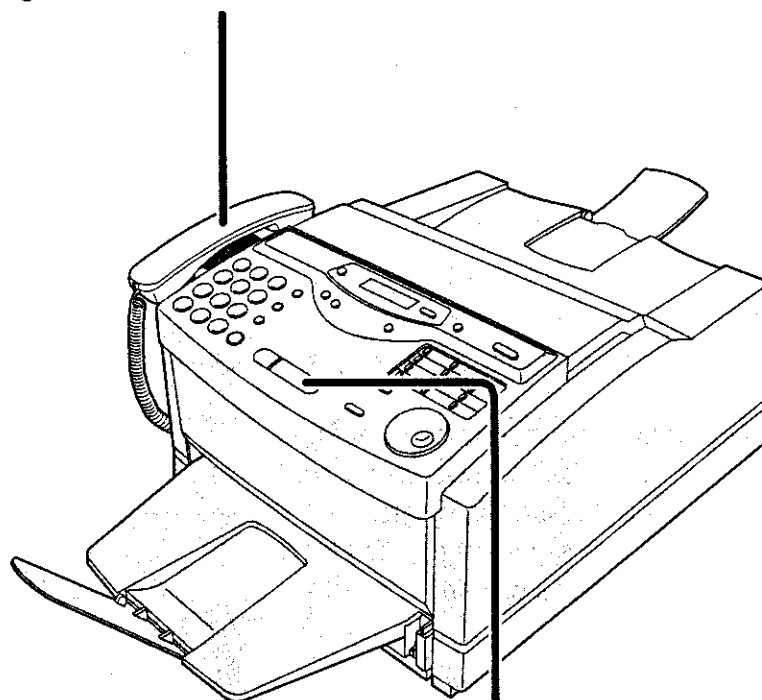

- 2** When:
 - document reception is required,
 - a fax calling tone (slow beep) is heard, or
 - no sound is heard,press **START/SET/COPY**.

- 3** Replace the handset.

- For further details, see page 58.
- You can select the way to receive calls according to your needs (p. 56, 57).
- If you are having trouble, see page 113.

Copying

- 1** Open the document feeder tray.

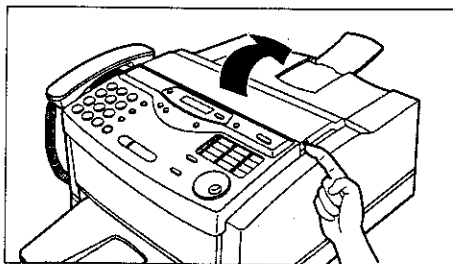

- 2** Adjust the width of the document guides to the size of the document.

- 3** Insert the document until the unit grabs the document and a single beep is heard.

- Make sure the handset is on the cradle.

- 4** Press **START/SET/COPY**.

- 5** Enter the number of copies.

- 6** Press **START/SET/COPY**.

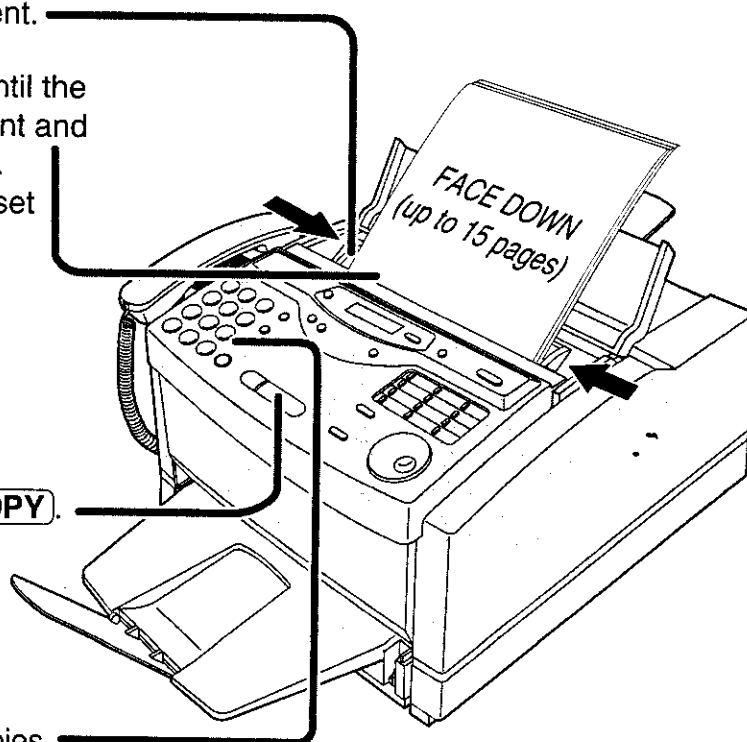

Note:

- While scanning, do not move the pages which have already been ejected. A paper jam may occur. Allow the scanning process to finish before viewing documents.

- For further details, see page 76.
- If you are having trouble, see page 113.

PC information

- 1** Connect to a computer (p. 78).

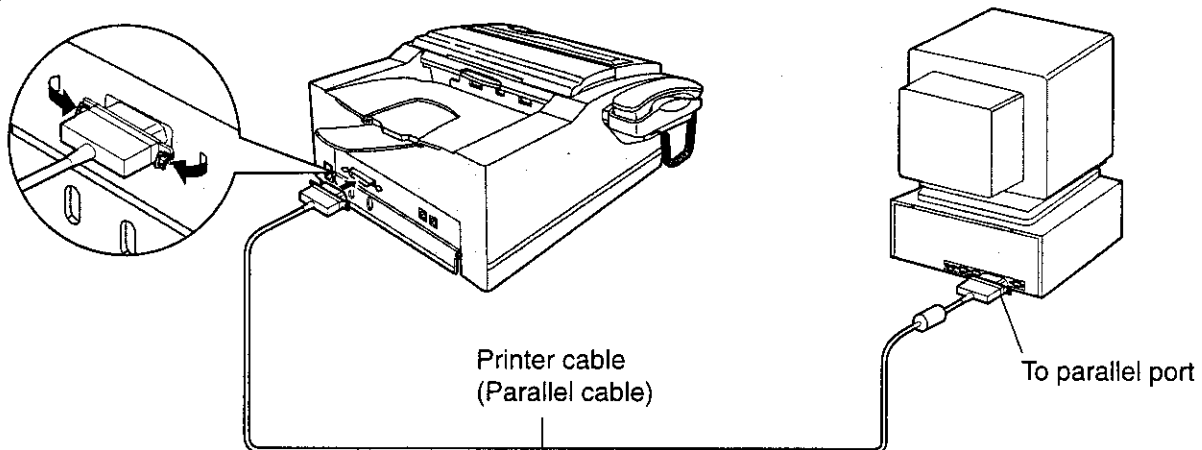

Caution:

- When connecting the fax machine to your computer, use the included printer cable for reliable data communications and compliance with EMI.

- 2** Install the PANA LINK software (p. 79).

1. Start Windows® 95* or Windows 98** and close all applications.
2. Insert the included CD into your CD-ROM drive.
 - The language dialogue box will appear.
Select the desired language that you use with this software. Click **OK**.
 - If the language dialogue box does not appear and the installation does not start automatically:
Click **Start**, choose **Run...** . Type "**d:\setup**" (where **d:** is the drive letter of your CD-ROM drive). Click **OK**.
(If you are not sure what the drive letter is for your CD-ROM drive, please use Windows Explorer and look for the CD-ROM drive.)
3. The installation will start automatically.
4. Follow the instructions on the screen until all files have been installed.
5. Be sure to read the README file for more information.

- 3** Activate the PANA LINK software (p. 80).

1. Click **Start**.
2. Point to **Programs**, point to **PANA LINK** and click **PANA LINK**.
 - The PANA LINK main panel will appear.

*Microsoft® Windows 95 operating system (hereafter Windows 95)

**Microsoft Windows 98 operating system (hereafter Windows 98)

Table of Contents

Initial Preparation	Help Button	Help function	18	
	Finding the Controls	Overview	19	
		Location	20	
	Setup	Before installation	22	
		Toner cartridge and drum unit	22	
		Recording paper	25	
		Paper tray	27	
		Paper stacker	27	
		Connections	28	
		Date and time, your logo and facsimile telephone number	29	
Recording paper size		32		
Volumes	Adjusting volumes	33		
Telephone	Making and Answering Calls	Voice calls - making	34	
		Voice calls - answering	34	
		RECALL and PAUSE buttons	35	
		Dialing mode (touch tone or pulse) (KX-FLM600AL only)	36	
		Setting the melody ringer	36	
	One-Touch Dial	Storing names and telephone numbers in the One-Touch Dial	37	
		Making a voice call using the One-Touch Dial	38	
	EASY DIAL	Storing names and telephone numbers in the EASY DIAL directory	39	
		Making a voice call using the EASY DIAL directory	41	
	Voice Contact	Talking to the caller after fax transmission or reception	42	
Fax/Copy	Sending Faxes	Sending a fax manually	43	
		Sending a fax using the One-Touch Dial	44	
		Sending a fax using the EASY DIAL directory	45	
		Documents you can send	46	
		Sending report for confirmation	47	
		Automatic journal report	48	
		Delayed transmission (sending a fax at a specified time)	49	
		From memory	50	
		Multiple stations	51	
		Overseas mode	54	
		Half-tone setting	54	
		Error correction mode setting	55	
		Connecting tone	55	
		Receiving Faxes	Setting the unit to receive calls	56
			TEL mode (answering all calls manually)	58
	Turning the AUTO ANSWER mode on remotely		59	
	Extension telephone		60	
Fax activation code	60			
FAX ONLY mode (all calls are received as faxes)	61			
Using the unit with an answering machine	63			
TEL/FAX mode (receiving voice calls with rings and fax calls without rings when you are near the unit)	66			
Distinctive ring service - FaxAbility	70			
Other size documents	71			
Copying	Silent detection (receiving faxes from older model fax machines)	72		
	Memory reception alert	72		
	Friendly reception	73		
	Pager call - when your unit receives a fax	74		
	Toner save	75		
Copying	Making a copy	76		

PC Software	Setup (PC)	Connecting to a computer	78	Initial Preparation		
		Installing the PANA LINK software	79			
		Activating the PANA LINK software	80			
		Setting up PANA LINK	82			
		Setting user information	83			
	Printer	Printing documents created on the PC	84		Telephone	
		Printing using the paper tray (manual feeding)	88			
	PC Fax	Sending documents created on the PC	92			
		Sending a document from the fax machine using the PC	96			
	PC Receiving	Receiving faxes on your PC	97			
	Phone Call	Making a phone call	99			
Address Book	Computerized directory for fax and phone numbers	100				
Scanning	Using your fax machine as a scanner	101				
Copier	PC based copying	105				
More Information	The Communication Log	106	Fax/Copy			
	Viewer	107				
	PC link (turning PC related functions on/off)	108				
Help	Error Messages	Reports		109	PC Software	
		Display		110		
	Operations	When a function does not work, check here before requesting help		112		
		If a power failure occurs		119		
	Jams	Clearing paper jams		120		
		Sending document jams		122		
	Cleaning	Cleaning		122		
	Replacement	Replacing the toner cartridge and drum unit		123		
	Repacking	Transporting the unit	126			
	General Information	Print Reports	Printing the feature settings, telephone numbers, journal and broadcast list	129		Help
		Display Contrast	Changing the display contrast	130		
Reset		Resetting the advanced features	130			
Specifications		Technical data about this product	131			
Index		Index	134			
Features Summary		Summary of user programmable features	136			
Important Information		Important Information (KX-FLM600AL only)	139			
					General Information	

Help Button

Help function

You can print a quick reference for assistance as follows. Before using this function, read the instructions on pages 22 to 28 and set up the unit.

1 Press **HELP**.

Display: **PRESS [▼▲] & [SET]**

2 Press **▼** or **▲** until the desired item is displayed. The following items are available.

1. How to program your unit

1. HOW TO SET UP

2. How to store names in the EASY DIAL directory and how to dial them

2. EASY DIAL

3. Help with problems receiving faxes

3. FAX RECEIVING

4. How to use the copier function

4. COPIER

5. List of available reports

5. REPORTS

3 Press **START/SET/COPY**.

PRINTING

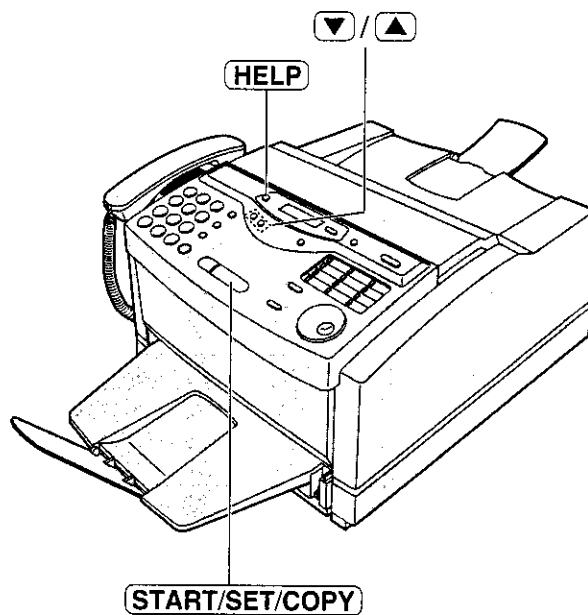

Overview

Front view

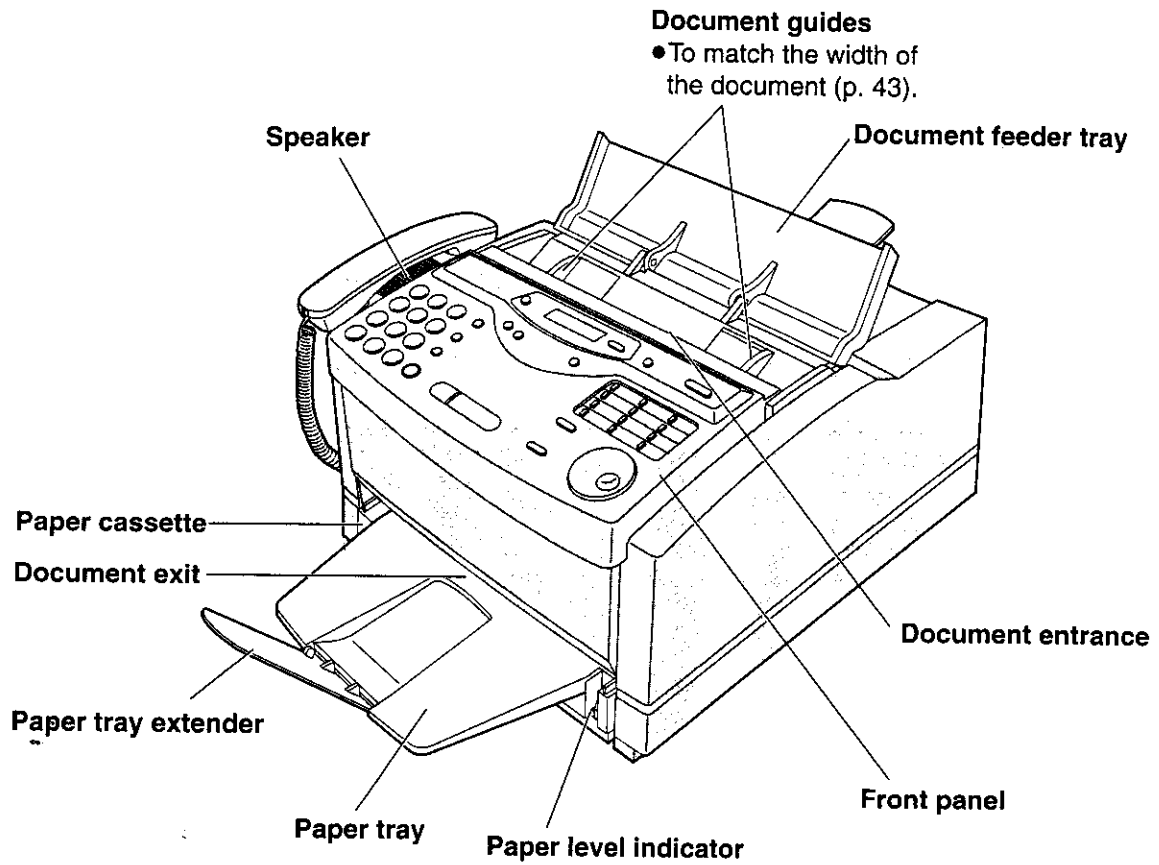

Rear view

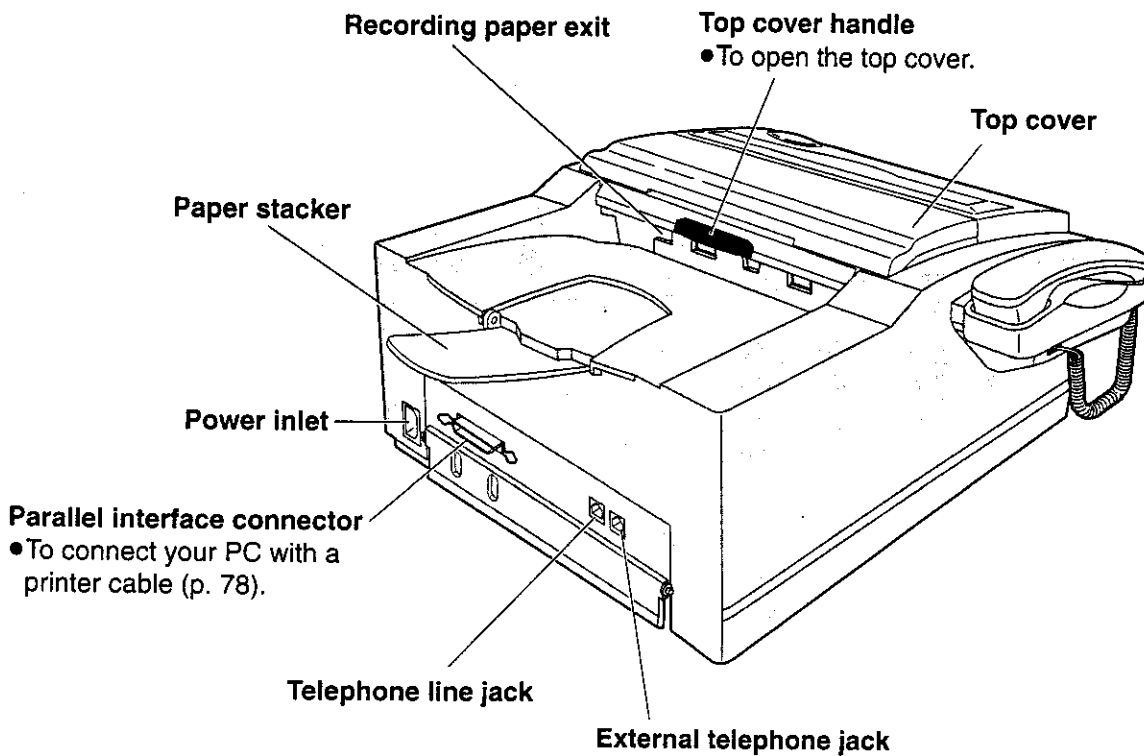

Finding the Controls

Location

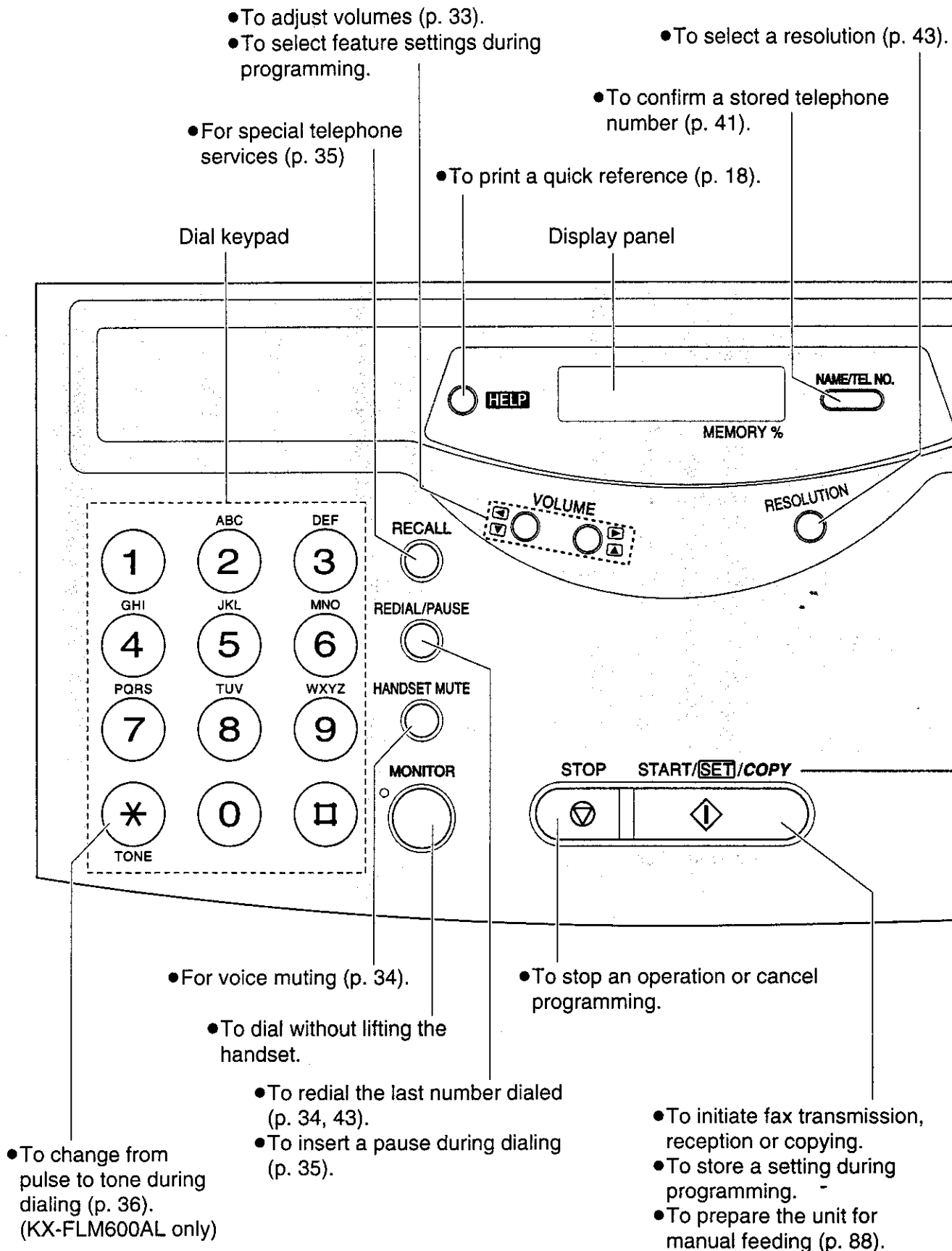

Finding the Controls

- For transmission to multiple stations (p. 51–53).

- For the One-Touch Dial (p. 37, 38, 44).
- Command keys (p. 31)

- To initiate or exit programming.

- To turn the AUTO ANSWER mode on/off (p. 56, 57).

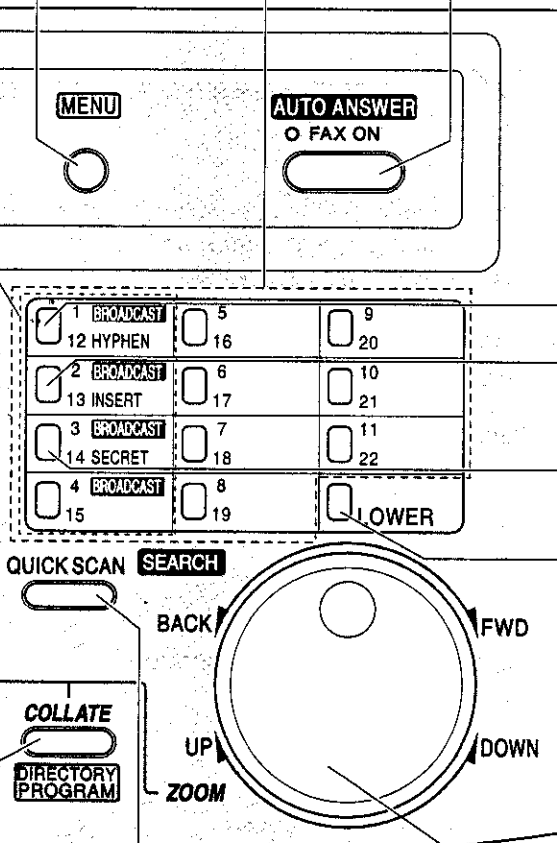

- To insert a hyphen (p. 31, 37).

- To insert one character or one space (p. 30, 31).

- To keep the telephone number secret (p. 37, 39).

- To select stations 12–22 for the One-Touch Dial (p. 37, 38, 44).

- To scan and store a document into memory, and then transmit or copy the stored document.

- To choose “Collated” or “Uncollated” in the copy mode (p. 76).

- To store or edit names and telephone numbers (p. 37, 39, 40, 51).

- To search for a stored name (p. 41, 45).

- To select characters during programming (p. 31).

- To select the basic features during programming (p. 136).

- To select an enlargement/reduction rate in the copy mode (p. 76, 77).

Setup

Before installation

Remove the shipping tape.

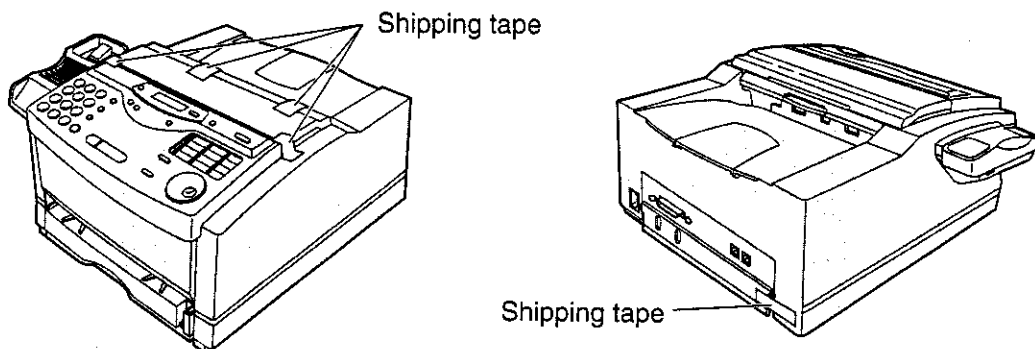

Toner cartridge and drum unit

Caution:

- If ingestion of toner occurs, drink several glasses of water to dilute stomach contents, and seek immediate medical treatment. If toner comes into contact with eyes, flush thoroughly with water, and seek medical treatment. If toner comes into contact with skin, wash thoroughly with soap and water.
 - Do not tip the toner cartridge on its end.
 - Do not open the protection bag until you have read the following instructions and are ready to install the drum unit. The drum unit contains a photosensitive drum. Exposing it to light may damage the drum.
- Once you have opened the protection bag:
- Do not expose the drum unit to light for more than 5 minutes.
 - Do not touch or scratch the green drum surface.
 - Do not place the drum unit near dust or dirt.
 - Do not place the drum unit in a high humidity area.
 - Do not expose the drum unit to direct sunlight.

Important:

- Keep the protection materials in case the fax machine must be repacked and transported.

- 1 Pull the top cover handle forward and open the top cover.

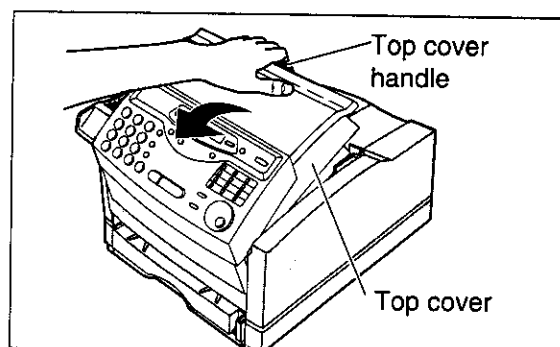

(continued)

- 2** Open the protection bag by cutting the end of the bag and remove the toner cartridge.

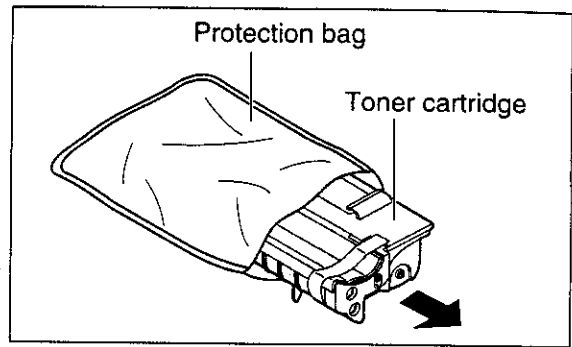

- 3** Remove the tape and remove the protection cap by holding the tab.

Caution:

- Do not touch the roller.
- Do not tip the toner cartridge on its end.

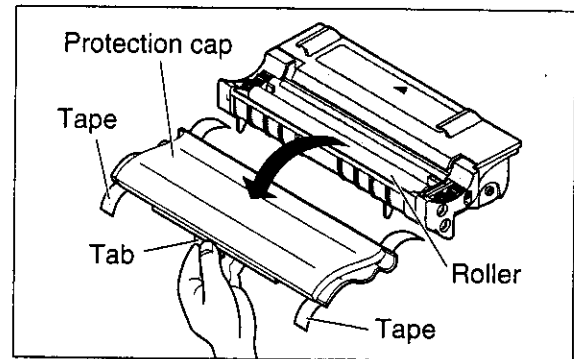
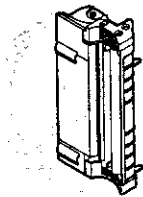

- 4** Carefully rock the toner cartridge from side to side several times.

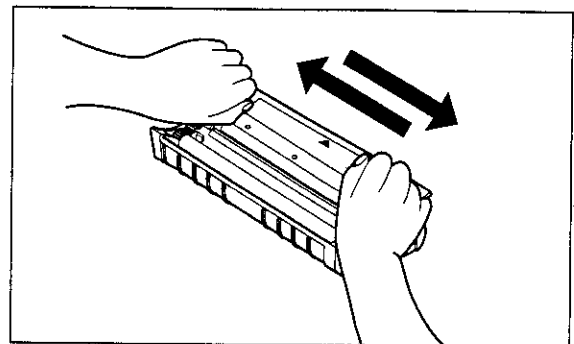

- 5** Install the toner cartridge, holding the two tabs and matching the triangles.

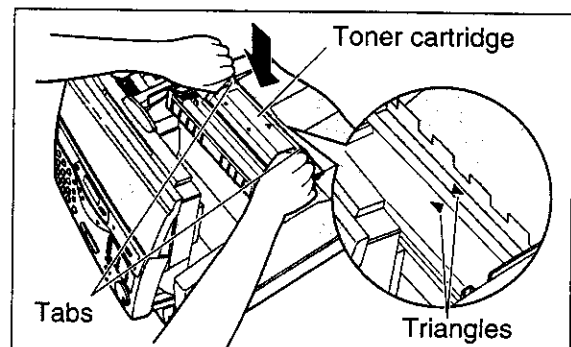

- 6** Open the protection bag by cutting the end of the bag, and remove the drum unit.

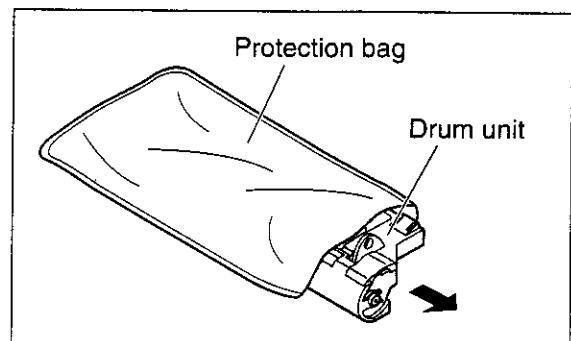

(continued)

Setup

- 7** Remove the tape and protection cap.

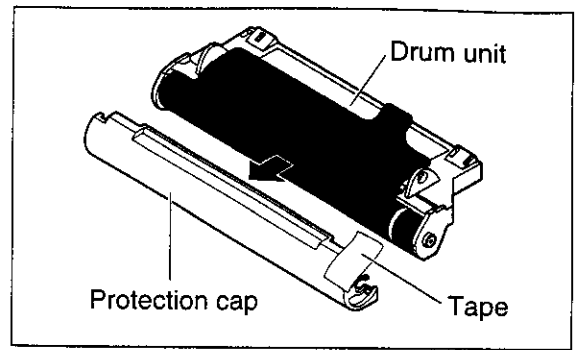

- 8** Remove the protection sheet.

Caution:

- Do not touch or scratch the green drum surface as this may damage the drum unit.
- Do not expose the drum unit to light for more than 5 minutes as this may damage the drum unit.

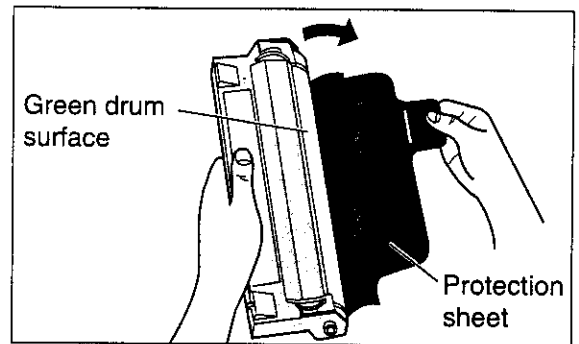

- 9** Install the drum unit on the toner cartridge, holding the two tabs and matching the triangles.

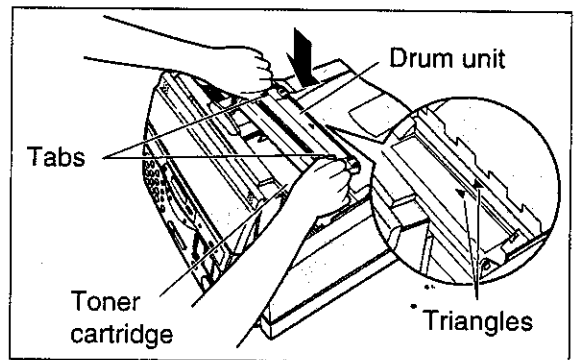

- 10** Close the top cover securely by pushing down on the dotted area at both ends.

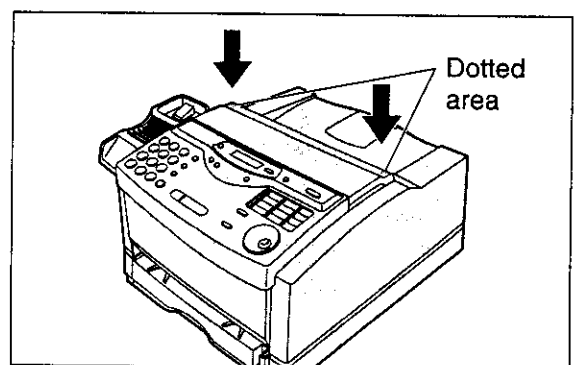

Recording paper

You can load A4 size paper in the paper cassette. The paper cassette can hold up to 250 sheets of 75 g/m² (20 lb.) paper. You can use 60 g/m² to 90 g/m² (16 lb. to 24 lb.) paper.

Loading paper in the paper cassette

- 1 Lift the paper cassette up slightly and pull it out of the unit.

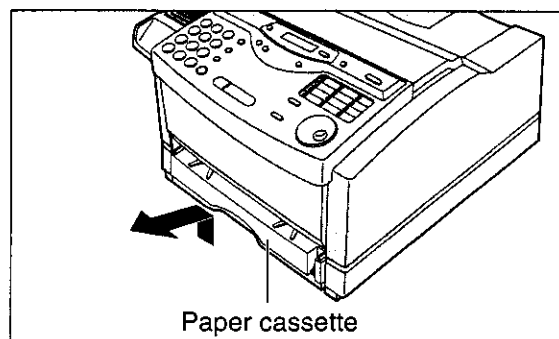

- 2 Fan the stack of paper to prevent a paper jam and place the paper into the paper cassette.

- Put the side to be printed face up.
- The height of the stack of paper should not exceed the upper limit on the paper cassette, or the paper may jam or multi-feed.

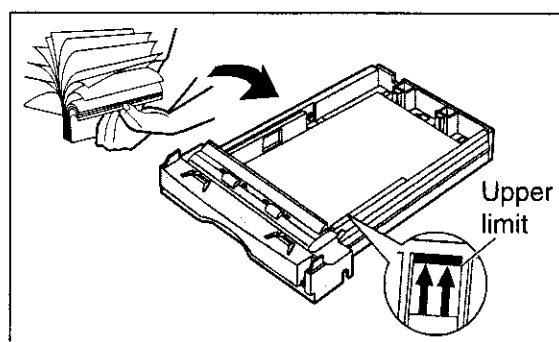

- 3 Insert the paper cassette into the unit until it clicks into place.

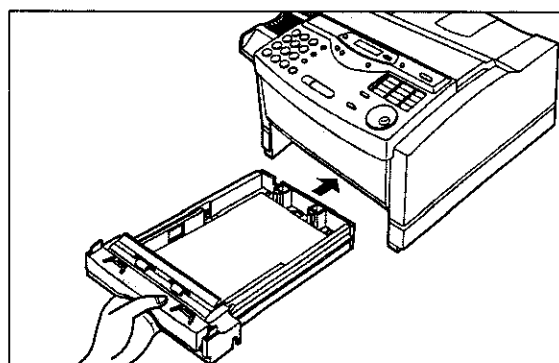

Note:

- Do not use different types or thicknesses of paper in the paper cassette at the same time. This may cause a paper jam.
- Avoid double-sided printing.
- Do not use paper printed from this unit for double-sided printing with other copiers or printers, or a paper jam may occur.

Setup

Checking the amount of remaining recording paper

You can see the amount of remaining paper without removing the paper cassette.

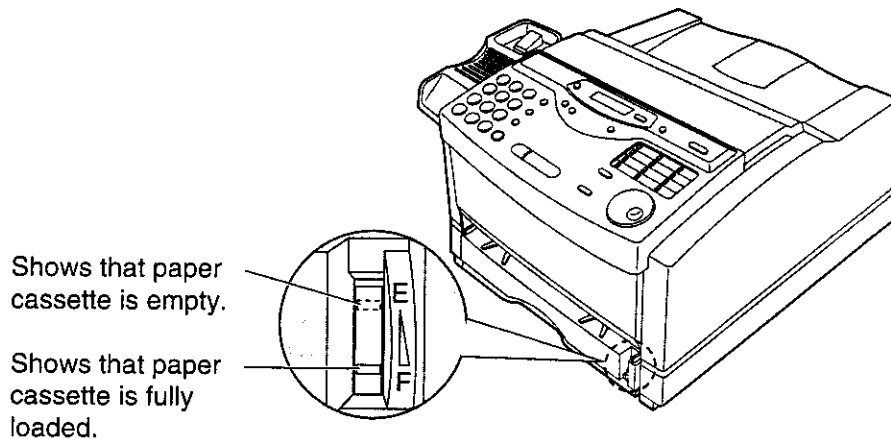

Types of paper to avoid

- Extremely smooth or shiny paper, or paper that is highly textured
- Coated papers
- Letterhead imprinted with low temperature or thermography. These materials may transfer onto the fusing roller and cause damage. Any pre-printed paper should use inks compatible with 200°C (392°F) for 0.1 second
- Damaged or wrinkled paper, or paper with irregularities such as tabs, staples, etc.
- Multipart forms or carbonless paper
- Paper with a cotton and/or fibre content over 25%
- Ink jet paper (It may transfer onto the fuser roller and cause damage.)

Paper tray

- 1 Insert the two tabs of the paper tray into the slots on the paper cassette.

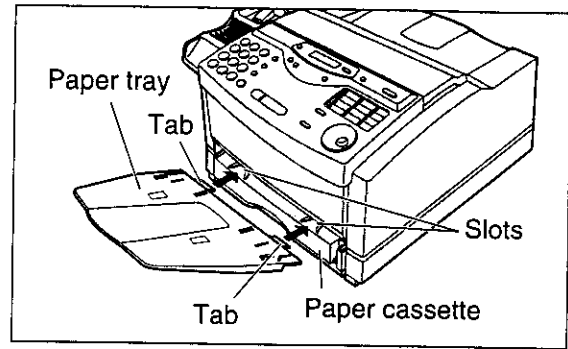

- 2 Open the paper tray extender by pressing on the area marked "▽".

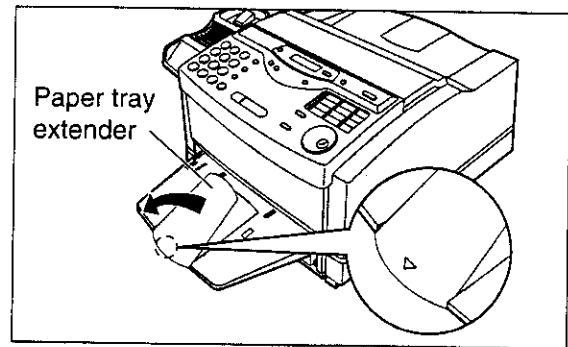

Paper stacker

- 1 Press the area marked "▽" on the paper stacker.

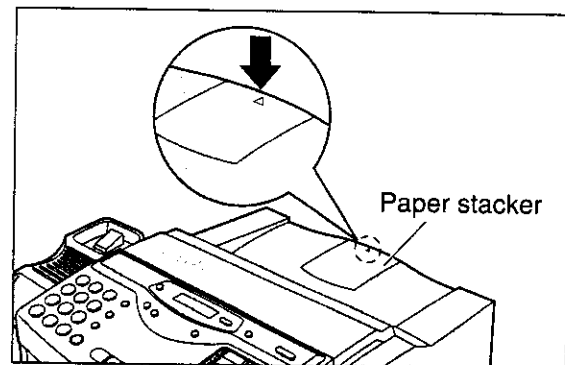

- 2 Open the paper stacker.

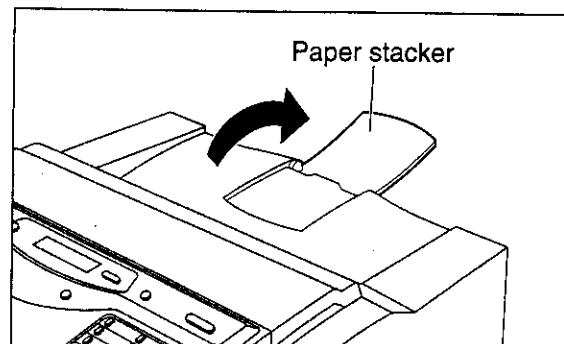

Setup

Connections

- 1 Connect the handset cord.
- 2 Connect the telephone line cord.
- 3 Connect the power cord.
 - When the power is turned on for the first time, the unit will eject the protection sheet and print some basic information.

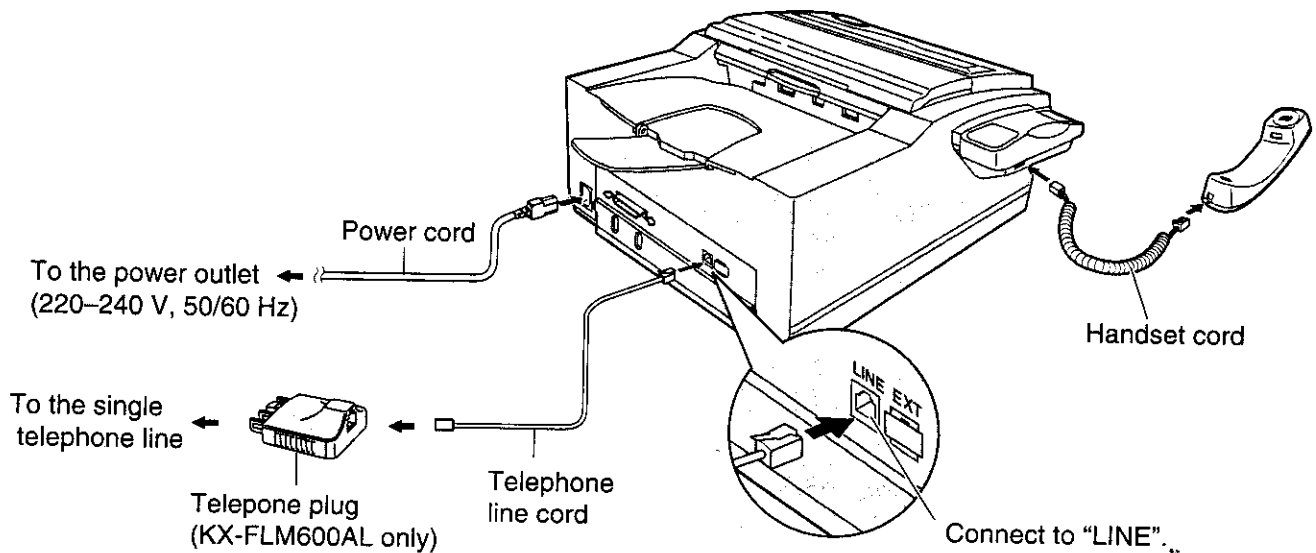

Note:

- When you operate this product, the power outlet should be near the product and easily accessible.
- If you want to connect a personal computer to the unit, see page 78.
- If you want to connect an answering machine to the unit, see page 63.

Helpful hints when using an extension telephone:

If you connect an extension telephone or answering machine to the facsimile unit, please take note of the following.

- When an extension telephone or answering machine is in use, the facsimile unit will show the following message on the display:

EXT. IN USE

When a call is received and you press **MONITOR** on the facsimile unit, the call is switched to the facsimile unit, and the external device will be disconnected.

- If no sound is heard when you lift the handset of the extension telephone, the facsimile unit is in use.
- In the TEL/FAX mode, only the facsimile unit will ring. You cannot answer a call with the extension telephone.

Date and time, your logo and facsimile telephone number

You should program the date and time, your logo and facsimile telephone number. This information will be printed on each page transmitted from your unit.

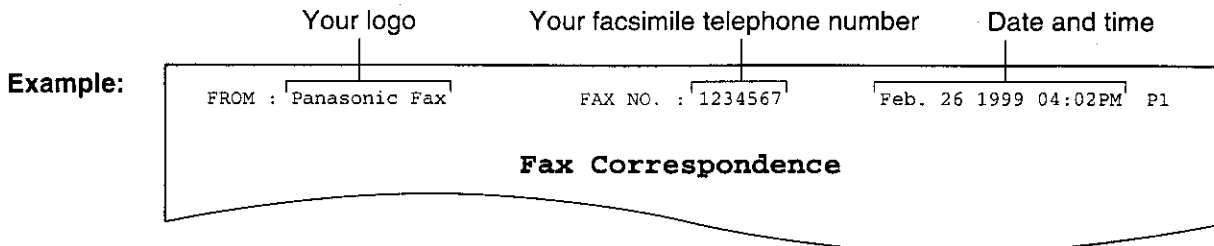

Setting the date and time

- 1 Press **MENU**.
Display: 1.SYSTEM SET UP
- 2 Press **#**, then **0 1**.
SET DATE & TIME
- 3 Press **START/SET/COPY**.
M:01/D:01/Y:99
Cursor
- 4 Enter the correct month/day/year by selecting each 2 digits using the dial keypad.
Example: Aug. 10, 1999
Press **08 10 99**.
M:08/D:10/Y:99
- 5 Press **START/SET/COPY**.
TIME: 12:00AM
- 6 Enter the correct hour/minute by selecting 2 digits for each using the dial keypad.
Press ***** to select "AM" or "PM".
Example: 3:15PM
1. Press **03 15**.
TIME: 03:15AM
2. Press ***** until "PM" is displayed.
TIME: 03:15PM
- 7 Press **START/SET/COPY**.
SETUP ITEM []
- 8 Press **MENU**.

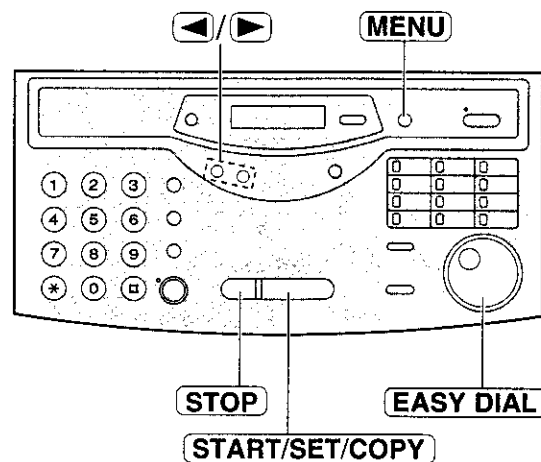

Note:

- To enter the year "2000" in step 4, press **00** for the correct year.
- You can enter the number by rotating **EASY DIAL** in steps 4 and 6. In this case, press **▶** to move the cursor.
- The accuracy of the clock is approximately ± 60 seconds a month.

To correct a mistake

- Press **◀** or **▶** to move the cursor to the incorrect number, then make the correction.
- If you press **STOP** while programming, the display will return to the previous one.

Setup

Setting your logo

The logo can be your company, division or name.

1 Press **MENU**.

Display: 1. SYSTEM SET UP

2 Press **#**, then **0 2**.

YOUR LOGO

3 Press **START/SET/COPY**.

LOGO=

4 Enter your logo, up to 30 characters, by using the dial keypad. See next page for details.

Example: Bill

1. Press **2** twice.

LOGO=B

Cursor

2. Press **4** six times.

LOGO=Bi

3. Press **5** six times.

LOGO=Bi

4. Press **▶** to move the cursor to the next space and press **5** six times.

LOGO=Bill

5 Press **START/SET/COPY**.

SETUP ITEM []

6 Press **MENU**.

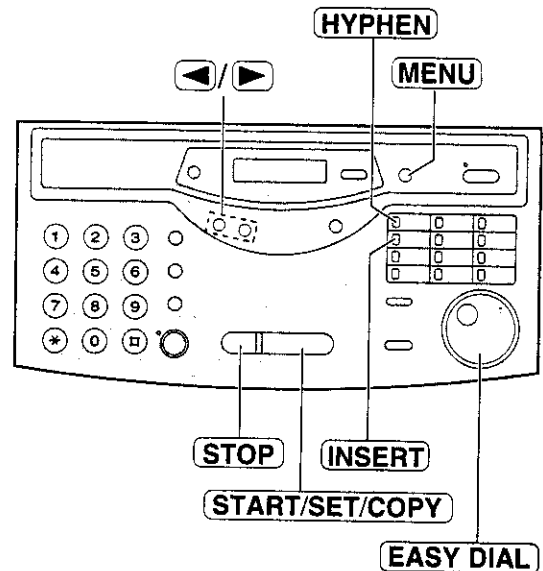

Note:

- You can enter your logo by rotating **EASY DIAL** (see next page).

To correct a mistake

- Press **◀** or **▶** to move the cursor to the incorrect character, and make the correction.

To delete a character





- Move the cursor to the character you want to delete and press **STOP**.

To insert a character

1. Press **◀** or **▶** to move the cursor to the right of where you want to insert the character.
2. Press **INSERT** (One-Touch Dial key 2) to insert a space and enter the character.

To select characters with the dial keypad

Pressing the dial keys will select a character as shown below.

Keys	Characters
①	1 [] { } + - / = , . _ ' : ; ?
②	A B C a b c 2
③	D E F d e f 3
④	G H I g h i 4
⑤	J K L j k l 5
⑥	M N O m n o 6
⑦	P Q R S p q r s 7
⑧	T U V t u v 8
⑨	W X Y Z w x y z 9
⑩	0 () < > ! " # \$ % & ¥ * @ ^ ' →
	HYPHEN key (To insert a hyphen.)
	INSERT key (To insert one character or one space.)
STOP	Delete key (To delete a character.)
	◀ key (To move the cursor to the left.)
	▶ key (To move the cursor to the right.) To enter another character using the same number key, move the cursor to the next space.

To select characters using the EASY DIAL

Instead of pressing the dial keys, you can select characters using the EASY DIAL.

1. Rotate **EASY DIAL** until the desired character is displayed.
2. Press  to move the cursor to the next space.
• The character displayed in step 1 is inserted.
3. Return to step 1 to enter the next character.

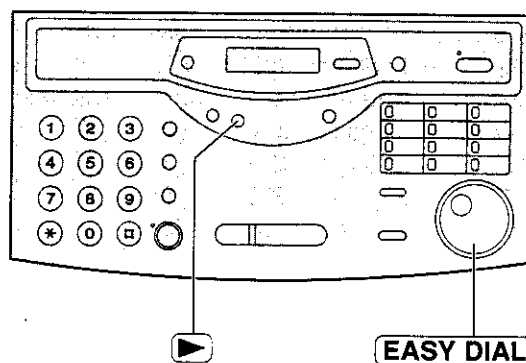

Display order of characters

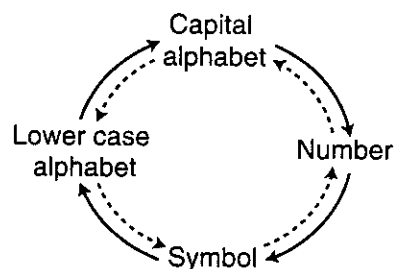

- : Rotating to the right
- : Rotating to the left

Setup

Setting your facsimile telephone number

- 1 Press **MENU**.
Display: 1. SYSTEM SET UP
- 2 Press **#**, then **0 3**.
YOUR FAX NO.
- 3 Press **START/SET/COPY**.
NO. =
- 4 Enter your facsimile telephone number up to 20 digits using the dial keypad.
Example: NO. = 1234567
- 5 Press **START/SET/COPY**.
SETUP ITEM []
- 6 Press **MENU**.

Note:

- You can enter your facsimile telephone number by rotating **EASY DIAL**. If using **EASY DIAL**, press **▶** to move the cursor.
- The ***** button replaces the digit with a "+" and the **#** button replaces it with a space.

Example (using the dial keypad): +234 5678
Press *** 2 3 4 # 5 6 7 8**.

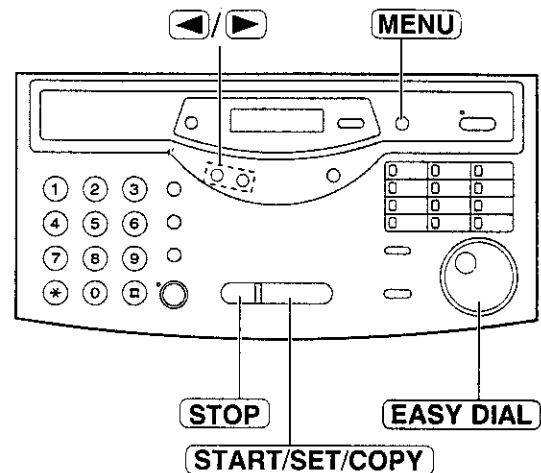

To correct a mistake

- Press **◀** or **▶** to move the cursor to the incorrect number, and make the correction.

To delete a number

- Move the cursor to the number you want to delete and press **STOP**.

Recording paper size

Set the size of recording paper depending on the paper you load in the paper cassette and the printer driver setting of PC software (p. 94).

This setting is used when the unit determines the reduction rate for incoming faxes.

The following choices are available.

A4: 210 mm × 297 mm (8¹/₄" × 11¹¹/₁₆") (pre-selected setting)

LETTER: 216 mm × 279 mm (8¹/₂" × 11")

LEGAL: 216 mm × 356 mm (8¹/₂" × 14")

- 1 Press **MENU**.
Display: 1. SYSTEM SET UP
- 2 Press **#**, then **1 6**.
PAPER SIZE
- 3 Press **START/SET/COPY**.
=A4 ▼▲
- 4 Press ▼ or ▲ to select the size of paper you load.
- 5 Press **START/SET/COPY**.
SETUP ITEM []

- 6 Press **MENU**.

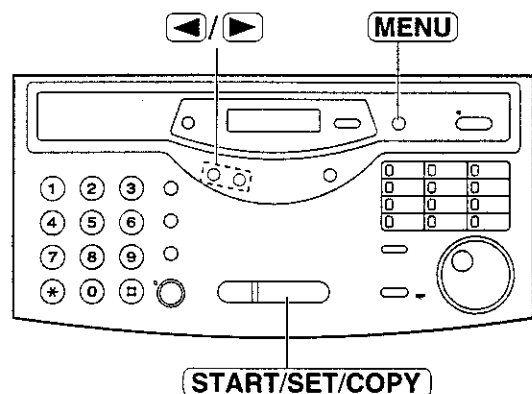

Adjusting volumes

Ringer volume

4 levels (high/middle/low/off) are available.

While the unit is idle, press ▼ or ▲.

■ **To turn the ringer off:**

1. Press ▼ repeatedly until the following message is displayed.

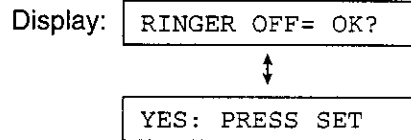

2. Press **START/SET/COPY**.

• To turn the ringer back on, press ▲.

■ **While the ringer volume is set to off:**

The display will show the following message.

RINGER OFF

When a call is received, the unit will not ring and will display the following.

INCOMING CALL

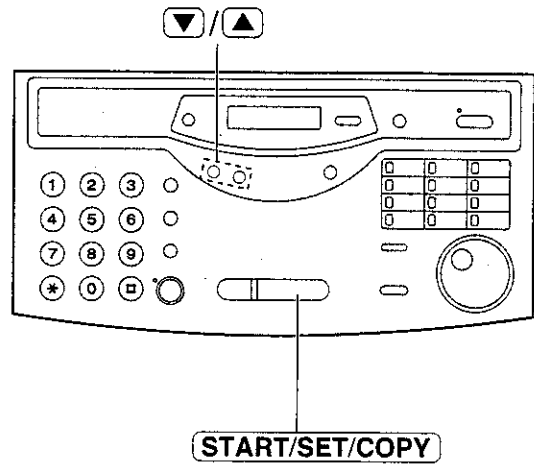

Monitor volume

8 levels (high to low) are available.

While using the monitor, press ▼ or ▲.

Making and Answering Calls

Voice calls - making

- 1 Press **MONITOR** or lift the handset.

Display: TEL=

- 2 Dial the telephone number.

Example: TEL=2345678

- If you misdial, hang up and dial again.

- 3 When the other party answers, talk into the handset.

- 4 When finished talking, replace the handset.

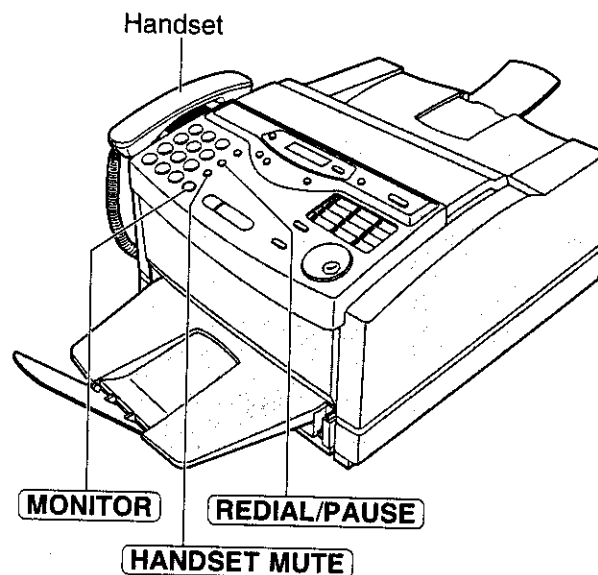

Voice calls - answering

- 1 When the unit rings, lift the handset.

- 2 When finished talking, replace the handset.

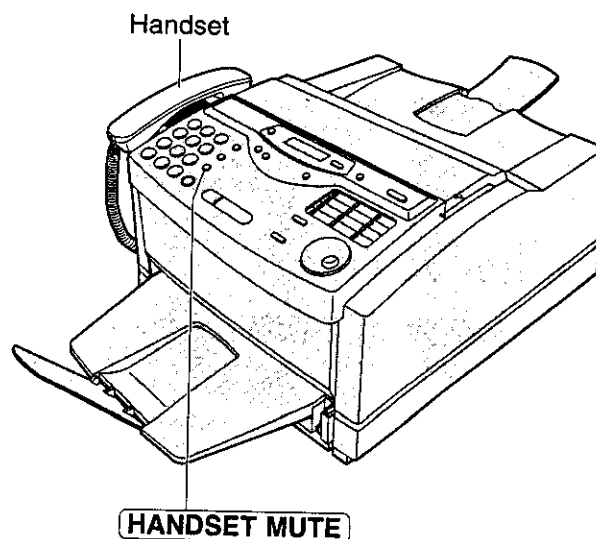

To redial the last number

1. Press **MONITOR** or lift the handset.
2. Press **REDIAL/PAUSE**.
3. When the other party answers, talk into the handset.
 - If the line is busy when using the **MONITOR** button, the unit will automatically redial the number once (KX-FLM600NZ only).
 - During redial, the following will be displayed (KX-FLM600NZ only).

Display: WAITING REDIAL

To mute your voice to the other party

1. Press **HANDSET MUTE** during a telephone conversation using the handset.

Display: <MUTE>

- The other party cannot hear you, but you can hear them.

2. To resume the conversation, press **HANDSET MUTE** again.

RECALL and PAUSE buttons

RECALL button

The **RECALL** button functions as the hookswitch on a regular telephone. If you misdial a telephone number, press the **RECALL** button firmly.

The **RECALL** button also allows you to use special features of a host exchange (if connected) or local telephone company services such as call waiting. For further details, contact your host exchange supplier or local telephone company.

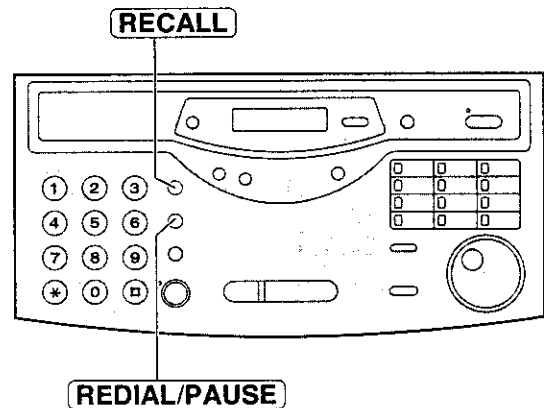

Telephone

Entering pauses

When the **REDIAL/PAUSE** button is pressed during dialing, a pause will be inserted. Pressing **REDIAL/PAUSE** once creates a 3 second pause.

Example 1:

If your unit is connected to a host exchange, insert a pause to get an outside line.

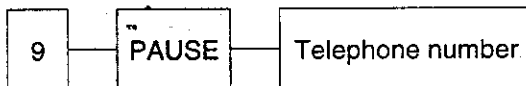

Line access code

Example 2:

If a transmission error occurs during an overseas transmission, add two pauses at the end of the telephone number.

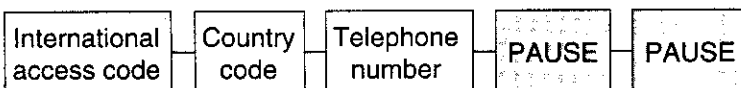

Note:

- **RECALL** and **PAUSE** can be stored into a telephone number in the One-Touch Dial and the EASY DIAL directory.

Making and Answering Calls

Dialing mode (KX-FLM600AL only) (touch tone or pulse)

If your private exchange (PBX) does not support "TONE" dialing, you can change to "PULSE" dialing. This feature is set to "TONE" as a pre-selected setting.

- 1 Press **MENU**.
Display: 1.SYSTEM SET UP
- 2 Press **#**, then **1 3**.
DIALING MODE
- 3 Press **START/SET/COPY**.
MODE=TONE ▼▲
- 4 Press ▼ or ▲ to select the desired setting.
- 5 Press **START/SET/COPY**.
SETUP ITEM []
- 6 Press **MENU**.

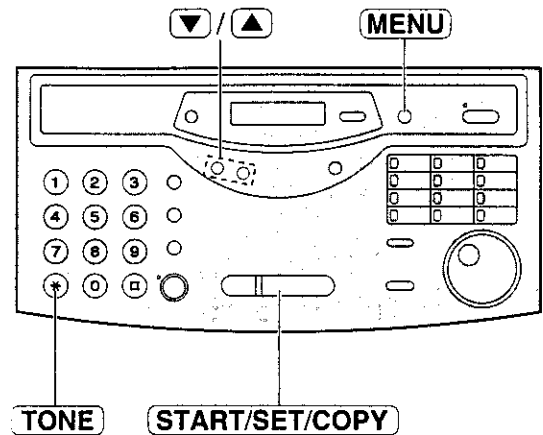

Note:

- The **TONE** (*) button is used for rotary pulse dial services and allows you to temporarily change from the pulse to tone mode during a dialing operation. When you hang up, the unit will automatically return to the pulse mode.

Setting the melody ringer

You can choose from 3 melody rings (A, B or C).

- 1 Press **MENU**.
Display: 1.SYSTEM SET UP
- 2 Press **#**, then **7 1**.
MELODY RINGER
- 3 Press **START/SET/COPY**.
MODE=A ▼▲
- 4 Press ▼ or ▲ to select the desired setting.
•Each time the selected setting is changed, the selected melody ring will be played.
- 5 Press **START/SET/COPY**.
SETUP ITEM []
- 6 Press **MENU**.

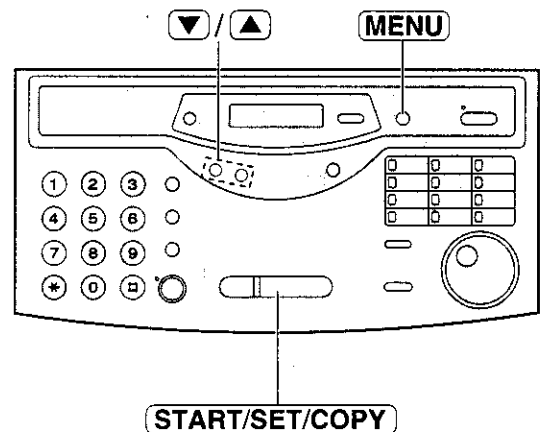

Storing names and telephone numbers in the One-Touch Dial

The unit's memory allows you to use the One-Touch Dial for rapid access to your most frequently dialed numbers. 22 stations are available.

- One-Touch Dial keys 1 to 4 can be used as One-Touch Dial keys (DIAL MODE) or as broadcast keys (BROADCAST). These functions cannot be used at the same time. For the broadcast function, see pages 51 to 53.

1 Press **DIRECTORY PROGRAM**.

Display: **PRESS STATION**
↓
OR USE EASYDIAL

2 For stations 1-4
Press one of the One-Touch Dial keys.
Select the following by pressing **▼**.

DIAL MODE ▼▲

Press **START/SET/COPY** to go to the next prompt.

For stations 5-11
Press one of the One-Touch Dial keys.

For stations 12-22
Press **LOWER**, then press one of the One-Touch Dial keys.

3 Enter the station name, up to 10 characters, following the instructions on page 31.

Example: **NAME=John**

4 Press **START/SET/COPY**.

Example: **<S02>=**

5 Enter the telephone number up to 30 digits.
• If you want to enter a hyphen, press **HYPHEN** (One-Touch Dial key 1).

Example: **<S02>=111-4497**

6 Press **START/SET/COPY**.

REGISTERED
↓
PRESS STATION
↓
OR USE EASYDIAL

- To program other stations, repeat steps 2 to 6.

7 Press **DIRECTORY PROGRAM** to exit the program.

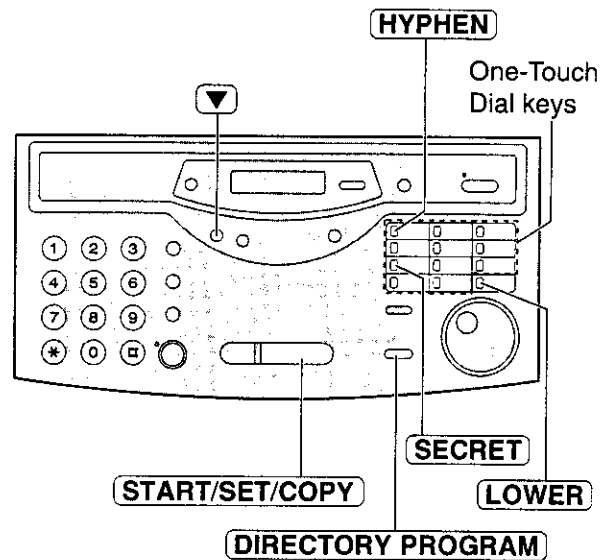

Telephone

Helpful hint:

- You can confirm the stored items on the display (p. 41), or on the telephone number list (p. 129).

Note:

- A hyphen entered in a telephone number counts as two digits.

To keep a telephone number secret

Press **SECRET** (One-Touch Dial key 3) after entering the telephone number in step 5.

- A secret number cannot be viewed if this is set.
- The telephone number will not appear on the telephone number list.
- Pressing **SECRET** does not count as a digit.

To edit a stored station name and number

Enter the desired name in step 3.

Enter the desired number in step 5.

To erase a stored station name and number, see page 40.

One-Touch Dial

Making a voice call using the One-Touch Dial

Before using this feature, program the desired names and telephone numbers into the One-Touch Dial (p. 37).

- 1 Press **MONITOR** or lift the handset.

Display:

- Check that there are no documents in the document feeder tray.

- 2 **For stations 1–11**
Press the desired One-Touch Dial key.

For stations 12–22

Press **LOWER**, then press the desired One-Touch Dial key.

Example:

- 3 When the other party answers, talk into the handset.

- 4 When finished talking, replace the handset.

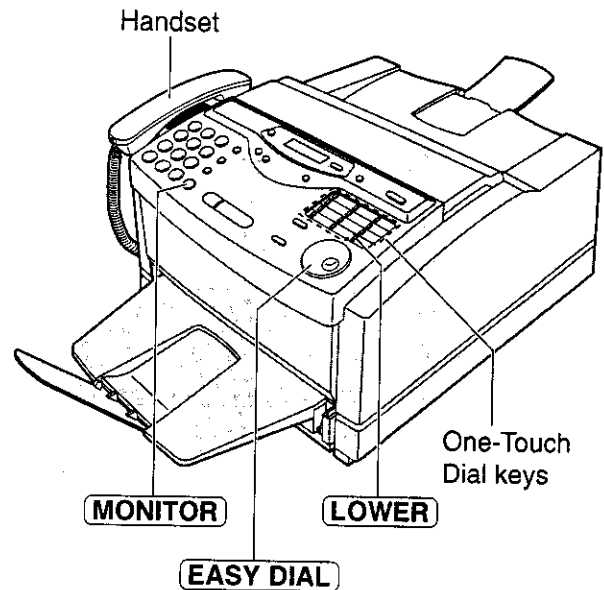

Helpful hints:

- You can confirm the stored items on the display (p. 41), or on the telephone number list (p. 129).
- You can use the EASY DIAL directory to select the station name instead of using the One-Touch Dial keys. Rotate **EASY DIAL** until the desired name is displayed, then press **MONITOR** or lift the handset.

Storing names and telephone numbers in the EASY DIAL directory

For rapid access to frequently dialed numbers, the unit also provides an EASY DIAL directory (100 stations) in addition to the One-Touch Dial.

1 Press **DIRECTORY PROGRAM**.

Display:
 ↓

2 Rotate **EASY DIAL** until the following is displayed.

3 Enter the name, up to 10 characters, following the instructions on page 31.

Example:

4 Press **START/SET/COPY**.

5 Enter the telephone number, up to 30 digits.
 •To enter a hyphen in a telephone number, press **HYPHEN** (One-Touch Dial key 1).

Example:

6 Press **START/SET/COPY**.

↓

•To program other items, repeat steps 3 to 6.

7 Press **DIRECTORY PROGRAM** to exit the program.

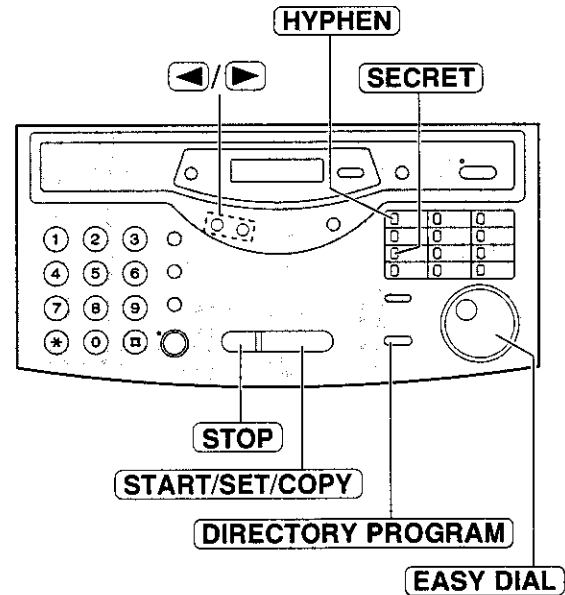

Telephone

Note:

- You can confirm the stored items on the display (p. 41), or on the telephone number list (p. 129).
- You can store items during a telephone conversation.
- When the following message is displayed in step 6, you can only store 5 more items.

Display:

- If the unit shows "EASY DIAL FULL" in step 1, there is no space to store new stations. Edit or erase unnecessary stations (p. 40).
- A hyphen entered in a telephone number counts as two digits.

To correct a mistake

- Press **◀** or **▶** to move the cursor to the incorrect character, then make the correction.

To delete a character or number

- Move the cursor to the character or number you want to delete and press **STOP**.

To keep a telephone number secret

Press **SECRET** (One-Touch Dial key 3) after entering the telephone number in step 5.

- A secret number cannot be viewed if this is set.
- The telephone number will not appear on the telephone number list.
- Pressing **SECRET** does not count as a digit.

EASY DIAL

Editing a stored name and number

- 1 Rotate **EASY DIAL** until the desired name is displayed.

Example:

- 2 Press **DIRECTORY PROGRAM**.

- 3 Press ***** to select "EDIT".

• If you do not need to edit the name, go to step 5.

- 4 Edit the name by following the instructions on page 31.

- 5 Press **START/SET/COPY**.

Example:

• If you do not need to edit the telephone number, go to step 7.

- 6 Edit the telephone number. For further details, see page 39.

- 7 Press **START/SET/COPY**.

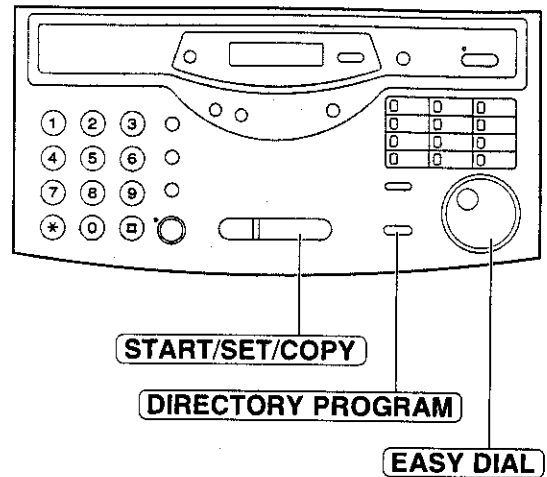

Erasing a stored name and number

You can erase a name and number stored in the One-Touch Dial and EASY DIAL directory.

- 1 Rotate **EASY DIAL** until the desired name is displayed.

Example:

- 2 Press **DIRECTORY PROGRAM**.

- 3 Press **#** to select "DELETE".



• If you do not want to erase the item, press **STOP**.

- 4 Press **START/SET/COPY**.

• The stored name and number are deleted.

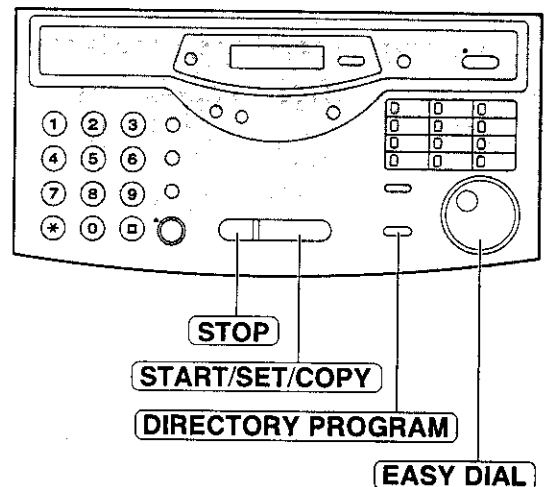

Making a voice call using the EASY DIAL directory

Before using this feature, program the desired names and telephone numbers into the directory (p. 39).

- 1 Rotate **EASY DIAL** until the desired name is displayed.

Example:

- 2 Press **MONITOR** or lift the handset.
 - The unit will start dialing automatically.

- 3 When the other party answers, talk into the handset.

- 4 When finished talking, replace the handset.

Helpful hint:

- You can confirm the stored items on the display (see below) or on the telephone number list (p. 129).

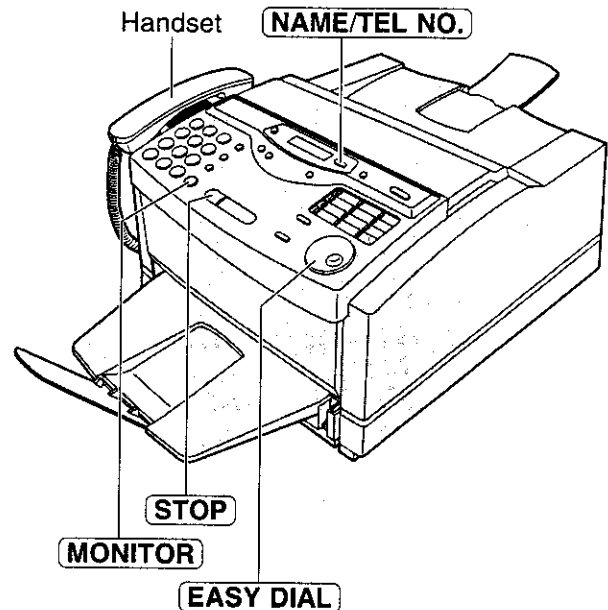

Telephone

Note:

- If the desired name has not been stored, press **STOP** and dial the number manually.
- If the names and telephone numbers are stored in the One-Touch Dial (p. 37), the station numbers will be shown on the right side of the display.

Example:

To confirm the stored items on the display

1. Rotate **EASY DIAL** until the desired name is displayed.

Example:

2. Press **NAME/TEL NO.**.

- To stop the operation, press **STOP**.

3. Press **MONITOR** or lift the handset, and the unit will automatically dial the number.

To search for a name by initial

Example: If you want to search for the name "Lisa"

1. Rotate **EASY DIAL** until any name is displayed.

Example:

2. Press **5** repeatedly until any name with the initial "L" is displayed (see the character table on page 31).

3. Rotate **EASY DIAL** to the right until "Lisa" is displayed.

- To stop the operation, press **STOP**.

4. Press **MONITOR** or lift the handset.
 - The unit will automatically dial the number.

Note:

- When you want to search for symbols (not letters or numbers), press ***** in step 2.

Voice Contact

Talking to the caller after fax transmission or reception

You can talk to the other party after a fax message is completed. This will save the added expense and time of making another call.

This feature only works when the other party's fax machine is equipped with a voice contact feature.

Initiating voice contact

- 1 Press **MONITOR** while transmitting or receiving documents.

Display: **VOICE STANDBY**

- Your unit will call the other party with a distinctive ring.
- When the other party answers, your unit will emit a distinctive ring.

- 2 Lift the handset to start talking.

Note:

- If you initiate voice contact during transmission, the unit will call you with a distinctive ring after all the documents have been transmitted.
- If you initiate voice contact during reception, the unit will call you with a distinctive ring after the current page of the document is received.

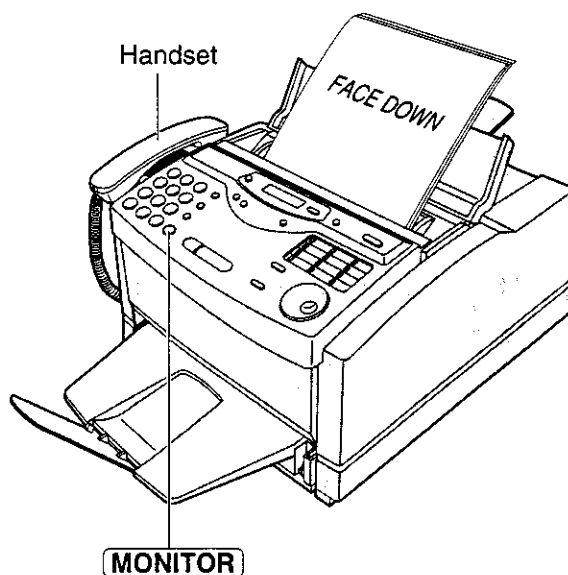

Receiving a request for voice contact

- 1 If the other party initiates voice contact, your unit will sound a distinctive ring and the following will be displayed.

Display: **PLEASE PICK UP**

- 2 Lift the handset within 10 seconds of the distinctive ring to start talking.

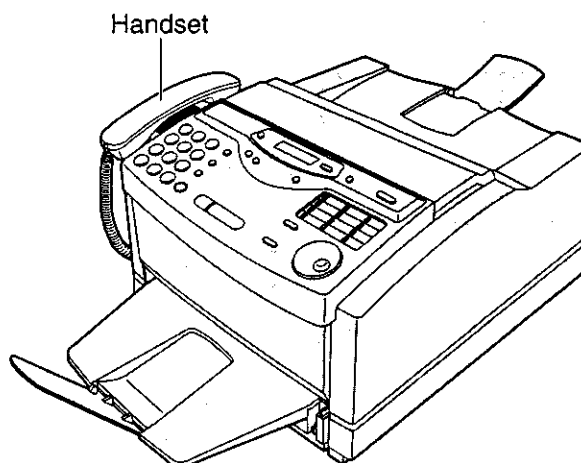

Sending a fax manually

- 1** Open the document feeder tray.
- 2** Adjust the width of the document guides to the size of the document.
- 3** Insert the document (up to 15 pages) **FACE DOWN** until the unit grabs the document and a single beep is heard.

Display: STANDARD

- 4** If necessary, press **RESOLUTION** repeatedly to select the desired setting (see below).
- 5** Press **MONITOR** or lift the handset. (This step is optional. See note.)

TEL=

- 6** Dial the fax number.

Example: TEL=5678901

- 7** **When a fax tone is heard:**
Press **START/SET/COPY**, and replace the handset if using it.
OR

When the other party answers your call:
Lift the handset if using the monitor and ask them to press their start button. When a fax tone is heard, press your **START/SET/COPY** and replace the handset.

CONNECTING.....

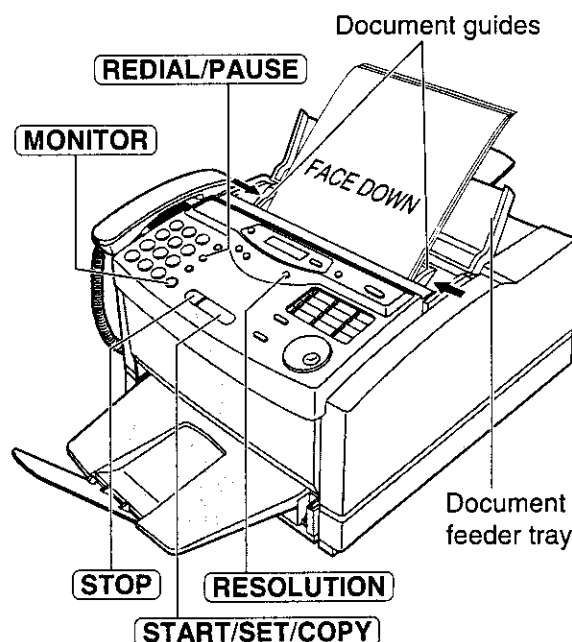

Fax/Copy

Note:

- While scanning, do not move the pages which have already been ejected. A paper jam may occur. Allow the scanning process to finish before viewing documents.
- **If you cannot send a fax**, confirm the problem by printing a journal report (p. 129) and see page 109 to solve the problem.
- Performing step 5 allows you to identify any possible problems in sending a fax. For the parties with whom you have experienced no problems, you can skip step 5. Dial the fax number and press **START/SET/COPY**.
- If the other party's fax number is written on the document, you can enter the number by referring to the document before inserting it.

To feed more than 15 pages at a time

Insert the first 15 pages of the document. Add the extra pages (up to 15) before the last page is fed into the unit.

To redial the last number

Press **REDIAL/PAUSE**.

- If the line is busy, the unit will automatically redial the number up to 2 times.
- During redial, the following will be displayed.

Display: WAITING REDIAL

To stop transmission

Press **STOP**.

To eject the document, press **STOP** again.

To select the resolution

Select the desired resolution according to the type of document.

STANDARD: For printed or typewritten originals with normal-sized characters.

FINE: For originals with small printing.

SUPER FINE: For originals with minute printing.

HALF TONE: For originals containing photographs, shaded drawings, etc.

- Using the fine, super fine or half tone setting will increase the transmission time.
- If the resolution setting is changed during feeding, it will be effective from the next sheet.
- The super fine resolution only works with other compatible fax machines.

Sending Faxes

Sending a fax using the One-Touch Dial

Before using this feature, program the desired names and telephone numbers into the One-Touch Dial (p. 37).

- 1 Open the document feeder tray.
- 2 Adjust the width of the document guides to the size of the document.
- 3 Insert the document (up to 15 pages) FACE DOWN until the unit grabs the document and a single beep is heard.

Display:

- 4 If necessary, press **RESOLUTION** repeatedly to select the desired setting (p. 43).
- 5 For stations 1–11
Press the desired One-Touch Dial key.

For stations 12–22

Press **LOWER**, then press the desired One-Touch Dial key.

Example:
↓

- The unit will start transmission.

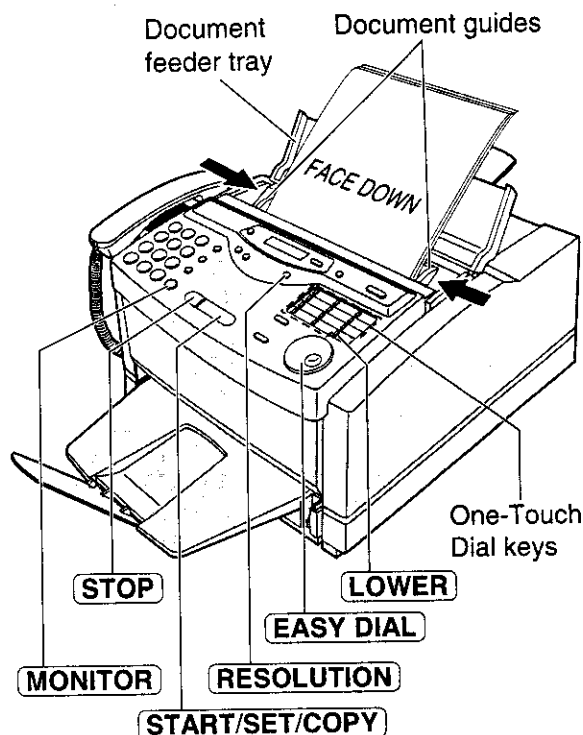

Helpful hints:

- You can confirm the stored items on the display (p. 41), or on the telephone number list (p. 129).
- You can use the EASY DIAL directory to select the station name instead of using the One-Touch Dial keys. Rotate **EASY DIAL** until the desired name is displayed, then press **START/SET/COPY**.
- The connecting tone will be heard during dialing to tell you the status of the other party's machine (p. 55).

Note:

- While scanning, do not move the pages which have already been ejected. A paper jam may occur. Allow the scanning process to finish before viewing documents.

Fax auto redial

If the line is busy or there is no answer, the unit will automatically redial the number up to 2 times.

- This feature is also available for;
—sending faxes using the EASY DIAL directory (p. 45), and
—delayed transmission (p. 49).
- During redial, the following will be displayed.

Display:

- To cancel redialing, press **STOP**.

If your unit cannot send a fax

Verify that the number dialed is answered by the other party's machine.

1. Press **MONITOR**.
2. For stations 1–11
Press the desired One-Touch Dial key.
For stations 12–22
Press **LOWER** then press the desired One-Touch Dial key.

Sending a fax using the EASY DIAL directory

Before using this feature, program the desired names and telephone numbers into the directory (p. 39).

- 1 Open the document feeder tray.
- 2 Adjust the width of the document guides to the size of the document.
- 3 Insert the document (up to 15 pages) FACE DOWN until the unit grabs the document and a single beep is heard.

Display:

- 4 If necessary, press **RESOLUTION** repeatedly to select the desired setting (p. 43).
- 5 Rotate **EASY DIAL** until the desired name is displayed.

Example:

- To confirm the number, press **NAME/TEL NO.**

- 6 Press **START/SET/COPY**.

↓

- The unit will start transmission.

Helpful hints:

- You can confirm the stored items on the display (p. 41) or on the telephone number list (p. 129).
- The connecting tone will be heard during dialing to tell you the status of the other party's machine (p. 55).

Note:

- While scanning, do not move the pages which have already been ejected. A paper jam may occur. Allow the scanning process to finish before viewing documents.
- If the desired name has not been stored, press **STOP** and dial the number manually.
- For further details about using the EASY DIAL, see page 41.

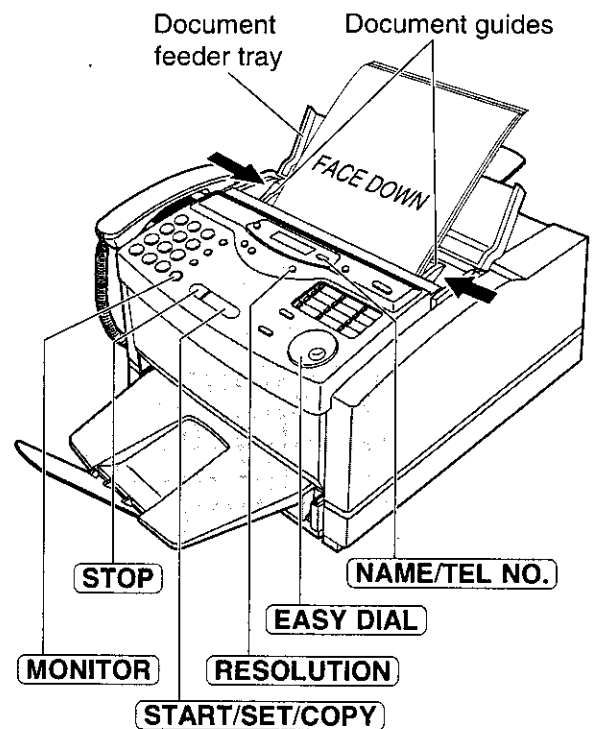

If your unit cannot send a fax

Verify that the number dialed is answered by the other party's machine.

1. Rotate **EASY DIAL** until the desired name is displayed.
2. Press **MONITOR**.

Sending Faxes

Documents you can send

Minimum size

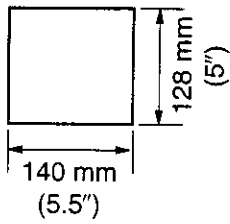

Maximum size

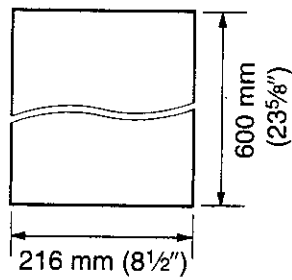

Effective scanning area

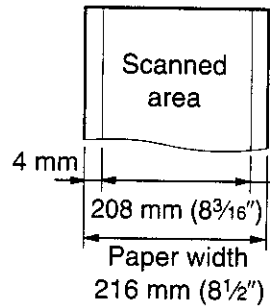

Document weight

Single sheet:
45 g/m² to 90 g/m²
(12 lb. to 24 lb.)

Multiple sheets:
60 g/m² to 75 g/m²
(16 lb. to 20 lb.)

Note:

- Remove clips, staples or other similar fastening objects.
- Check that ink, paste or correction fluid has dried.
- Do not send the following types of document. Use copies for fax transmission.
 - Chemically treated paper such as carbon or carbonless duplicating paper
 - Electrostatically-charged paper
 - Heavily curled, creased or torn paper
 - Paper with a coated surface
 - Paper with a faint image
 - Paper with printing on the opposite side that can be seen through the front (e.g. newspaper)

Sending report for confirmation

The sending report will provide you with a printed record of the fax transmission results. One of the following choices is available.

- ERROR:** The sending report will print out only when fax transmission fails (pre-selected setting).
- ON:** The sending report will always print out, indicating whether fax transmission is successful or not.
- OFF:** The sending report will not print.

- 1** Press **MENU**.

Display: 1.SYSTEM SET UP
- 2** Press **#**, then **0** **4**.

SENDING REPORT
- 3** Press **START/SET/COPY**.

MODE=ERROR ▼▲
- 4** Press ▼ or ▲ to select the desired setting.
- 5** Press **START/SET/COPY**.

SETUP ITEM []
- 6** Press **MENU**.

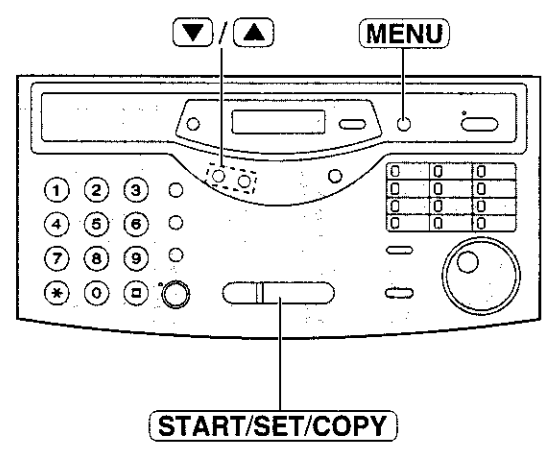

Fax/Copy

Sample of a sending report

SENDING REPORT		Jan. 20 1999 01:19PM						
		YOUR LOGO		:Bill				
		YOUR FAX NO.		:1234567				
NO.	OTHER FACSIMILE	START TIME	USAGE TIME	MODE	PAGES	RESULT	*CODE	
01	2345678	Jan. 20 01:18PM	00'51	SND	00	COMMUNICATION ERROR	43	

Communication message (p. 109)

Error code (for service personnel use only)

Sending Faxes

Automatic journal report

This feature prints a journal report automatically after every 35 new fax communications. After printing, only the oldest communication result will be erased when a new communication occurs. If this feature is deactivated, the unit will store the records of the fax communications, but will not print the journal report automatically.

- 1 Press **MENU**.
Display: 1. SYSTEM SET UP
- 2 Press **#**, then **2 2**.
AUTO JOURNAL
- 3 Press **START/SET/COPY**.
MODE=ON ▼▲
- 4 Press ▼ or ▲ to select the desired setting.
•If this feature is not required, select "OFF".
- 5 Press **START/SET/COPY**.
SETUP ITEM []
- 6 Press **MENU**.

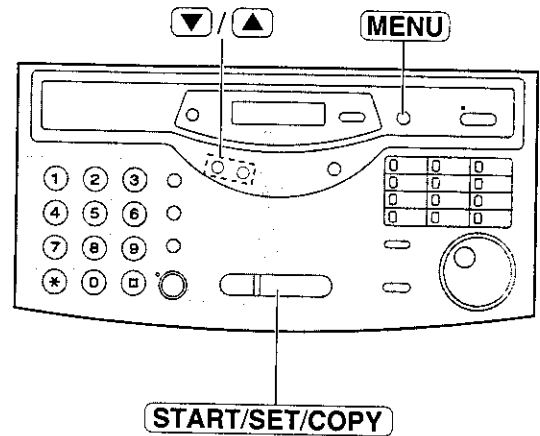

Sample of a journal report

JOURNAL							
Jan. 25 1999 05:22PM							
YOUR LOGO :Bill							
YOUR FAX NO. :1234567							
NO.	OTHER FACSIMILE	START TIME	USAGE TIME	MODE	PAGES	RESULT	*CODE
01	3332222	Jan. 21 02:14PM	00'45	SND	01	OK	
02	9998765	Jan. 21 03:17PM	00'58	SND	02	OK	
03	John	Jan. 21 05:18PM	00'48	RCV	01	OK	
04	555556677	Jan. 22 10:35AM	02'45	SND	03	COMMUNICATION ERROR	43
05				SND	05	OK	
06				RCV	03	OK	

Communication message (p. 109) Error code (for service personnel use only)

Note:

- You can also print a journal report manually (p. 129).

Delayed transmission (sending a fax at a specified time)

Using a built-in clock, this unit can send documents automatically at a specified time. This allows you to take advantage of low-cost calling hours offered by your telephone company. The delayed transmission can be reserved to take place up to 24 hours in advance.

- 1 Insert the document **FACE DOWN** until the unit grabs the document and a single beep is heard.

Display: STANDARD

- 2 Press **MENU**.

1.SYSTEM SET UP

- 3 Press **#**, then **2 5**.

DELAYED SEND

- 4 Press **START/SET/COPY**.

MODE=OFF ▼▲

- 5 Press ▼ or ▲ to select "ON".

MODE=ON ▼▲

- 6 Press **START/SET/COPY**.

FAX=

- 7 Enter the fax number using the dial keypad, One-Touch Dial or **EASY DIAL**.

- 8 Press **START/SET/COPY**.

TIME=12:00AM

- 9 Enter the transmission start time. Press * to select "AM" or "PM".

Example (using the dial keypad): 11:30PM
Press **1130**, then press * until "PM" is displayed.

TIME=11:30PM

- 10 Press **START/SET/COPY**.

SETUP ITEM []

- 11 Press **MENU**.

SEND AT 11:30PM

- At the programmed time, the unit will automatically start transmission.

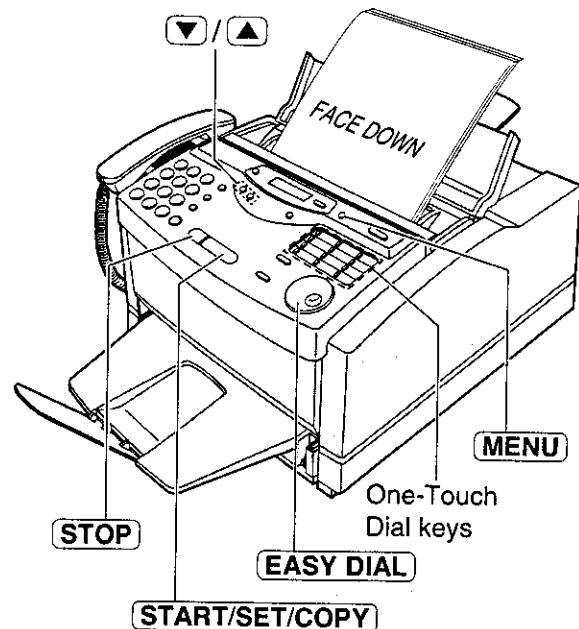

Note:

- While scanning, do not move the pages which have already been ejected. A paper jam may occur. Allow the scanning process to finish before viewing documents.
- You can receive, transmit and copy documents while delayed transmission is set.

To cancel the delayed transmission setting

1. Press **STOP** while the unit is idle.

Display: SEND CANCELED?



YES: PRESS SET

2. Press **START/SET/COPY**.

Sending Faxes

From memory

The unit is able to scan and store documents into memory, and then transmit the stored document. The memory capacity is approx. 120 pages based on the CCITT No. 1 Test Chart in standard resolution. For the CCITT No. 1 Test Chart, see page 131.

Transmitting documents from memory

- 1 Insert the document **FACE DOWN**.
- 2 Enter the fax number using the dial keypad.
- 3 Press **QUICK SCAN**.

- The document will be fed into the unit and scanned into memory.
- The amount of memory used will be shown as a percentage on the display.

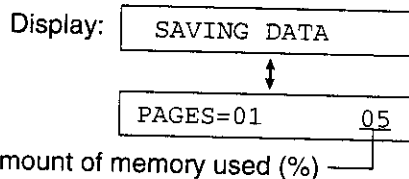

- After storing all pages, the unit will transmit the document.

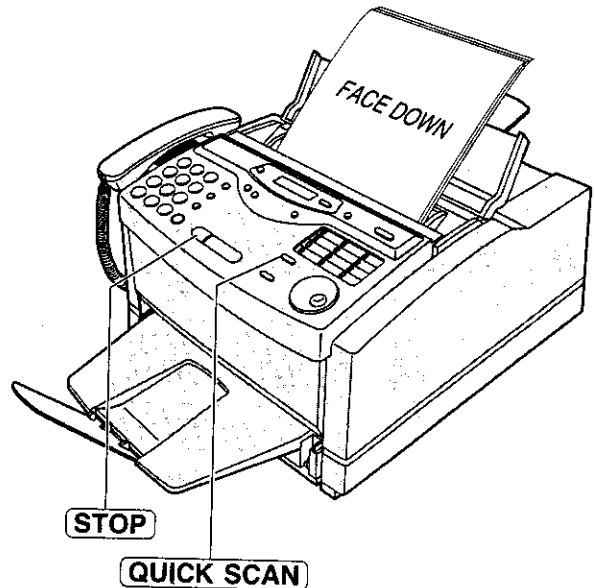

Note:

- While scanning, do not move the pages which have already been ejected. A paper jam may occur. Allow the scanning process to finish before viewing documents.
- The stored document will be automatically erased after transmission.
- To cancel the memory transmission, press **STOP** while, or after, scanning the document.
- If you select the fine, super fine or half tone resolution, the number of pages that can be sent will decrease.
- If the stored pages exceed the memory capacity, the transmission will be cancelled.

Multiple stations

This feature is useful for sending the same document to selected parties whose telephone numbers are stored in the One-Touch Dial or EASY DIAL directory. You must program the desired parties into one of the BROADCAST keys (One-Touch Dial key 1, 2, 3 or 4).

Important:

- Before programming, make sure that the desired telephone numbers have been stored in the One-Touch Dial or EASY DIAL directory.
- Each BROADCAST key can be used as a One-Touch Dial key or as a broadcast key. These functions cannot be used at the same time.

Programming telephone numbers into the BROADCAST keys

- 1** Press **DIRECTORY PROGRAM**.

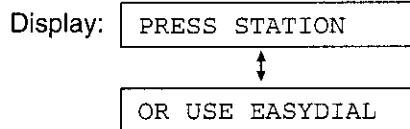

- 2** Press one of the **BROADCAST** keys.

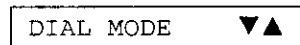

- 3** Press ▼ or ▲ to select "BROADCAST".

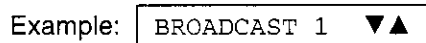

- 4** Press **START/SET/COPY**.

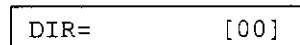

- 5** Enter the stations.

a: Using the One-Touch Dial:

For stations 1–4, press the preset One-Touch Dial key which is not used as a **BROADCAST** key.

For stations 5–11, press the preset One-Touch Dial key.

For stations 12–22, press **LOWER**, then press the preset One-Touch Dial key.

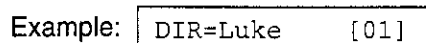

b: Using the EASY DIAL directory:

Rotate **EASY DIAL** until the desired name is displayed.

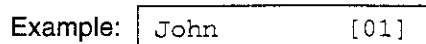

Press **START/SET/COPY**.

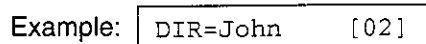

- To enter other stations, repeat this step (up to 20 stations).

- 6** Press **START/SET/COPY** after entering all of the desired stations.

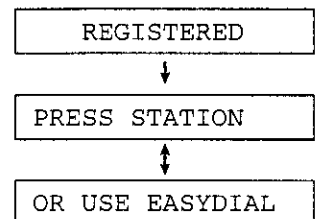

- To program another BROADCAST key, repeat steps 2 to 6.

- 7** Press **DIRECTORY PROGRAM** to exit the program.

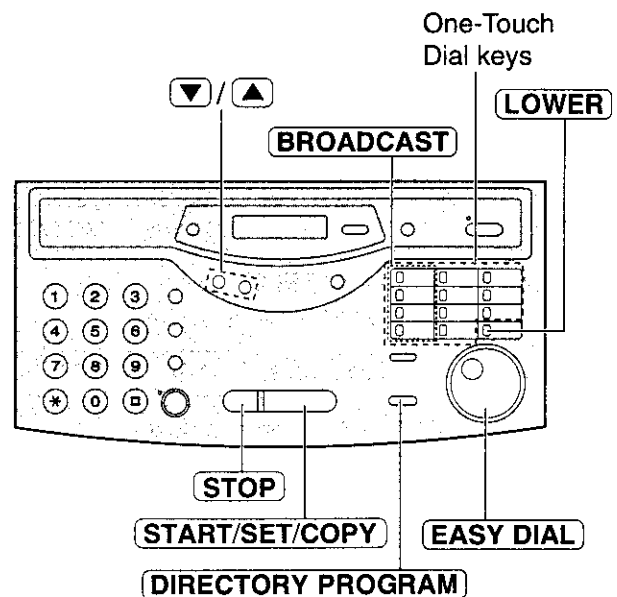

Note:

- If you make a mistake while programming, press **STOP**, and make the correction.
- Confirm the stored numbers by printing a broadcast list (p. 129).

Sending Faxes

Adding a new name and number

- 1 Rotate **EASY DIAL** until the BROADCAST key you want to edit is displayed.

Example:

- 2 Press **DIRECTORY PROGRAM**.

- 3 Press ***** to select "ADD".

Example:

- 4 Rotate **EASY DIAL** until the desired name is displayed.

Example:

- 5 Press **START/SET/COPY**.

Example:

- To add other stations, repeat steps 4 and 5 (up to 20 stations).

- 6 Press **DIRECTORY PROGRAM** to exit the program.

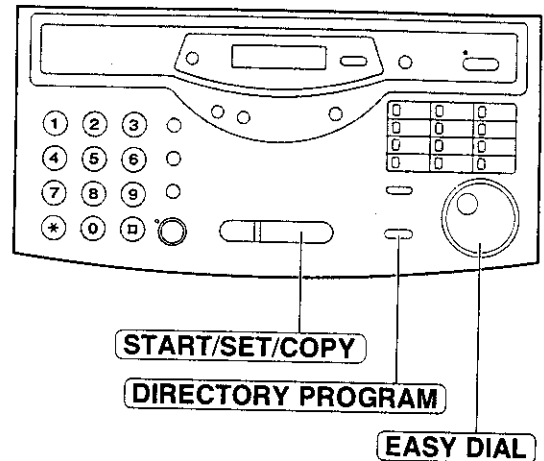

Erasing a stored name and number

- 1 Rotate **EASY DIAL** until the BROADCAST key you want to edit is displayed.

Example:

- 2 Press **DIRECTORY PROGRAM**.

- 3 Press **#** to select "DELETE".
 - The first name will be shown.

Example:

- 4 Rotate **EASY DIAL** until the desired name is displayed.

Example:

- If you do not want to erase the item, press **STOP**.

- 5 Press **START/SET/COPY**.

- 6 Press **START/SET/COPY**.

Example:

- To delete other stations, repeat steps 4 to 6.

- 7 Press **DIRECTORY PROGRAM** to exit the program.

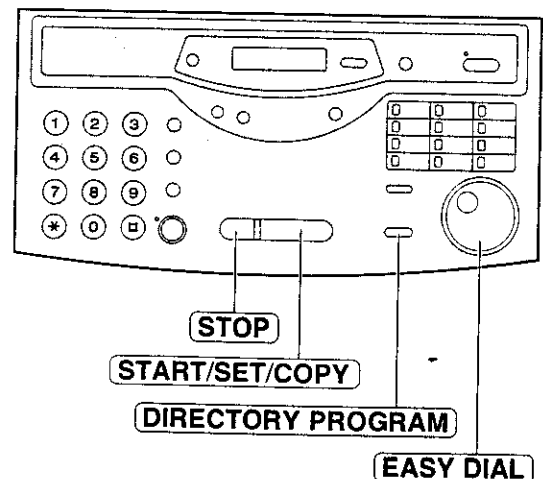

Using BROADCAST keys

The document will be scanned and stored into memory when using a BROADCAST key. After transmission, the stored document will be erased automatically.

The memory capacity is approx. 120 pages based on the CCITT No. 1 Test Chart in standard resolution. For the CCITT No. 1 Test Chart, see page 131.

- 1 Insert the document FACE DOWN.
- 2 Press the preset **BROADCAST** key.
 - The document will be fed into the unit and scanned into memory. The unit will then transmit the data to each station, calling each number sequentially.

Note:

- While scanning, do not move the pages which have already been ejected. A paper jam may occur. Allow the scanning process to finish before viewing documents.
- If you select the fine, super fine or half tone resolution, the number of pages that the unit can transmit will decrease.
- If one of the stations is busy or does not answer, the station will be skipped. All skipped stations will be redialed up to 2 times after all other stations have been called.

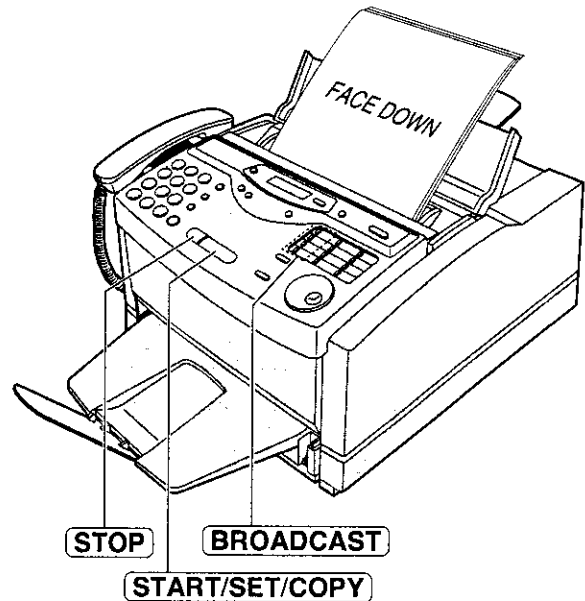

Fax/Copy

To cancel the broadcast setting

1. Press **STOP** while the unit displays "BROADCASTING".

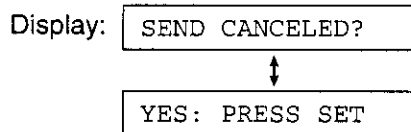

2. Press **START/SET/COPY**.

Broadcast report

After all of the transmissions have been completed, the unit will automatically print the following report.

Sample of a broadcast report:

BROADCAST REPORT 1					
Jan. 10 1999 03:36PM					
YOUR LOGO :Bill					
YOUR FAX NO. :1234567					
NO.	OTHER FACSIMILE	START TIME	USAGE TIME	PAGES	RESULT
01	Mike	Jan. 10 03:31PM	01'10	02	OK
02	Peter	Jan. 10 03:33PM	01'08	02	OK
03	Sam	Jan. 10 03:34PM	01'09	02	OK
04	Kim	Jan. 10 03:35PM	01'10	02	OK
TOTAL			004'37	008	

Sending Faxes

Overseas mode

You may experience difficulty when transmitting documents overseas. This feature makes sending documents easier as the transmission speed is slowed down. Before starting transmission, follow the steps below.

- 1 Press **MENU**.
Display: 1.SYSTEM SET UP
 - 2 Press **#**, then **2 3**.
OVERSEAS MODE
 - 3 Press **START/SET/COPY**.
MODE=OFF ▼▲
 - 4 Press ▼ or ▲ to select "ON".
MODE=ON ▼▲
- If this feature is not required, select "OFF".
- 5 Press **START/SET/COPY**.
SETUP ITEM []
 - 6 Press **MENU**.

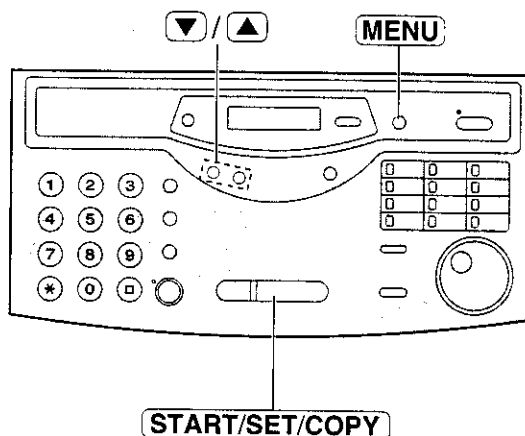

Note:

- After transmission, this feature will turn off automatically.
- This feature is not available for transmission using the BROADCAST keys.
- A slower transmission speed will lengthen the call duration. Therefore the calling charges may be higher.

Half-tone setting

You can change the setting of the half-tone resolution according to the image to be scanned. You can choose from the following.

- AUTO:** Use this setting when the image to be scanned contains both photographs and words (pre-selected setting).
- PHOTO:** Use this setting when the image to be scanned mainly contains photographs.

- 1 Press **MENU**.
Display: 1.SYSTEM SET UP
- 2 Press **#**, then **3 8**.
HALFTONE MODE
- 3 Press **START/SET/COPY**.
MODE=AUTO ▼▲
- 4 Press ▼ or ▲ to select the desired setting.
- 5 Press **START/SET/COPY**.
SETUP ITEM []
- 6 Press **MENU**.

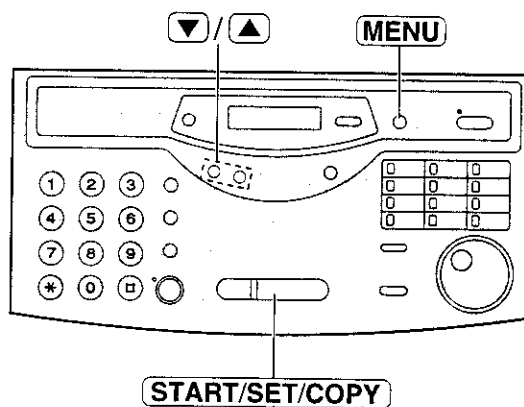

Error correction mode setting

ECM stands for Error Correction Mode.

You can send documents even if there is static interference on the telephone line, provided both the transmitting and receiving stations are ECM compatible.

ON: The unit functions with ECM communication (pre-selected setting).

OFF: The unit does not function with ECM communication.

- 1 Press **MENU**.
Display: 1.SYSTEM SET UP
- 2 Press **#**, then **6 8**.
ECM SELECTION
- 3 Press **START/SET/COPY**.
MODE=ON ▼▲
- 4 Press ▼ or ▲ to select the desired setting.
- 5 Press **START/SET/COPY**.
SETUP ITEM []
- 6 Press **MENU**.

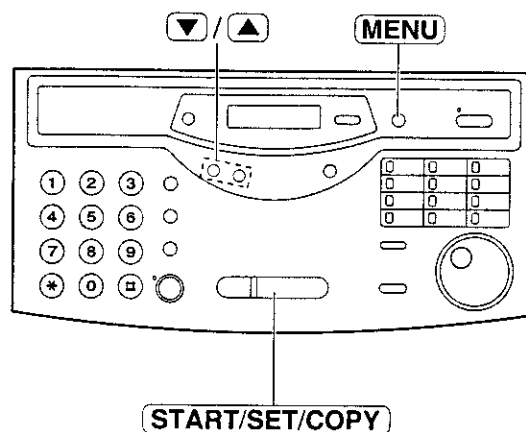

Fax/Copy

Connecting tone

This feature allows you to hear connecting tones, such as a fax tone, ring back tone or busy tone for several seconds when you send a fax using the One-Touch Dial or EASY DIAL directory. This will tell you the status of the other party's machine.

If you hear a:

- Fax tone: The other party's machine is ready for reception.
- Ring back tone: If this tone continues, the other party's machine may not be a facsimile or may have run out of paper. Check with the other party.
- Busy tone: The other party's machine is busy. Let the unit continue redialing or press **STOP** and try again later.

This feature is set to "ON" as a pre-selected setting. If this feature is not required, you can turn it off.

- 1 Press **MENU**.
Display: 1.SYSTEM SET UP
- 2 Press **#**, then **7 6**.
CONNECTING TONE
- 3 Press **START/SET/COPY**.
MODE=ON ▼▲
- 4 Press ▼ or ▲ to select the desired setting.
•If this feature is not required, select "OFF".
- 5 Press **START/SET/COPY**.
SETUP ITEM []
- 6 Press **MENU**.

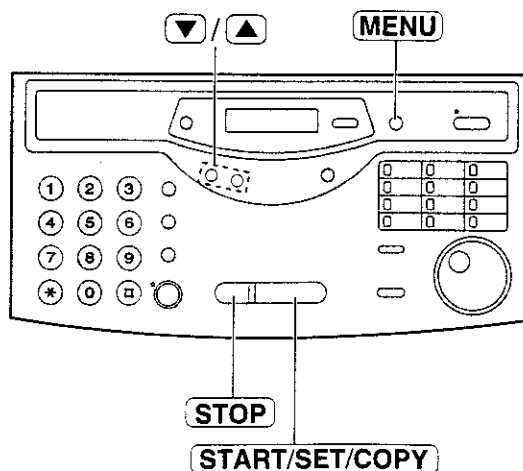

Note:

- The connecting tone volume cannot be adjusted.

Receiving Faxes

Setting the unit to receive calls

Option A

Option B

How you want the unit to receive faxes

To receive all voice and fax calls yourself.

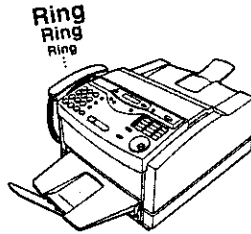

Voice/Fax call

You have a separate telephone line just for fax calls.

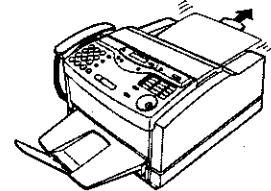

Fax call

You have to set this.

TEL mode

(p. 58)

FAX ONLY mode

(p. 61, 62)

The AUTO ANSWER light should be OFF.

- If the AUTO ANSWER light is on, press **AUTO ANSWER**.

The AUTO ANSWER light should be ON (RED).

- If the AUTO ANSWER light is off, press **AUTO ANSWER**.

This is how the unit will operate.

When the unit rings, you must answer all calls.

- If you hear a fax calling tone (slow beep) or no sound is heard, press **START/SET/COPY**.
- An answering machine can also answer the incoming calls (p. 63).

All incoming calls will be answered as faxes, and the unit will try to receive a fax.

Option C

To receive fax calls without ringing.
(The unit will only ring for voice calls.)

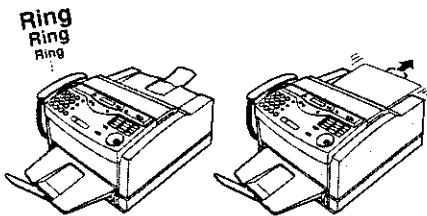

Voice call

Fax call

TEL/FAX mode

(p. 66-69)

The AUTO ANSWER light should be ON.

- If the AUTO ANSWER light is off, press **AUTO ANSWER**.

When receiving voice calls:
The unit will ring.

When receiving fax calls:
The unit will receive fax documents without ringing.

Option D

You want to use the fax machine with an answering machine.

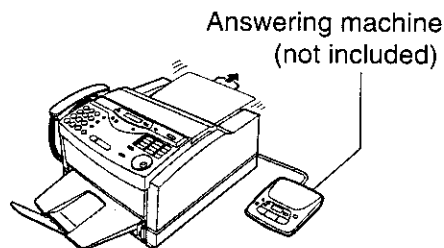

Voice/Fax call

1. Connect an answering machine to the EXT jack.
2. Set the number of rings on the answering machine to less than 4.
3. Record a greeting message on the answering machine.
4. Turn on the answering machine.
5. Program the remote activation ID into your fax machine.

For further details, see pages 63 to 65.

Use with TEL mode or FAX ONLY mode.
If you use with FAX ONLY mode, set the FAX ONLY mode ring count to more than 5 (p. 62).

When receiving voice calls:
The answering machine will record voice messages.

When receiving fax calls:
The fax machine will receive documents.

Other options

With PC
If you have a computer attached to the same telephone line, see page 64.

Distinctive ring service
If you subscribe to a distinctive ring pattern service, you can have an additional number on the same telephone line, with a different ringing pattern (p. 70).

Remote activation
If you answer a telephone in another room and hear the fax tone, you can activate the unit remotely by pressing *9 (p. 60).

Receiving Faxes

TEL mode (answering all calls manually)

If the AUTO ANSWER light is on, turn it off by pressing **AUTO ANSWER**.

Display: TEL MODE

1 When the unit rings, lift the handset to answer the call.

2 When:
—document reception is required,
—a fax calling tone (slow beep) is heard, or
—no sound is heard,
press **START/SET/COPY**.

CONNECTING.....

3 Replace the handset.
•The unit will start reception.

Note:

- If you do not answer the call within 10 rings;
—if the caller presses *****, the unit will switch to the FAX mode.
—if the caller presses **#**, the unit will switch to the TEL/FAX mode.

The caller can then send documents (p. 59).

- Manual feeding is not possible for receiving documents.

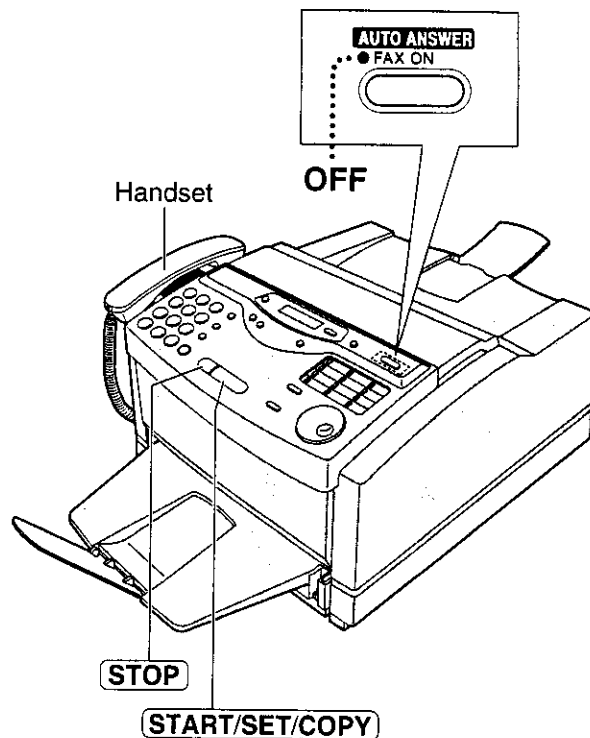

To stop receiving

Press **STOP**.

Friendly reception feature

When you answer a call and hear a fax calling tone (slow beep), the unit will automatically start receiving.

- If this feature is not required, set to "OFF" (p. 73).

Memory reception

When a printing problem is detected, the unit will temporarily store the received document into memory.

While the document is in memory, the unit will:

- display an error message and the following message alternately.

Display: FAX IN MEMORY

—alert you with a slow beep (memory reception alert).

- Follow the instructions on pages 110 and 111 to solve the problem and print the stored document.
- For memory capacity, see page 131.

Turning the AUTO ANSWER mode on remotely ==

When you are not in, and the AUTO ANSWER mode of your unit is set to off (TEL mode), you can turn the AUTO ANSWER mode on (FAX or TEL/FAX mode) from a remote location using a touch tone telephone.

1. Dial the number of your unit.
 2. Let it ring 10 times.
 3. You will hear a beep signal.
 4. To switch to the FAX mode, press *****.
To switch to the TEL/FAX mode, press **#**.
 5. Hang up the handset.
- Press ***** or **#** within 8 seconds after hearing the beep, otherwise the call will be interrupted and the unit will remain in the TEL mode.

Receiving Faxes

Extension telephone

If you connect an extension telephone to your unit or on the same line, you can receive fax documents using the extension telephone.

You do not have to press **START/SET/COPY** on the unit.

Important:

- Use a touch tone telephone as the extension telephone and enter the fax activation code **firmly**.

- 1** When the extension telephone rings, lift the handset.
- 2** When:
 - document reception is required,
 - a fax calling tone (slow beep) is heard, or
 - no sound is heard,press ***9** (pre-selected fax activation code) **firmly**.
- 3** Hang up the handset.
 - The unit will start reception.

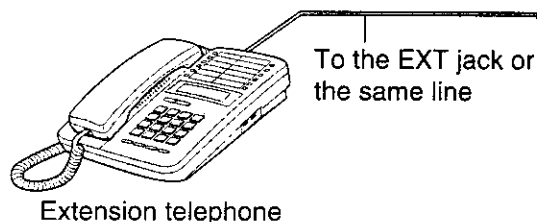

Note:

- You can change the fax activation code (see below).

Fax activation code

The fax activation code is required in the following cases:

- when receiving faxes using an extension telephone (see above).
- when receiving a voice message and fax document in the same call (p. 65).

Important:

- This code should be different from the remote activation ID (p. 65).

- 1** Press **MENU**.
Display: 1. SYSTEM SET UP
- 2** Press **#**, then **4** **1**.
FAX ACTIVATION
- 3** Press **START/SET/COPY**.
MODE=ON ▼▲
- 4** Press ▼ or ▲ to select "ON".
 - If this feature is not required, select "OFF".
- 5** Press **START/SET/COPY**.
CODE=*9
 - The display will show the pre-selected code.
- 6** Enter the new code.
 - This code can be from 2 to 4 digits in length using 0-9 and *.
- 7** Press **START/SET/COPY**.
SETUP ITEM []
- 8** Press **MENU**.

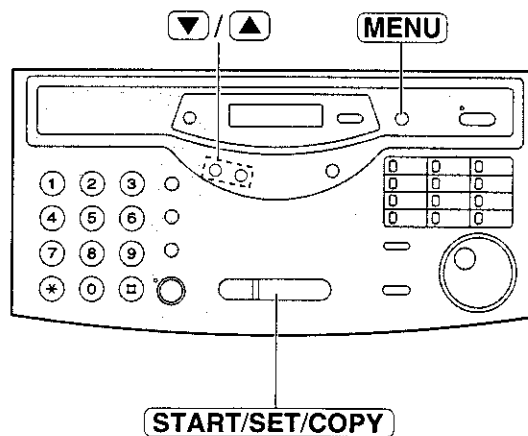

Note:

- If you subscribe to any special telephone company services which require a code, all or part of the fax activation code must be different from the service access code.
- The fax activation code should not be set to "0000".

FAX ONLY mode (all calls are received as faxes)

Activating the FAX ONLY mode

Press **AUTO ANSWER** if the AUTO ANSWER light is off.

- The display will show the following.

Display: **FAX ONLY MODE**

- The unit will automatically answer all calls and only receive fax documents.
- The number of rings before a call is answered can be changed (p. 62).

Note:

- This mode should not be used with a telephone line which is used for both voice and fax calls. When the unit answers the call, fax communication is attempted even if someone is trying to call you.

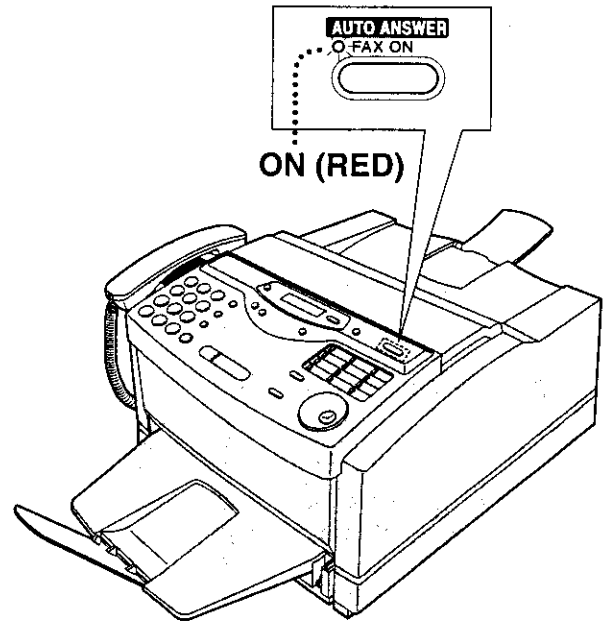

If you have a telephone line just for receiving faxes, we recommend the following setup.

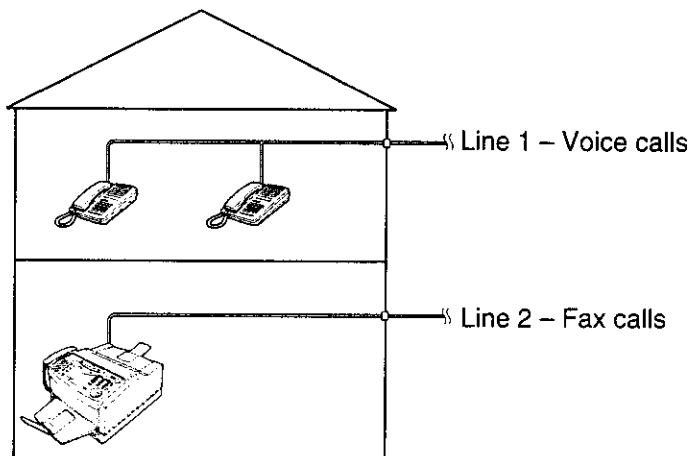

Only a fax machine is connected.

Example: One telephone line is used for voice calls and a separate telephone line for faxes. If someone sends a fax to Line 2, the fax machine will ring.

Receiving Faxes

Setting the ring count in the FAX ONLY mode

This setting determines the number of rings before the unit answers a call in the FAX ONLY mode. You can choose from 2 to 9 rings. If you use the unit with an answering machine (p. 63–65), set the ring count to more than 5.

Helpful hints:

- To answer a call before the unit does, increase the number of rings.
- If you have difficulty receiving faxes, the other parties may have tried to send faxes before confirming if your unit answered or not. Decrease the number of rings.

- 1 Press **MENU**.
Display: 1.SYSTEM SET UP
- 2 Press **#**, then **0 6**.
FAX RING COUNT
- 3 Press **START/SET/COPY**.
RING=2 ▼▲
- 4 Press ▼ or ▲ to select the desired number, or enter the number using the dial keypad.
- 5 Press **START/SET/COPY**.
SETUP ITEM []
- 6 Press **MENU**.

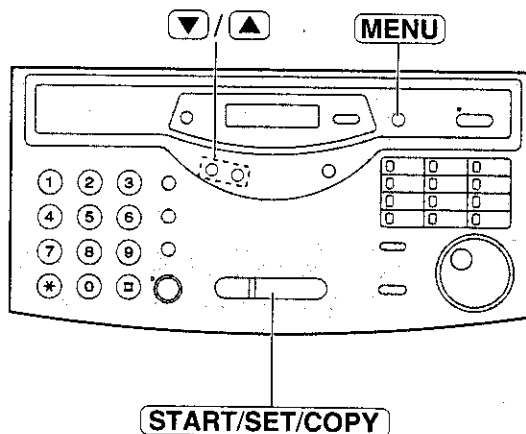

Using the unit with an answering machine

Setting up the fax machine with an answering machine

- 1 Connect the answering machine to the EXT jack on the back of the fax machine.

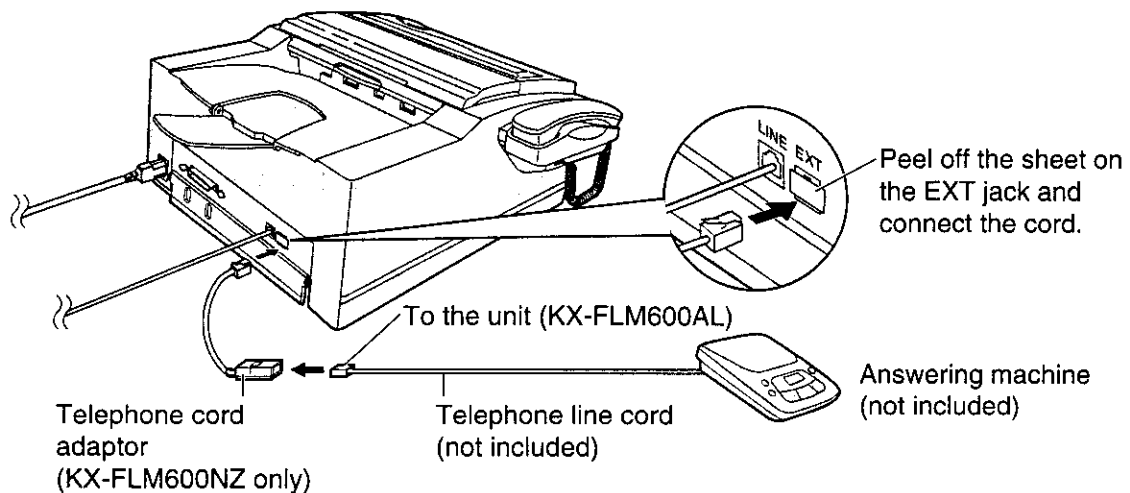

- 2 If you plan to use the FAX ONLY mode on the fax machine, set the number of rings on the answering machine to less than 4.
 - This will allow the answering machine to answer the call first.
- 3 Record a greeting message on the answering machine.
Example: "This is (your name, business and/or telephone number). We are unable to answer the phone right now. To send a fax, start transmission. To leave a message, please speak after the beep. Thank you."
- 4 Turn on the answering machine.
- 5 Set the receive mode of the fax machine to the TEL mode (p. 58) or FAX ONLY mode (p. 61).
 - If you set it to FAX ONLY mode, **set the ring count in the FAX ONLY mode (feature setting #06) to more than 5** (p. 62). The number of rings on the answering machine should be less than the FAX ONLY mode ring count so that the answering machine will answer a call first. Using the FAX ONLY mode will allow you to receive faxes if the answering machine is full.
- 6 Check the remote access code of your answering machine and program the same code into the remote activation ID of the fax machine (feature setting #12). See page 65.

Note:

- Do not pause for more than 4 seconds during the greeting message. If a 4-second pause is stored in the greeting message, all incoming calls will be routed to the unit from the answering machine even while the greeting message is playing.
- We recommend you make the greeting message around 10 seconds long. If the greeting message is too long, some incoming fax calls may not be answered by the fax machine.
- Each time the unit receives a document, a silent pause or fax tone may be recorded on the answering machine.

Receiving Faxes

How the fax machine and answering machine work

Receiving voice calls

The answering machine will record voice messages automatically.

Receiving fax calls

The fax machine will receive documents automatically.

Receiving a voice message and fax document in one call

The answering machine will record the voice message first. The fax machine will then be activated by the caller's request and receive the document. For further details, see next page.

To use the unit with an answering machine and computer, we recommend the following setup.

Always connect the fax machine directly to the wall jack.

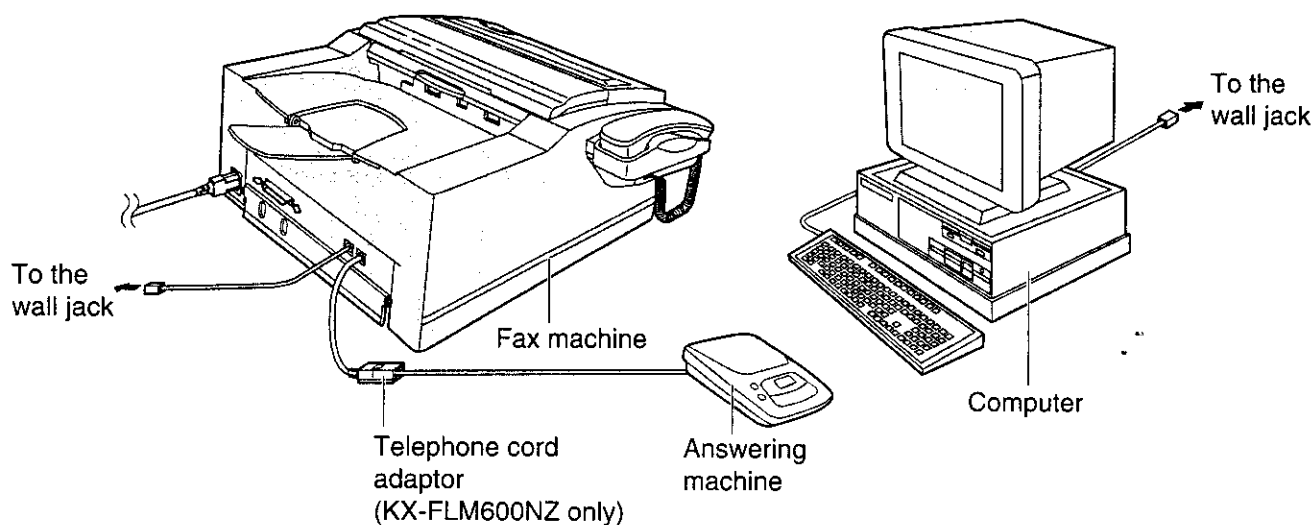

Note:

- Set the TEL mode on the fax machine.
- The device which has the shortest ring count will answer a call first. Confirm the ring count for each device.
- If you use your computer as an answering machine, connect the telephone line cord from the EXT jack on the back of the fax machine to the computer.

Remote operation of your answering machine (remote activation ID)

Some answering machines will allow you to retrieve voice messages from a remote location. To deactivate the fax machine while you are checking your messages, set the remote activation ID code for the answering machine.

Important:

- This ID must be different from the fax activation code (p. 60).

- 1 Press **MENU**.
Display: 1. SYSTEM SET UP
- 2 Press **#**, then **1** **2**.
REMOTE TAM ACT.
- 3 Press **START/SET/COPY**.
MODE=OFF ▼▲
- 4 Press ▼ or ▲ to select "ON".
MODE=ON ▼▲
- 5 Press **START/SET/COPY**.
ID=11
- 6 Enter your ID number.
 - This ID can be from 1 to 5 digits in length using 0-9, * and #.
- 7 Press **START/SET/COPY**.
SETUP ITEM []
- 8 Press **MENU**.

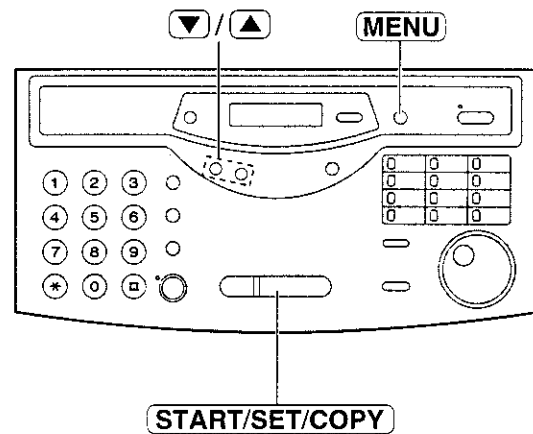

Receiving a voice message and fax document in one call

The caller can leave a voice message and send a fax document during the same call. Inform the caller of the following procedures beforehand.

1. The caller calls your fax machine.
 - The answering machine will answer the call.
2. The caller can leave their message after the greeting message.
3. The caller presses ***9** (pre-selected fax activation code).
 - The fax machine will activate the fax function.
4. The caller presses their start button to send a document.

Note:

- The fax activation code can be changed (p. 60).
- If the wrong fax activation code is entered, the caller must wait at least 5 seconds to reenter the correct code.

Receiving Faxes

TEL/FAX mode

(receiving voice calls with rings and fax calls without rings when you are near the unit)

Use this mode when you are always near the unit, are not using an answering machine and want the fax machine to detect faxes without ringing. When a call is received, the unit will work as follows. If you have an extension telephone connected, see next page.

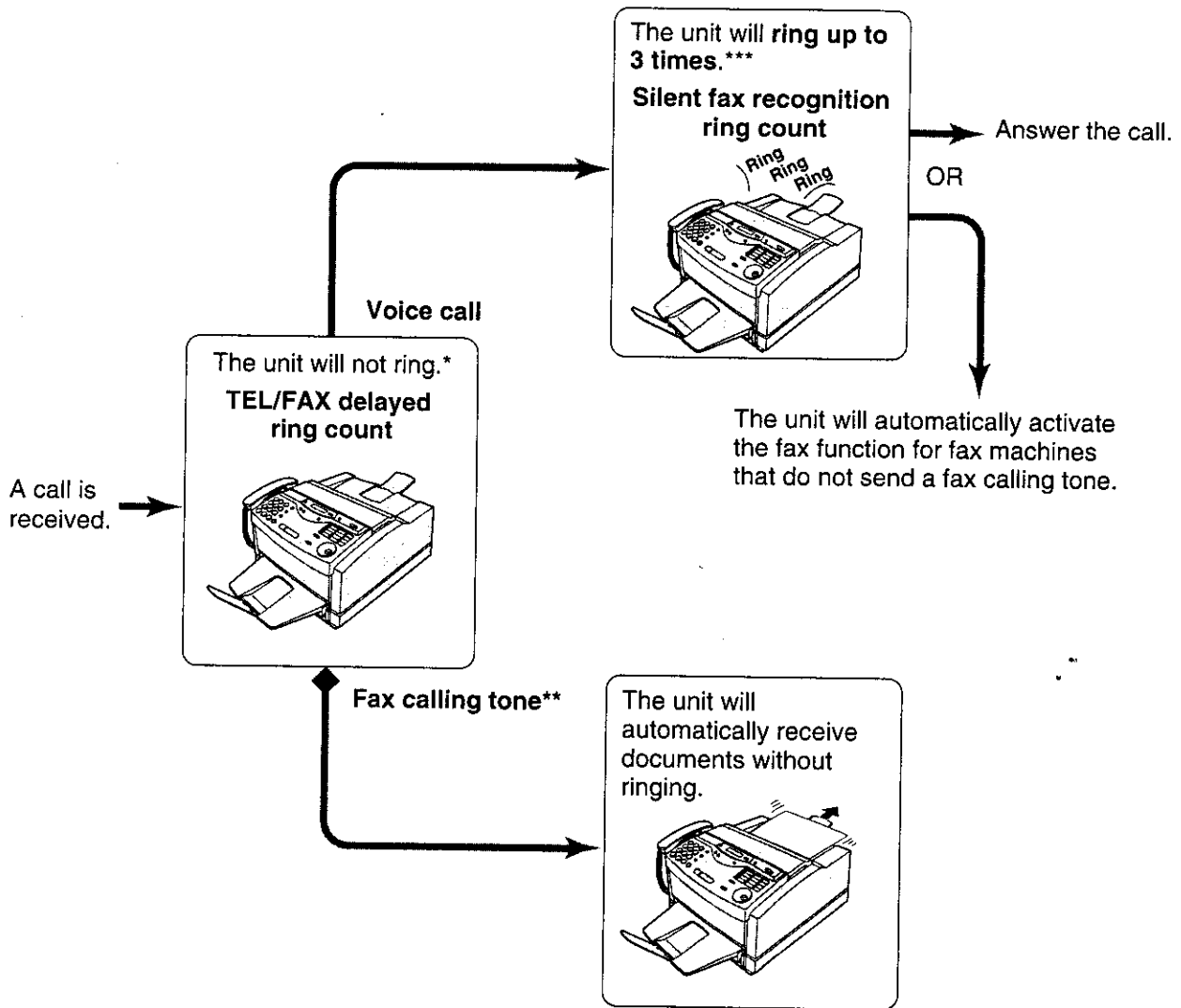

* A telephone fee will be charged to the caller from this point.

** A fax calling tone is automatically generated by the sending fax machine. Some fax machines do not have this capability.

*** While ringing, the unit will emit a different ring back tone to the calling party.

Note:

- The unit will display the following when a call is received.

Display: INCOMING CALL

- Some fax messages that are transmitted manually may not send a fax calling tone. These calls must be received manually.
- The ringer should be on (p. 33).

T
L
th
S
T
F
T

Receiving Faxes

Ring pattern when an extension telephone is connected

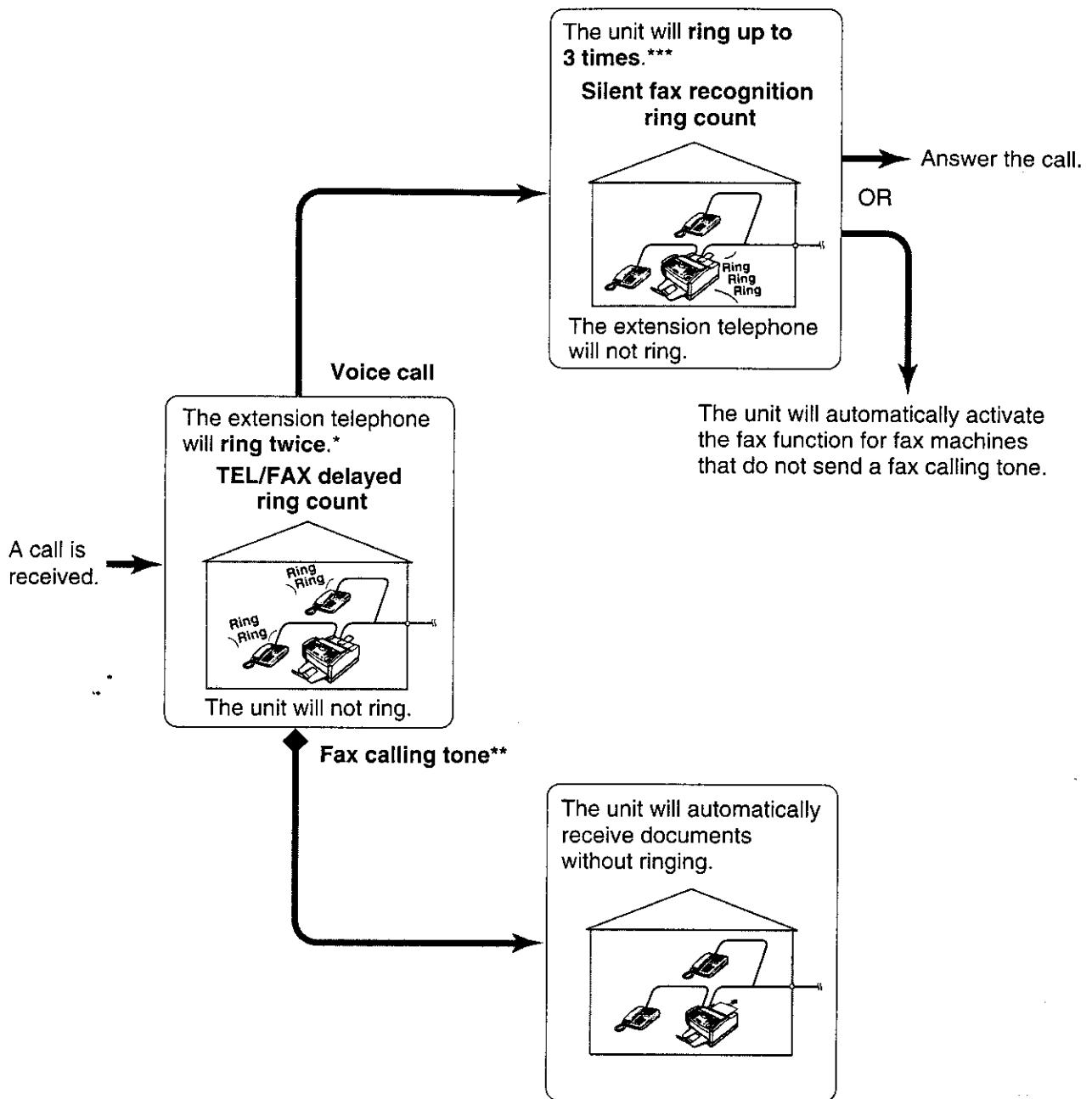

Fax/Copy

TEL/FAX delayed ring count:

Up to 9 ring signals will be generated before the unit answers, depending on feature setting #78 on page 69. In the TEL/FAX mode, the unit will not generate an audible ring during this time.

Silent fax recognition ring count:

The unit generates audible rings to indicate that it is receiving a voice call.

For KX-FLM600AL: 3 to 6 rings will be generated, depending on feature setting #30 on page 69.

For KX-FLM600NZ: 3 to 9 rings will be generated, depending on feature setting #30 on page 69.

This signal will not ring at an extension telephone.

Receiving Faxes

Changing the AUTO ANSWER setting to the TEL/FAX mode

- 1 Press **MENU**.
Display: 1.SYSTEM SET UP
- 2 Press **#**, then **7 7**.
AUTO ANSWER
- 3 Press **START/SET/COPY**.
MODE=FAX ONLY ▼▲
- 4 Press ▼ or ▲ to select "TEL/FAX".
MODE=TEL/FAX ▼▲
- 5 Press **START/SET/COPY**.
SETUP ITEM []
- 6 Press **MENU**.
- 7 If the AUTO ANSWER light is off, turn it on by pressing **AUTO ANSWER**.
TEL/FAX MODE

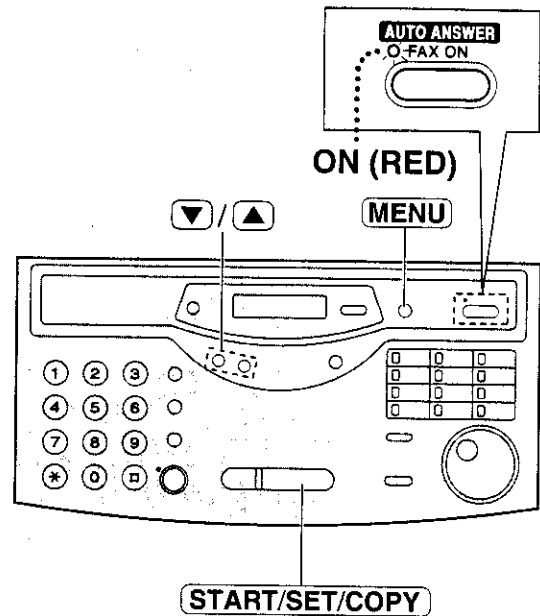

Note:

- To return to the FAX ONLY mode, select "FAX ONLY" in step 4.

We recommend the following setup.

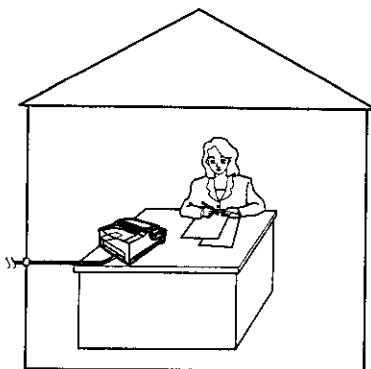

Only a fax machine is connected and you are always near the fax machine.

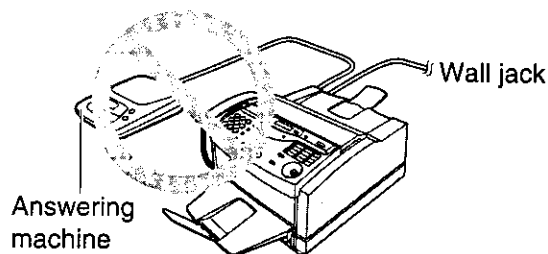

- Do not connect an answering machine when using the TEL/FAX mode.

TEL/FAX delayed ring count

This setting determines the number of times the extension telephone rings in the TEL/FAX mode. You can choose from 2 to 9 rings.

This setting does not need to be changed if an extension telephone is not connected.

- 1 Press **MENU**.
Display: 1.SYSTEM SET UP
- 2 Press **#**, then **7** **8**.
TEL/FAX RING
- 3 Press **START/SET/COPY**.
RING=2 ▼▲
- 4 Press ▼ or ▲ to select the desired number, or enter the number using the dial keypad.
- 5 Press **START/SET/COPY**.
SETUP ITEM []
- 6 Press **MENU**.

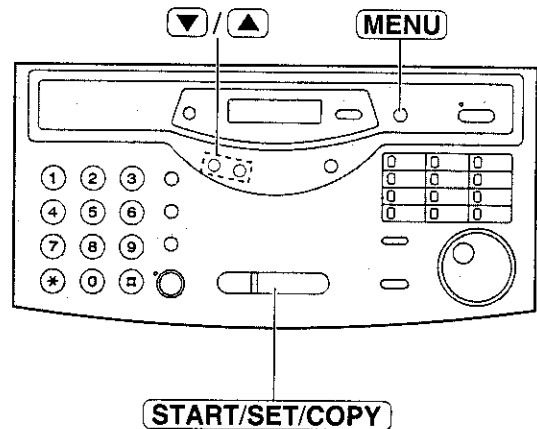

Note:

- If the number of rings is increased, you may not be able to receive documents from some older model fax machines which do not send a fax calling tone.

Fax/Copy

Silent fax recognition ring count

When the unit detects a voice call in the TEL/FAX mode, it will ring up to 3 times.

KX-FLM600AL: The number of rings can be changed up to 6.

KX-FLM600NZ: The number of rings can be changed up to 9.

The number of rings can be changed up to 9.

- 1 Press **MENU**.
Display: 1.SYSTEM SET UP
- 2 Press **#**, then **3** **0**.
SILENT FAX RING
- 3 Press **START/SET/COPY**.
RING=3 ▼▲
- 4 Press ▼ or ▲ to select the desired number, or enter the number using the dial keypad.
- 5 Press **START/SET/COPY**.
SETUP ITEM []
- 6 Press **MENU**.

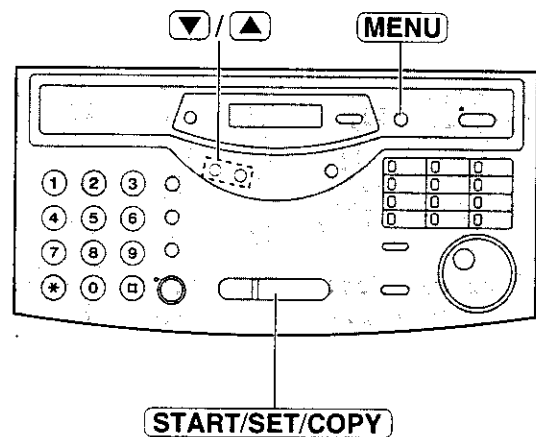

Note:

- If the number of rings is increased, you may not be able to receive documents from some older model fax machines which do not send a fax calling tone.

Receiving Faxes

Distinctive ring service - FaxAbility

This feature is only for use if you subscribe to a distinctive ring pattern service from your telephone company. For more information on the availability of this service in your area, please contact your telephone company before setting this feature on your unit.

The distinctive ring service gives you an additional phone number on a single telephone line, with a different ringing pattern.

When you wish to use the additional phone number as a facsimile telephone number, set the Distinctive ring pattern feature to ON. When the unit detects a call matching the distinctive ring pattern, it will activate the fax function.

To use this feature properly, set the unit to the TEL/FAX mode (p. 68).

Setting the Distinctive ring pattern feature

1 Press **MENU**.

Display: 1. SYSTEM SET UP

2 Press **#**, then **3 1**.

RING DETECTION

3 Press **START/SET/COPY**.

MODE=OFF ▼▲

4 Press ▼ or ▲ to select "ON".

MODE=ON ▼▲

• If this feature is not required, select "OFF".

5 Press **START/SET/COPY**.

SETUP ITEM []

6 Press **MENU**.

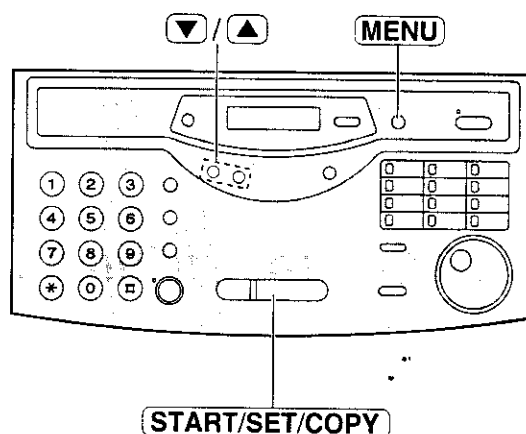

Note:

- The unit will automatically answer a Distinctive Ring call after the second ring regardless of the AUTO ANSWER, receive mode or ring count setting.

Other size documents

When the size of the document sent by the other party is larger than the recording paper, the unit can reduce each page of the document to fit on one page.

ON: The unit will reduce any document larger than A4 (pre-selected setting).

OFF: The unit does not reduce any incoming faxes. Oversized documents will be divided when printed out.

To change the setting, proceed as follows.

- 1 Press **MENU**.
Display: 1.SYSTEM SET UP
- 2 Press **#**, then **3 7**.
AUTO REDUCTION
- 3 Press **START/SET/COPY**.
MODE=ON ▼▲
- 4 Press ▼ or ▲ to select the desired setting.
- 5 Press **START/SET/COPY**.
SETUP ITEM []
- 6 Press **MENU**.

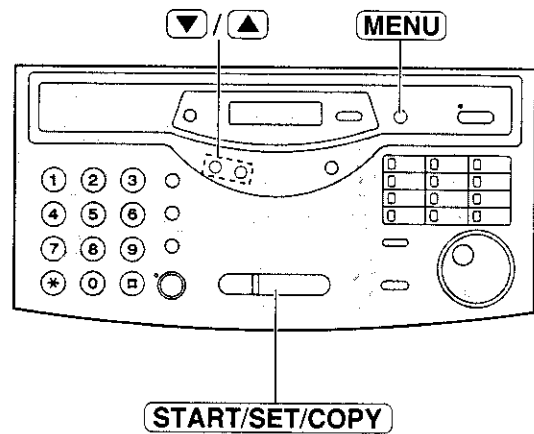

Note:

- Documents usually have a heading on the top of each page which contains the sender's name/telephone number. This increases the length of each page. Therefore using the reduction mode is recommended.

Receiving Faxes

Silent detection (receiving faxes from older model fax machines)

This feature allows the unit to activate the fax function automatically if a silent pause longer than 4 seconds is detected when using an answering machine.

Helpful hints:

- If you wish to receive documents from fax machines that do not send a fax calling tone, activate this feature.
- If you use an answering machine to give greeting messages and record incoming messages on a single cassette tape, deactivate this feature.

- 1 Press **MENU**.
Display: 1.SYSTEM SET UP
- 2 Press **#**, then **4 0**.
SILENT DETECT.
- 3 Press **START/SET/COPY**.
MODE=OFF ▼▲
- 4 Press ▼ or ▲ to select "ON".
• If this feature is not required, select "OFF".
- 5 Press **START/SET/COPY**.
SETUP ITEM []
- 6 Press **MENU**.

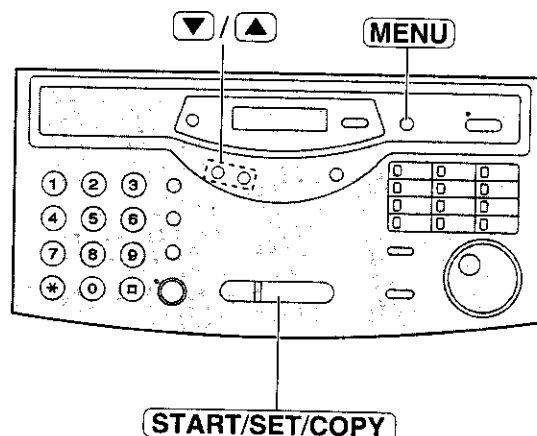

Memory reception alert

When a received document is stored into memory due to a problem, the unit will alert you with beep tones. If you hear slow beeps, clear the printing problem or supply paper to print the stored document. The beep tones will stop.

- 1 Press **MENU**.
Display: 1.SYSTEM SET UP
- 2 Press **#**, then **4 4**.
RECEIVE ALERT
- 3 Press **START/SET/COPY**.
MODE=ON ▼▲
- 4 Press ▼ or ▲ to select the desired setting.
• If this feature is not required, select "OFF".
- 5 Press **START/SET/COPY**.
SETUP ITEM []
- 6 Press **MENU**.

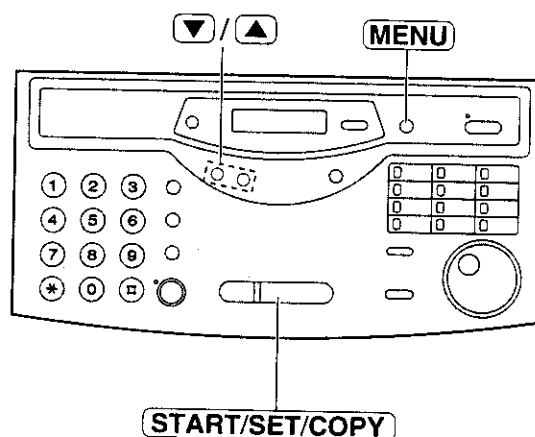

Friendly reception

The friendly reception feature allows you to receive fax documents automatically without pressing **START/SET/COPY** (p. 58).

When this feature is deactivated, you have to press **START/SET/COPY** to receive fax documents each time you answer a fax call.

- 1 Press **MENU**.
Display: 1. SYSTEM SET UP
- 2 Press **#**, then **4** **6**.
FRIENDLY RCV
- 3 Press **START/SET/COPY**.
MODE=ON ▼▲
- 4 Press ▼ or ▲ to select the desired setting.
• If this feature is not required, select "OFF".
- 5 Press **START/SET/COPY**.
SETUP ITEM []
- 6 Press **MENU**.

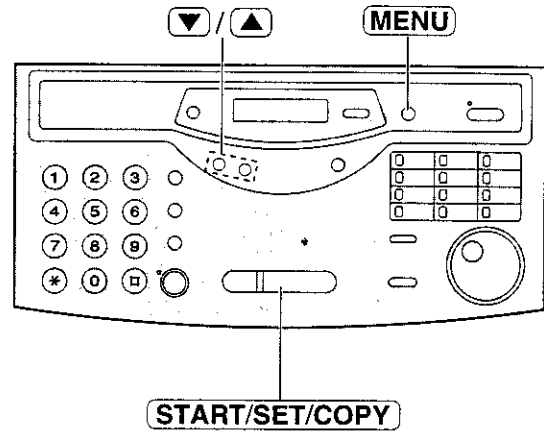

Receiving Faxes

Pager call - when your unit receives a fax

This feature allows your unit to call your pager when your unit receives a fax document.

- 1 Press **MENU**.
Display: 1.SYSTEM SET UP
- 2 Press **#**, then **7 0**.
FAX PAGER CALL
- 3 Press **START/SET/COPY**.
MODE=OFF ▼▲
- 4 Press ▼ or ▲ to select "ON".
MODE=ON ▼▲
- 5 Press **START/SET/COPY**.
NO. =
- 6 Enter your pager number.
•You can enter a total of 46 digits and/or pauses.
Example:
1 202 555 1234PPP12345678PPP5555#
Your pager number Pauses Your pager access code, if required. Message you want to display on your pager when your unit receives a fax.
- 7 Press **START/SET/COPY**.
•The unit will dial the stored pager number.
PAGER TEST
- 8 Check that the message is displayed on your pager.
- 9 Press **MONITOR**.
- 10 If the AUTO ANSWER light is off, turn it on by pressing **AUTO ANSWER**.

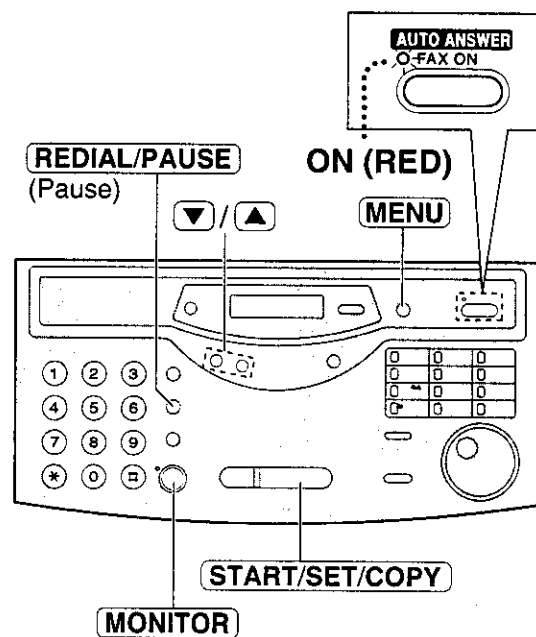

How your unit and pager work

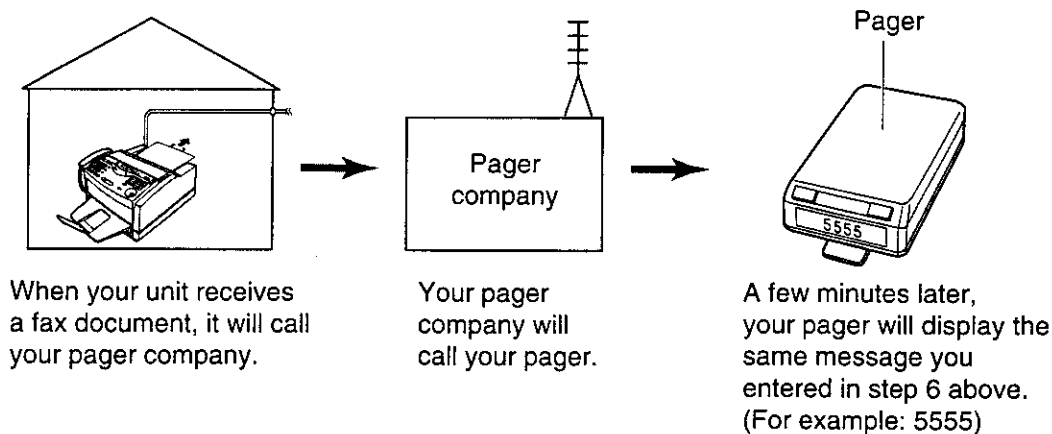

Toner save

With the toner save feature on, toner consumption can be decreased, resulting in a longer effective cartridge life.

This feature is available when printing received fax documents, help lists and other reports/lists or copying documents.

- 1 Press **MENU**.
Display: 1.SYSTEM SET UP
- 2 Press **#**, then **7** **9**.
TONER SAVE
- 3 Press **START/SET/COPY**.
MODE=OFF ▼▲
- 4 Press ▼ or ▲ to select "ON".
MODE=ON ▼▲
- 5 Press **START/SET/COPY**.
SETUP ITEM []
- 6 Press **MENU**.

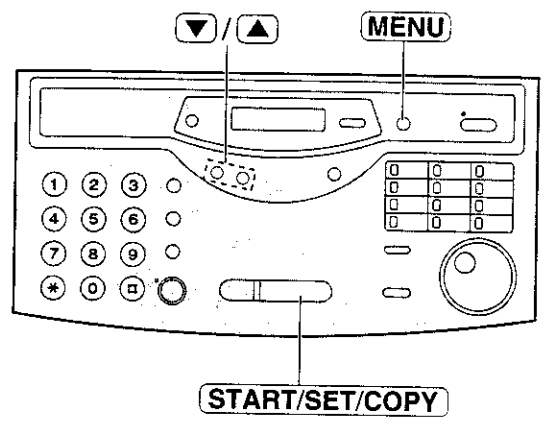

Fax/Copy

Note:

- Using the toner save feature may reduce print quality.
 - When printing from the PC, this setting does not work.
- To save toner, use the PANA LINK printer driver setting.

Copying

Making a copy

The unit can make single or multiple copies (up to 99). Any transmittable document (p. 46) can be copied.

- 1 Open the document feeder tray.
- 2 Adjust the width of the document guides to the size of the document.
- 3 Insert the document (up to 15 pages) FACE DOWN until the unit grabs the document and a single beep is heard.

Display:

- Make sure the handset is on the cradle.

- 4 If necessary, press **RESOLUTION** repeatedly to select the desired setting (p. 43).

- 5 Press **START/SET/COPY**.

- 6 Enter the number of copies (up to 99).

- 7 If necessary, choose an enlargement/reduction rate by rotating **EASY DIAL**. See next page.

- 8 If you want to print collated copies, press **COLLATE** until the following is displayed (see next page).

- 9 Press **START/SET/COPY**.

OR

Press **QUICK SCAN** if you want to remove the copy document for other uses.

- The unit will feed the documents and scan them into memory, then start printing.

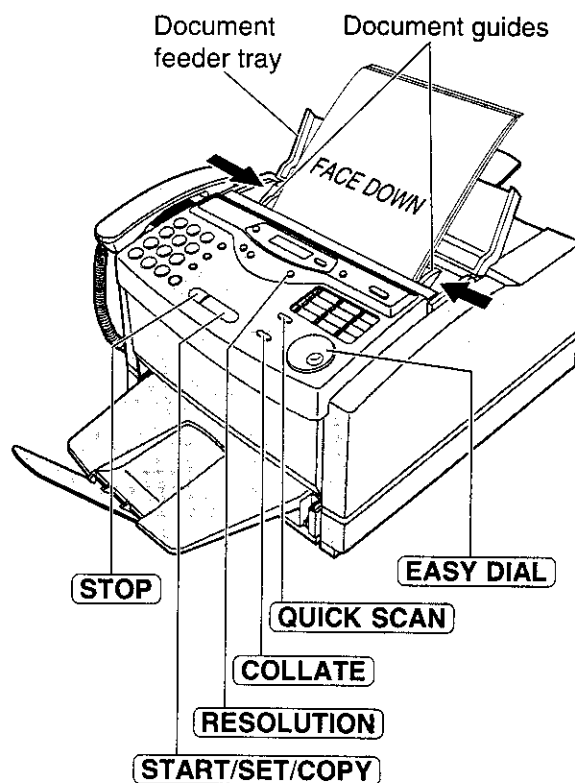

Note:

- While scanning, do not move the pages which have already been ejected. A paper jam may occur. Allow the scanning process to finish before viewing documents.
- If a resolution is not selected, FINE resolution will automatically be selected.
- Once copying has started, the resolution cannot be changed.
- You can make or receive a voice call while making copies.
- After copying, the enlargement/reduction rate setting will return to "100%".
- Manual feeding is not possible when making a copy.

To stop copying

Press **STOP**.

Printing collated copies

The unit will print uncollated copies. You can also print collated copies. See the example below.

Example: Making two copies of a 4 page original document

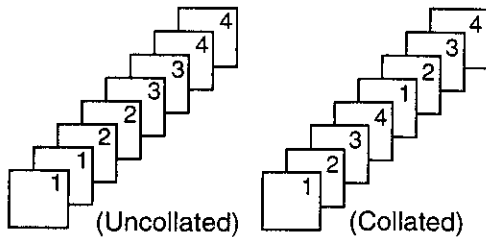

- If you turn the collating feature on, the unit will store the document into memory and print it. If memory becomes full while storing, the unit will not print.
- After copying, the collating feature will turn off automatically.

Choosing an enlargement/reduction rate

The unit can make enlarged or reduced copies of a document.

■ To enlarge a document:

Select the desired enlargement rate by rotating **EASY DIAL** to the right. The unit will only enlarge the centre part of the document and print it on two pages.

The unit can enlarge copies by 5% to as much as 200% of the original.

Sample of an enlarged copy:

• 200% example

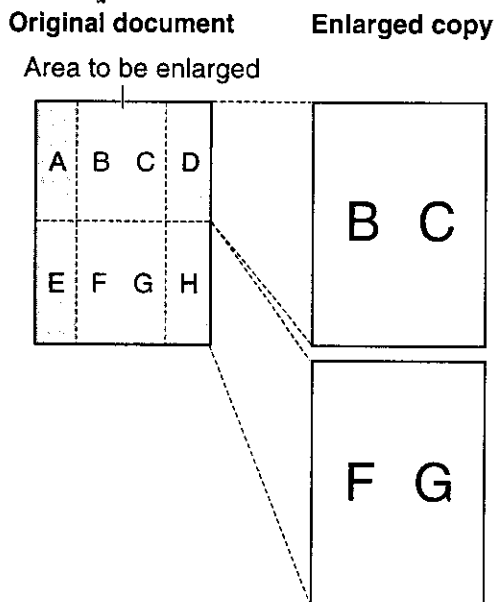

• 150% example

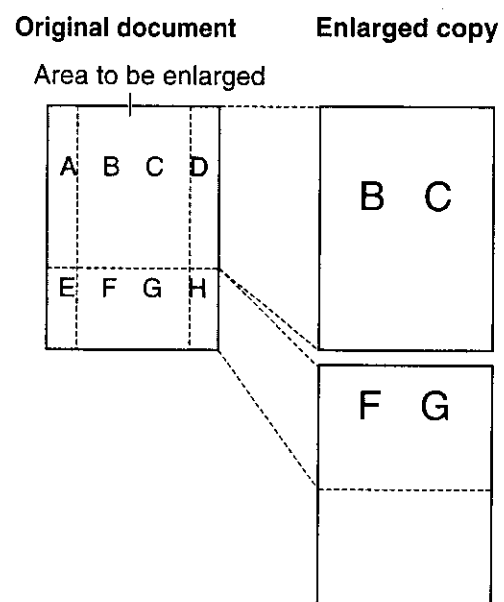

■ To reduce a document:

Select the desired reduction rate by rotating **EASY DIAL** to the left.

The unit can reduce copies by 5% to as little as 50% of the original.

Note:

- If the appropriate reduction rate is not programmed, the document may be divided and the top of the second sheet will be deleted.

Setup (PC)

Connecting to a computer

To run the Panasonic Multi-Function software (PANA LINK), you need the following software and hardware.

CPU:	An IBM compatible personal computer with a 486 or higher processor (Pentium is recommended.)
Basic Software:	Microsoft Windows 95 or Windows 98 (Windows 3.1/3.11*—printer driver only)
Memory Minimum:	16 MB (32 MB or more is recommended)
Hard disk:	More than 40 MB available space
Other:	Parallel port Panasonic Multi-Function fax machine

*Microsoft Windows operating system Version 3.1/3.11 (hereafter Windows 3.1/3.11)

Connect your personal computer to the fax machine as follows:

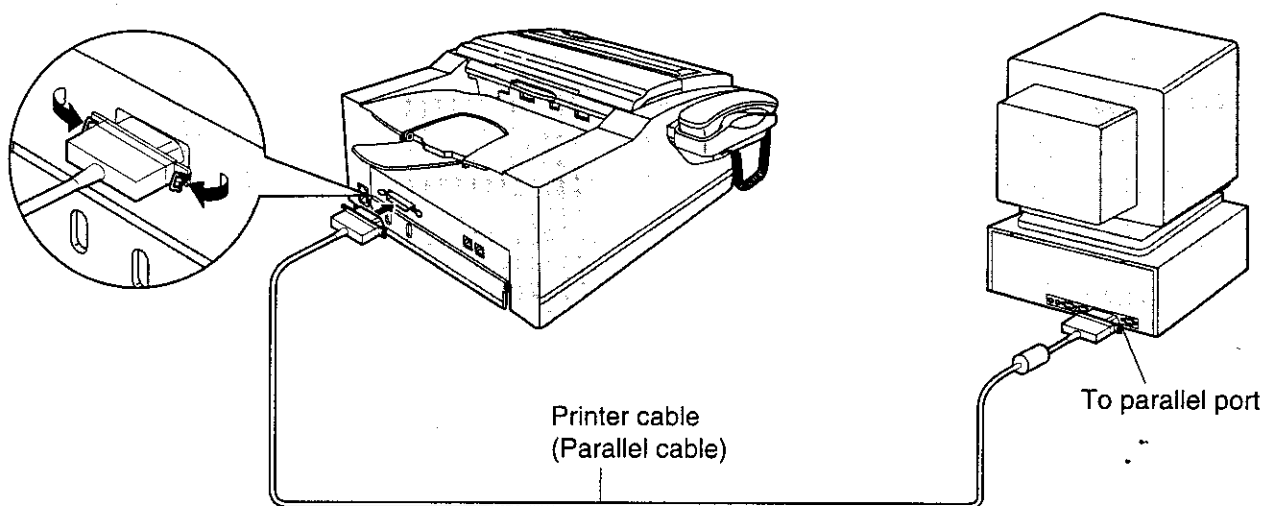

Caution:

- When connecting the fax machine to your computer, use the included printer cable for reliable data communications and compliance with EMI.
- Do not connect the printer cable to the serial port on the computer. This may cause damage to your fax machine and computer.

Installing the PANA LINK software

- 1 Start Windows 95 or Windows 98 and close all applications.
- 2 Insert the included CD into your CD-ROM drive.
 - The language dialogue box will appear. Select the desired language to use with this software. Click **OK**.

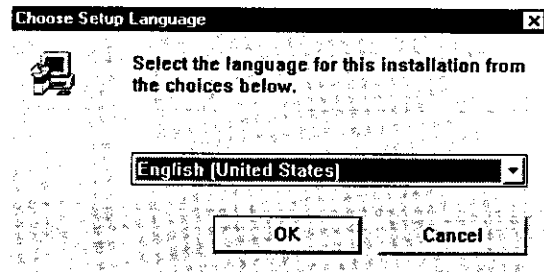

- If the language dialogue box does not appear and the installation does not start automatically:
Click **Start**, choose **Run...** . Type "**d:\setup**" (where **d:** is the drive letter of your CD-ROM drive). Click **OK**.
(If you are not sure what the drive letter is for your CD-ROM drive, please use Windows Explorer and look for the CD-ROM drive.)

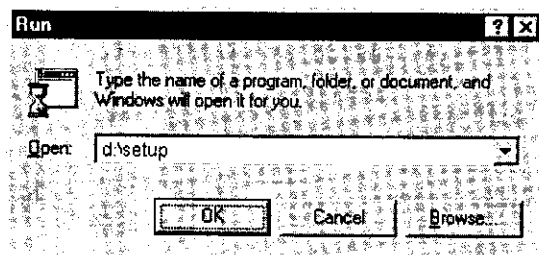

Note:

- For detailed instructions on PANA LINK software, use the Help function.
- The screens shown in these instructions are from Windows 95.

Windows 3.1 or 3.11 users:

- If you are using Windows 3.1 or 3.11, follow these steps to install the software.
 1. From the Program Manager, click **File**, choose **Run...** .
 2. Type "**d:\win31\Eng_uk\setup**" (where **d:** is the drive letter of your CD-ROM drive).
 3. Click **OK**.
- The printer driver only is available. Please read the README file (README.WRI) in the CD-ROM for more information.

- 3 The installation will automatically start.

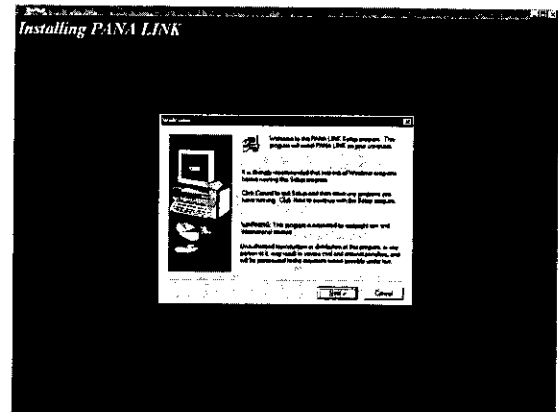

- 4 Follow the instructions on the screen until all files have been installed.

- 5 Be sure to read the README file for more information.

- The README file contains the following information:
 1. Install/uninstall PANA LINK for Windows 95/98.
 2. Install/uninstall KX-FLM600/650 for Windows 3.1.
 3. Print and Scan from Windows 3.1.
 4. How to feed recording paper manually.
 5. How to use Help.
 6. ECP Problems

- The display illustrations may differ slightly from the display of the actual product.
- The display details are subject to change without notice for improvement.

Setup (PC)

Activating the PANA LINK software

- 1 Click **Start**.
- 2 Point to **Programs**, point to PANA LINK and click **PANA LINK**.
 - The PANA LINK main panel will appear.

Send a fax To send a file created on the PC.	Scan To create an image file by scanning the document set in the fax machine.	Copy To make a copy of the document set in the fax machine.	Print To print a file created on the PC.
--	---	---	--

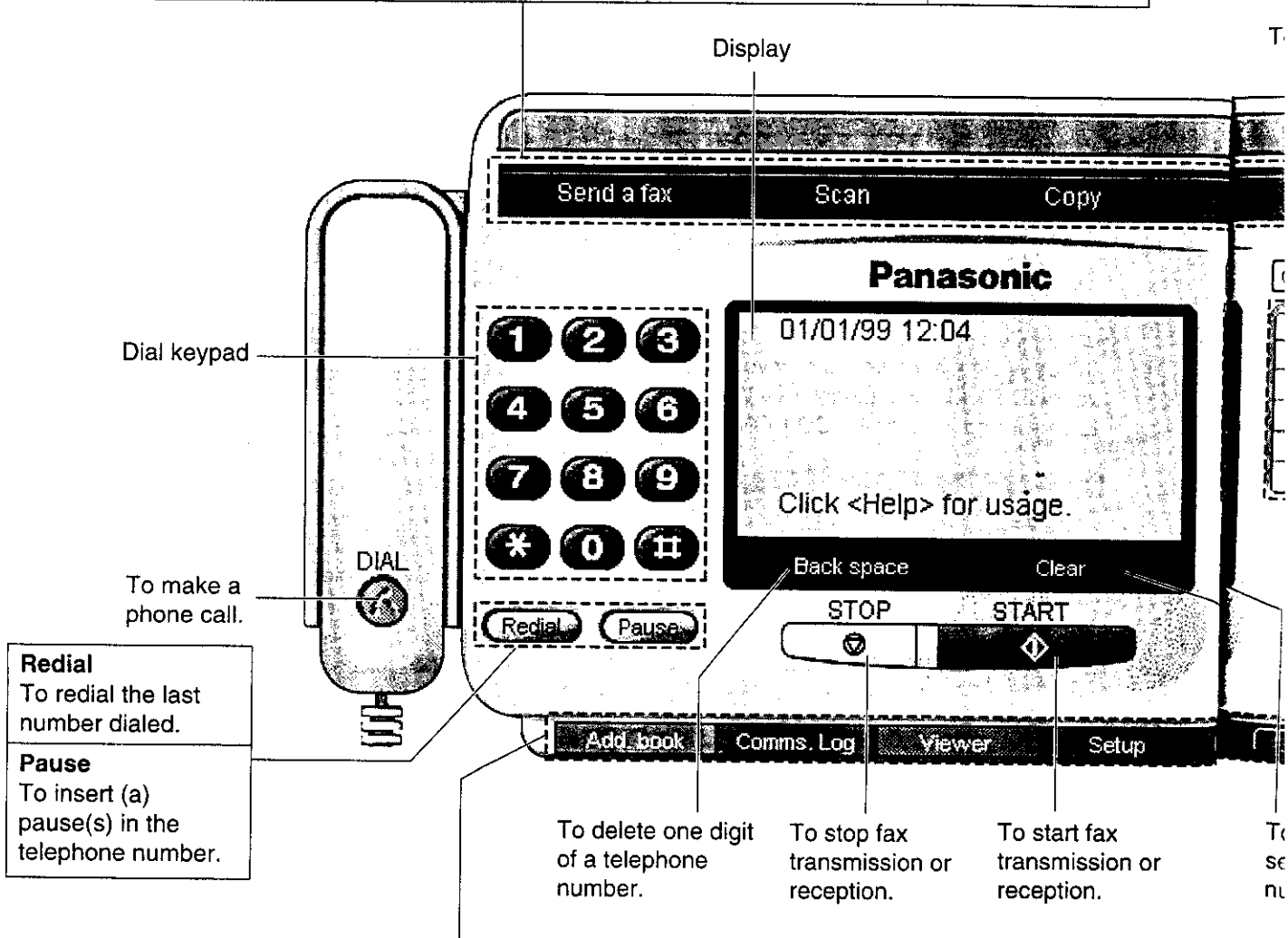

Redial To redial the last number dialed.
Pause To insert (a) pause(s) in the telephone number.

Add. book To store and view information in your address book.	Comms. Log To display the record of transmitted/received facsimile documents and manage the documents waiting to be sent.	Viewer To display an image sent or received with PANA LINK.	Setup To set PANA LINK options.	Help For detailed instructions on PANA LINK software.
---	---	---	---	---

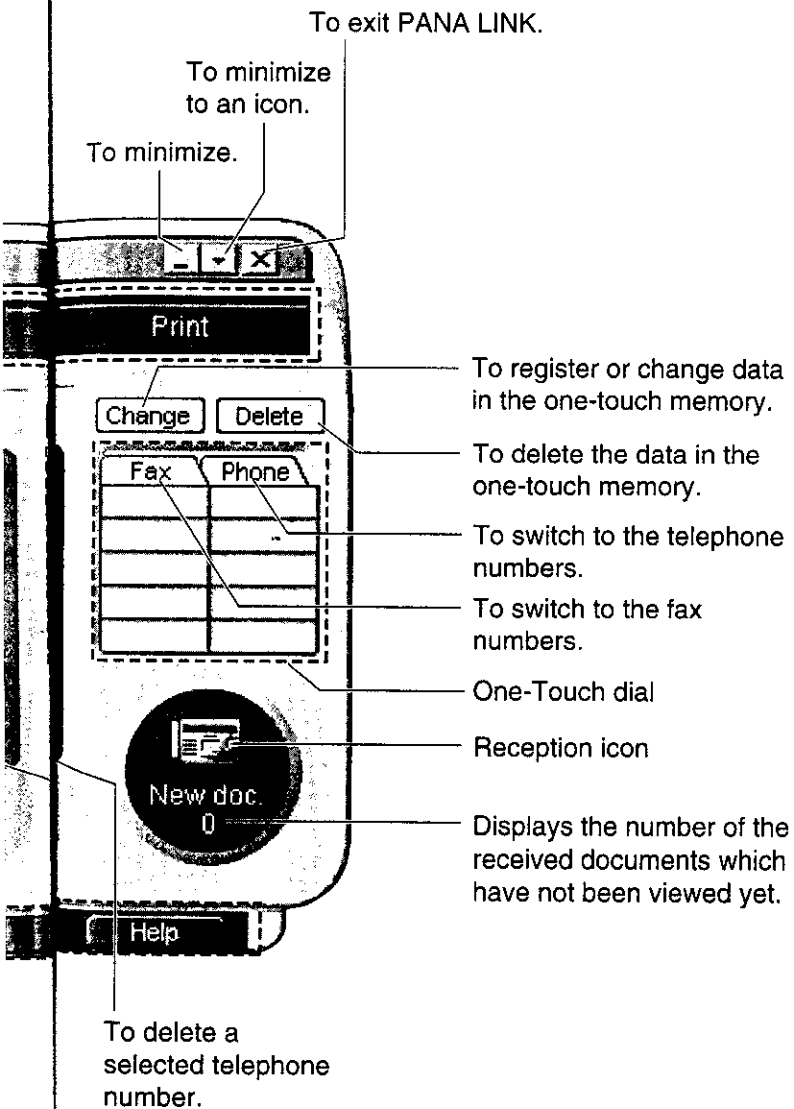

Setup (PC)

Setting up PANA LINK

The items which can be set are the Line, Transmission, Reception, System, User Information and Cover Page.

- 1 Open the **PANA LINK** main panel.

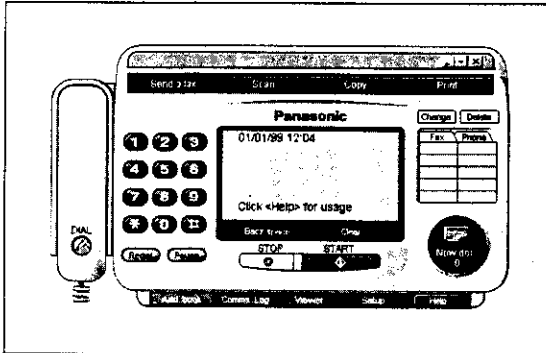

- 2 Click **Setup** in the main panel.

- The Setup dialogue box will be displayed.

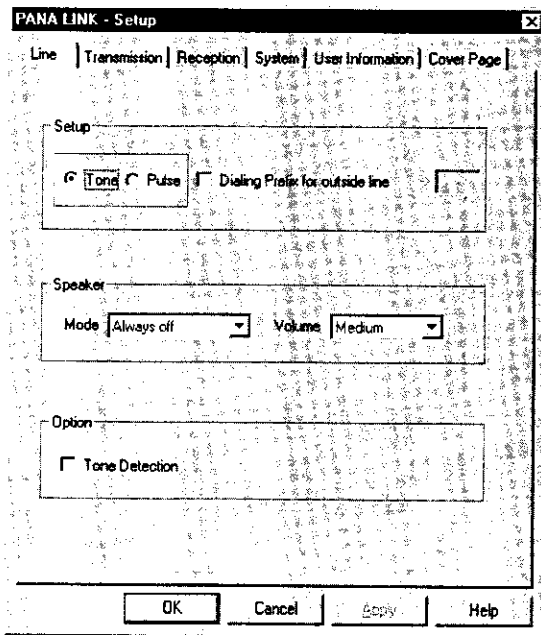

Note:

- For further details, use the Help function.

- 3 Change the set value in the Setup dialogue box.

- To change the value without closing the window, press **Apply**.

- 4 Click **OK**.

Setting user information

The information set here is used on your cover page and the header that prints on the top of each page you send from the PC.

- 1 Open the **PANA LINK** main panel.

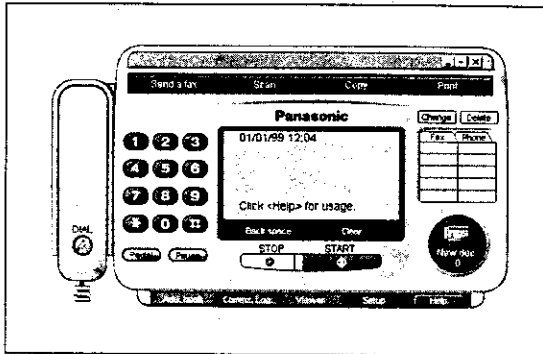

- 2 Click **Setup** in the main panel.

- The Setup dialogue box will be displayed.

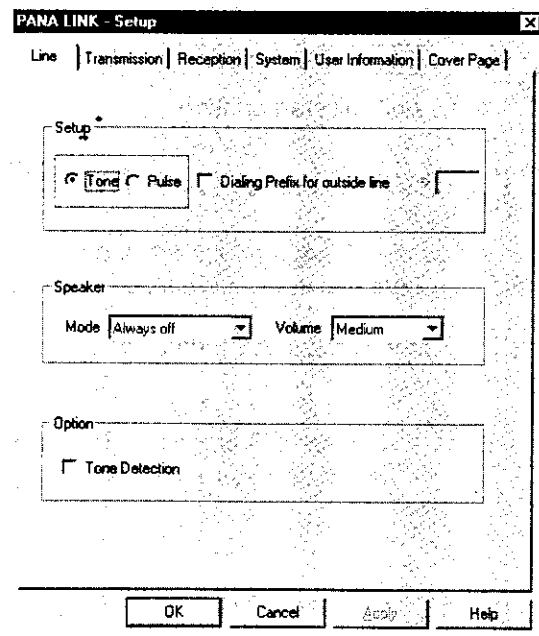

- 3 Click **User Information**.

- The User Information dialogue box will be displayed.

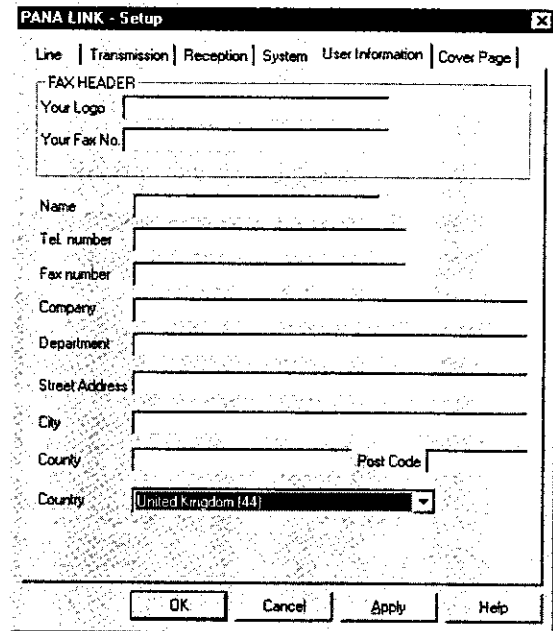

- The default setting for "Country" will depend on the model.

- 4 Enter your information for each item.

- 5 Click **OK**.

Printer

Printing documents created on the PC

You can print documents created from a Windows application.
Select Panasonic Fax Machine "Panasonic KX-FLM600/650" as the active printer.

Printing from Windows applications

For example, to print from Microsoft Word, proceed as follows.

1 Open the document you want to print.

2 Select **Print** from the File menu.

- The Print dialogue box will appear.

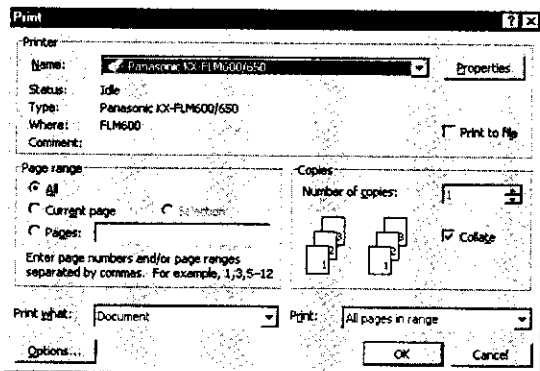

3 Select "Panasonic KX-FLM600/650" as the active printer.

- If you want to change the printer setting, click **Properties**. The printer setup dialogue box will appear.

You can change the following settings;
Resolution, Orientation, Paper Source,
Copies and Paper Size.

For details, see page 86.

4 Set the Page range and enter the number of copies.

5 Click **OK** in the Print dialogue box.

- The unit will start printing.

Note:

- For details about the printer driver, use the Help function.

Printing a selected file

You can print a specific file created with an application.

- 1 Open the **PANA LINK** main panel.

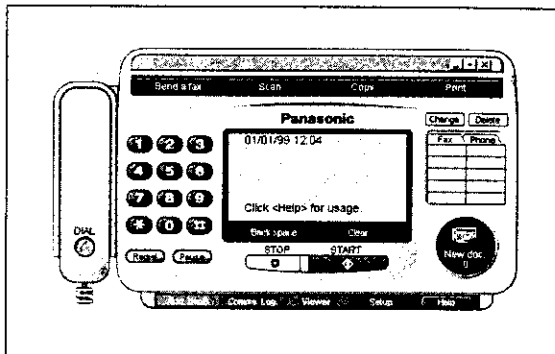

- 2 Click **Print** in the main panel.
 - The Open dialogue box will appear.

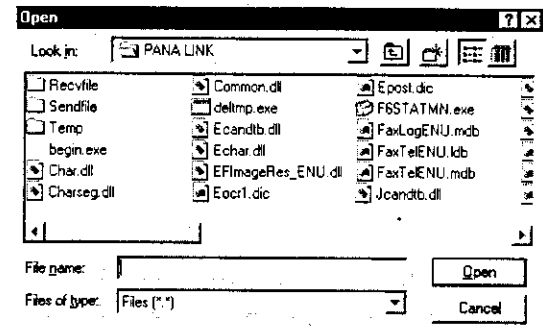

- 3 Select the file you want to print.
- 4 Click **Open** in the Open dialogue box.
 - The unit will start printing.
 - If an application which creates the file starts, follow the instructions for the application to print the file.

Printing from Windows 3.1

You can print documents from the Windows 3.1 applications. For example, to print from Write, use the Print command from the File menu.

- 1 Open the document you want to print.
- 2 Select **Print** from the File menu.
 - The Print dialogue box appears.

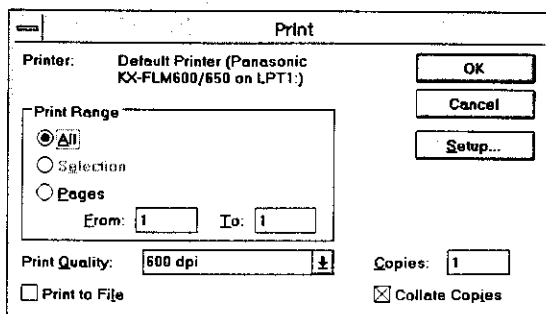

- 3 Click **Setup**.
 - The Print Setup dialogue box appears.

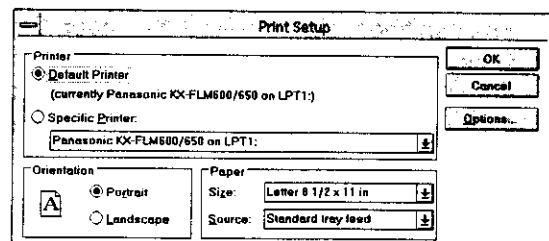

- By clicking Options in the Print Setup dialogue box, the Options dialogue box appears. You can change the following settings: Grayscale Settings, Graphics Options, Toner Save and Halftoned Text.

- 4 Click **OK**.
 - The Print dialogue box appears again.
- 5 Set the **Print Range** and the **Copies**.
- 6 Click **OK**.
 - The unit will start printing.

Printer

Setting up the printer driver

Panasonic KX-FLM600/650 dialogue box

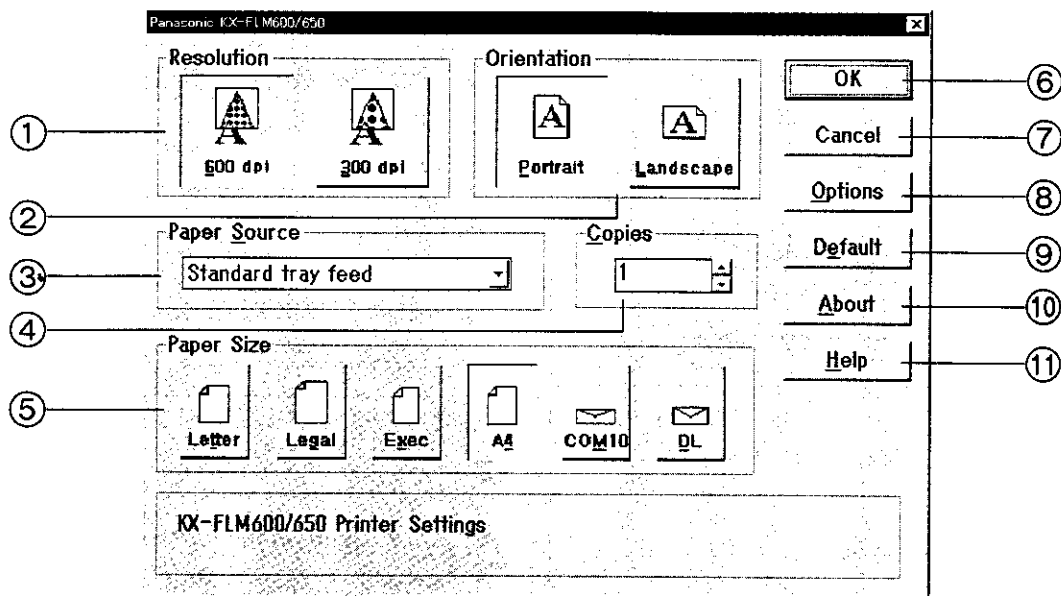

① Resolution

Choose print quality.

600 dpi: Use this setting to print documents with 600 dpi quality. Print speed may be slow.

300 dpi: Use this setting to print documents with 300 dpi quality. (When choosing this, you cannot change "Graphics Options" in the Options dialogue box.)

② Orientation

Click these buttons to set the print orientation.

Portrait: Use this setting to print in tall format.

Landscape: Use this setting to print in wide format.

③ Paper Source

You can choose how to feed the paper. Choose the following options from the Paper Source Setting drop down list box.

Standard tray feed: When selecting this option, you cannot select Exec, COM 10 and DL in the Paper Size.

Manual sheet feed: When selecting this option, you must feed paper into the unit by hand, one sheet at a time

④ Copies

Use this setting to make multiple copies of the same document. Enter the number of copies (up to 250) to be printed.

⑤ Paper Size

You can set the paper size. To choose the paper size, click the following buttons.

Letter: Standard US paper size [216 mm × 279 mm]
Set the recording paper size to "Letter" on the unit

Legal: US legal-sized paper size [216 mm × 356 mm]
Set the recording paper size to "Legal" on the unit

Exec: US executive paper size [184 mm × 267 mm]

A4: Standard European paper size [210 mm × 297 mm]
Set the recording paper size to "A4" on the unit

COM 10: Standard US envelope size [105 mm × 241 mm]

DL: Standard European envelope size [220 mm × 110 mm]

⑥ **OK:** Save all options you changed, and then close the dialogue box.

- ⑦ **Cancel:** Cancel the option setting operation for KX-FLM600/650, then close the dialogue box.
- ⑧ **Options:** The Options dialogue box appears. You can choose more detailed settings.
- ⑨ **Default:** Back to the default settings.
- ⑩ **About:** Display the version information of KX-FLM600/650.
- ⑪ **Help:** Display help.

Options dialogue box

When clicking the Options button in the Panasonic KX-FLM600/650 dialogue box, the Options dialogue box appears.

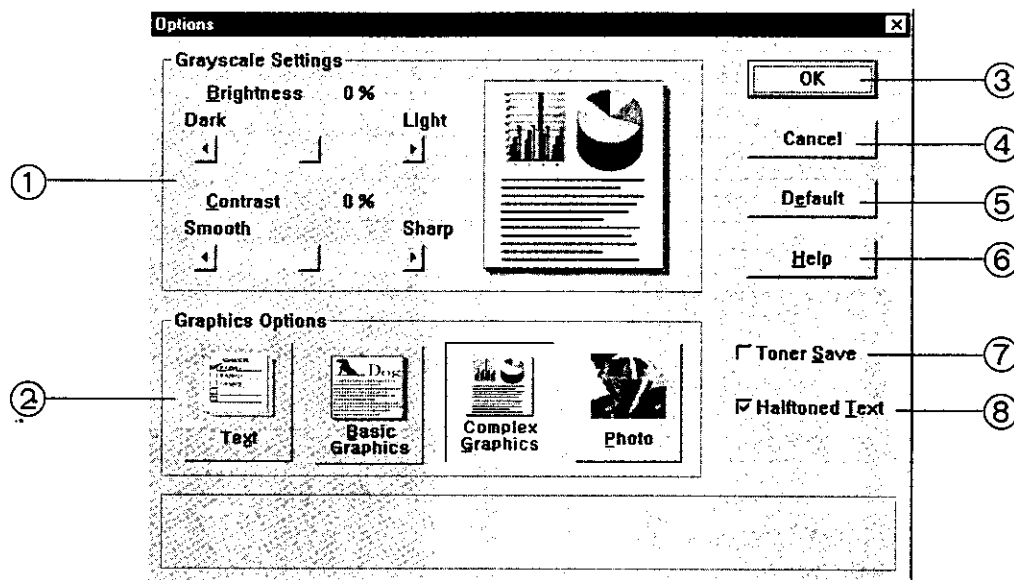

① Grayscale Settings

Adjust contrast and brightness of the printing image.

Brightness: Use this setting to make the printed image lighter or darker overall.

Contrast: Use this setting to control the range of difference between the light and dark areas of the pictures.

Note:

- The Brightness/Contrast settings may not change the print result in some cases. (For example, a text-only document.)

② Graphic Options

Choose one of the following options depending on an original document type or the purpose to print.

Text: Use this setting when the document is mostly text.

Basic Graphics: Use this setting to print simple charts and graphics.

Complex Graphics: Use this setting to print detailed line art.

Photo: Use this setting to print shaded images.

Note:

- When setting the Resolution at 300 dpi, you cannot change "Graphics Options".

- ③ **OK:** Save all options you changed, and then close the dialogue box.
- ④ **Cancel:** Cancel the option setting operation for KX-FLM600/650, then close the dialogue box.
- ⑤ **Default:** Back to the default settings.
- ⑥ **Help:** Display help.
- ⑦ **Toner Save:** Use this setting to use less toner. Shaded areas will be lighter.
- ⑧ **Halftoned Text:** Use this setting to print color texts as gray.

Printer

Printing using the paper tray (manual feeding)

With manual feeding, you can print on media other than letter or legal size plain paper.

Media you can print on

Media size

Media	Size	Dimension
Paper	Letter	216 mm × 279 mm (8½" × 11")
	Legal	216 mm × 356 mm (8½" × 14")
	A4	210 mm × 297 mm
	Executive	184 mm × 267 mm (7¼" × 10½")
Transparency	Letter	216 mm × 279 mm (8½" × 11")
	A4	210 mm × 297 mm
Envelope	COM10	105 mm × 241 mm (4⅛" × 9½")
	DL	110 mm × 220 mm

Paper weight

60 g/m² to 105 g/m²
(16 lb. to 28 lb.)

Loading a sheet manually

Important:

- You cannot load more than one sheet at a time.

- 1 Close the paper tray extender.
- 2 Press **START/SET/COPY** and check that the following message is displayed.

Display: **READY TO PRINT**

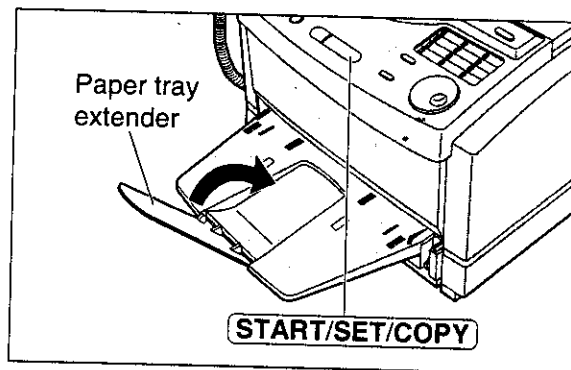

- 3 Place a sheet on the paper tray with printing side face down and align the edge of the sheet to the guide marks.
 - The sheet should not exceed the tabs on either ends of the paper tray.

- 4 Slide the sheet into the unit until it stops.
 - A few seconds later, the unit will feed the sheet.

- 5 To print, change the Paper Source setting in the printer setup dialogue box to Manual Sheet Feed (see next page).

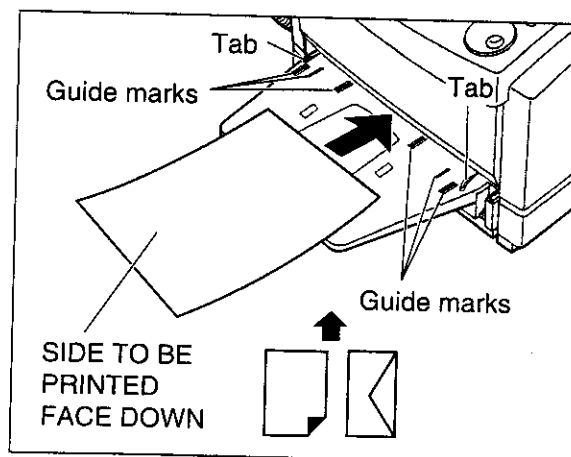

Note:

- Manual feeding is not possible when receiving or copying documents.
- Do not load a sheet while the unit displays the following message.

Display: PLEASE WAIT

- If you load another paper on the paper tray when the fax machine is feeding the paper, a paper jam may occur. When printing more than one sheet, place the sheets one by one after the message indicating to do so is displayed on your PC.
- Please read the README file (README.WRI) on the CD-ROM for more information.

Printing from Windows applications

You can feed recording paper manually for printing. The procedure is as follows.

- 1 Open the file you want to print on your computer.
- 2 Select **Print** from the File menu.
 - The Print dialogue box appears.
- 3 Click **Properties**.
 - The Panasonic KX-FLM600/650 dialogue box appears.
- 4 Select **Manual sheet feed** from the Paper Source drop-down list box, and click **OK**.
 - The Print dialogue box appears again. If necessary, set the Page Range and the Number of Copies.
- 5 Press **START/SET/COPY** on the fax machine and confirm the LCD message "READY TO PRINT".
- 6 Place a sheet on the paper tray, printing side down (p. 88).
 - Feed the sheets of recording paper one by one.
- 7 Click **OK**.
 - The fax machine will start printing.

- 8 The Manual Feed Required dialogue box appears when printing of each page has been completed.

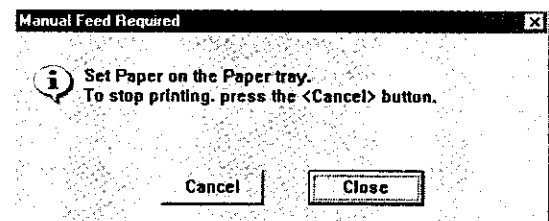

- If you want to cancel printing, click **Cancel**.
- If you want to continue to print:
 - A. Place another sheet on the paper tray.
 - B. Click **Close**.
 The Manual Feed Required dialogue box disappears. Start printing the next page.

*Even without clicking the Close button, printing is started automatically a few seconds after a sheet is placed on the tray.

Printer

Transparencies and labels

You may also print on labels and transparencies that are made for the printer.

Note:

- Labels must completely cover the backing material (see below).
- Re-using transparencies that have been fed through the printer once (for example, after jams or if the transparency is ejected without being printed) can reduce the life of the consumables and paper path components.
- Some types of paper, especially transparencies, are made to print on a specific side. If the print quality is poor, try printing on the other side.

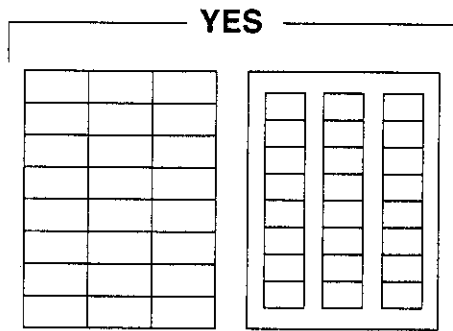

Labels cover the entire backing material.

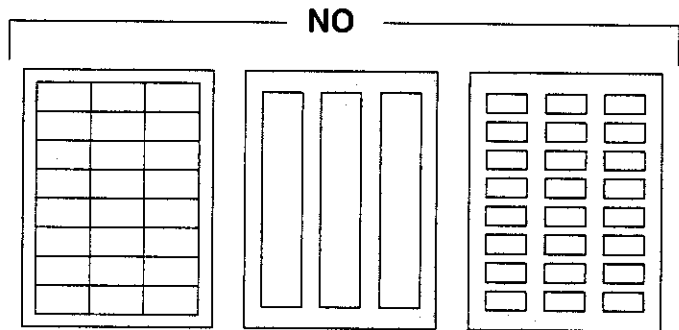

The backing material is exposed.

Envelope specifications

We recommend that you purchase only high quality envelopes with diagonal seams, as shown in the diagram below:

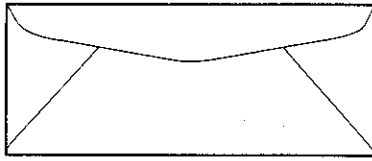

High quality envelopes have the following characteristics:

- A thin, sharply creased leading edge
- Paper weight of 75 g/m² (20 lb.)
- Flat, free of curls, wrinkles, nicks, etc.
- No cotton and/or fibre material included

Note:

- Wrinkles may occur in some cases, even if high quality envelopes are used.

We recommend that you do not use envelopes with any of the following characteristics (using these may result in paper jams):

- Irregularly shaped envelopes
- Envelopes with curls, wrinkles, nicks, twists, dog-ears or other damage
- Envelopes with side seam construction
- Highly textured envelopes, or envelopes with extremely shiny surfaces
- Envelopes that seal by removing a peel-off strip
- Envelopes with more than one flap to be sealed
- Self-adhesive envelopes
- Envelopes that are baggy or not sharply creased
- Embossed envelopes
- Envelopes that have previously been printed on

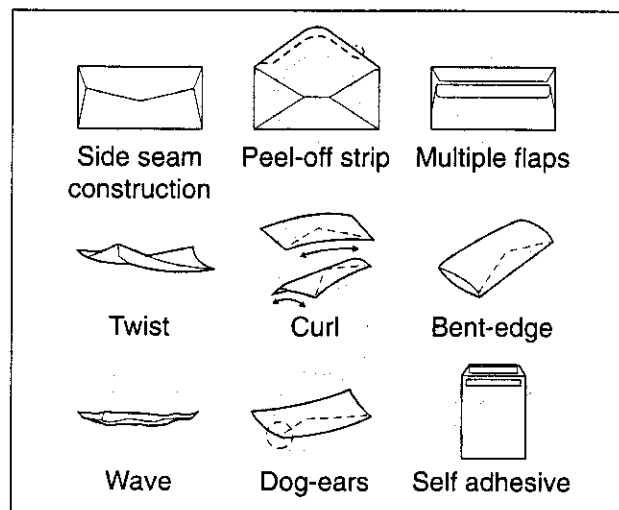

Do not attempt to print on any of the following types of envelopes (these may cause damage to your printer):

- Envelopes with clasps, snaps or tie strings (see Fig. 1)
- Envelopes with transparent windows (see Fig. 2)
- Envelopes that will melt, discolor, scorch, offset or release hazardous emissions when exposed to 200°C (392°F) for 0.1 second
- Envelopes that use encapsulated types of adhesive that do not require moistening but rely on pressure to seal them

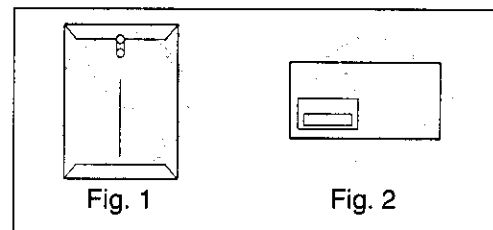

Always test a sample of the envelopes you are thinking of buying. Check that the envelope performs satisfactorily.

For best printing results

- Avoid printing in high humidity i.e., above 70%.
High humidity may cause the envelope to curl and pick up excess toner.
High humidity may also cause the envelope to seal.
- Avoid printing below 10°C (50°F) with less than 30% relative humidity.
Low temperature with low humidity may cause light printing.
- Print only one envelope at a time.

Envelope storage is very important. Store them away from moisture and humidity, where they can lay flat and their edges will not be bent or damaged. Humidity should not exceed 70% RH.

Sending documents created on the PC

Sending a document created by an application as a fax message

You can access the fax function from a Windows application by using the Print command in the File menu. Select **PANA LINK FAX** as the active printer.

For example, to send a document created from Microsoft Word, proceed as follows.

- 1 Open the document you want to send.
- 2 Select **Print** from the **File** menu.
 - The Print dialogue box will appear.

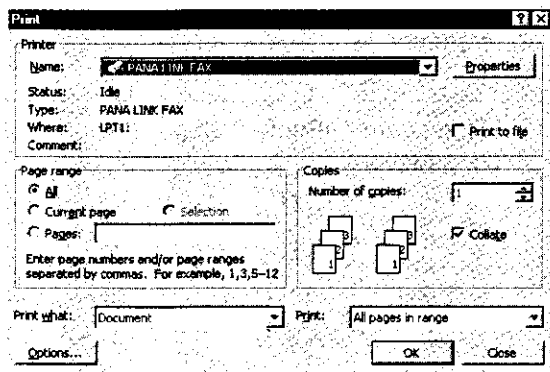

- 3 Select **PANA LINK FAX** as the active printer.
- 4 Click **OK** in the Print dialogue box.
 - If the PANA LINK application has not started yet, it will start now, and one item will be added to it as the transmission document.

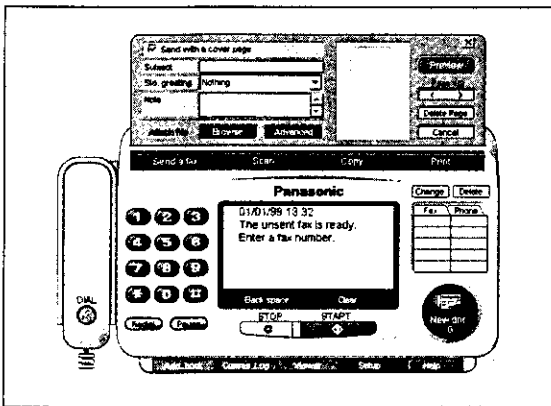

- 5 Enter the fax number to which you want to send the document.

- To enter the telephone number, you can use the Dial keypad, One-Touch dial or the Add. book.

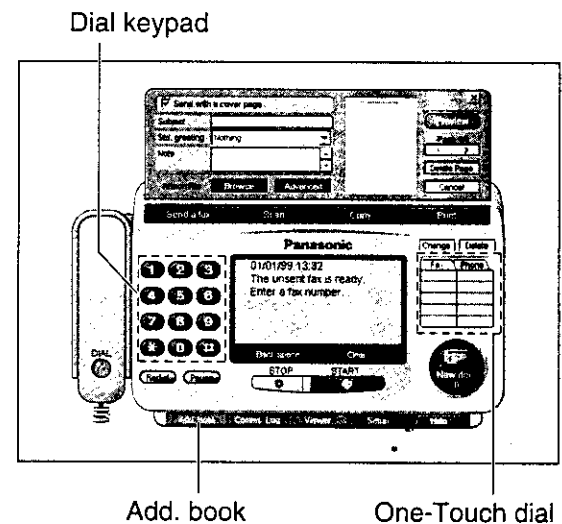

- 6 Click **START** in the main panel.
 - The document will be sent.

Note:

- To cancel transmission after dialing, click **STOP** in the main panel or press **STOP** on the fax machine.
- When you click **START** to send the selected file, any document set on the fax machine will also be sent at the same time.

Sending a file from the PANA LINK window

- 1 Open the **PANA LINK** main panel.

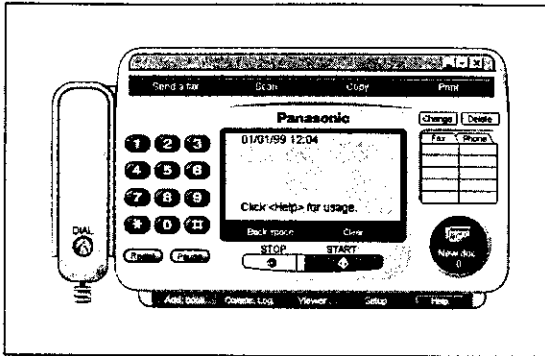

- 2 Click **Send a fax** in the main panel.
 - The Send fax panel will be displayed.

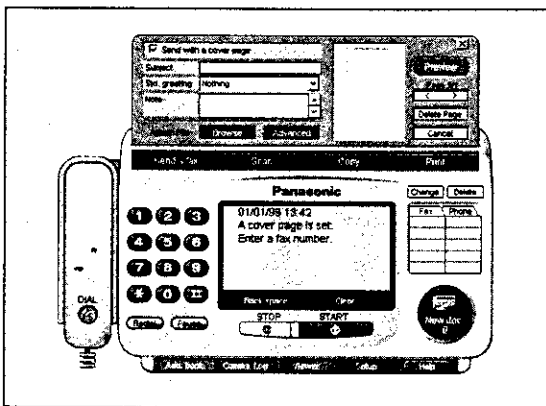

- 3 Click **Browse** in the Send fax panel.
 - The Open dialog box will be displayed.

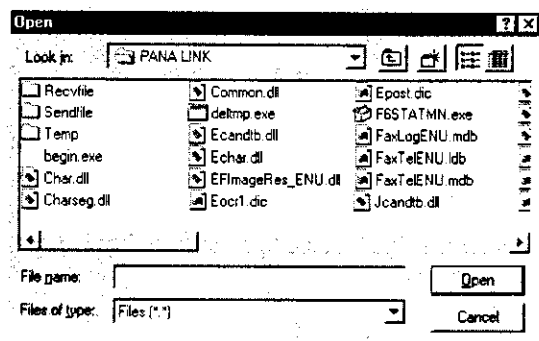

- 4 Select the file you want to send, and click **Open**.

- An image of the file will be displayed in the preview window.

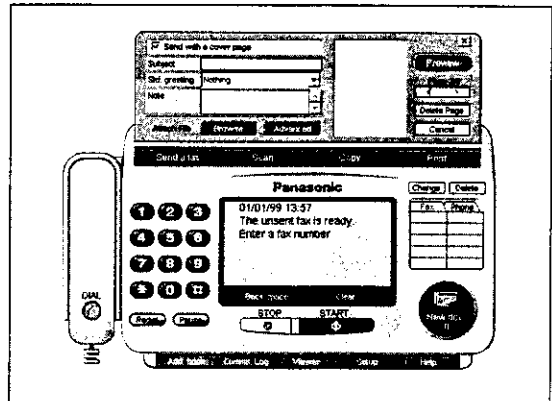

- 5 Enter the fax number to which you are going to send the file.

- To enter the telephone number, you can use the Dial keypad, One-Touch dial or the Add. book.

Dial keypad

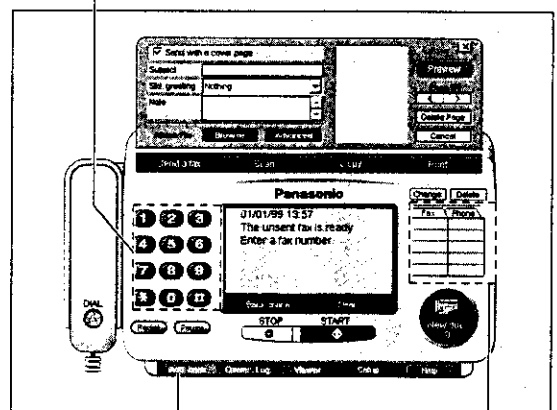

Add. book

One-Touch dial

- 6 Click **START** in the main panel.

- The document will be sent.
- If an application which creates the file starts, follow the instructions for the application to send the file.

Note:

- To cancel transmission after dialing, click **STOP** in the main panel or press **STOP** on the fax machine.
- When you click **START** to send the selected file, any document set on the fax machine will also be sent at the same time.

The PANA LINK FAX Properties dialogue box

This dialogue box has three tabs as follows.

Paper tab

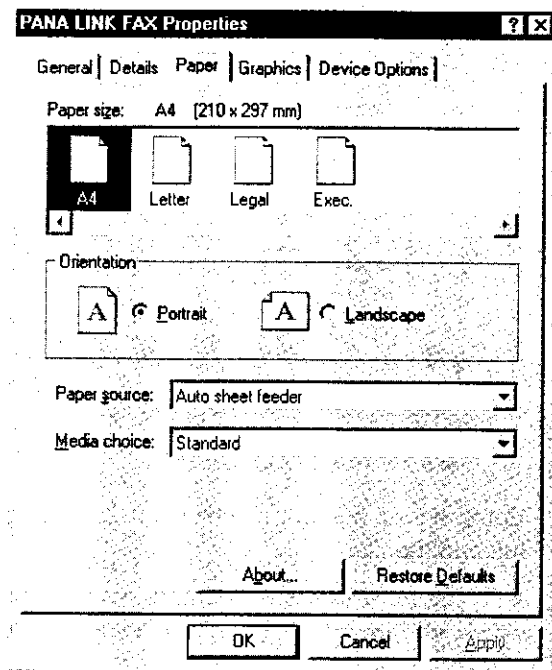

• Paper size

You can set the paper size. To choose the paper size, click the following buttons.

- A4:** Standard European paper size [210 mm × 297 mm]
- Letter:** Standard US paper size [216 mm × 279 mm]
- Legal:** US legal-sized paper size [216 mm × 356 mm]
- Executive:** US executive paper size [184 mm × 267 mm]

• Orientation

Click these buttons to set the print orientation.

- Portrait:** Use this setting to print in tall format.
- Landscape:** Use this setting to print in wide format.

- You cannot change **Paper source** and **Media choice**.

Graphics tab

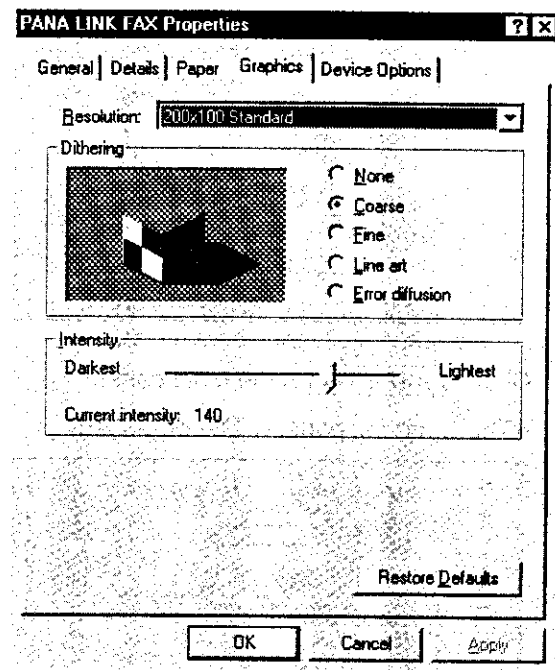

• Resolution

Specifies the resolution you want for graphic images. Generally, higher resolution settings produce higher quality printing; however, your documents may take longer to print.

Select the desired resolution according to the type of document.

- Standard (200 × 100 dpi)**
- Fine (200 × 200 dpi)**
- Super Fine (200 × 400 dpi)**

• Dithering

Specifies the type of dithering used in printing. For colour printing, dithering blends pure colours into patterns to simulate a wider range of colours. For example, orange is produced by blending red and yellow. For non-colour printing, dithering produces gray shading in graphics.

- None:** Click this if you do not want any dithering.
- Coarse:** Click this if your resolution setting is 300 dpi or higher.
- Fine:** Click this if your resolution setting is 200 dpi or less.
- Line Art:** Click this if your graphics include well-defined borders between black, white and gray shadings.

• Error

Diffusion: Click this for printing photographs or pictures that do not have sharp, well-defined edges.

• Intensity

Specifies how dark to print graphics in your document.

Device Options tab

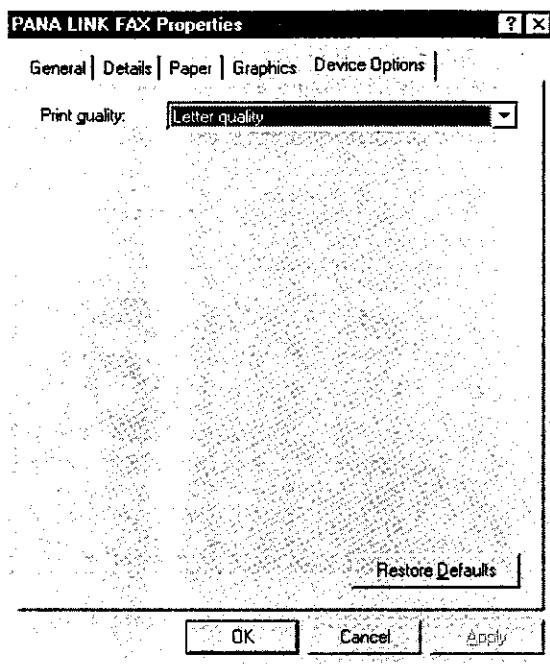

- **Print quality**
Specifies the text quality you want to use for your printed document.

PC Fax

Sending a document from the fax machine using the PC

- 1 Place the document on the fax machine.

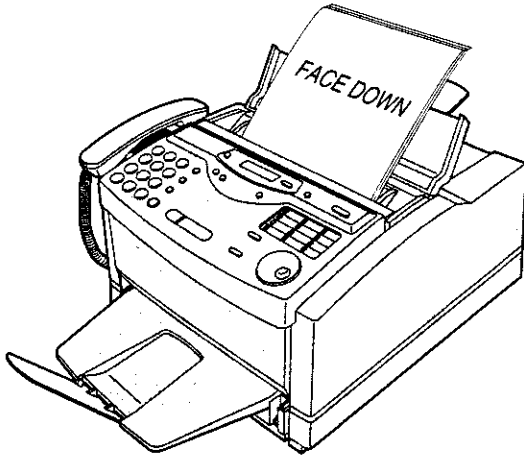

- 2 Open the PANA LINK main panel.

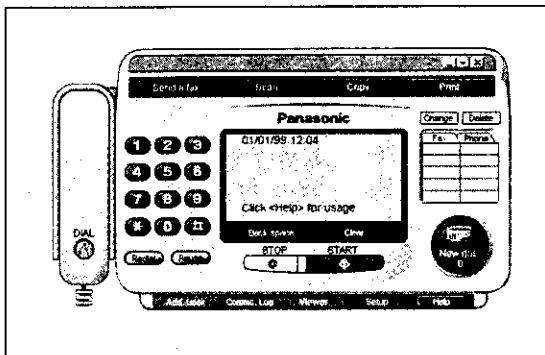

- 3 Enter the fax number to which you want to send the document in the main panel.

- To enter the telephone number, you can use the Dial keypad, One-Touch dial or the Add. book.

Dial keypad

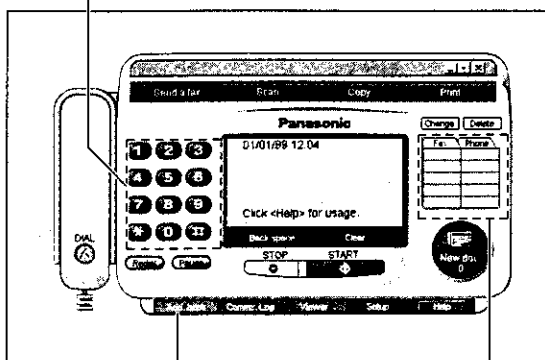

Add. book

One-Touch dial

- 4 Click **START**.

- A dialogue box to set the image quality, type and brightness will be displayed.

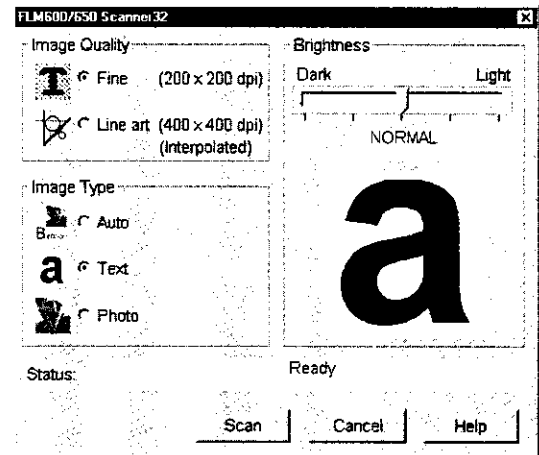

- 5 Set the image quality, type and brightness, and click **Scan**.

Note:

- To cancel transmission after dialing, press **STOP** on the fax machine.

Receiving faxes on your PC

You can receive a fax on the computer.

The received facsimile document is saved as an image file (TIFF-G4 format), and which you can view, print or send again.

To receive manually

You can receive manually during a telephone conversation.

- 1 Open the **PANA LINK** main panel.

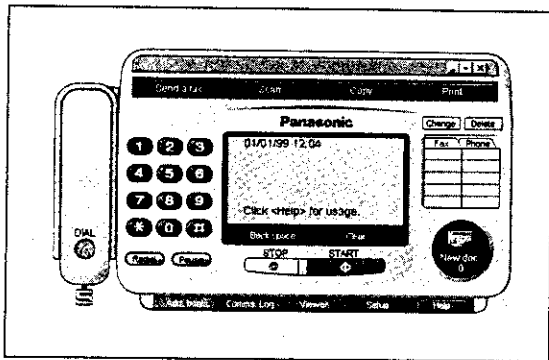

- 2 Click **START** in the main panel.

To receive automatically

You can receive faxes to your PC automatically.

- 1 Set the fax machine to the **AUTO ANSWER** mode by pressing **AUTO ANSWER**.

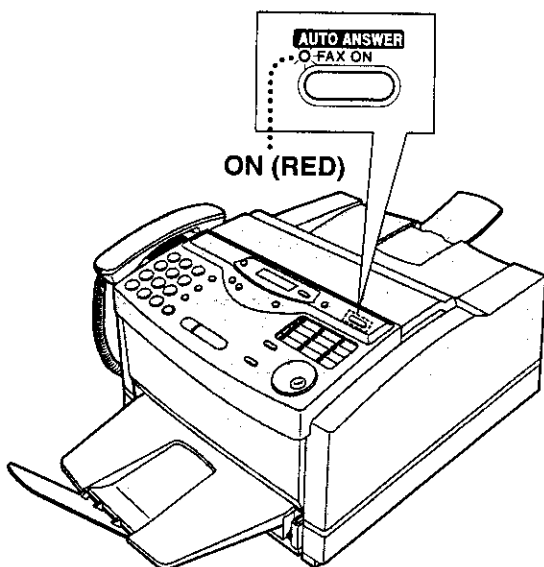

- 2 Open or minimize the **PANA LINK** main panel.

PC Receiving

To receive directly to the fax machine

If you do not want to be disturbed by incoming faxes when using the PC, but want faxes to go directly to your facsimile machine, follow these steps.

1. Click **Setup** in the main panel.
 - The Setup dialogue box will appear.
2. Click the **Reception** tab in the dialogue box.
3. Click "Receive directly to facsimile unit".
4. Click **OK**.

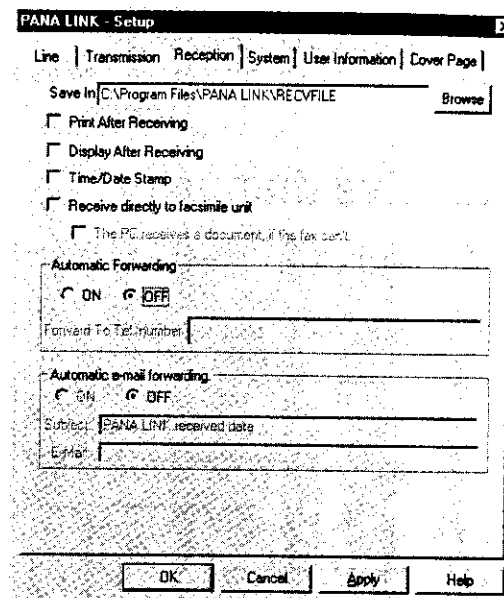

Confirming the result of reception

1. Open the **PANA LINK** main panel.

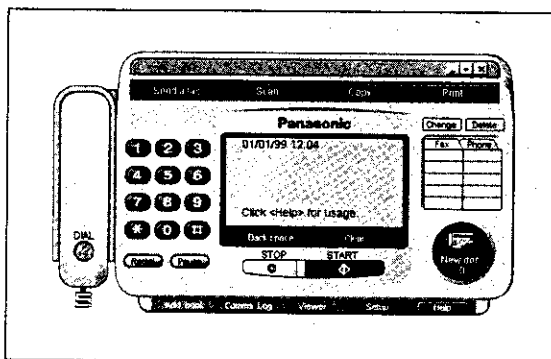

2. Click on the **reception icon (New doc.)** in the main panel, or click on **Comms. Log** and switch to the Received log.

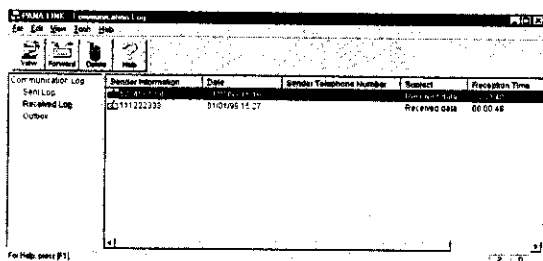

3. Click on the items in the Received log which have not been viewed yet (icon).

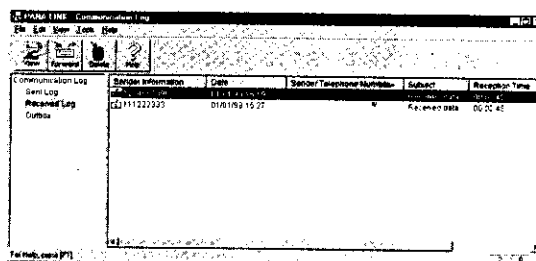

4. Click on **File** in the menu bar, then click on **View**, or click **View** in the toolbar.

- The Viewer dialogue box will appear, and the received fax will be displayed.

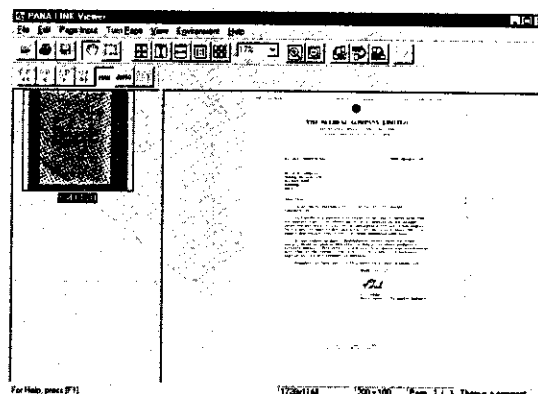

Making a phone call

You can place a phone call using PANA LINK.
Use the handset on the fax machine to talk.

- 1 Open the PANA LINK main panel.

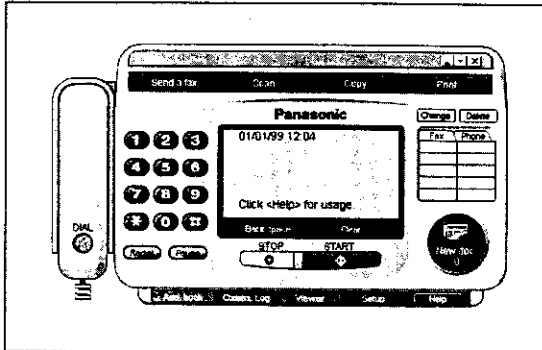

- 2 Enter the telephone number in the main panel.
 - You can select the telephone numbers using the following methods: Dial keypad, One-Touch dial, Add. book or Redial. The main panel indicator will display "Start calling by pressing the <Dial>."

Dial keypad

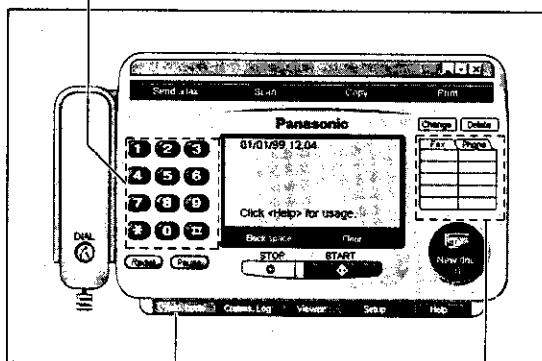

Add. book

One-Touch dial

- 3 Click **Dial**.

- The main panel indicator will display "Lift the fax machine's handset to talk."

- 4 Lift the fax machine's handset.

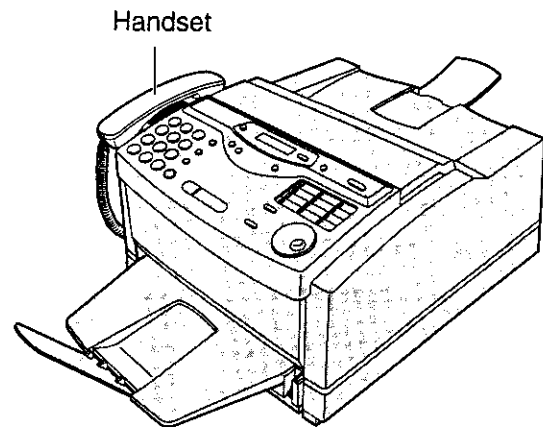

Address Book

Computerized directory for fax and phone numbers

The Address Book is your personal information database for fax and phone numbers.

- 1 Open the **PANA LINK** main panel.

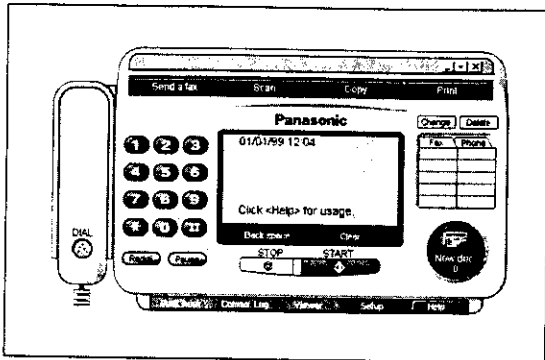

- 2 Click **Add. Book** in the main panel.
 - The Address Book window will appear.

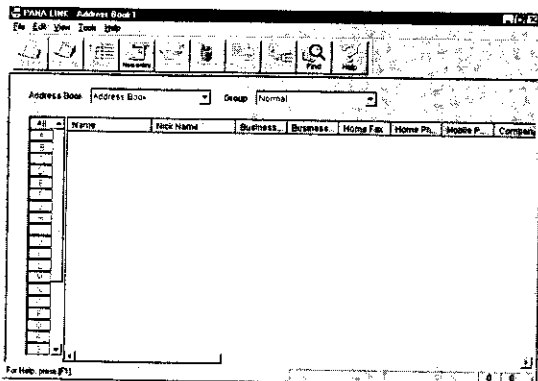

- 3 Select **New entry** from Edit menu or click **New entry** in the toolbar.

- A dialogue box to register personal information will appear.

A screenshot of the 'New Address Book Data' dialog box. It has a title bar 'New Address Book Data'. The 'Setup Name' section includes fields for 'Name', 'Nick name', 'Title' (with a dropdown menu showing 'Nothing'), and 'Job Title'. Below are fields for 'Company', 'Department', 'Business Fax', 'Business Phone', 'Home Fax', and 'Home Phone'. The 'Address' section includes fields for 'Street Address', 'City', 'Country', and 'Post Code'. There is also a 'Note' field and an 'E-Mail' field. At the bottom, there is a 'Default number to use' dropdown menu and a note: 'The select box must be completed.'. 'OK', 'Cancel', and 'Help' buttons are at the bottom right.

- 4 Enter the personal information in each space.
 - The name is required.

- 5 Click **OK**.
 - The registered information will be shown in the list.

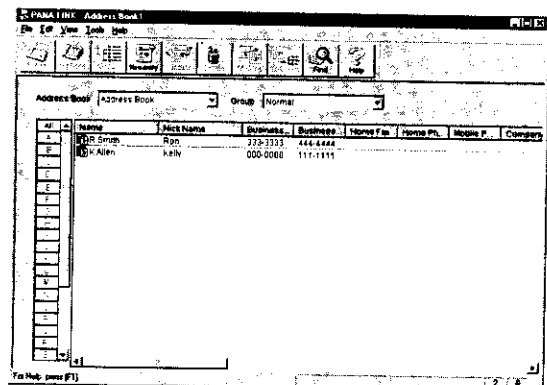

Broadcast

When sending the same document to more than one location, you can use the "Group" function in the Address Book. You may select as many locations as you want from the Address Book.

Using your fax machine as a scanner

Scanning from Windows 95/98

Create an image file (TIF format) by scanning the document which is set in the fax machine.

- 1 Set the document which you are going to scan, in the fax machine.

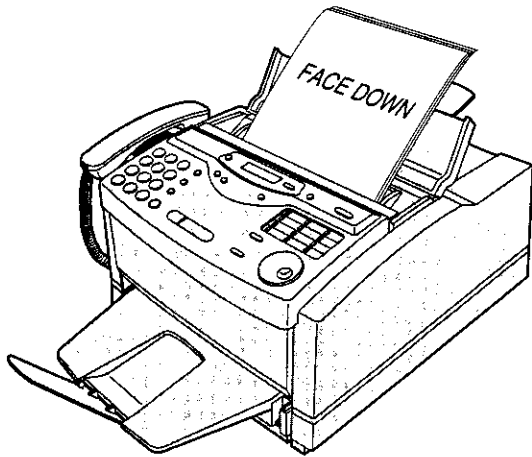

- 2 Open the PANA LINK main panel.

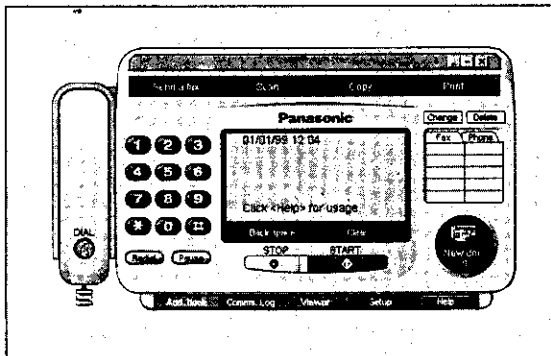

- 3 Click **Scan** in the main panel.
 - The Scan dialogue box will appear.

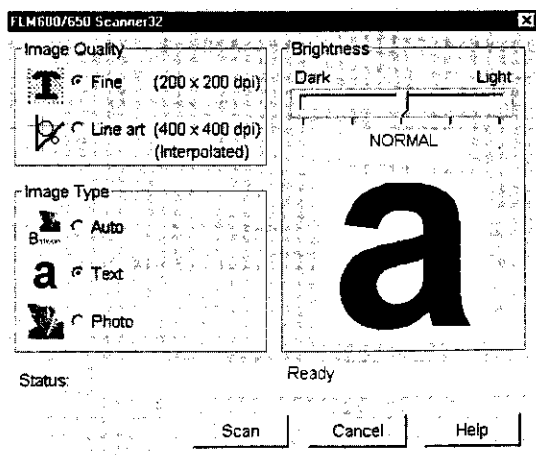

- 4 If necessary, change the setting of **Image Quality**, **Image Type** and **Brightness**. For details, see pages 103 and 104.

- 5 Click **Scan**.
 - The Viewer window will appear after scanning, and the scanned image will be displayed in it.

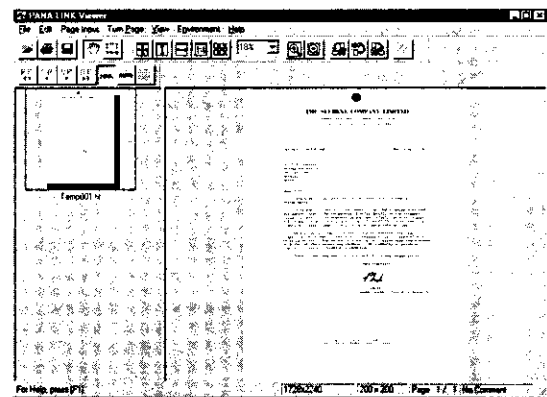

- 6 To save the scanned image, select **Save As** from the **File** menu.

Note:

- While scanning, do not move the pages which have already been ejected. A paper jam may occur. Allow the scanning process to finish before viewing documents.
- To cancel scanning while the document is being scanned, press **STOP** on the fax machine.

Scanning

Scanning from Windows 3.1

To scan a document into your PC as an image file, you need an application which contains a scanning feature such as Visioneer PaperPort.

- 1 Set the document you are going to scan on the unit.

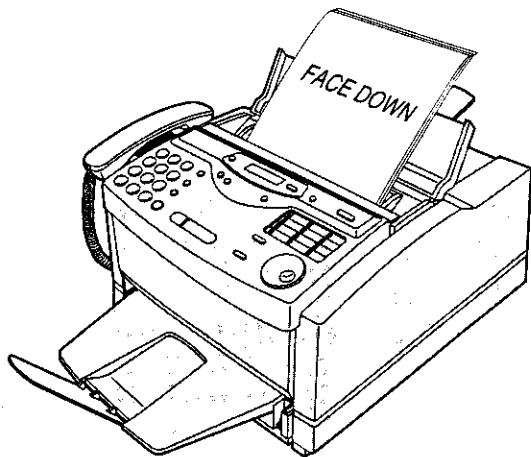

- 2 Start Visioneer PaperPort.
 - The Visioneer PaperPort window appears.

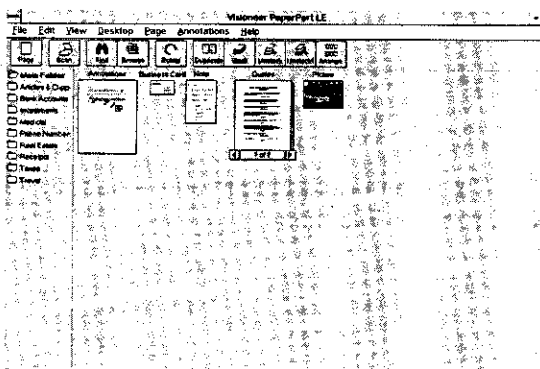

- 3 Select **Select Source** from the File menu.
 - The Select Source dialogue box appears.

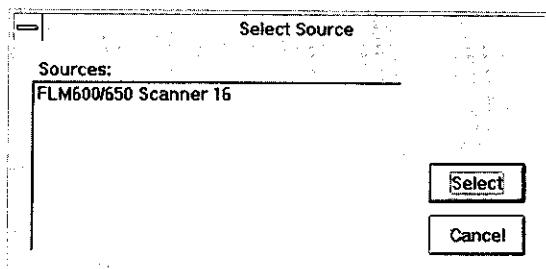

- 4 Select **FLM600/650 Scanner 16** in the Source list box, and then click **Select**.

- 5 Select **Acquire** from the File menu.
 - The FLM600/650 Scanner 16 dialogue box appears.
 - If necessary, change the setting of Image quality, Image Type and Brightness.

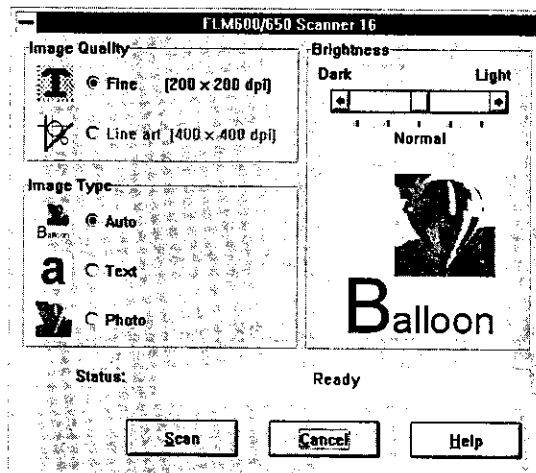

- 6 Click **Scan**.
 - The scanned document is displayed in the Viewer window after scanning.
- 7 To save the scanned image, select **Save As** from the **File** menu.

Note:

- To cancel scanning while the document is being scanned, press **STOP** on the fax machine.

FLM600/650 Scanner 32

The FLM600/650 Scanner dialogue box is displayed when you click the Scan button on the PANA LINK Main panel.

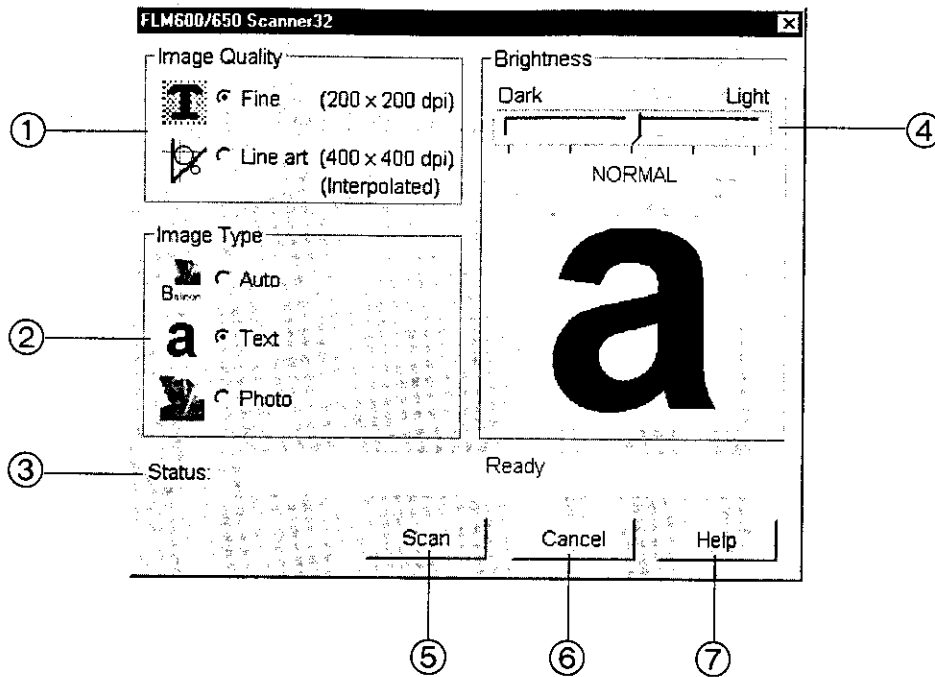

You can set up the following items to improve an image file.

① Image Quality

You can set the image quality to scan.

Fine (200 × 200 dpi): For a text document with small writing or a document with a simple graphic.

Line art (400 × 400 dpi): For a document with complicated graphics or very small text. (400 × 400 dpi: interpolated)

② Image Type

You can set the image type to scan.

Auto: Sets the image type automatically.

Text: For a text document. (We recommend this as a default.)

Photo: For a photograph.

③ Status

Shows the current state of the unit.

The following messages are displayed depending on the state of the unit.

Message	State
Ready	A document is set on the unit. Please click the Scan button for scanning.
Please insert document to scan.	A document is not set on the unit. Please set a document on the feeder tray.
Scanning	The unit is scanning a document.
FLM600/650 unit power is off. Plug the unit in and try again.	The power of the unit is off or unplugged, or the PC is not connected to the FLM600/650. Please check.
FLM600/650 unit is warming up.	The unit is warming up. Please wait for a while.

Scanning

④ **Brightness**

You can adjust brightness by using the slider.

Normal: Brightness is not adjusted. You can adjust the brightness based on the result of this scan.

Light: Use this when scanning a dark document.

Very Light: Use this when scanning a very dark document.

Dark: Use this when scanning a light document.

Very Dark: Use this when scanning a very light document.

⑤ **Scan:** To start scanning.

You can use this button only when a document to be scanned is set.

⑥ **Cancel:** Close the FLM600/650 Scanner dialogue box.

⑦ **Help:** Display help.

PC based copying

- 1 Set the document which you are going to copy in the fax machine.

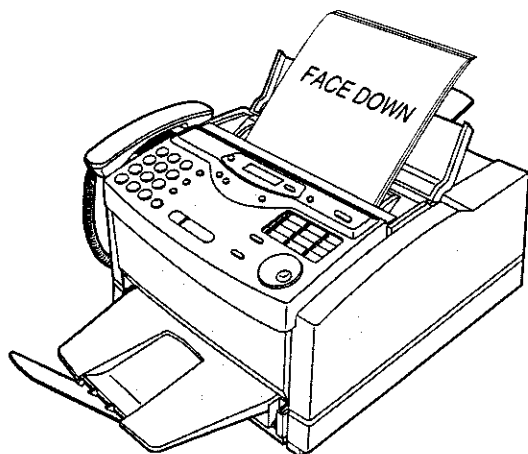

- 2 Open the PANA LINK main panel.

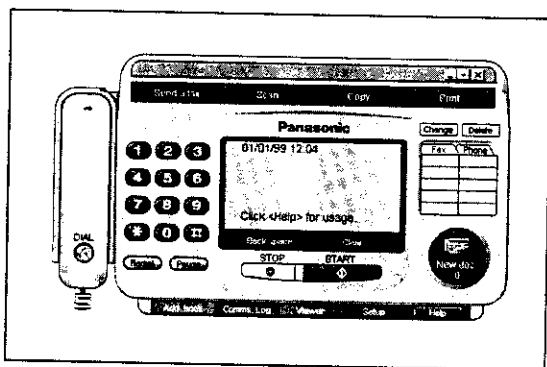

- 3 Click **Copy** in the main panel.
 - The Copier dialogue box will appear.

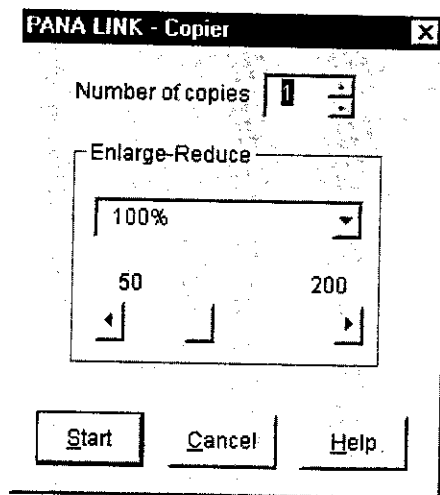

- 4 Enter the number of copies required in Number of copies.

- 5 If necessary, change the setting of Enlarge-Reduce.

- 6 Click **Start**.
 - The Scan dialogue box will appear.

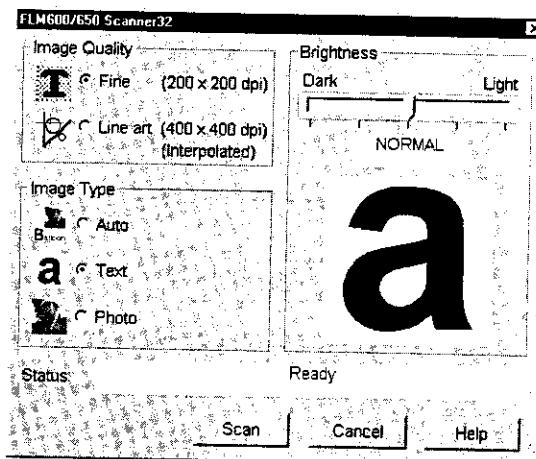

- 7 If necessary, change the setting of Image Quality, Image Type and Brightness.

- 8 Click **Scan**.
 - The fax machine will start scanning the documents, and will then print the copies.

Note:

- While scanning, do not move the pages which have already been ejected. A paper jam may occur. Allow the scanning process to finish before viewing documents.
- To cancel copying while the document is being scanned, press **STOP** on the fax machine.

More Information

The Communication Log

It is possible to view a list of faxes sent or received from the PC, and to view their contents. It is also possible to forward or resend these faxes.

- 1 Open the PANA LINK main panel.

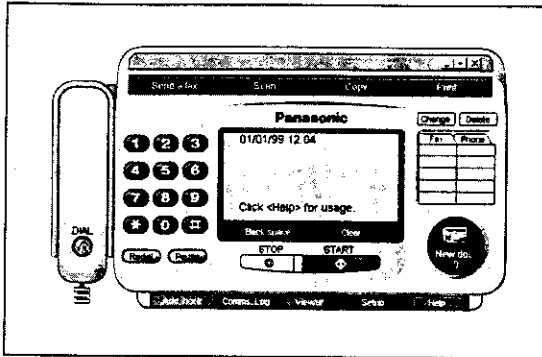

- 2 Click **Comms. Log** in the main panel.
 - The Communication Log window will appear.

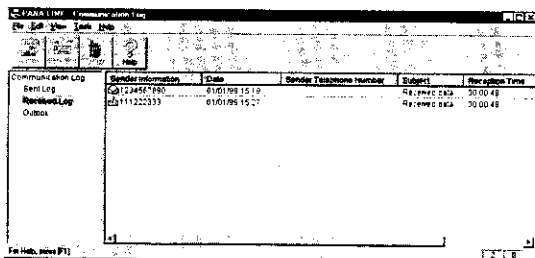

- 3 Select an item from Communication Log.
 - The content of the log will be displayed.

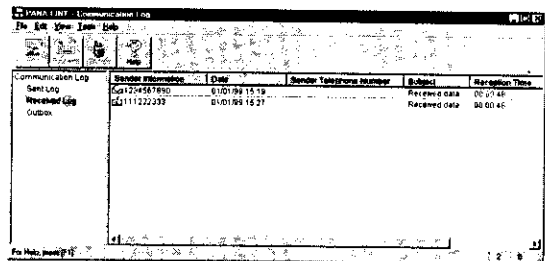

Note:

- As the transmitted image files will remain in the hard disk, please check regularly that there is enough free space.

Viewer

It is possible to display the images sent, received, or scanned with PANA LINK.
It is possible to move, copy and delete a file or page.
From the Viewer, it is also possible to send an image as a fax.

- 1 Open the PANA LINK main panel.

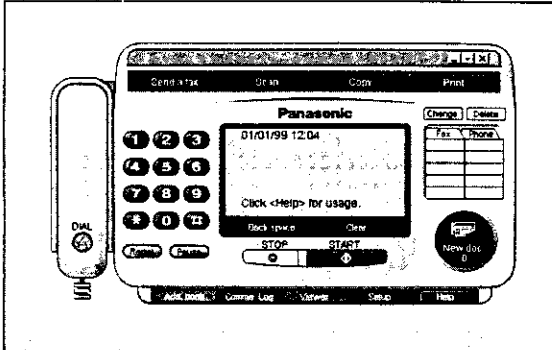

- 2 Click **Viewer** in the main panel.
 - The Viewer window will appear.

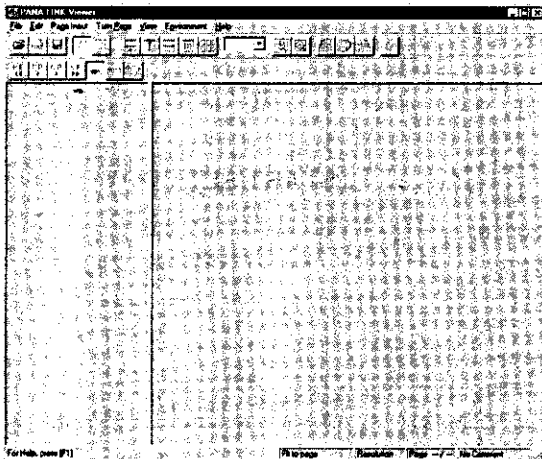

- 3 Click on **File** then **Open** in the menu bar, or click the **Open** in the tool bar in the main panel.

- The Open this document dialogue box will appear.

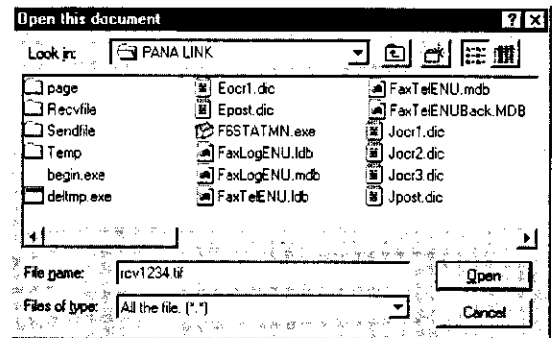

- 4 Select the file you want to view.

Note:

- Text on the image cannot be edited.

More Information

PC link (turning PC related functions on/off)

The PC LINK feature is "ON" by default.

If the AUTO ANSWER mode is turned on, all faxes will be received at your PC automatically.

If you do not want to be disturbed by incoming faxes when using the PC, but want to receive faxes directly to your fax machine, do one of the following.

—Turn off the PC LINK on the fax machine.

—Select "Receive directly to facsimile unit" on the PC (p. 98).

To turn off the PC LINK on the fax machine

•When this feature is off, operations from your PC, such as fax transmission/reception, scanning, or copying are not available.

1 Press **MENU**.

Display: 1. SYSTEM SET UP

2 Press **#**, then **1** **4**.

PC LINK

3 Press **START/SET/COPY**.

MODE=ON ▼▲

4 Press ▼ or ▲ to select "OFF".

MODE=OFF ▼▲

•To turn on the PC LINK on the fax machine, select "ON".

5 Press **START/SET/COPY**.

SETUP ITEM []

6 Press **MENU**.

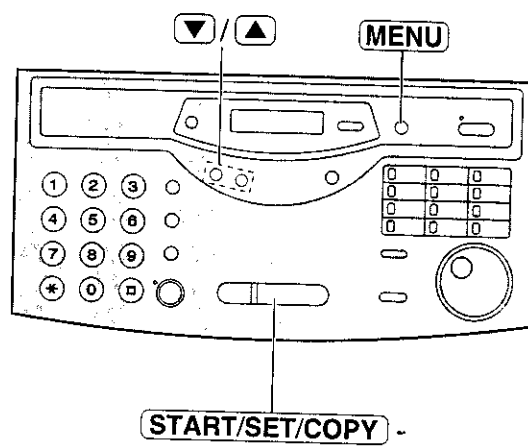

Reports

If your unit cannot send a fax, check the following.

—The number you dialed is correct.

—The other party's machine is a facsimile.

If the problem remains, correct it by following the communication message printed on the sending and journal reports (p. 47, 48).

Communication message	Error code	Cause & Remedy
COMMUNICATION ERROR	41-72 FF	<ul style="list-style-type: none"> •A transmission or reception error occurred. Try again or check with the other party.
DOCUMENT JAMMED	—	<ul style="list-style-type: none"> •The document is jammed. Remove the jammed document (p. 122). •A sheet of paper was inserted from the paper tray while scanning the document. Remove the paper from the paper tray.
ERROR-NOT YOUR UNIT	54, 59 70	<ul style="list-style-type: none"> •A transmission or reception error occurred because of a problem with the other party's fax machine. Check with the other party.
MEMORY FULL	—	<ul style="list-style-type: none"> •The document was not received due to memory being full.
NO DOCUMENT	—	<ul style="list-style-type: none"> •The document was not fed into the unit properly. Reinsert the document and try again.
OTHER FAX NOT RESPOND	40	<ul style="list-style-type: none"> •The other party's fax machine was busy or ran out of recording paper. Try again. •The document was not fed properly. Reinsert the document and try again. •The other party's fax machine rings too many times. To send a fax manually, dial the number, confirm the fax tone, and press START/SET/COPY. •The other party's machine is not a facsimile. Check with the other party. •The number you dialed is not in service.
PC FAIL OR BUSY	—	<ul style="list-style-type: none"> •The PC cannot control the fax functions. The printer cable is not connected correctly, or the software is not running on the PC (p. 78-81).
PRESSED THE STOP KEY	—	<ul style="list-style-type: none"> •STOP was pressed and fax communication was cancelled.
TOP COVER WAS OPENED	—	<ul style="list-style-type: none"> •The top cover was opened. Close it and try again.
FRONT PANEL WAS OPENED	—	<ul style="list-style-type: none"> •The front panel was opened. Close it and try again.
OK	—	<ul style="list-style-type: none"> •Fax communication was successful.

Error Messages

Display

If the unit detects a problem, one or more of the following messages will appear on the display.

Display message	Cause & Remedy
CALL SERVICE	<ul style="list-style-type: none">• There is something wrong with the unit. Contact our service personnel.
CHANGE DRUM	<ul style="list-style-type: none">• The drum unit is being worn out. Replace the drum unit and toner cartridge with new ones as soon as possible (p. 123–125).
CHECK DOCUMENT	<ul style="list-style-type: none">• The document is not fed into the unit properly. Reinsert the document.
CHECK DRUM	<ul style="list-style-type: none">• The drum unit is not inserted properly. Reinsert it correctly (p. 22–24).• The installed drum is worn out. Replace the drum unit with a new one.
CHECK MEMORY	<ul style="list-style-type: none">• Memory (telephone numbers, parameters, etc.) has been erased. Re-program.
CHECK TONER	<ul style="list-style-type: none">• The toner cartridge is not installed properly. Reinsert it correctly (p. 22–24).
DRUM LIFE OVER	<ul style="list-style-type: none">• The drum unit has reached the end of its life expectancy. Replace the drum unit and toner cartridge with new ones (p. 123–125).
FAILED PICK UP	<ul style="list-style-type: none">• The unit cannot pick up the recording paper loaded in the paper cassette. Remove the paper cassette and clear the jammed paper (p. 121).
FAX IN MEMORY	<ul style="list-style-type: none">• The unit has a document in memory. See the other message instructions to print out the document.
FAX MEMORY FULL	<ul style="list-style-type: none">• Memory is full of received documents due to a lack of recording paper or a recording paper jam etc. Install paper or clear the jammed paper.• When performing memory transmission, the document being stored exceeds the memory capacity of the unit. Transmit the entire documents using manual or automatic transmission.
EASY DIAL FULL	<ul style="list-style-type: none">• There is no space to store new stations in the EASY DIAL directory. Edit or erase unnecessary stations (p. 40).
MEMORY FULL	<ul style="list-style-type: none">• When making a copy, the document being stored exceeds the memory capacity of the unit. Press STOP to clear the message. Divide the documents and try again.
MODEM ERROR	<ul style="list-style-type: none">• There is something wrong with the modem circuit. Contact our service personnel.
NO FAX REPLY	<ul style="list-style-type: none">• The other party's fax machine is busy or has run out of recording paper. Try again.
OUT OF PAPER	<ul style="list-style-type: none">• The recording paper is not installed or the unit has run out of paper. Install paper (p. 25).
PANEL OPEN	<ul style="list-style-type: none">• The front panel is open. Close it.
PAPER JAMMED	<ul style="list-style-type: none">• A recording paper jam occurred. Clear the jammed paper (p. 120, 121).
PC FAIL OR BUSY	<ul style="list-style-type: none">• The fax function cannot be operated by the PC. The printer cable is not connected correctly, or the software is not running on the PC (p. 78–81).

Error Messages

Display message	Cause & Remedy
PLEASE WAIT	<ul style="list-style-type: none"> • The top cover was closed. Wait a while. • START/SET/COPY was pressed during the power save mode. Wait a while.
REDIAL TIME OUT	<ul style="list-style-type: none"> • The other party's fax machine is busy or has run out of recording paper. Try again.
REMOVE DOCUMENT	<ul style="list-style-type: none"> • The document is jammed. Remove the jammed document (p. 122). • Attempted to transmit a document longer than 600 mm (23$\frac{5}{8}$"). Press the STOP button to remove the document. Divide the document into two or more sheets and try again.
REMOVE PAPER	<ul style="list-style-type: none"> • Paper was placed on the paper tray for manual feeding without first pressing START/SET/COPY. Remove the paper. When the "PLEASE WAIT" message disappears, place the paper on the paper tray. • The paper cassette is not inserted correctly. Insert it correctly.
TONER EMPTY	<ul style="list-style-type: none"> • The toner is empty. Replace the toner cartridge and drum unit with new ones (p. 123–125).
TONER LOW	<ul style="list-style-type: none"> • The remaining toner is low. Replace the toner cartridge and drum unit with new ones as soon as possible (p. 123–125).
TOP COVER OPEN	<ul style="list-style-type: none"> • The top cover is open. Close it.
TRANSMIT ERROR	<ul style="list-style-type: none"> • Transmission error occurred. Try again.
UNIT OVERHEATED	<ul style="list-style-type: none"> • The unit is too hot. Let the unit cool down.
USE 1 FEED ONLY	<ul style="list-style-type: none"> • When transmitting or copying, another sheet was placed on the paper tray. Remove it from the paper tray and try again.
WRONG PAPER	<ul style="list-style-type: none"> • The unit printed on paper which is shorter than A4 size paper. To prevent the drum unit becoming dirty, use A4 size paper.

Operations

When a function does not work, check here before requesting help

Problems with fax machine

General

Problem	Cause & Remedy
I cannot make and receive calls.	<ul style="list-style-type: none">•The power cord or telephone line cord is not connected. Check the connections (p. 28).
I cannot make calls. (KX-FLM600AL only)	<ul style="list-style-type: none">•The dialing mode setting is wrong. Change to "TONE" or "PUSE" (p. 36).
The unit does not work.	<ul style="list-style-type: none">•Disconnect the unit from the telephone line and connect the line to a known working telephone. If the working telephone operates properly, contact our service personnel to have the unit repaired. If the working telephone does not operate properly, contact your telephone company.
The unit does not ring.	<ul style="list-style-type: none">•The ringer volume is set to off. Adjust it to a suitable level (p. 33).
The other party complains they only hear a fax tone and cannot talk.	<ul style="list-style-type: none">•The FAX ONLY mode is set. Tell them the number is only used for faxes or change to another mode (p. 56, 57).
The REDIAL/PAUSE button does not function properly.	<ul style="list-style-type: none">•If this button is pressed during dialing, a pause will be inserted. If pressed immediately after a dial tone is obtained, the last number dialed will be redialed.
The receive mode does not function as explained on pages 56 and 57.	<ul style="list-style-type: none">•The Distinctive ring pattern feature is set (p. 70).•The TEL/FAX mode is set (p. 66-69).
During programming, I cannot enter the code or ID number.	<ul style="list-style-type: none">•All or part of the numbers are the same. Change the number (p. 60, 65).

Fax - sending

Problem	Cause & Remedy
I cannot send documents.	<ul style="list-style-type: none">•The telephone line cord is connected to the EXT jack on the unit. Connect to the LINE jack (p. 28).•The other party's fax machine is busy or has run out of paper. Try again.•The other party's machine is not a facsimile. Check with the other party.•The other party's fax machine rings too many times. Send the fax manually - dial the number, confirm the fax tone, then press START/SET/COPY.
The other party complains that letters on their received documents are distorted.	<ul style="list-style-type: none">•If your line has special telephone services such as call waiting, the service may have been activated during fax transmission. Connect the unit to a line that does not have these services.•The extension telephone on the same line is off the hook. Hang up the extension telephone and try again.
The other party complains that white lines or black lines appear on their received documents.	<ul style="list-style-type: none">•The white roller is dirty. Clean it (p. 122).



Fax - sending (cont.)

Problem	Cause & Remedy
I cannot make an international fax call.	<ul style="list-style-type: none"> ● Use the overseas transmission mode (p. 54). ● Add two pauses at the end of the telephone number (p. 35) or dial manually.

Fax - receiving

Problem	Cause & Remedy
I cannot receive documents.	<ul style="list-style-type: none"> ● The telephone line cord is connected to the EXT jack on the unit. Connect to the LINE jack (p. 28).
I cannot receive documents automatically.	<ul style="list-style-type: none"> ● The receive mode is set to the TEL mode. Set to the FAX ONLY or TEL/FAX mode. ● The time taken to answer a call is too long. Decrease the number of rings (p. 62, 69).
The display shows "CONNECTING....." but faxes are not received.	<ul style="list-style-type: none"> ● The incoming call is not a fax. Change the receive mode to the TEL mode.
The recording image is faint.	<ul style="list-style-type: none"> ● The sender transmitted a faint document. Ask them to transmit a clearer copy of the document.

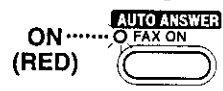
Receive mode



Problem	Cause & Remedy
I cannot select the desired receive mode.	<ul style="list-style-type: none"> ● If you want to set the FAX ONLY or TEL/FAX mode: <ul style="list-style-type: none"> — Select the desired mode using feature #77 (p. 68), and — Press AUTO ANSWER to turn on the AUTO ANSWER light. <div style="text-align: right;">  </div> ● If you want to set the TEL mode: <ul style="list-style-type: none"> — Press AUTO ANSWER to turn off the AUTO ANSWER light. <div style="text-align: right;">  </div>

Copying

Problem	Cause & Remedy
The unit does not make a copy.	<ul style="list-style-type: none"> ● You cannot make a copy during programming. Make the copy after programming or stop the programming.
White lines or black lines appear on the copied document.	<ul style="list-style-type: none"> ● The white roller is dirty. Clean it (p. 122).

Operations

Print quality

Problem	Cause & Remedy
The printing quality is poor.	<ul style="list-style-type: none"> Some paper has instructions recommending which side to print on. Try turning the paper over.
The printing is faint. <div style="display: flex; justify-content: space-around; align-items: center;"> <div style="text-align: center;"> <p>Original</p>  </div> <div style="text-align: center;"> <p>Copy</p>  </div> </div>	<ul style="list-style-type: none"> You may have used paper with a cotton and/or fibre content that is over 25%, such as letterhead or resume paper. The remaining toner is low. Replace the toner cartridge (p. 123–125).
A dirty pattern or a black line appears on the printouts.	<ul style="list-style-type: none"> There are scratches on the drum unit. Replace the drum unit (p. 123–125).

Using an answering machine

Problem	Cause & Remedy
I cannot receive documents automatically.	<ul style="list-style-type: none"> Your greeting message on the answering machine is too long. Shorten the message (up to 10 seconds). The answering machine rings too many times. Set to 1 or 2 rings. The silent detection feature is deactivated. Activate this feature (p. 72).
I cannot receive voice messages.	<ul style="list-style-type: none"> Check if the answering machine is turned on and connected to the unit properly (p. 63). Set the number of rings on the answering machine to 1 or 2.
I cannot retrieve recorded voice messages on the answering machine from a remote location.	<ul style="list-style-type: none"> The remote access code on your answering machine is the same as your fax activation code. Set a different number for each code. You did not program your remote access code in your fax machine correctly. Program the same code that is programmed on the answering machine (p. 65).
The greeting message on the answering machine is interrupted halfway and the caller cannot leave a voice message.	<ul style="list-style-type: none"> The greeting message has a silent pause longer than 4 seconds. Re-record the greeting message.
I pressed the remote access code to access the answering machine remotely, but the line was disconnected.	<ul style="list-style-type: none"> The code may include “#” which is used for certain features provided by telephone companies. Change the code on the answering machine to another number which does not include “#” (p. 65).
Callers complain that their voice message is interrupted halfway and they cannot leave a message.	<ul style="list-style-type: none"> Advise the caller not to pause for over 4 seconds while recording their voice message.
Callers complain that they cannot send a document.	<ul style="list-style-type: none"> Your answering machine ran out of recording tape. Rewind the tape to record messages. You set the answering machine to only give a greeting message.
When I answer a call with the extension telephone, the unit switches to the fax mode and I cannot talk with the other party.	<ul style="list-style-type: none"> You paused for over 4 seconds during the conversation. Do not pause for more than 4 seconds, or turn the #40 Silent detection feature (p. 72) off.

Problems with PC software

General

Problem	Cause & Remedy
I cannot send a fax from the PC at a specified time.	<ul style="list-style-type: none"> •The date and time of the PC may be set incorrectly. Adjust it. If it cannot be set correctly, consult your PC supplier.
The date and time that prints on the top of each page sent from the PC is incorrect.	<ul style="list-style-type: none"> •The date and time of the PC may be set incorrectly. Adjust it. If it cannot be set correctly, consult your PC supplier.
I do not know how to move the PANA LINK Main Panel, because there is no title bar.	<ul style="list-style-type: none"> •Point at an area with no buttons or parts and drag it where you want to move.
I do not know whether the PANA LINK Main Panel is active or not.	<ul style="list-style-type: none"> •The brightness of the Main Panel Display shows you whether the PANA LINK Main Panel is active or not. <Active – bright, Non active – dark>
A quick tip does not appear when I hold the mouse pointer over a button in the PANA LINK Main Panel, although I have set this to be displayed.	<ul style="list-style-type: none"> •If the PANA LINK Main Panel is non-active, the quick tip does not appear. Check again, after making the PANA LINK Main Panel active, by clicking anywhere on it.
The telephone number set in the Main Panel Display disappears, and the display shows, "For storing a phone or fax number.", explanation of the button and so on.	<ul style="list-style-type: none"> •The quick tip is displayed. Move the mouse cursor out of the PANA LINK Main Panel. If you do not need quick tips, open the setup dialogue and select OFF of the Quick Tip in the System tab.
The PANA LINK Main Panel disappears.	<ul style="list-style-type: none"> •Look in the task tray (in the task bar). If you do not find the PANA LINK icon, it is closed. If you find the icon, the PANA LINK Main Panel is just minimized or reduced to an icon. Double-click the icon in the task tray or open the menu by right-clicking the fax icon then select Restore.
The PANA LINK Main Panel disappears just after initializing.	<ul style="list-style-type: none"> •The PANA LINK Main Panel is set to minimize when PANA LINK starts. Double-click the icon in the task tray or open the menu by right-clicking the fax icon, then select Restore. If you do not want this to happen each time you start PANA LINK, press the Setup button in the PANA LINK Main Panel, and check off the Start minimized check box in the Program startup settings in the System tab.
I want to delete all of the telephone numbers set in the Main Panel Display.	<ul style="list-style-type: none"> •Press the Stop button.
I cannot recognize the last part of the entry in the address list of the Address Book or Communication log, because that part ended with...	<ul style="list-style-type: none"> •Put a cursor on the line between the buttons, the cursor changes shape and you can expand the area by dragging, or double-clicking.
A cover page is sent whenever I send a fax, though I do not want it to be sent.	<ul style="list-style-type: none"> •The setting of the cover page is "ON" by default. To deactivate the setting, open the Setup dialogue box by pressing the Setup button, and click the "Default Add cover page at every transmission" check box in the Cover page tab.
I attempted to select a telephone number from the Address Book for the PANA LINK Main Panel, but I selected a fax number by mistake.	<ul style="list-style-type: none"> •You can change your selection in the PANA LINK Main Panel. Double click the number you set in the Main Panel Display and the fax number switches to the telephone number. You can also right-click the entry to select a specific number.

(continued)

Operations

General (cont.)

Problem	Cause & Remedy
I cannot use the Dial button, even though I specified a telephone number.	<ul style="list-style-type: none"> • If there is transmission data or a document is set in the fax, you can only use the fax transmission function. If you want to make a phone call, please delete the transmission data.
When I exit PANA LINK, the Viewer does not close.	<ul style="list-style-type: none"> • The viewer can be operated separately, so when the PANA LINK is closed, it remains open.
The PANA LINK does not work properly.	<ul style="list-style-type: none"> • Click the <input checked="" type="checkbox"/> button to exit PANA LINK, and restart. If PANA LINK does not close, please force it to close by pressing the Ctrl+Alt+Delete keys.
I cannot send or receive a fax through PANA LINK.	<ul style="list-style-type: none"> • When you use a PC with an ECP printer port such as a Compaq Deskpro or an IBM Aptiva, you may need to change the ECP port into a standard port: <ol style="list-style-type: none"> 1. Click the Start button, point the Settings, then Control Panel. 2. Double-click System. 3. Double-click Ports [COM & LPT] from the Device Manager tab. 4. Double-click ECP Printer Port (LPT1). 5. Click the Update Driver... button on the Driver tab. <ul style="list-style-type: none"> —The Update Device Driver Wizard starts. 6. Click the "NO, select driver from list" button. 7. Click Show all hardware and choose Standard Port types from the Manufacturers list, and Printer Port from Models. 8. Click the Finish button. <p>If you are required to insert the Windows 95/98 CD-ROM, please do the following.</p> <ol style="list-style-type: none"> 1) Insert the Windows 95/98 CD-ROM. The Copying files dialogue box appears. 2) Click the Browse button, and then choose Win95/98 folder from the list. 3) Click the OK button. The Version Conflict dialogue box appears. Please check Your version here. If it is 4.00.955, click Yes. <p>You may need to change the ECP port in the BIOS system settings. It varies by PC, please refer to your PC operating instructions or manufacturer for instructions.</p> <p>Please check that the LPT.VXD version is 4.00.955:</p> <ol style="list-style-type: none"> 1) Click the Start button, point to Settings, then Control Panel. 2) Double-click System, and then open the Device Manager tab. 3) Double-click Ports [COM & LPT] from the Device Manager tab. 4) Double-click Printer Port (LPT1). 5) Click the Driver tab. Verify whether the File version is 4.00.955. <p>Note: If it is an old version, you must uninstall PANA LINK first, then reboot the PC, and re-install it again.</p>
I cannot open a TIFF file.	<ul style="list-style-type: none"> • You must change the compression format of the file. For example, to convert an image using WANG Imaging, proceed as follows: <ol style="list-style-type: none"> 1. Click on the Start button, point to Programs – Accessories, then click Imaging. 2. Open the TIFF file that you cannot open in the PANA Viewer. 3. Open the Page menu, then click Convert. <ul style="list-style-type: none"> —The Convert dialogue box appears. 4. Click the Compression tab, then choose [CCITT Group 3 (1d Modified Huffman)] from the Compression drop-down list. 5. Click the OK button. <ul style="list-style-type: none"> —The file's compression format is changed.

Printing

Problem	Cause & Remedy
<p>I cannot print.</p>	<ul style="list-style-type: none"> ● Please check the following. <ol style="list-style-type: none"> 1. Driver settings: If you change the driver settings in the Panasonic KX-FLM600/650 dialogue box, you may be able to print. 2. Preview window: If the image is not properly displayed in the Preview window, your file may contain errors. Try printing a different file. Also, there may be a problem with the application you are using. 3. Bad connection between PC and printer: Check that the printer is properly connected and plugged in. 4. Re-install: Uninstall PANA LINK, reboot your PC, then re-install. 5. Port setting: If the printer port is not set to FLM600, you cannot print. <ol style="list-style-type: none"> 1) Click the Start button, point to Settings, then Printer. 2) Choose Properties from the printer's pop-up menu. —The Properties dialogue box appears. 3) Click the Details tab, and check the Print to the following port drop down list box. If a different port is selected, re-select FLM600 (KX-FLM600 port). 4) Click the OK button. 6. Bi-Directional Parallel Port. (ECP mode): If using ECP (Extended Capability Port) mode, you may not be able to print. Please change it to a standard port: <ol style="list-style-type: none"> 1) Click the Start button, point to Settings, then Control Panel. 2) Double-click System, and open the Device Manager tab. 3) Double-click Ports [COM & LPT] from the Device Manager tab. 4) Double-click the ECP Printer Port. 5) Click the Update Driver... button from the Driver tab. 6) Change the ECP port into Printer Port (LPT1). <p>If the same error occurs repeatedly even after changing the printer port, check the BIOS settings or update LPT.VXD. Please consult your computer manufacturer for the latest LPT.VXD and the BIOS settings. LPT.VXD version 4.00.955 is required. If you do not use the correct version, we cannot guarantee that the driver will work properly.</p> <p>Reboot your PC, and try a test print.</p> <ol style="list-style-type: none"> 1) Click the Start button, point to Settings, then Printers. 2) Choose Properties from the printer's pop-up menu. —The Properties dialogue box appears. 3) Click the Print Test Page button from the General tab. If the same error occurs, please see next. <p>Please check that the LPT.VXD version is 4.00.955:</p> <ol style="list-style-type: none"> 1) Click the Start button, point to Settings, then Control Panel. 2) Double-click System, and open the System Properties dialogue box. 3) Double-click Ports [COM & LPT] from the Device Manager tab. 4) Double-click Printer Port (LPT1). 5) Click the Driver tab. Verify whether the File version is 4.00.955. <p>Note: If it is an old version, you must uninstall PANA LINK first, then restart the PC, and install it again.</p> <p>When you change settings manually, you must reboot your PC.</p>

Operations

Transmission

Problem	Cause & Remedy
The "Sending a fax failed." message is displayed.	<ul style="list-style-type: none">● Possible causes are as follows.<ul style="list-style-type: none">— Telephone circuit is not good.— You received a call-waiting signal.— The other party stopped reception.— The other party ran out of recording paper. Transmit again after confirming with the other party.
The "No response" message is displayed.	<ul style="list-style-type: none">● The other party did not answer the call or the line was busy. Transmit again after waiting a while.● The dialing mode setting (tone or pulse) is not correct. Open the Setup dialogue box and confirm the dialing mode setup check box in the Line tab.
I cannot make an international transmission.	<ul style="list-style-type: none">● Set the fax machine to the overseas transmission mode (p. 54).

Reception

Problem	Cause & Remedy
The fax machine receives a fax, but I want to receive it with the PC.	<ul style="list-style-type: none">● You may have checked the "Receive directly to Facsimile Unit" check box in the Reception tab in the Setup dialogue box. If so, click this check box to deactivate.● The setting of the PC LINK on the fax machine is off. Turn it on (p. 108).● The PANA LINK application is not operating. Start the PANA LINK application.
The PC receives a fax, but I want to receive it with the fax machine.	<ul style="list-style-type: none">● Open the Setup dialogue box, then check the "Receive directly to Facsimile Unit" check box to activate in the Reception tab.
I want to print out the received fax with another printer.	<ul style="list-style-type: none">● Print after selecting the desired printer from the Print dialogue box.
The "Receiving a fax failed." message is displayed.	<ul style="list-style-type: none">● Possible causes are as follows.<ul style="list-style-type: none">— The line condition was not good.— The call waiting signal interfered with reception. Check with the other party and try again.

Scanning and copying

Problem	Cause & Remedy
I cannot scan.	<ul style="list-style-type: none">● The facsimile unit is probably busy. Try again after the other operation is completed.● There might not be enough free space on the hard disk. Try again after deleting unnecessary files or closing unused applications.● There might not be enough RAM: Try again after closing some applications.● Restart the PC, then try again.
The document is not pulled into the document feeder.	<ul style="list-style-type: none">● Confirm that a maximum of 15 pages are set correctly.
A document is jammed.	<ul style="list-style-type: none">● If you select Fine (200 × 200 dpi) in the image quality list, make sure the document is less than 655 mm (25⁷/₈"). If you select Line Art (400 × 400 dpi), make sure the document is less than 470 mm (18¹/₂"). Remove the jammed document and try again.

Scanning and copying (cont.)

Problem	Cause & Remedy
The recording paper is jammed.	<ul style="list-style-type: none"> Remove the jammed recording paper, reinsert it, and try again.
Even after clicking the Cancel button, scanning continues.	<ul style="list-style-type: none"> Please wait. Sometimes, it takes a while for the cancel request to be accepted.
I cannot scan documents using other applications.	<ul style="list-style-type: none"> Due to compatibility issues, an error may occur when you scan documents using certain applications. Scan from PANA LINK.

Error message

Problem	Cause & Remedy
"Initialization failed" is displayed.	<ul style="list-style-type: none"> Check the connections of the PC and the fax machine. The setting of the PC LINK on the fax machine is off. Turn it on (p. 108).

If a power failure occurs

- The unit will not function.
- Transmission and reception will be interrupted.
- If fax documents are stored in memory, they will be lost. When power is restored, a power down report will be printed out stating which contents in memory have been erased.
- If delayed transmission is programmed, and the start time passes during a power failure, transmission will be attempted soon after power is restored.
- If an extension telephone/answering machine is connected to the unit, you can use it during a power failure.

Power down report

The power down report will be automatically printed out after power is restored.
The report will not be printed out if there are no documents stored in memory.

Sample of a power down report

POWER DOWN REPORT				
POWER DOWN AT:Jan. 05 1999 04:30AM				
RESTARTED AT:Jan. 05 1999 04:31AM				
YOUR LOGO :Bill				
YOUR FAX NO. :1234567				
<< WARNING >>				
CONTENTS HAVE BEEN CLEARED DUE TO POWER DOWN.				
FOR ADDITIONAL INFORMATION, PLEASE SEE THE JOURNAL REPORT.				
NO.	OTHER FACSIMILE	MODE	PAGES	FUNCTION
01	<FAX # NOT AVAIL.>	RCV	01	MEMORY RECEIVE

Jams

Clearing paper jams

If the unit does not eject any recording paper while printing, the recording paper has jammed. When the unit detects a paper jam, the following messages will be displayed.

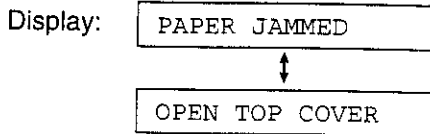

Open the top cover by pulling the top cover handle forward and check where the paper has jammed.

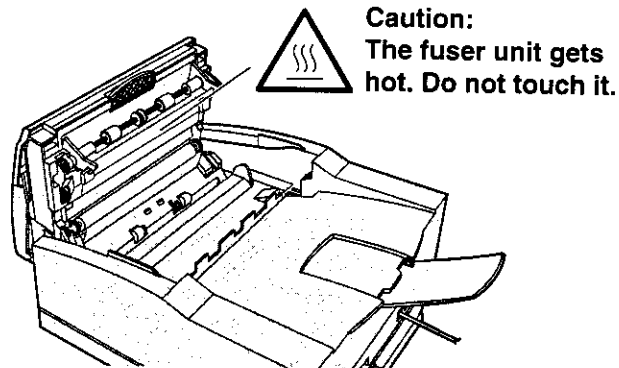
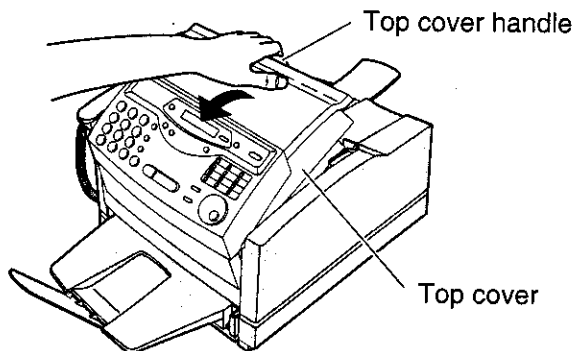

If paper has jammed on the drum unit

- 1 Remove the jammed paper carefully.

Caution:

- Do not touch or scratch the green drum surface as this may damage the drum unit.

- 2 Close the top cover securely by pushing down on the dotted area at both ends.

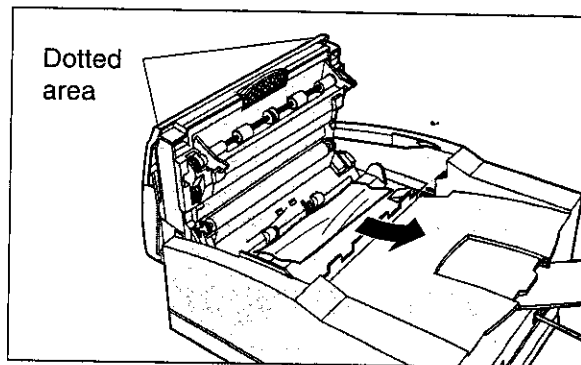

If paper has jammed in the fuser unit

- 1 Pull the jammed paper out carefully.

Caution:

- Do not touch or scratch the green drum surface as this may damage the drum unit.

- 2 Close the top cover securely by pushing down on the dotted area at both ends.

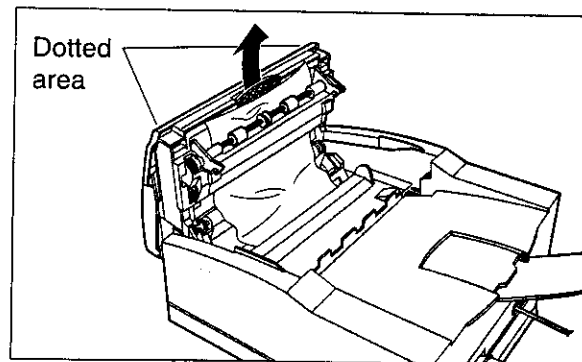

Note:

- If the jammed paper cannot be found, it may have stopped under the drum unit. Follow the instructions on the next page to clear the jammed paper.

If "FAILED PICK UP" is displayed

- 1** Close the paper tray extender and remove the paper tray by (A) slightly lifting and (B) pulling it out of the unit.
- 2** Lift the paper cassette up slightly and pull it out of the unit.
- 3** Remove the jammed recording paper.
- 4** Insert the paper cassette into the unit until it clicks into place.
- 5** Replace the paper tray and open the paper tray extender.

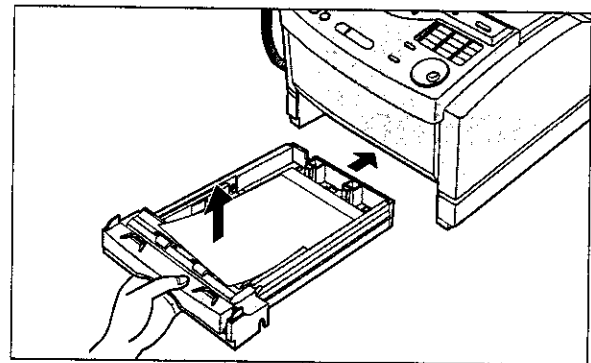
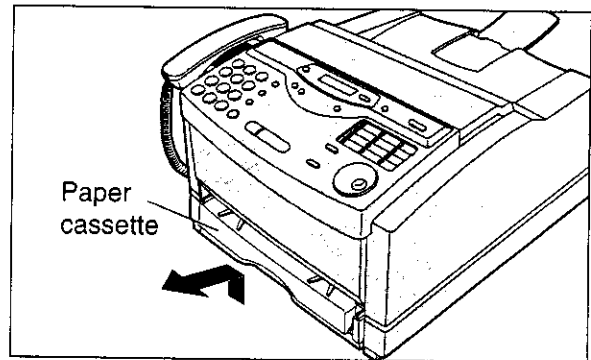
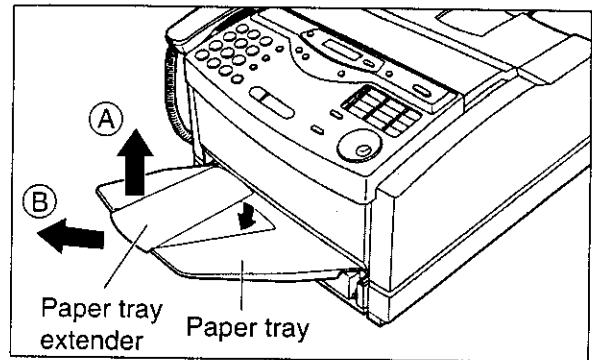

Jams / Cleaning

Sending document jams

If the unit does not release the document during feeding, remove the jammed document.

- 1 Open the front panel.
- 2 Remove the jammed document carefully.
- 3 Close the front panel securely by pushing down on both ends.

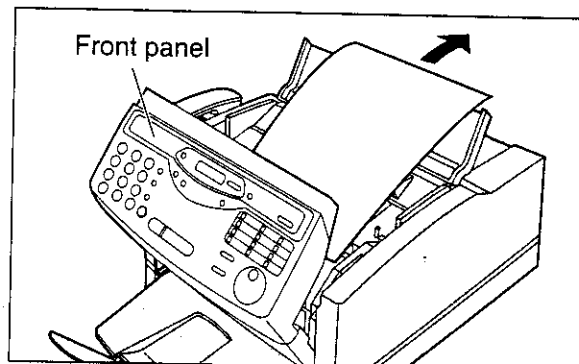

Note:

- Do not pull out the jammed paper forcibly before opening the front panel.

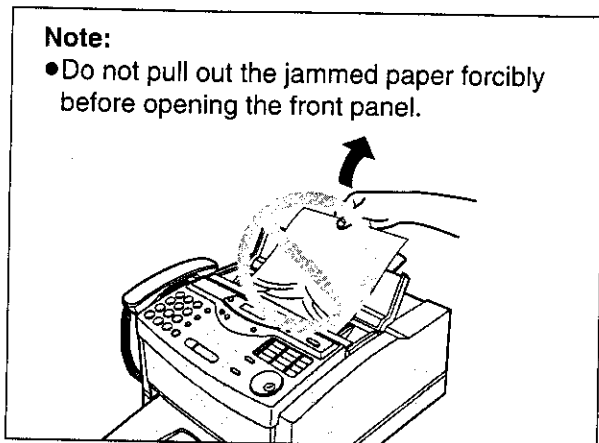

Cleaning

If white or black bands appear on a copied or transmitted document, clean the white roller.

- 1 Disconnect the printer cable, the power cord and the telephone line cord.
- 2 Open the document feeder tray and the front panel.
- 3 Clean the white roller with a cloth moistened with isopropyl rubbing alcohol by rotating the roller and let it dry thoroughly.
- 4 Close the front panel securely by pushing down on both ends.
- 5 Connect the printer cable, the power cord and the telephone line cord.

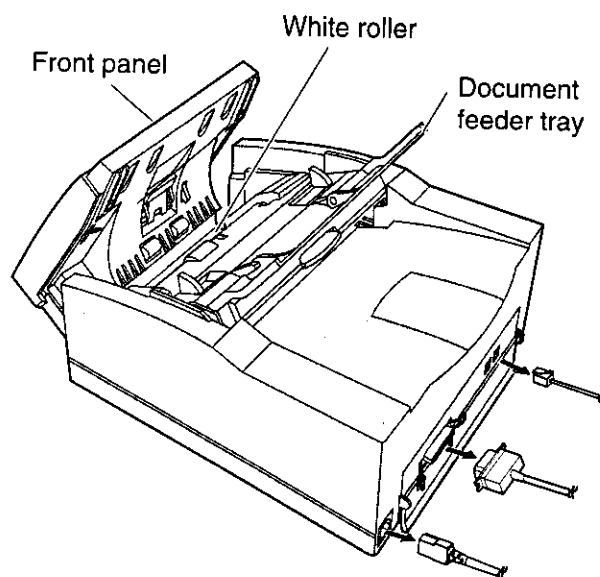

Caution:

- Do not use paper products, such as paper towels or tissues, to clean the white roller.

Replacing the toner cartridge and drum unit

When the display shows the following message, replace the toner cartridge and drum unit with new ones.

Display: TONER EMPTY OR TONER LOW

Depending on usage, the following message may be displayed.

DRUM LIFE OVER OR CHANGE DRUM

The following is available for replacement. To order, see page 7.

KX-FA75A: Toner cartridge and drum unit

Caution:

- If ingestion of toner occurs, drink several glasses of water to dilute stomach contents, and seek immediate medical treatment. If toner comes into contact with eyes, flush thoroughly with water, and seek medical treatment. If toner comes into contact with skin, wash thoroughly with soap and water.
- Do not tip the toner cartridge on its end.
- The drum unit contains a photosensitive drum. Exposing it to light may damage the drum.
 - Do not expose the drum unit to light for more than 5 minutes.
 - Do not touch or scratch the green drum surface.
 - Do not place the drum unit near dust or dirt.
 - Do not place the drum unit in a high humidity area.
 - Do not expose the drum unit to direct sunlight.

Important:

- To prevent loss of fax memory, when replacing the toner cartridge and drum unit, do not unplug the fax machine.
- Keep the protection materials in case the unit must be repacked and transported (p. 126–128).

- 1** Pull the top cover handle forward and open the top cover.



Caution:
The fuser unit gets hot. Do not touch it.

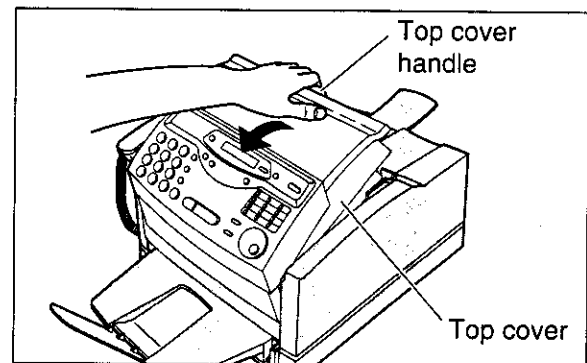
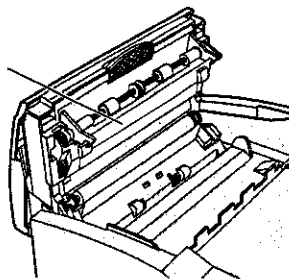

- 2** Remove the used drum unit by holding the two tabs.

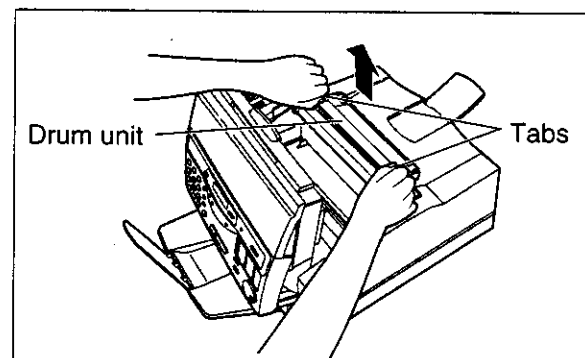

(continued)

Replacement

3 Remove the used toner cartridge by lifting the two tabs.

Caution:

- To avoid getting your hands dirty, do not touch the roller.

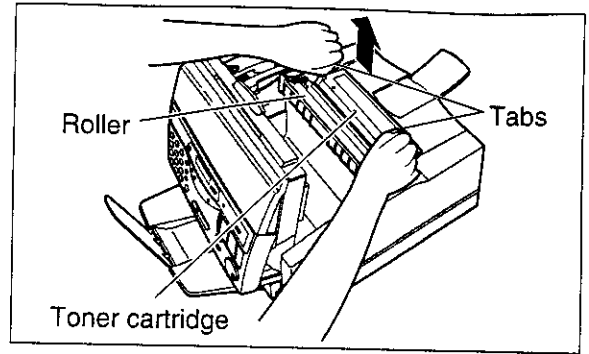

4 Open the protection bag by cutting the end of the bag and remove the new toner cartridge.

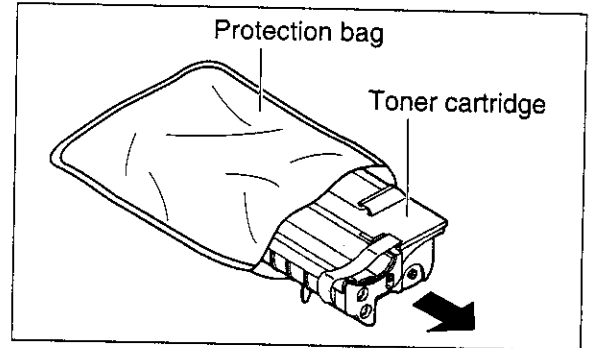

5 Remove the tape and remove the protection cap by holding the tab.

Caution:

- Do not tip the toner cartridge on its end.

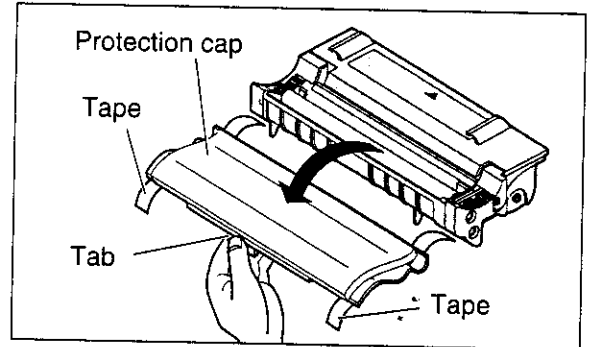
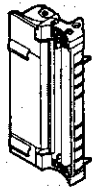

6 Carefully rock the toner cartridge from side to side several times.

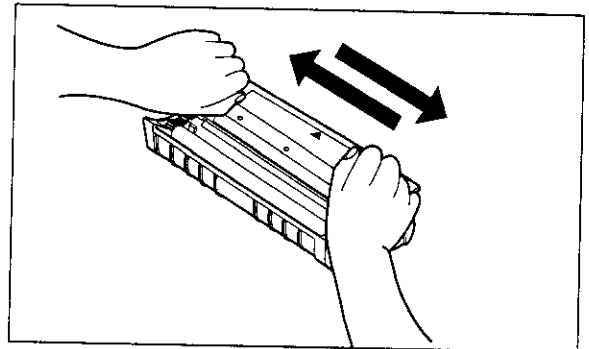

7 Install the new toner cartridge, holding the two tabs and matching the triangles.

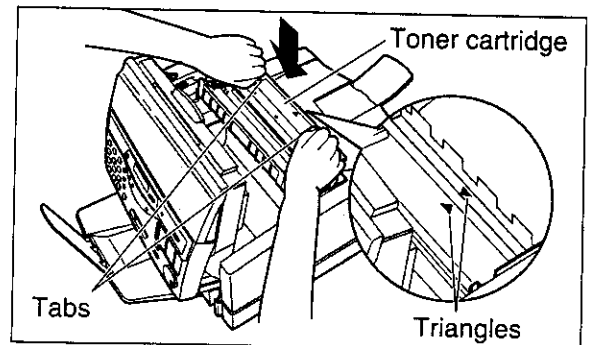

Replacement

- 8** Open the protection bag by cutting the end of the bag and remove the drum unit.

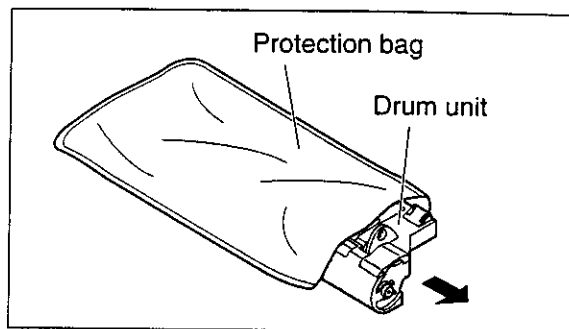

- 9** Remove the protection cap.

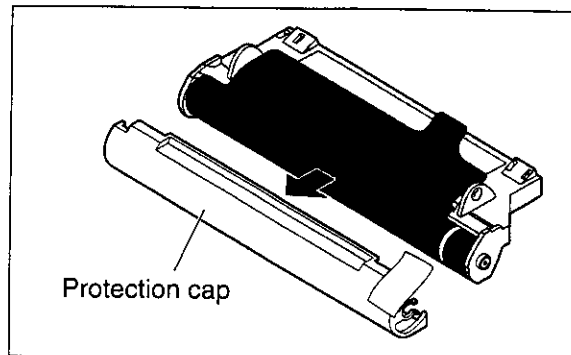

- 10** Remove the protection sheet.

Caution:

- Do not touch or scratch the green drum surface as this may damage the drum unit.
- Do not expose the drum unit to light for more than 5 minutes as this may damage the drum unit.

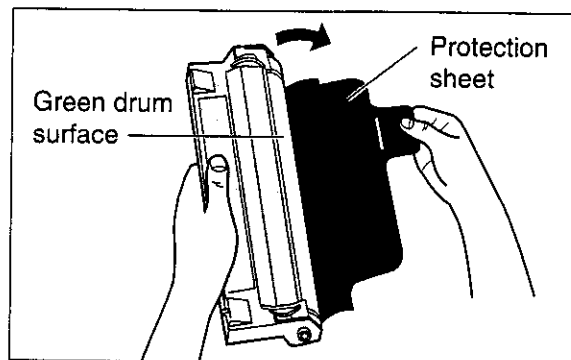

- 11** Install the new drum unit on the toner cartridge by holding the two tabs and matching the triangles.

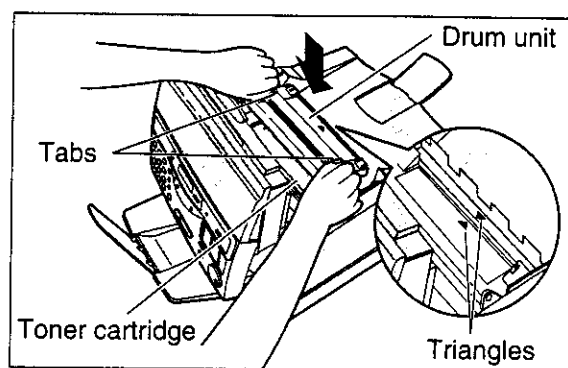

- 12** Close the top cover securely by pushing down on the dotted area at both ends.

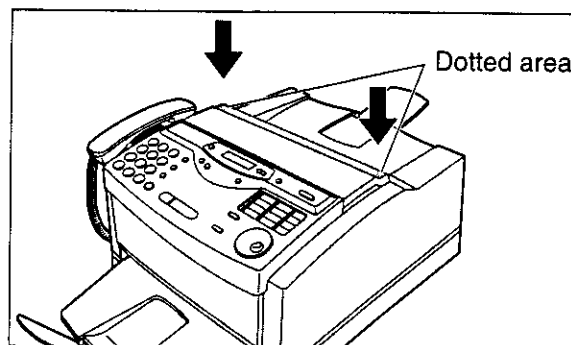

Repacking

Transporting the unit

This unit is not designed to be portable, so please take care when transporting it.

—Use the original carton and all of the original packing materials.

—Improper repacking of the unit may result in a service charge to repair the unit or in a cleaning charge to remove spilled toner.

—Because the unit uses dry toner, extreme care must be taken when handling. The unit should be handled in the upright position until the unit is repacked completely.

If you plan to move the unit from one location to another, or if you want to store it, follow the steps below.

- 1** Disconnect the power cord, printer cable, telephone line cord, handset and handset cord.

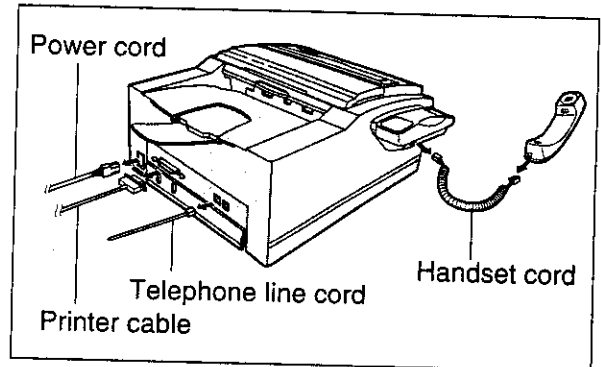

- 2** Close the paper stacker and the paper tray extender. Remove the paper tray by (A) slightly lifting and (B) pulling it out of the unit.

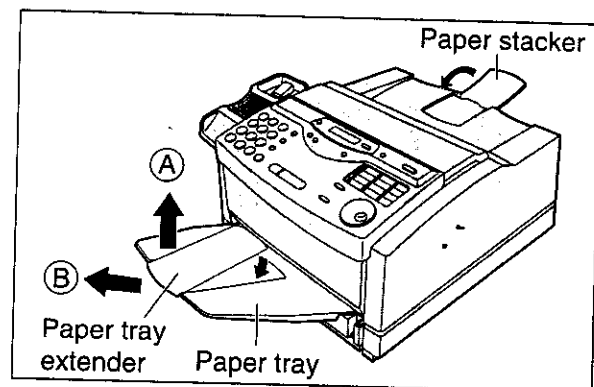

- 3** Spread a dropcloth or newspaper under the unit to keep the work area clean.

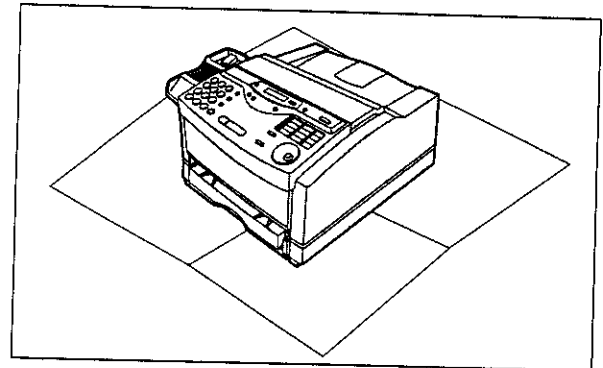

Repacking

- 4** Pull the top cover handle forward and open the top cover.

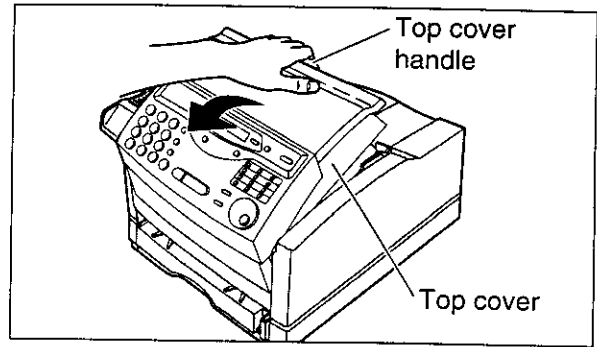

- 5** Remove the drum unit by lifting the two tabs.

Caution:

- Do not touch or scratch the green drum surface as this may damage the drum unit.

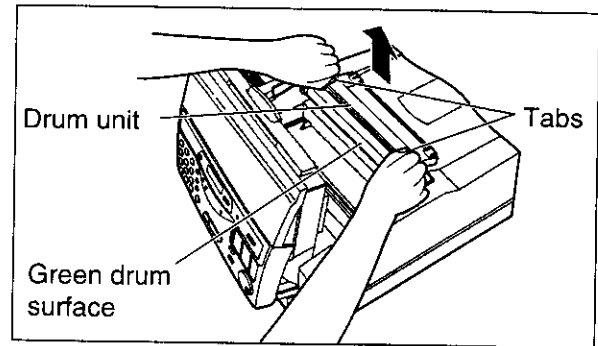

- 6** Attach the protection sheet and cover the green drum surface completely.

Caution:

- Do not expose the drum unit to light for more than 5 minutes as this may damage the drum unit.
- Do not stick tape to the green drum surface.

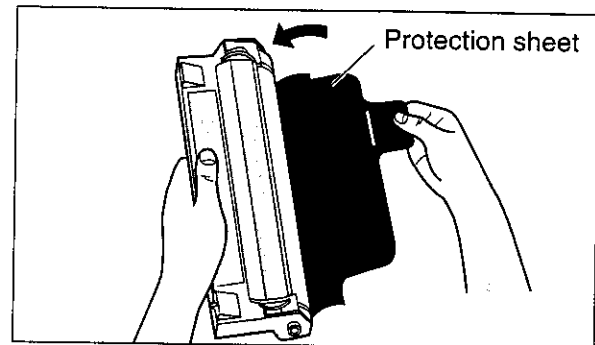

- 7** Attach the protection cap to the drum unit using the tape.

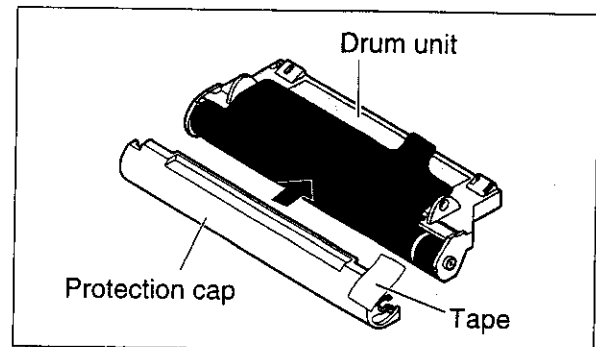

- 8** Pack the drum unit into the protection bag.

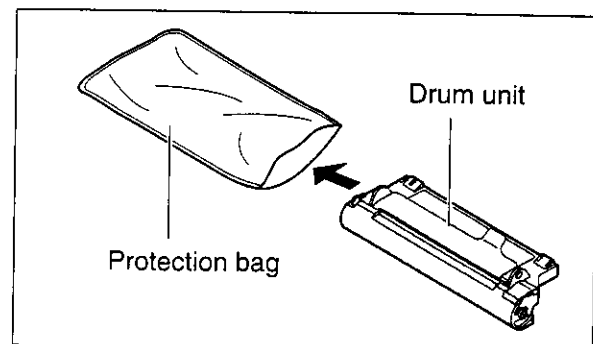

(continued)

Repacking

- 9** Remove the toner cartridge by holding the two tabs.

Caution:

- Do not tip the toner cartridge on its end.

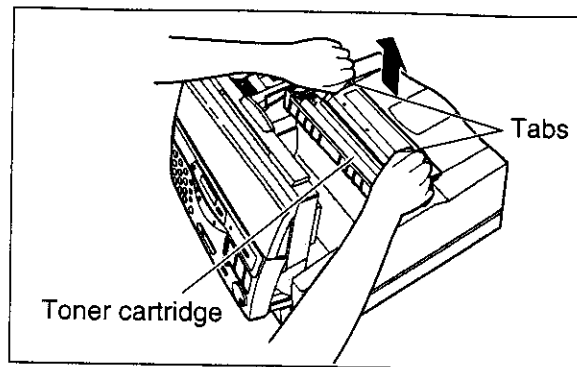
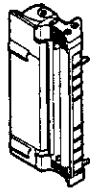

- 10** Attach the protection cap tightly using the tape.

Caution:

- To avoid getting your hands dirty, do not touch the roller.

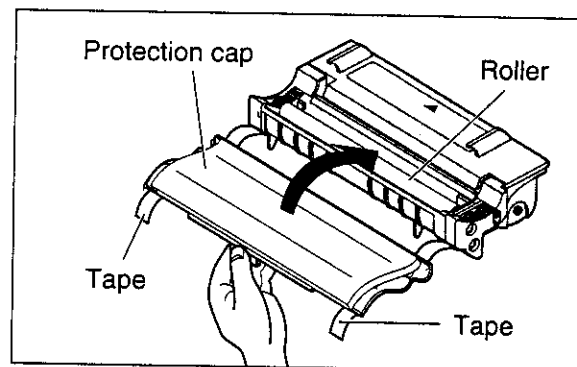

- 11** Pack the toner cartridge into the protection bag.

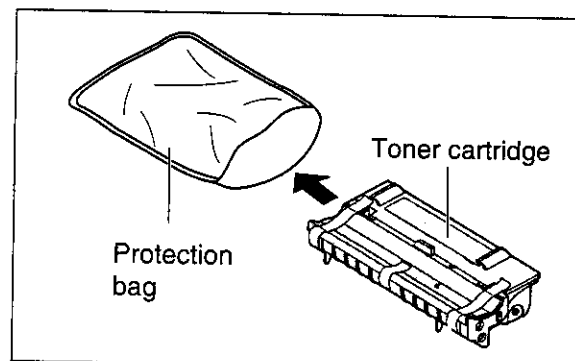

- 12** Close the top cover securely by pushing down on the dotted area at both ends.

- 13** Repack the unit in its original packing materials.

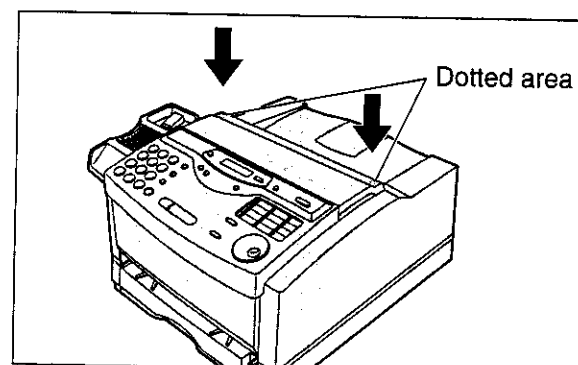

Printing the feature settings, telephone numbers, journal and broadcast list

You can print out the following report and lists.

Feature list: provides you with the current settings of the basic and advanced programming features (p. 136–138).

Telephone number list: provides you with names and telephone numbers which are stored in the One-Touch Dial and EASY DIAL directory. The telephone number codes are as shown below.

P: A pause has been entered.

F: A RECALL has been entered.

[]: A secret telephone number has been entered. (The telephone number is not printed.)

Journal report: keeps records of fax transmissions and receptions. This report will be printed automatically after every 35 fax communications (p. 48).

Broadcast list: provides you with names and telephone numbers which are stored in the BROADCAST keys (p. 51–53).

1 Press **MENU** two times.

Display: 2.PRINT REPORT

2 For the **feature list**, press **#**, then **1**.

SETUP LIST

For the **telephone number list**, press **#**, then **3**.

TEL NO. LIST

For the **journal report**, press **#**, then **4**.

JOURNAL REPORT

For the **broadcast list**, press **#**, then **6**.

BROADCAST LIST

3 Press **START/SET/COPY** to start printing.

PRINTING

•To stop printing, press **STOP**.

•After printing, the following will be displayed.

PRINT ITEM []

4 Press **MENU**.

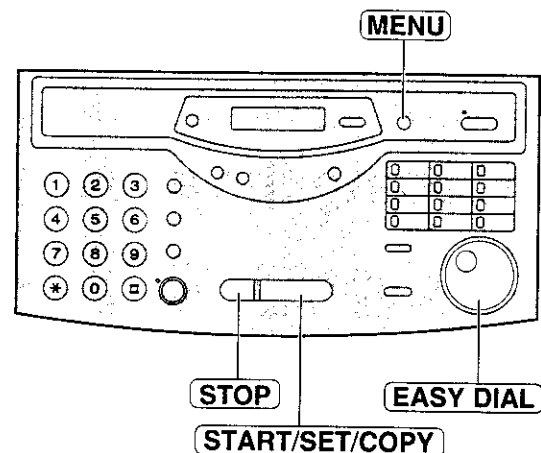

Note:

- In step 2, you can select the desired item by rotating **EASY DIAL**.

Display Contrast / Reset

Changing the display contrast

Use this feature to adjust the display contrast.

NORMAL: (Pre-selected setting)

DARKER: Used when the display contrast is too light.

- 1 Press **MENU**.
Display: 1. SYSTEM SET UP
- 2 Press **#**, then **3 9**.
LCD CONTRAST
- 3 Press **START/SET/COPY**.
MODE=NORMAL ▼▲
- 4 Press ▼ or ▲ to select the desired setting.
- 5 Press **START/SET/COPY**.
SETUP ITEM []
- 6 Press **MENU**.

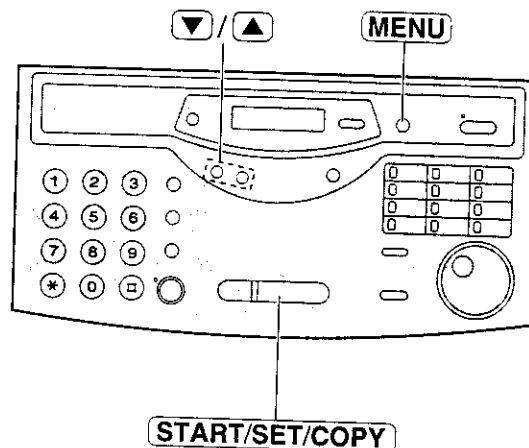

Resetting the advanced features

Use this feature to return the advanced features to their pre-selected settings (p. 137, 138).

- 1 Press **MENU**.
Display: 1. SYSTEM SET UP
- 2 Press **#**, then **8 0**.
SET DEFAULT
- 3 Press **START/SET/COPY**.
RESET=NO ▼▲
- 4 Press ▼ or ▲ to select "YES".
RESET=YES ▼▲
- 5 Press **START/SET/COPY**.
RESET OK?
- If this feature is not required, press **STOP**.
- 6 Press **START/SET/COPY** again for confirmation.
RESET COMPLETED
↓
SETUP ITEM []
- 7 Press **MENU**.

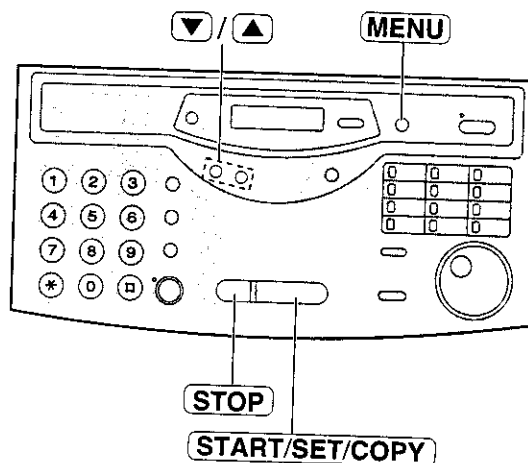

Technical data about this product

Common specifications

Laser Diode Properties:	Laser output: 5 mW max
	Wave length: 760–800 nm
	Emission duration: Continuous
Operating Environment:	10 °C – 32.5 °C (50 °F – 90.5 °F), 20 % – 80 % RH (Relative Humidity)
Dimensions (H×W×D):	422 mm × 430 mm × 212 mm (16 ⁵ / ₈ " × 16 ¹⁵ / ₁₆ " × 8 ¹ / ₃₂ ")
Mass (Weight):	Approx. 12.2 kg (26.9 lb.)
Power Consumption:	Standby: Approx. 40 W
	Power save*: Approx. 10 W
	Transmission: Approx. 12 W (Power save)
	Approx. 42 W (Standby)
	Print (Copy or Reception): Approx. 200 W
	Maximum: Approx. 480 W
Power Supply:	220–240 V AC, 50/60 Hz

*If this product is not used for 5 minutes, it will change to power save mode.

Fax/Copy feature

Applicable Lines:	Public Switched Telephone Network
Document Size:	Max. 216 mm (8 ¹ / ₂ ") in width
	Max. 600 mm (23 ⁵ / ₈ ") in length—STANDARD/FINE/HALF TONE mode
	Max. 420 mm (16 ¹ / ₃₂ ") in length—SUPER FINE mode
Effective Scanning Width:	208 mm (8 ³ / ₁₆ ")
Effective Printing Width:	208 mm (8 ³ / ₁₆ ")
Transmission Time*:	Approx. 8 s/page (ECM-MMR)**
Scanning Density:	Horizontal: 8 pels/mm (203 pels/inch)
	Vertical: 3.85 lines/mm (98 lines/inch)—STANDARD mode
	7.7 lines/mm (196 lines/inch)—FINE/HALF TONE mode
	15.4 lines/mm (392 lines/inch)—SUPER FINE mode
Halftone Level:	64-level
Scanner Type:	CIS (Contact Image Sensor)
Printer Type:	Laser beam printer
Data Compression System:	Modified Huffman (MH), Modified READ (MR), Modified Modified READ (MMR)
Modem Speed:	14,400 / 12,000 / 9,600 / 7,200 / 4,800 / 2,400 bps; Automatic Fallback
Memory Capacity:	Approx. 120 pages of memory transmission/reception/copy (Based on the CCITT No. 1 Test Chart in standard resolution.)

*Transmission speed depends upon the contents of the pages, resolution, telephone line conditions and capability of the receiving unit.

**The 8 second speed is based upon the CCITT No. 1 Test Chart.

CCITT No. 1 Test Chart

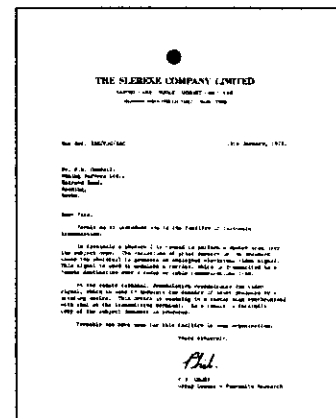

General Information

Specifications

Printer feature

Printer Type: Laser beam printer
Print Speed: 8 ppm
Printing Resolution: 600×600 dpi
Compatible OS: Windows 3.1/3.11/95/98
Interface: 8-bit parallel (Included)
Paper Specifications:
Media Size:

Using the paper cassette

Media	Size	Dimension
Paper	A4	210 mm × 297 mm

Using the paper tray

Media	Size	Dimension
Paper	Letter	216 mm × 279 mm (8½" × 11")
	Legal	216 mm × 356 mm (8½" × 14")
	A4	210 mm × 297 mm
	Executive	184 mm × 267 mm (7¼" × 10½")
Transparency	Letter	216 mm × 279 mm (8½" × 11")
	A4	210 mm × 297 mm
Envelope	COM10	105 mm × 241 mm (4⅛" × 9½")
	DL	110 mm × 220 mm

Paper Weight:

Using the paper cassette
60 g/m² to 90 g/m² (16 lb. to 24 lb.)
Using the paper tray
60 g/m² to 105 g/m² (16 lb. to 28 lb.)

Note:

- Fax receiving and copying are only available when using the paper cassette.

Scanner feature

Document Size: Max. 216 mm (8½") in width
Max. 600 mm (23⅝") in length
Effective Scanning Width: 208 mm (8⅜")
Scanning Density: Standard 200 × 100 dpi
Fine 200 × 200 dpi
S-Fine 200 × 400 dpi
Halftone Level: 64-level
Scanner Type: CIS (Contact Image Sensor)
Compatible OS: Windows 95/98,
Windows 3.1/3.11 (Need application software which is compatible with TWAIN driver.)

Note:

- Any details given in these instructions are subject to change without notice.
- The pictures and illustrations in these instructions may vary slightly from the actual product.

Toner life

Toner life of the included toner cartridge or KX-FA75A toner cartridge depends on the amount of content in a received, copied or printed document. We refer to the content as "image area". Because image area varies in actual usage, so does toner life. The following is the approximate relationship between image area and toner life for the included toner cartridge or KX-FA75A toner cartridge.

■ Toner life for the included toner cartridge or KX-FA75A toner cartridge:

5% image area	10% image area	15% image area
<p>Specifications</p> <p>Main unit specifications</p> <p>1. Applicable Lines: Public switched telephone network</p> <p>2. Compatibility: 170-75 (C)</p> <p>3. Effective Scanning Width: Max. 206mm</p> <p>4. Recording Paper Size: Letter: 214.27mm Legal: 214.25mm</p> <p>5. Effective Printing Width: 206mm</p> <p>6. Transmission Time: Approx. 20sec/page (C) (Noted under 9H) Approx. 17sec/page (C) (Original mode, 9H) Approx. 15sec/page (C) (Original mode, 9H)</p> <p>7. Fax Redial Time: Up to 90sec</p> <p>8. Telephone Redial Time: Up to 150sec</p> <p>9. Scanning Density: Horizontal: 600dpi Vertical: 3.85lines/inch (Standard mode) Vertical: 7.71lines/inch (File or Not From mode)</p> <p>10. Scanner Type: Contact Image Sensor</p>	<p>Specifications</p> <p>Main unit specifications</p> <p>1. Applicable Lines: Public switched telephone network</p> <p>2. Compatibility: 170-75 (C)</p> <p>3. Effective Scanning Width: Max. 206mm</p> <p>4. Recording Paper Size: Letter: 214.27mm Legal: 214.25mm</p> <p>5. Effective Printing Width: 206mm</p> <p>6. Transmission Time: Approx. 20sec/page (C) (Noted under 9H) Approx. 17sec/page (C) (Original mode, 9H) Approx. 15sec/page (C) (Original mode, 9H)</p> <p>7. Fax Redial Time: Up to 90sec</p> <p>8. Telephone Redial Time: Up to 150sec</p> <p>9. Scanning Density: Horizontal: 600dpi Vertical: 3.85lines/inch (Standard mode) Vertical: 7.71lines/inch (File or Not From mode)</p> <p>10. Scanner Type: Contact Image Sensor</p> <p>11. Printer Type: Electrostatic LED array printer</p> <p>12. Data Compression System: Modified Huffman (MH), Modified READ (MR)</p> <p>13. Main Speed: 900/1200/1600/2400dpi; Automatic Feedback</p> <p>14. Operating Environment: 10-32.5 C 20-65°F</p> <p>15. Dimensions (H x D): 271 x 48.6mm</p> <p>16. Power Consumption: Standby: 13-60W Transmission: 12-60W Copy: 24-60W Maximum: 600W</p> <p>Transmission Time: Transmission time varies to task data using 170-75 No. 1 task card's memory. Use same results at maximum speed and may vary in actual usage.</p>	<p>Specifications</p> <p>Main unit specifications</p> <p>1. Applicable Lines: Public switched telephone network</p> <p>2. Compatibility: 170-75 (C)</p> <p>3. Effective Scanning Width: Max. 206mm</p> <p>4. Recording Paper Size: Letter: 214.27mm Legal: 214.25mm</p> <p>5. Effective Printing Width: 206mm</p> <p>6. Transmission Time: Approx. 20sec/page (C) (Noted under 9H) Approx. 17sec/page (C) (Original mode, 9H) Approx. 15sec/page (C) (Original mode, 9H)</p> <p>7. Fax Redial Time: Up to 90sec</p> <p>8. Telephone Redial Time: Up to 150sec</p> <p>9. Scanning Density: Horizontal: 600dpi Vertical: 3.85lines/inch (Standard mode) Vertical: 7.71lines/inch (File or Not From mode)</p> <p>10. Scanner Type: Contact Image Sensor</p> <p>11. Printer Type: Electrostatic LED array printer</p> <p>12. Data Compression System: Modified Huffman (MH), Modified READ (MR)</p> <p>13. Main Speed: 900/1200/1600/2400dpi; Automatic Feedback</p> <p>14. Operating Environment: 10-32.5 C 20-65°F</p> <p>15. Dimensions (H x D): 271 x 48.6mm</p> <p>16. Power Consumption: Standby: 13-60W Transmission: 12-60W Copy: 24-60W Maximum: 600W</p> <p>Transmission Time: Transmission time varies to task data using 170-75 No. 1 task card's memory and may vary in actual usage.</p> <p>NOTE: The specifications are subject to change without notice.</p>

Note:

- The image area changes with the depth, thickness and size of the characters in the document.

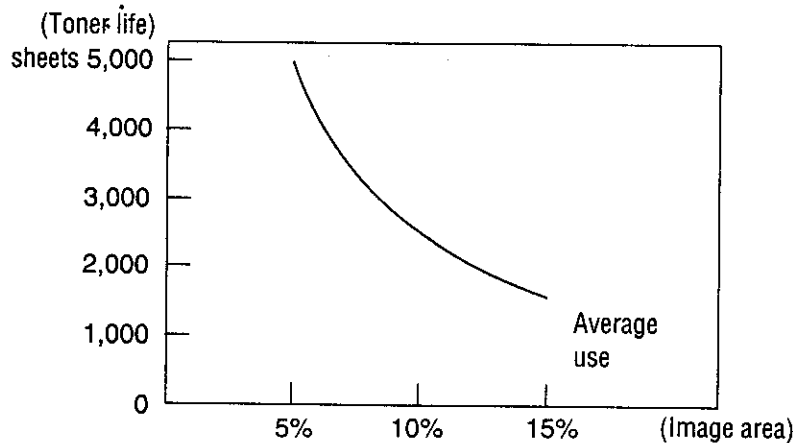

Note:

- Toner life will vary depending on actual usage.

Drum life

The included drum unit or KX-FA75A drum unit can print approx. 5,000 sheets of A4 size paper regardless of the content of image area.

Index

- A** Accessories 6
 Address Book 80, 100
 Advanced features 137, 138
 (Resetting) 130
 Answering machine 63–65
 AUTO ANSWER button 56–58, 61, 68
 AUTO ANSWER mode 56–58, 68
 Auto reduction 71
- B** Basic features 136
 BROADCAST keys 51, 53
 Broadcast list 129
 Broadcast report 53
- C** Character table 31
 Cleaning 122
 COLLATE button 76
 Communication Log 80, 98, 106
 Communication messages 109
 Connecting tone 55
 Connections 10, 28
 Copier 105
 Copy
 (Collated) 76, 77
 (Enlargement/reduction) 76, 77
 (Multiple copies) 76
 COPY button 14, 76
- D** Date and time 29
 Delayed transmission 49
 Dialing mode 36
 Directory feature 39, 41, 45
 DIRECTORY
 PROGRAM button 37, 39, 40, 51, 52
 Display
 (Contrast) 130
 (Error messages) 110, 111
 Distinctive Ring service 70
 Document jam 122
 Document size 46, 131
 Drum life 133
 Drum unit
 (Installing) 8, 22–24
 (Replacing) 123–125
- E** EASY DIAL
 (Making a voice call) 41
 (Selecting characters) 31
 (Sending faxes) 45
 (Storing) 39, 40
 Enlarge/Reduce copy 76, 77
 Envelope specifications 91
 Error correction mode setting 55
 Error messages 109–111
 Extension telephone 60, 67
- F** Facsimile telephone number 32
 FaxAbility 70
 Fax activation code 60
 Fax auto redial 44
 FAX ONLY mode 56, 61, 62
 FAX ONLY ring count 62
 Fax pager 74
 Feature list 129
 Feeder jam 122
 Friendly reception 58, 73
- H** Half-tone setting 54
 Handset cord 10, 28
 HANDSET MUTE button 34
 HELP button 18
 HYPHEN key 30, 31, 37
- I** INSERT key 30, 31
- J** Jam 120–122
 Journal auto print 48
 Journal report 48, 129
- L** List
 (Broadcast) 129
 (Feature) 129
 (Telephone number) 129
 Location panel 20, 21
 Logo 30, 31
 LOWER key 37, 38, 44
- M** Manual feeding 88
 Media size 88, 132
 Melody ring 36
 Memory reception alert 58, 72
 Memory transmission 50
 MONITOR button 34, 38, 42
 Monitor volume 33
- N** NAME/TEL NO. key 41
- O** One-Touch Dial
 (Making a voice call) 38
 (Sending faxes) 44
 (Storing) 37
 Other size documents 71
 Overseas transmission mode 54
 Overview 19

- P**
 - Pager call 74
 - PANA LINK software
 - (Activating) 80
 - (Installing) 79
 - (Setup) 82
 - Paper jam 120, 121
 - Paper stacker 9, 27
 - Paper tray 9, 27, 88
 - PAUSE button 35
 - PC link 108
 - Power down report 119
 - Power failure 119
 - Power supply/cord 10, 28, 131
 - Printing paper size 132
 - Printing reports 129
 - Problem solving
 - (Fax machine) 112–114
 - (PC software) 115–119
 - Programmable features 136–138
- Q**
 - QUICK SCAN button 50, 76
- R**
 - RECALL button 35
 - Receiving
 - (Fax) 13, 58
 - (Setting) 56, 57
 - Receiving reduction 71
 - Recording paper 9, 25, 26, 132
 - Recording paper jam 120, 121
 - REDIAL button 34, 43
 - Remote activation ID 65
 - Report
 - (Broadcast) 53
 - (Feature setting) 129
 - (Journal) 48, 129
 - (Sending) 47
 - (Telephone numbers) 129
 - Reset 130
 - RESOLUTION button 43–45, 76
 - Ring count 62, 69
 - Ringer volume 33
- S**
 - Scanner 101
 - SECRET key 37, 39
 - Sending
 - (EASY DIAL) 45
 - (From memory) 50
 - (From PC) 92–96
 - (Manually) 12, 43
 - (Multiple stations) 53
 - (One-Touch Dial) 44
 - Sending document jam 122
 - Sending report 47
 - Set default 130
 - Silent detection 72
 - Silent fax recognition ring 69
 - Specifications
 - (Common) 131
 - (Fax/Copy) 131
 - (Printer) 132
 - (Scanner) 132
 - Storing
 - (EASY DIAL) 39, 40
 - (One-Touch Dial) 37
- T**
 - TEL mode 56, 58
 - TEL/FAX delayed ring count 69
 - TEL/FAX mode 66–69
 - Telephone line cord 10, 28
 - Telephone number list 129
 - Toner cartridge
 - (Installing) 22–24
 - (Replacing) 123–125
 - Toner life 133
 - Toner save 75
 - Transmission
 - (EASY DIAL) 45
 - (Manually) 12, 43
 - (One-Touch Dial) 44
 - Transmittable document 46, 131
- V**
 - Viewer 80, 107
 - Voice call
 - (Answering) 11, 34
 - (EASY DIAL) 41
 - (Making) 11, 34
 - (One-Touch Dial) 38
 - (PC) 99
 - Voice contact 42
 - VOLUME button 33

Features Summary

Summary of user programmable features

Basic features

Code	Feature & Display	Available settings	Meaning	Page
#01	Setting the date and time SET DATE & TIME	(2 digits for each entry)	mm/dd/yy hh:mm	29
#02	Setting your logo YOUR LOGO	(Up to 30 characters)		30
#03	Setting your facsimile telephone number YOUR FAX NO.	(Up to 20 digits)		32
#04	Printing the sending report SENDING REPORT	ERROR ON OFF	If transmission fails Activate Deactivate	47
#06	Setting the ring count in the FAX ONLY mode FAX RING COUNT	2, 3, 4, 5, 6, 7, 8, 9	2 to 9 rings	62
#12	Securing the remote operation for the answering machine REMOTE TAM ACT.	ON / ID=11 OFF	Activate Deactivate	65
#13	Setting the dialing mode (KX-FLM600AL only) DIALING MODE	TONE PULSE	Sets to TONE Sets to PULSE	36
#14	Setting the PC link PC LINK	ON OFF	Activate Deactivate	108
#16	Setting the recording paper size PAPER SIZE	A4 LETTER LEGAL	A4 size paper Letter size paper Legal size paper	32

(The pre-selected value is in bold.)

Note:

- You can display the basic features in the order above by rotating **EASY DIAL** instead of entering the code number (#01, #02, etc.).

Features Summary

Advanced features

Code	Feature & Display	Available settings	Meaning	Page
#22	Setting the journal report to print automatically AUTO JOURNAL	ON	Activate	48
		OFF	Deactivate	
#23	Sending documents overseas OVERSEAS MODE	ON	Activate	54
		OFF	Deactivate	
#25	Sending a fax at a specific time DELAYED SEND	ON	Activate	49
		OFF	Deactivate	
#30	Setting the silent fax recognition ring count SILENT FAX RING	(KX-FLM600AL) 3, 4, 5, 6	3 to 6 rings	69
		(KX-FLM600NZ) 3, 4, 5, 6, 7, 8, 9	3 to 9 rings	
#31	Setting the Distinctive ring pattern feature RING DETECTION	ON	Activate	70
		OFF	Deactivate	
#37	Receiving other sizes of documents AUTO REDUCTION	ON	Reduces large size documents to fit onto A4 size paper.	71
		OFF	Deactivate	
#38	Changing the half-tone setting HALFTONE MODE	AUTO	For photographs and words	54
		PHOTO	For photographs	
#39	Changing the display contrast LCD CONTRAST	NORMAL	Normal contrast	130
		DARKER	Darker contrast	
#40	Setting the silent detection SILENT DETECT.	ON	Activate	72
		OFF	Deactivate	
#41	Changing the fax activation code FAX ACTIVATION	ON / CODE= *9	Activate	60
		OFF	Deactivate	
#44	Setting the memory reception alert RECEIVE ALERT	ON	Activate	72
		OFF	Deactivate	
#46	Setting the friendly reception FRIENDLY RCV	ON	Activate	73
		OFF	Deactivate	
#68	Setting the error correction mode ECM SELECTION	ON	Activate	55
		OFF	Deactivate	

(The pre-selected value is in bold.)

Features Summary

Code	Feature & Display	Available settings	Meaning	Page
#70	Signaling your pager when your unit receives a fax FAX PAGER CALL	ON	Activate	74
		OFF	Deactivate	
#71	Setting the melody ringer MELODY RINGER	A, B, C	Melody rings A, B or C	36
#76	Setting the connecting tone CONNECTING TONE	ON	Activate	55
		OFF	Deactivate	
#77	Changing the AUTO ANSWER setting AUTO ANSWER	FAX ONLY	Facsimile only mode	68
		TEL/FAX	Telephone/Facsimile mode	
#78	Setting the TEL/FAX delayed ring count TEL/FAX RING	2, 3, 4, 5, 6, 7, 8, 9	2 to 9 rings	69
#79	Setting the toner save TONER SAVE	ON	Activate	75
		OFF	Deactivate	
#80	Resetting the advanced features SET DEFAULT	YES	Reset	130
		NO	Will not reset	

(The pre-selected value is in bold.)

Important Information (KX-FLM600AL only)

Instructions to customer

Installation

Attached to this apparatus is an approval label. This label is evidence that it is a "Permitted Attachment" which has been authorized to be connected to your telephone service.

Conditions relating to connection and operation of this Permitted Attachment are contained in Telecommunications General By-Law 220 (5).

You are authorized to install this Permitted Attachment yourself by plugging it into the line socket of any regular telephone. You may connect it in place of your existing telephone or to any spare telephone socket installed in your premises.

To disconnect your existing telephone you must first remove its plug from the line socket. You can then insert the plug of your Permitted Attachment into the socket and use your equipment.

If the plug of your existing telephone cannot be readily removed, you will have to remove the screw securing it. To do this proceed as follows:

1. Loosen screw "A" sufficiently to remove the socket cover. (See Fig. 1.)
2. Remove screw "B" and withdraw the plug. (See Fig. 2.)
3. Replace screw "B". (See Fig. 3.) Ensure that it screws completely into the socket recess. (If the screw is too long, increase the hole depth or replace the screw with one 5 mm shorter.)
4. Replace socket cover and tighten screw "A". (See Fig. 4.)

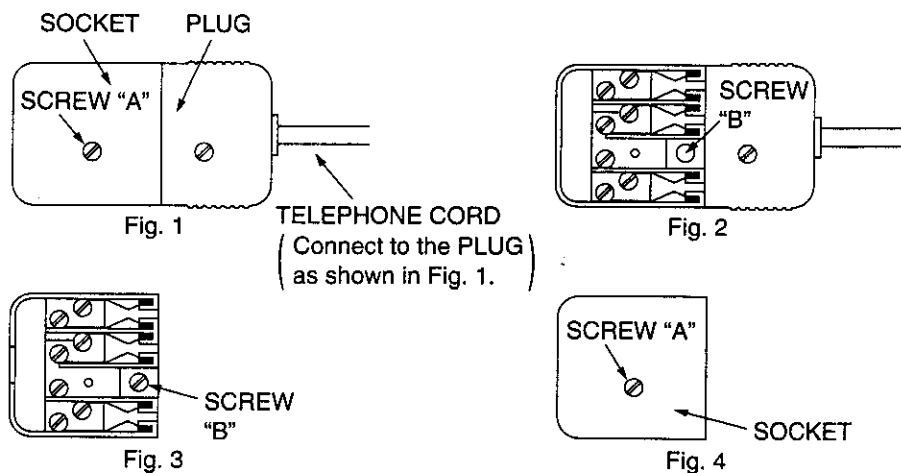

If you are satisfied with the operation of your telephone service after plugging in your Permitted Attachment, your installation is completed.

You will be unable to connect this Permitted Attachment if your telephone service consists only of a wall phone or an old style telephone which is not connected by means of a modern plug and socket. In such cases a new socket will need to be installed.

Should the Permitted Attachment not operate when plugged into a socket, it is either faulty or unsuitable for operation with your telephone service. It should be returned to the store where purchased.

Service difficulties

If at any time a fault occurs on your telephone service carry out the following checks before you call for service:

- Disconnect the Permitted Attachment and try using the service with the normal telephone.
- If the telephone service then operates satisfactorily, the fault is in your Permitted Attachment. Leave the Permitted Attachment disconnected and report the fault to its supplier or agent to arrange for repair.
- If when using the telephone the service is still faulty, report the fault to "Service Difficulties and Faults" for attention.

You are required to keep this Permitted Attachment in good working order while it is connected to your telephone service. Its construction or internal circuit must not be modified in any way without permission.

General
Information

Free Manuals Download Website

<http://myh66.com>

<http://usermanuals.us>

<http://www.somanuals.com>

<http://www.4manuals.cc>

<http://www.manual-lib.com>

<http://www.404manual.com>

<http://www.luxmanual.com>

<http://aubethermostatmanual.com>

Golf course search by state

<http://golfingnear.com>

Email search by domain

<http://emailbydomain.com>

Auto manuals search

<http://auto.somanuals.com>

TV manuals search

<http://tv.somanuals.com>