

Panasonic

Telephone Answering
System with Facsimile

KX-F50BA
MODEL NO. KX-F155BA

OPERATING INSTRUCTIONS

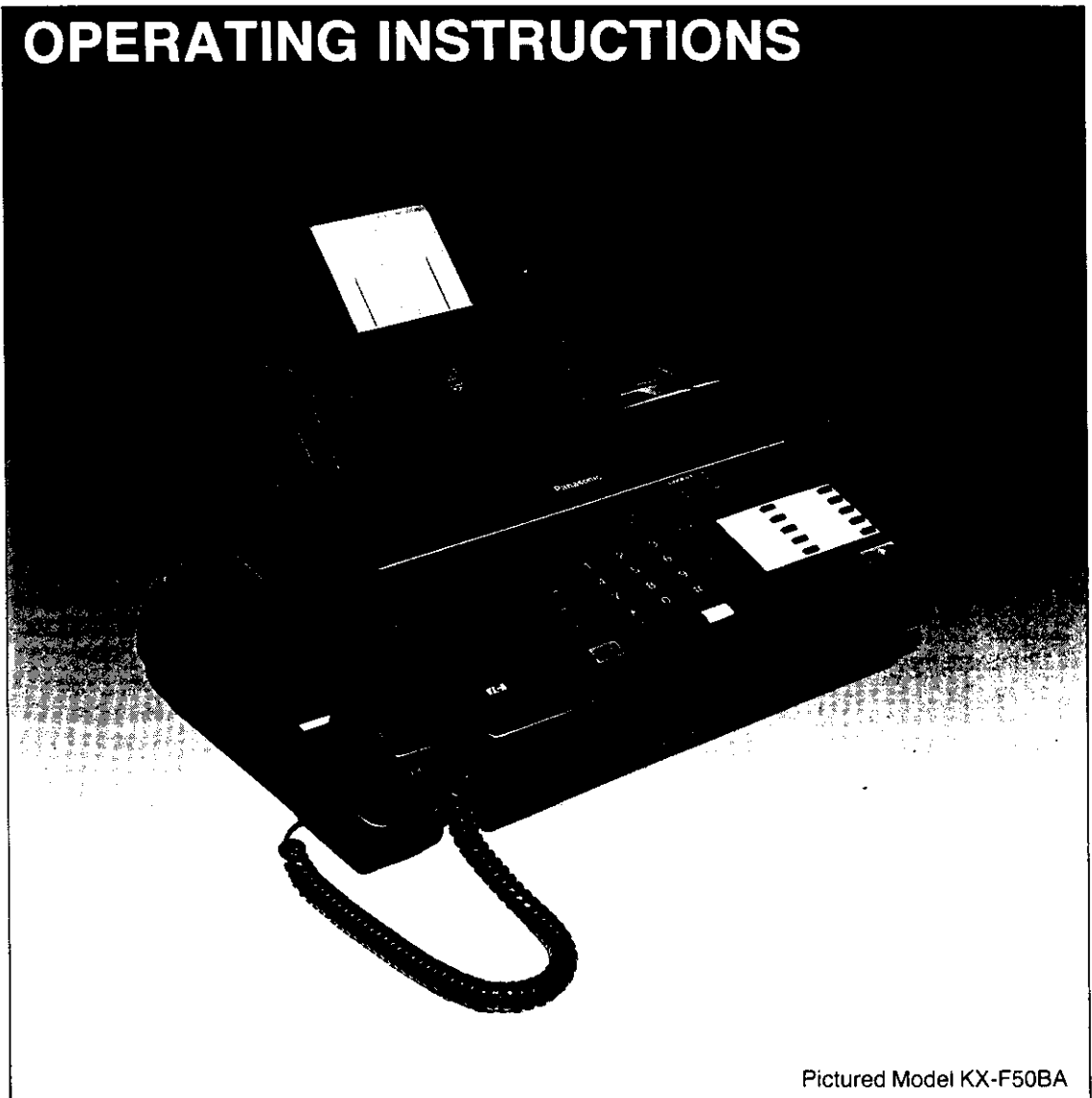

Pictured Model KX-F50BA

Please read before use.

Thank you for purchasing the Panasonic Telephone Answering System with Facsimile.

Before using the unit, please read these OPERATING INSTRUCTIONS. You can then easily install, configure and operate the unit properly.

This unit combines multiple functions of Facsimile, Answering Device and Telephone, so you can send and receive both voice-messages and documents on a single telephone line.

WARNING

WHEN A FAILURE OCCURS WHICH RESULTS IN THE INTERNAL PARTS BECOMING ACCESSIBLE, DISCONNECT THE POWER SUPPLY CORD IMMEDIATELY AND RETURN THIS UNIT TO AN AUTHORIZED SERVICE CENTER.

DISCONNECT THE TELECOM CONNECTION BEFORE DISCONNECTING THE POWER CONNECTION PRIOR TO RELOCATING THE EQUIPMENT, AND RECONNECT THE POWER FIRST.

THE POWER SOCKET WALL OUTLET SHOULD BE LOCATED NEAR THIS EQUIPMENT AND BE EASILY ACCESSIBLE.

TO PREVENT FIRE OR SHOCK HAZARD, DO NOT EXPOSE THIS PRODUCT TO RAIN OR ANY TYPE OF MOISTURE.

Introduction

Multi-function system using one telephone line

General:

- Desk-top type
- Combined facsimile, answering device and integrated telephone
- Single telephone line operation
- Automatic answering device/facsimile switching
- Clear copies

Facsimile (FAX):

- CCITT G3 compatibility
- Transmission time*: Approximately 17 seconds per page
- Automatic document feeder for up to 10 pages at a time
- One touch transmission with automatic dialer
- Superb image quality
- Polling function
- Automatic fall back (9600/7200/4800/2400 bps)

*Transmission times apply to text data using CCITT No.1 test chart, between same machine models at maximum modem speed. Transmission times vary in actual usage.

Telephone Answering Device (TAD):

- One touch operation:
The unit automatically plays back all recorded messages and stops at the last message, then provides for answering the next call at the touch of a button.
- Record 2-way telephone conversation
- Outgoing Message (OGM) stored on chip
- Remote control from touch tone telephone

Integrated Telephone System:

- Call monitor for on-hook dialing
- One touch dialing and speed dialing
- Pulse-or-tone dialing capability

Three types of receiving mode

TAD/FAX mode:

When you wish to use the unit as a telephone answering device and a facsimile, select this mode.

When a call is received during your absence, the unit records a voice-message and/or receives a document automatically depending on the caller's choice. In this mode, you also are able to speak with the other party and transmit/receive a document manually.

The unit automatically distinguishes between voice and fax calls. If a fax tone is heard when the call is answered, it will switch automatically to the fax mode. If the caller's voice is heard within 5 seconds of the end of the OGM, the unit functions as an answering device.

FAX mode:

When you wish to use the unit as a facsimile machine only, select this mode.

If someone calls you when you are in the FAX mode, a fax tone sounds and the person cannot talk to you. Please inform your callers that this is a fax only telephone number.

When in the FAX mode, you may still use the fax telephone to place outgoing voice calls.

TEL (Telephone) mode:

When you wish to use the unit as a standard telephone, select this mode. If you wish to receive the incoming fax during telephone conversation, press the START/COPY button.

Table of Contents

Page

Introduction	2
---------------------------	---

Installation and Initial Preparation

Accessories	1-1
--------------------------	-----

Installation Connections	1-2
---------------------------------------	-----

Location of Controls	1-3
-----------------------------------	-----

The Buttons and Indicators	1-5
---	-----

Precaution	1-7
-------------------------	-----

Micro Cassette Tape Installation	1-8
---	-----

Recording Paper Installation	1-9
---	-----

Document Tray Installation	1-11
---	------

Selector Settings	1-12
--------------------------------	------

Turning the Power Switch On	1-12
--	------

Recording an Outgoing Message (OGM)	1-13
--	------

Suggested message	1-13
-------------------------	------

Recording your OGM	1-14
--------------------------	------

Verifying or changing your OGM	1-14
--------------------------------------	------

Re-recording of OGM	1-14
---------------------------	------

Programming Functions	1-15
------------------------------------	------

List of programming functions	1-15
-------------------------------------	------

Programming	1-16
-------------------	------

Programming your logo	1-17
-----------------------------	------

Programming your facsimile telephone number	1-19
---	------

Programming Phone Numbers for Automatic Dialing	1-20
--	------

Programming phone numbers for one touch dialing	1-20
---	------

Programming phone numbers for speed dialing	1-21
---	------

Programming secret phone numbers	1-22
--	------

Erasing a phone number	1-23
------------------------------	------

Listing the directory card	1-23
----------------------------------	------

Basic Instructions

Page

Facsimile machine

Before Transmitting Documents	2-1
Acceptable documents	2-1
Document loading	2-2
Resolution and contrast	2-2
Transmitting Documents	2-3
Manual transmission	2-3
One touch transmission	2-4
Adding extra pages	2-4
Transmitting documents using the REDIAL button	2-5
Receiving Documents and/or Voice-Messages	2-6
Receiving mode	2-6
Manual reception	2-7
Voice Contact	2-8
Initiating voice contact	2-8
Receiving a request for voice contact	2-8
Making Copies	2-9

Answering device

Operating as an Answering Device	2-10
Recording after the messages you want to save	2-11
Recording a memo message	2-12
Recording a 2-way conversation	2-13
Monitoring incoming calls	2-13

Telephone

Making and Answering Voice Calls	2-14
Making voice calls	2-14
Redialing (Repeat call attempt)	2-14
Making voice calls using the automatic dialing	2-15
Answering voice calls	2-15

Advanced Instructions

Facsimile machine

Polling	3-1
Setting the polling password	3-1
Polling another facsimile	3-2
Setting the Main Password	3-3

Answering device

Operating as an Answering Device from a Remote Phone . . .	3-4
Toll saver	3-4
Summary of remote control functions	3-4

Programming a REMOTE TAD ID number for remote operation	3-5
Message playback	3-6
Newly recorded messages playback (Memory Playback)	3-6
Back space and skip forward	3-7
Recording a marker message	3-7
Resetting the tape for future messages	3-8
Re-recording an outgoing message	3-9
Skipping the OGM for ICM recording	3-9

Telephone

Other Features	3-10
TONE button (Temporary tone dialing)	3-10
RECALL button	3-10
PAUSE button	3-11
Combination dialing	3-11

General Information

Printing Reports and Lists	4-1
Individual Transmission Report (TX REPORT)	4-1
List of stored phone numbers (TELEPHONE NUMBER LIST)	4-2
System Programming Functions	4-3
FAX LOGO HEADING	4-3
FAX TX SPEED	4-3
FAX RX SPEED	4-4
TONE DETECT	4-4
RECALL	4-5
RECORDING TIME	4-5
CPC MODE	4-6
TAD RING COUNT	4-6
FAX RING COUNT	4-7
PRINTER TEST	4-7
PRINT CHARACTER CODE	4-7
RESET USER PROGRAMMABLE FUNCTIONS	4-8
Service Functions	4-9
Printing the SERVICE DATA LIST	4-9
Programming the service functions	4-9
Maintenance	4-10
Cassette deck	4-10
Facsimile machine	4-11
Troubleshooting Guide	4-12
Specifications	4-16

Installation and Initial Preparation

Accessories

1. Carefully remove the unit from the packing carton.
2. Examine the unit for signs of shipping damage.
3. All of the necessary accessories, hardware, cords, etc., are packed with the unit. Make sure that you have removed all accessories before discarding the packing material.
4. Check that all of the accessories are included. If you are missing any item, consult your place of purchase.

Telephone line cord one

AC power cord one

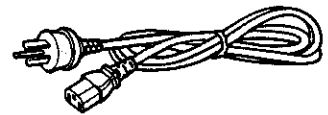
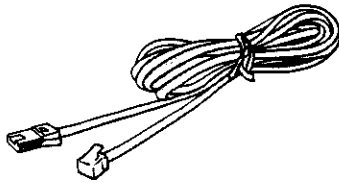

Micro cassette tape one

Recording paper one

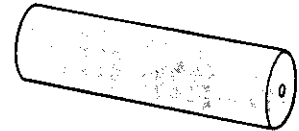
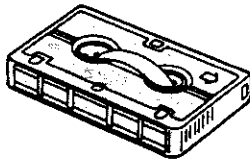

Document tray one

Handset one

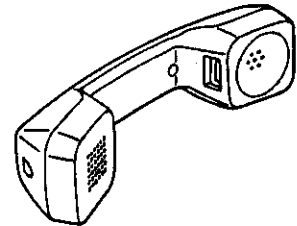
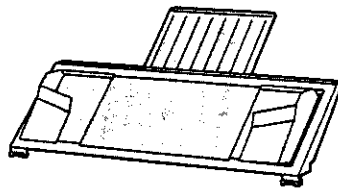

Handset cord one

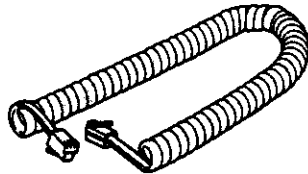

Installation Connections

Connect the AC power cord, the telephone line cord and the handset cord as shown below. Then connect your unit to the AC outlet and the telephone line.

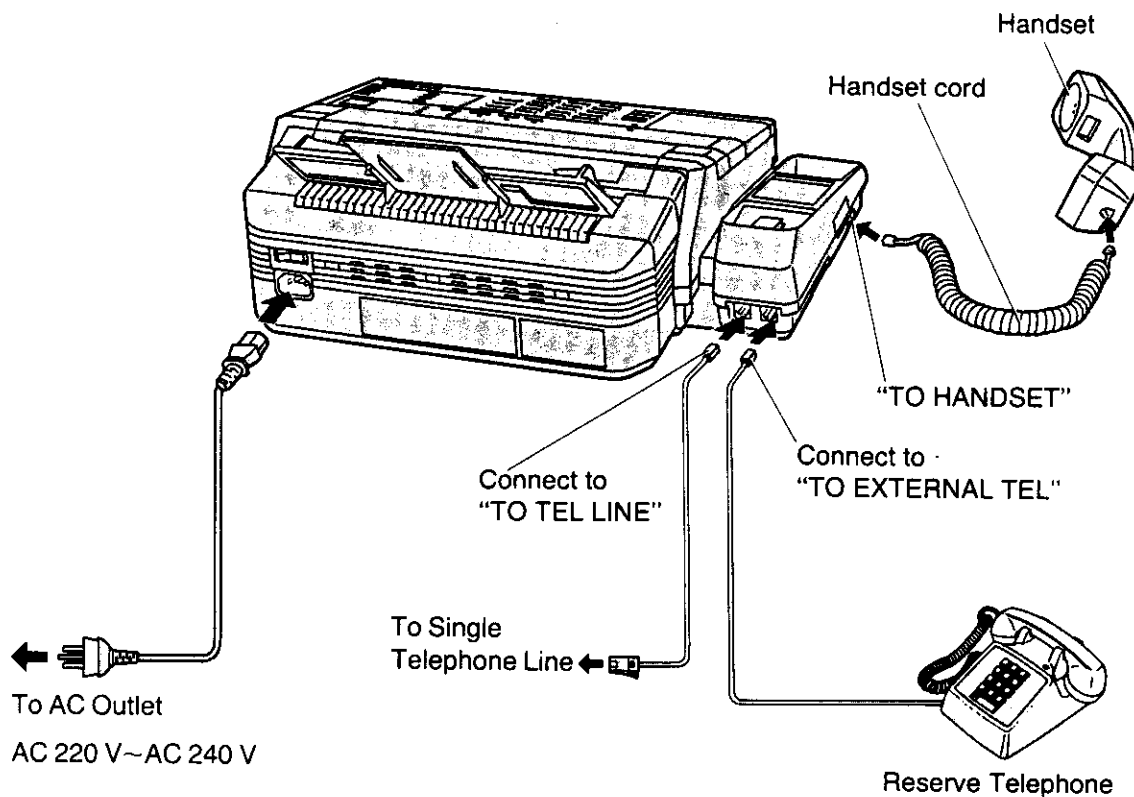

- The unit including the telephone handset will not function during a power failure or power off. However, if you have a reserve telephone connected to the port of the "TO EXTERNAL TEL", you will still be able to make calls during a power failure or power off.
- Avoid using the same AC outlet for the unit and other equipments. We recommend you to use an exclusive AC outlet to avoid interference from other equipment.
- If you connect another extension to the same line that your unit is connected to, do not use another telephone during fax transmission and reception. It will affect image quality.
- This unit is equipped with a 3-wire grounded type plug for safety. This plug will only fit into a grounding-type power outlet. If you are unable to insert the plug into your outlet, contact your electrician to replace your outlet.

Location of Controls

Front view

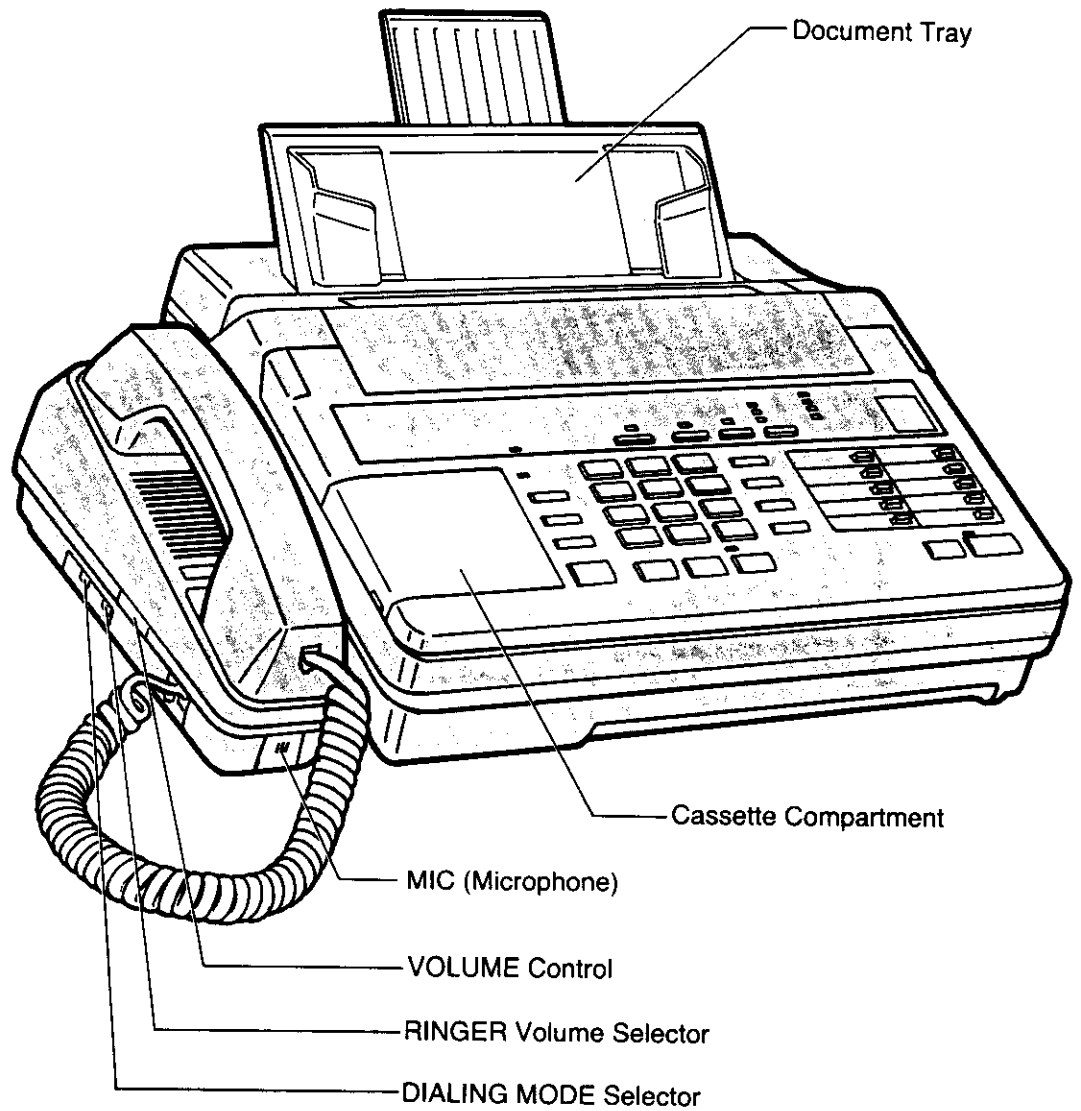

Rear view

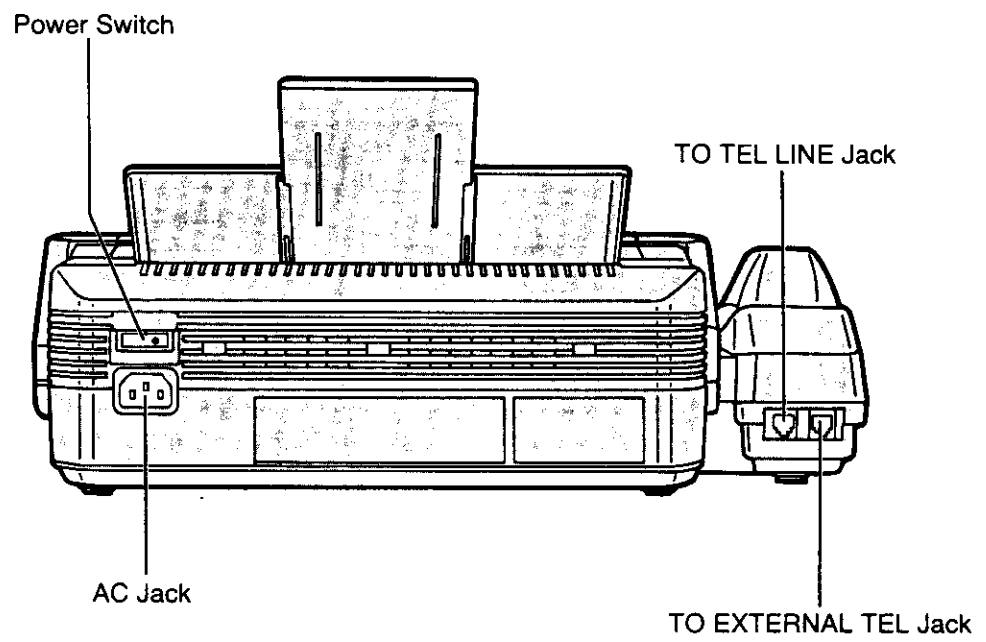

Side view

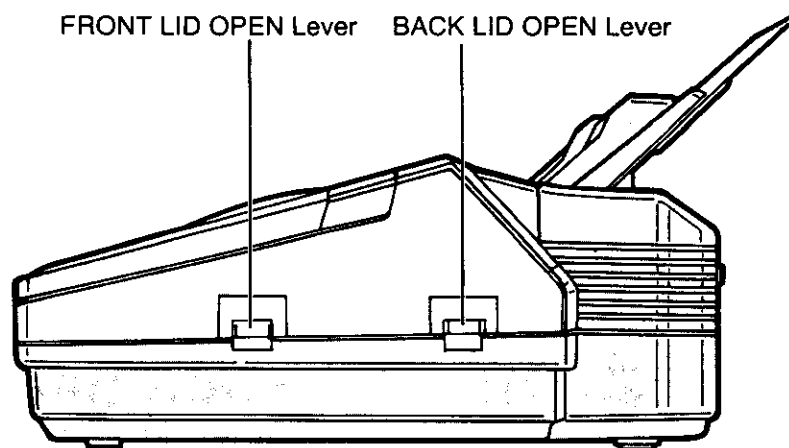

The Buttons and Indicators

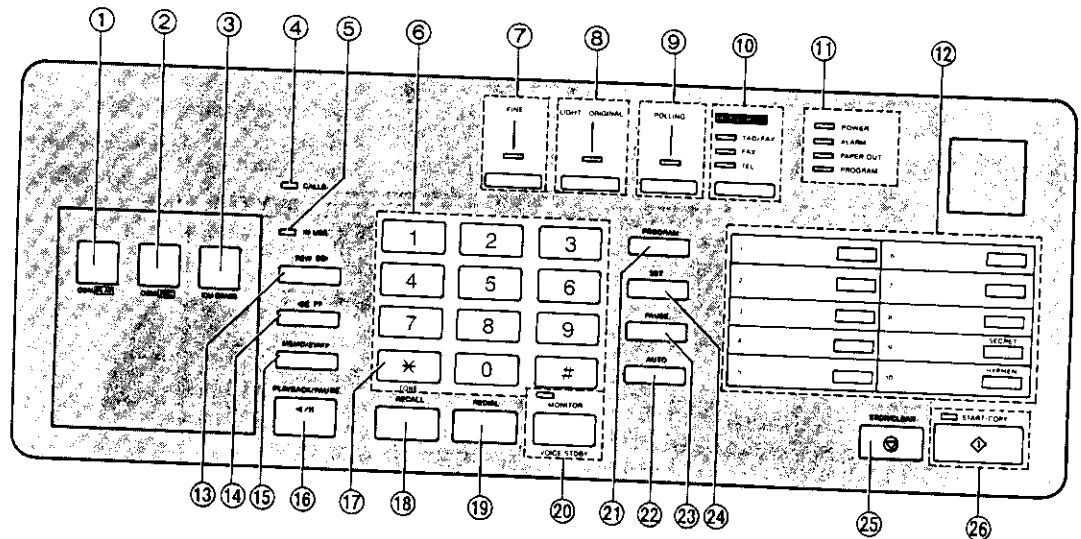

- ① **OGM PLAY Button (p. 1-14):** Used to replay your outgoing message.
- ② **OGM REC Button (p. 1-13):** Used to record your outgoing message.
- ③ **ICM ERASE Button (p. 2-10):** Used to erase recorded incoming messages at high speed.
- ④ **CALLS Indicator (p. 2-10):** The indicator flashes to show the number of incoming messages recorded.
- ⑤ **IN USE Indicator:** The indicator lights or flashes when the answering device is in use.
- ⑥ **Dial Keypad:** Used to dial or program numbers.
- ⑦ **FINE Button and Indicator (p. 2-2):** Used to set the scanning line density. The indicator lights when this feature is on.
- ⑧ **LIGHT ORIGINAL Button and Indicator (p. 2-2):** Used to transmit or copy originals with faint writing. The indicator lights when this feature is on.
- ⑨ **POLLING Button and Indicator (p. 3-2):** Used for polling function. The indicator lights when polling function is being set.
- ⑩ **RECEIVE MODE Button and Indicators (p. 2-6):** Used to select the desired receiving mode. The indicators light to show the mode in which the unit is set.

- ⑪ **POWER Indicator (p. 1-12):** The indicator lights when the POWER switch is turned on.
- ALARM Indicator (p. 4-13):** The indicator lights when any trouble occurs.
- PAPER OUT Indicator:** The indicator lights when the recording paper roll is empty.
- PROGRAM Indicator:** The indicator lights or flashes when you are programming the unit.
- ⑫ **Direct Call Station Keys (p. 1-20):** Used for one touch dialing.
- ⑬ **REW (REWIND) Button (p. 2-10):** Used to run the tape quickly backward to a desired point.
- ⑭ **FF (FAST FORWARD) Button (p. 2-10):** Used to run the tape quickly forward to a desired point.
- ⑮ **MEMO/2WAY Button (p. 2-12, 2-13):** Used to start and stop recording of a memo message or a telephone conversation.
- ⑯ **PLAYBACK/PAUSE Button (p. 2-10):** Used to play back recorded messages, or interrupt playback or FF/REW operation.
- ⑰ **TONE Button (p. 3-10):** Used to change the dialing mode from pulse to tone during a dialing operation.
- ⑱ **RECALL Button (p. 3-10):** Used to access some features of your host PBX.
- ⑲ **REDIAL Button (p. 2-14):** Used to redial the last dialed number.
- ⑳ **MONITOR (VOICE STDBY) Button and Indicator (p. 2-3, 2-8):** Used for on-hook dialing and voice contact features. The indicator lights when these functions are on.
- ㉑ **PROGRAM Button (p. 1-15):** Used to start or end programming functions.
- ㉒ **AUTO Button (p. 1-21):** Used for speed dialing.
- ㉓ **PAUSE Button (p. 3-11):** Used to insert a pause into a facsimile telephone number during programming.
- ㉔ **SET Button (p. 1-16):** Used to store parameters during programming.
- ㉕ **STOP/CLEAR Button (p. 2-3):** Used to cancel transmission or copy operation. Also used during programming to clear the previously entered parameters.
- ㉖ **START/COPY Button and Indicator (p. 2-3):** Used to start transmission and copy functions. The indicator lights when these functions are on.

Precaution

Keep the unit away from heating appliances such as radiators or air conditioning units.

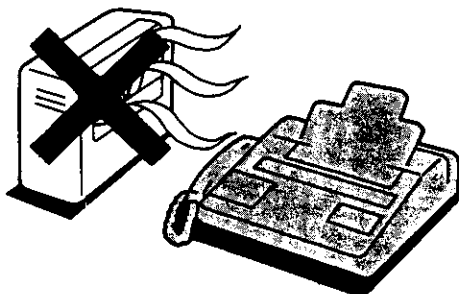

Keep the unit away from electrical noise generating devices such as fluorescent lamps and motors.

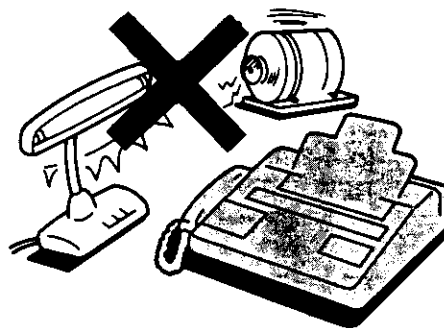

The unit and the cassette tape should not be exposed to direct sunlight.

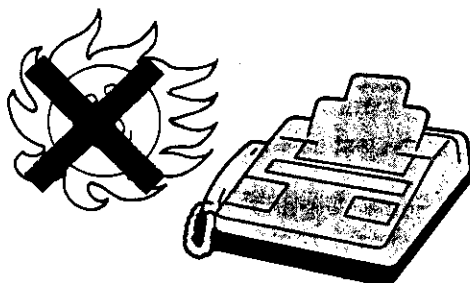

The unit and the cassette tape should be kept free from dust, moisture, high temperature and vibration.

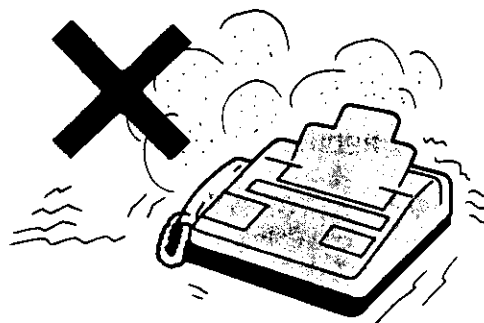

Do not use benzine, thinner, or the like, or any abrasive powder to clean the cabinet. Wipe it with a soft cloth.

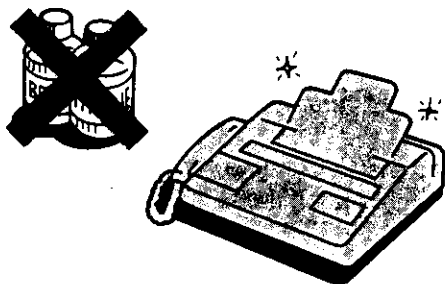

Do not place any covering over the unit while it is turned on.

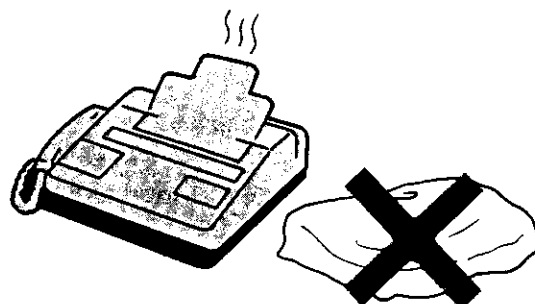

Micro Cassette Tape Installation

To record your outgoing message, install a micro cassette tape first.

1. Open the compartment cover.
2. Insert the micro cassette tape into the compartment as follows.
 - Ⓐ Slide in.
 - Ⓑ Push down.

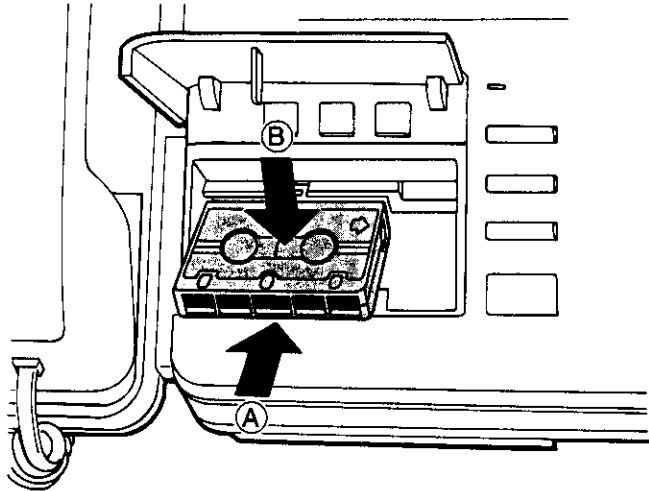

3. Close the compartment cover.

Cassette Tape

- Make sure that there is no slack in the tape. If there is any slack, remove it by rotating the tape reel with an instrument like a pencil, as shown.

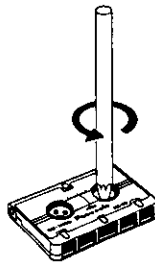

- For optimum sound quality and performance, we recommend that you use the opposite side (side-2) after six months and replace the tape with a new one every year, assuming that the unit answers about ten calls a day.
- Never place a cassette tape near a magnetic source such as a magnet or a TV set, because it may erase or break the recorded message on the tape.
- Should the cassette tape break or become worn, replace it with a new cassette tape. We recommend using the Panasonic cassette tape RT-30MC or RT-60MC.



RT-30MC



RT-60MC

Recording Paper Installation

Follow the steps below to install a new roll of recording paper.

Caution:

Use only the included roll or specified recording paper (Part No. KX-A106) for supplement or else the print quality may deteriorate or excessive thermal head wear may occur.

- 1** Press the FRONT LID OPEN lever in the direction of the arrow to open the cover.

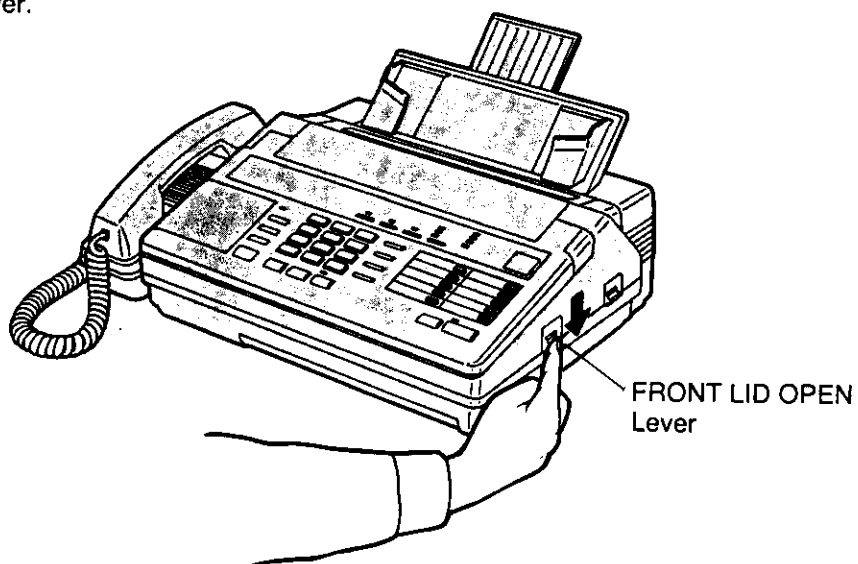

- 2** Place a recording paper roll into the paper compartment. Make sure that the shiny side of the paper is facing up and that there is no slack in the paper roll.

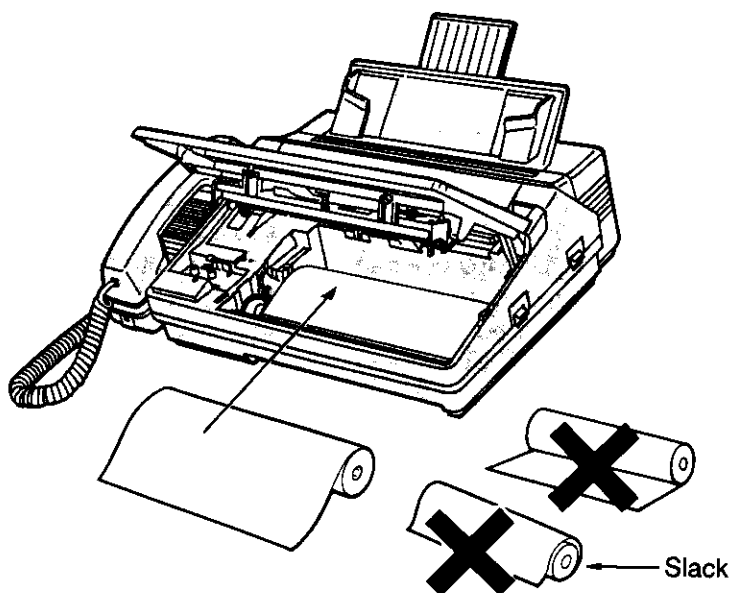

- 3** Insert the recording paper between the upper and the lower guide plates and pull the paper a few centimeters (one or two inches) out of the unit.

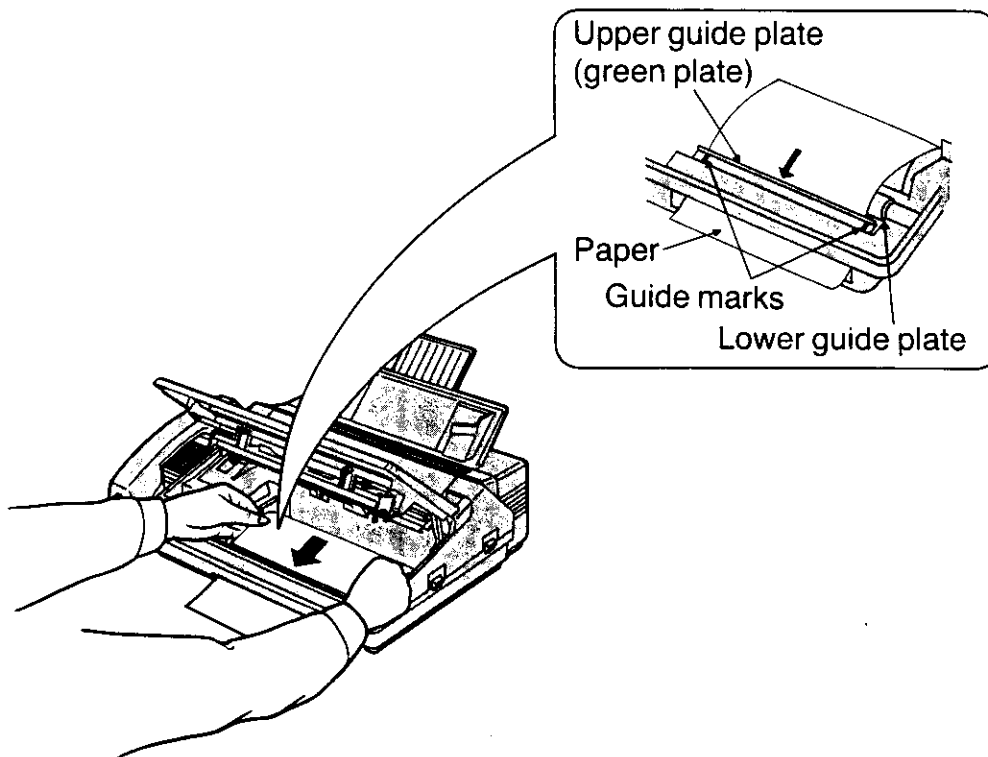

- 4** Close the cover carefully by pressing both ends gently.



Document Tray Installation

- 1 Insert the two tabs of the tray into the two grooves on the unit.

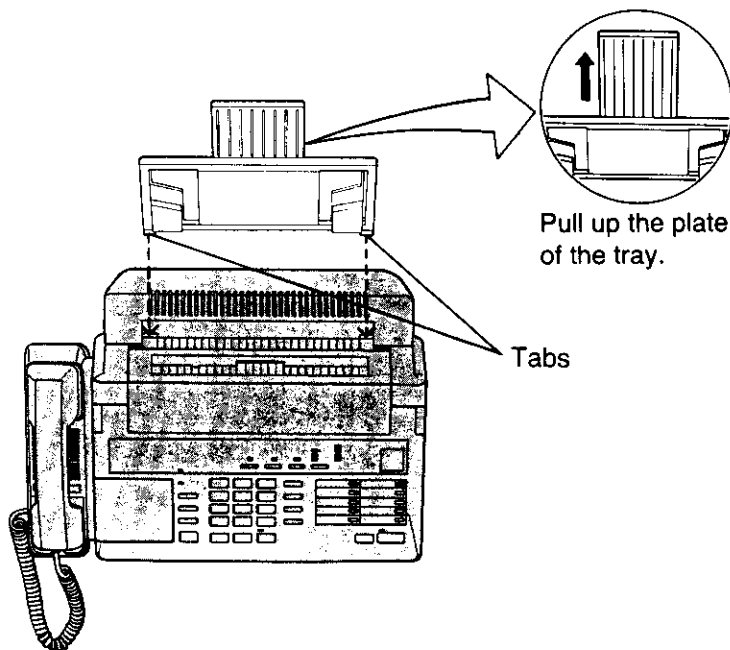

- 2 Press the center of the tray with both hands until the two fins on the rear of the tray click into place.

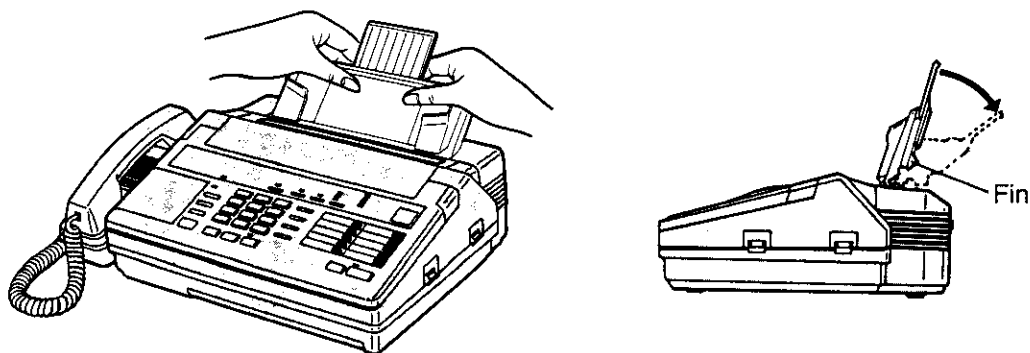

Selector Settings

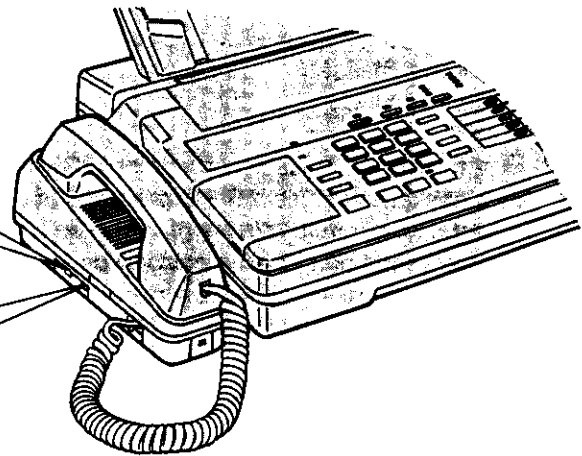
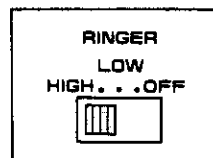
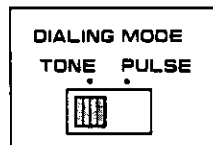

DIALING MODE:

If your line has touch tone service, set the selector to "TONE". If your line has rotary pulse dial service, set to "PULSE".

RINGER volume:

HIGH: The ringing sound will be loud.

LOW: The ringing sound will be soft.

OFF: The unit will not ring.

Turning the Power Switch On

Before turning the POWER switch on, confirm the following:

1. The cassette tape and the recording paper are installed properly.
2. The handset is on the cradle.

Turn the POWER switch to the "I (ON)" position. The POWER indicator lights.

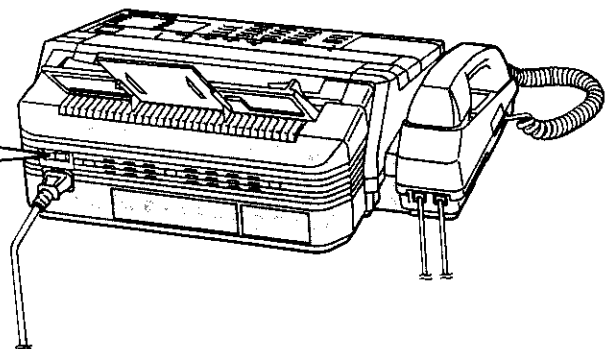
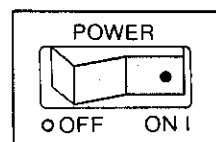

When you use the unit for the first time, the ALARM indicator will light. After recording your outgoing message, the ALARM indicator will go out. See page 1-13.

Recording an Outgoing Message (OGM)

- The outgoing message (OGM) tells the caller that you are out, and asks to leave a voice-message or to send a fax message. Before using your unit as both an answering device and a facsimile, you should first record your OGM.
- You can store a personal OGM up to 16 seconds on the voice-recordable microchip. Once recorded, the OGM will be automatically recorded on the micro cassette tape as a backup in case of power failure.
- If a power failure takes place or the POWER switch is turned off, the OGM recorded on the microchip will be erased. However, after the power is restored, the unit will automatically re-record the OGM onto the microchip using the OGM recorded on the tape. You need not re-record your OGM.

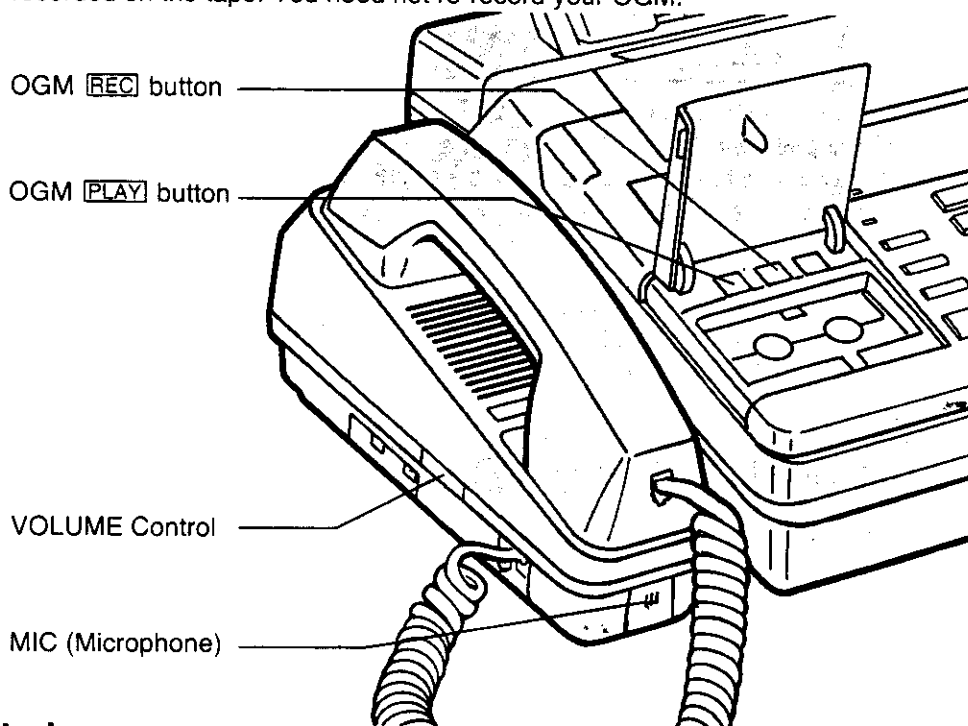

Suggested message

Record your OGM referring to the examples below.

"This is (your name, business and/or telephone number). We are out right now. To send a fax, start transmission. To leave a message, speak after the long beep. Thank you."

"This is (your name, business and/or telephone number). We are out right now. To send a fax, start transmission. To leave a message, speak for up to 1 minute after the long beep. Thank you."

You can choose from two lengths of recording times for incoming messages. When the unit is in the "VOX" position, the recording time is unlimited, and when in the "1 MIN" position, the recording time is limited to 1 minute. The two examples above correspond to these two conditions.

The unit is preprogrammed to the "VOX" position. To change the recording time, see page 4-5.

Recording your OGM

Note:

- The recording time is limited to 16 seconds. For optimum performance, we recommend that you record your OGM within 12 seconds.
- Do not pause for over 2 seconds while recording your OGM. If 16 seconds pass or a pause continues for more than 2 seconds, the unit will finish recording. The rest of your message will not be recorded.

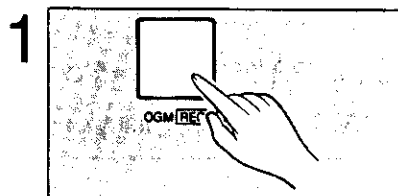

Lift the cassette compartment cover and press the **OGM REC** button until a long beep is heard, then release it.

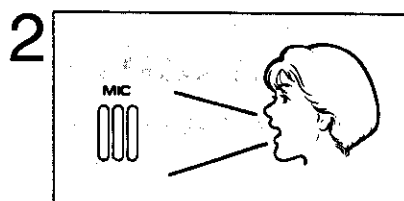

After the beep, speak immediately, clearly and loudly, toward the microphone from a distance of approximately 20 cm (8 inches).

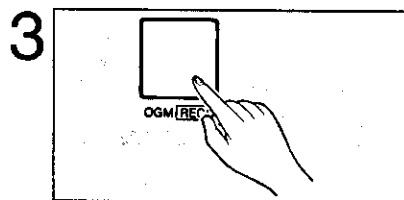

Press the **OGM REC** button again upon finishing your OGM.

4 The unit plays the stored OGM so that you can confirm your message.

5 The unit plays the stored OGM again to record your OGM on the micro cassette tape as a backup.

Note:

- If you make a mistake while recording, repeat from step 1.

Verifying or changing your OGM

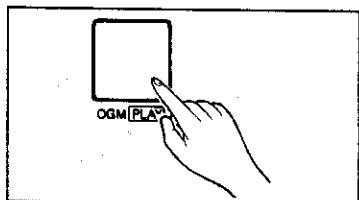

Press the **OGM PLAY** button.

The unit replays your OGM. If you want to change your OGM, perform the operation on this page again. The previous message will be automatically erased and a new message will be recorded.

Re-recording of OGM

When you replace the cassette tape with a new one or you use the opposite side (side-2), you have to record an OGM again.

Programming

To make a function change;

1. Press the **PROGRAM** button.
2. Press "#", then press code number described below.
3. If the code number pressed is 02 through 33, enter the desired value and then press the **SET** button to store the programming in memory.
If the code number pressed is 41 through 50, press the **START/COPY** button to print out reports.
4. Press the **PROGRAM** button again to end setup.

CODE	FUNCTION	DEFAULT	REFERENCE
#02	YOUR LOGO	(not entered)	See page 1-17.
#04	YOUR TELEPHONE NUMBER	(not entered)	See page 1-19.
#05	FAX LOGO HEADING	ON	See page 4-3.
#06	REMOTE TAD ID	111	See page 3-5.
#11	PRINT TX REPORT	OFF	See page 4-1.
#12	MAIN PASSWORD	0000	See page 3-3.
#16	POLLING PASSWORD	0000	See page 3-1.
#17	FAX TX SPEED	9600 BPS	See page 4-3.
#18	FAX RX SPEED	9600 BPS	See page 4-4.
#20	TONE DETECT	OFF	See page 4-4.
#21	RECALL	T-BR	See page 4-5.
#30	RECORDING TIME	VOX	See page 4-5.
#31	CPC MODE	A	See page 4-6.
#32	TAD RING COUNT	2 (twice)	See page 4-6.
#33	FAX RING COUNT	2 (twice)	See page 4-7.
#41	PRINT TEL LIST		See page 4-2.
#42	PRINTER TEST		See page 4-7.
#43	PRINT CHARACTER CODE		See page 4-7.
#50	RESET USER PROGRAMMABLE FUNCTIONS (#05 TO #33)		See page 4-8.
#9000*	SERVICE DATA SET UP		See page 4-9.

Programming your logo

The logo is a means of identifying your unit. Your logo may consist of alphanumeric letters and symbols. Your programmed logo will be printed on the top of all pages transmitted from your unit.

Your Logo	Your Telephone Number	Number of Page
FROM: PANASONIC CO.	PHONE NO.: 123 4567	P01
FAX CORRESPONDENCE		
TO: Mr. MATSUSHITA	DATE: June 5, 1991	
FROM: PANASONIC COMPANY	OUR TEL. NO.: 123-4567	

Usually the logo is a company, division or personal name in an abbreviated form. **Up to 30 characters can be entered as your logo.**

To enter each character, select the correct code (2 digits) referring to the Character Code Table on page 1-18, and program as shown below.

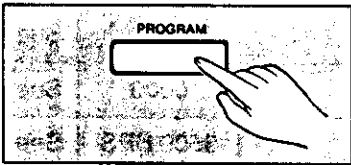
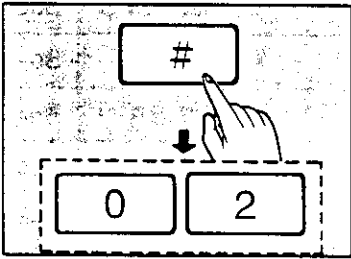
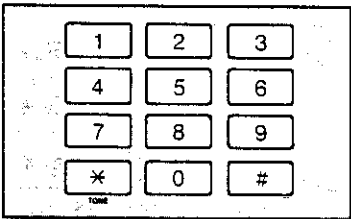
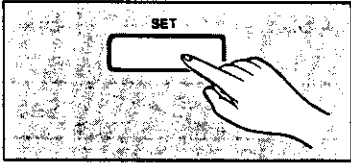
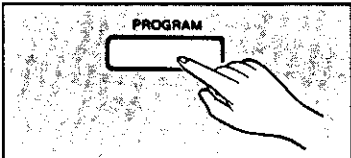
- 1**  Press the **PROGRAM** button.
The PROGRAM indicator lights.
- 2**  Press "#", then "02" for your logo setting.
- 3**  Enter your logo by using the dial keypad.
Example: If you want to program the logo as "COMPANY ABC", press "32 44 42 45 30 43 54 01 30 31 32".
To print out your logo for confirmation during programming, press the START/COPY button.
- 4**  When you have finished, press the **SET** button to store the programming in memory.
- 5**  Press the **PROGRAM** button to end the operation.
The PROGRAM indicator goes out.

Character Code Table

Input	Code	Input	Code	Input	Code	Input	Code	Input	Code
(NOTE1)	0 0)	1 0	0	2 0	A	3 0	K	4 0
(space)	0 1	*	1 1	1	2 1	B	3 1	L	4 1
!	0 2	+	1 2	2	2 2	C	3 2	M	4 2
"	0 3	,	1 3	3	2 3	D	3 3	N	4 3
#	0 4	-	1 4	4	2 4	E	3 4	O	4 4
\$	0 5	.	1 5	5	2 5	F	3 5	P	4 5
%	0 6	/	1 6	6	2 6	G	3 6	Q	4 6
&	0 7	:	1 7	7	2 7	H	3 7	R	4 7
'	0 8	;	1 8	8	2 8	I	3 8	S	4 8
(0 9	<	1 9	9	2 9	J	3 9	T	4 9
Input	Code	Input	Code	Input	Code	Input	Code	Input	Code
U	5 0	a	6 0	k	7 0	u	8 0	_	9 0
V	5 1	b	6 1	l	7 1	v	8 1	`	9 1
W	5 2	c	6 2	m	7 2	w	8 2	{	9 2
X	5 3	d	6 3	n	7 3	x	8 3		9 3
Y	5 4	e	6 4	o	7 4	y	8 4	}	9 4
Z	5 5	f	6 5	p	7 5	z	8 5	→	9 5
=	5 6	g	6 6	q	7 6	[8 6	(NOTE2)	9 6
>	5 7	h	6 7	r	7 7	¥	8 7		9 7
?	5 8	i	6 8	s	7 8]	8 8		9 8
@	5 9	j	6 9	t	7 9	^	8 9		9 9

NOTE 1: Enter "00" to erase all of the characters that have been programmed. (All Clear)

NOTE 2: Enter "96" to delete the last character. (Back Space)

- Check your logo and codes referring to the character code table before programming.

Example: If the logo is Panasonic, fill out the form as follows.

Input	P	a	n	a	s	o	n	i	c		
Code	45	60	73	60	78	74	73	68	62		

Write your own logo and its code in the form below.

Input																			
Code																			
Input																			
Code																			

Programming your facsimile telephone number

Your facsimile telephone number can be programmed into your unit. When you transmit a document, your programmed telephone number will be printed on the top of all pages transmitted from your unit. The unit can hold your phone number up to 20 digits long. Program as shown below.

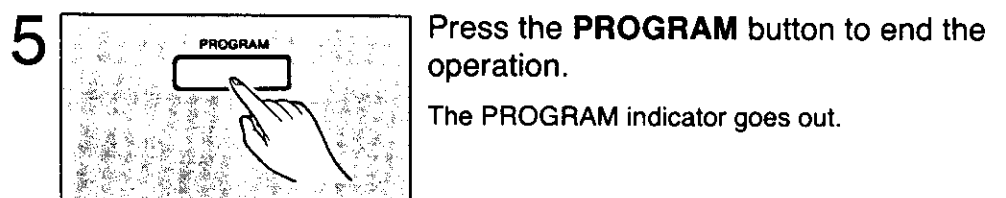
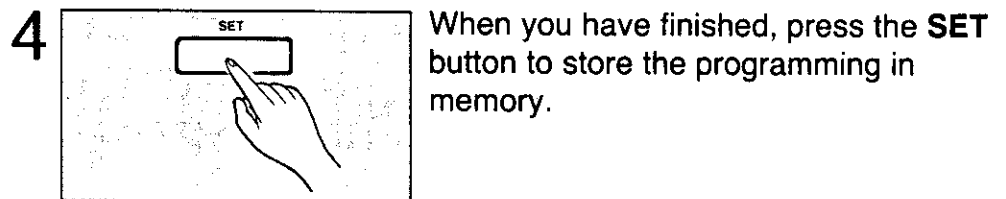
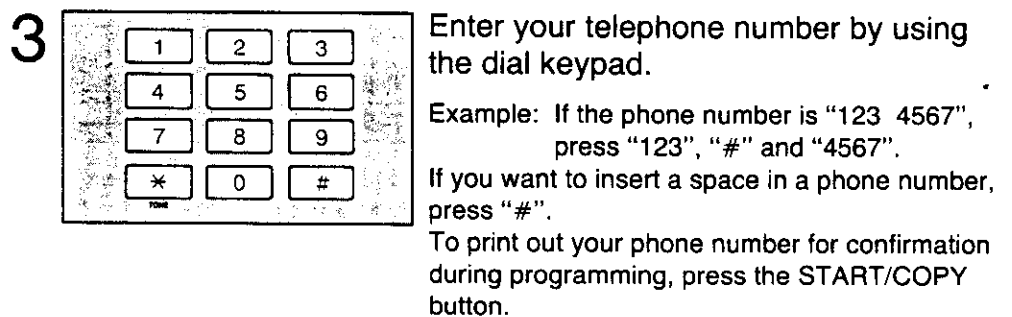
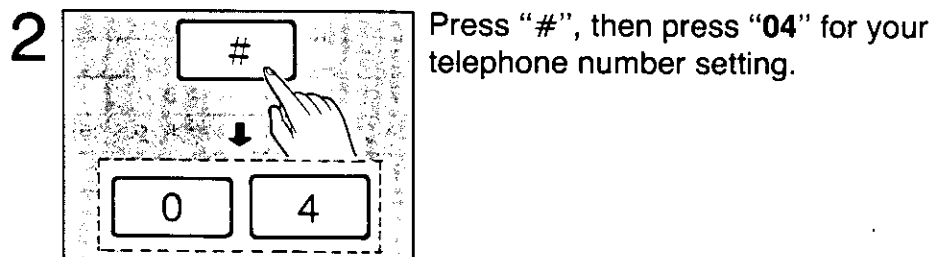
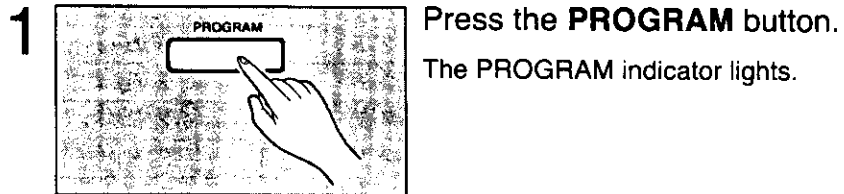

Note: To correct an error while programming, press the STOP/CLEAR button then repeat from step 2.

Programming Phone Numbers for Automatic Dialing

The unit's memory allows you to use both one touch dialing (up to 10 phone numbers) and speed dialing (up to 20 phone numbers) for rapid access to your most frequently called numbers.

Programming phone numbers for one touch dialing

This unit is equipped with 10 direct call stations including SECRET and HYPHEN keys, each of which can store a telephone number for one touch dialing. Each phone number can be programmed up to 30 digits long. Make sure first whether the DIALING MODE selector is set to TONE or PULSE mode.

1

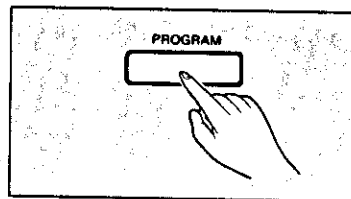

Press the **PROGRAM** button.

The PROGRAM indicator lights.

2

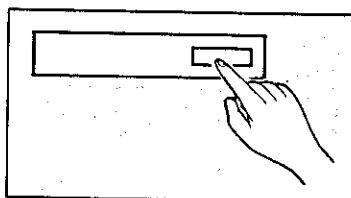

Press one of the direct call station keys where you want to store the phone number.

3

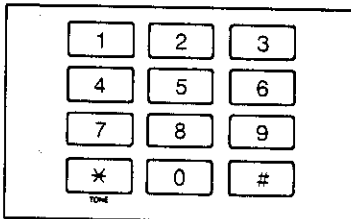

Enter the phone number by using the dial keypad.

If you want to insert a hyphen in the number, press the HYPHEN key during programming. HYPHEN is counted as 2 digits.

4

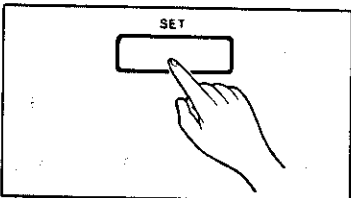

Press the **SET** button to store the programming in memory.

To program other phone numbers, repeat steps 2 to 4.

5

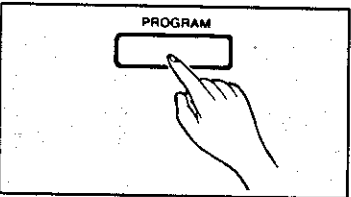

After programming all the numbers, press the **PROGRAM** button to end the operation.

The PROGRAM indicator goes out.

Note: To correct an error while programming, press the STOP/CLEAR button then repeat from step 2.

You can print a list of the stored phone numbers. See page 4-2.

*

1-20

Programming phone numbers for speed dialing

This unit is equipped with 20 stations (00 through 19), each of which can store a telephone number for speed dialing. Each phone number can be programmed up to 30 digits long.

Make sure first whether the DIALING MODE selector is set to TONE or PULSE mode.

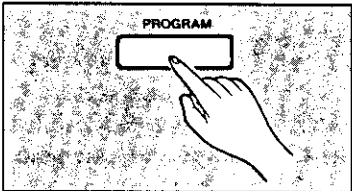
- 1  Press the **PROGRAM** button.
The PROGRAM indicator lights.

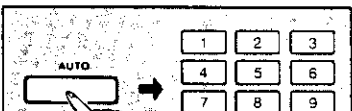
- 2  Press the **AUTO** button, then enter the station number at 2 digits ("00" through "19") by using the dial keypad.

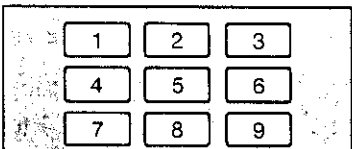
- 3  Enter the phone number.
If you want to insert a hyphen in the number, press the HYPHEN key during programming. HYPHEN is counted as 2 digits.

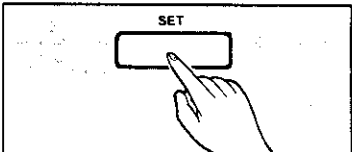
- 4  Press the **SET** button to store the programming in memory.
To program other phone numbers, repeat steps 2 to 4.

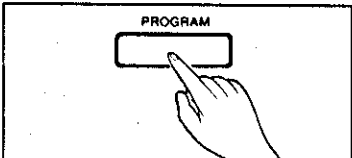
- 5  After programming all the numbers, press the **PROGRAM** button to end the operation.
The PROGRAM indicator goes out.

Note: To correct an error while programming, press the STOP/CLEAR button then repeat from step 2.

You can print a list of the stored phone numbers. See page 4-2.

Programming secret phone numbers

This function is useful for keeping the whole or a portion of a telephone number secret. When you print out a list of the stored numbers, this number will not be printed.

1

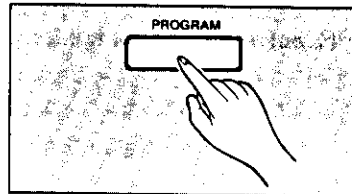

Press the **PROGRAM** button.
The PROGRAM indicator lights.

2

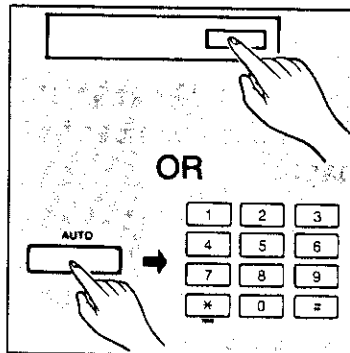

Press one of the direct call station keys.
OR
Press the **AUTO** button and enter the station number ("00" through "19") by using the dial keypad.

3

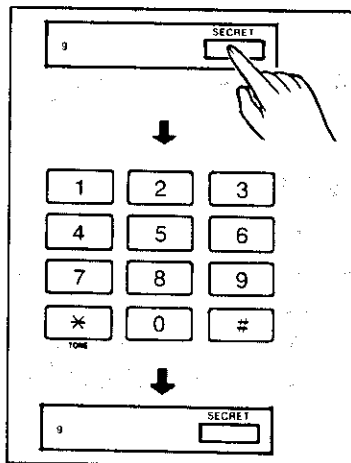

Press the **SECRET** key and enter the phone number, then press the **SECRET** key again.

Pressing the SECRET key once counts as 2 digits.

4

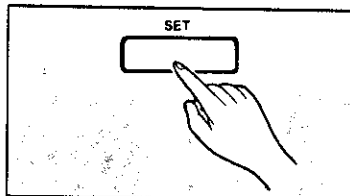

Press the **SET** button to store the programming in memory.

To program other phone numbers into memory, repeat steps 2 to 4.

5

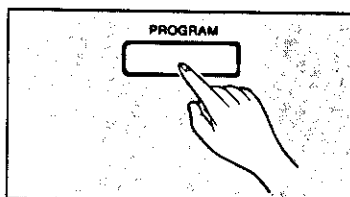

After programming all the numbers, press the **PROGRAM** button to end the operation.

The PROGRAM indicator goes out.

Note: To correct an error while programming, press the STOP/CLEAR button then repeat from step 2.

Erasing a phone number

If you wish to erase a phone number programmed into memory, follow the steps below.

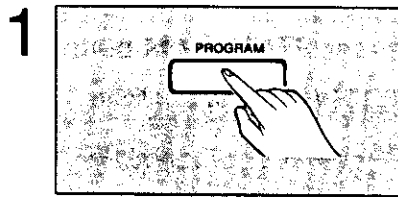

Press the **PROGRAM** button.
The PROGRAM indicator lights.

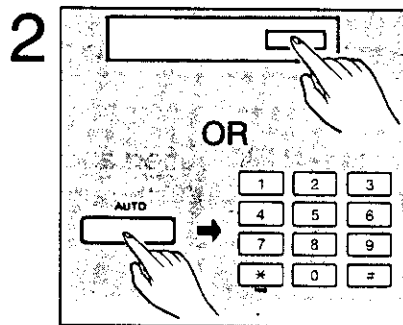

Press the desired direct call station key.
OR
Press the **AUTO** button, then enter the desired station number by using the dial keypad.

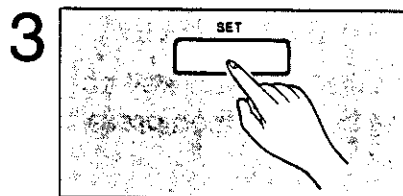

Press the **SET** button.
The number will now be erased.
If you wish to erase more than one number, repeat from step 2.

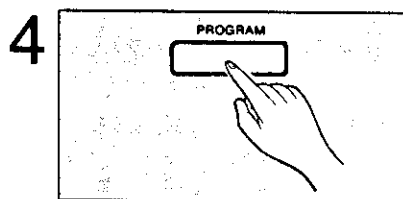

Press the **PROGRAM** button to end the operation.
The PROGRAM indicator goes out.

Listing the directory card

Remove the cover using an instrument with a pointed end like a pen.
Write the names of the other parties in the directory.

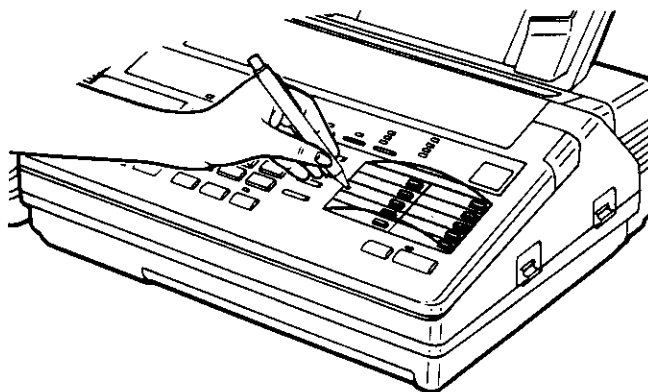

Basic Instructions

Before Transmitting Documents

Acceptable documents

The unit can transmit documents that meet the following conditions.

- Paper width should be 128 mm (5") to 216 mm (8½").
- Effective scanning width should be up to 208 mm (8¾").
- Paper weight should be 45 g/m² (12 pounds) to 90 g/m² (24 pounds).

Maximum paper size

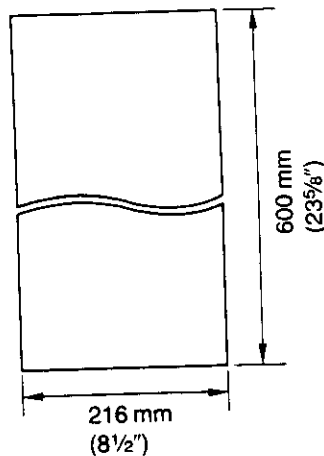

Minimum paper size

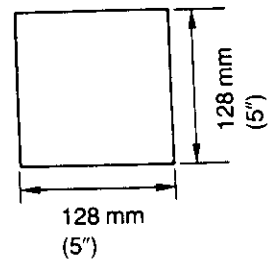

Effective scanning width

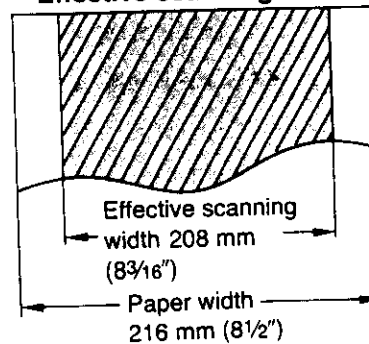

Automatic document feeder:

- Up to 10 sheets of paper can be set in the document tray at a time.
- Paper weight should be 60 g/m² (16 pounds) to 75 g/m² (20 pounds).
- Paper with a coated surface must not be used.

Do not use the following types of documents or they may jam. Make a copy of such documents and feed the copy into the unit.

- Paper with chemically treated surfaces such as carbon paper or carbonless duplicating paper
- Heavily curled, creased or torn paper
- Paper with a coated surface
- Small size paper such as a slip or voucher
- Thin paper less than 45 g/m² (12 pounds)
- Thick paper over 90 g/m² (24 pounds)
- Paper whose contrast between the print and the background is faint
- Paper whose printing on the reverse side can be seen through from the front (e.g. newspaper)

Remove clips, staples or other similar objects from a document before feeding it into the unit.

Make sure that any ink or paste on the document is completely dry before feeding it into the unit.

Note:

- A document whose length exceeds 600 mm (23⁵/₈") cannot be transmitted. When you feed such document, the unit stops transmitting and a long beep will be heard. If this happens, press the STOP/CLEAR button and remove the document.
- If a document is electrostatically charged, the automatic document feeder may not function properly.

Document loading

Place the documents on the tray **FACE DOWN**.

After aligning the documents, adjust the document guide according to their width.

Resolution and contrast

You can set the following functions depending on the quality of an original. Set the functions before transmission or copying. If you set them during transmission, they will be effective from the next sheet to be transmitted.

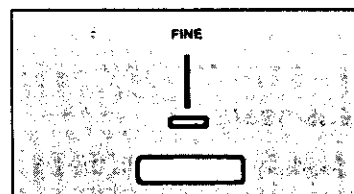

FINE is suitable for originals written with small characters.
Press the **FINE** button. The **FINE** indicator lights.

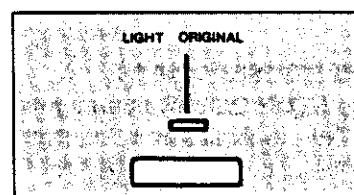

LIGHT ORIGINAL is useful when transmitting or copying originals with faint writing.
Press the **LIGHT ORIGINAL** button. The **LIGHT ORIGINAL** indicator lights.

Transmitting Documents

Manual transmission

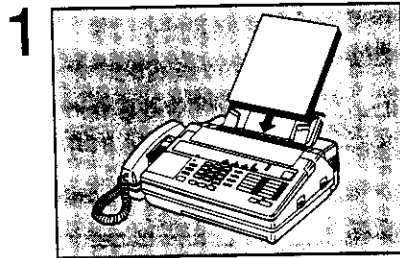

Insert the documents **FACE DOWN**.
The unit can accept up to 10 sheets of paper at a time.

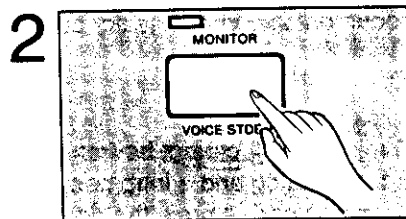

Press the **MONITOR** button or lift the handset.

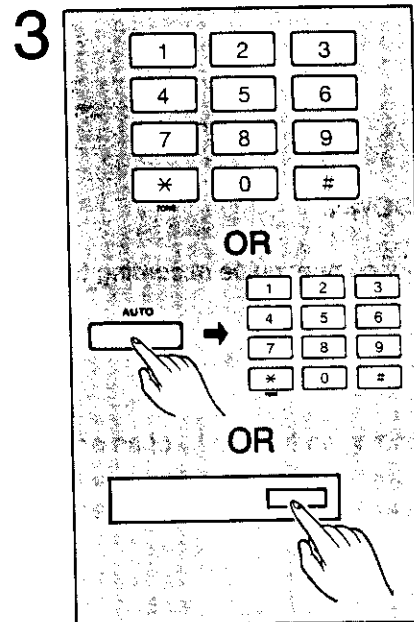

Dial the phone number.

OR

Press the **AUTO** button, then press the desired station number ("00" through "19") by using the dial keypad.

For programming of phone numbers, see page 1-21.

OR

Press the direct call station.

For programming of phone numbers, see page 1-20.

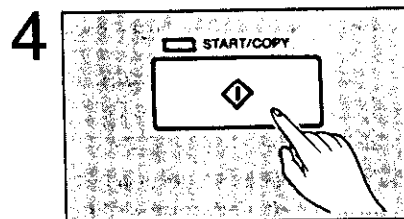

Press the **START/COPY** button when a fax tone is heard.

The unit feeds and transmits the documents.
After pressing the **START/COPY** button, replace the handset if using it.

To stop transmission:

Press the **STOP/CLEAR** button until a beep sounds. The transmission is interrupted.

To eject the documents, press the **STOP/CLEAR** button again.

One touch transmission

You can dial and transmit documents automatically using direct call station keys. Before using these features, make sure that the desired telephone numbers have been stored in direct call stations.

For programming of phone numbers, see page 1-20.

1

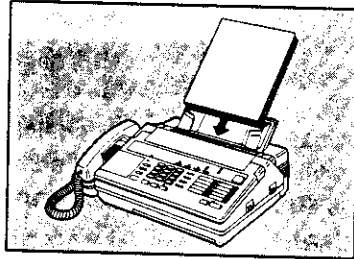

Insert the documents **FACE DOWN**.

The unit can accept up to 10 sheets of paper at a time.

2

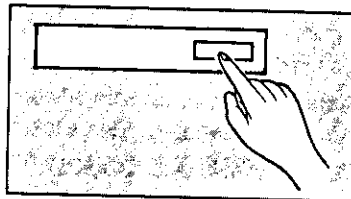

Press the desired direct call station key.

The unit dials and transmits the documents automatically.

If there is no answer or the line is busy, the unit will automatically redial the number up to 3 times (Automatic redialing function).

To cancel automatic redialing, press the **STOP/CLEAR** button.

Adding extra pages

If you want to send 11 or more sheets at a time, insert the documents up to 10 sheets of paper first, and add the extra pages up to 10 sheets before the last page feeds into the unit.

Transmitting documents using the REDIAL button

You can transmit documents to the last dialed number using the REDIAL button.

1

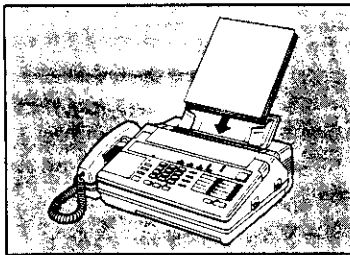

Insert the documents **FACE DOWN**.

The unit can accept up to 10 sheets of paper at a time.

2

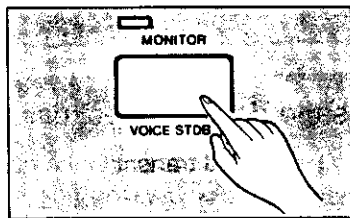

Press the **MONITOR** button or lift the handset.

3

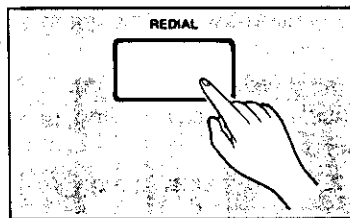

Press the **REDIAL** button.

The unit dials the last dialed number.

4

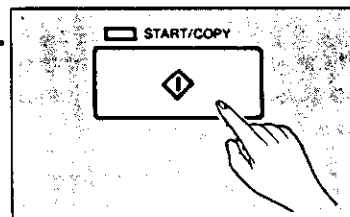

Press the **START/COPY** button when a fax tone is heard.

The unit feeds and transmits the documents.
Replace the handset if using it.

To stop transmission:

Press the **STOP/CLEAR** button until a beep sounds. The transmission is interrupted.

To eject the documents, press the **STOP/CLEAR** button again.

Receiving Documents and/or Voice-Messages

Receiving mode

The unit can receive documents and/or voice-messages either automatically or manually.

The unit has three types of receiving mode. To select the desired receiving mode, press the RECEIVE MODE button. Each time you press the RECEIVE MODE button, one of the receiving modes will be selected.

■ TAD/FAX mode

Select this mode when you use the unit as a telephone answering device and/or a facsimile machine. The TAD/FAX indicator lights.

When the unit is in the TAD/FAX mode, incoming calls are automatically routed either to the fax or to the telephone answering device.

When a call is received, the unit answers the call and begins playing your OGM to the calling party automatically. The unit automatically distinguishes between voice and fax calls, and then functions as an answering device and/or a facsimile.

If a fax tone is heard when the call is answered, it will switch automatically to the fax mode. If the caller's voice is heard within 5 seconds of the end of the OGM, the unit functions as an answering device.

■ FAX mode

Select this mode when you use the unit only as a facsimile machine. The FAX indicator lights.

When a call is received, the unit answers the call and produces a fax tone for documents reception. Then the unit receives documents automatically. Your OGM is not played back.

If someone calls you when your unit is in the FAX mode, he/she will hear the fax tone and cannot talk to you.

■ TEL (Telephone) mode

Select this mode when you use the unit as a telephone or for manual fax reception. The TEL indicator lights.

In this mode, if you do not answer the call until the unit rings 15 times, the unit will automatically switch to the TAD/FAX mode.

HELPFUL HINTS:

- **If a caller wishes to transmit a document after recording a voice-message:**
Advise the caller to "Press the asterisk (*) button to send a document after recording your voice-message".
- **If a caller wishes to record a voice-message after sending a document:**
Advise the caller to "Make a call reservation following a voice contact procedure on your facsimile during transmission". The unit will start playing the OGM again, then be able to record a voice-message.

Manual reception

1

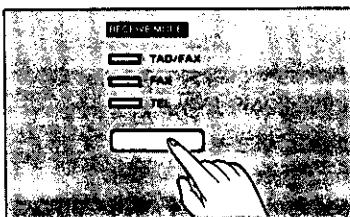

Press the **RECEIVE MODE** button to set to the TEL mode.

2



When the phone rings, lift the handset to answer the call.

3

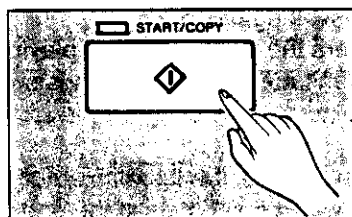

Press the **START/COPY** button to receive documents, and then place the handset on the cradle.

If you do not place the handset on the cradle after pressing the **START/COPY** button, the unit automatically calls the other party. For further details, see "Voice Contact" on page 2-8.

Note:

- When the red lines appear on both sides of the recording paper or the PAPER OUT indicator lights, replace the paper roll with a new one. The unit cannot receive a document without recording paper. To install recording paper, see page 1-9.
- If the ALARM indicator lights when you close the cover after installing the paper, open the cover and close it firmly again.

Voice Contact

Initiating voice contact

While you are transmitting or receiving a document, you may wish to speak to the other party. If the other party's unit is equipped with a voice contact feature, you can initiate voice contact and notify the other party that you wish to speak after the transmission/reception is completed. This saves the extra expense and time of making a subsequent telephone call to discuss information sent over the fax.

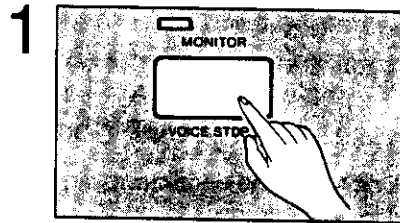

Press the **MONITOR** button or lift the handset while transmitting or receiving the documents.



When the other party answers, start speaking using the handset.

If you initiate voice contact while transmitting documents, you can speak after all the documents have been transmitted.

If you initiate voice contact while receiving documents, you can speak after receiving the current page of the documents.

Receiving a request for voice contact

If the other party initiates voice contact during transmission or reception, your unit will beep after the fax is completed.



When the beep sounds, lift the handset and start speaking.

Note:

If you do not answer within 10 seconds after hearing several beeps indicating the request for voice contact, one of the following occurs:

- When you have set the unit to the TAD/FAX mode, the unit plays back your OGM and records the voice-message on the tape.
- When you have set the unit to the FAX mode, the line is disconnected.
- When you have set the unit to the TEL mode, the line is disconnected.

Making Copies

This unit can make a copy. Any transmissible documents can be copied. The unit automatically selects the FINE resolution when copying.

1

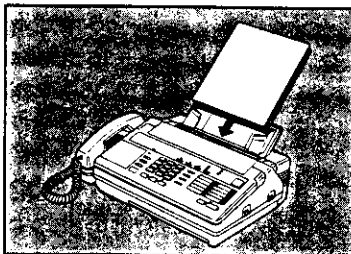

Insert the documents **FACE DOWN**.

The unit can accept up to 10 sheets of paper at a time.

2

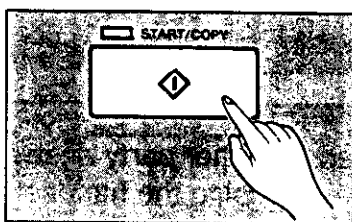

Press the **START/COPY** button.

The unit feeds the documents and starts copying.

To stop copying:

Press the **STOP/CLEAR** button until a beep sounds.

To eject the document, press the **STOP/CLEAR** button again.

Operating as an Answering Device

The unit also works as an automatic telephone answering and recording system in the TAD/FAX mode. The following functions are available as an answering device.

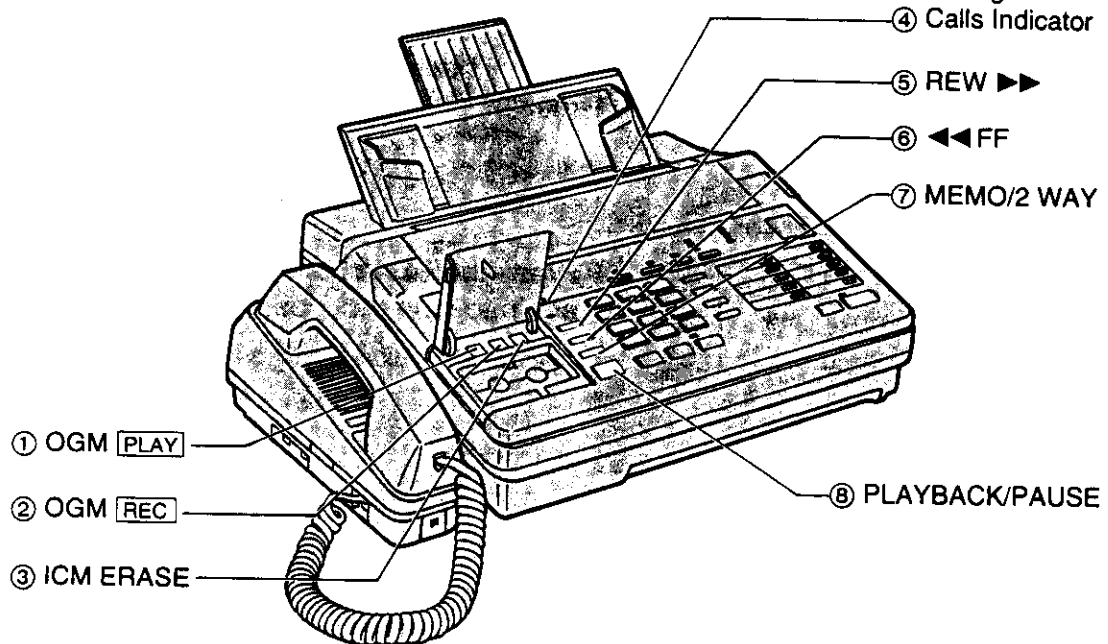

① Verifying your OGM:

See page 1-14.

② Recording your OGM:

See page 1-13.

③ Erasing recorded messages:

After reviewing your messages, press the ICM ERASE button.

The messages are erased while the tape is rewinding.

The tape can be erased at high speed even if the record-prevention (knock-out) tabs have been removed.

④ Calls indicator:

The indicator flashes to show the number of incoming messages recorded up to 15 times. Even if 16 or more calls are recorded, the indicator will flash up to 15 times.

⑤ Rewinding (Resetting) the tape quickly:

Press the REW (Rewind) button.

⑥ Forwarding the tape quickly:

Press the FF (Fast Forward) button.

⑦ Recording a memo message:

See page 2-12.

Recording a 2-way conversation:

See page 2-13.

⑧ Playing back recorded voice-messages:

Press the PLAYBACK/PAUSE button.

One-touch operation:

The unit plays all the recorded messages when the PLAYBACK/PAUSE button is pressed. At the end of the last message the tape stops, and 3 beeps are heard. After 7 seconds, the unit resets itself to the TAD/FAX mode. All calls are saved automatically.

Stopping the tape (pause mode):

Press the PLAYBACK/PAUSE button during playback mode.

The tape pauses until you restart it by pressing the PLAYBACK/PAUSE button. The unit does not answer calls automatically while in the pause mode.

Recording after the messages you want to save

New incoming messages will automatically be stored after the last message. If you want a new incoming message to be stored after the messages you want to save, perform the following steps.

1

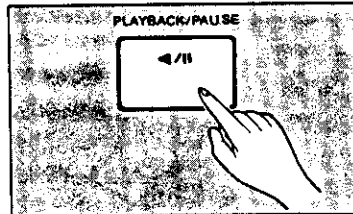

Press the **PLAYBACK/PAUSE** button to play back the tape to the end of the messages you want to save.

2

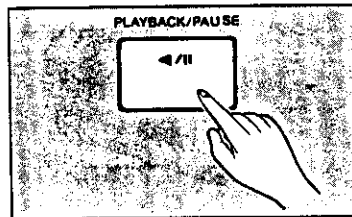

Press the **PLAYBACK/PAUSE** button again to stop the tape.

The IN USE indicator flashes.

3

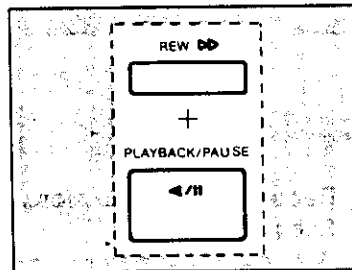

Press the **REW** and **PLAYBACK/PAUSE** buttons together.

New calls will be recorded after the messages you have saved.

Note:

You can choose between two types of recording time of incoming messages. When the unit is in the "VOX" position, the recording time is unlimited, and when in the "1 MIN" position, the recording time is limited to 1 minute. The unit is preprogrammed to the "VOX" position. To change the recording time, see page 4-5.

Recording a memo message

If you are going out and you want to leave a private message for someone, you can record a voice memo in the unit. This can then be played back either directly or remotely, exactly like any other incoming messages.

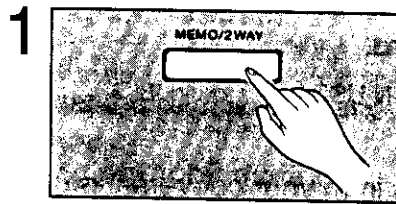

Press the **MEMO/2WAY** button until a beep is heard.

The IN USE indicator lights.

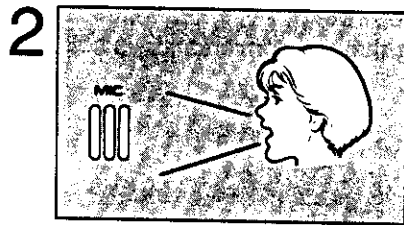

Speak toward the microphone from approximately 20 cm (8 inches) away.

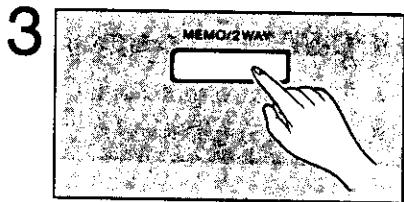

When the recording is finished, press the **MEMO/2WAY** button again.

The IN USE indicator goes out.

Recording a 2-way conversation

While speaking with someone on the telephone, you can record your conversation.

1

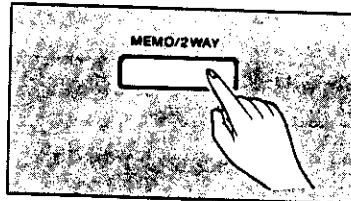

During your conversation, press the **MEMO/2WAY** button until a beep is heard.

The IN USE indicator lights.

2



Continue your conversation.

A beep sounds every 15 seconds to notify the caller that the conversation is being recorded.

3

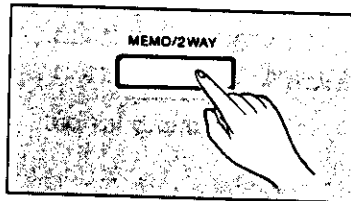

To stop recording, press the **MEMO/2WAY** button again.

The IN USE indicator goes out.

Monitoring incoming calls

While an incoming message is being recorded, you can monitor it through the built-in speaker. Adjust the sound level using the VOLUME control.

You can talk to the caller directly by simply lifting the handset. The unit stops recording automatically.

Making and Answering Voice Calls

Making voice calls

Using the handset:

- 1 Lift the handset.
- 2 Dial the phone number.

Using on-hook dialing:

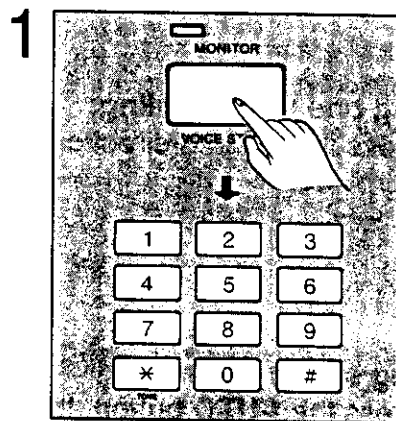

Press the **MONITOR** button, then dial the phone number.

The **MONITOR** indicator lights, and you will hear the number being dialed, the called line ringing and connection being made.

2

When the other party answers your call, lift the handset and talk with it.

Redialing (Repeat call attempt)

If the line is busy or you wish to redial the last dialed number, you can redial by simply pressing the **REDIAL** button.

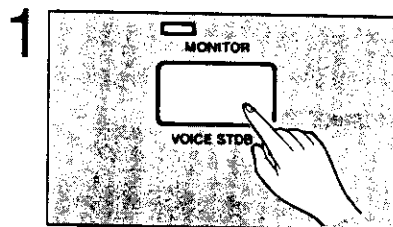

Press the **MONITOR** button or lift the handset.

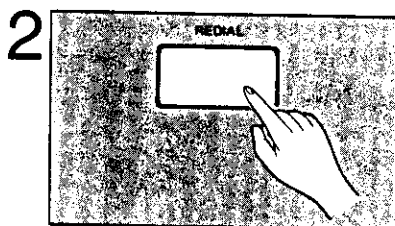

Press the **REDIAL** button.

The unit dials the last dialed number once.

Making voice calls using the automatic dialing

The unit's memory allows you to use both one touch dialing (up to 10 phone numbers) and speed dialing (up to 20 phone numbers) for rapid access to your most frequently called numbers.

Before using these features, make sure that the desired telephone numbers have been stored in memory. See pages 1-20 to 1-23.

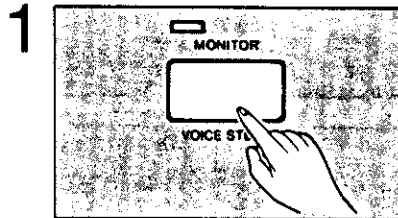

Press the **MONITOR** button or lift the handset.

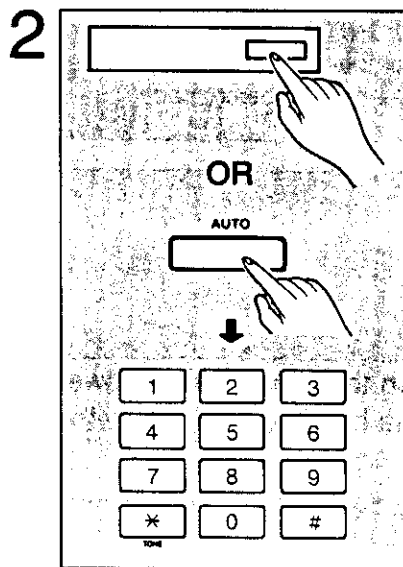

Using one touch dialing:
Press the desired direct call station key.

OR

Using speed dialing:
Press the **AUTO** button, then press the desired station number ("00" through "19") by using the dial keypad.

Answering voice calls

When the phone rings, lift the handset to answer the call.

Advanced Instructions

Polling

Polling means that a facsimile machine "retrieves" a document loaded on the other machine (we call it "polled machine") so that the telephone fee is charged to the receiving unit, not the transmitting one.

This unit can only receive polled documents; it cannot be "polled".

To activate the polling, the other machine must be prepared for your call.

Setting the polling password

If the document to be retrieved is of a confidential nature and the password is set on the other machine to prevent unauthorized retrieving, you must set the same password on your unit.

The polling using a password is effective only between Panasonic compatible facsimile machines (e.g. KX-F95, KX-F110, etc.).

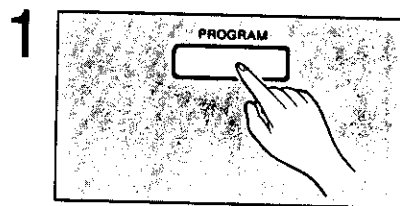

Press the **PROGRAM** button.

The PROGRAM indicator lights.

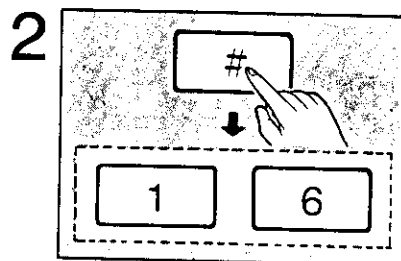

Press "#", then press "16" for the polling password setting.

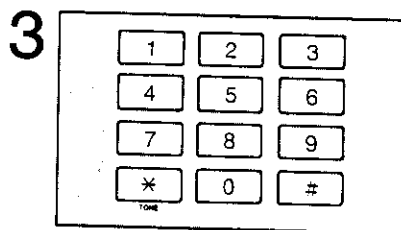

Enter the same polling password of 4 digits using the dial keypad.

The polling password is set to "0000" as the default. Set the same password as the polled machine.

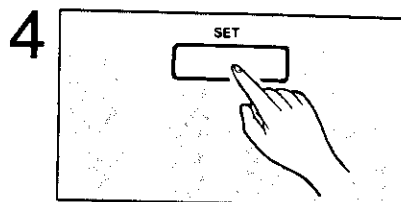

Press the **SET** button to store the programming in memory.

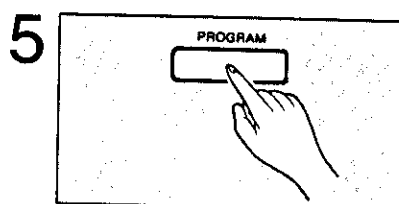

Press the **PROGRAM** button to end the operation.

The PROGRAM indicator goes out.

Note: To correct an error while programming, press the STOP/CLEAR button then repeat from step 2.

Polling another facsimile

The following procedure lets you poll another station.
Make sure that documents are loaded on the polled machine.

1

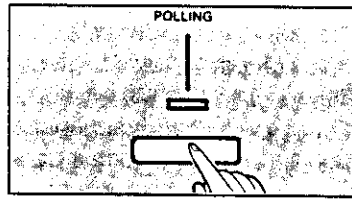

Press the **POLLING** button.

The POLLING indicator lights.

2

Using one touch dialing:

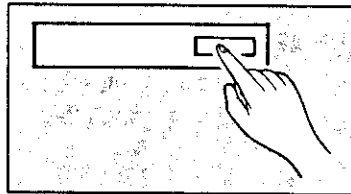

Press the desired direct call station key.

The unit will dial and receive documents.
When reception ends, the POLLING indicator goes out.

Using speed dialing or manual dialing:

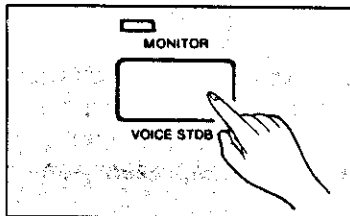

Press the **MONITOR** button.

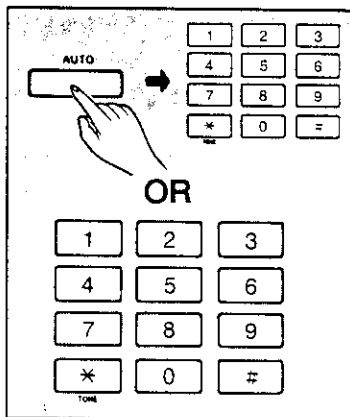

Press the **AUTO** button and the desired station number ("00" through "19") for speed dialing.

OR

Dial the phone number for manual dialing.

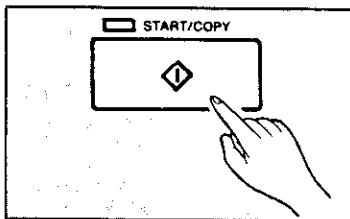

Press the **START/COPY** button.

The unit will dial and receive documents.
When reception ends, the POLLING indicator goes out.

Note: The unit automatically redials up to 3 times if the polled station is busy or there is no answer when you use one touch dialing.

Setting the Main Password

The password communication means that only the machines which have the same password can transmit/receive confidential documents. If the main password of 4 digits is set on your unit, you can participate in the password communication among Panasonic compatible facsimile machines (e.g. KX-F95, KX-F110, etc.).

Note: The password for the polling function is not related to this password communication. They are independent functions.

1

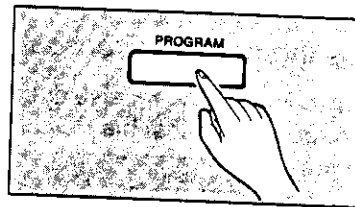

Press the **PROGRAM** button.
The PROGRAM indicator lights.

2

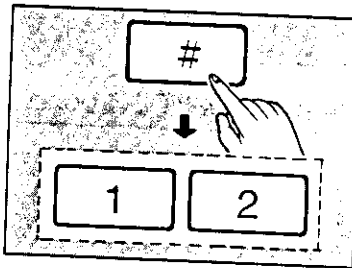

Press "#", then press "12" for the main password setting.

3

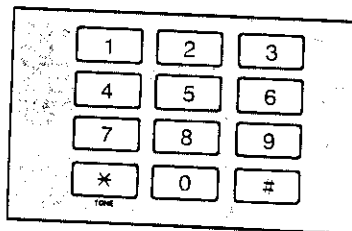

Enter the same main password of 4 digits using the dial keypad.
The main password is set to "0000" as the default. Set the same password as other stations.

4

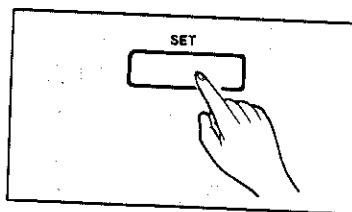

Press the **SET** button to store the programming in memory.

5

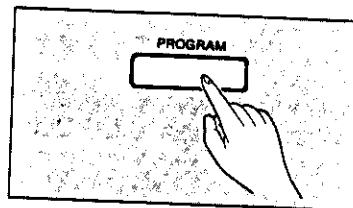

Press the **PROGRAM** button to end the operation.
The PROGRAM indicator goes out.

Note: To correct an error while programming, press the STOP/CLEAR button then repeat from step 2.

Operating as an Answering Device from a Remote Phone

You can retrieve the incoming messages and re-record your outgoing message from a remote location with a touch tone telephone.

The following features are available on this unit.

- Message playback
- Newly recorded message playback (Memory Playback)
- Back space and skip forward
- Recording a marker message
- Resetting the tape for future messages
- Re-recording the OGM (outgoing message)
- Skipping the OGM for ICM (incoming message) recording

These operations are available only in TAD/FAX mode. If your unit is in the TEL mode, call your unit and wait for 15 rings. The unit will switch to the TAD/FAX mode.

Toll saver

When you call the unit from a remote location, the number of rings tells you if there are any new voice-messages.

If the unit answers on the 2nd ring, there is at least one new message recorded.

If the unit answers on the 4th ring, there are no new messages recorded.

Hang up immediately when you hear the 3rd ring. The 3rd ring indicates that there are no new messages. This will save you the toll charge for the call.

The toll saver works only when TAD RING COUNT is set to the Toll Saver position. See page 4-6.

Summary of remote control functions

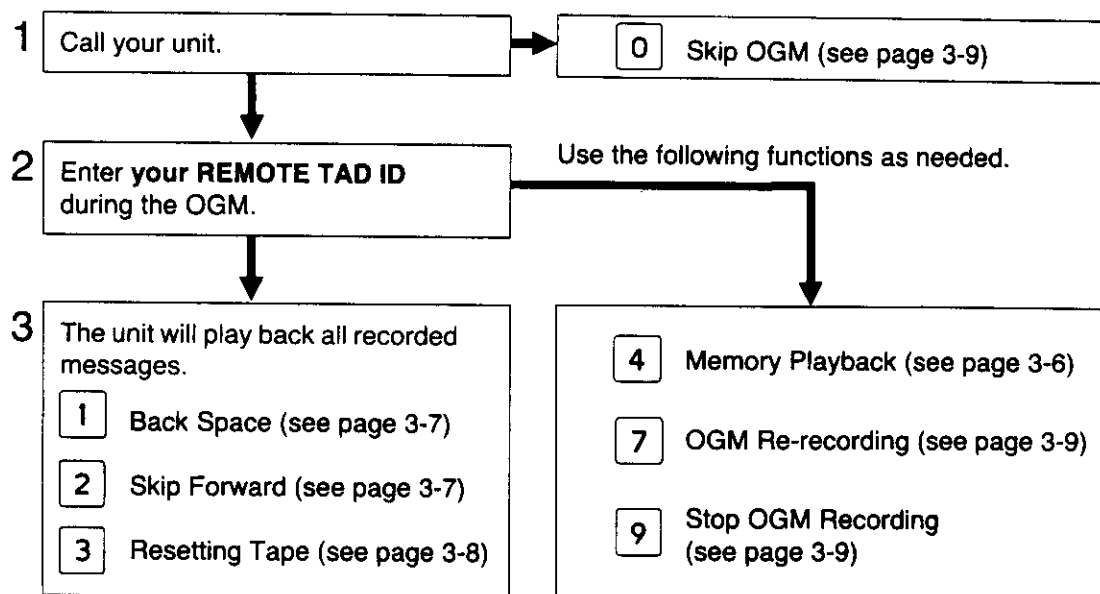

Note: For your convenience, the quick reference card for remote operation is attached in these operating instructions. See pages 4-14 and 4-15.

Programming a REMOTE TAD ID number for remote operation

The REMOTE TAD ID number prevents unauthorized persons from accessing your unit and listening to your messages. The REMOTE TAD ID is preset to 111. If you wish to change the number, you can choose any number from "1" to "999" except numbers including "0" or "7".

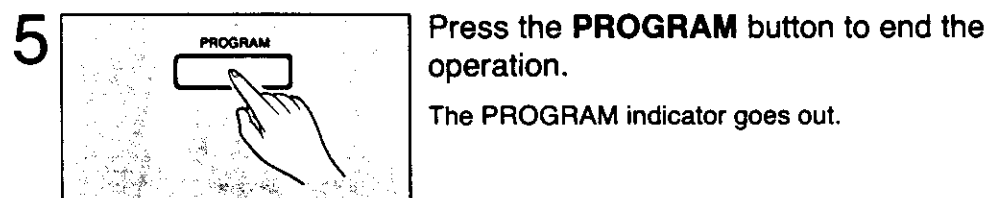
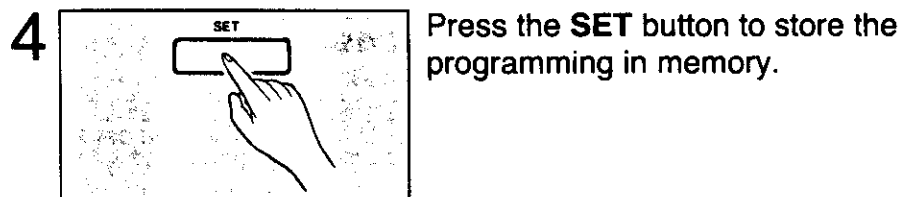
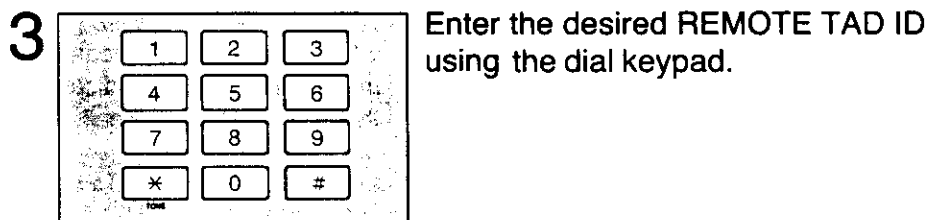
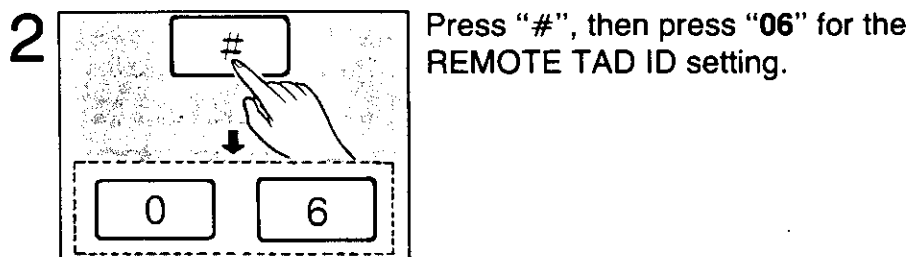
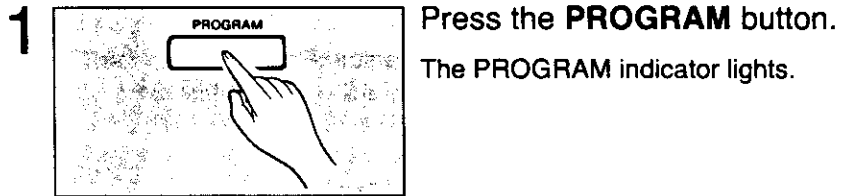

Note: You should not use codes which contain zero (0) since this causes the unit to skip the OGM. (For example, 200, 502, 70 etc.)
We recommend that you do not use seven (7) as a code number, since this number is used as the OGM rerecording command for remote operations. Otherwise the answering features may not operate properly.

Message playback

You can listen to the recorded messages from a remote location.

1

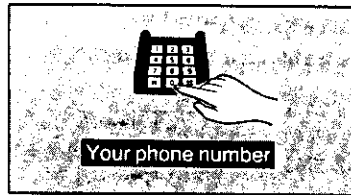

Call your unit.

2

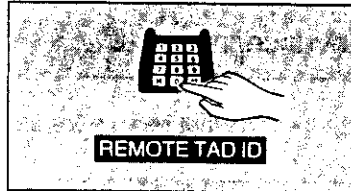

Dial your REMOTE TAD ID while the OGM is playing.

A long beep and a short beep(s) will sound. Short beep(s) indicate(s) the number of recorded message(s) up to 8 times. Even if 9 or more calls are recorded, a short beep sounds up to 8 times.

3

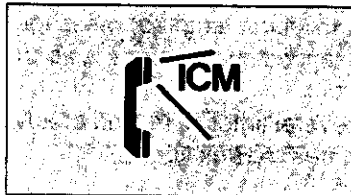

The unit rewinds the tape and plays back the message(s) recorded.

3 beeps will be heard indicating the end of the messages. After hanging up, all the recorded messages are saved and the unit is ready to record further messages.

Newly recorded messages playback (Memory Playback)

It is possible to skip over the recorded messages you have already heard and to play back only new messages.

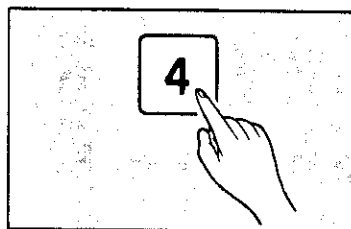

Press "4" immediately after hearing the beeps that indicate the number of recorded messages.

The unit plays back the new messages. Even during the playback of previously heard messages, you can skip to the new messages by pressing "4".

Back space and skip forward

While listening to the recorded messages, you can rewind or advance the tape.

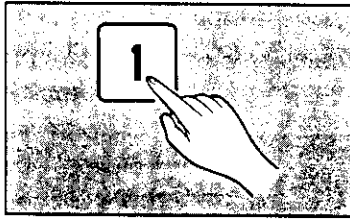

To rewind, press "1".

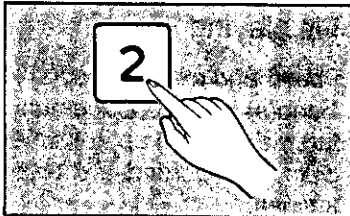

To advance, press "2".

Note:

The maximum length of message to be rewound or advanced by one press is approximately 15 seconds. So you may have to press "1" or "2" several times to rewind or advance the tape to the desired position.

Recording a marker message

After playing back the recorded messages, you can record your new message on the same call.

When replay is finished, wait for 3 beeps indicating the end of the last message. Then wait about 10 seconds for another 2 beeps indicating that the tape is ready for recording.

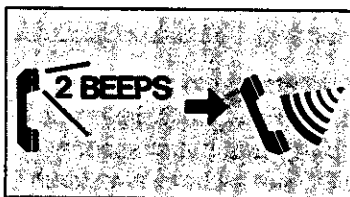
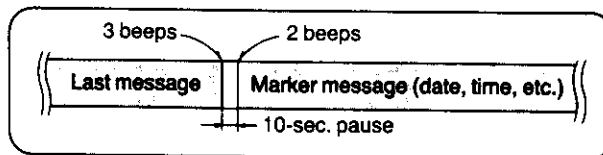

Leave your message after the last 2 beeps.

Hang up when finished. The marker message is recorded after the last message on the tape.

Resetting the tape for future messages

After listening to the recorded messages, you can reset the tape and record future messages from the beginning of the tape.

After all the messages have been played back or even while they are being played;

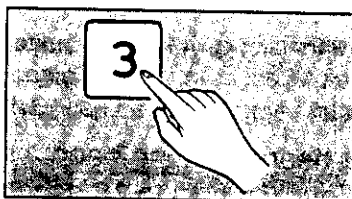

Press "3", then hang up.

The unit rewinds the tape to the beginning. Future messages will be recorded and the previously recorded messages are lost.

If you have used Memory Playback;

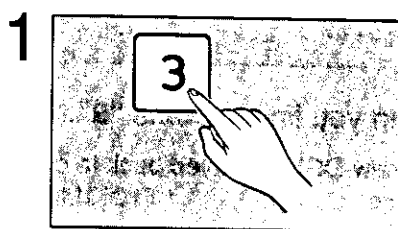

Press "3".

The unit rewinds the tape to the beginning of the newly recorded messages, then beeps.

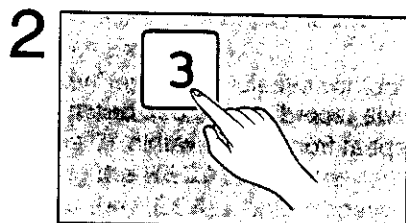

Press "3" again after hearing the beep.

The unit rewinds the tape to the beginning of the previously recorded messages.

If you have reset the tape by mistake;

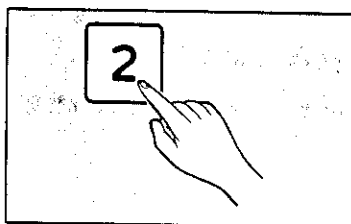

Press "2" after the tape has been reset.

One beep sounds.
The unit advances the tape to the end of the recorded messages.

Re-recording an outgoing message

You can change the content of your OGM from a remote telephone.

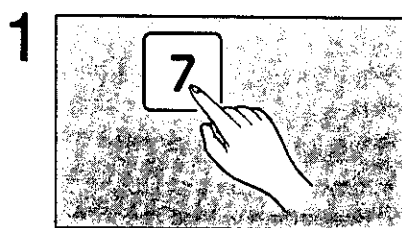

Press "7" to start re-recording after hearing the beeps that indicate the number of recorded messages.

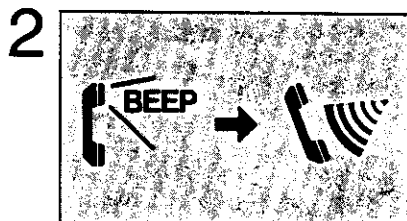

After hearing a long beep, speak clearly and loudly for up to 16 seconds.

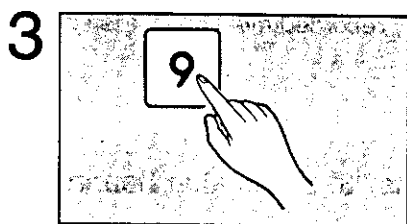

When you finish, press "9".

The new OGM is played back to confirm the change.

Note: If you pause for over 2 seconds while recording, the unit beeps and stops the OGM recording. In such a case, repeat from step 1 within 10 seconds.

Skipping the OGM for ICM recording

You can leave a message on your unit without listening to your OGM.

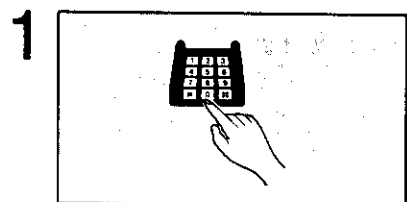

Call your unit.

You need not enter your REMOTE TAD ID.

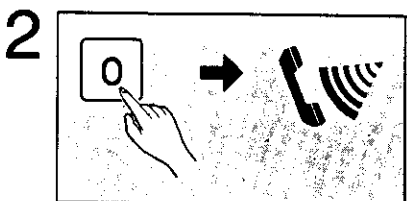

Press "0" while the OGM is playing.

After hearing a long beep, speak clearly and loudly to leave your message.

Other Features

TONE button (Temporary tone dialing)

This function is useful only if your line has rotary pulse dial service. Pressing the TONE (*) button will allow you to change from pulse to tone mode during a dialing operation, and enter special tones and codes to operate your answering machine, electronic banking services and other special services.

"TONE" can be programmed into memory with the telephone numbers.

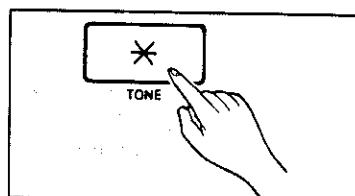

Press the **TONE (*)** button.

When you hang up, the unit automatically returns to pulse mode.

- "TONE" can be stored in memory in the same way as explained on pages 1-20 to 1-23.
- Pressing the TONE button counts as 1 digit while programming.

RECALL button

The RECALL button is used to access some of the features of your host PBX (Private Branch Exchange).

For further details, please contact your local telephone company for information about the availability of these services in your area.

Using the RECALL button

Press the RECALL button briefly when required.

- "RECALL" can be stored into memory in the same way as explained on pages 1-20 to 1-23.
- Pressing the RECALL button counts as 1 digit while programming.

PAUSE button

The PAUSE button is used in a dial sequence to access an outside line. Pressing the PAUSE button makes a dialing delay.

Using the PAUSE button

Example: Line access number 9

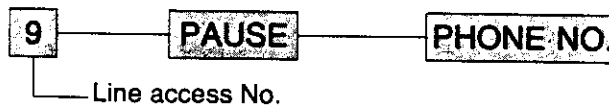

- "PAUSE" can be stored in memory in the same way as explained on pages 1-20 to 1-23.
- Pressing the PAUSE button counts as 1 digit while programming.

Combination dialing

The following combination of dialing methods can be used.

- Manual dialing and automatic dialing
- Pulse and Tone dialing
- Plural memory stations

General Information

Printing Reports and Lists

Individual Transmission Report (TX REPORT)

One of the following choices is available:

ON mode: The report is always printed to let you know if the transmission is successful or not.

ERROR mode: The report is printed only when a transmission error occurs.

OFF mode: The report is not printed whether the transmission is successful or not. (Default)

```
-----  
<< TX REPORT >>  
OTHER FACSIMILE = PANASONIC  
PAGES = 00 RESULT = NG( 03 )  
-----
```

■ Transmission error codes

Code	Description
OK	Successful transmission
NG (02)	The STOP/CLEAR button was pressed to interrupt the operation.
NG (03)	Document jammed or not fed into the unit properly. Check the paper path and try again.
NG (04)	Transmission error. Try again.

■ Setting PRINT TX REPORT mode

- 1 Press the **PROGRAM** button. The PROGRAM indicator lights.
- 2 Press "#", then press "11" for the transmission report mode setting.
- 3 Press "1", "2" or "3", then press the **SET** button to store your selection in memory. Selection is as follows:
Press "1" to set to ON mode.
Press "2" to set to ERROR mode.
Press "3" to set to OFF mode.
- 4 Press the **PROGRAM** button to end the operation. The PROGRAM indicator goes out.

List of stored phone numbers (TELEPHONE NUMBER LIST)

You can print a list of the numbers programmed for one touch dialing and speed dialing. Use this function to confirm that you have correctly stored phone numbers.

```

***** TELEPHONE NUMBER LIST *****
*
*                               << STATION KEY LIST >>                               *
*   PHONE NUMBER                                     PHONE NUMBER                       *
*-----*-----*
* 01 T123-4567                                       06 T012-2345-6789                       *
* 02 R345-6789                                       07 R123-[ ]                             *
* 03 T[ ]                                           08                                           *
* 04 R[ ]                                           09 SECRET NUMBER                       *
* 05                                           10                                           *
*
*                               << AUTO KEY LIST >>                               *
*   PHONE NUMBER                                     PHONE NUMBER                       *
*-----*-----*
* 00 T233-5555                                       10 R111-222-3333                       *
* 01 T456-P753-7568                                   11 R123-F465-7890                       *
* 02 T[ ]                                           12 R[ ]                                 *
* 03                                           13                                           *
* 04                                           14                                           *
* 05                                           15                                           *
* 06                                           16                                           *
* 07 T456-[ ]                                       17                                           *
* 08                                           18                                           *
* 09                                           19                                           *
*
*****

```

■ Codes in each phone number

- T: Shows that you have entered the telephone number in the TONE dialing mode.
- R: Shows that you have entered the telephone number in the PULSE (rotary) dialing mode.
- P: Shows that you have entered PAUSE.
- F: Shows that you have entered RECALL.

■ Printing the TELEPHONE NUMBER LIST

- 1 Press the **PROGRAM** button.
The PROGRAM indicator lights.
- 2 Press "#", then press "41" for the PRINT TEL LIST setting.
- 3 Press the **START/COPY** button.
The unit begins printing the list.
- 4 Press the **PROGRAM** button to end the operation.
The PROGRAM indicator goes out.

System Programming Functions

FAX LOGO HEADING

The FAX LOGO HEADING setting

ON: Your logo and telephone number are printed on the transmitted document. (Default)

OFF: Your logo and telephone number are not printed.

Operation:

- 1 Press the **PROGRAM** button.
The PROGRAM indicator lights.
- 2 Press "#", then press "05" for the FAX LOGO HEADING setting.
- 3 Press "1" or "2".
(1=ON, 2=OFF)
- 4 Press the **SET** button to store your selection in memory.
- 5 Press the **PROGRAM** button to end the operation.
The PROGRAM indicator goes out.

FAX TX SPEED

The FAX TRANSMISSION SPEED setting

The unit can automatically select the optimum transmitting speed depending on the line condition and the type of the other facsimile unit.

9600 BPS: Maximum speed of 9600 bits per second. (Default)

4800 BPS: Maximum speed of 4800 bits per second. If you frequently experience problems such as transmission errors caused by poor line condition, set to "4800 BPS".

Operation:

- 1 Press the **PROGRAM** button.
The PROGRAM indicator lights.
- 2 Press "#", then press "17" for the FAX TX SPEED setting.
- 3 Press "1" or "2".
(1=9600 BPS, 2=4800 BPS)
- 4 Press the **SET** button to store your selection in memory.
- 5 Press the **PROGRAM** button to end the operation.
The PROGRAM indicator goes out.

FAX RX SPEED

The FAX RECEPTION SPEED setting

The unit can automatically select the optimum receiving speed depending on the line condition and the type of the other facsimile unit.

9600 BPS: Maximum speed of 9600 bits per second. (Default).

4800 BPS: Maximum speed of 4800 bits per second. If you frequently experience problems such as reception errors caused by poor line condition, set to "4800 BPS".

Operation:

- 1 Press the **PROGRAM** button.
The PROGRAM indicator lights.
- 2 Press "#", then press "18" for the FAX RX SPEED setting.
- 3 Press "1" or "2".
(1=9600 BPS, 2=4800 BPS)
- 4 Press the **SET** button to store your selection in memory.
- 5 Press the **PROGRAM** button to end the operation.
The PROGRAM indicator goes out.

TONE DETECT

The TONE DETECT setting

The unit automatically disconnects the line when it detects a busy tone after dialing in on-hook dialing mode.

OFF: The unit does not detect a busy tone. (Default)

ON: The unit detects a busy tone.

Operation:

- 1 Press the **PROGRAM** button.
The PROGRAM indicator lights.
- 2 Press "#", then press "20" for the TONE DETECT setting.
- 3 Press "1" or "2".
(1=ON, 2=OFF)
- 4 Press the **SET** button to store your selection in memory.
- 5 Press the **PROGRAM** button to end the operation.
The PROGRAM indicator goes out.

RECALL

The RECALL (T-BR/E-RE) setting

Select T-BR or E-RE depending on your host PBX.

T-BR: For PBX using timed break register recall facility. (Default)

E-RE: For PBX using earth recall facility.

Operation:

- 1 Press the **PROGRAM** button.
The PROGRAM indicator lights.
- 2 Press "#", then press "21" for the RECALL setting.
- 3 Press "1" or "2".
(1=T-BR, 2=E-RE)
- 4 Press the **SET** button to store your selection in memory.
- 5 Press the **PROGRAM** button to end the operation.
The PROGRAM indicator goes out.

RECORDING TIME

The RECORDING TIME setting

The recording time for incoming messages can be set to VOX (unlimited) or 1 MIN.

VOX: The unit records an ICM as long as a caller speaks. (Default)

1 MIN: The unit records an ICM up to 1 minute per message.

Operation:

- 1 Press the **PROGRAM** button.
The PROGRAM indicator lights.
- 2 Press "#", then press "30" for the RECORDING TIME setting.
- 3 Press "1" or "2".
(1=VOX, 2=1 MIN)
- 4 Press the **SET** button to store your selection in memory.
- 5 Press the **PROGRAM** button to end the operation.
The PROGRAM indicator goes out.

CPC MODE

The CPC (Calling Party Control) mode setting

Select the CPC mode "A" or "B" depending on your line condition.

- A: Set to this mode if your line does not have special telephone services.
(Default)
- B: Set to this mode if your line has special telephone services such as call waiting and call forwarding. If some incoming messages are cut off in mode "A", set the mode to "B".

Operation:

- 1 Press the **PROGRAM** button.
The PROGRAM indicator lights.
- 2 Press "#", then press "31" for the CPC MODE setting.
- 3 Press "1" or "2".
(1=A, 2=B)
- 4 Press the **SET** button to store your selection in memory.
- 5 Press the **PROGRAM** button to end the operation.
The PROGRAM indicator goes out.

TAD RING COUNT

The TAD RING COUNT setting

This function is available only in the TAD/FAX mode when receiving a call.

If you find there is difficulty in receiving from machines that have an automatic transmission feature, set the TAD RING COUNT number to "2" (twice).

- 0: Toll Saver*
- 2: The unit answers on the 2nd ring.
(Default)
- 3: The unit answers on the 3rd ring.
- 4: The unit answers on the 4th ring.

Operation:

- 1 Press the **PROGRAM** button.
The PROGRAM indicator lights.
- 2 Press "#", then press "32" for the TAD RING COUNT setting.
- 3 Press "0", "2", "3" or "4".
(0=Toll Saver, 2=twice, 3=three times, 4=four times)
- 4 Press the **SET** button to store your selection in memory.
- 5 Press the **PROGRAM** button to end the operation.
The PROGRAM indicator goes out.

* Toll Saver function:

When you set the mode to "0", the number of rings tells you if there are any new voice-messages recorded.

If the unit answers on the 2nd ring, there is at least one new message.

If the unit answers on the 4th ring, there are no new messages.

Hang up immediately when you hear the 3rd ring. The 3rd ring indicates there are no new messages. This will save you toll charge for the call.

FAX RING COUNT

The FAX RING COUNT setting

This function is available only in the FAX mode when receiving a document.

If you find there is difficulty in receiving from machines that have an automatic transmission feature, set the FAX RING COUNT number to "2" (twice).

- 2: The unit answers on the 2nd ring.
(Default)
- 3: The unit answers on the 3rd ring.
- 4: The unit answers on the 4th ring.

Operation:

- 1 Press the **PROGRAM** button.
The PROGRAM indicator lights.
- 2 Press "#", then press "33" for the FAX RING COUNT setting.
- 3 Press "2", "3" or "4".
(2=twice, 3=three times,
4=four times)
- 4 Press the **SET** button to store your selection in memory.
- 5 Press the **PROGRAM** button to end the operation.
The PROGRAM indicator goes out.

PRINTER TEST

If you have difficulty with the print quality of your unit, check it using this feature.

Operation:

- 1 Press the **PROGRAM** button.
The PROGRAM indicator lights.
- 2 Press "#", then press "42".
- 3 Press the **START/COPY** button.
The unit prints the pattern as shown in Figure 1.
If the print pattern has any blurred points or lines or dirty pattern, consult with your service center.
- 4 Press the **PROGRAM** button to end the operation.
The PROGRAM indicator goes out.



Figure 1

PRINT CHARACTER CODE

You can print the character code list for fax logo setting.

Operation:

- 1 Press the **PROGRAM** button.
The PROGRAM indicator lights.
- 2 Press "#", then press "43".
- 3 Press the **START/COPY** button.
The unit starts printing.
- 4 Press the **PROGRAM** button to end the operation.
The PROGRAM indicator goes out.

RESET USER PROGRAMMABLE FUNCTIONS

This operation enables you to return the user programmable functions of 05 through 33 to their initial default settings. The function number 02 (YOUR LOGO setting) and 04 (YOUR TELEPHONE NUMBER setting) will not be erased.

Operation:

- 1 Press the **PROGRAM** button.
The PROGRAM indicator lights.
- 2 Press "#", then press "50".
- 3 Press the **START/COPY** button.
The following message is printed.

USER PROGRAMMABLE FUNCTIONS RESET OK? YES: PRESS "START/COPY" NO : PRESS "STOP/CLEAR"
--

- 4 Press the **START/COPY** button to return to initial settings.
The following message will be printed.

USER PROGRAMMABLE FUNCTIONS RESET COMPLETED!
--

OR

Press the **STOP/CLEAR** button to cancel.

- 5 Press the **PROGRAM** button to end the operation.
The PROGRAM indicator goes out.

Service Functions

The following service functions can be changed as the need arises. For further details, consult with your service center.

Example of service functions list (SERVICE DATA LIST):

```
***** SERVICE DATA LIST *****
*
* 01 PAUSE TIME      = 050*100ms[000...600]*100ms      *
* 03 DIAL SPEED     = 10pps      [1 = 10      2 = 20      ]pps      *
* 10 VOX TIME       = 6sec       [1 = 6        2 = 4        ]sec      *
* 11 VOX SENSE      = HI         [1 = HI       2 = LOW      ]         *
* 20 CED FREQ.      = 2100Hz     [1 = 2100   2 = 1100  ]Hz      *
* 21 INTL. MODE     = ON         [1 = ON     2 = OFF    ]         *
* 22 AUTO STANDBY   = ON         [1 = ON     2 = OFF    ]         *
* 23 RX EQL.        = 1.8Km      [1 = 0.0   2 = 1.8   3 = 3.6   4 = 7.2 ]Km      *
* 24 TX EQL.        = 1.8Km      [1 = 0.0   2 = 1.8   3 = 3.6   4 = 7.2 ]Km      *
*
* << SPECIAL SERVICE SETTINGS >>
*
* 52 53 59 63 70 71 72 73 74 80 81 82
* 2 3 1 15 2 00 030 15 2 1 2 1
*
*
* 83 84 86 87 90 91 92 93 94 95 96 97
* 170 1 1 1 1 02 065 2 0075 1 100 -15 2
*
*****
```

Printing the SERVICE DATA LIST

You can print a list of service functions (SERVICE DATA LIST).

Operation:

- 1 Press the **PROGRAM** button.
The PROGRAM indicator lights.
- 2 Press "#", "9", "0", "0", "0" and "*".
- 3 Press the **START/COPY** button to start printing.
- 4 Press the **PROGRAM** button to end the operation.
The PROGRAM indicator goes out.

Programming the service functions

- 1 Press the **PROGRAM** button.
The PROGRAM indicator lights.
- 2 Press the "#", "9", "0", "0", "0" and "*".
- 3 Enter the desired code number.
- 4 Press the desired value.
- 5 Press the **SET** button to store your selection in memory.
- 6 Press the **PROGRAM** button to end the operation.
The PROGRAM indicator goes out.

Maintenance

Be sure that the AC plug is disconnected from the outlet before performing any maintenance.

Cassette deck

Since the head and capstan assemblies are in contact with the tape, dirt and residue from the tape may easily adhere to these parts, causing distortion. Clean these parts periodically in the manner described below for the best sound quality.

Clean the head surfaces, pinch roller and capstan with a cotton swab. If these surfaces are extremely dirty, wipe them with a cotton swab dampened with alcohol, then wipe them with a dry soft cloth.

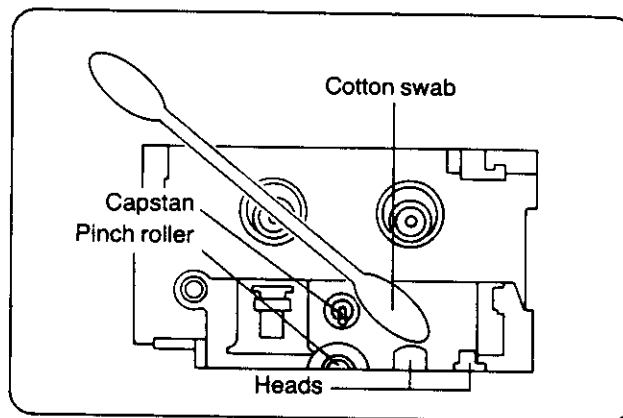

Note:

- Do not bring magnetic or metal objects, such as a screwdriver, near the head assembly, as such objects could magnetize the heads.
- Do not oil any part of the unit.

Facsimile machine

If a streak or a dirty pattern appears on a copied, transmitted or received document;

1. Clean the glass with a dry soft cloth.
2. Clean the paper rollers with a damp cloth then dry thoroughly to prevent the paper from jamming.

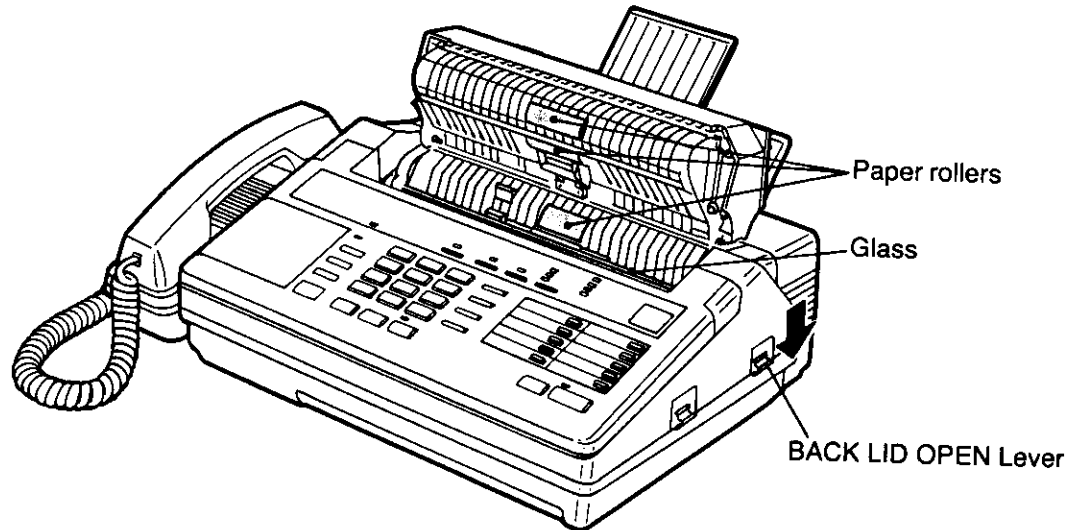

If you cannot get a clear copy after performing the above steps 1 and 2, clean the thermal head with a cloth moistened with denatured alcohol (alcohol without water), then dry thoroughly. To prevent malfunction due to static electricity, do not use a dry cloth and do not touch the thermal head with your finger directly.

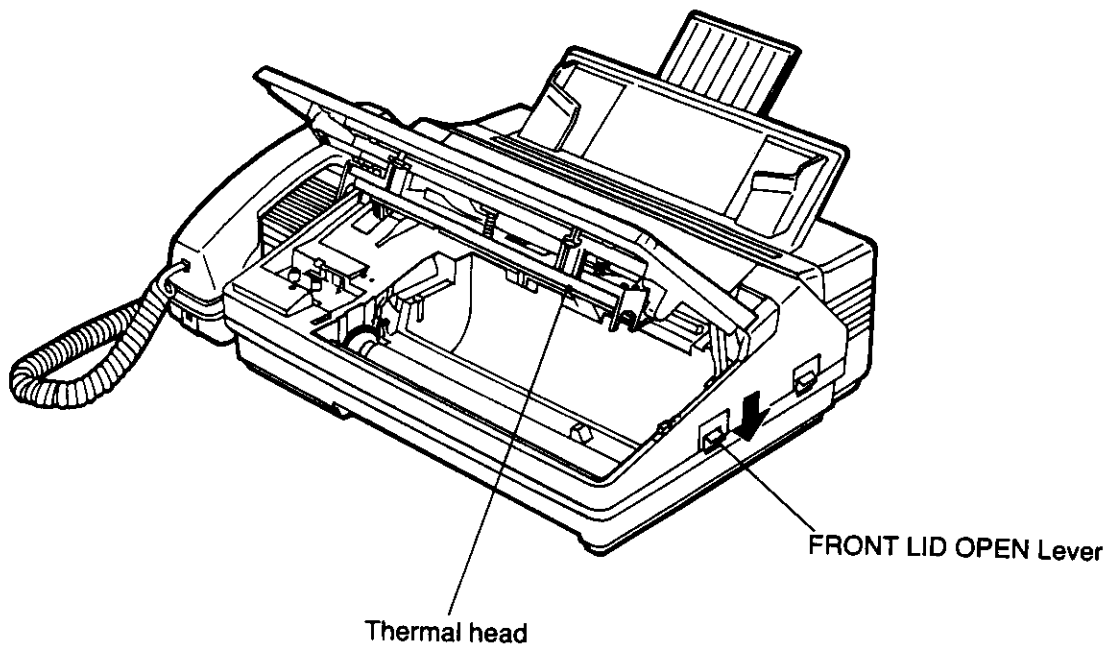

Troubleshooting Guide

Facsimile

PROBLEM	CAUSE & REMEDY
I cannot receive documents automatically.	<ul style="list-style-type: none">•Make sure recording paper is installed properly.•Make sure the RECEIVE MODE of the unit is set to TAD/FAX or FAX mode and not to TEL mode.•Shorten your OGM.•Set the vox sensitivity (VOX SENSE) to "LOW". See page 4-9.
Recording image is faint and I cannot read it well.	<ul style="list-style-type: none">•The sender transmitted a faint document. Request him to transmit a more clear document (e.g. copied one) again.
The other party complains that the letters on the document are distorted.	<ul style="list-style-type: none">•If your line has special telephone service such as call waiting, it may have been activated by another telephone call. Connect the unit to a line that does not have such service.•Be sure another telephone is not connected to the same line as your unit.
The START/COPY indicator flashes for about 40 seconds after the unit receives a call automatically, but nothing is recorded.	<ul style="list-style-type: none">•The caller hangs up during or immediately after playing back your OGM. This may occur if the disconnect signal is not transmitted from the central office.
When I receive or copy a document that has a dark background or contains photographs, the unit produces a high pitched noise.	<ul style="list-style-type: none">•This is quite normal.
The unit does not operate properly.	<ul style="list-style-type: none">•Turn the POWER switch off, then turn it on again.
Problems when receiving international facsimiles.	<ul style="list-style-type: none">•Shorten your OGM to 10 seconds or less.•FAX RX SPEED may need to be set to 4800 bps. See page 4-4.
The recording paper does not move during copying or receiving.	<ul style="list-style-type: none">•Make sure that the recording paper is correctly inserted between the upper guide plate and lower guide plate.•If the recording paper is wrapped around the roller, turn off the power and remove the paper. Cut off any part of the paper that is creased, and reinsert the paper between the guides.

Answering Device & Telephone

PROBLEM	CAUSE & REMEDY
The unit does not work when any button is pressed.	<ul style="list-style-type: none"> •Turn the POWER switch off, then turn it on again.
The unit has been set to the TAD/FAX mode, but no voice-messages have been recorded.	<ul style="list-style-type: none"> •The tape is not installed properly or is broken (cut, worn out or twisted). Install the tape or replace it with a new one.
When the tape is played, the sound level is low or nothing can be heard.	<ul style="list-style-type: none"> •Raise the sound level using the VOLUME control. •Clean the head of the cassette deck compartment. See page 4-10.
I have played back all the recorded messages and I want to record the next call after the last message.	<ul style="list-style-type: none"> •Leave the unit as it is after hearing the messages.
I cannot retrieve recorded messages from a remote phone.	<ul style="list-style-type: none"> •Make sure that you use your REMOTE TAD ID number correctly. •When you press your REMOTE TAD ID number, press the buttons firmly.
Some voice-messages have not been fully recorded.	<ul style="list-style-type: none"> •Set the calling party control (CPC) to "B". See page 4-6.
When a caller hangs up after leaving a message, the tape does not stop.	<ul style="list-style-type: none"> •VOX TIME should be set to 4 seconds. See page 4-9.
The unit does not ring.	<ul style="list-style-type: none"> •Set the RINGER volume selector to the HIGH or LOW position.

The ALARM Indicator

PROBLEM	CAUSE & REMEDY
The indicator flashes after transmission.	<ul style="list-style-type: none"> •A transmission error has occurred. Try again.
The indicator lights.	<ul style="list-style-type: none"> •Confirm that the covers of the unit are closed firmly. •Your OGM is not recorded. See page 1-13.
The indicator lights during transmission.	<ul style="list-style-type: none"> •A document more than 600 mm (23$\frac{5}{8}$") is being transmitted. •A document is jamming. Remove it. •Connect the unit to a line that does not have special telephone service such as call waiting.

SPEED DIALER LIST

CODE	NAME	CODE	NAME
00		10	
01		11	
02		12	
03		13	
04		14	
05		15	
06		16	
07		17	
08		18	
09		19	

Transmitting a document using the speed dialer:
 Insert the documents FACE DOWN, then press the AUTO button and the code number (00 through 19).

QUICK REFERENCE CARD

FOR TONE REMOTE CONTROL

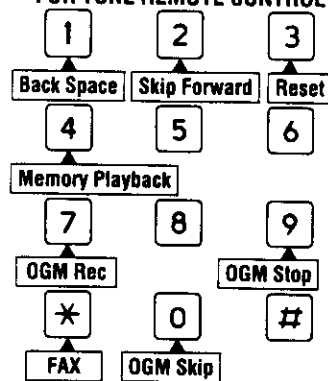

- To set the TAD/FAX mode, call your unit and wait for 15 rings. The unit will answer, then hang up.
- To send the document, press **#**. The "beep" (answering carrier tone) is heard. Then start transmission.

SPEED DIALER LIST

CODE	NAME	CODE	NAME
00		10	
01		11	
02		12	
03		13	
04		14	
05		15	
06		16	
07		17	
08		18	
09		19	

Transmitting a document using the speed dialer:
 Insert the documents FACE DOWN, then press the AUTO button and the code number (00 through 19).

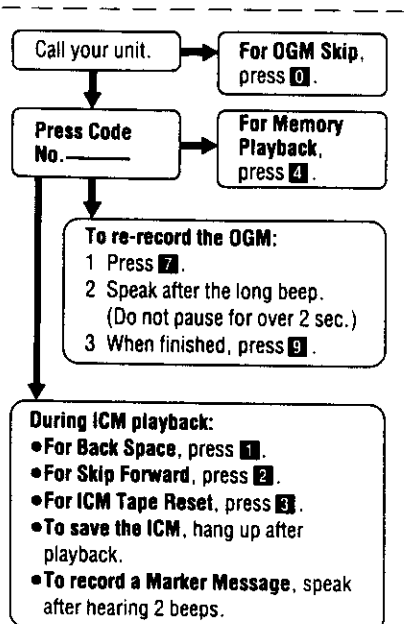

•When you press any button, press firmly.

Specifications

Type:	Desktop
Applicable Lines:	Public Switched Telephone Network
Compatibility:	CCITT G3
Document Size:	Max. 216 mm (8½") in width, Max. 600 mm (23⅝") in length
Effective Scanning Width:	Max. 208 mm (8⅜")
Printing Paper Size:	216 mm (letter) × 30 m roll (8½" × 98' roll)
Effective Printing Width:	208 mm (8⅜")
Transmission Time*:	Approx. 30 sec/page (G3 Normal mode) Approx. 17 sec/page (Original mode)
Scanning Density:	Horizontal 8 pels/mm (203 pels/inch) Vertical 3.85 lines/mm (98 lines/inch)—Standard 7.7 lines/mm (196 lines/inch)—Fine
Scanner Type:	CCD image sensor
Printer Type:	Thermal printing
Data Compression System:	Modified Huffman (MH)
Modem Speed:	9600/7200/4800/2400 bps; Automatic Fallback
Automatic Document Feeder:	Max. 10 sheets
Temperature Range:	5°–35°C (41°–95°F)
Humidity Range:	45%–85%
Dimensions (H×W×D):	125 × 429 × 312 mm (4 ²⁹ / ₃₂ " × 16 ⁷ / ₈ " × 12 ⁹ / ₃₂ "
Weight:	5.2 kg (11 lb 7.4 oz.)
Power Consumption:	Approx. 65 W
Power Supply:	AC 220 V–AC 240 V 50 Hz/60 Hz

*Transmission Time: Transmission times apply to text data using CCITT No. 1 test chart, between same machine models at maximum modem speed. Transmission times vary in actual usage.

Free Manuals Download Website

<http://myh66.com>

<http://usermanuals.us>

<http://www.somanuals.com>

<http://www.4manuals.cc>

<http://www.manual-lib.com>

<http://www.404manual.com>

<http://www.luxmanual.com>

<http://aubethermostatmanual.com>

Golf course search by state

<http://golfingnear.com>

Email search by domain

<http://emailbydomain.com>

Auto manuals search

<http://auto.somanuals.com>

TV manuals search

<http://tv.somanuals.com>