

# Panasonic

## AUTOMATIC TELEPHONE ANSWERING SYSTEM

### KX-T1460

### KX-T1461

EASA-PHONE

MODEL NO.

## OPERATING INSTRUCTIONS



The unit in this picture is the KX-T1460.

**Be sure to read Important Safety  
Instructions on page 43 and all the pages  
before use.**

La referencia rápida en español  
puede ser encontrada en las páginas 31~38.  
(Spanish Quick Reference can be found  
on pages 31~38.)

# AUTO-LOGIC™

# Features

Thank you for purchasing the Panasonic Telephone Answering System.

The KX-T1460/KX-T1461 features include:

- **Voice-Synthesized Announcements**  
for time, AM/PM, and time/day stamp on each ICM.
- **Extended OGM**  
lets you record an outgoing message of any length on a regular audio cassette tape (C-15 tape included).
- **AUTO-LOGIC™ Operation**  
simply press the Playback/Pause button, and the answering system will automatically switch to the Playback mode, rewind the ICM tape, and play any recorded messages. When your messages are finished playing, the tape will stop and the unit will switch to the Answer mode to record further messages.
- **Tone Remote Control System**  
lets you activate functions including OGM Record, Remote Turn On/Off, Memory Playback, and Room Monitoring via any tone telephone system.
- **Remote Turn On/Off**  
lets you turn the unit on and off from a remote location by using a tone telephone.

- **OGM Skip**  
special code lets the caller bypass your outgoing message so that they can promptly leave their message.
- **Remote Memory Playback**  
lets you review only those messages which haven't been played before.
- **Room Monitoring**  
lets you monitor the sounds in the room where the KX-T1460/KX-T1461 is located from a remote location.
- **Message Memo Recording**  
allows you to leave recorded memos for family and friends.
- **Automatic Interrupt**  
unit will automatically stop answering a call and switch to the stand-by mode when a parallel extension phone handset is lifted.

Quick Reference Card for remote operation can be found on page 39. Detach this Card from the Operating Instructions and carry it with you for your convenience.

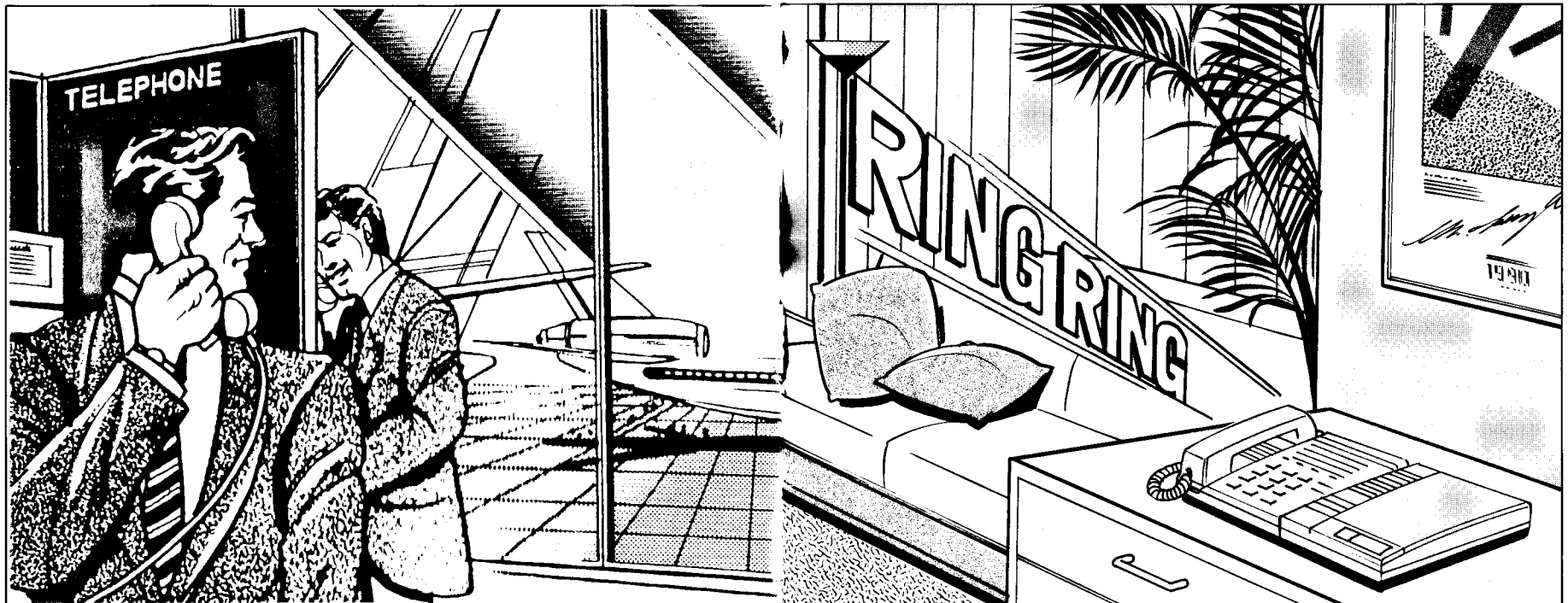

# Contents

## Preparation

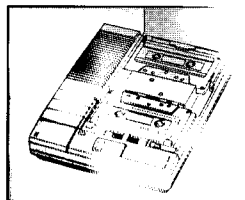

## Operation

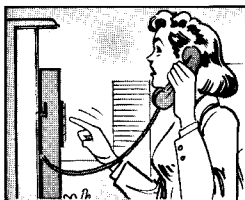

## General

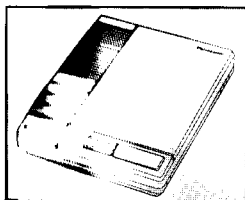

## Preparation

Location of controls and jacks .....	6
Inserting the tapes and Connection .....	8
Initial settings .....	10
Setting day and time .....	12
Recording an OGM (Outgoing Message) .....	14

## Answering Calls

Setting the ICM (Incoming Message) recording position .....	16
---	----

## After Returning

Listening to the recorded incoming messages .....	18
Erasing recorded messages .....	19

## Remote Control

Listening to the recorded messages from a remote telephone ...	20
Recording a message from a remote telephone .....	22
Resetting the ICM tape for future messages .....	23
Recording a new OGM (Outgoing Message) .....	24
Monitoring sounds where the unit is located (Room Monitor) ....	25
Turning the answering function on and off from a remote telephone .....	26

## Other Features

Recording a memo message .....	28
Screening calls .....	29

## Information

Troubleshooting guide .....	30
<u>Referencia rápida</u> .....	31
Maintenance, Cassette tape .....	39
Others .....	40
Important Information .....	41
Important Safety Instructions .....	43

# Location of controls and jacks

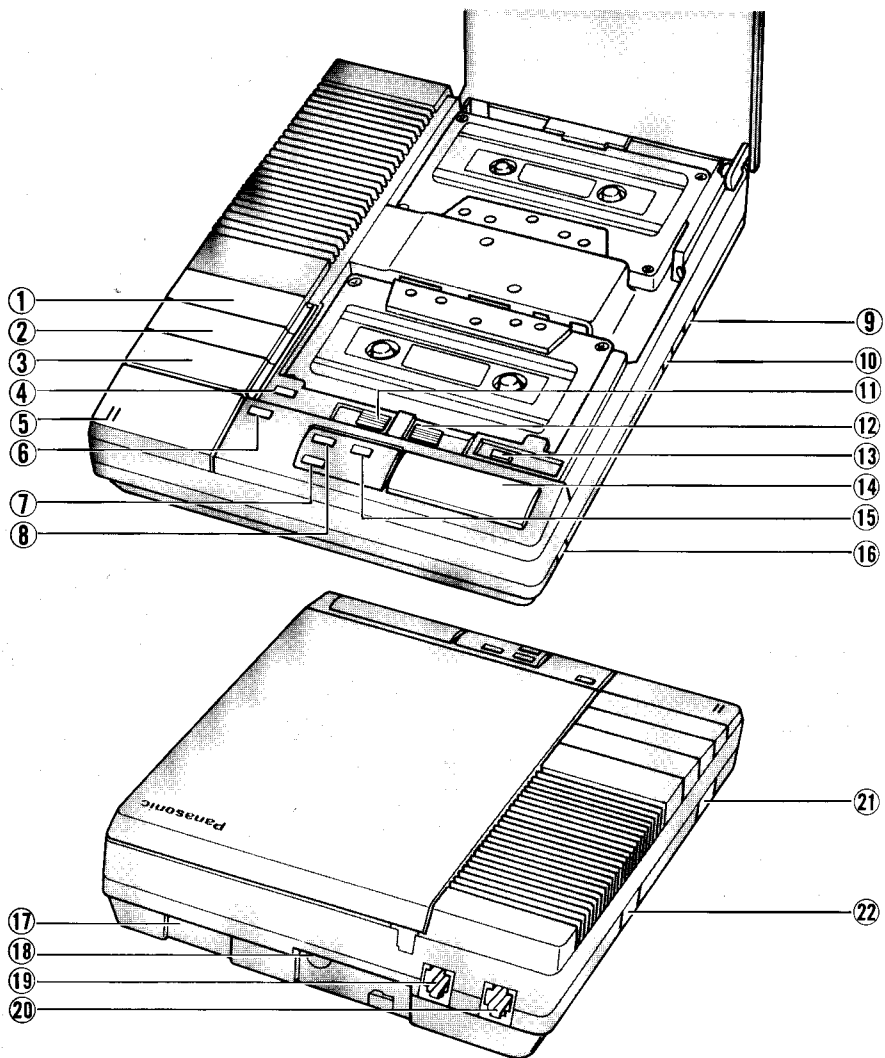

- ① Rewind Button (REW) : Used to rewind the ICM tape.
- ② Fast Forward Button (FF) : Used to forward the ICM tape.
- ③ MEMO Button : Used to record a personal message.
- ④ TIME ADJUST Button : Used to program the day and time.
- ⑤ Microphone (MIC)
- ⑥ TIME DAY CHECK Button : Announces the time and day.
- ⑦ ANSWER/CALLS Indicator : Indicates if there is a recorded incoming call or a personal message.
- ⑧ TIME Indicator : It lights when the TIME DAY CHECK button is pressed.
- ⑨ RING Selector (RINGS) : Used to select the number of rings before it answers.
- ⑩ Recording Time (REC TIME) Selector : Used to select the caller's recording time.
- ⑪ OGM Recording (REC) Button : Used to record an OGM.
- ⑫ OGM PLAY Button : Used to play the OGM.
- ⑬ ICM ERASE Button : Used to erase the ICM.
- ⑭ PLAYBACK/PAUSE Button : Used to play and stop the recorded ICM.
- ⑮ POWER/IN USE Indicator :
- ⑯ POWER ON/OFF Switch : Used to turn on and off the answering machine.
- ⑰ CPC Selector : Selector for call waiting service.
- ⑱ DC Jack
- ⑲ Telephone Line Jack
- ⑳ Telephone Jack
- ㉑ VOLUME CONTROL
- ㉒ REMOTE CODE Selector : Used to select the remote control code.

Included accessories: For accessory order, call toll free 1-800-332-5368.

AC adaptor ..... One

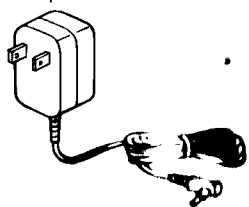

Telephone cord ..... One

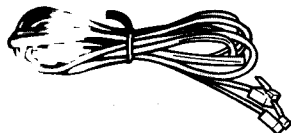

OGM (Outgoing Message) tape (C-15) ..... One (Standard Cassette)



ICM (Incoming Message) tape (C-60) ..... One (Standard Cassette)



# Inserting the tapes and Connection

Be sure to switch the power off before inserting a tape.

**1** Open the cover.

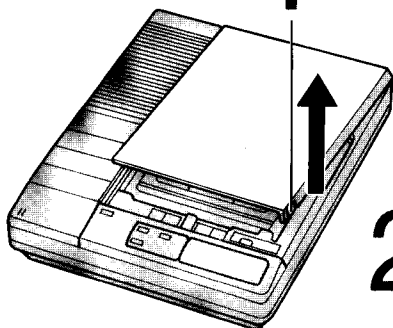

**2** Insert the OGM tape.  
(Outgoing Message)

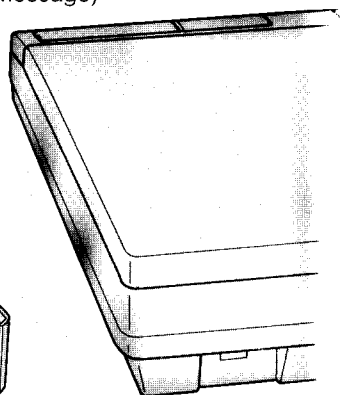

Insert the ICM tape.  
(Incoming Message)

**3**

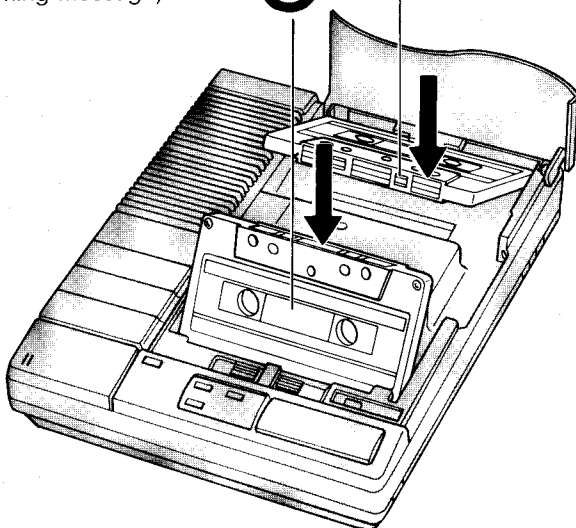

## Use Panasonic tapes:

KX-C150, KX-C300 ..... OGM tape  
KX-C600 ..... ICM tape  
(Standard Cassette)

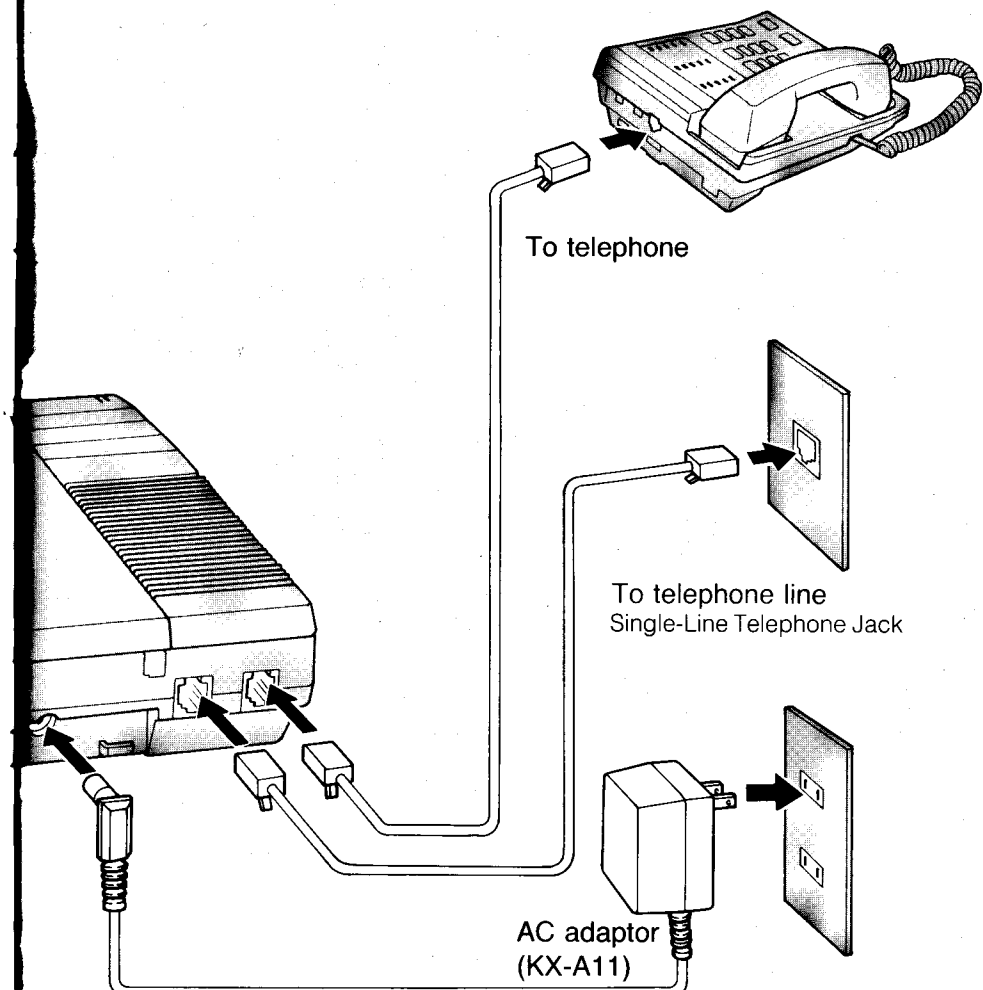
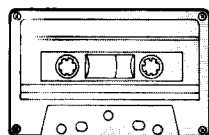

Snap the cord into the holder.

- Be sure to insert the tapes before connecting the AC adaptor.

Power receptacle  
(AC120V 60Hz)

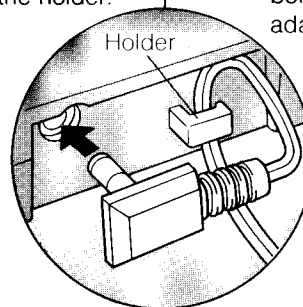

- Use only Panasonic AC Adaptor KX-A11.
- The unit will automatically turn itself on 3 minutes after the AC adaptor is connected.
- While operating the unit, the case of the AC adaptor may feel warm, this is a normal condition.

# Initial settings

These settings only have to be made the first time you use the unit, and not every time.

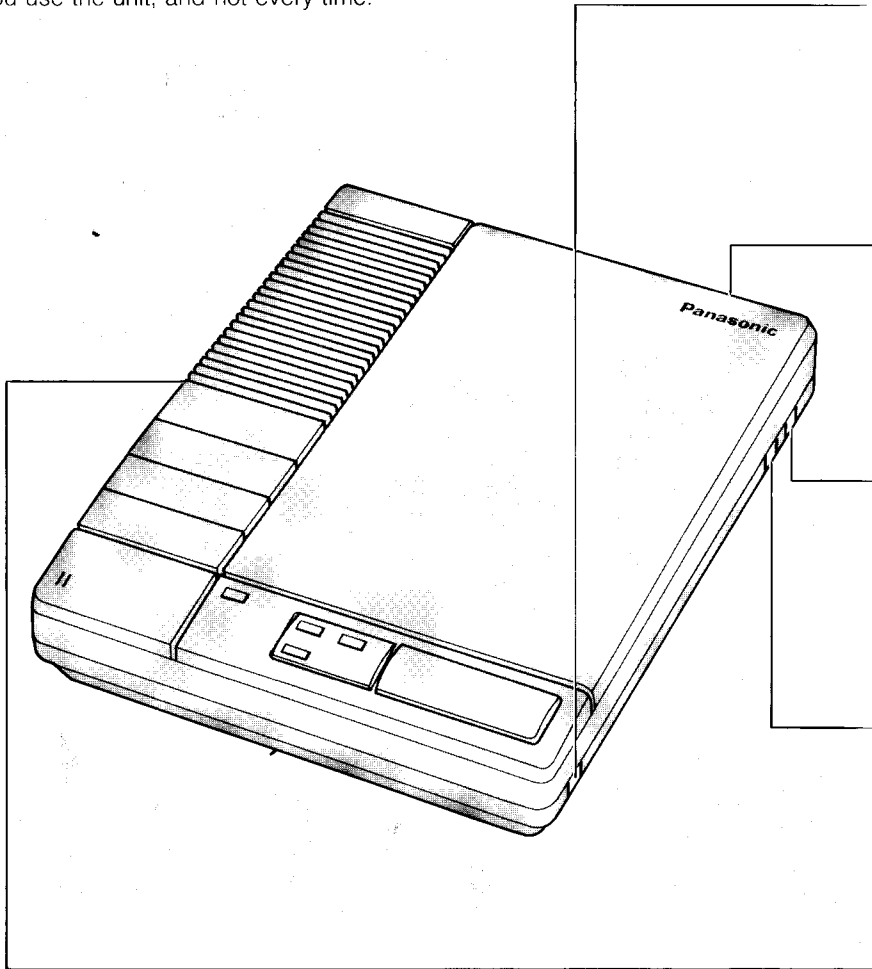

## Function of the AUTO setting (TOLL SAVER)

When you call up from an outside phone, the number of rings that it takes for the unit to answer tells you if there are any new messages.  
Answer on the 2nd ring ..... At least one new message  
Answer on the 4th ring ..... No new messages  
Hang up immediately when you hear the 3rd ring. Because the 3rd ring means there are no new messages. This will save you the toll charge for the call.

1

POWER  
ON/OFF



Press the **POWER ON/OFF** switch

to turn unit on. The POWER/IN USE indicator lights, and the OGM tape rewinds.

2

CPC



A •• B

**Calling Party Control setting**

A ... Use this setting if your telephone line does not have call waiting service.

B ... Use this setting if your telephone line has call waiting service.

If some incoming messages are cut off in position A, set to position B.

3

RINGS



2 ••• AUTO  
4

**Number of rings**

AUTO · See "AUTO setting" box on page 10.

2 ... Answers on the 2nd ring.

4 ... Answers on the 4th ring.

4

REC TIME



1 MIN •• VOX

**ICM (Incoming Message) recording time**

VOX ..... The recording time is limited by the length of the tape

1 MIN ... Maximum of 1 minute per incoming message.

5

REMOTE CODE



3 •• 9

**Remote operation code number**

The first digit is preset by the factory. Select "3" or "9" as the second digit.

# Setting day and time

Incoming messages can be recorded with the day and time the message was received. This is called the TIME/DAY stamp.

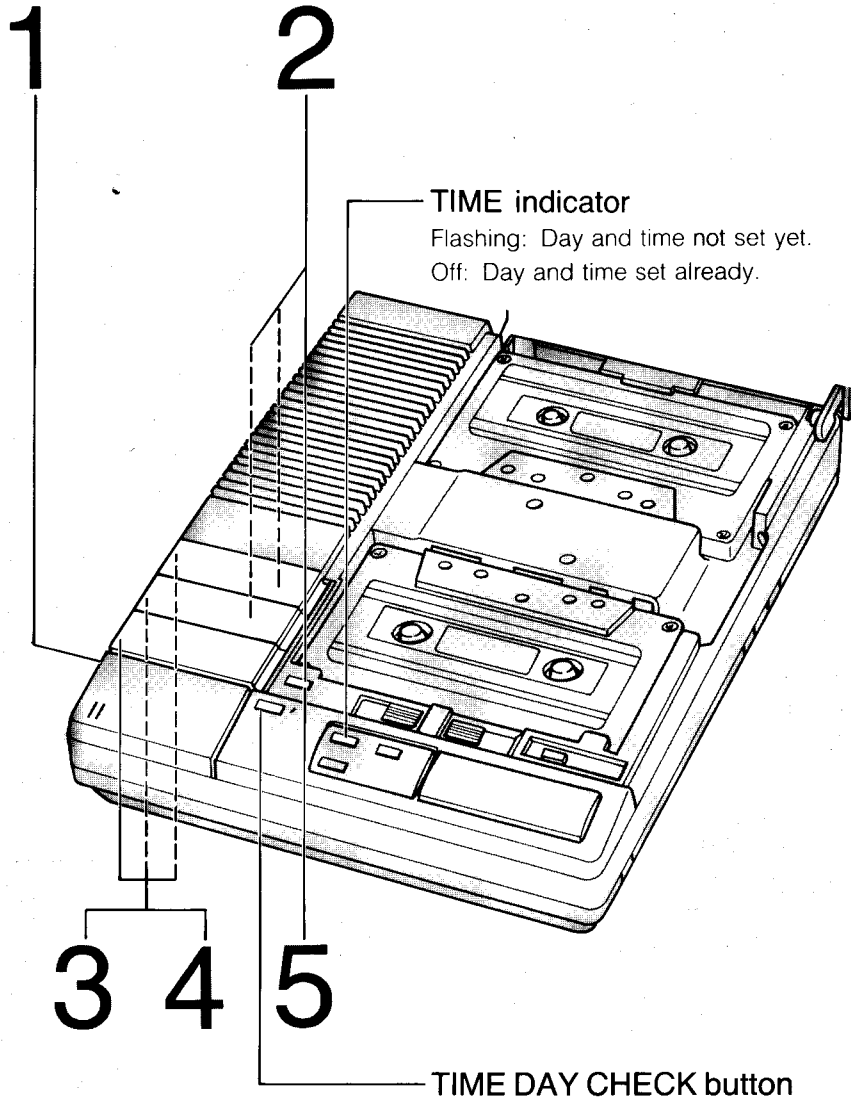

## NOTE

- The FF and the REW buttons are used to program the setting.
- Settings are protected for about three hours if external power is cut off.
- The clock is accurate to about 45 seconds a month at room temperature.

**1**

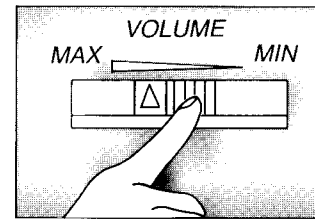

**Set the volume.**  
The central position is usually best.

**2**

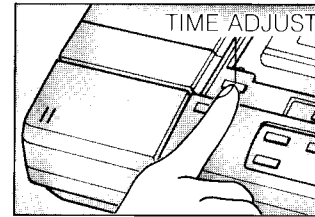

**Setting day**  
**Press the TIME ADJUST button.**  
"Sunday" is announced.  
The TIME indicator lights.  
Press the FF or the REW button to advance or reverse the days.

**3**

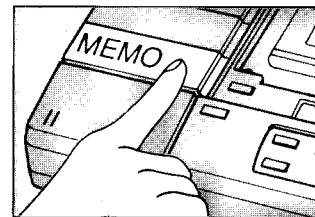

**Setting hour**  
**Press the MEMO button.**  
"12:00 A.M." is announced.  
Press the FF or the REW button to advance or reverse the hours.

**4**

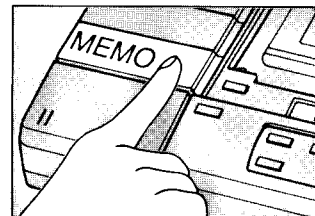

**Setting minute**  
**Press the MEMO button.**  
"0 (Oh)" is announced.  
Press the FF or the REW button to advance or reverse the minutes.

**5**

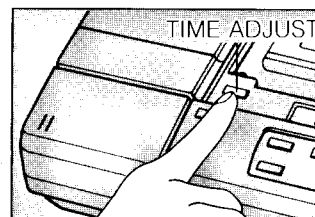

**Press the TIME ADJUST button**  
to record your settings. (The TIME indicator goes out and the clock starts.)  
The day and time is announced.  
(If they are wrong, repeat from step 2 above.)

**Checking the day and time:**

Press the TIME DAY CHECK button.

# Recording an OGM (Outgoing Message)

The OGM tells the caller that you are out, and asks to leave a message.

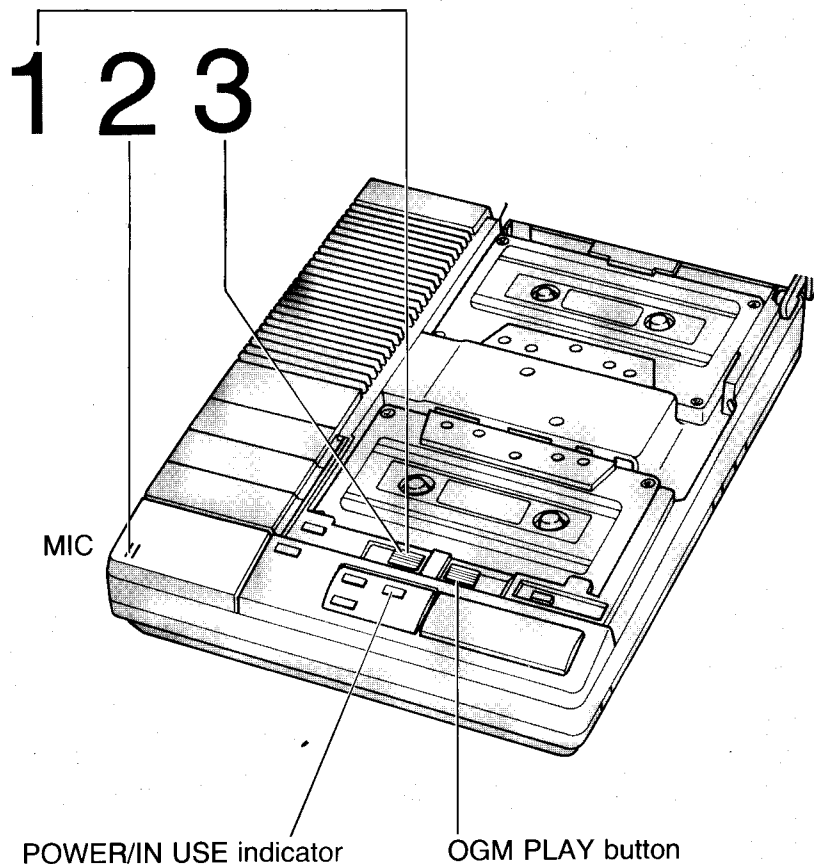

## Sample OGMs

### When Recording Time is set to "VOX" (see page 11)

Example: "Hello. This is Dick Smith. I'm not here now, but if you'll leave your name and phone number after the beep, I'll call you back. Thank you."

Example: "This is Smith Appliances. Our offices will be closed until nine o'clock in the morning. Please leave a message with your name and telephone number after the beep, and we will return your call as soon as possible. Thank you."

### When Recording Time set to "1 MIN" (see page 11)

Example: "Hello, this is Dick Smith. I'm out now, but if you leave a message after the beep I'll call you back. You have one minute for recording. Thank you."

1

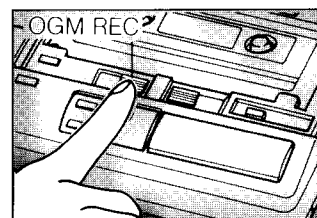

**Press the OGM REC button until a long beep is heard, then release it.**  
The IN USE indicator flashes.

2



**Begin speaking at once,**

Speak loudly and clearly right after the beep, about 8 inches away from the microphone (MIC).  
Do not pause for over 2 seconds while recording.

If the beeper sounds six times, start over again from step 1 after the unit stops rewinding.

3

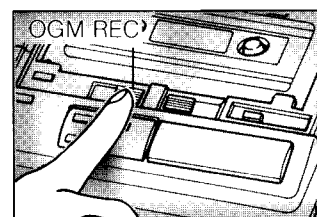

**Press the OGM REC button again when the recording finished.**

The tape rewinds, and the unit will be ready to receive incoming calls seven seconds later.

## Checking your recorded message (OGM)

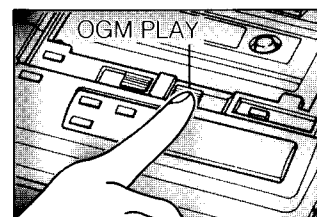

**Press the OGM PLAY button to start.**

Adjust volume with the volume control, if needed.

**Press the OGM PLAY button again to stop.**

When finished, the tape rewinds. The unit will be ready to receive incoming calls seven seconds later.

After you replace your OGM tape, press the OGM PLAY and REW buttons simultaneously to rewind the tape back to the beginning.



## Setting the ICM (Incoming Message) recording position

If you want to check your OGM, press the OGM PLAY button.

Check that the ANSWER/CALLS indicator is lit. If off, press the POWER ON/OFF switch.

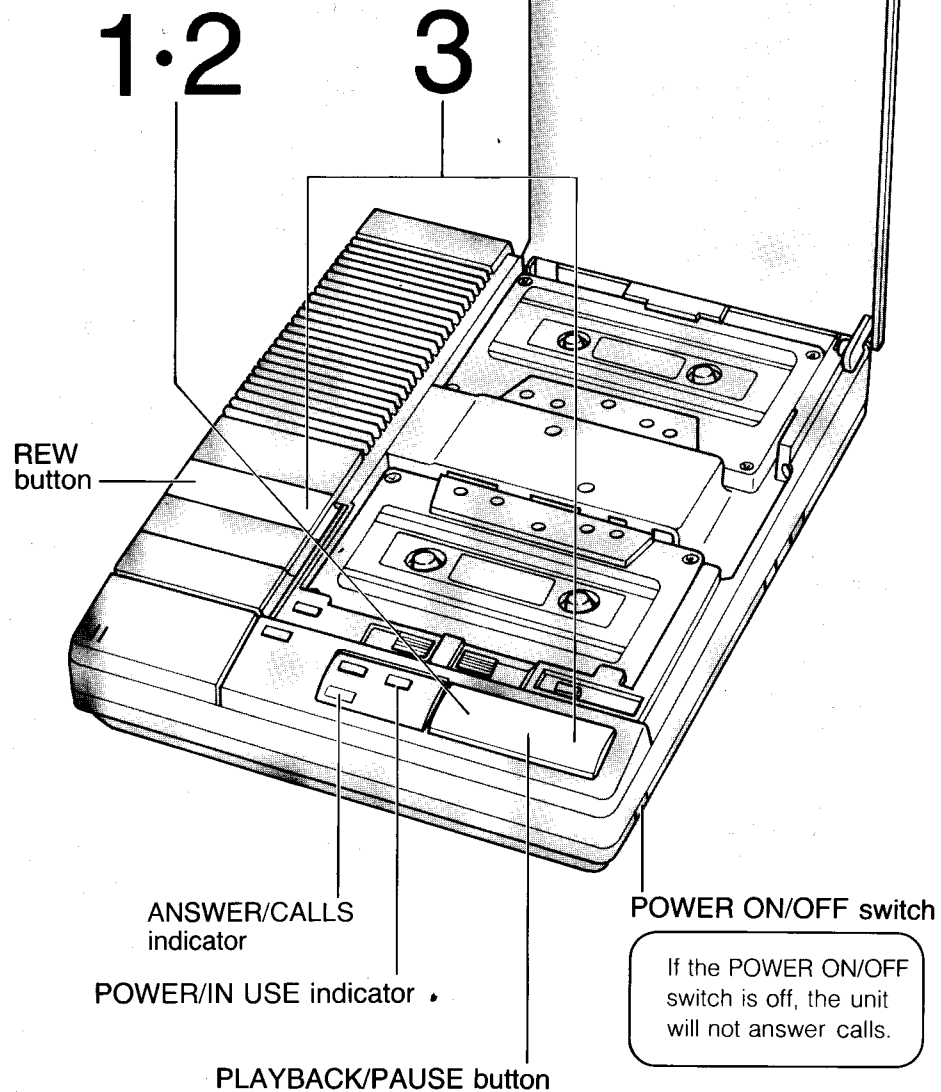

## Recording from the beginning of the ICM tape

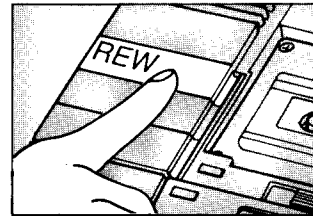

Press the REW button to rewind the tape.

The unit is now ready to answer incoming calls.

## Recording after the last recorded message

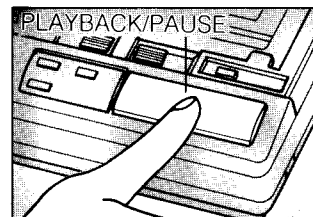

Press the PLAYBACK/PAUSE button to play back the recorded messages.

After playing back all the messages (this means that the unit saves all the messages), the unit is automatically ready to record future messages.

## Recording after the messages that you want to save

1

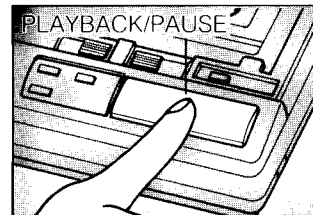

Press the PLAYBACK/PAUSE button to play back the tape.

2

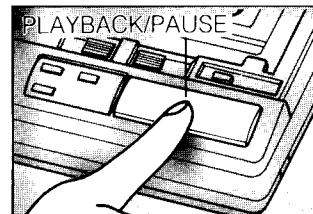

Press the PLAYBACK/PAUSE button again after hearing the messages you want to save.

The tape stops, and the IN USE indicator flashes (pause mode).

3

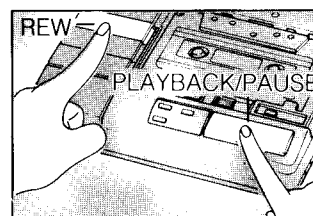

Press the PLAYBACK/PAUSE and REW buttons simultaneously.

The POWER/IN USE indicator lights. The ANSWER/CALLS indicator lights, showing the unit is ready to answer incoming calls.

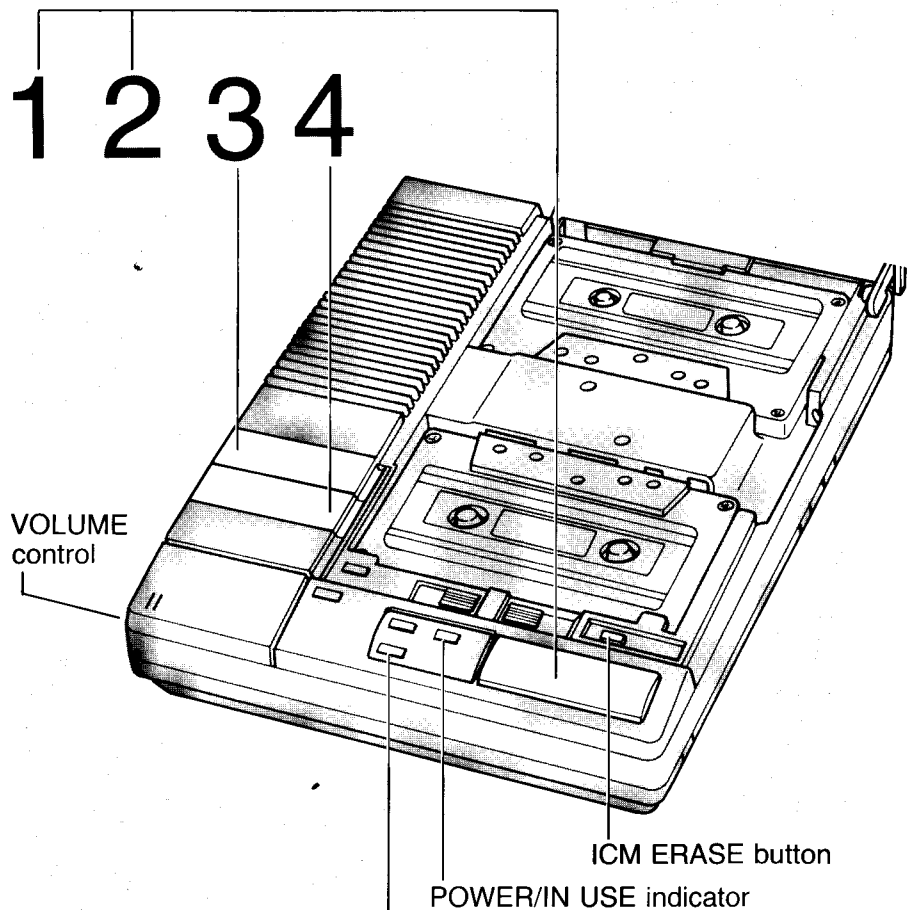

**ANSWER/CALLS indicator**

The number of flashes indicates the number of messages received (maximum of 15 flashes).  
In case of power interruption, the indicator will flash slowly after the power is restored.

**AUTO-LOGIC™ Operation**

Simply press the Playback/Pause button, and the answering system will automatically switch to the Playback mode, rewind the ICM tape, and play any recorded messages. When your messages are finished playing, the tape will stop and the unit will switch to the Answer mode to record further messages.

**Playing the tape from the start**

1

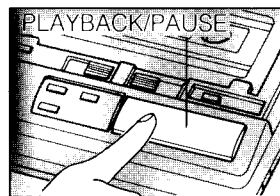

Press the **PLAYBACK/PAUSE** button to rewind the tape and start playing.  
Adjust volume, if needed.  
Three beeps will mark the end of the last recorded message.

2

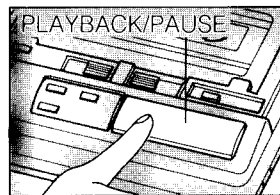

Press the **PLAYBACK/PAUSE** button to stop the tape (pause mode).  
Press the button again to restart playback.

3

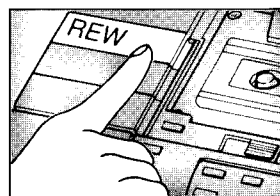

Press the **REW** button to rewind the tape back to the desired location.  
Press the **PLAYBACK/PAUSE** button to listen to the message.

4

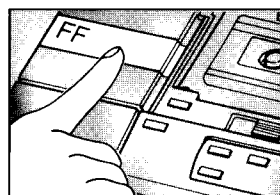

Press the **FF** button to fast forward the tape to the desired location.  
Press the **PLAYBACK/PAUSE** button to listen to the message.

After returning

**Erasing recorded messages**

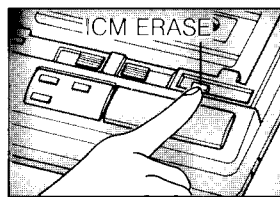

Press the **ICM ERASE** button until the beep is heard.  
The tape is erased while it rewinds.

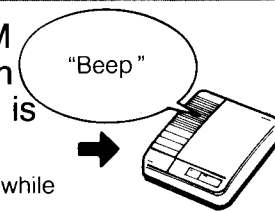

**Caution**

- The tape will be erased even if the record-prevention tabs (knockouts) have been removed.

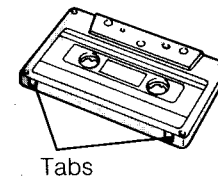

# Listening to the recorded messages from

# a remote telephone

## ■ TOLL SAVER

The number of rings that it takes for the unit to answer tells you if there are any new messages.

Answer on the 2nd ring ..... At least one new message

Answer on the 4th ring ..... No new messages

To save the toll charge, hang up immediately when you hear the 3rd ring.

• Note that remote control operations is only possible with a tone telephone (touch tone telephone).

## REMOTE CODE (2 digits)

Be sure to remember your remote code number (see page 11).

You can use this code number to operate the unit from a touch tone telephone.

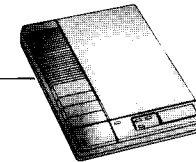
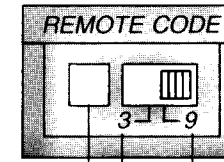

The first digit is pre-set by the factory.

The second digit is selected by you.

It is possible to skip over messages you have already heard and jump to new messages.

### Playing back all the messages

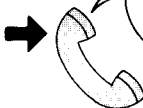
**1**  **Dial your telephone number.**  "Hello, this is Dick Smith. I'm out now..."

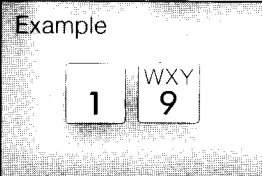
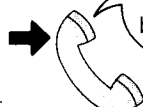
**2**  **Press your code number** (for example, 19) while the OGM is playing. One beep will sound for each message recorded, up to a maximum of eight.  "Beep, beep, beep,..."

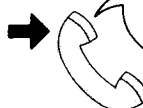
**3**  **The tape will automatically rewind.**  "Whir, whir,..."

You will be able to hear it rewinding.

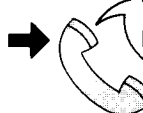
**4**  **When the tape has rewound back to the start, it will play the messages.**  "Beep, beep, beep,..."

Three beeps will mark the end of the messages.

**5**  **Hang up.**

All recorded messages will be saved and the unit will be ready to record additional messages.

### Playing back newly-recorded messages (Memory Playback)

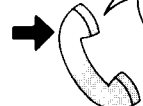
**1**  **Dial your telephone number.**  "Hello, this is Dick Smith. I'm out now..."

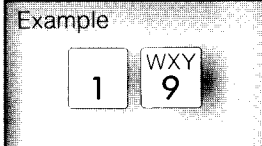
**2**  **Press your code number** (for example, 19) while the OGM is playing.

**3**  **Press "4"** after hearing beep(s), up to a maximum of eight.

- If you want to rewind the tape and listen to previously recorded messages: Press "3", then press "3" again after hearing a beep (the tape will rewind to the start). Press "2" after hearing a beep, to play back messages.

### Rewinding/Fast forwarding

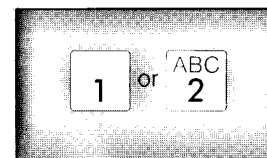

To rewind, press "1".  
To fast forward, press "2".

(Pressing once will move the tape by about 15 seconds of message time in the corresponding direction. Press as many times as necessary.)

Remote Operation

## Recording a message from a remote telephone

After playing back the recorded messages, you can record your own message, on the same call.

You can also record a message directly without listening to the OGM.



### Recording after listening to the last recorded message

- When replay is finished, wait for the three beeps to mark the end of the last message and then wait about 10 seconds for another two beeps to indicate the tape is ready to record.

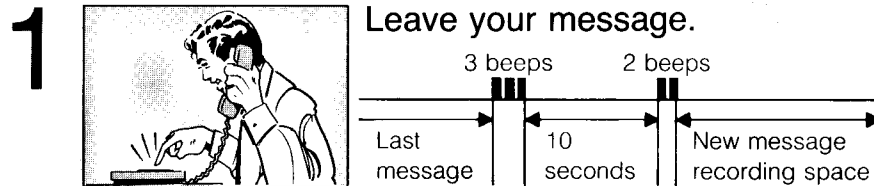

### Recording your message without listening to the OGM

- After dialing (step 1, page 20).

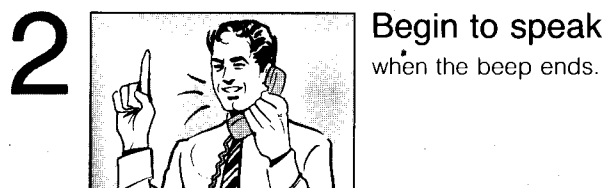
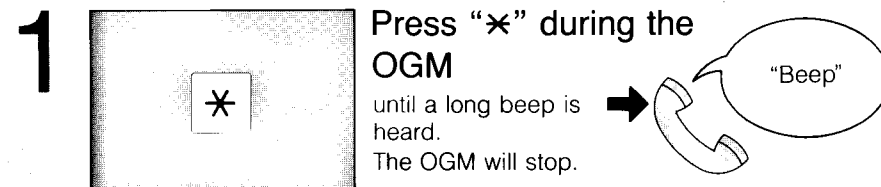

## Resetting the ICM tape for future messages

If you rewind the tape and new messages are recorded from the beginning of the tape, old messages will be lost.



### Resetting the tape

- When the recorded messages have been played back or while they are being played,

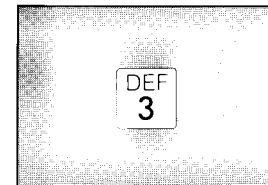

**Press "3".**

The unit rewinds to the beginning of the tape. You are able to hear the rewinding sound.



### Resetting the tape after you have used Memory Playback

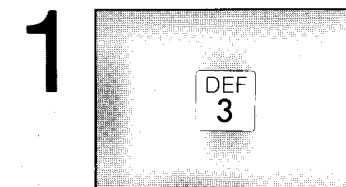

**Press "3".**

The unit rewinds the tape to the beginning of the newly-recorded messages and a beep will be heard.

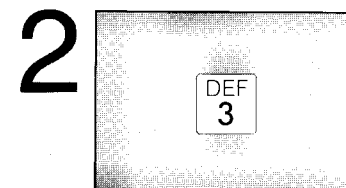

**Press "3" again after hearing a beep.**

The unit rewinds the tape to the beginning of the previously recorded messages.

### If you have reset the tape by mistake

Press "2" after hearing a beep (the tape has been reset) then hang up. The tape will advance to the end of the recorded messages.

# Recording a new OGM (Outgoing Message)

You can change the content of your OGM (Outgoing Message) tape from a remote telephone.





# Monitoring sounds where the unit is located (Room Monitor)

You can listen to (monitor) the sounds in the room where the unit is installed for about 30 seconds.



## Recording a new OGM

**1**  **Dial your telephone number.** 

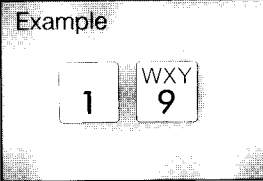
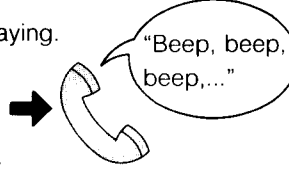
**2**  **Press your code number** (for example, 19) while the OGM is playing. One beep sounds for each message recorded, up to a maximum of eight. 

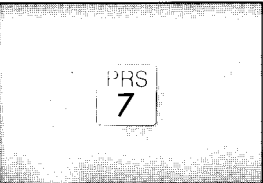
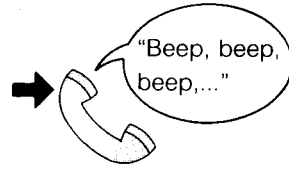
**3**  **Press "7" to rewind the tape.** 

**4**  **Speak immediately** after the long beep. If you pause for more than about 2 seconds you will hear six beeps, and the OGM recording will stop. In this case, repeat step 3 within 10 seconds.

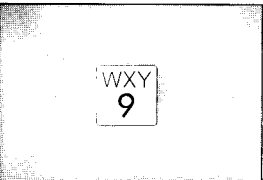
**5**  **Press "9"** when you are finished. The new OGM is played back for you to check. Return to step 3 and repeat if there are any mistakes.

## Room sound monitor

**1**  **Dial your telephone number.**

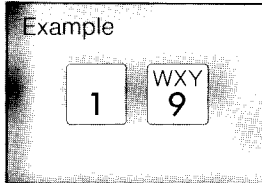
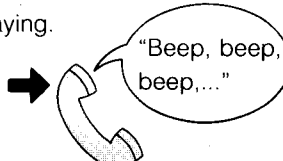
**2**  **Press your code number** (for example, 19) while the OGM is playing. One beep sounds for each message recorded, up to a maximum of eight. 

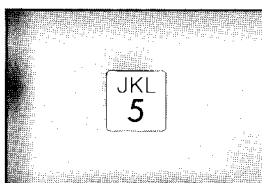
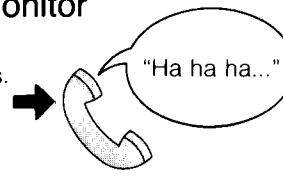
**3**  **Press "5" to monitor** the room sounds for about 30 seconds. 

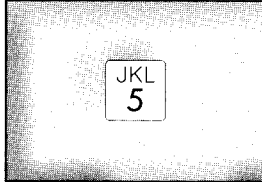
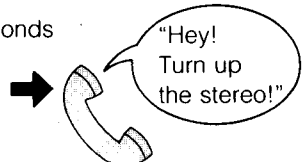
■ To continue monitoring;  **Press "5"** again within 10 seconds after the beep. 

Remote Operation

# Turning the answering function on and

You can turn on the answering function from a remote telephone.



# off from a remote telephone

Turning off the answering function from a remote telephone.



## Turning on the automatic answer function



Dial your telephone number.

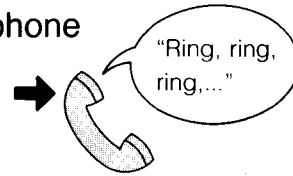

Let the telephone ring 15 times,

and the unit will automatically switch on and begin to play the OGM.

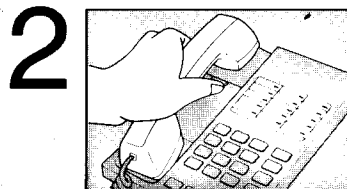
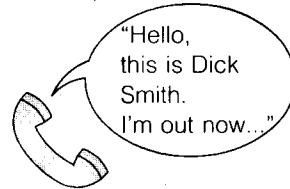

Hang up while the OGM is playing.

The unit will stay on and record any other incoming calls.

## Turning off the automatic answer function



Dial your telephone number.

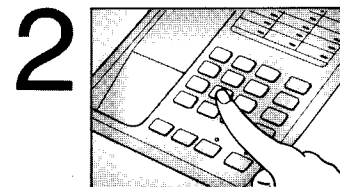
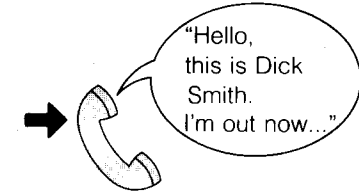

Press your code number

while the OGM is playing. One beep sounds for each message recorded, up to a maximum of eight.

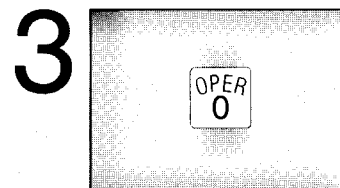
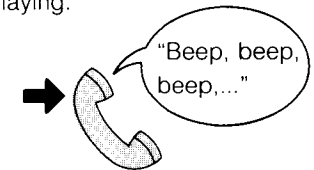

Press "0" to turn off the automatic answer function.

## Recording a memo message

You can record a memo message at home. It will be heard by anyone who listens to the recorded messages.



## Screening calls

You can listen to incoming messages as they are being recorded.

If you lift up the handset to talk to the caller during recording, recording will stop at once.

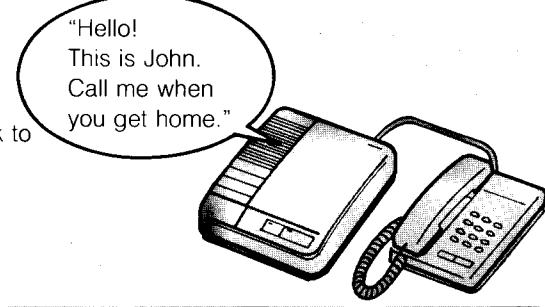

### Recording a personal message (message memo)

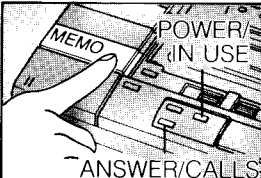
**1**  Press the **MEMO** button until the beep is heard. The IN/USE indicator begins to flash.

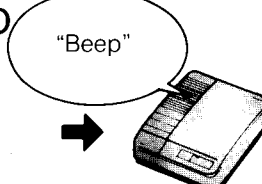
 "Beep"

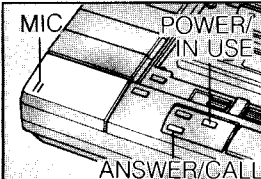
**2**  Record your message. Speak from a distance of about 8 inches away from the microphone.

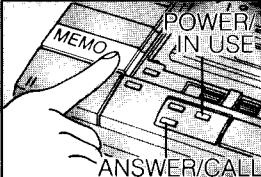
**3**  Press the **MEMO** button when finished. The IN/USE indicator goes out, and the ANSWER/CALLS indicator begins to flash.

### Screening call

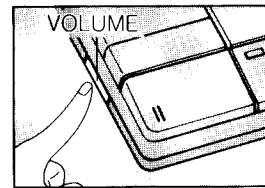

Adjust the **VOLUME** control.

### To talk to the caller during recording

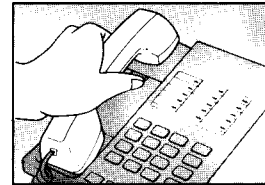

Lift up the handset and talk.

Recording stops automatically.



# Troubleshooting guide

Problem	Cause & Remedy
<ul style="list-style-type: none"> <li>●The unit does not work when I press any buttons.</li> <li>●I cannot remove the cassette from the unit.</li> </ul>	<p>Plug in the AC adaptor then switch the power on.</p>
<p>The unit has been set to the Answer mode, but no Incoming Message is recorded.</p>	<ul style="list-style-type: none"> <li>●The OGM or ICM cassette tape is cut or is not inserted. Replace the cassette tape with a new one.</li> <li>●The OGM is recorded improperly. Record a new OGM.</li> </ul>
<p>The unit does not function. However, the beep sounds 6 times and the ANSWER/ CALLS indicator flashes on and off quickly.</p>	<ul style="list-style-type: none"> <li>●OGM cassette tape might be broken. Replace it with a new one.</li> <li>●Clean the heads. (See page 39.)</li> </ul>
<p>While recording an Outgoing Message, the beep sounds 6 times.</p>	<p>Re-record your Outgoing Message. Speak clearly and loudly, and do not pause for over 2 seconds while recording.</p>
<p>When the Outgoing Message or the Incoming Message tape is played back, the sound level is low, even if the VOLUME control is turned up fully.</p>	<p>Clean the Heads. (See Maintenance instruction on page 39.)</p>
<p>I have played back all the recorded messages and I want to record the next phone call after the last previously recorded message.</p>	<ul style="list-style-type: none"> <li>●Wait for 7 seconds. The unit will be ready to record the next phone call.</li> <li>●In case of the remote operation, just hang up.</li> </ul>
<p>I press the button of a remote phone, but the unit does not respond.</p>	<ul style="list-style-type: none"> <li>●Make sure that you are entering your correct Code number.</li> <li>●Record the Outgoing Message in a quiet place.</li> </ul>
<p>Some Incoming Messages have not been recorded up to their end.</p>	<p>Set the CPC switch to "B". (See page 11.)</p>
<p>The ICM tape continues to run after a caller hangs up.</p>	<p>Set the recording time selector to "1 MIN".</p>



## Free Manuals Download Website

<http://myh66.com>

<http://usermanuals.us>

<http://www.somanuals.com>

<http://www.4manuals.cc>

<http://www.manual-lib.com>

<http://www.404manual.com>

<http://www.luxmanual.com>

<http://aubethermostatmanual.com>

Golf course search by state

<http://golfingnear.com>

Email search by domain

<http://emailbydomain.com>

Auto manuals search

<http://auto.somanuals.com>

TV manuals search

<http://tv.somanuals.com>