

AUTO-LOGIC™

Panasonic

Operating Instructions

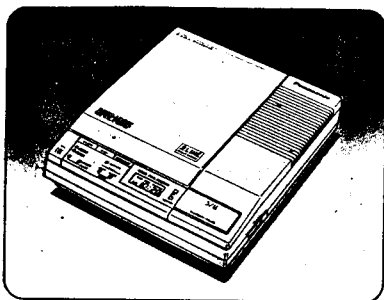

Please read before use.

TONE REMOTE CONTROL
AUTOMATIC TELEPHONE
ANSWERING SYSTEM

Model No. **KX-T1720**

EASA-PHONE

Thank you for purchasing
the Panasonic Telephone
Answering System.

Contents

Location of Controls	1	Cassette Tapes	13
Initial Preparation	1	Maintenance	14
Connections	2	Others	14
Basic Operation		Troubleshooting Guide	15
How to Record Outgoing		Important Information	16
Message (OGM)	3	Accessory Order Information ..	17
Setting Prior to Leaving	4	Tarjeta de Referencia	
Listening to Messages	5	Rápida	18
Other Features	6	Servicenter Directory	21
Detailed Operation		Warranty	22
How to Adjust Time	7		
How to Operate from			
Remote Phone	8		
General Information			
Liquid Crystal Display	12		
Announcements			
by the Unit	12		

Accessories

AC Adaptor (KX-A11)	1
Outgoing Message Tape	1
Incoming Message Tape	1
Telephone Cord (4-wired)	1
Telephone Cord (2-wired)	1

La tarjeta de referencia rápida en español puede encontrarse en las páginas 18~20.

(Spanish quick reference card can be found on pages 18~20.)

Basic Operation

Detailed Operation

General Information

Location of Controls

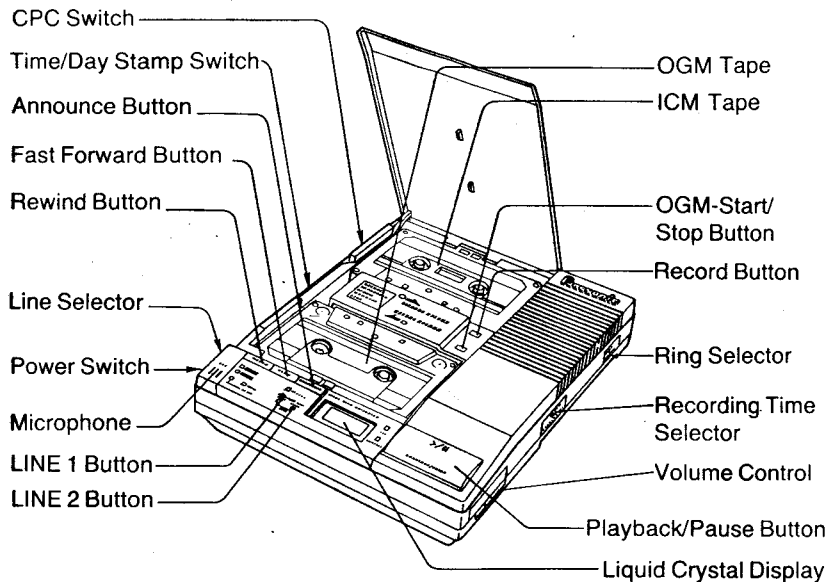

Initial Preparation

- 1 Connect as shown on page 2.
- 2 Set for the correct time. See page 7.
- 3 Insert the tapes.
- 4 Push the Power Switch on. (Power indicator will light.)
- 5 Set the CPC Switch to "A".

Usually set to "A".
(No call waiting service)
Set to "B" when you have call waiting service. Or if some incoming messages are interrupted.

- 6 Set the Line Selector.

LINE 1 The unit will answer a call on Line 1 only.
LINE 2 The unit will answer a call on Line 2 only.
AUTO The unit will answer a call on Line 1 and Line 2.

- The selected line's indicator lights up. (When you set to "AUTO", both line indicators light up.)
- The line indicator receiving a call flashes.

- 7 Push the REW button to reset the ICM tape.

Connections

Connect as shown.

- USE Panasonic AC ADAPTOR, KX-A11.
- While operating the unit, the cabinet may feel warm, this is a normal condition.

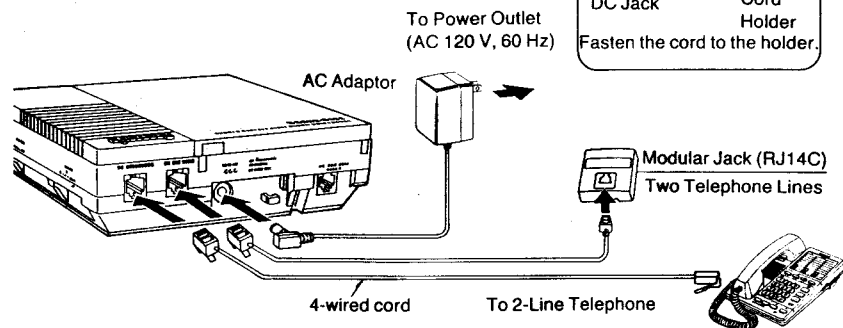

- This unit may not be connected to a coin operated line. If you are on a party line, check with your local telephone company.

To Use Two Single Lines

- When you connect to the 2 single lines:

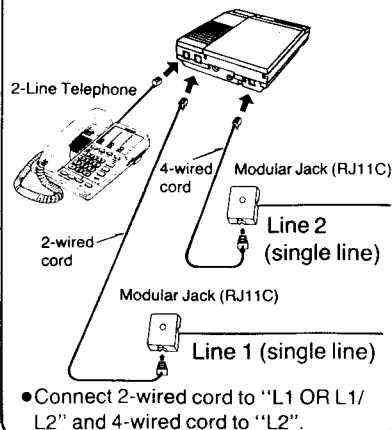

To Use Two Single Line Telephones

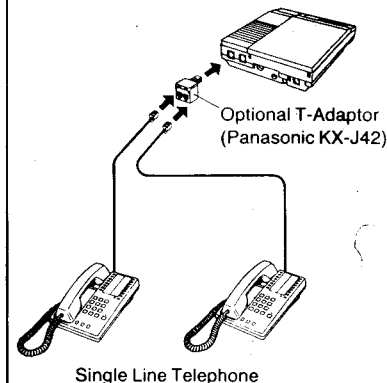

- When you connect two single line telephones instead of a 2-line telephone to each line:



How to Record Outgoing Message (OGM)

The purpose of the Outgoing message is to inform the calling party that you cannot answer, but want to record the caller's message.

Recording

1  , while holding it, push the  until a beep sound is heard.

- The In Use indicator will light.
- The Display will show "0" → "1" → "2" → "3"...

2 Speak clearly and loudly to .

- Speak for up to 30 seconds from about 8 inches away from MIC.
- While recording, do not pause for over 2 seconds.

3 When finished, 

- Wait until the In Use indicator goes out.
- A series of short beeps will be heard to advance the tape followed by a long beep signaling that the unit is at the beginning of the tape.

Confirming

4 

- Adjust the volume control to confirm.
- Wait until the In Use indicator goes out.

Re-recording

If you want to record again, repeat from the step 1.

- Note:**
- If you pause for over 2 seconds while recording, the unit will sound 6 beeps and announce "Please record your outgoing message again." If this happens, wait until the In Use indicator goes out and start with the step 1 over.
 - The unit will automatically change to the Answer mode after 7 seconds from when the In Use indicator goes out.

Sample of Outgoing Message

- **Set Recording Time Selector to "1 MINUTE" or "VOX".**

Hello, this is (the Panasonic Company). We cannot answer your call at this time. If you leave your name and phone number, we will return your call as soon as possible. Speak clearly after you hear the beep.

(You have 1 minute to leave your message.)

If "End of tape" is announced, your message will not be recorded. Should this happen please call back tomorrow.

Note:

When the ICM tape is full, the unit cannot record any more messages. This is indicated to the caller by the announcement "End of tape". If you wish to inform the caller of this possibility, add the sentences (printed in bold-face above) to your OGM recording.

- **Set Recording Time Selector to "ANNOUNCE".**

Hello, this is (the Panasonic Company). We are not able to answer your call at this time. Please call us again tomorrow, after 9 AM. Thank you for calling.

Setting Prior to Leaving

The unit will automatically set to the Answer mode by simply pushing the Power Switch. When the telephone rings, the unit will play back the OGM, then it will record the Caller's messages and the day and time of the message will be recorded on the ICM tape.

- Select each selector.

Recording Time Selector

REC TIME
1 MIN
ANNOUNCE...VOX



(Select)

1 MIN:

- The unit will record up to 1 minute.

VOX:

- The unit will record for as long as the caller speaks.

ANNOUNCE:

- The unit will play back the Outgoing message and will not record any Incoming messages.

Ring Selector

RING
2...4 AUTO



(Select)

2:

- The unit will answer a telephone call on the second ring.

4:

- The unit will answer a telephone call on the fourth ring.

AUTO:

- The unit will answer on the second ring if any Incoming messages have been recorded.
- The unit will answer on the fourth ring when no Incoming messages have been recorded.

See "Toll Saver" on page 8.

Preparation

After reviewing the Outgoing or Incoming message the unit will automatically reset itself to the Answer mode and will be ready to answer the next call.

After reviewing.
(The Liquid Crystal Display will show "0".)

To record future messages after the last message.

Leave the unit as it is.

To record future messages from the beginning of the tape.

Push the **REW** button.

- Before leaving home (or office) confirm that the Answer indicator light is on and the Line Selector is set to the desired line.
- If you use a new ICM tape or record future messages from the beginning of the tape, push the REW button.
- If you do not want to set the unit to the Answer mode, turn the Power Switch off.

Listening to Messages

When an Incoming message has been recorded, the Liquid Crystal Display will show the number of calls and the Answer indicator will flash.
In the case of a power interruption, the Liquid Crystal Display will show "--" after the power is restored.

To Listen to Messages



Auto-Logic (One Touch Operation)

The unit will announce the number of received messages and the ICM tape will automatically rewind and begin to play back. At the end of all the messages "End of final message" will be heard. 7 seconds after "End of final message" is announced the unit will reset back to the Answer mode.

- The unit will announce "1" or "2", according to the Line 1 or Line 2, before recording the Incoming message and the day and time after the recording.
- **Future Incoming messages will be recorded after the last message.**
To record from the beginning of the tape, push the REW button.

• To stop the tape temporarily, push the Pause button. (The In Use indicator will flash.) To restart, push the button again.

- to rewind the tape.
- to fast forward the tape.

- During the Pause mode, the unit will not automatically change to the Answer mode.

Monitoring the Incoming Call



While an Incoming message is being recorded;

- 1 Adjust the Volume Control.

To talk to the caller directly during recording Incoming message, confirm which line indicator is flashing and lift the handset to talk.

- The ICM tape will stop after recording the message recorded day and time.



- Even when the handset of another telephone that is connected on the same line is lifted, the ICM tape will stop recording.
- If the tape will not stop, depress the hook switch for about 1 second.

Other Features

Recording a Conversation

Many States have regulations on the manner in which Two-Way Telephone Conversations may be recorded. Consult your public utility agency.

■ To record a conversation on Line 1

- 1 While having a conversation, until a beep sound is heard.
 - A beep will sound every 15 seconds.

- 2 When finished, again.

■ To record a conversation on Line 2

- 1 While having a conversation, until a beep sound is heard.
 - A beep will sound every 15 seconds.
- 2 When finished, again.
 - Use the handset, even if your telephone is equipped with a speakerphone. Recording may not be done in the hands-free mode.

Message Memo

You may record a confidential message any time at home on the ICM tape. It can be heard by people who know the code number.

- 1 and simultaneously until a beep sound is heard.
- 2 Speak into the .
- 3 When finished, .
 - The unit will be ready to answer the next call.

Voice Time/Day Stamp

When the messages are received, a voice synthesized announcement of the day and time will be recorded on the ICM tape.

Set the Time/Day Stamp Switch to "ON".

- When you record the Two-way Telephone Conversation or Message Memo, the day and time will be stamped as well as the incoming message.

If a call is received on one of the 2 lines while recording the ICM or OGM from a remote phone, noise will be occasionally heard and recorded on the tape. This is normal.

Other Features (cont.)

Saving the Recorded Messages

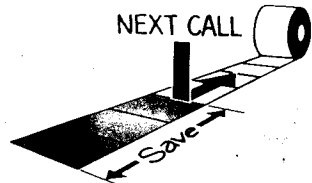

1 Play back the tape to the message you want to save.

2 , while holding it, push the button.

- The unit will go into the Answer mode and future Incoming messages will be recorded after the messages you have saved.

Erasing the Recorded Messages

, while holding it, push

the or until a beep sound is heard.

- The messages are erased while rewinding or fast forwarding.
- The cassette can be erased even if the record-prevention tabs have been removed.

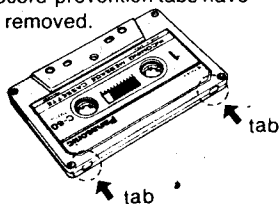

How to Adjust Time

Press the Function and Set buttons with a pointed object such as a ball point pen.



- Hour digits will flash.
FUNCTION
- to adjust the "Hour".
SET
- Minute digits will flash.
FUNCTION
- to adjust the "Minute".
SET
- ":" will flash.
FUNCTION
- to adjust the "Day".
SET • Day will be announced.
- to complete adjustment.
FUNCTION

• The unit will announce the day and time.

■ To confirm, .
Push

• The unit will announce the day and time.

- When completing the adjustment, push the according to the time signal to set the 0 second.
- Lightly depressing the forwards one digit.
- Holding down of the fast forwards digits.
- The programmed real time can be stored up to about 4 hours during a power failure.
- The accuracy of the clock will be approximately ± 45 seconds a month at 0° to 40°C of room temperature.

How to Operate from Remote Phone

You can listen to the received Incoming messages from a remote location with a tone telephone.

How to Set the Remote Code

Example: 86
(on the bottom of the unit)

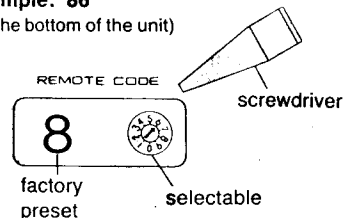

- Code No. is two digits.
- Do not use No. 7 as code No.

■ The Quick Reference Card (spare) for tone remote control can be found on page 16.

To Set/Cancel the Answer Mode

If you forgot to set or want to cancel the Answer mode:

■ To set



DIAL THE PHONE NO. TO WHICH THE UNIT IS CONNECTED

WAIT FOR 15 RINGS

OGM WILL BE HEARD

• The unit will play back the Outgoing message and then you may hang up the

■ To cancel



DIAL THE PHONE NO. TO WHICH THE UNIT IS CONNECTED

PUSH CODE NO. (2 digits) DURING THE OGM

2 • The unit will not pick up any calls.
Push

Toll Saver

Set the Ring Selector to "AUTO"; If you call from a remote location and the unit does not pick up on the third ring, hang up. This means no calls have been recorded and you will not be required to retrieve and pay toll charges.

• Pick-up on the second ring: At least one message has been recorded.

• If does not pick-up on the third ring: No messages have been recorded. So hang up.

■ After you have played back all the messages from a remote phone;

• Pick-up on the second ring in the next call: At least one new message has been recorded. The unit will announce the number of the newly recorded messages.

• If no pick-up occurs on the third ring, no messages have been recorded.

How to Operate from Remote Phone (cont.)

How to Operate from Remote Phone (cont.)

Message Playback

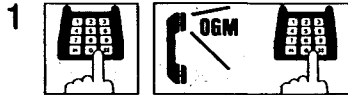

DIAL THE PHONE NO. TO WHICH THE UNIT IS CONNECTED

PUSH CODE NO. (2 digits) DURING THE OGM

- 1

 - The unit will announce the number of the received messages.
 - The unit will rewind the tape with voice even at tape end and play back all the received incoming messages automatically from the beginning of the tape.
 - "End of final message" will be announced after the last message.
 - If "End of tape" is announced, the ICM tape is full. Reset the ICM tape. See "Remote Reset".

2 Hang up.

- Future Incoming messages will be recorded after the last message.

Skip Forward and Back Space

- To skip forward the tape: Push **ABC 2**
- To rewind the tape: Push **1**
- The tape will skip forward or rewind for approximately 15 seconds corresponding to playback time.

Memory Playback

When you have already heard the messages from a remote phone, you can skip them and listen only to the newly recorded messages.



DIAL THE PHONE NO. TO WHICH THE UNIT IS CONNECTED

PUSH CODE NO. (2 digits) DURING THE OGM

- 1
- 2 Push **GHI 4** right after you hear the announcement of the number of the received messages.
 - The unit will play back the new messages.
 - Even during the playback of the previously heard messages, you can skip them by pushing **GHI 4**.

Remote Reset

To record Incoming messages from the beginning of the tape.

- After the received messages are played back or while they are playing;
- The unit will rewind to the beginning of the tape.



After you have used the Memory Playback;

1. Push **DEF 3**
 - The unit will rewind to the beginning of the newly recorded messages and a beep will be heard.
2. Push **DEF 3** again to go to the beginning of the ICM tape.

- To cancel: Push the **2** after a beep is heard.

Monitoring Room Sound

To monitor a conversation or sound from a room where the unit is installed.



DIAL THE PHONE NO. TO WHICH THE UNIT IS CONNECTED

PUSH CODE NO. (2 digits) DURING THE OGM

- 1
- 2 Push **JKL 5** right after you hear the announcement of the number of the received messages.

- You can listen for 30 seconds.
- To listen further, push the **JKL 5** again within 10 seconds of hearing one beep.

Recording a Marker Message

After hearing all messages, you can leave your index message on the tape.

The day and time will be stamped automatically at the end of your message.

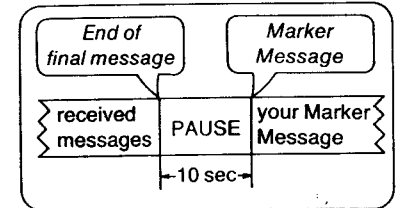

"End of final message" will be announced after all the recorded messages have been played back.

- 1 Start to talk right after "Marker Message" is announced.
- 2 When finished, hang up.

How to Operate from Remote Phone (cont.)

How to Change the Outgoing Message

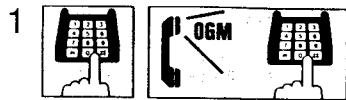

DIAL THE PHONE NO. TO WHICH THE UNIT IS CONNECTED

PUSH CODE NO. (2 digits) DURING THE OGM

2  right after you hear the announcement of the number of the received messages.

- Short beeps will be heard continuously until the OGM tape has reset and then a long beep will be heard.

3 Speak clearly and loudly after you hear the long beep.

4 When finished,  Push

- The new Outgoing message will be played back. So you can check or amend it.

If you pause for over 2 seconds while recording, the unit will sound 6 beeps and announce "Please record your Outgoing message again." If this happens, repeat from step 2.

OGM Skip

If you or a friend do not want to hear the Outgoing message, the machine can be switched promptly to the Incoming message mode.



DIAL THE PHONE NO. TO WHICH THE UNIT IS CONNECTED

PUSH '* *' DURING THE OGM

2 Speak clearly and loudly after you hear the long beep to record the Incoming message.

- You can leave your message on the tape by using the OGM Skip procedure even if you have set the Recording time selector to the "ANNOUNCE" position. At this time, you have 1 minute to leave your message.

Notes:

- In some areas, a remote tone phone may not function due to telephone line conditions such as line noise, echo, etc.

- The unit may not respond if a push tone telephone produces tones that are too short to activate.

Liquid Crystal Display

Display Type	When the display shows
AM 10:30 (Real Time)	• When you set the Power Switch to "OFF".
OGM 0 25 (Tape Timer)	• While you are recording or playing back the Outgoing message. example: "25" means 25 seconds elapsed.
MESSAGE 12 (Message Counter)	Recording Time Selector is set to "1 MIN or VOX". The display will show the number of recorded messages.
CALL 18 (Call Counter)	Recording Time Selector: ANNOUNCE The display shows the number of calls received.
E (Error)	• When the OGM tape is broken or not inserted. • When there is more than a 2-second pause in the recording of the OGM.
--	• After plugging the AC Adaptor into the unit at the initial use. • When power is restored after a power interruption.

Announcements by the Unit

Announcement Type	When the announcement is said
Monday seven o'clock AM	<div style="display: flex; align-items: center;"> <div style="border: 1px solid black; padding: 2px; margin-right: 5px;">Display shows</div> <div style="margin-right: 10px;"> AM 7:00 PM 12:00 PM 6:15 </div> <div> • When you push the Announce button. </div> </div>
Sunday twelve o'clock PM	
Wednesday six fifteen PM	
Number of messages received twelve (12 messages are recorded.)	• When you push the playback button. • When you push your Code No. on a remote phone to play back the recorded message.

Cassette Tapes

- For optimum sound quality and performance, we recommend you to **replace the OGM and the ICM cassette tapes every six months** and to **re-record the outgoing message every three months** supposing that the unit answers calls about ten times every day.
- Never place a cassette tape near a magnetic source, such as a magnet or a TV set, because this will affect the tape quality.

Cassette Tape (C-60) for the Incoming Messages

- Should the Incoming Message cassette tape break or become worn, replace it with a high quality "NORMAL" tape. Use Panasonic (C-30, C-60, C-90), TDK or MAXELL cassette tape. Metal or chrome tape cannot be used.
- Slack in the tape can be tightened by rotating the tape reel with a pencil, as shown:

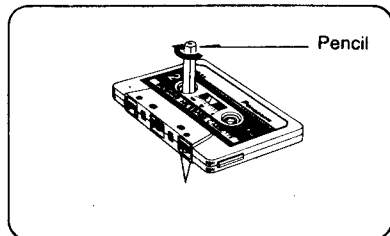

- Do not use C-120 tape to prevent the tape from sticking.

Endless Cassette Tape (KX-C030) for the Outgoing Message

- A sensing foil (silver) is attached to the endless tape. If the sensing foil does not contact the sensing switch, the endless tape will not stop automatically, and it is probably worn or cracked. Replace it with a new Panasonic endless cassette tape (KX-C030).
- Observe carefully that the tape and capstan are located as shown below, and insert the endless tape into the machine.

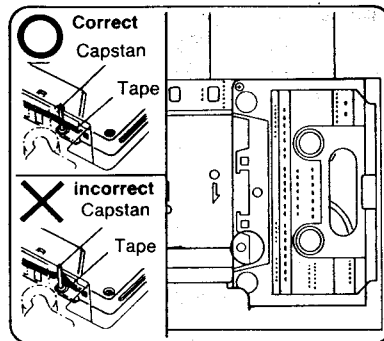

The following endless cassette tapes can also be used with this unit:

- KX-C010 • KX-C020

Maintenance

Because the head and capstan assemblies are in contact with the tape, dirt and residue from the tape can easily adhere to these parts, causing distortion. These parts should be cleaned periodically in the manner described below:

- **Clean the head surfaces, sensing switch, pressure rollers and capstans with a cotton swab.** If these surfaces are extremely dirty, dampen the cotton swab with alcohol.

Notes:

- Do not bring magnetic or metal objects, such as a screwdriver, near the head assemblies, as such objects could magnetize the heads.
- Do not oil any part of the unit.

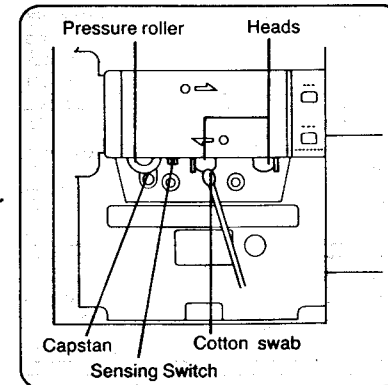

Others

- If there is trouble, disconnect the unit from the telephone line. When the telephone is connected to the EASA-PHONE, disconnect the telephone from the EASA-PHONE and plug the telephone directly into the telephone line. If the telephone operates properly, do not reconnect the unit to the line until the trouble has been repaired by an authorized Panasonic Factory Service Center. If the telephone does not operate when the unit is disconnected, chances are that the trouble is in the telephone system, and not in the unit.
- Do not use benzine, thinner, or similar solvents. Do not use abrasive powder to clean the cabinet. Wipe it with a soft cloth.
- Keep the unit away from heating appliances and electrical noise generating devices such as fluorescent lamps, motors and television. These noise sources can interfere with the performance of the EASA-PHONE.
- This unit and the cassette tapes should be kept free of dust, moisture, high temperature and vibration, and should not be exposed to direct sunlight.
- Never attempt to insert wires, pins, etc. into the vents or other holes of this unit.

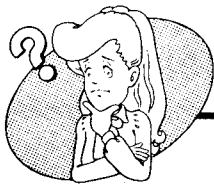

Troubleshooting Guide



Problem

Cause & Remedy

•The unit will not work when I push any buttons.
•I cannot remove the cassette from the unit.

Unplug the AC adaptor and plug it in again.

The unit has been set to operate as an answering machine, but no incoming messages are recorded.

- The OGM cassette is broken (cut, worn out or twisted). Replace the cassette with a new one.
- The OGM is recorded improperly. Record a new OGM.
- The recording time selector is set to "ANNOUNCE".

The unit does not function. However, a beep sounds 6 times and the answer indicator flashes on and off quickly.

The OGM cassette might be broken. Replace it with a new one. (Refer to the endless cassette tape on page 13.)

When the Outgoing Message or the Incoming Message tape is played back, the sound level is low, even if the Volume Control is turned up fully.

Clean the heads. (See Maintenance instruction on page 14.)

I have played back all the recorded messages and I want to record the next phone call after the last recorded message.

- Wait for 7 seconds. The unit will be ready to record the next phone call.
- In case of remote operation, just hang up.

I push the button of a remote phone, but the unit does not respond.

- Make sure that you are using your own code number.
- Record the outgoing message in a quiet place.

Some incoming messages have not been recorded up to its end.

Set the CPC Switch to the "B". See page 1.

Important Information



If you are required from the Telephone Company, inform the followings.

- FCC Registration No. ACJ96N-19677-AN-N
- Ringer Equivalence 0.4 B
- The particular line to which the equipment is connected

In the event terminal equipment causes harm to the telephone network, the telephone company should notify the customer, if possible, that service may be stopped. However, where prior notice is impractical, the company may temporarily cease service providing that they:

- Promptly notify the customer.
- Give the customer an opportunity to correct the problem with their equipment.
- Inform the customer of the right to bring a complaint to the Federal Communication Commission pursuant to procedures set out in F.C.C. Rules and Regulations Subpart E of Part 68.

The Telephone Company may make changes in its communications facilities, equipment, operations or procedures, where such action is reasonably required in the operation of its business and is not inconsistent with the rules and regulations in F.C.C. Part 68. If such changes can be reasonably expected to render any customer terminal equipment incompatible with telephone company communications facilities, or require modification or alteration of such terminal equipment, or otherwise materially affect its use or performance, the customer shall be given adequate notice in writing, to allow the customer an opportunity to maintain uninterrupted service.

WARNING:
TO PREVENT FIRE OR SHOCK HAZARD, DO NOT EXPOSE THIS PRODUCT TO RAIN OR ANY TYPE OF MOISTURE.

"This equipment has been tested and found to comply with the limits for a Class B computing device in accordance with the specifications set forth in Subpart J of Part 15 of the F.C.C. Rules. If this equipment does cause interference to radio or television reception which can be determined by turning the equipment on and off, use the equipment in another location and/or utilize an electrical outlet different from that used by the receiver."

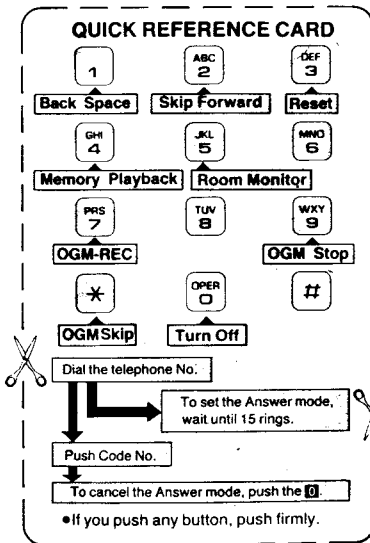

Free Manuals Download Website

<http://myh66.com>

<http://usermanuals.us>

<http://www.somanuals.com>

<http://www.4manuals.cc>

<http://www.manual-lib.com>

<http://www.404manual.com>

<http://www.luxmanual.com>

<http://aubethermostatmanual.com>

Golf course search by state

<http://golfingnear.com>

Email search by domain

<http://emailbydomain.com>

Auto manuals search

<http://auto.somanuals.com>

TV manuals search

<http://tv.somanuals.com>