

Panasonic

CORDLESS TELEPHONE ANSWERING SYSTEM

MODEL NO. **KX-T4300BA**

EASA-PHONE

Pulse-or-tone dialing capability

Operating Instructions



**DYNAMIC
SOUND FOCUS**

Please read before use.

AUTO-LOGIC

Charge the battery for about 10 hours before initial use.

XNZ

Introduction (Features)

Thank you for purchasing the KX-T4300BA, which is an excellent cordless telephone with an answering system. Besides playing back your greeting message and recording callers' messages, it includes the following features.

Telephone features:

- Redialing the last dialed number (p. 19)
- Dialing a stored number from memory (p. 22–25)
- Intercom—Having a conversation between one person using the base unit and another person using the portable handset (p. 26)
- Maintaining the best sound by selecting the clearest channel (p. 28)

Answering system features:

- Listening to recorded messages (p. 33)
- Monitoring an incoming call (p. 35)
- Recording your own message (p. 35)
- Remote operation from a touch tone phone (p. 36)
- Remote operation from the portable handset (p. 45)

Accessories

AC Adaptor
(p. 10)

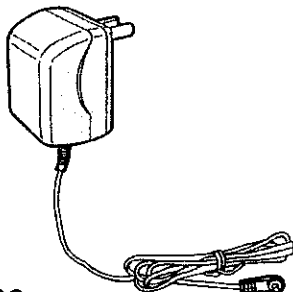

one

Telephone Line Cord
(p. 10)

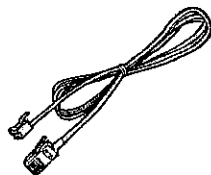

one

Micro Cassette
Tape (MC-30)
(pp. 9, 56)

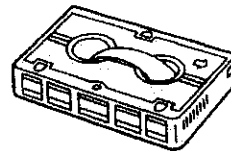

one

Wall Mounting Adaptor
(p. 55)

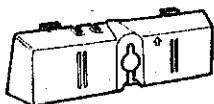

one

Screw
(p. 55)

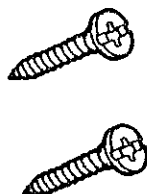

two

Washer
(p. 55)



two

Precaution

To power the portable handset, charge its battery by placing the portable handset on the base unit for about 10 hours before initial use.

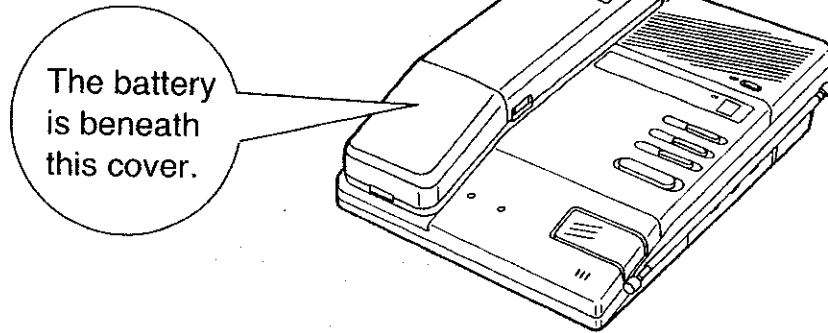

Extend the antennas fully for best performance.

Be careful when extending the rubber antenna, or it may suffer permanent damage.

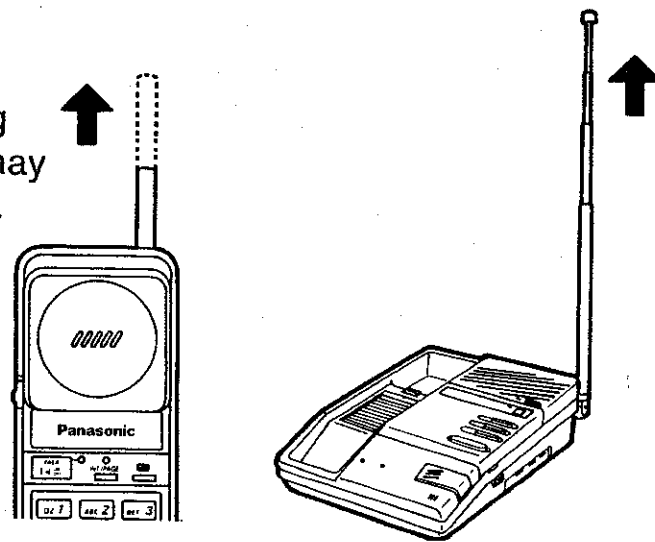

Do not place the unit near electrical appliances or obstacles. This might cause interference or shorten the possible operating range while using the cordless telephone.

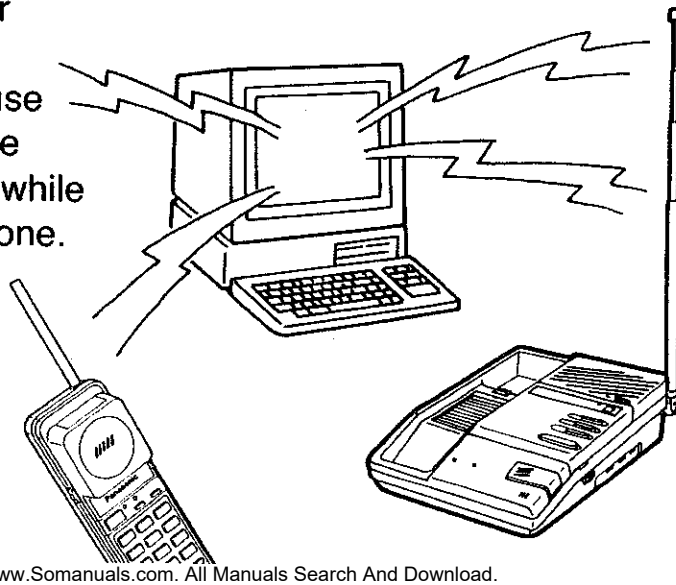

Contents

Location of controls	6
Installation	9
Setting up the unit	9
Recording a greeting message	12
Charging the portable handset battery	14
Setting selectors	15

<Basic operation>	
Making calls	18
Answering calls	20
Automatic dialing	22
Storing phone numbers into memory	23
Dialing a stored number from memory	25
<Advanced operation>	
Intercom between the base unit and the portable handset	26
Other features	28
Selecting the clearest channel	28
FLASH button (To use the hookswitch feature)	29
Using call waiting feature	29
PAUSE button (For users behind a PBX)	29
Temporary tone dialing	29

<Basic operation>	
Turning on the answering system	30
Listening to the recorded messages	32
To listen to messages	33
To rewind/fast forward the tape	34
To reset the tape	34
To save old messages	34
Monitoring an incoming call	35
Recording your own message	35

<Advanced operation>

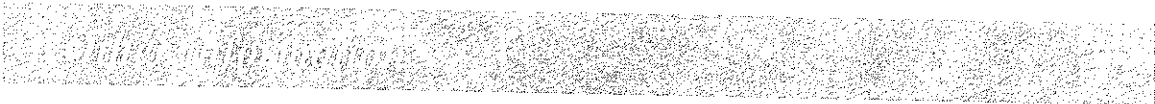
Remote operation from a touch tone phone	36
To play back all messages	38
To play back new messages only	39
To reset the tape	40
To record your own message (Marker message)	41
To monitor the room sound	41
To re-record the greeting message	42
To skip the greeting message (For outside callers)	43
To turn off the answering system	44
To turn on the answering system	44
Remote operation from the portable handset	45
To play back all messages	46
To play back new messages only	47
To reset the tape	48
To record your own message	49
To monitor an incoming call	49
To monitor the room sound	50
To turn off the answering system	51
To turn on the answering system	52
	
The portable handset battery	53
Battery replacement	54
Wall mounting	55
Maintenance	56
Troubleshooting guide	58
Safety instructions	61

Location of controls

Portable handset

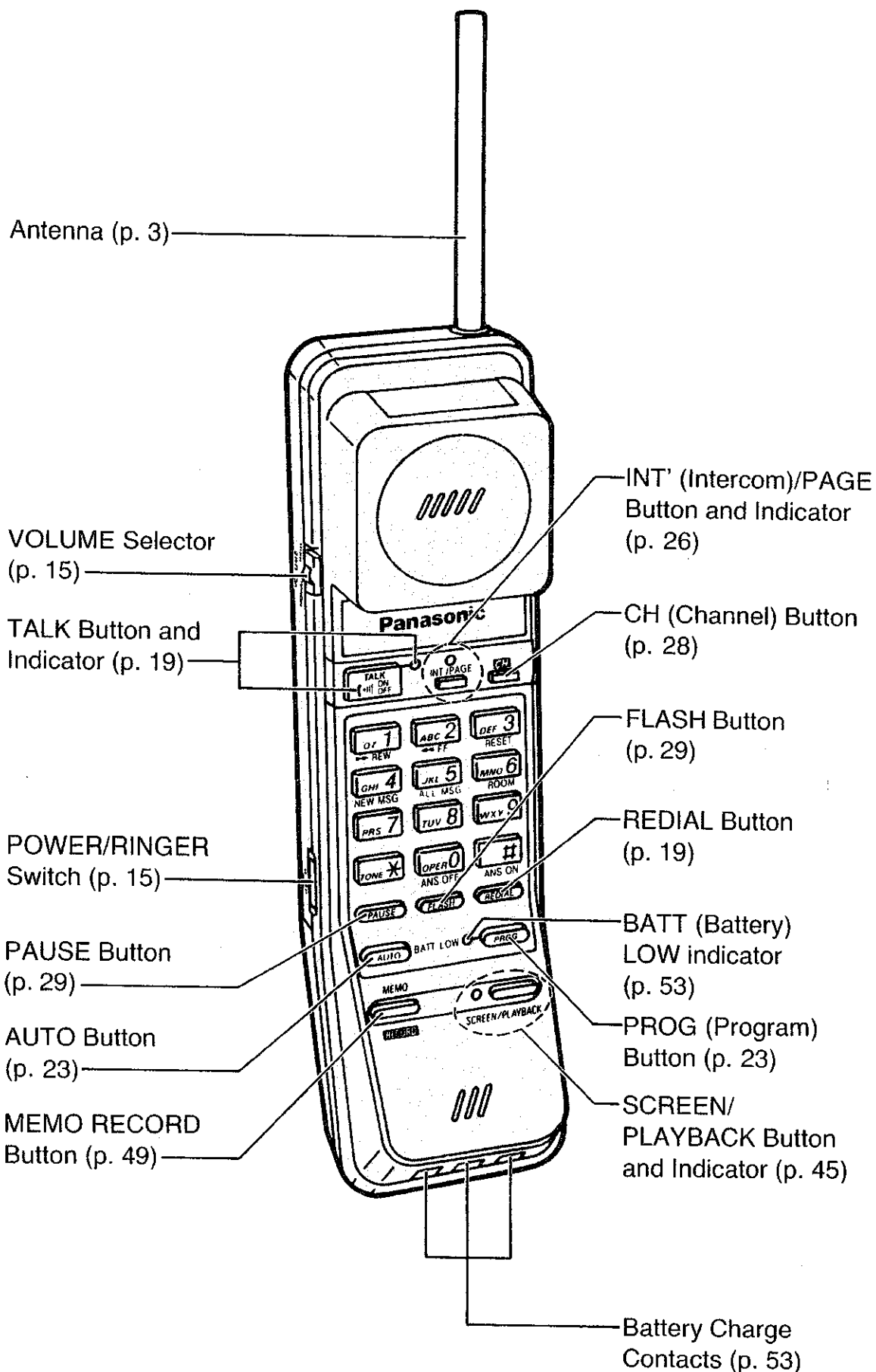

Base unit

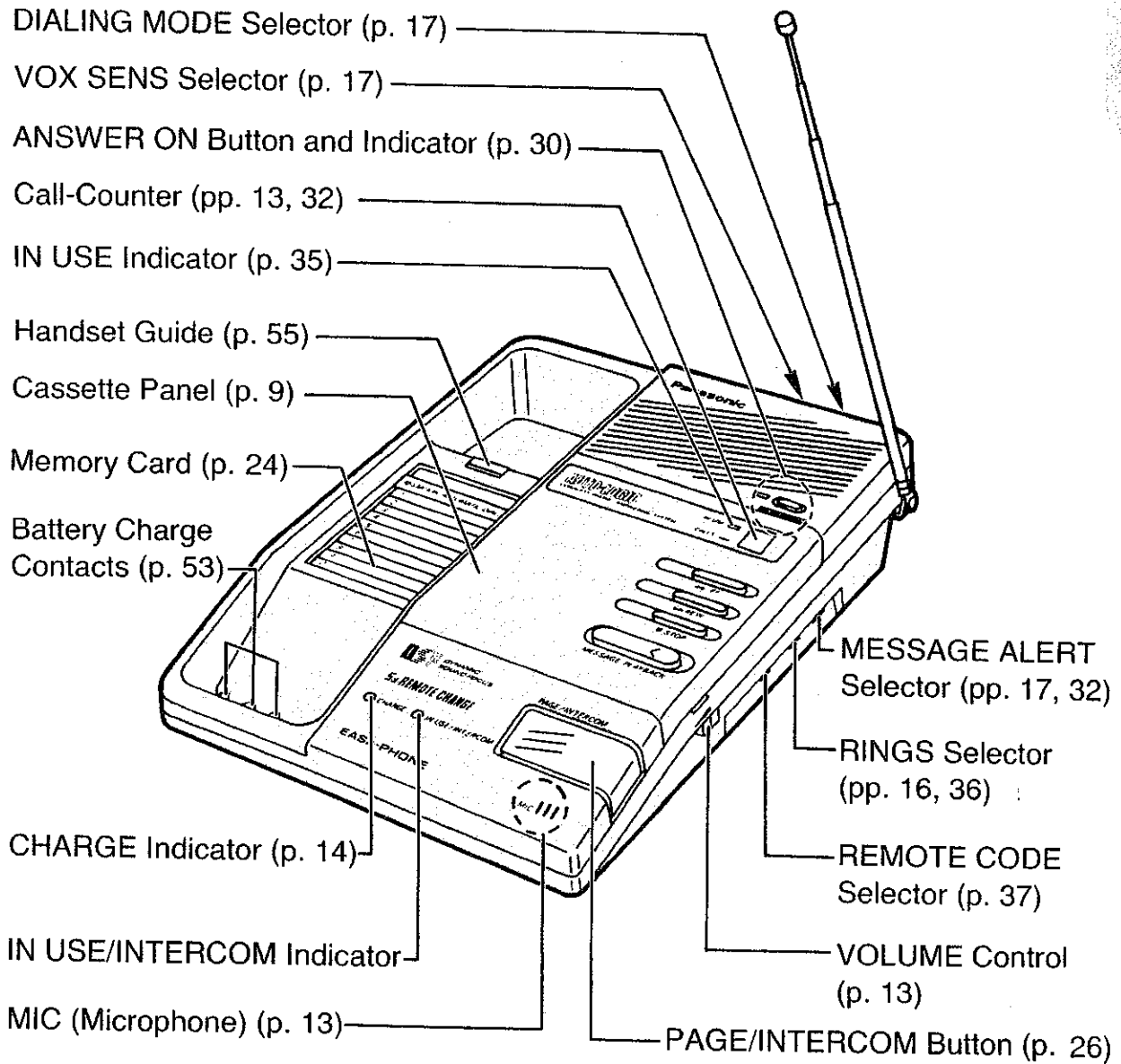

In the cassette panel

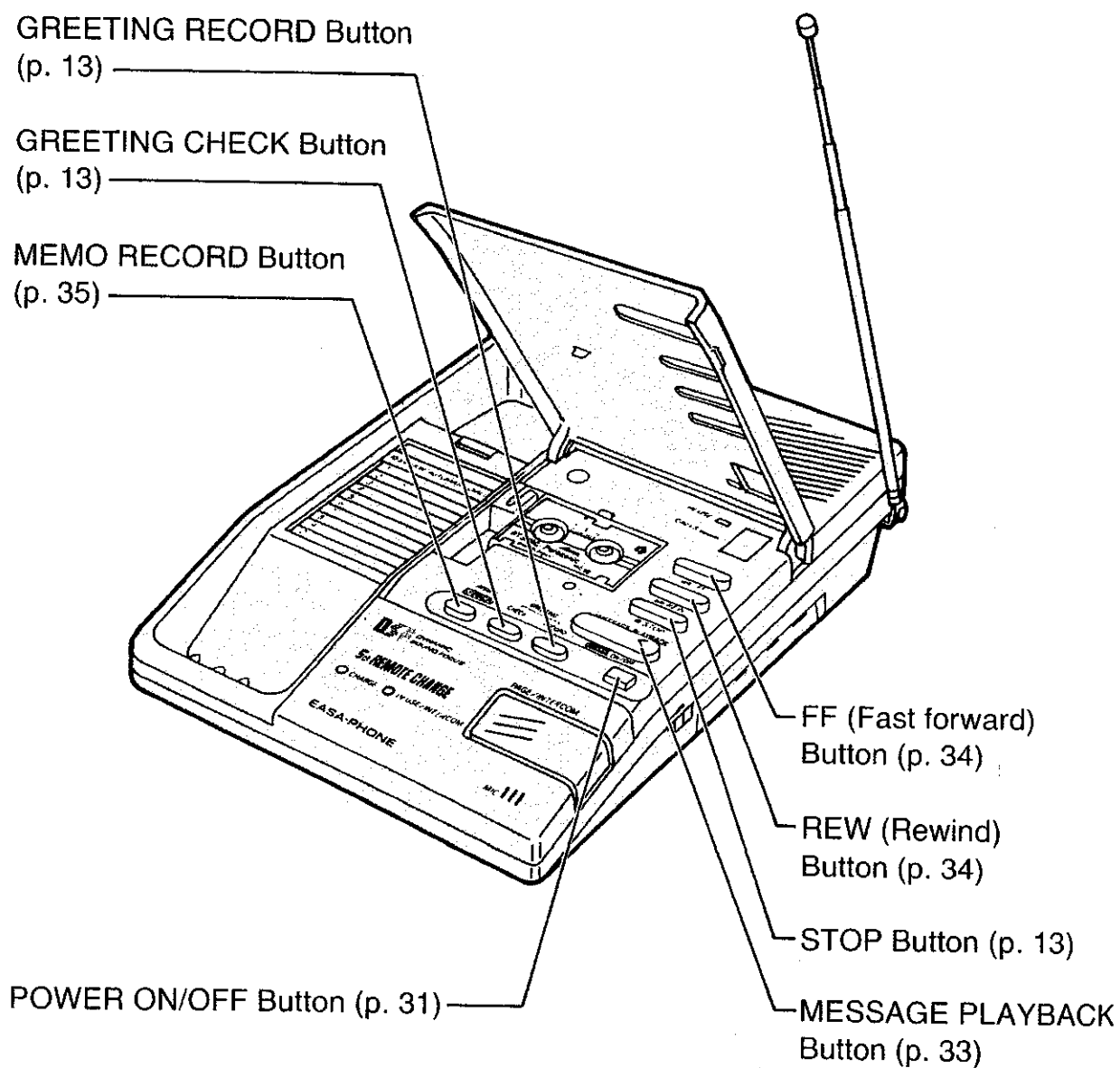

Installation

Please complete the following preparations before use, or the unit will not function properly.

- Setting up the unit. (See below.)
- Recording your greeting message. (See page 12.)
- Charging the portable handset battery. (See page 14.)

Setting up the unit

Be sure to insert the micro cassette tape before connecting the AC adaptor.

To insert the micro cassette tape

1

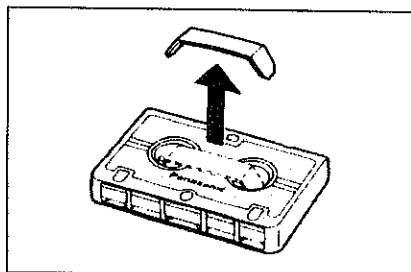

Remove the stopper of the micro cassette tape.

2

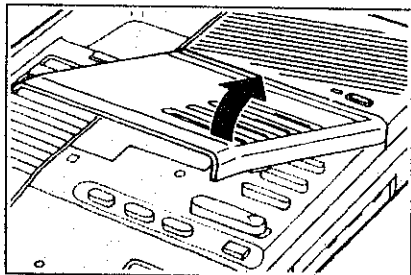

Open the cassette panel.

3

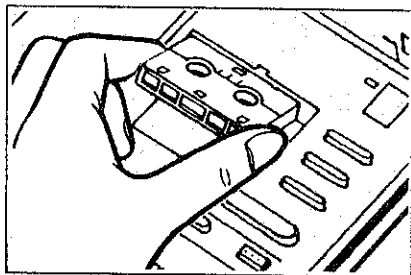

Insert the micro cassette tape with the full reel to the right and the exposed tape facing you.

4

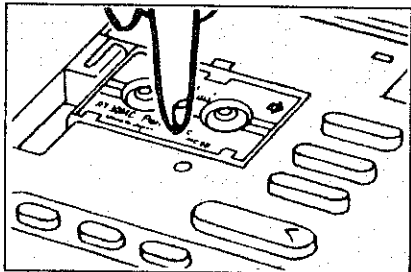

Press down the micro cassette tape.

To connect the telephone line and AC adaptor

Connect as shown.

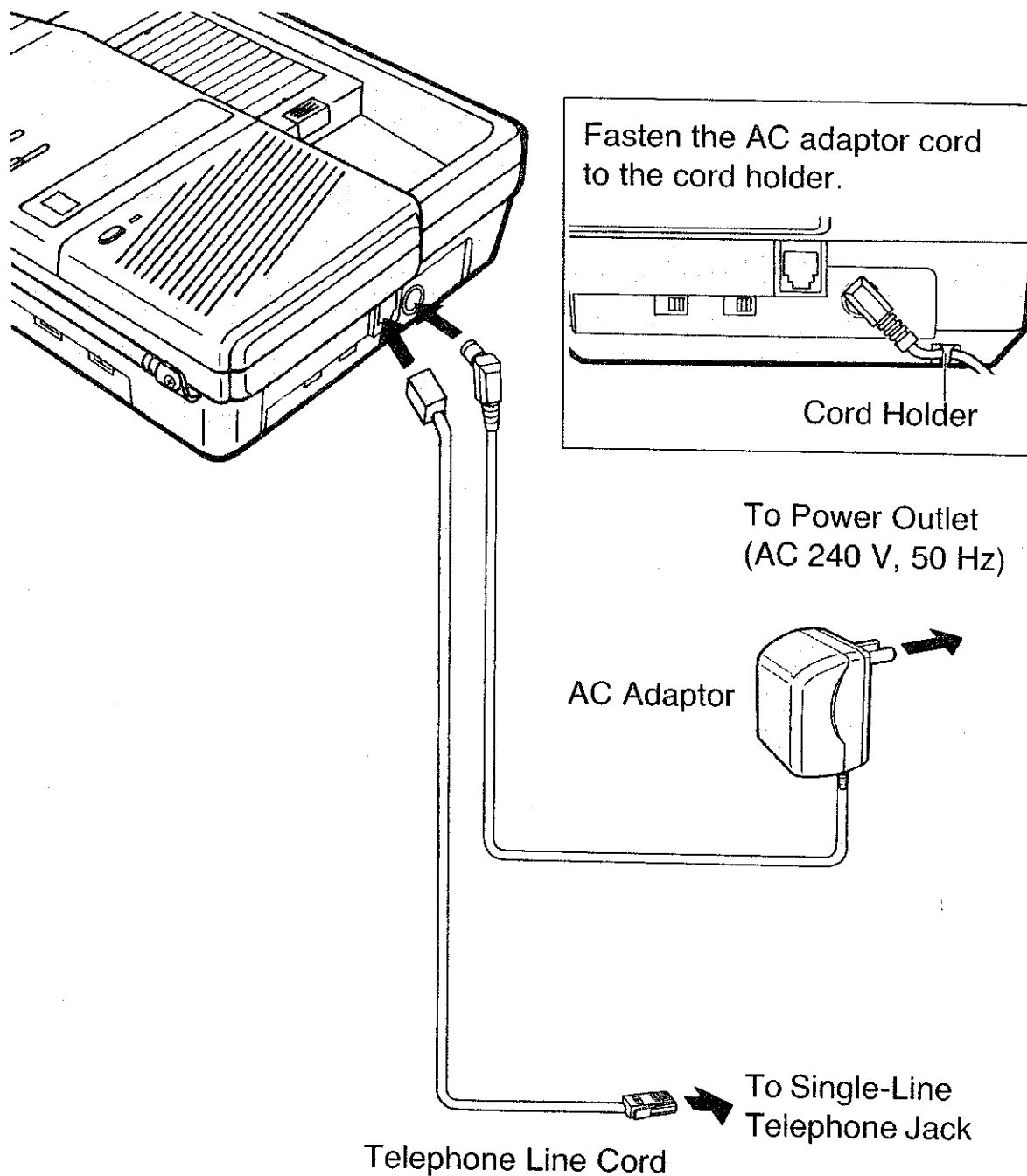

Note:

- For maximum range, place the base unit in a **HIGH AND CENTRAL LOCATION** of the house, with no obstructions.
- USE ONLY Panasonic AC ADAPTOR KX-A11BA.
- The AC adaptor must remain connected at all times.
- The unit will not function during a power failure.

We recommend you connect a reserve telephone (standard telephone) on the same line as power failure protection.

Connection to another telephone

If you connect a reserve telephone (standard telephone) on the same line to guard against a power failure, please purchase a T-adaptor and connect as shown below.

To Single-Line Telephone Jack

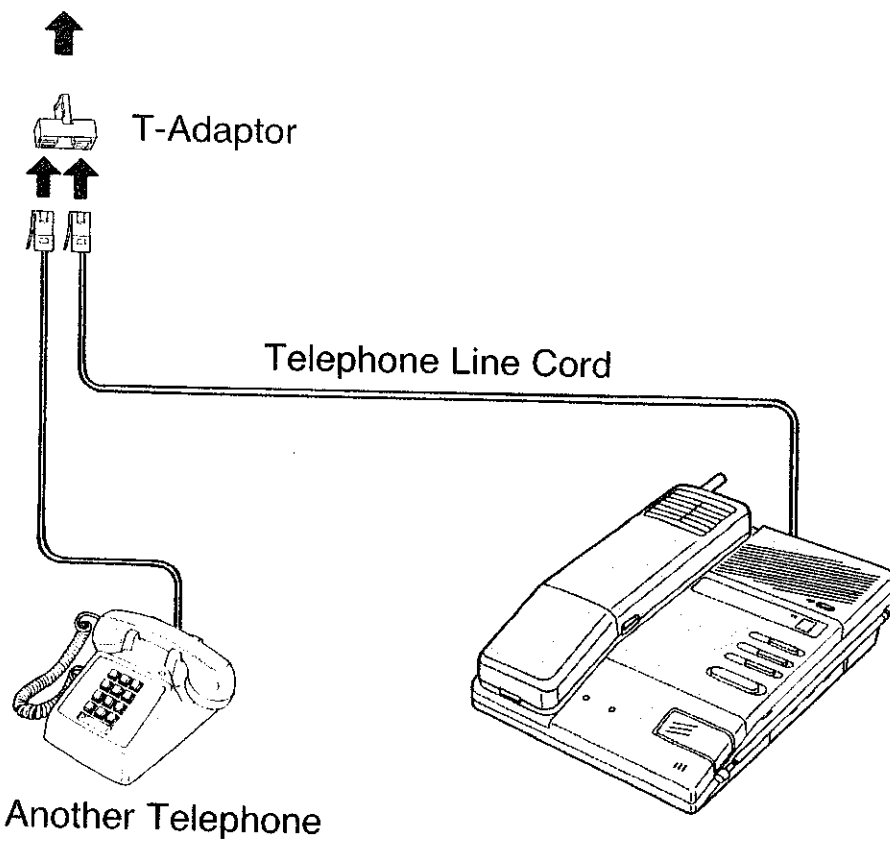

Be sure that the Call-Counter light is on. If it is off, press the POWER ON/OFF button to turn on the power.

Caution:

- The recording time is up to 30 seconds.
- Do not pause for over 2 seconds while recording. If 6 beeps sound and the Call-Counter shows "E" (Error), start over again from step 1 of the following procedure.

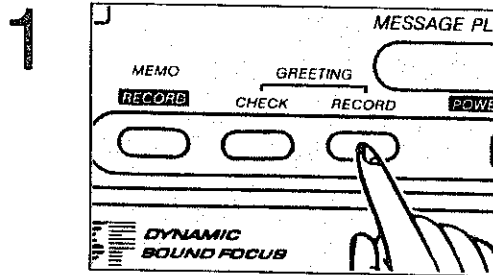

Open the cassette panel and press the GREETING RECORD button.

—A series of short tones will sound, followed by a long beep.

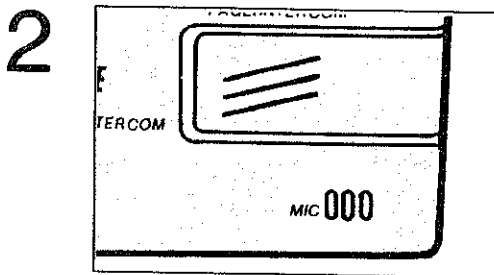

Immediately after the long beep, speak clearly and loudly, 20 cm (8") away from the MIC (Microphone).

—The Call-Counter counts up your recording time.

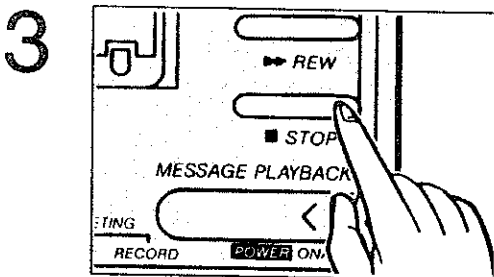

To stop recording, press the STOP button.

To check the greeting message

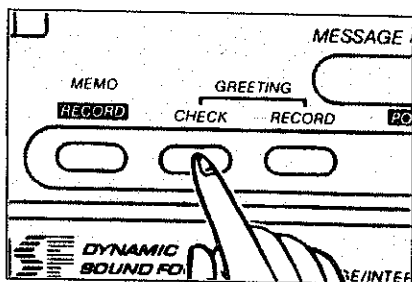

Press the GREETING CHECK button to play back the greeting message.

—Adjust the volume using the VOLUME control on the right side of the base unit.

Note:

- When you want to re-record the greeting message, start over again from step 1.
- When you use the other side of the tape, please record the greeting message again.

Charging the portable handset battery

To power the portable handset, charge its battery before initial use.

Place the portable handset on the base unit for about 10 hours.

The CHARGE indicator light is on.

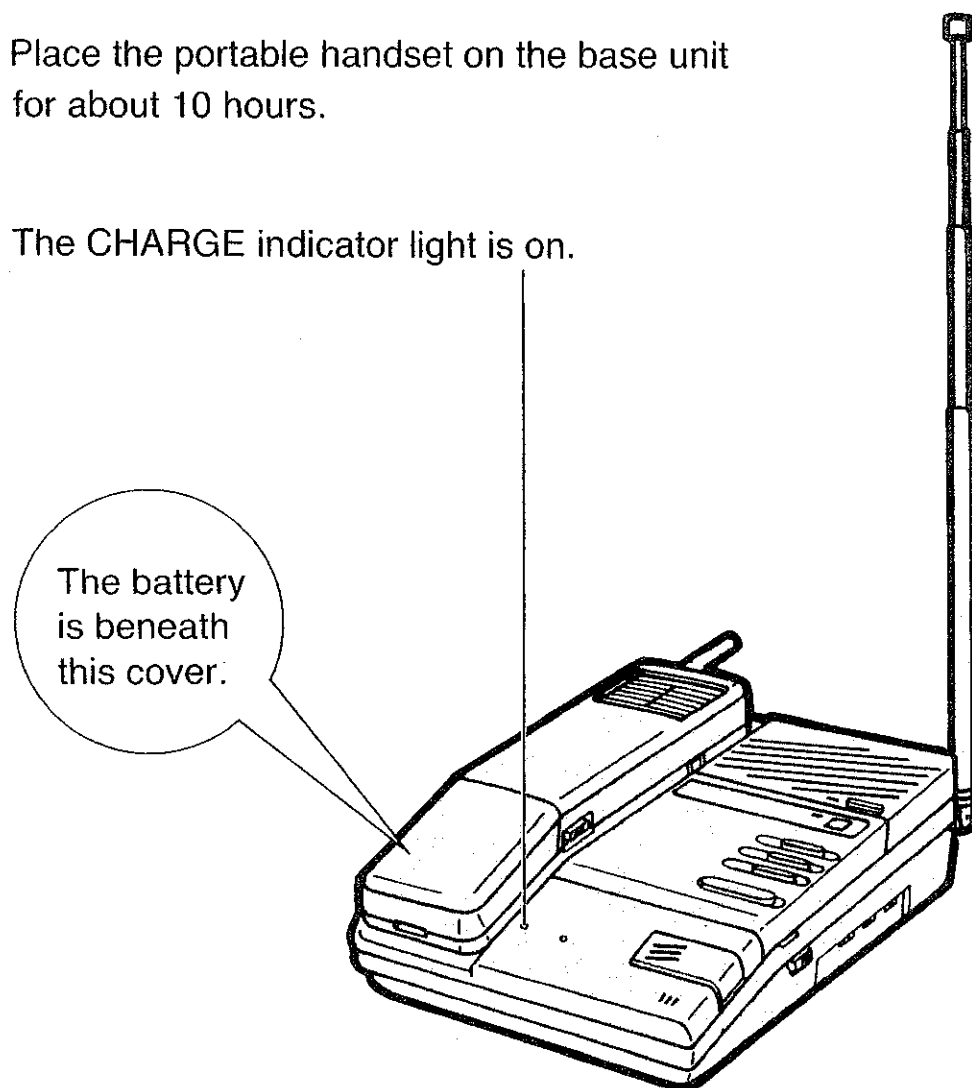

To keep long operation time for every recharge

Panasonic rechargeable battery is Ni-Cd type which keeps best capacity of battery at discharged condition when you recharge it. Therefore, we recommend you to replace the handset on the base unit every few days.

It is important NOT to recharge the battery after every tel-call.

Note:

- Charging is also necessary when the BATT LOW indicator flashes or a beep sounds every 15 seconds during a conversation.
(See page 53.)
- You can charge the battery when the POWER/RINGER switch is set to either the ON or the OFF position.

Setting selectors

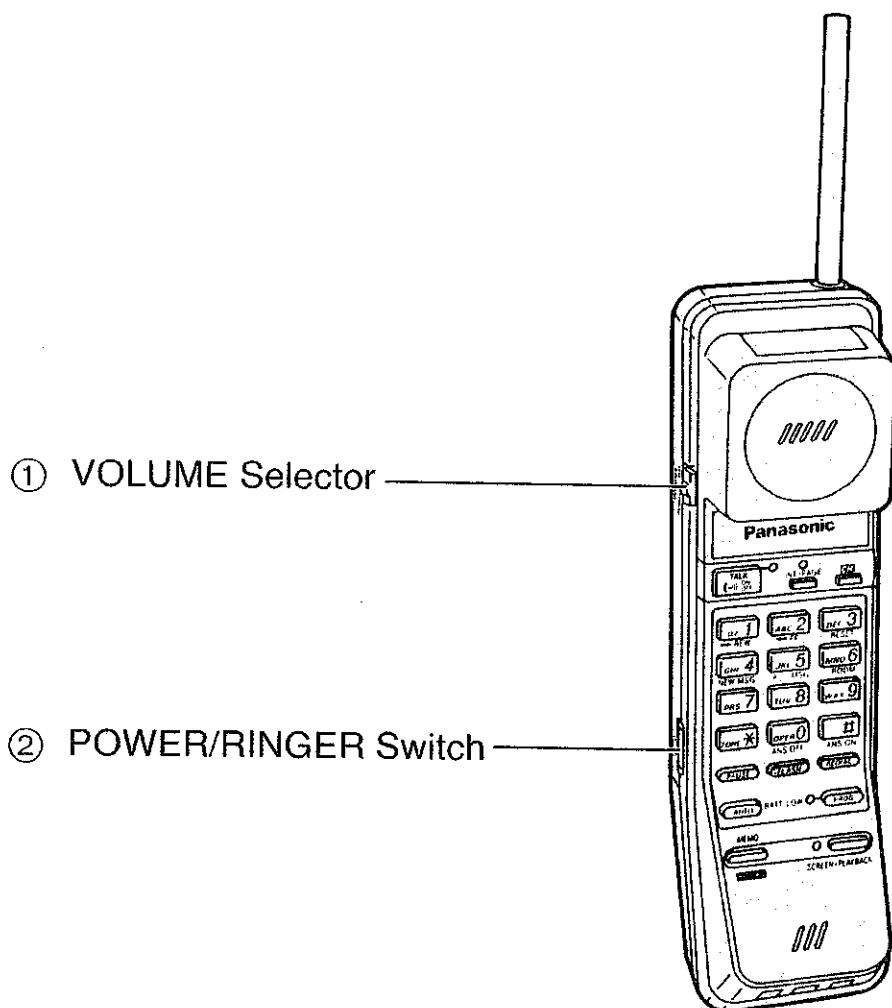

① VOLUME Selector

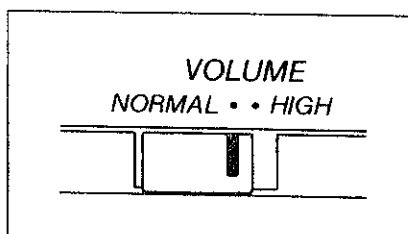

Set to the NORMAL position. When the other party's voice is difficult to hear, set to the HIGH position.

② POWER/RINGER Switch

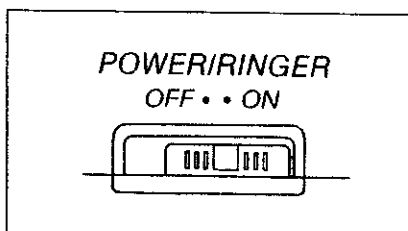

Set to the ON position. When in the OFF position, the battery power will be saved, but the portable handset will not ring.

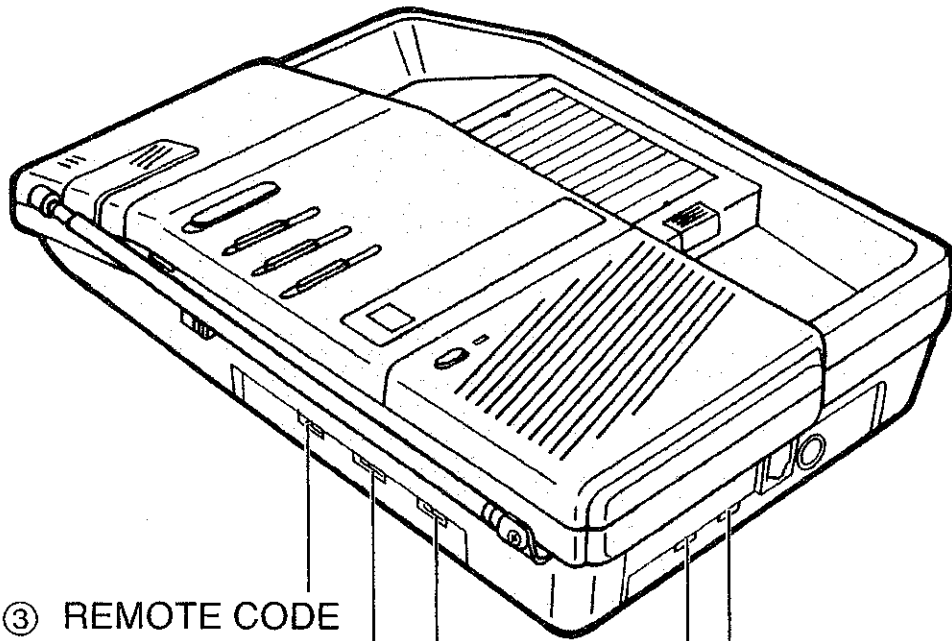

③ REMOTE CODE Selector

④ RINGS Selector

⑤ MESSAGE ALERT Selector

⑥ VOX SENS Selector

⑦ DIALING MODE Selector

③ REMOTE CODE Selector

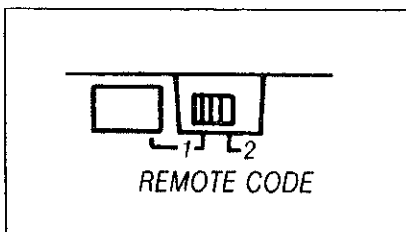

Set the remote code number when operating the answering system from a touch tone phone. (See page 37.)

④ RINGS Selector

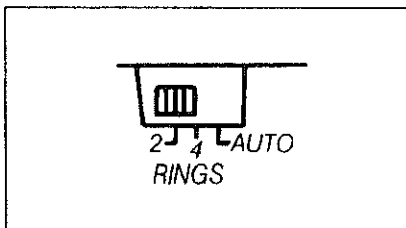

Select the desirable ring number.

2: The unit answers on the 2nd ring.

4: The unit answers on the 4th ring.

AUTO: When you want to use "Toll saver", set to the AUTO position. (See page 36.)

⑤ MESSAGE ALERT Selector

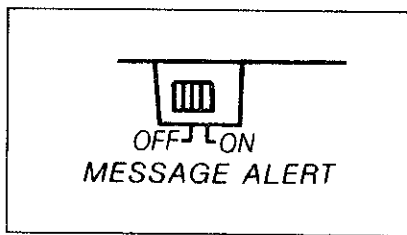

You will know that new messages have been recorded by hearing the beep sound from the base unit.

ON: When new messages have been recorded, a short beep sounds every 10 seconds. The beeping stops after the messages have been played back.

OFF: No beep sounds.

⑥ VOX SENS Selector

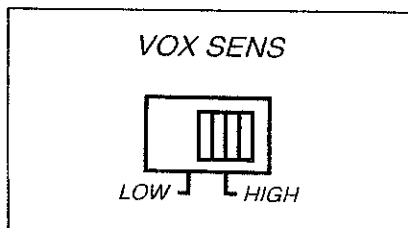

If caller's messages are cut off, the tape continues to run after a caller has replaced his handset, there are long pauses between or after messages, set to the LOW position. (Normally the selector is preset to the HIGH position.)

⑦ DIALING MODE Selector

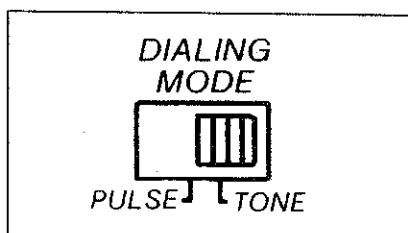

Set to the TONE position when your telephone line has touch tone service. If it has rotary service, set to the PULSE position.

Making calls

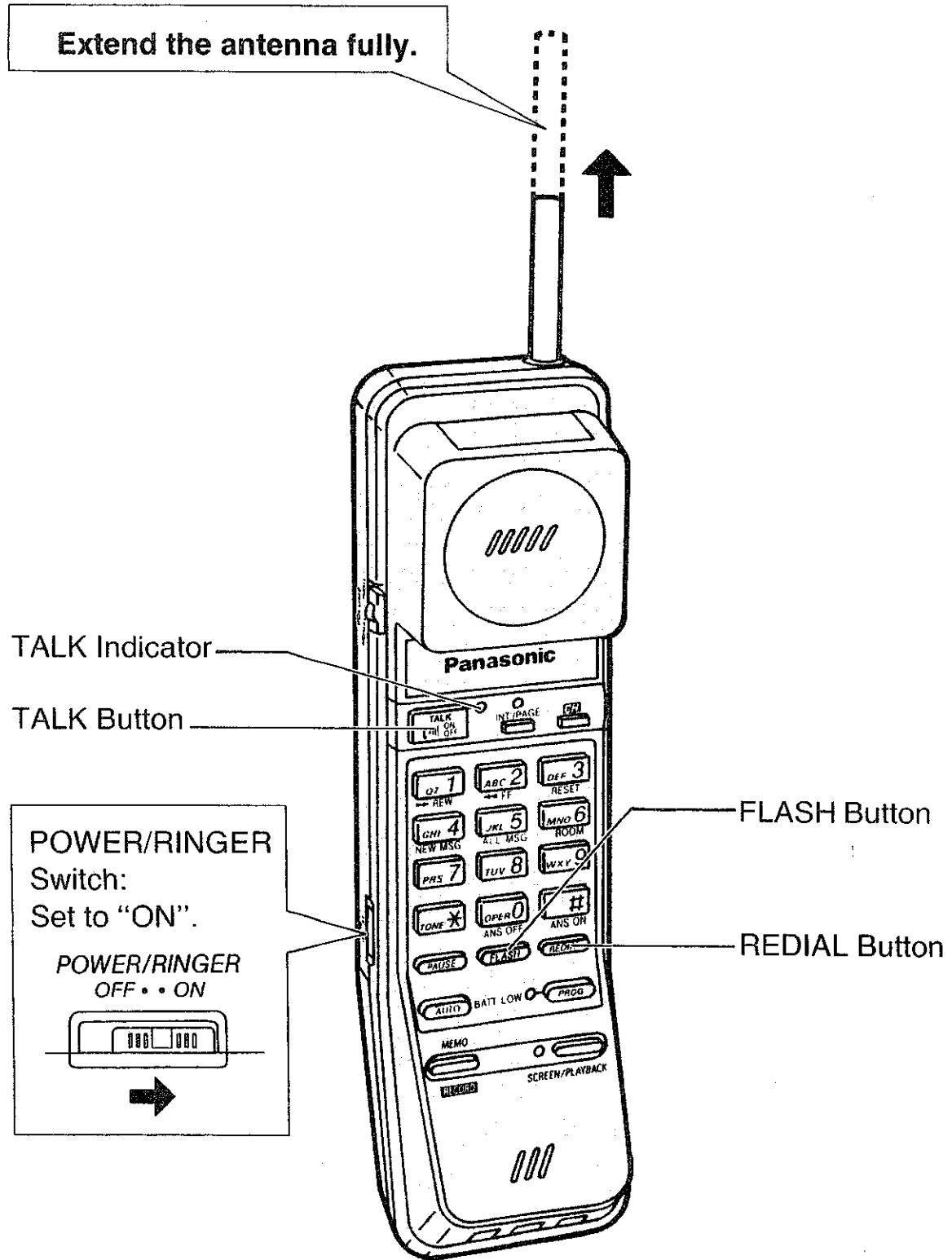

Note:

—If alarm tone sounds when you press the TALK button, approach the base unit or place the portable handset on the base unit. Then try again.

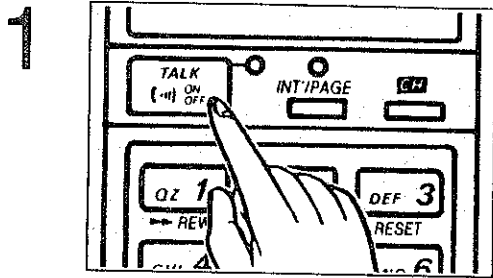

Press the TALK button to get dial tone.

—The TALK indicator light is on.

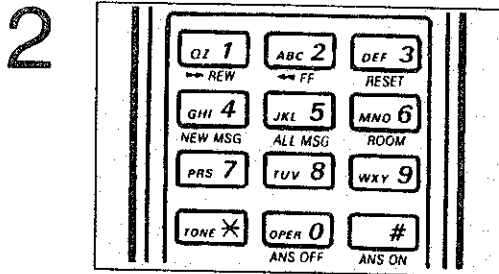

Dial a telephone number.

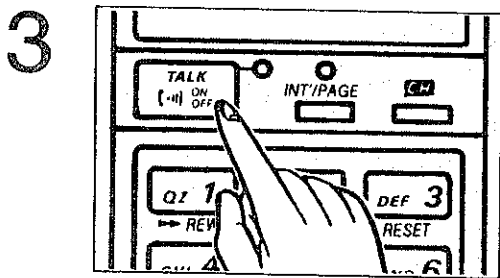

When the conversation is over, press the TALK button or place the portable handset on the base unit to hang up.

—The TALK indicator light goes out.

If you misdial

Press the FLASH button firmly.

The dial tone is heard, and you can dial the correct number.

To redial

Press the TALK button to get dial tone, then press the REDIAL button. The last dialed number is automatically dialed.

Answering calls

Make sure that the POWER/RINGER switch is in the ON position, or the portable handset will not ring.

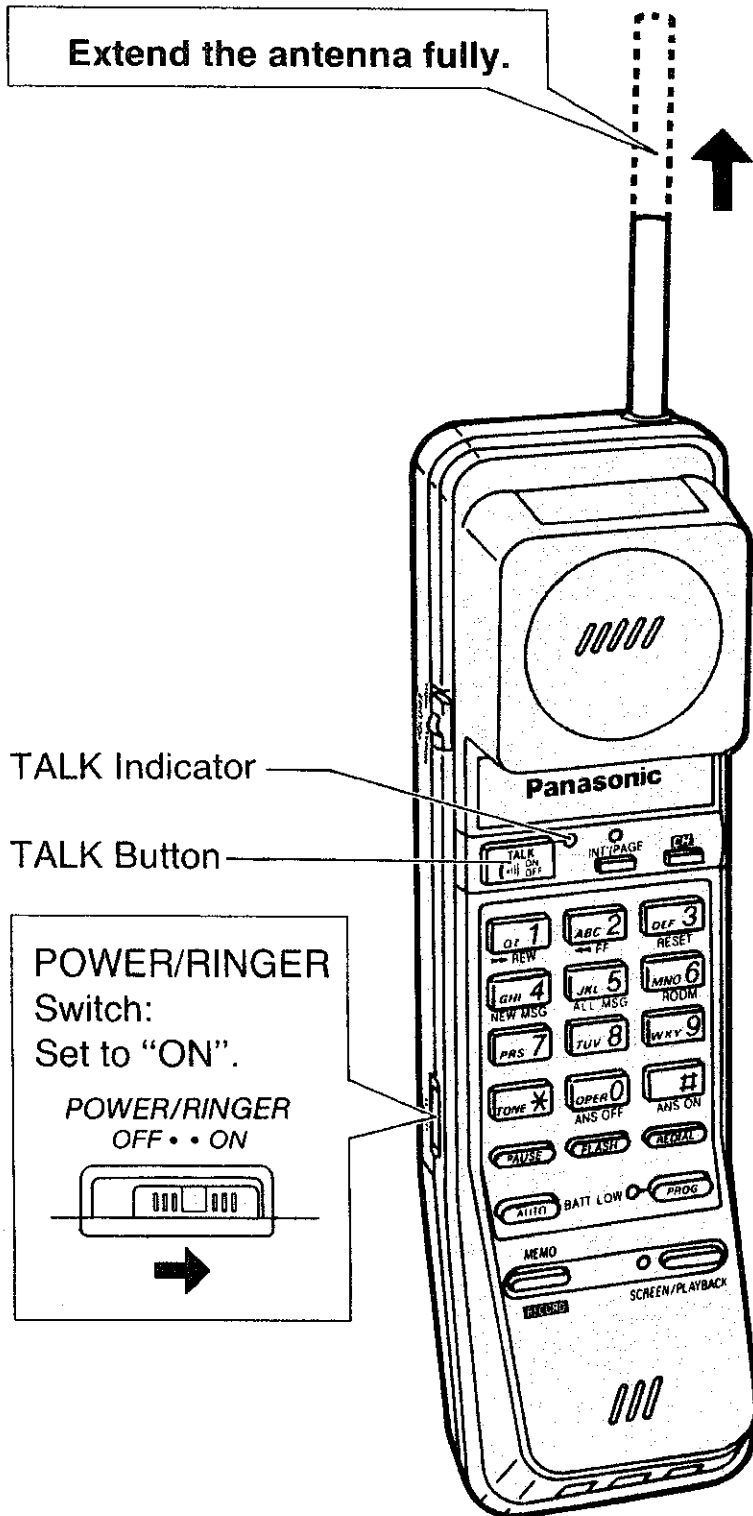

If the portable handset is off the base unit:

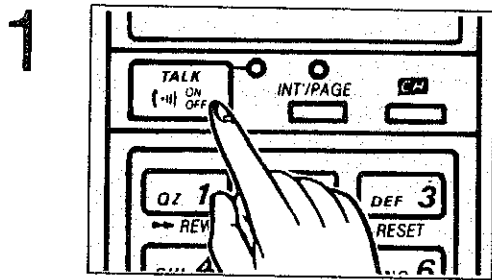

When the telephone rings, press the TALK button to answer the call.

—The TALK indicator light is on.

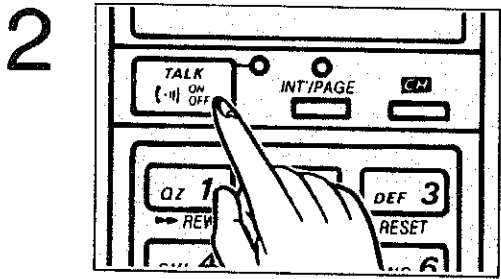

When the conversation is over, press the TALK button or place the portable handset on the base unit to hang up.

—The TALK indicator light goes out.

If the portable handset is on the base unit:

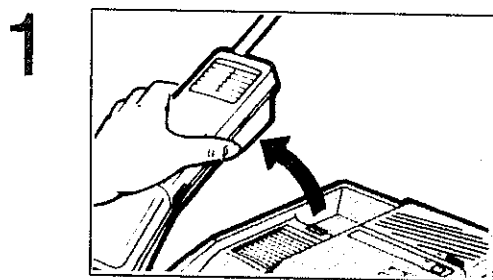

When the telephone rings, pick up the portable handset to answer the call.

—You can talk without pressing the TALK button.

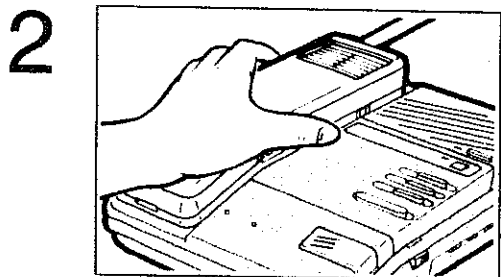

When the conversation is over, place the portable handset on the base unit or press the TALK button to hang up.

Automatic dialing

The unit can store 10 phone numbers, into memory. You can dial a stored number automatically by pressing the AUTO button and one of the dialing buttons.

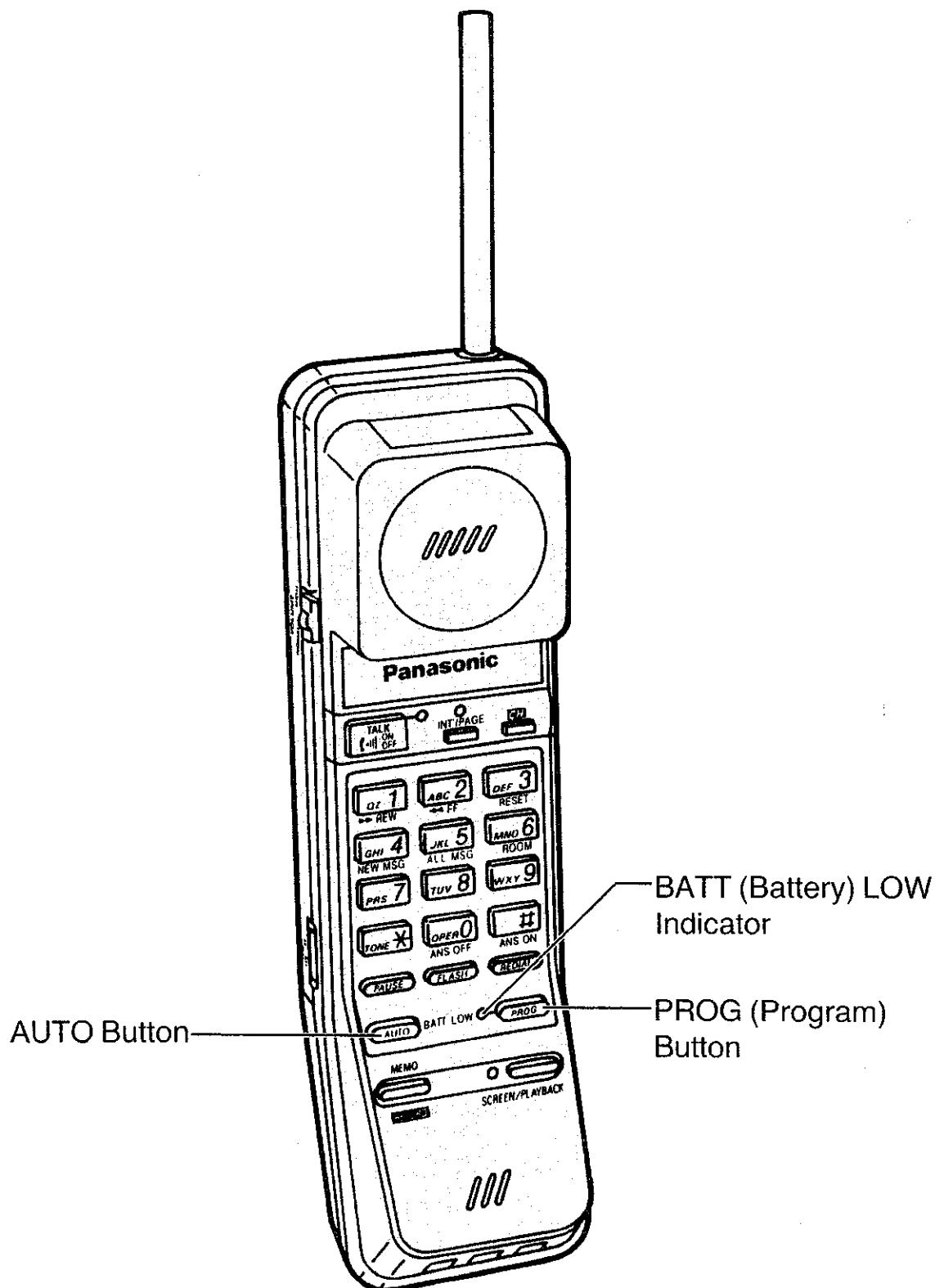

Storing phone numbers into memory

Each dialing button (0 through 9) functions as a memory station for automatic dialing. Each station can store a 16-digit phone number.

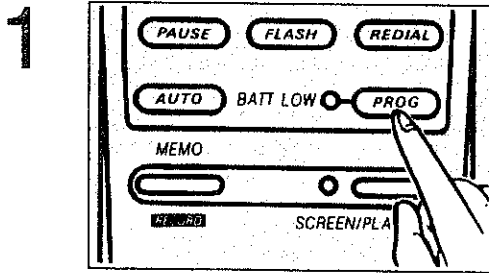

Press the PROG button.

—The BATT LOW indicator light is on to show the unit is in the programming mode.

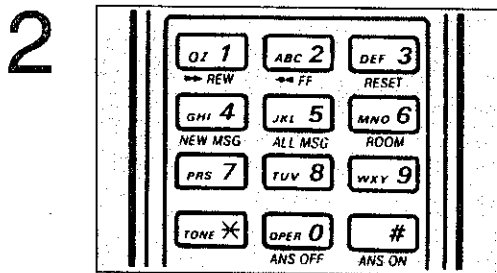

Enter the phone number to be stored up to 16 digits.

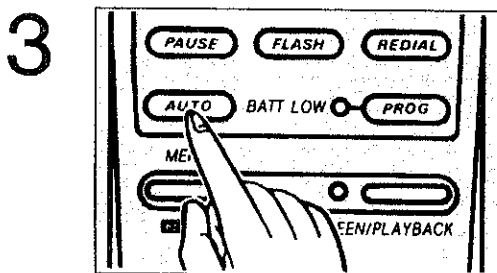

Press the AUTO button.

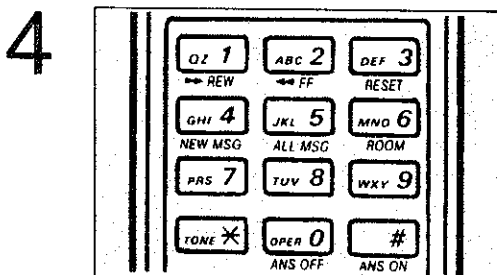

Press one of the dialing buttons (0 through 9) to store the phone number.

—A beep sounds and the BATT LOW indicator light goes out. The phone number is then stored into the memory location.

—To store other numbers, repeat steps 1 through 4.

Basic operation

To correct an error while storing

Press the PROG button to end the programming mode, then start from step 1 on page 23 again to store the correct number.

To confirm a stored number

Store the phone number which you want to confirm into the same memory station. You will hear one or two beeps.

- 2 beeps:** The newly stored number is the same as the previously stored one.
- 1 beep:** The newly stored number is different from the previously stored one.

To erase a stored number

1. Press the PROG button.
2. Press the AUTO button.
3. Press the dialing button of the memory station for the phone number to be erased.

Memory card

Pull out the memory card and write down the names or phone numbers associated with automatic dialing.

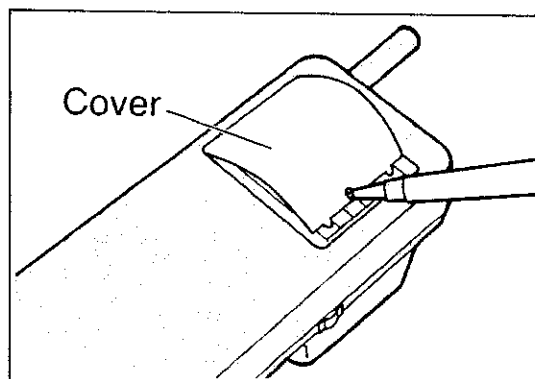
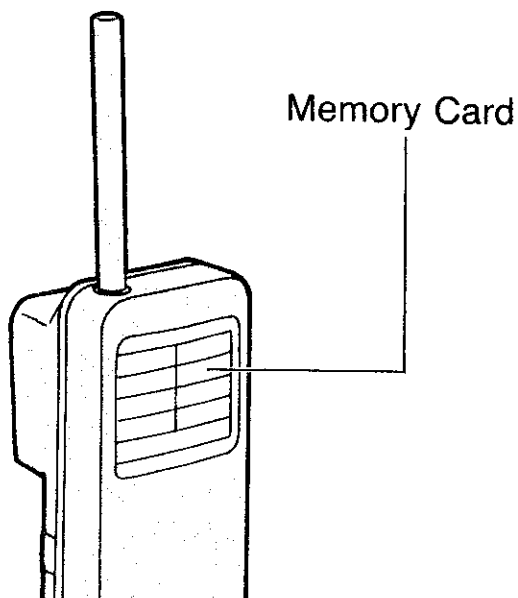

Dialing a stored number from memory

1

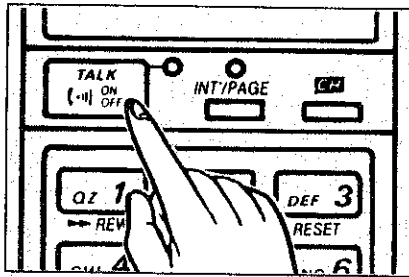

Press the TALK button to get dial tone.

—The TALK indicator light is on.

2

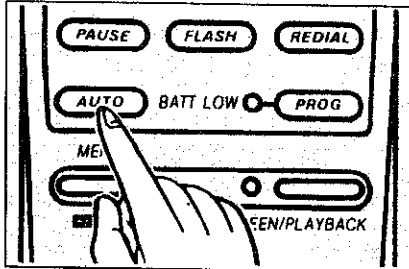

Press the AUTO button.

3

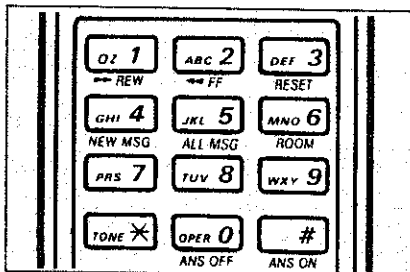

Press the dialing button (0 through 9) where the phone number you want to dial is stored.

—The stored number is dialed automatically.

Intercom between the base unit and the portable handset

You can use the unit as a 2-way intercom between the portable handset and the base unit.

Paging the portable handset from the base unit

1

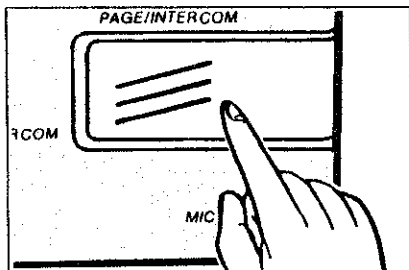

The base unit user:

Press the PAGE/INTERCOM button.

—Both units beep until the portable handset user answers the paging. If there is no answer, press the PAGE/INTERCOM button again to stop the paging.

2

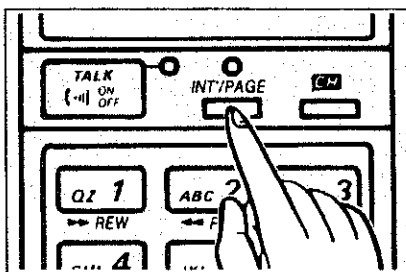

The portable handset user:

When the unit beeps and the INT/PAGE indicator flashes, press the INT/PAGE button to answer the paging.

3

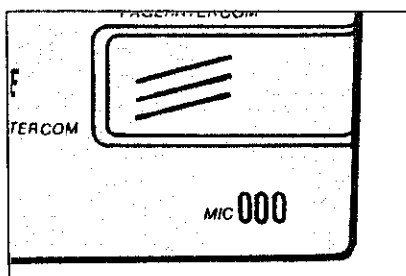

The base unit user:

Speak to the paged party through the MIC (Microphone).

4

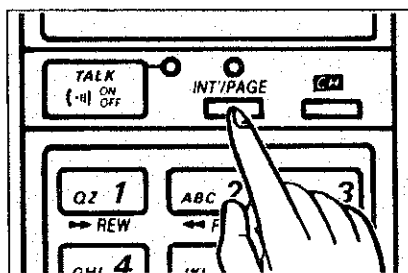

The portable handset user:

When the conversation is over, press the INT/PAGE button.

—Intercom calls can only be terminated by the portable handset.

Paging the base unit from the portable handset

1

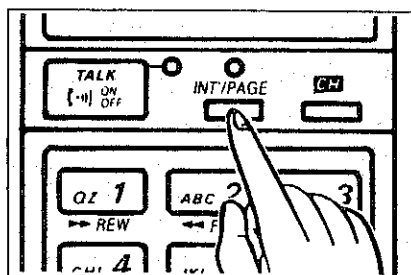

The portable handset user:
Press the INT'/PAGE button.

—Both units beep while the INT'/PAGE button is pressed. When you release the button, the unit automatically switches to the intercom mode. If there is no answer, press the INT'/PAGE button again to end the intercom.

2

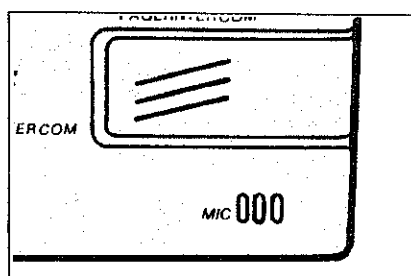

The base unit user:
When the unit beeps and the paging party's voice is heard, answer through the MIC.

3

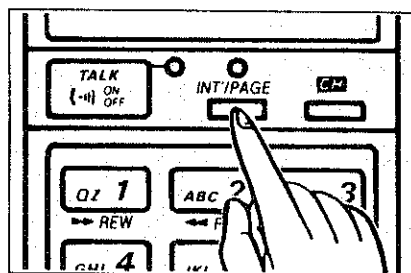

The portable handset user:
When the conversation is over, press the INT'/PAGE button.

—Intercom calls can only be terminated by the portable handset.

Helpful hints:

- Even while in a conversation with an outside caller, the portable handset user can page the base unit user by pressing the INT'/PAGE button. The outside call is put on hold then. To return to the outside call, press the TALK button.
- If you hear two tones while using the intercom feature, it means someone is calling from outside. These two tones replace the normal ringing signal. You can answer the call by pressing the TALK button. The intercom call is then terminated.

Other features

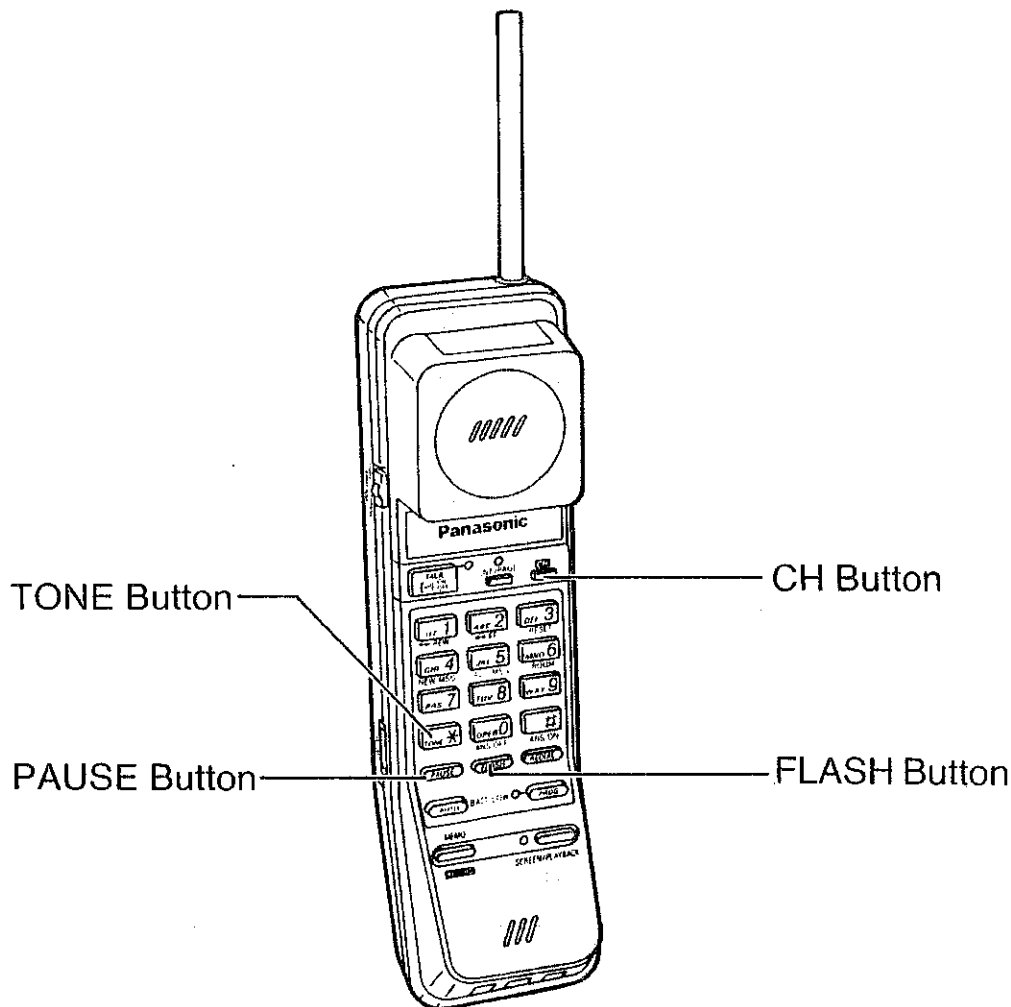

Selecting the clearest channel

A channel is a selected set of receiving and transmitting frequencies. You may select the clearest one of the 5 available channels.

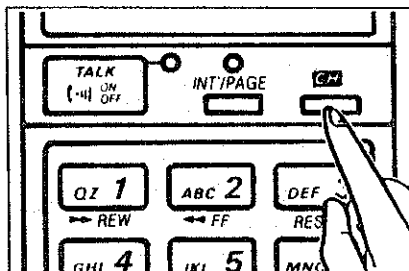

If you hear interference noise while having a conversation, press the CH button.

- Each time you press the CH button, the next channel is selected. Press the CH button repeatedly until the clearest channel is selected.
- The selected channel number is displayed on the Call-Counter.

Note:

- If the portable handset user is too far from the base unit, the CH button does not function fully. Approach the base unit.

FLASH button (To use the hookswitch feature)

The FLASH button functions as the hookswitch on a regular phone. If you misdial or dial another phone number, press the FLASH button firmly. The call is terminated and the dial tone is heard, then you can dial the next phone number.

If your unit is connected to a PBX, pressing the FLASH button lightly allows you to use special features of the PBX such as transferring an extension call.

Using call waiting feature

To use this feature, you are required to subscribe to the call waiting service offered by your local telephone company.

1. While having a conversation, another party calls and you hear a tone.
2. Press the FLASH button lightly.

The first call is put on hold and you can answer the second call. To return to the first caller, press the FLASH button again. The second call is put on hold.

PAUSE button (For users behind a PBX)

If your unit is connected to a PBX, you need to dial an access number (usually 9) to get an outside line. In this case, inserting a pause between the access number and the phone number is necessary especially when redialing or storing the number into memory. Pressing the PAUSE button once makes 3.5-second pause.

Temporary tone dialing

If your line has rotary service, pressing the TONE (*) button allows you to change the dialing mode temporarily into tone. Then you can dial the numbers or codes needed to operate the answering system or to use electronic banking services and other special services.

When you hang up, the dialing mode returns to pulse automatically.

Turning on the answering system

Confirm that the ANSWER ON indicator light is on when you want to use the answering system (e.g. before leaving home).

When the answering system is on, the ANSWER ON indicator light is on and the unit receives an incoming call, plays back the greeting message and records the callers' messages.

Before using the answering system feature, you should record your greeting message. See pages 12–13.

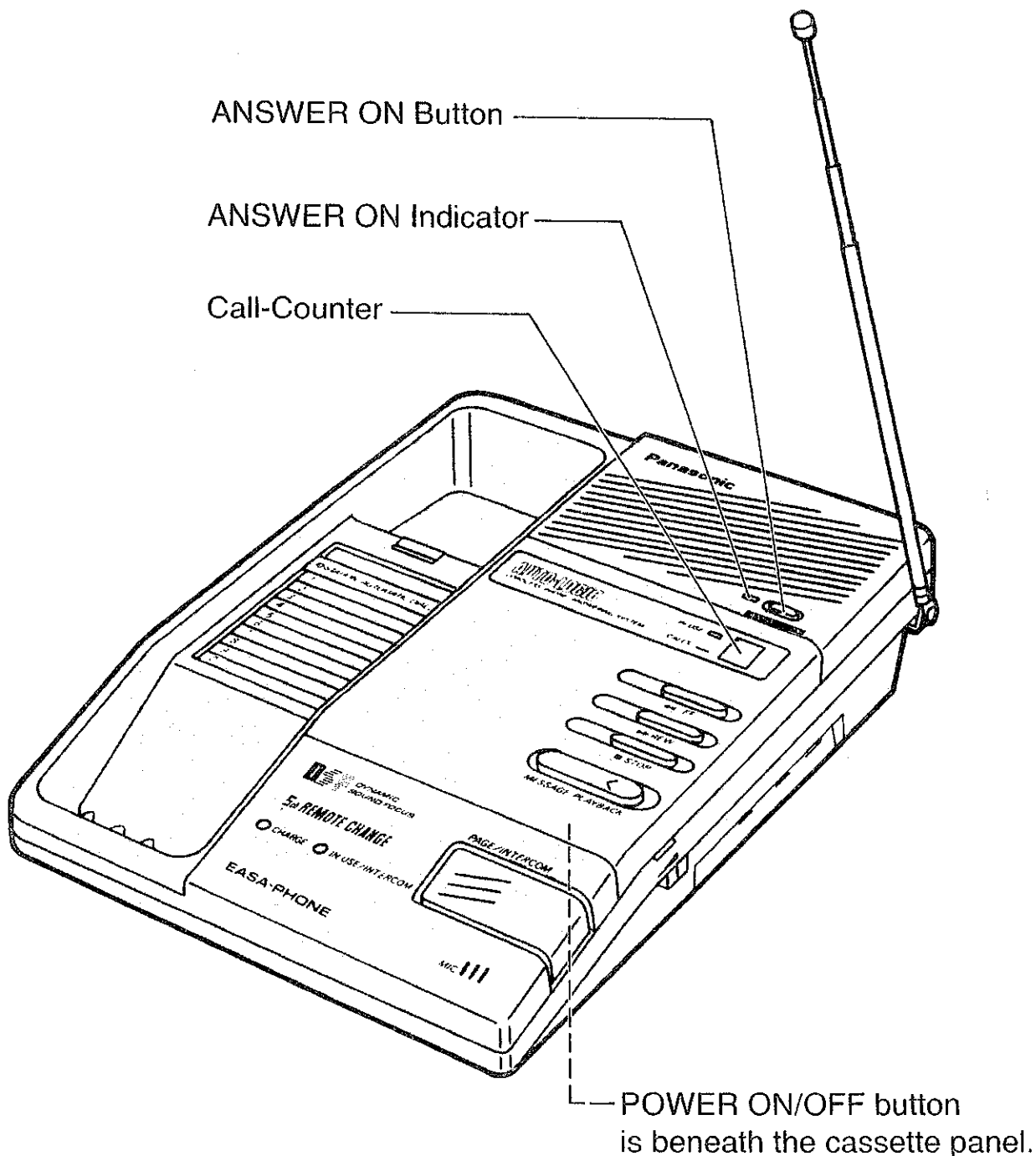

Make sure that the Call-Counter light is on. If it is off, press the POWER ON/OFF button to turn on the power.

When the ANSWER ON indicator light is off:

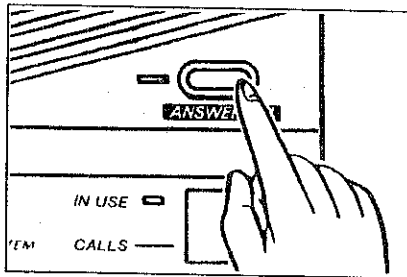

Press the ANSWER ON button to turn on the answering system.

—The ANSWER ON indicator light is on.

Helpful hints:

—When you want to use the unit only as a cordless telephone, press the ANSWER ON button until the ANSWER ON indicator light goes out. The answering system turns off.

To turn on the power of the base unit

If the Call-Counter light is off, the power of the base unit is turned off and the answering system will not function.

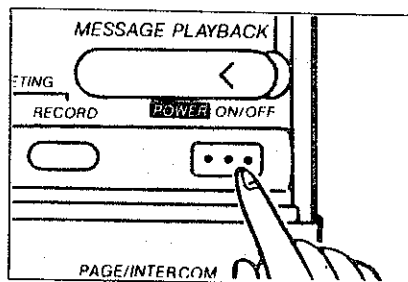

Press the POWER ON/OFF button in order to turn the power on and the Call-Counter light is on.

Listening to the recorded messages

When incoming messages have been recorded, the Call-Counter shows the number of recorded messages up to 9 in total.

If there are new messages which have not been listened to yet, the Call-Counter flashes. When the MESSAGE ALERT selector is set to the ON position, the base unit beeps every 10 seconds.

(See page 17.)

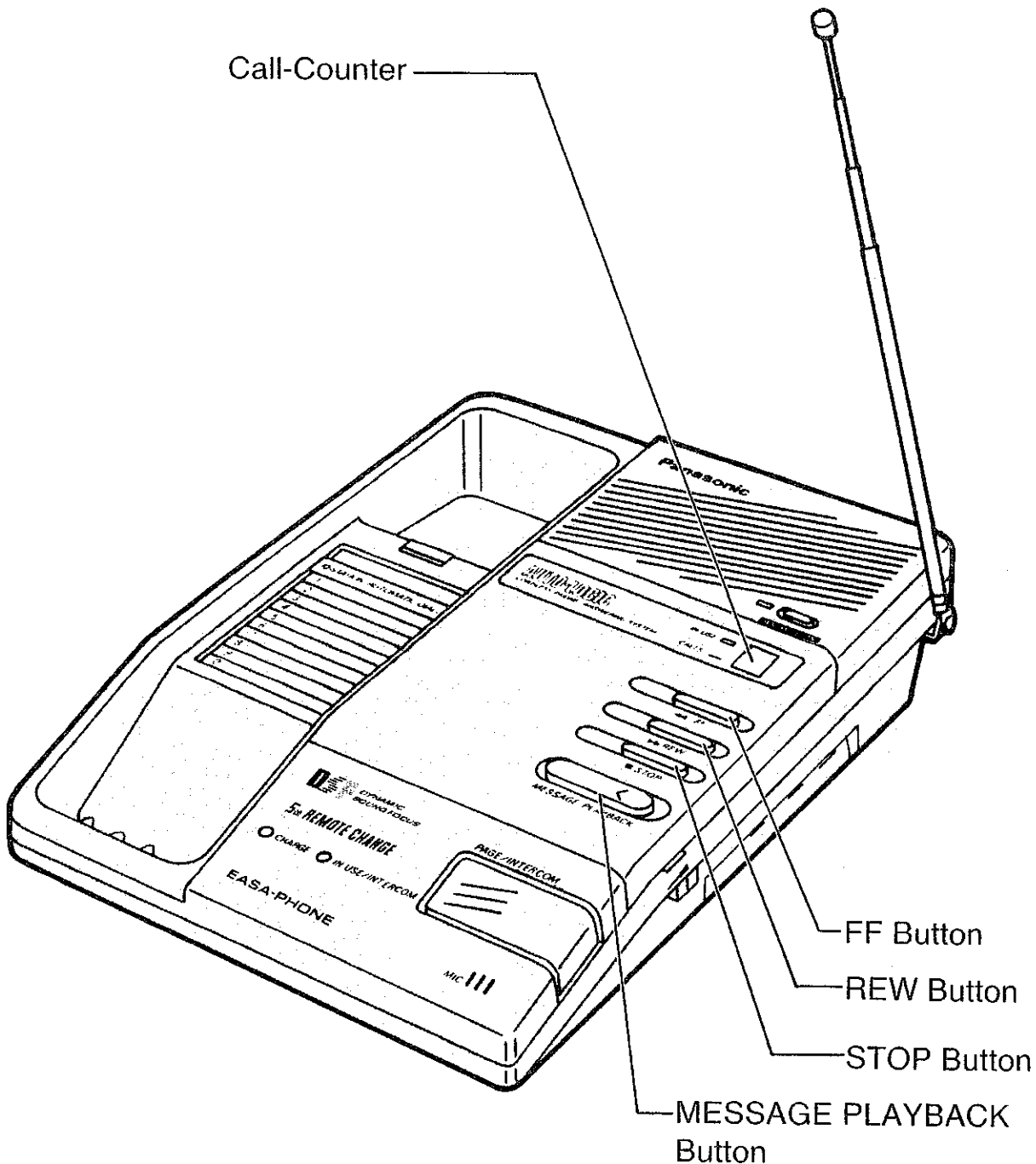

To listen to messages

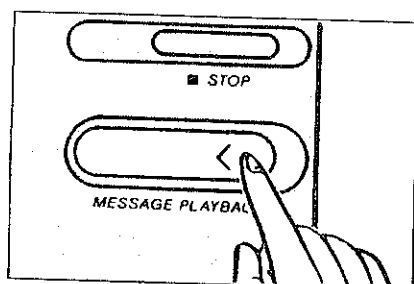

Press the MESSAGE PLAYBACK button.

- The unit automatically rewinds the tape and starts to play back the messages.
- At the end of the last message, 3 beeps sound and the tape stops automatically.

Note:

- To stop listening halfway, press the STOP button.
- 10 seconds after having played back all the recorded messages, the tape automatically rewinds to the beginning and resets itself. The Call-Counter shows "0". New messages are recorded over old messages.

AUTO-LOGIC

When you use the MESSAGE PLAYBACK button to listen to the recorded messages, the unit automatically;

- rewinds the tape and plays back the messages
- tells you the end of the last message by beeping 3 times
- rewinds the tape to reset
- prepares to record new messages (returns to the answer mode by itself)

We named this MESSAGE PLAYBACK button's feature "AUTO-LOGIC".

To rewind/fast forward the tape

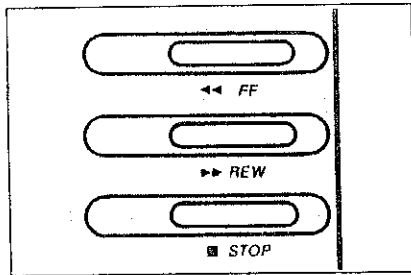

Keep pressing the REW button to rewind the tape.

Keep pressing the FF button to fast forward the tape.

—The unit rewinds/fast forwards the tape while the REW/FF button is pressed, and starts playback again when you release the button.

Note:

—When the tape is completely rewound, a beep sounds and the tape is reset. To listen to the recorded messages again, press the MESSAGE PLAYBACK button within 10 seconds after the beep.

To reset the tape

After having played back all the recorded messages, the unit automatically rewinds the tape to the beginning and resets itself. New messages are recorded over old messages.

To save old messages

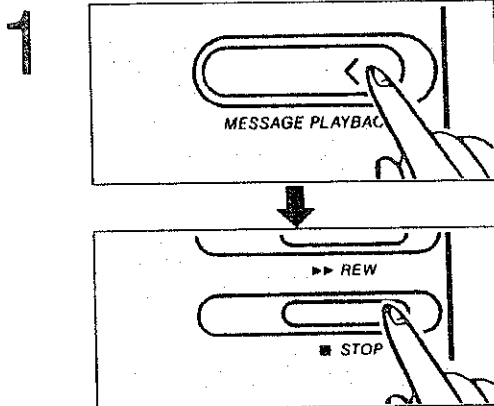

Play back the messages by pressing the MESSAGE PLAYBACK button, then press the STOP button at the end of the messages you want to save.

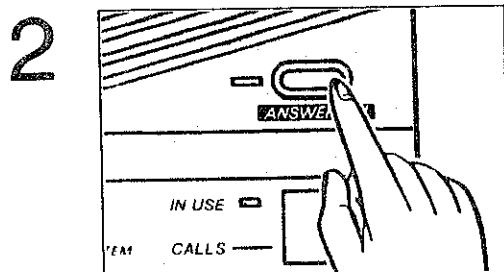

Press the ANSWER ON button to turn on the answering system.

- The Call-Counter returns to “0”.
- The ANSWER ON indicator light is on.
- The new messages will be recorded after saved messages.

Monitoring an incoming call

While an incoming call is being recorded, you can monitor and answer it if you wish.

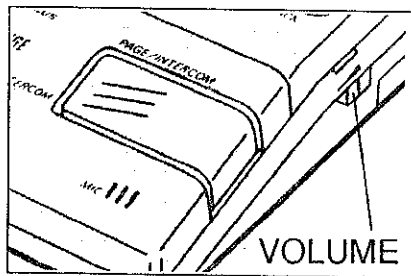

When the unit answers a call, the caller's message is heard through the speaker on the base unit.

—Adjust the VOLUME control.

Helpful hints:

—To answer the call while monitoring, lift the portable handset or press the TALK button.

Recording your own message

You may record a personal message on the tape. It can be heard by anyone playing back messages remotely or manually.

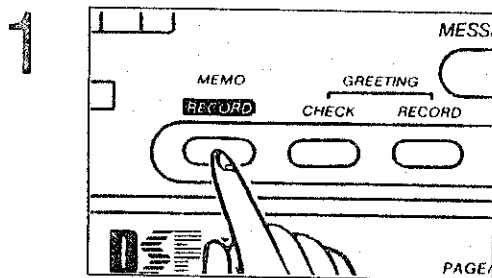

Open the cassette panel and press the MEMO RECORD button.

—A series of short tones will sound, followed by a long beep.

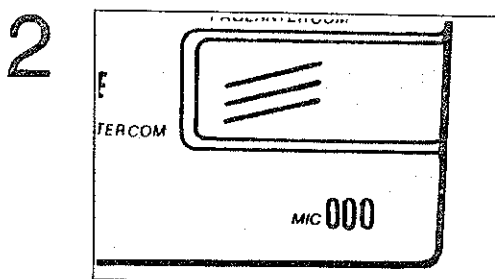

Speak immediately after the long beep, about 20 cm (8") away from the MIC (Microphone).

—The IN USE indicator flashes.

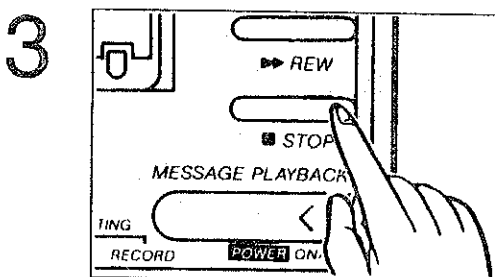

To stop recording, press the STOP button.

—The IN USE indicator light goes out.

Remote operation from a touch tone phone

You can operate the answering system remotely from a touch tone telephone while you are away from home.

The following features can be operated with a touch tone telephone.



- Playing back all messages (p. 38)
- Playing back new messages only (p. 39)
- Rewinding and fast forwarding (p. 39)
- Resetting the tape (p. 40)
- Recording your own message (p. 41)
- Monitoring the room sound (p. 41)
- Re-recording the greeting message (p. 42)
- Skipping the greeting message (p. 43)
- Turning off/on the answering system (p. 44)

Note:

- Touch tone telephone must be the type where a tone is emitted for as long as a number or digit is pressed. (When pressing the buttons for remote operation, press each key pad for approximately 1–2 seconds.)

Toll saver

When you call the unit from a touch tone telephone, the number of rings before the unit answers tells you if there are any new messages or not.

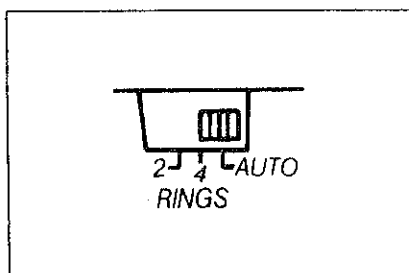

To use this feature, set the RINGS selector to the AUTO position.
 If the unit answers on the 2nd ring:
 There is at least one new message.
 If the unit answers on the 4th ring:
 There are no new messages.

Hang up immediately when you hear the 3rd ring. Because the 3rd ring indicates there are no new messages and no need to make the unit answer your call. This saves you the toll charge for the call.

To set the remote code number

To get remote access, set your remote code number. The remote code number prevents unauthorized persons from accessing your unit and listening to your messages. The remote code number is made up of 2 digits. The first digit is factory preset, and the second digit is selectable ("1" or "2").

Example:

If the factory preset number is "4", then your code number could be either "41" or "42" depending on the position of the REMOTE CODE selector.

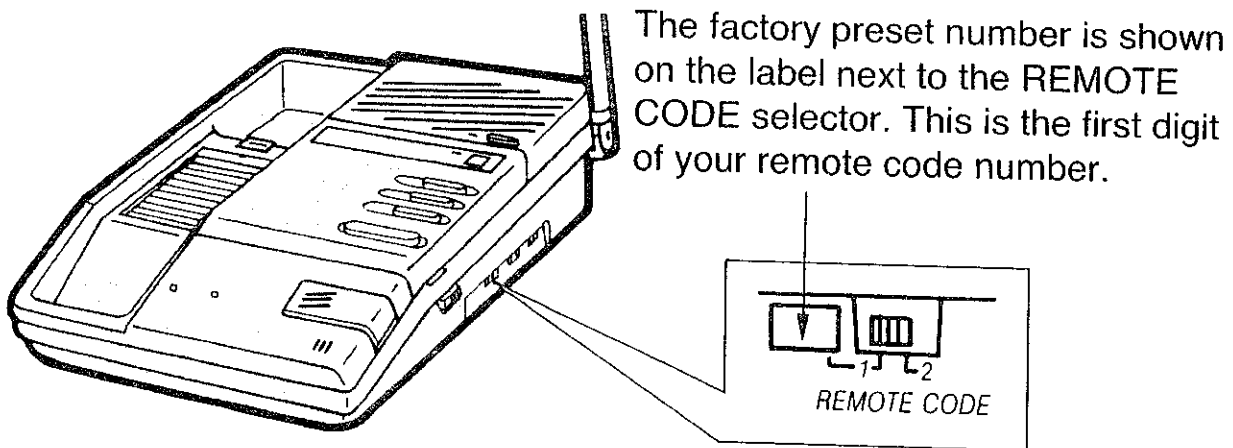

To play back all messages

1

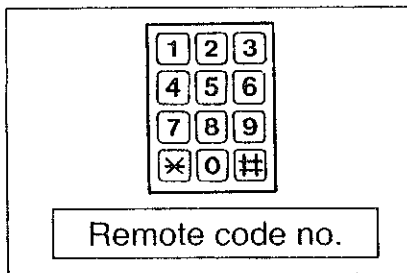

Call your unit and press the remote code number during the greeting message playback.

—After a long beep, short beeps sound to indicate the number of recorded messages.

2

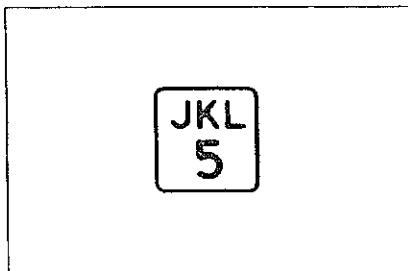

Press "5" within 4 seconds after the short beeps.

—The unit rewinds the tape and starts to play back all the recorded messages. At the end of the last message, 3 beeps sound.

3

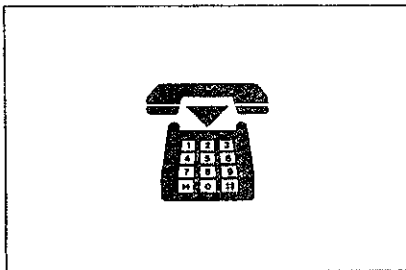

To stop listening, hang up.

—Old messages are saved and new messages will be recorded after them.

Helpful hints:

—Even if you do not press "5" on step 2, all messages are played back automatically.

To play back new messages only

You can listen to new messages only without replaying the previously heard messages.

1

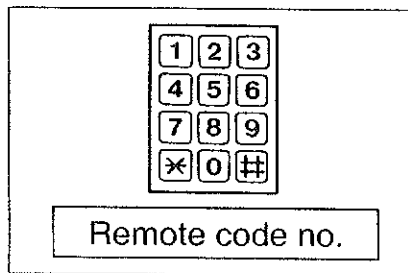

Call your unit and press the remote code number during the greeting message playback.

—After a long beep, short beeps sound to indicate the number of recorded messages.

2

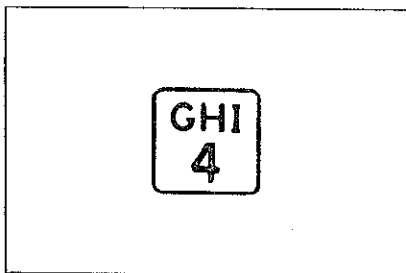

Press "4" within 4 seconds after the short beeps.

—The unit rewinds the tape and plays back the recorded messages which have not been listened to yet.

—To stop remote operation, hang up.

Note:

—Even during the playback of old messages, you can skip them by pressing "4".

To rewind/fast forward the tape

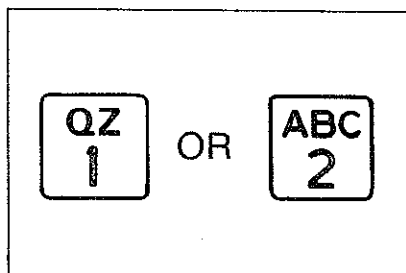

Press "1" to rewind the tape.

Press "2" to fast forward the tape.

—The tape rewinds or fast forwards for a few seconds and starts playback.

To reset the tape

Within 10 seconds after or during playing back all messages:

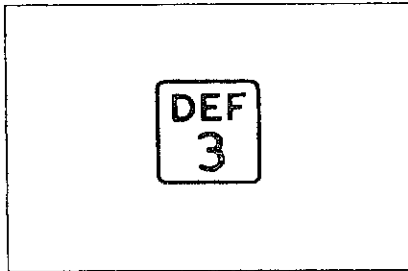

Press "3".

- The unit rewinds the tape to the beginning. New messages will be recorded over the old messages.
- To stop remote operation, hang up.

Within 10 seconds after having played back new messages only:

1

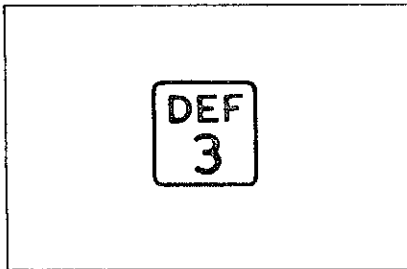

Press "3".

- The unit rewinds the tape to the beginning of the newly recorded messages and a beep will be heard.

2

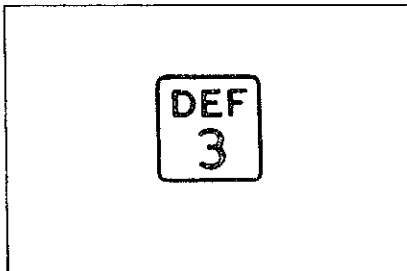

Press "3" again after hearing the beep.

- The unit rewinds the tape to the beginning.
- To stop remote operation, hang up.

Note:

- To cancel the resetting of the tape, press "2" before hanging up.

To record your own message (Marker message)

You can leave your own message on the tape after listening to the last message.

1. After 3 beeps indicating the end of the last message, wait for 10 seconds and start to speak your message when 2 beeps sound.
2. To finish recording, hang up.

To monitor the room sound

You can monitor the sound in the room where the base unit is installed for 30 seconds.

1

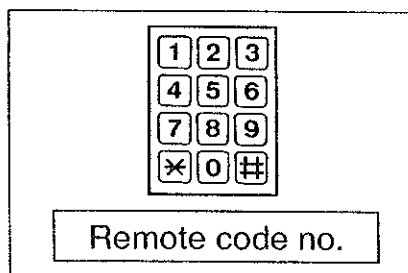

Call your unit and press the remote code number during the greeting message playback.

—After a long beep, short beeps sound to indicate the number of recorded messages.

2

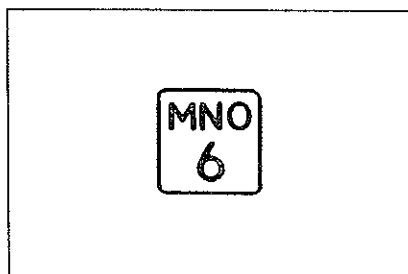

Press "6" within 4 seconds after the short beeps.

—The sound in the room is heard.
—To stop remote operation, hang up.

Note:

—When 30 seconds are up, a beep indicating that the time is up will sound. To monitor further, press "6" again within 10 seconds after the beep.

To re-record the greeting message

1

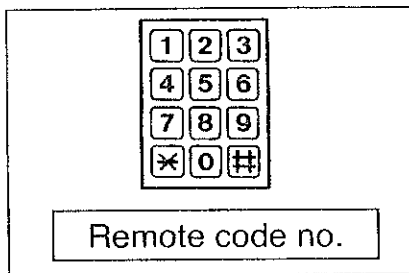

Call your unit and press the remote code number during the greeting message playback.

—After a long beep, short beeps sound.

2

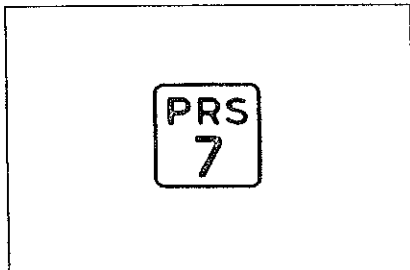

Press "7" within 4 seconds after the short beeps.

—A series of short tones will sound followed by a long beep.

3



Speak right after the long beep.

4

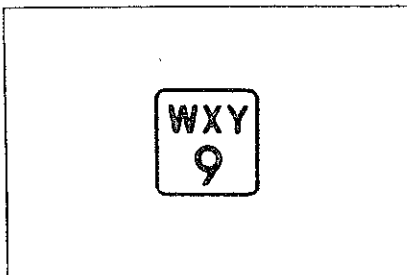

To stop recording, press "9".

—A long beep sounds and the new greeting message is played back for confirmation.

—To stop remote operation, hang up.

Note:

—Do not pause for over 2 seconds while recording, or the recording results in failure. If 6 beeps sound, start again from step 2.

—When you want to re-record, start again from step 2.

To skip the greeting message (For outside callers)

Callers can record their messages on the tape without listening to your greeting message.

1

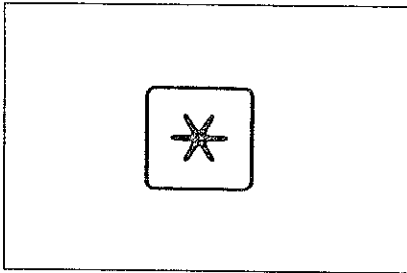

Call your unit and press “*” during the greeting message playback.

—The greeting message stops and a series of short tones will sound, followed by a long beep.

2



Start recording right after the long beep.

To turn off the answering system

1

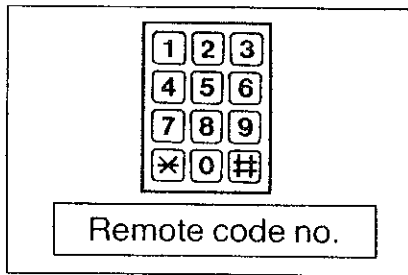

Call your unit and press the remote code number during the greeting message playback.

—After a long beep, short beeps sound.

2

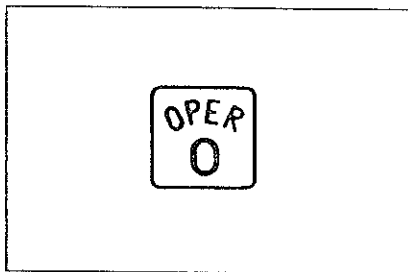

Press "0" within 4 seconds after the short beeps.

—The answering system turns off.

To turn on the answering system

You may easily turn on the answering system even when you forgot to turn it on.

1

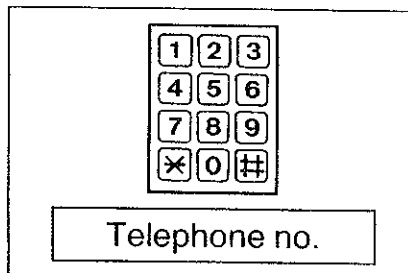

Call your unit.

2

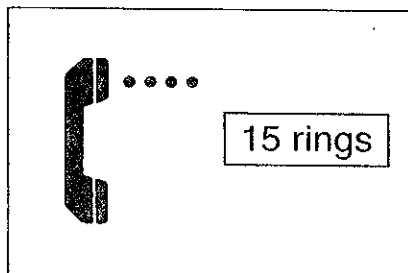

Wait for 15 rings.

—When the unit answers your call, the greeting message is heard.

Then, hang up.

—The answering system turns on.

Remote operation from the portable handset

You can operate the answering system remotely from your portable handset using dialing buttons when the unit is in the answer mode. When incoming message is being recorded, the SCREEN/PLAYBACK indicator on the portable handset flashes slowly. When the recording is over, 4 short beeps sound twice on the portable handset.

The following features are available with your portable handset.

- Playing back all messages (p. 46)
- Rewinding and fast forwarding (p. 46)
- Playing back new messages only (p. 47)
- Resetting the tape (p. 48)
- Recording your own message (p. 49)
- Monitoring an incoming call (p. 49)
- Monitoring the room sound (p. 50)
- Turning off/on the answering system (pp. 51, 52)

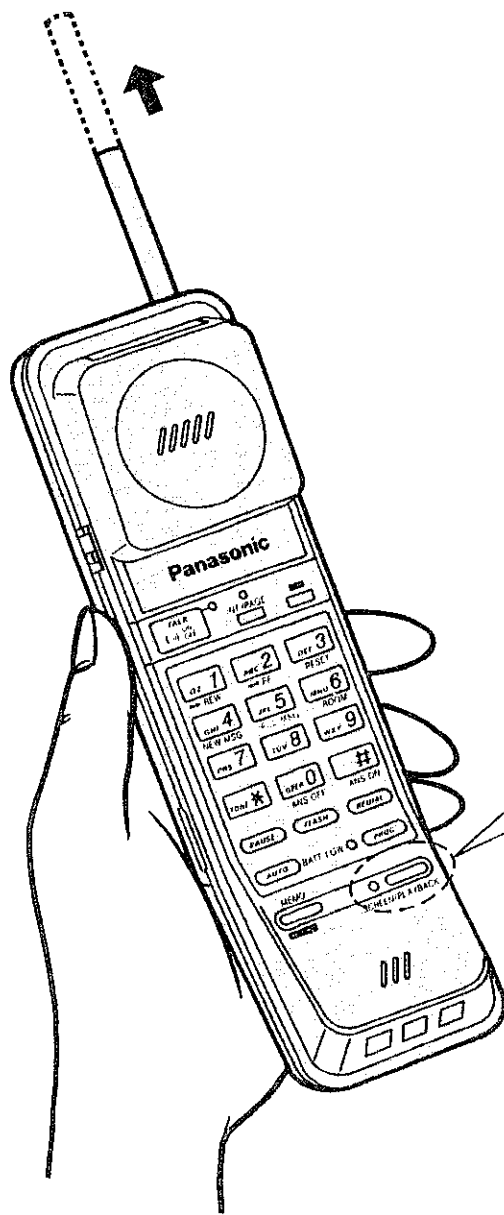

If the SCREEN/PLAYBACK indicator flashes when you press the SCREEN/PLAYBACK button, the answering system is turned off. Press “#” to turn on the answering system.

To play back all messages

1

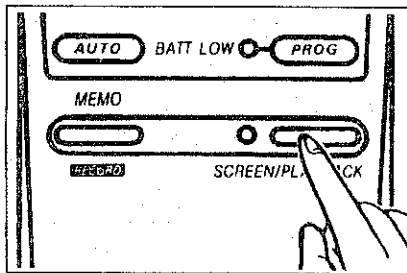

Press the SCREEN/PLAYBACK button.

- The SCREEN/PLAYBACK indicator light is on.
- Short beeps indicating the number of recorded messages sound.

2

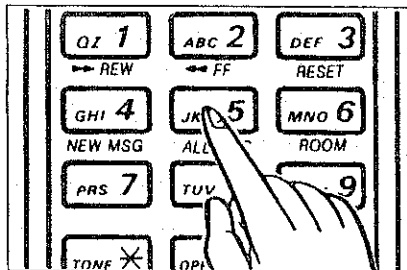

Press “5” (ALL MSG) after the short beeps.

- Short tones sound while the tape rewinds, then all messages are played back.
- At the end of last message, 3 beeps sound.

3

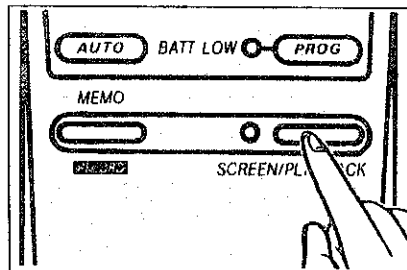

To stop remote operation, press the SCREEN/PLAYBACK button.

- The SCREEN/PLAYBACK indicator light goes out.

To rewind/fast forward the tape during playback

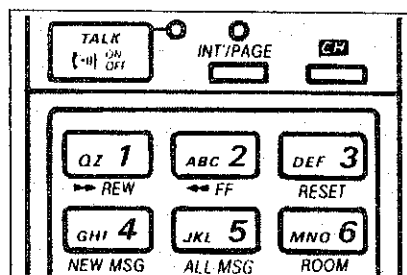

Press “1” (REW) to rewind the tape, press “2” (FF) to fast forward the tape during playback.

- The unit rewinds or forwards the tape for a few seconds and starts playback.

To play back new messages only

1

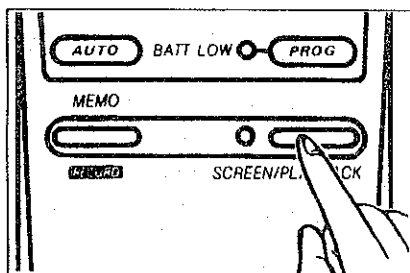

Press the SCREEN/PLAYBACK button.

- The SCREEN/PLAYBACK indicator light is on.
- Short beeps indicating the number of recorded messages sound.

2

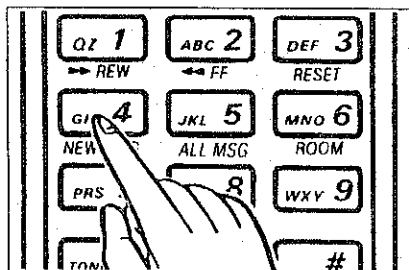

Press "4" (NEW MSG) after the short beeps.

- Short tones sound while the tape rewinds, then new messages are played back.
- At the end of the last message, 3 beeps sound.

3

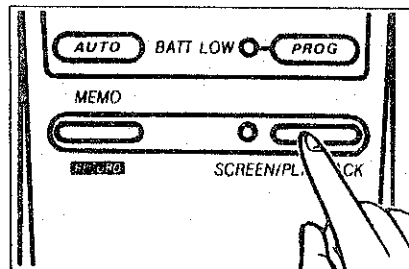

To stop remote operation, press the SCREEN/PLAYBACK button.

- The SCREEN/PLAYBACK indicator light goes out.

To reset the tape

Within 10 seconds after or during playing back all messages:

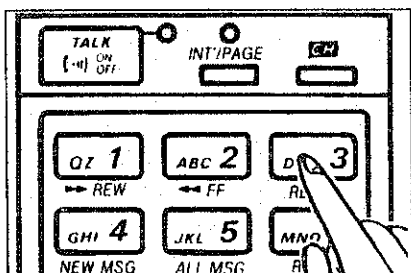

Press "3" (RESET).

- The unit rewinds the tape to the beginning.
- New messages will be recorded over the old messages.
- To stop remote operation, press the SCREEN/PLAYBACK button.

Within 10 seconds after having played back new messages only using "4" (NEW MSG)

1

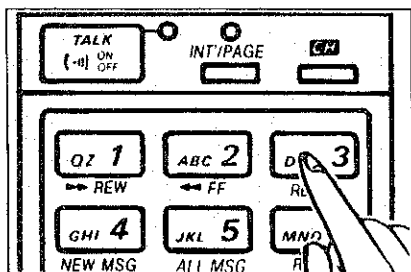

Press "3" (RESET).

- The unit rewinds the tape to the beginning of the newly recorded messages and a beep sounds.

2

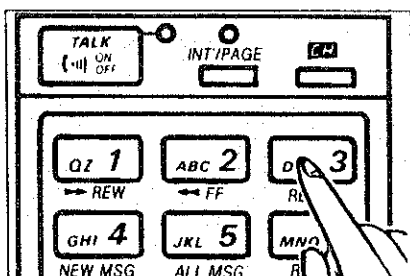

Press "3" (RESET) again after the beep.

- The unit rewinds the tape to the beginning.
- To stop remote operation, press the SCREEN/PLAYBACK button.

Note:

- To cancel the resetting of the tape, press "2" before stopping the remote operation.

To record your own message

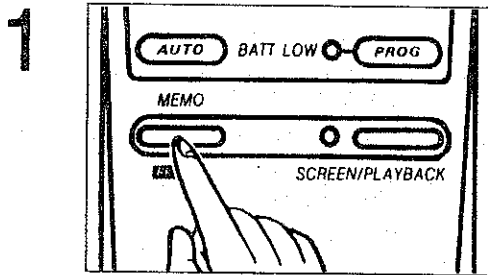

Press the MEMO RECORD button.

- The SCREEN/PLAYBACK indicator light is on.
- A series of short tones will sound, followed by a long beep.



Speak with your portable handset right after the long beep.

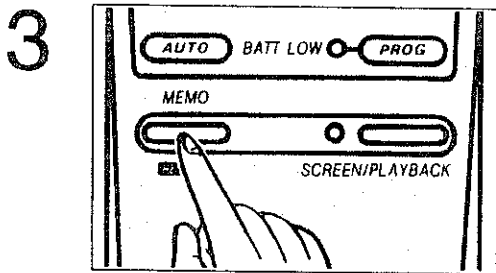

To stop recording, press the MEMO RECORD button again.

- The SCREEN/PLAYBACK indicator light goes out.

To monitor an incoming call

You will know that an incoming message is being recorded by the slow flashing of the SCREEN/PLAYBACK indicator.

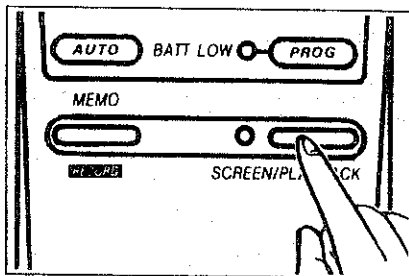

Press the SCREEN/PLAYBACK button.

- The SCREEN/PLAYBACK indicator turns to a steady light from slow flashing, and you can listen to the incoming call.
- To stop remote operation, press the SCREEN/PLAYBACK button again.

Helpful hints:

- To answer the call while monitoring, press the TALK button.

To monitor the room sound

You can monitor the sound in the room where the base unit is installed for 30 seconds.

1

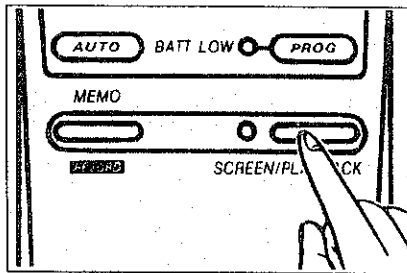

Press the SCREEN/PLAYBACK button.

—The SCREEN/PLAYBACK indicator light is on and short beeps sound.

2

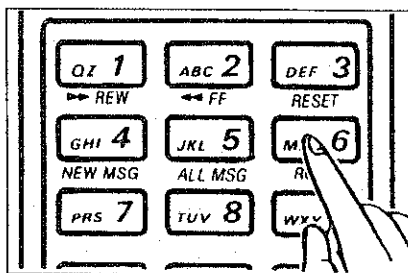

Press "6" (ROOM) after the short beeps.

—The sound in the room where the base unit is installed is heard.

3

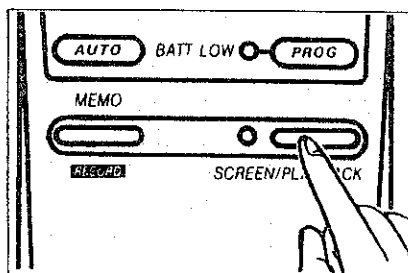

To stop remote operation, press the SCREEN/PLAYBACK button again.

—The SCREEN/PLAYBACK indicator light goes out.

Note:

—When 30 seconds are up, a beep indicating that the time is up will sound. To monitor further, press "6" again within 10 seconds after the beep.

To turn off the answering system

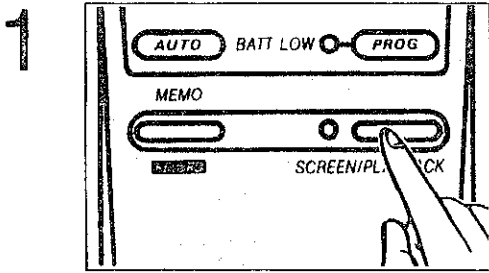

1 Press the SCREEN/PLAYBACK button.

—The SCREEN/PLAYBACK indicator light is on to show the answering system is on.

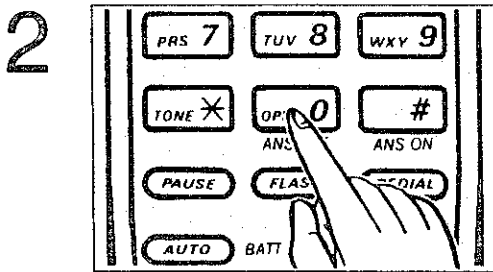

2 Press "0" (ANS OFF).

—The SCREEN/PLAYBACK indicator light goes out.

OPERATION FROM TONE PHONE

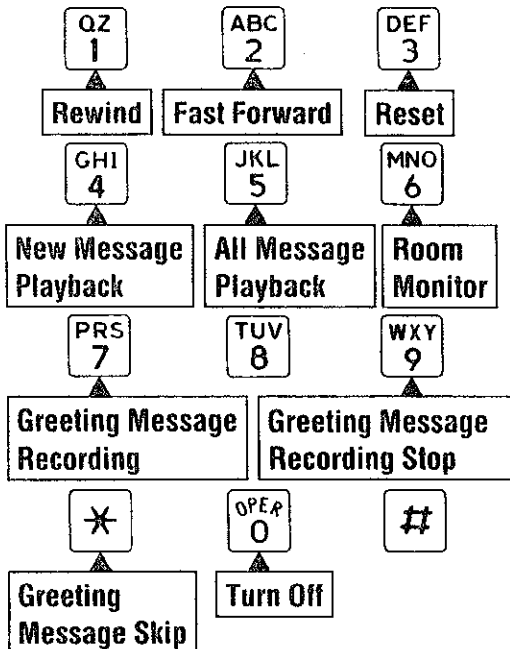

• To turn on the answering system, call your unit and wait for 15 rings. The unit answers, then hang up.

• To turn off the answering system...

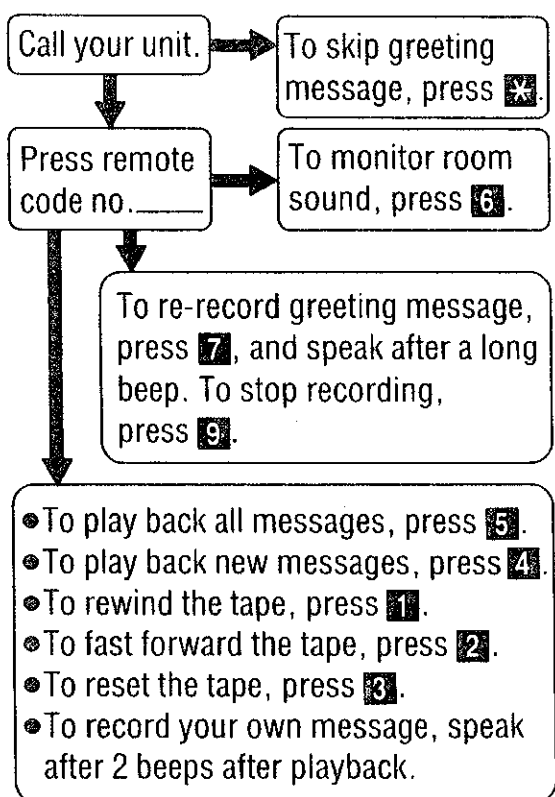

When you place a button, press firmly

To turn on the answering system

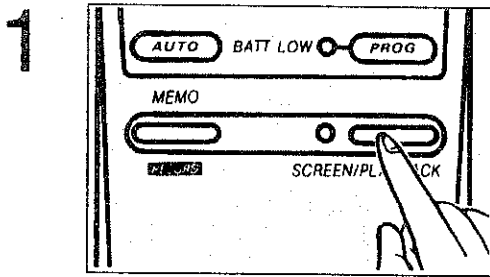

1 Press the SCREEN/PLAYBACK button.

—The SCREEN/PLAYBACK indicator light is flashing to show the answering system is off.

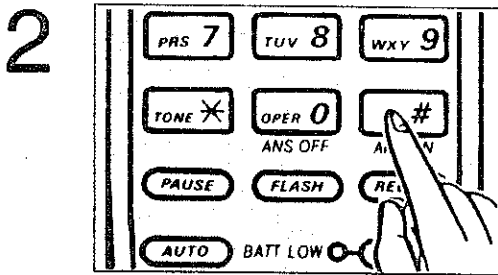

2 Press “#” (ANS ON).

—The SCREEN/PLAYBACK indicator light turns to a steady light.

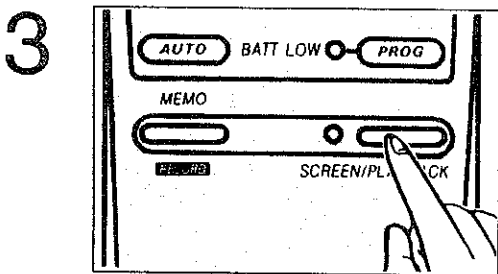

3 To stop remote operation, press the SCREEN/PLAYBACK button.

OPERATION FROM PORTABLE HANDSET

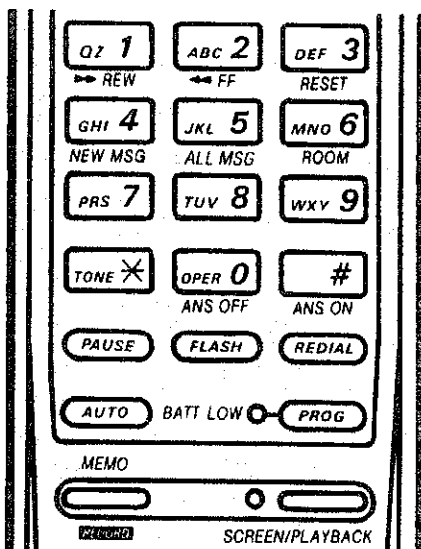

To record your own message;
 1. Press the MEMO RECORD button.
 2. Speak after hearing short tones followed by a long beep.
 3. To stop recording, press the MEMO

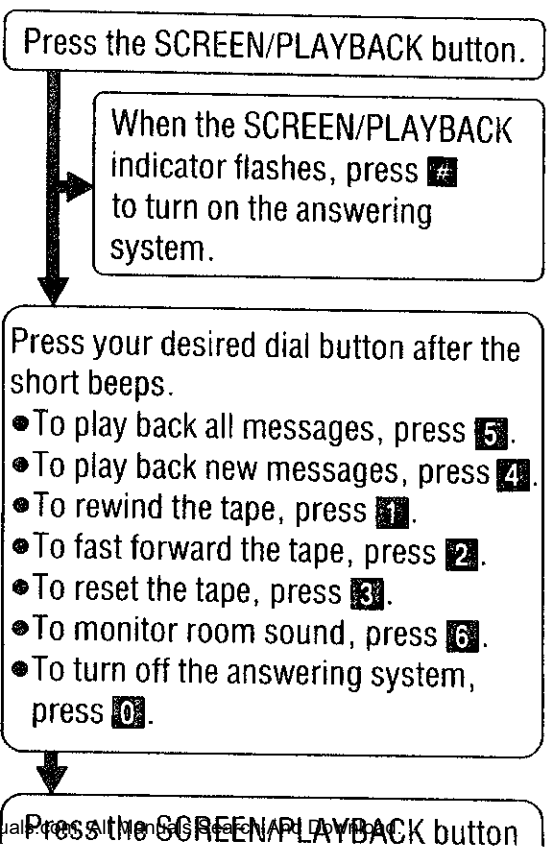

Press the SCREEN/PLAYBACK button

The portable handset battery

The battery is charged continuously while the portable handset is on the base unit. The battery cannot be overcharged. If you keep the portable handset off the base unit, charging will be required.

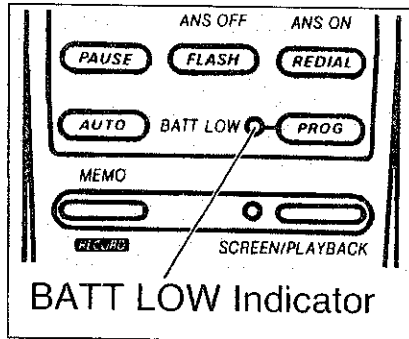

When the BATT LOW indicator flashes or a beep sounds every 15 seconds during a conversation, it means the battery needs to be charged.

Place the portable handset on the base unit for about 10 hours.

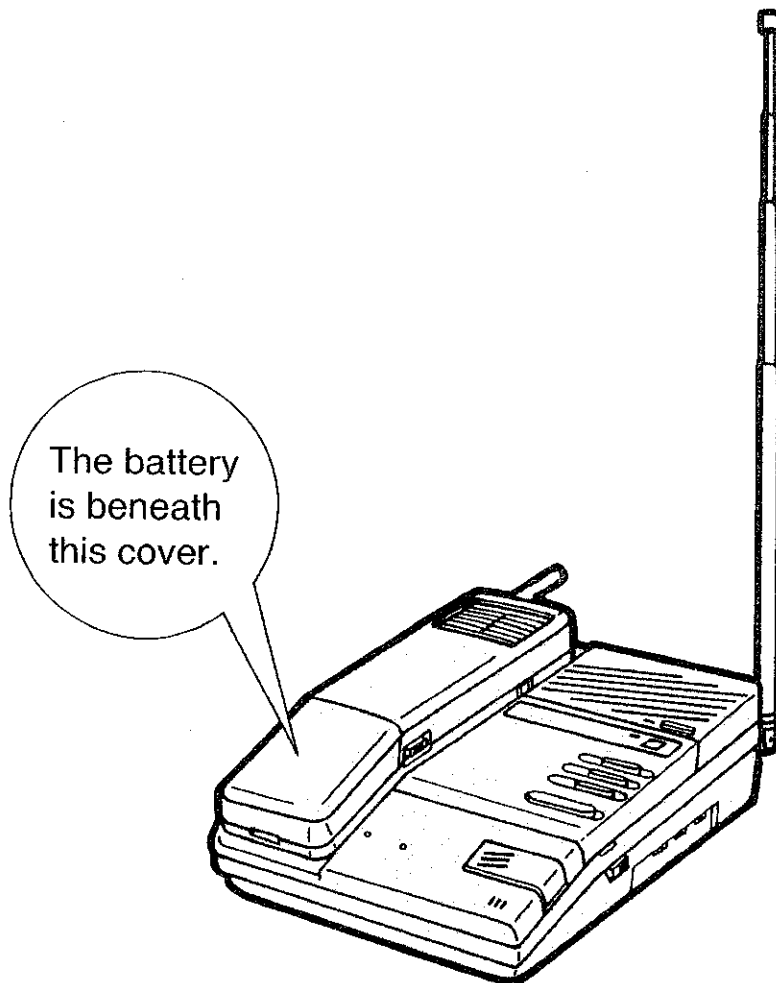

Note:

—You can use the unit for a short period of time when the BATT LOW indicator flashes. Be sure to put the portable handset on the base unit after use.

Clean the battery charge contacts with a soft cloth about once a month, otherwise the portable handset may not be charged properly.

Battery replacement

Replace the battery with a new one if the BATT LOW indicator flashes after a few telephone calls even when the battery has been charged for 10 hours.

1

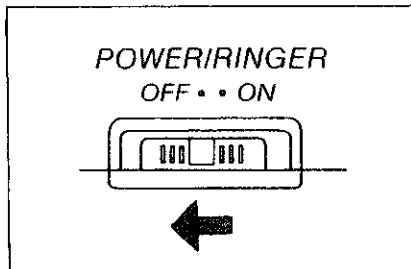

Set the POWER/RINGER switch on the portable handset to the OFF position, to prevent the memory loss.

2

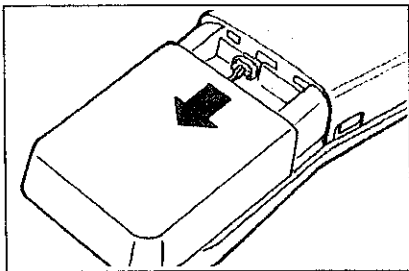

Remove the battery compartment cover.

3

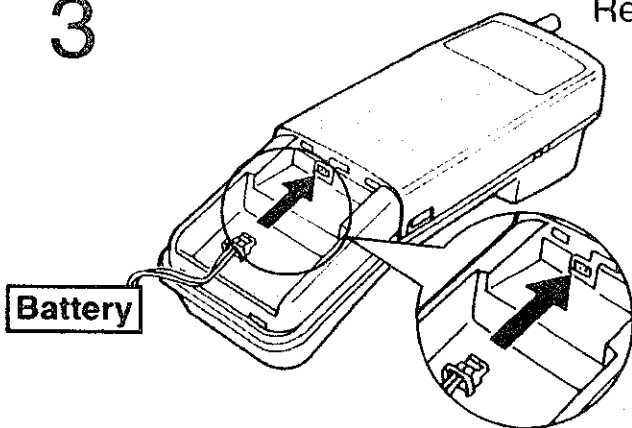

Replace the battery.

4

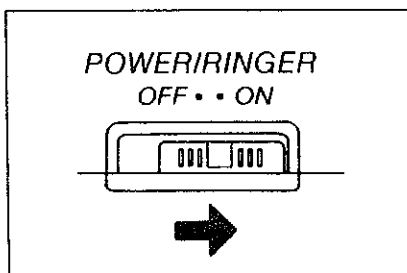

Close the cover and set the POWER/RINGER switch to the ON position.

Note:

- Please use only Panasonic KX-A36A battery.
- Remember to charge the battery for about 10 hours before use, after replacing the battery.

Wall mounting

This unit can be mounted on a wall using screws and washers included.

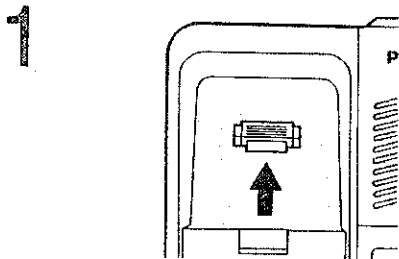

Remove the handset guide from the base unit.

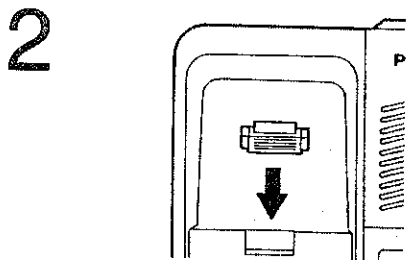

Turn the handset guide, then replace it making its tab upward.

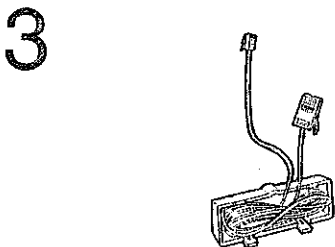

Tuck the telephone line cord inside the wall mounting adaptor.

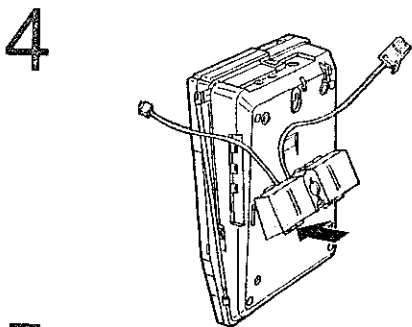

Insert the tabs of the wall mounting adaptor into the openings of the unit, then push it in the direction of the arrow. (Make sure the word "UP" on the adaptor faces upward.)

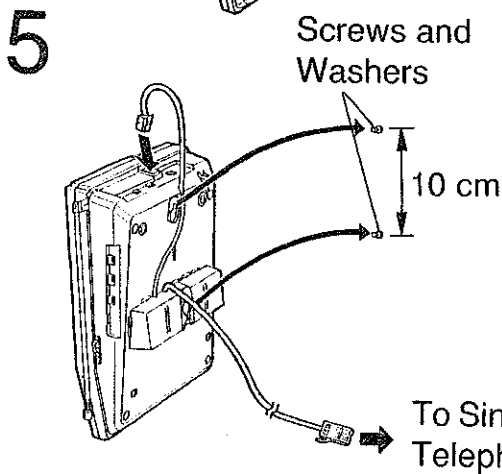

Install screws and washers using the wall template on this page.

Connect the telephone line cord to the unit and to the single-line telephone jack. Then mount the unit securely on the screws as shown.

Wall Template

Drill here

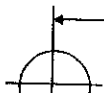

10 cm

Drill here



Maintenance

Cassette tape

- For optimum sound quality and performance, we recommend that you **use the opposite side (side-2) after six months and replace the tape with a new one every year**, assuming that the unit answers about ten calls a day.
- Never place a cassette tape near a magnetic source, such as a magnet or a TV set; because it may erase or distort the recorded message on the tape.
- Slack in the tape can be tightened by rotating the tape reel with an instrument like a pencil, as shown.

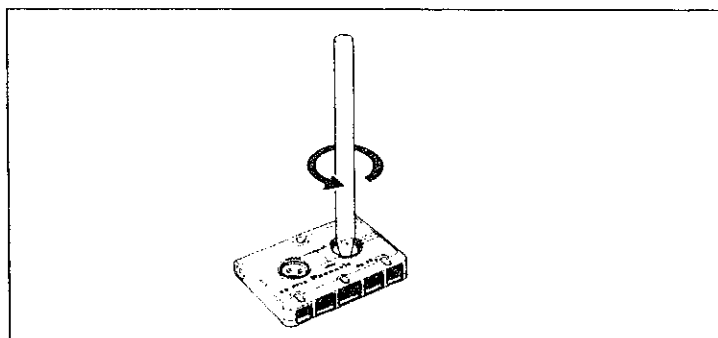

Tape deck

Since the head and capstan assemblies are in contact with the tape, dirt and residue from the tape may easily adhere to these parts, causing distortion. These parts should be cleaned periodically in the manner described below.

Clean the head surfaces, pinch roller and capstan with a cotton swab. If these surfaces are extremely dirty, wipe them with the cotton swab dampened with alcohol, then wipe them with a dry soft cloth.

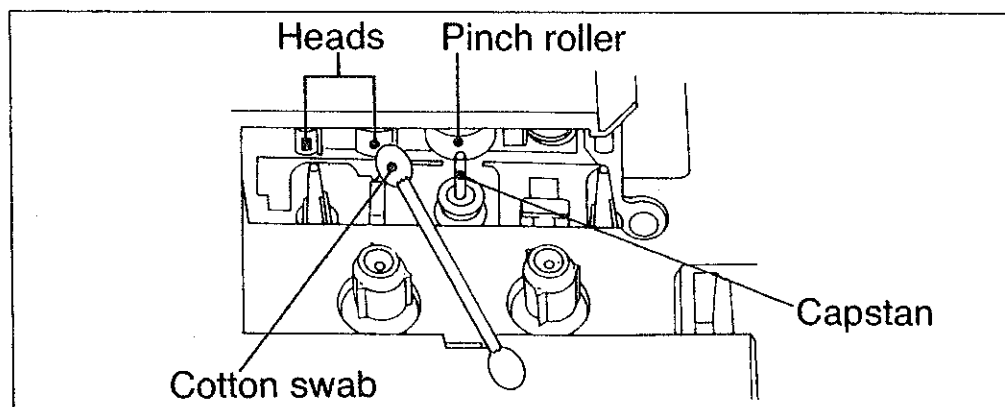

Note:

- Do not bring magnetic or metal objects, such as a screwdriver, near the head assemblies, as such objects could magnetize the heads.
- Do not oil any part of the unit.

Cassette panel installation

If the panel comes off, replace it by pushing as shown.

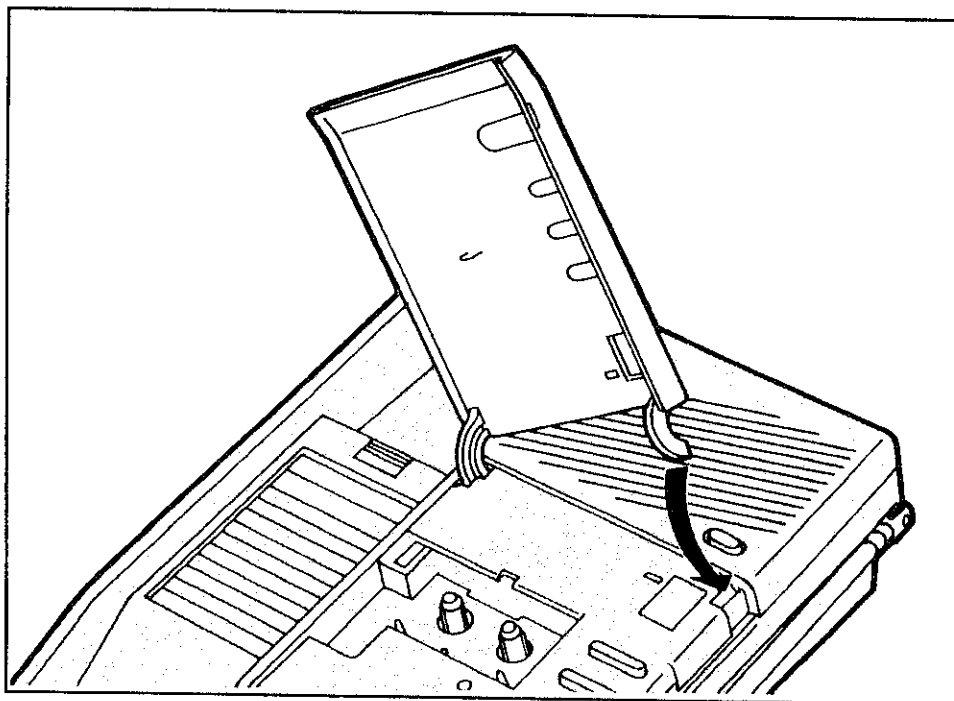

Troubleshooting guide

Sound flutters or fades.

- You are too far from the base unit. Approach it.
- Extend the antennas of the base unit and the portable handset fully.

I am encountering interference from another unit.

- Select another channel. (p. 28)
- Set the portable handset and the base unit away from other electric appliances.

When I press the TALK button to make a call, 3 beeps sound and dial tone is not heard.

- Approach the base unit and try again.
- Place the portable handset on the base unit and try again.
- Make sure that the AC adaptor is connected.

The portable handset does not ring.

- The POWER/RINGER switch is in the OFF position. Set to the ON position.

When I press the INT'/PAGE button, 3 beeps sound and paging cannot be done.

- Someone is operating the answering system.
- You are too far from the base unit. Approach it.

I cannot page the portable handset from the base unit.

- Paging cannot be done while the base unit is receiving an incoming call or recording some messages.
- Set the POWER/RINGER switch to the ON position.

I cannot store a phone number into memory.

- You cannot store the number into memory while the unit is in the talk mode or in the intercom mode.
- Do not pause for over 30 seconds while storing.

While storing the phone number, the unit starts to ring.

- You can answer the call by pressing the TALK button. The program will be canceled; store the phone number again.

A beep sounds every 15 seconds during a conversation.

- Charge the battery fully. (p. 53)

While having an intercom call, two tones are heard.

- Someone is calling you from outside. Press the TALK button to answer the outside call. Intercom call is terminated.

The Call-Counter shows "E" (Error), or 6 quick beeps sound during greeting message recording, and it results in failure.

—Re-record your greeting message. Speak clearly and loudly, and do not pause for over 2 seconds while recording.

The answering system is on, but no incoming messages are recorded.

The Call-Counter shows "E" (Error) when you return.

—The cassette tape is cut or is not inserted. Insert the tape or replace it with a new one.

—The greeting message is recorded improperly or not recorded, so no one can leave a message. Check and record a new greeting message.

A beep sounds every 10 seconds on the base unit.

—New messages are recorded. Play back the messages.

I cannot operate the answering system by using the button of the base unit.

—The portable handset user is operating the answering system or having a conversation. After the IN USE indicator or IN USE/INTERCOM indicator light goes out, try again.

I cannot operate the answering system from a touch tone phone.

—Be sure that you press your correct remote code number.

—In some areas, a remote touch tone phone may not function due to telephone line conditions such as line noise, echo, etc.

—The answering system may not respond if a touch tone phone produces tones which are too short to activate the unit. Press each button firmly and long.

—The answering system is off. Turn it on. (p. 44)

When the tape is played back, the sound level is low, even if the VOLUME control is set to maximum position.

—Clean the heads. (p. 56)

Some incoming messages have not been recorded up to their end.

—Set the VOX SENS selector to the LOW position. (p. 17)

When pressing the SCREEN/PLAYBACK button, the SCREEN/PLAYBACK indicator flashes.

I cannot operate the answering system with the portable handset.

—Press "#" to turn on the answering system. (p. 52)

When pressing the SCREEN/PLAYBACK button, 3 beeps sound and operation cannot be accomplished.

- Someone is operating the answering system.
- You are too far from the base unit. Approach it.

4 short beeps are heard twice from the portable handset.

- A new message is just recorded on your answering system.

After plugging in the AC adaptor, the cassette deck does not stop rewinding.

- Disconnect the AC adaptor, and insert the micro cassette tape. Then connect the AC adaptor again.

The Call-Counter showed “-” when you returned home.

- Power failure took place. If new messages have been recorded after the power is restored, the Call-Counter cannot count them, so press the MESSAGE PLAYBACK button for confirmation.

I cannot use the unit during a power failure.

- The unit will not function during a power failure. We recommend that you connect a reserve telephone (standard telephone) and use it during a power failure. (p. 11)

The unit does not work.

- The connection of the unit was made improperly. (p. 10)
- The battery of the portable handset becomes weak. Charge the battery fully. (p. 53)

The BATT LOW indicator flashes.

- Charge the battery fully. (p. 53)

I charged the battery for 10 hours, but the BATT LOW indicator flashes after a few telephone calls.

- Clean the battery charge contacts and charge once more. (p. 53)
- It is time to change the battery. Please replace with a new one. (p. 54)

The beginning of the cassette tape has remained unrewound after the unit rewinds the tape.

While operating the unit, the AC adaptor feels warm.

The CHARGE indicator light never goes out while the portable handset is on the base unit.

- These are normal conditions.

Safety instructions

Take special care to follow the safety suggestions listed below.

Safety

- 1) Power Source: The unit should be connected to a power supply only of the type described in the operating instructions or as marked on the unit.
- 2) Nonuse Periods: When the unit is not used, turn the power off. When left unused for a long period of time, the base unit should be unplugged from the household AC outlet.

Installations

Environment

- 1) Water and Moisture: Do not use this unit near water—for example, near a bath tub, washbowl, sink, etc. Damp basements should also be avoided.
- 2) Heat: The unit should be situated away from heat sources such as radiators, kitchen range, etc. It also should not be placed in rooms where the temperature is less than 5°C (41°F) or greater than 40°C (104°F).

Placement

- 1) Stacking: Do not place heavy objects on top of this unit.

- 2) Foreign Material: Care should be taken so that objects do not fall into and liquids are not spilled into the unit. Do not subject this unit to excessive smoke, dust, mechanical vibration, or shock.
- 3) Surface: Place the unit on a flat, level surface.

For best performance

- 1) If noise prevents the conversation from being understood at the portable handset, approach the base unit to lessen the noise.
- 2) The portable handset should be used at the "HIGH" volume setting when the reception tone is difficult to hear.
- 3) The portable handset should be fully recharged on the base unit when the BATT LOW indicator flashes.
- 4) The small-sized antenna of the portable handset should not be touched during use because of its high sensitivity.
- 5) The possible calling distance may be shortened when the unit is used in the following places:
Near obstacles such as hills, tunnels, undergrounds, near metal objects such as wire fences, etc.

For your future reference

Serial No. _____ Date of purchase _____
(found on the bottom of the unit)

Name of dealer _____

Dealer's address _____

WARNING:

TO PREVENT FIRE OR SHOCK HAZARD, DO NOT EXPOSE THIS PRODUCT TO RAIN OR ANY TYPE OF MOISTURE.

When a failure occurs which results in the internal parts becoming accessible, disconnect AC adaptor immediately and return this unit to service center.

If there is any trouble, disconnect the unit from the telephone line and connect a known working phone. If the known working phone operates properly, do not reconnect the unit to the telephone line until the trouble has been repaired. If the known working phone does not operate properly, consult with a telephone company.

Quick Reference Guide

Thank you for purchasing the Panasonic KX-T4300BA.

- Please read the Operating Instructions for details.
- Keep this leaflet for your next use.

Check the accessories:

- | | |
|--|---|
| <input type="checkbox"/> AC Adaptor one | <input type="checkbox"/> Wall Mounting |
| <input type="checkbox"/> Telephone Line Cord . . one | Adaptor one |
| <input type="checkbox"/> Micro Cassette Tape . . one | <input type="checkbox"/> Screw two |
| | <input type="checkbox"/> Washer two |

How to Set Up the Unit

1. Insert the tape before plugging in the AC adaptor.

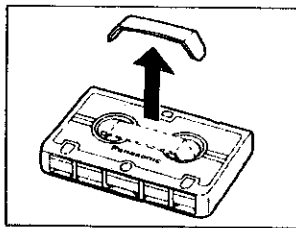

Remove the stopper.

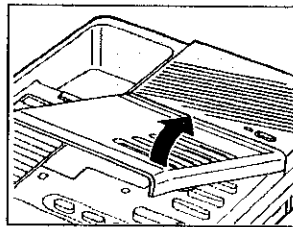

Open the panel.

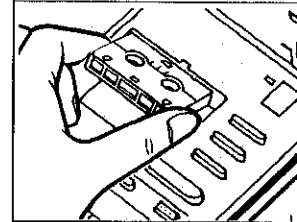

Insert the tape with full reel to the right and the exposed tape facing you.

2. Connect the unit as shown.

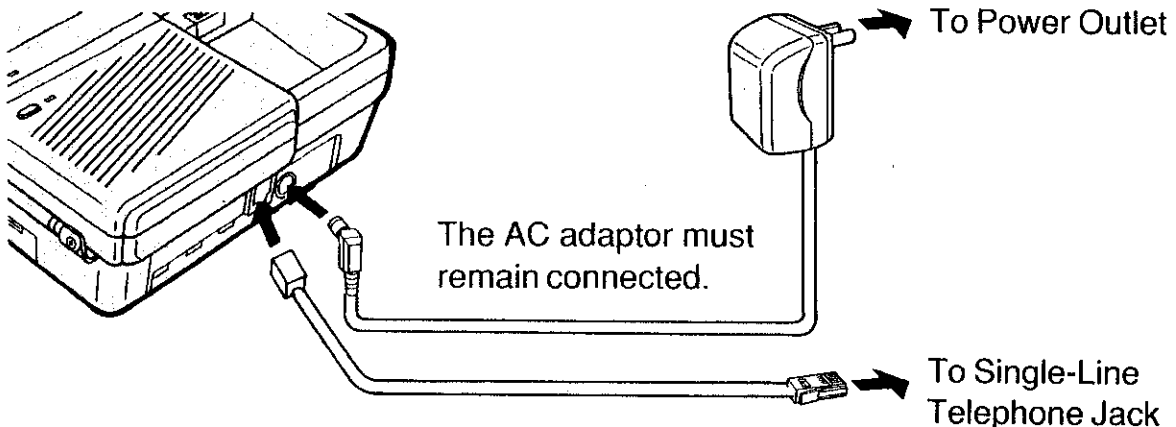

How to Operate the Unit

Charge the portable handset battery before initial use.

The battery is beneath this cover.

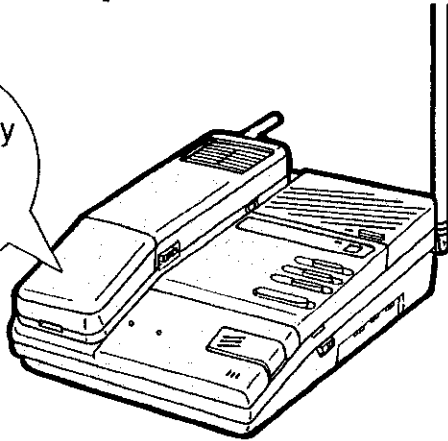

Place the portable handset on the base unit for about 10 hours.

Extend antennas fully during use.

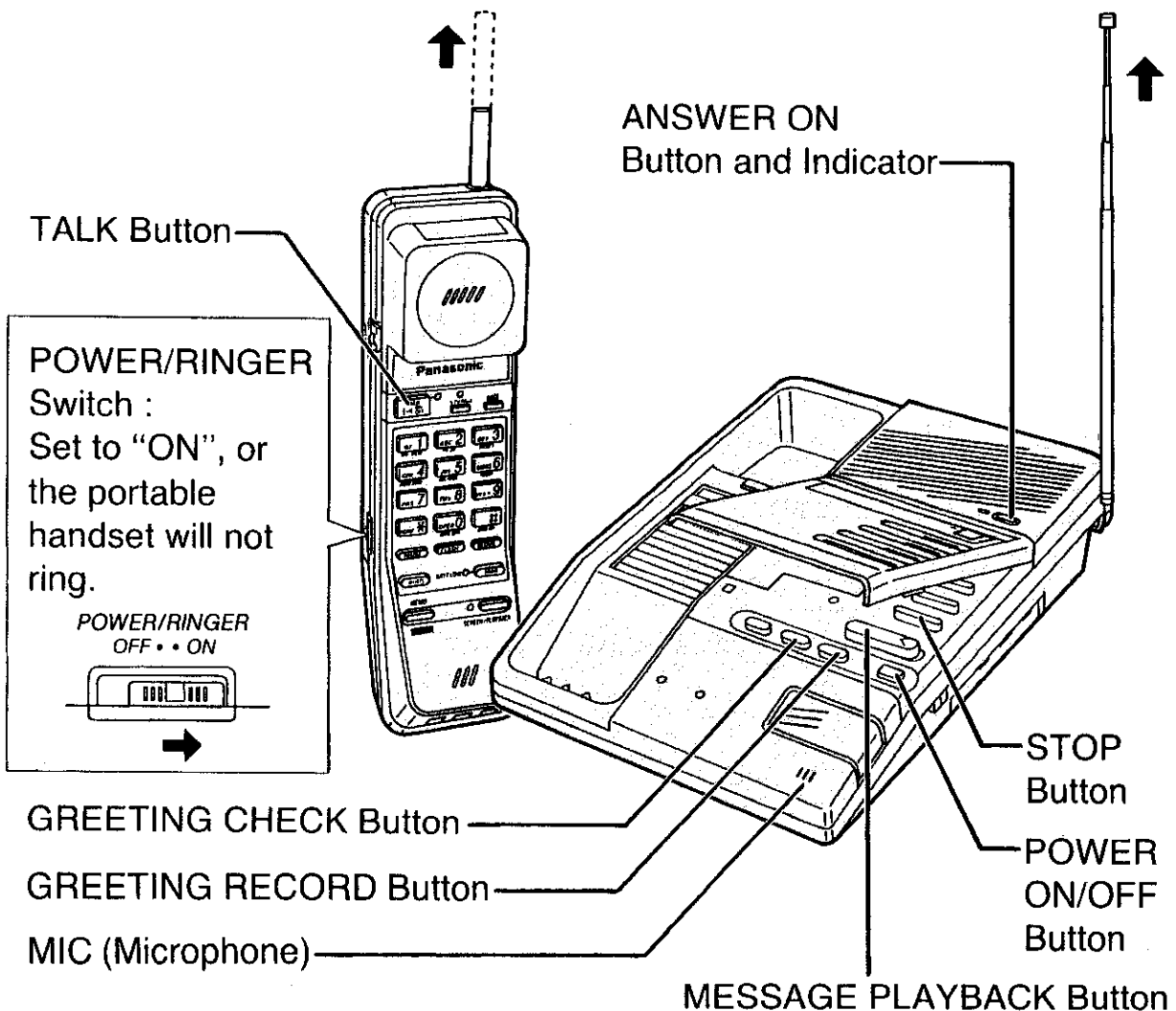

Sample of a greeting message:

"Hello, this is Smith. Sorry, I can't take your call. Please leave your message after a long beep. You have up to 2 minutes to record your message. Thank you."

Recording a greeting message

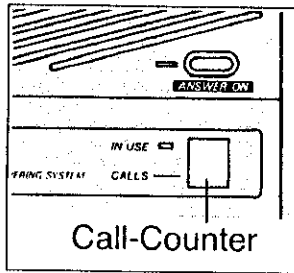

Confirm that the **ANSWER ON** indicator light is on.

- If the light is off, press **ANSWER ON** to turn on the answering system.
- If the Call-Counter light is off, press **POWER ON/OFF** to turn on the power.

1

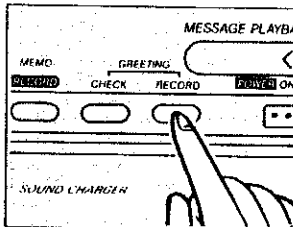

Open the panel and press **GREETING RECORD**.

A series of short tones will sound, followed by a long beep.

2

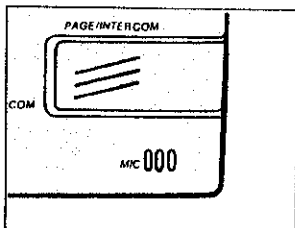

Speak clearly into the **MIC**, right after the long beep.

The Call-Counter counts up your recording time, up to 30 seconds.

- Do not pause for over 2 seconds while recording. If quick 6 beeps sound and the Call-Counter shows "E (Error)", start again from step 1.

3

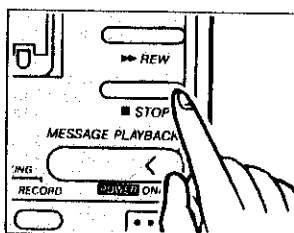

Press **STOP** to stop recording.

To check the greeting message, press **GREETING CHECK**.

- If you wish to re-record, start from step 1.

Listening to the recorded incoming messages

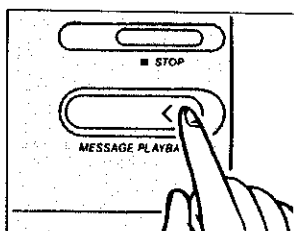

Press **MESSAGE PLAYBACK**.

At the end of the last message, 3 beeps sound and the tape stops. Then, the tape rewinds and resets itself. The new messages are recorded over old messages.

- To save messages, see page 34 in the Operating Instructions.

(continued on next page)

Making calls

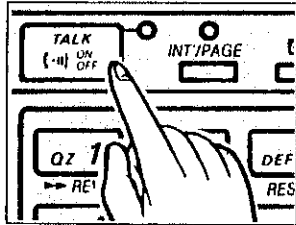

Press **TALK** to get dial tone.

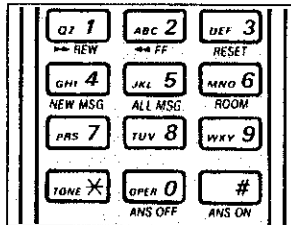

Dial a phone number.

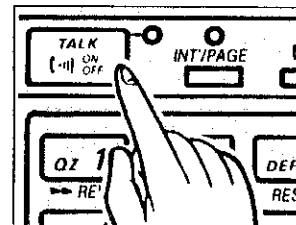

When the conversation is over, press **TALK** or place the portable handset on the base unit.

If you have difficulty in dialing, check the dialing mode. See page 17 in the Operating Instructions.

Answering calls

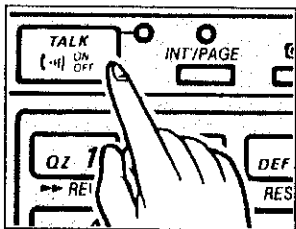

If the portable handset is off the base unit, press **TALK**.

OR

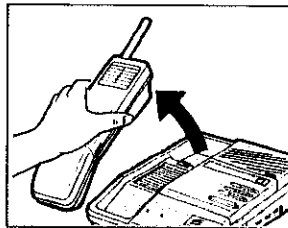

If the portable handset is on the base unit, just lift it.

Attention

When the BATT LOW indicator flashes or a beep sounds every 15 seconds during a conversation, place the portable handset on the base unit to charge the battery.

Do not place the unit near electrical appliances or obstacles. This might cause interference or shorten the possible operating range while using the cordless telephone.

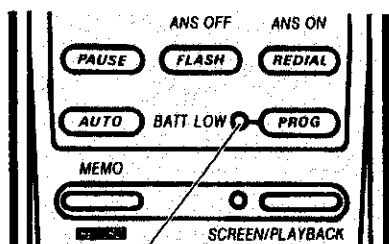

BATT LOW Indicator

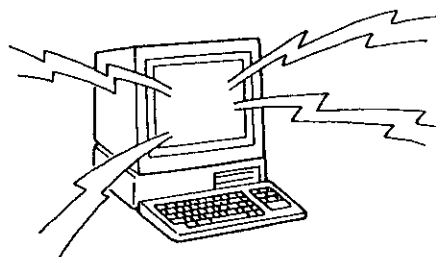

Free Manuals Download Website

<http://myh66.com>

<http://usermanuals.us>

<http://www.somanuals.com>

<http://www.4manuals.cc>

<http://www.manual-lib.com>

<http://www.404manual.com>

<http://www.luxmanual.com>

<http://aubethermostatmanual.com>

Golf course search by state

<http://golfingnear.com>

Email search by domain

<http://emailbydomain.com>

Auto manuals search

<http://auto.somanuals.com>

TV manuals search

<http://tv.somanuals.com>