

Panasonic

900MHz Cordless Answering System

Model No. **KX-TC1731W**
KX-TC1731B

Pulse-or-tone dialing capability

Operating Instructions



KX-TC1731B

**PLEASE READ BEFORE USE
AND SAVE.**

Caller ID Compatible

Charge the battery for about 4 hours before initial use.

Panasonic World Wide Web address: <http://www.panasonic.com>
for customers in the USA or Puerto Rico

Before Initial Use

Please read **IMPORTANT SAFETY INSTRUCTIONS** on page 72 before use.
Read and understand all instructions.

Thank you for purchasing your new Panasonic cordless telephone.

Caller ID and Visual Call Waiting (Call Waiting ID), where available, are telephone company services. After subscribing to Caller ID, this phone will display the caller's name and phone number. An added service, Visual Call Waiting, will display the second caller's name and phone number during call waiting.

Attach your purchase receipt here.

For your future reference

Serial No. _____

Date of purchase _____

(found on the bottom of the unit)

Name and address of dealer _____

Accessories (included) For extra orders, call 1-800-332-5368.

- AC Adaptor (p. 13)
Order No. PQLV1Z

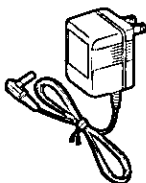

one

- Telephone Line Cord (p. 13)

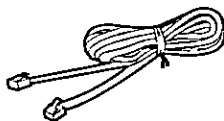

one

For Best Performance

Battery Charge

A rechargeable Ni-Cd battery powers the handset. Charge the battery for about **4 hours** before initial use (p. 14).

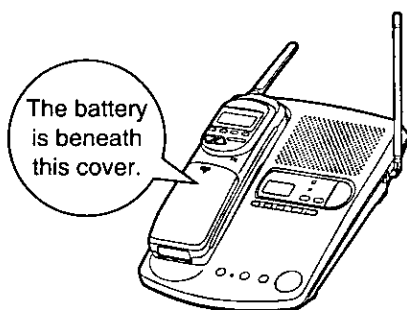

Base Unit Location

Calls are transmitted between the base unit and the handset using wireless radio waves. **For maximum distance and noise free operation**, the recommended base unit location is:

Away from electrical appliances such as a TV, radio or personal computer.

In a **HIGH and CENTRAL** location with no obstructions such as walls.

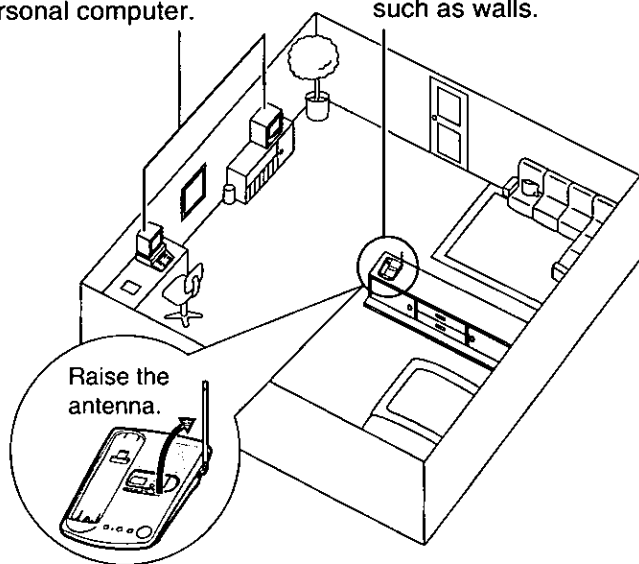

Contents

Preparation

Location of Controls	6
Displays	10
Settings	13
Connections.....	13
Battery Charge	14
Selecting the Dialing Mode.....	16
Selecting the Line Mode	17
Storing Your Area Code	18
Storing a Second Area Code.....	19
Setting the Auto Talk Feature.....	20
Selecting the Ringer Volume	21
Wall Mounting.....	22
Preparing the Answering System	23
Greeting Message	23
Programming Summary for the Answering System.....	25
Time and Day Adjustment	26
Selecting the Caller's Recording Time	27
Selecting the Number of Rings.....	28

Cordless Telephone

Making Calls	29
Answering Calls	31
Speed Dialer	32
Storing Phone Numbers in Memory	32
Dialing a Stored Number	33
Caller ID Service	34
Using the Caller List	36
Viewing the Caller List.....	36
Calling Back from the Caller List	38
Editing the Caller's Phone Number	39
Storing Caller List Information in Speed Dialer Memory.....	40
Erasing the Caller List Information	41

Intercom	42
Special Features	43
How to Use the PAUSE Button (For Analog PBX Line/Long Distance Service Users)	43
Temporary Tone Dialing (For Rotary or Pulse Service Users)	43
Automatic Security Code Setting	44
For Call Waiting Service Users.....	44
FLASH Button.....	45

Answering System

Automatic Answering Operation	46
Setting the Unit to Answer Calls	46
Listening to Messages	47
From the Handset.....	48
Erasing Messages	49
Pager Call	50
Storing a Pager Number	50
Storing Your Home Telephone Number	52
Pager Mode Setting.....	54
Setting the Unit to Call a Pager	55
Remote Operation from a Touch Tone Phone	56
Setting the Remote Code	57
Voice Menu.....	58
Direct Remote Operation.....	60
Remote Operation with the Handset	62

Useful Information

Battery Replacement	64
Adding Another Phone	64
Before Requesting Help	65
Important Safety Instructions	72
FCC and Other Information	74

Location of Controls

Handset (Front)

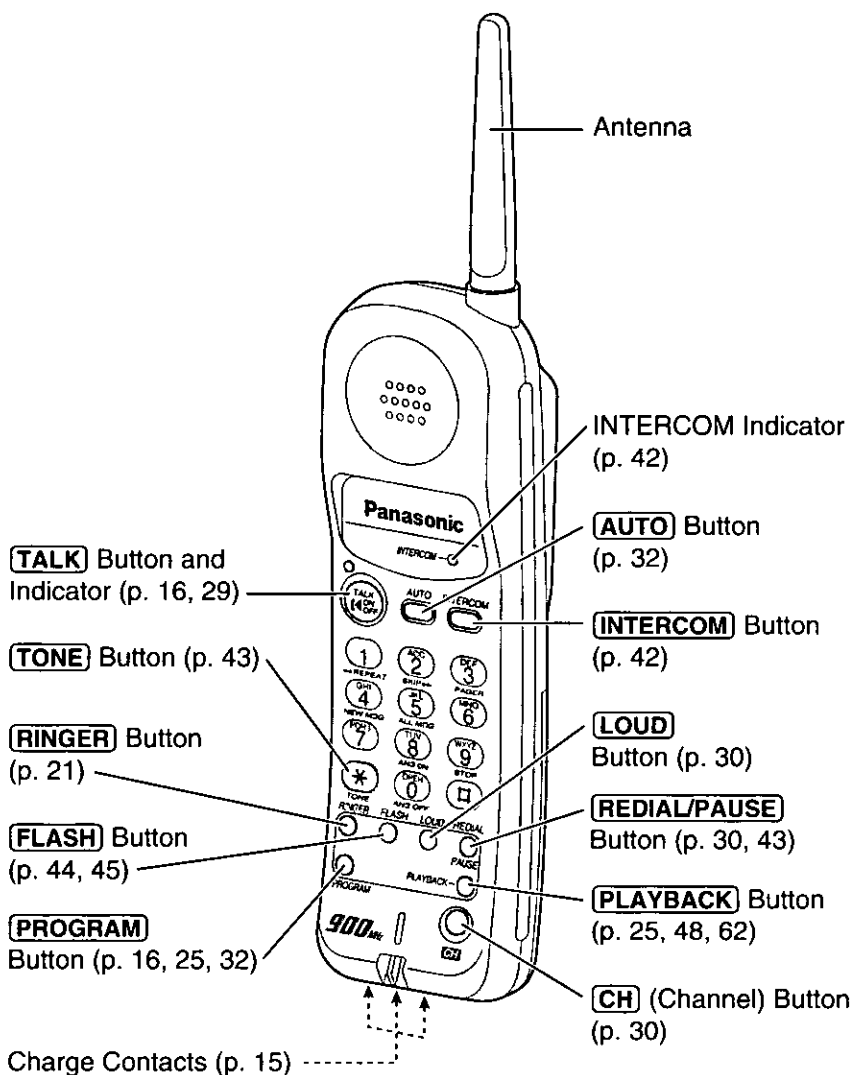



Handset (Back)

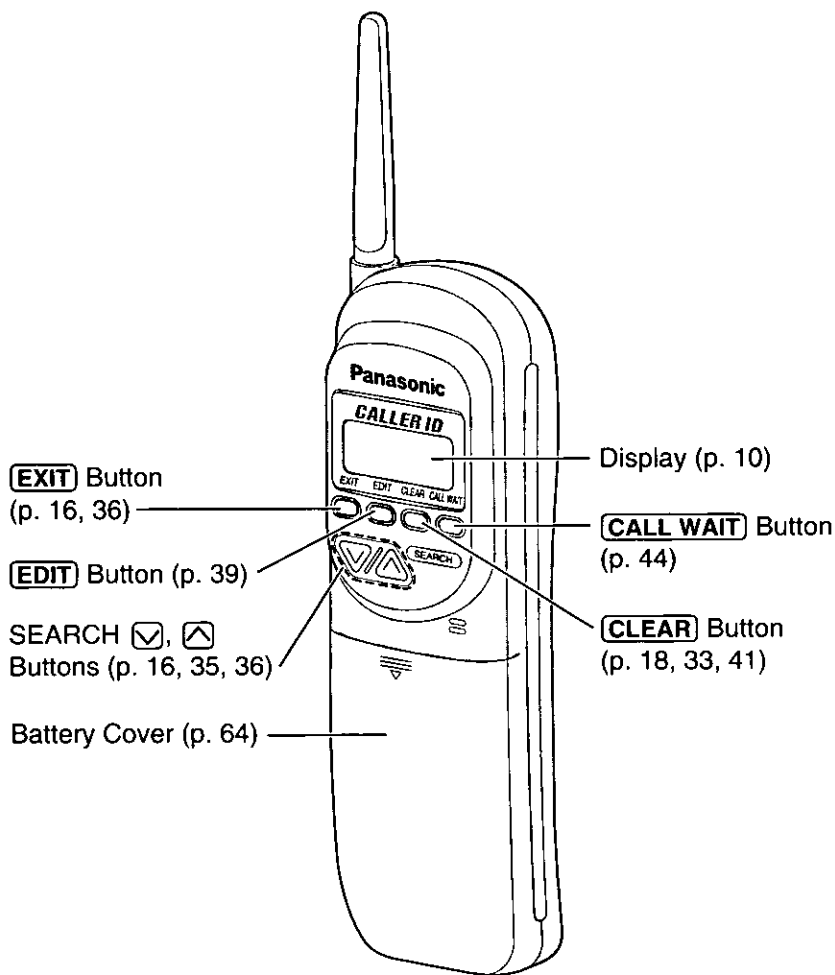

➔ Location of Controls

Base unit

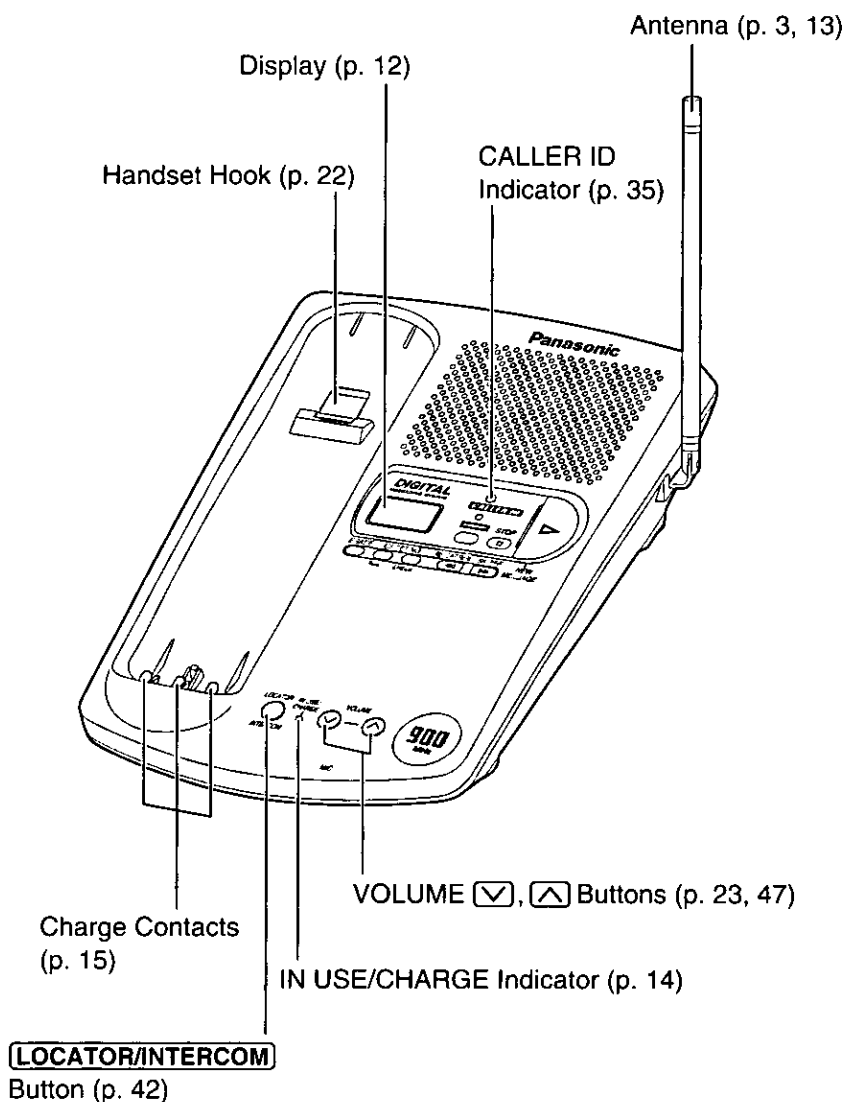

NEW MESSAGE Button (p. 47)

STOP Button (p. 23, 47)

ANSWER ON Button
and Indicator (p. 46, 47)

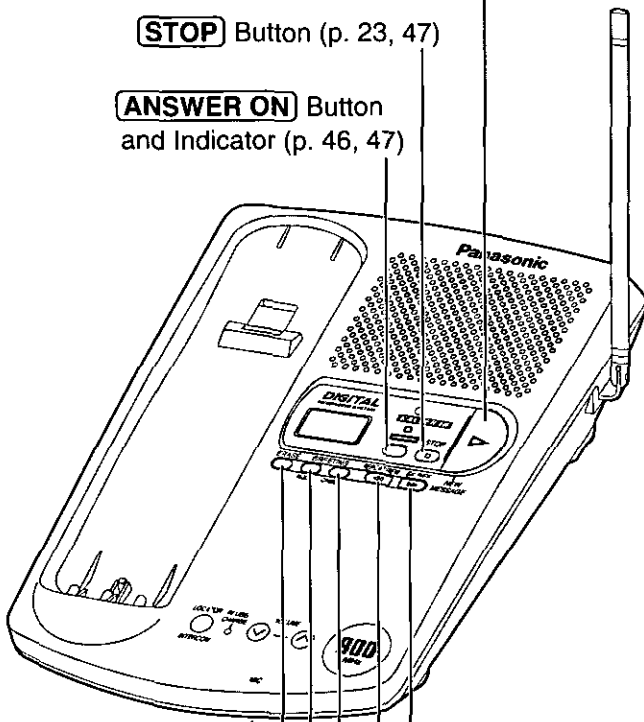

MIC (Microphone) (p. 23, 42)

SKIP/FF (Fast Forward)
Button (p. 47)

ERASE Button (p. 24, 49)

REPEAT/REW (Rewind)
Button (p. 47)

GREETING REC (Record)
Button (p. 23)

GREETING CHECK Button (p. 23)

Displays

Both the handset and the base unit show you information and instructions on their displays. These display prompts are shown below.

Handset display

No items stored

The Caller List is empty.

Recharge

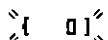

The battery needs to be charged. Place the handset on the base unit to charge the battery (p. 14).

12 new calls

{ 000 }

The display shows the number of new calls and the battery strength while the handset is on the base unit.

12 new calls

v=New ^=Old

This display will be shown when:

- you lift the handset off the base unit, or
- **SEARCH** or is pressed when the handset is off the base unit.

To search from the most recent call, press **SEARCH** (New key). To search from the oldest call, press **SEARCH** (Old key) (p. 36).

⊠ Ringer off ⊠

When the handset ringer volume is set to OFF (p. 21), "Ringer off" will flash for about 45 seconds before the handset returns to the stand-by mode (p. 15).

Talk

01-06-35 { 000 }

During a conversation, the display shows the length of the call (ex. 1 hour, 6 minutes and 35 seconds). The battery strength is also displayed (p. 14).

Out of range

The handset has lost communication with the base unit. Move closer to the base unit.

Save error

While programming, the handset lost communication with the base unit. Move closer to the base unit.

TINA ROBINSON

1-000-222-3333

When a call is received, the display shows the caller's name and number after the first ring.



JACK SMITH
111-2222
11:20A JAN12 x3

This is a name from the Caller List.
The display shows:

- the caller's name,
- the caller's number,
- the time and date of the last call (ex. Jan. 12, 11:20 AM), and
- the number of times called (ex. 3 times).

Paging
Press INTERCOM

The base unit is paging the handset (p. 42).

Intercom
00-00-07 {000}

The handset and the base unit are in the intercom mode (p. 42).

NANCY BROWN
1-000-222-3333
----Waiting----

A second call is received during a conversation (p. 44).

Please lift up
and try again

SEARCH or was pressed while the handset was on the base unit. Lift the handset and press **SEARCH** or again.

Not available

SEARCH or , **PLAYBACK** or **INTERCOM** was pressed while the base unit was not in the stand-by mode.

Answering
system setting
{000}

The unit is in answering system programming mode (p. 25).

Remote
operation
{000}

The handset is operating the answering system remotely (p. 62).

⇒ Displays

Base unit display



The clock needs adjusting (p. 26).

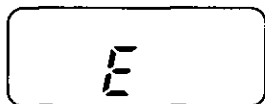

Your greeting message was not recorded correctly. Record it again (p. 23).

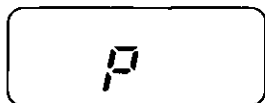

The unit is in the answering system programming mode.

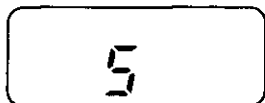

The speaker volume level is set to "5".

You can select:

- 9 levels (0–8) while using the answering system (p. 23, 47).
- 8 levels (1–8) while using the intercom (p. 43).

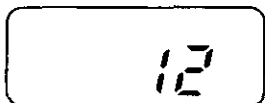

12 messages have been recorded.

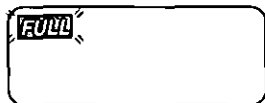

Memory is full. Erase some or all of the messages (p. 49).



The recording time is set to "greeting only" (p. 28). (The display is blank.)



The pager call mode is set to ON (p. 55).



Connections

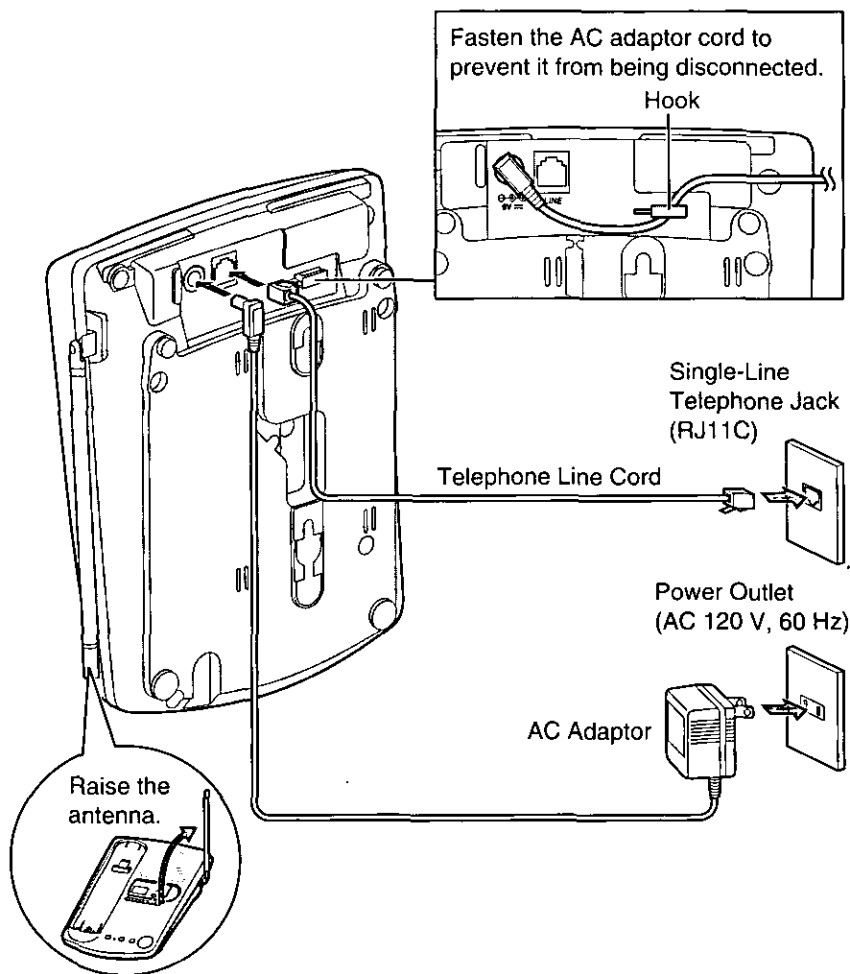

- USE ONLY WITH Panasonic AC ADAPTOR PQLV1 (Order No. PQLV1Z).
- The AC adaptor must remain connected at all times. (It is normal for the adaptor to feel warm during use.)
- To connect a standard telephone on the same line, see page 64.
- If your unit is connected to a PBX which does not support Caller ID services, you cannot access those services.

Battery Charge

Place the handset on the base unit and charge for about **4 hours** before initial use.

- The IN USE/CHARGE indicator lights.

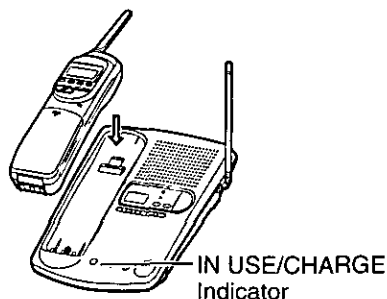

Battery strength

You can check the present battery strength on the display while the handset is on the base unit, while it is in use (making/answering a call etc.), or after viewing the Caller List, programming, etc. The battery strength will remain for 5 seconds after using the handset, then the display will return to the stand-by mode (see next page).

The battery strength is shown as in the chart below.

Display prompt	Battery strength
{ □ □ □ }	Fully charged
{ □ □ }	Medium
{ □ }	Low
⋈ { □ } ⋈ (flashing)	Needs to be recharged.

Recharge

Recharge the battery when:

- “Recharge” is displayed on the handset,
- “{ □ }” flashes on the handset display, or
- the handset beeps intermittently while it is in use.

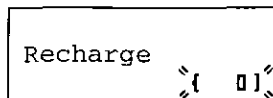

- If you DO NOT recharge the handset battery for more than 15 minutes, the display will keep indicating “Recharge” and/or “{ □ }” will continue to flash.



Battery information

After your Panasonic battery is fully charged (p. 14);

Operation	Approx. battery life
While in use (TALK)	Up to about 8 hours
While not in use (Stand-By)	Up to about 21 days

- Battery life may be shortened depending on usage conditions, such as viewing the Caller ID Caller List, and ambient temperature.
- **Clean the handset and the base unit charge contacts with a soft, dry cloth once a month. Clean more often if the unit is subject to grease, dust or high humidity.** Otherwise the battery may not charge properly.
- If the battery is fully charged, you do not have to place the handset on the base unit until "Recharge" is displayed and/or "[01]" flashes. This will maximize the battery life.
- The battery cannot be overcharged.

Stand-by mode (The handset is off the base unit.)

The handset goes into the stand-by mode after you finish using the handset (making/answering a call, viewing the Caller List, etc.).

The display is blank, but the handset can receive calls.

The battery life is conserved in this mode.

Selecting the Dialing Mode

You can program the dialing mode using the handset near the base unit. If you have touch tone service, set to "Tone". If rotary or pulse service is used, set to "Pulse". Your phone comes from the factory set to "Tone".
The TALK indicator light must be off before programming.

1 Press **PROGRAM**.

- The TALK indicator flashes.

Save AUTO# ?
v=Next ^=Yes

2 Press **SEARCH** (Next key) repeatedly until "Set dial mode ?" is displayed.

Set dial mode ?
v=Next ^=Yes

3 Press **SEARCH** (Yes key).

Dial mode
v=Tone ^=Pulse

4 To select "Pulse", press **SEARCH** .
OR

To select "Tone", press **SEARCH** .

Dial mode
Pulse

- A beep sounds.
- The handset will return to the stand-by mode.

Dial mode
Tone

- To cancel during programming, press **EXIT** or **PROGRAM**. Start again from step 1.
- If 3 beeps sound and the display shows "Save error", move closer to the base unit and try again. If "Save error" is still displayed, place the handset on the base unit. Start again from step 1.



Selecting the Line Mode

If the line is connected to a low voltage system such as a PBX, set to "B". Otherwise the Visual Call Waiting (Call Waiting ID) Service may not be available (p. 44), and the unit may not alert your pager (p. 50). Your phone comes from the factory set to "A".

The TALK indicator light must be off before programming.

- 1 Press **PROGRAM**.
 - The TALK indicator flashes.

```
Save AUTO# ?
v=Next      ^=Yes
```

- 2 Press **SEARCH** (Next key) repeatedly until "Set line mode ?" is displayed.

```
Set line mode ?
v=Next      ^=Yes
```

- 3 Press **SEARCH** (Yes key).

```
Line mode
v=A          ^=B
```

- 4 To select "B", press **SEARCH** .

OR

 To select "A", press **SEARCH** .

```
Line mode
B
```

- A beep sounds.
- The handset will return to the stand-by mode.

```
Line mode
A
```

- To cancel during programming, press **EXIT** or **PROGRAM**. Start again from step 1.
- If 3 beeps sound and the display shows "Save error", move closer to the base unit and try again. If "Save error" is still displayed, place the handset on the base unit. Start again from step 1.

Storing Your Area Code

We recommend that you program your area code first before using the Caller ID feature (p. 34). Incoming calls from the same area code will then be recorded in the Caller List without the area code. You do not have to remove the area code before calling back or storing. When incoming calls from a different area code are received, "1" will automatically be added before the area code.

The TALK indicator light must be off before programming.

1 Press **PROGRAM**.

- The TALK indicator flashes.

Save AUTO# ?
v=Next ^=Yes

2 Press **SEARCH** (Next key).
Be sure that "Area code ?" is displayed.

Area code ?
v=Next ^=Yes

3 Press **SEARCH** (Yes key).
• The current setting is displayed.
If no area code has been programmed, "----" will be displayed.

Area code	:---
Enter area code	

4 Enter your area code.
• If you enter a wrong number, press **CLEAR**, and enter the correct number.

Area code	:123
PROGRAM=Save	

5 Press **PROGRAM** (Save key).

- A beep sounds.
- The handset will return to the stand-by mode.

Area code	:123
-----------	------

• To cancel during programming, press **EXIT**. Start again from step 1.

To erase the area code

Press **PROGRAM** ⇨ **SEARCH** (Next key) ⇨ **SEARCH** (Yes key) ⇨ ⇨ **CLEAR** ⇨ **PROGRAM** (Save key).

- If a "2nd area code" has been stored (p. 19), it will also be cleared automatically.



Storing a Second Area Code

You can program another local area code. This area code does not require a "1" before it when dialing. After storing this area code, the display will show the 10 digits (3-digit area code plus 7-digit phone number) after a call is received from that area code. Calls will be recorded in the Caller List without "1". You cannot store a second area code unless your area code is stored first (p. 18).

The TALK indicator light must be off before programming.

1 Press **PROGRAM**.

- The TALK indicator flashes.

Save AUTO# ?

v=Next ^=Yes

2 Press **SEARCH** (Next key) repeatedly until "2nd area code ?" is displayed.

2nd area code ?

v=Next ^=Yes

3 Press **SEARCH** (Yes key).

- The current setting is displayed.
If no second area code has been programmed, "---" will be displayed.
- If 3 beeps sound, your area code is not stored. Store the code first (p. 18), then start from step 1.

2nd area code

:---

Enter area code

4 Enter a second area code.

- If you enter a wrong number, press **CLEAR**, and enter the correct number.

2nd area code

:124

PROGRAM=Save

5 Press **PROGRAM** (Save key).

- A beep sounds.
- The handset will return to the stand-by mode.

2nd area code

:124

- To cancel during programming, press **EXIT**. Start again from step 1.

To erase the second area code

Press **PROGRAM** \Rightarrow **SEARCH** (Next key) twice \Rightarrow

\Rightarrow **SEARCH** (Yes key) \Rightarrow **CLEAR** \Rightarrow **PROGRAM** (Save key).

Setting the Auto Talk Feature

The Auto Talk feature allows you to answer a call by lifting the handset off the base unit without pressing **TALK**. If you want to view caller's information on the display after lifting the handset, turn this feature OFF by programming. Your phone comes from the factory set to ON.

The TALK indicator light must be off before programming.

1 Press **PROGRAM**.

- The TALK indicator flashes.

```
Save AUTO# ?
v=Next    ^=Yes
```

2 Press **SEARCH** (Next key) repeatedly until "Talk switching?" is displayed.

```
Talk switching?
v=Next    ^=Yes
```

3 Press **SEARCH** (Yes key).

```
Auto talk
v=On      ^=Off
```

4 To select OFF, press **SEARCH** .
OR

To select ON, press **SEARCH** .

- A beep sounds.
- The handset will return to the stand-by mode.

```
Auto talk
Off
```

```
Auto talk
On
```

- To cancel during programming, press **EXIT** or **PROGRAM**. Start again from step 1.
- To answer a call when the Auto Talk feature is OFF, lift the handset off the base unit, and press **TALK**.



Selecting the Ringer Volume

The TALK indicator light must be off.

To select HIGH (preset) or LOW

Press **RINGER**.

- Each time you press the button, the ringer volume will change and the selected volume will ring.

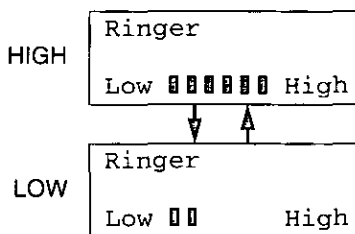

To turn the ringer OFF

Press and hold **RINGER** until 2 beeps sound.

- "Ringer off" will flash for about 45 seconds before the handset returns to the stand-by mode.

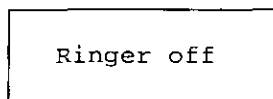

To turn the ringer ON

Press **RINGER**.

- The ringer will sound at the HIGH level.



Wall Mounting

This unit can be mounted on a wall phone plate.

- 1 Pull down the handset hook until it locks, **so the tab holds the handset.**

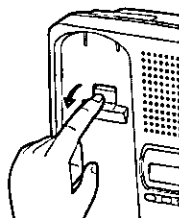

- 2 Connect the AC adaptor.

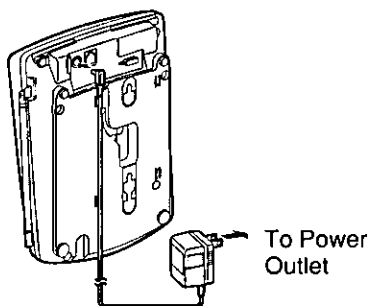

- 3 Connect the telephone line cord. Mount the unit, then slide down.
 - Raise the antenna.

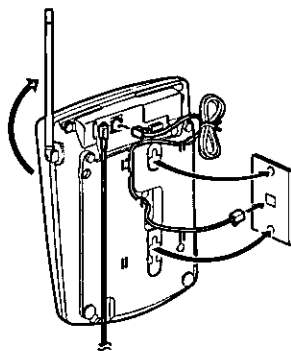

- 4 **To charge the battery:**
Place the handset on the handset hook as shown.
 - The IN USE/CHARGE indicator lights.

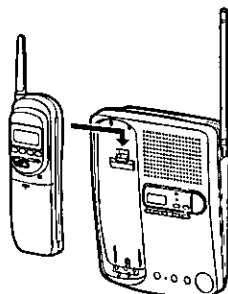

Preparing the Answering System ➔

Greeting Message

You can record a personal greeting message of **up to 2 minutes**. If a greeting message is not recorded, one of two pre-recorded greetings will be played when a call is received (p. 24).

All messages (greeting, incoming, etc.) are stored in digital memory (p. 24).
The **total recording time is about 15 minutes**.

We recommend you record a **brief greeting message** (see sample on next page) in order to leave more time for recording new messages.

To record a greeting message

- 1 Press **GREETING REC** to start the recording mode.
 - "Press RECORD again to record greeting" is heard.
- 2 Within 5 seconds, press **GREETING REC** again to record your greeting.
 - A long beep sounds.
- 3 After the long beep, talk clearly, about 8 inches (20 cm) away from the **MIC** (microphone).
 - The base unit display shows the elapsed recording time.
 - If you record for over 2 minutes, the unit will stop recording automatically.
- 4 When finished, press **STOP**.
 - **To check** the recorded greeting, press **GREETING CHECK**.
 - **To change** the message, repeat from step 1.

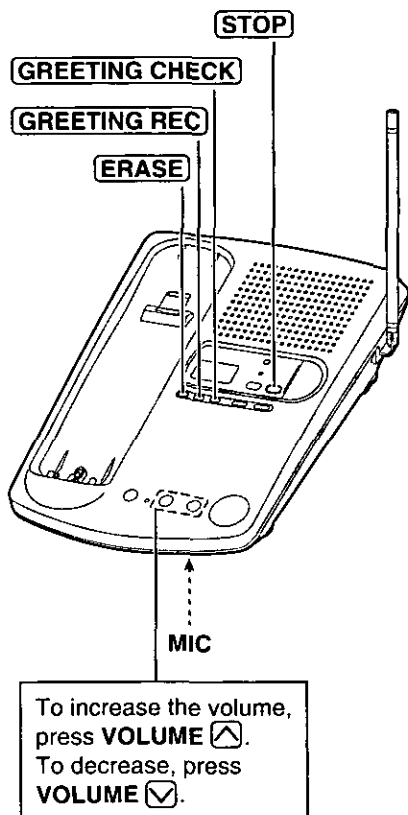

➔ Preparing the Answering System

Greeting message sample

"Hello, this is (your name and/or number). Sorry I cannot take your call. Please leave a message after the beep. Thank you."

To erase the recorded greeting message

Press **GREETING CHECK** ⇒ press **ERASE** while the message is being played.

- The unit will answer calls with a pre-recorded greeting.

Pre-recorded greeting message

If you do not record a greeting message (p. 23), one of two messages will be played when a call is received, depending on the caller's recording time (p. 27).

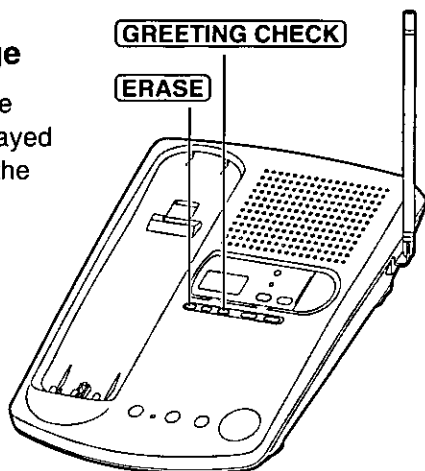

To check the pre-recorded greeting, press **GREETING CHECK**.

- A pre-recorded greeting will be played as follows:
 - When the recording time is set to "1 minute" or "3 minutes";
"Hello, we are not available now. Please leave your name and phone number after the beep. We will return your call."
 - When the recording time is set to "greeting only";
"Hello, we are not available now. Please call again. Thank you for your call."

Flash Memory Message Backup

Messages are stored indefinitely on a "flash memory" IC chip and will not be affected by power failures. All messages are saved until you erase them.



Programming Summary for the Answering System

You can program the following functions using the handset near the base unit. See the page numbers below for details.

The TALK indicator light must be off before programming.

Lift the handset, and press **PROGRAM**.



Press **PLAYBACK**.
• "Answering system setting" is displayed on the handset.



• If the handset displays "Out of range" and an alarm tone sounds, move closer to base unit and try again.

- To adjust **the time and day**, press **0**. (page 26)
- To set **the remote code**, press **1**. (page 57)
- To select **the number of rings**, press **2**. (page 28)
- To select **the caller's recording time**, press **5**. (page 27)
- To select **the pager mode setting**, press **6**. (page 54)
- To store **your home telephone number**, press **7**. (page 52)
- To store a **pager number**, press **#**. (pages 50, 51)
- The base unit display shows numbers or characters related to the adjustment or settings.



Press **PROGRAM**.
• A long beep sounds.
• If 6 beeps sound, the setting is not correct. Start again from the beginning.

- To cancel during programming, press **PROGRAM**. Start again from the beginning.
- If 6 beeps sound during programming, a wrong key was pressed. Enter the correct number.

Time and Day Adjustment

Voice Time/Day Stamp: During playback, a synthesized voice will announce the time and day that each message was recorded.

- 1 Press **PROGRAM**.
 - The TALK indicator flashes.
- 2 Press **PLAYBACK**.
 - "P" is displayed on the base unit.
- 3 Press **0**.
 - "Set time" is announced.
If previously adjusted, the time/day will be heard.
- 4 Enter the current time (hour and minute) using a 4-digit number.
(Ex. To set 9:30, enter "0930").
 - The entered number is displayed on the base unit.
- 5 Press ***** to select "AM" or "PM".
Press **#** repeatedly to set the day.
- 6 Press **PROGRAM**.
 - The unit announces the time/day.
The clock starts working.



- In step 4, you cannot enter numbers greater than 12. **Do not use military time.** (To set 13:00 hours, enter "0100" and select "PM" by pressing *****.)

If a power failure occurs, the adjusted time/day will be erased.
Reprogram the current time/day.

To check the time/day

Press **PROGRAM** ⇒ **PLAYBACK** ⇒ **0**.

- The current time/day is heard. When finished, press **PROGRAM**.



For Caller ID service users (p. 34)

- The Caller ID information will re-set the clock after the first ring if the adjusted time is incorrect. However, if the time has not previously been set (p. 26), the Caller ID information will not adjust the clock.
- The Caller ID information will automatically adjust the clock for daylight saving time.

Selecting the Caller's Recording Time

You can select "1 minute", "3 minutes" or "greeting only" for the caller's recording time. Your phone comes from the factory set to "3 minutes".

- 1 Press **PROGRAM**.
 - The TALK indicator flashes.
- 2 Press **PLAYBACK**.
 - "P" is displayed on the base unit.
- 3 Press **5**.
 - The current setting is displayed on the base unit.
 - 1: 1 minute
 - 2: 3 minutes (factory preset)
 - 3: greeting only
- 4 Press **1**, **2** or **3** to select the recording time.
 - The setting is displayed on the base unit.
- 5 Press **PROGRAM**.
 - A beep sounds.



If you select "greeting only", the unit will answer a call with the greeting message, and then hang up. The unit will not record any incoming messages.

Selecting the Number of Rings

You can select the number of times the unit rings before the answering system answers a call, from "2" to "7" or "AUTO (for Toll Saver*)". Your phone comes from the factory set to "AUTO".

- 1 Press **PROGRAM**.
 - The TALK indicator flashes.
- 2 Press **PLAYBACK**.
 - "P" is displayed on the base unit.
- 3 Press **2**.
 - The current setting is displayed on the base unit.
- 4 Press **0**, or **2** to **7** to set the number of rings.
 - 0: Selects "AUTO".
"A" is displayed.
 - 2-7: The unit will answer after the selected number of rings.
- 5 Press **PROGRAM**.
 - A beep sounds.



*Toll Saver (When set to "AUTO")

When you call the unit from a touch tone telephone:

If the unit answers on the 2nd ring, there is at least one new message.

If the unit answers on the 4th ring, there are no new messages.

Hang up when you hear the 3rd ring. This will save you the toll charge for the call.

Making Calls

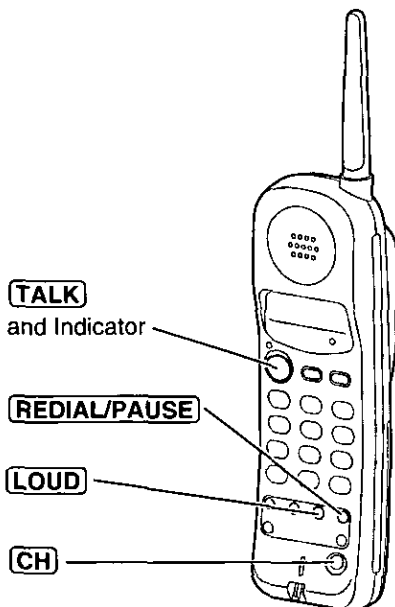

- 1** Press **TALK**.
- The TALK indicator lights.
 - The selected channel number is displayed.

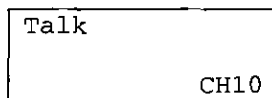

- 2** Dial a phone number.
- The dialed number is displayed.
 - After a few seconds, the display will show the length of the call and the present battery strength.

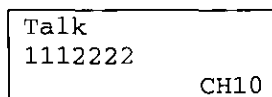

- 3** To hang up, press **TALK** or place the handset on the base unit.
- The indicator light goes out.
 - The display will return to the stand-by mode.

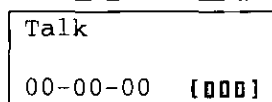

- If "Out of range" is displayed and an alarm tone sounds in step 1, move closer to the base unit or place the handset on the base unit. Then try again.

➔ Making Calls

To redial the last number dialed on the handset

Press **TALK** ⇒ **REDIAL/PAUSE**.

To select the receiver volume

Press **LOUD** while talking.

- Each time you press the button, the volume level will change from MEDIUM (preset) to HIGH to LOW.
- The display will return to the length of the call.

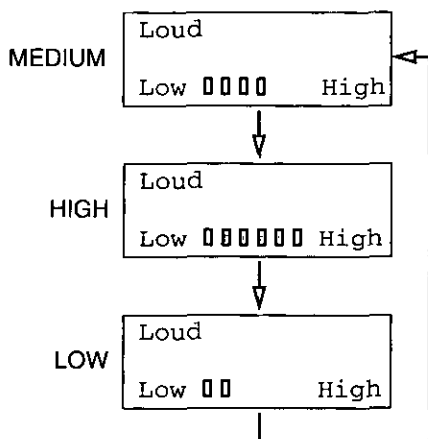

If noise interferes with the conversation

Press **CH** to select a clearer channel or move closer to the base unit.

- The selected channel number is displayed.

Talk	
00-01-30	CH12

Lighted handset keypad

The handset dialing buttons will light when you press a button or lift the handset off the base unit, and flash when a call is received. The lights will go out about 10 seconds after pressing a button, lifting the handset or answering a call.

Backlit LCD display

The lighted handset display will stay on for about 10 seconds after pressing a handset button or lifting the handset off the base unit.

Answering Calls

If you subscribe to a Caller ID service, the calling party information will be displayed on the handset after the first ring (p. 34). In order to view the CALLER ID information, please wait until the second ring to answer a call.

If the handset is off the base unit, press **TALK**.

- You can also answer a call by pressing any dialing button **0** to **9**, ***** or **#** (— **Any Key Talk**).

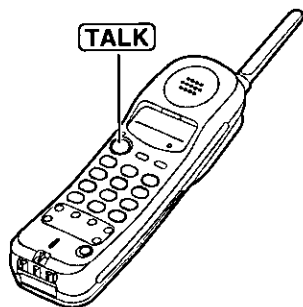

Cordless Telephone

OR

If on the base unit, just lift up.
(This is not available when the Auto Talk feature is set to OFF. See page 20.)

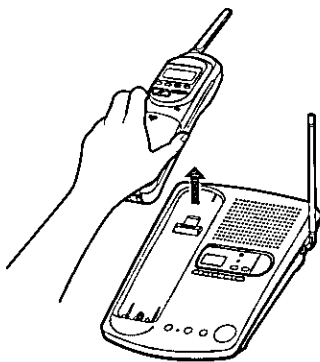



Speed Dialer

Storing Phone Numbers in Memory

You can store up to 10 phone numbers in the handset. The dialing buttons (0 to 9) function as memory stations.

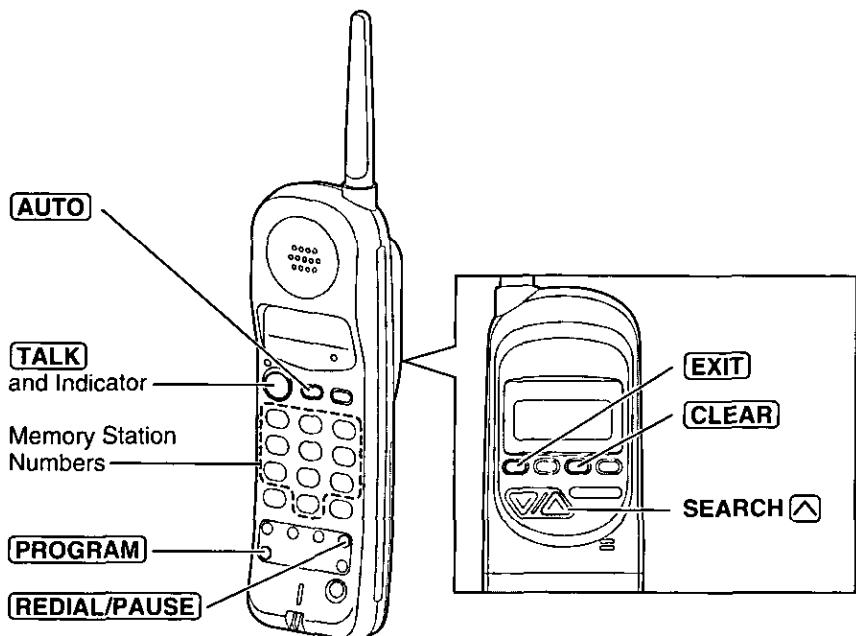
The TALK indicator light must be off before programming.



- 1 Press **PROGRAM**.
 - The TALK indicator flashes.
- 2 Press **SEARCH**  (Yes key).
- 3 Enter a phone number up to 22 digits.
 - If you misdial, press **CLEAR**. Digits are erased from the right.
- 4 Press **AUTO**.

Save AUTO# ?

v=Next ^=Yes

Enter phone no.

3334444

AUTO=Save

Select 0-9
to save in AUTO

5 Press a memory station number (0 to 9).

- A beep sounds.
- The handset will return to the stand-by mode.
- To store other numbers, repeat steps 1 through 5.

3334444

Save in AUTO 1

- To cancel during programming, press **PROGRAM** or **EXIT**. Restart from step 1.
- If a pause is required for dialing, press **REDIAL/PAUSE** where needed. Pressing **REDIAL/PAUSE** counts as one digit (p. 43).

To erase a stored number

1 Press **PROGRAM**.

- The TALK indicator flashes.

Save AUTO# ?

v=Next ^=Yes

2 Press **SEARCH** \wedge (Yes key).

Enter phone no.

3 Press **CLEAR**.

AUTO=Clear

4 Press **AUTO**.

Select 0-9 to
clear in AUTO

5 Press the memory station number (0 to 9) for the phone number to be erased.

Clear in AUTO 1

Dialing a Stored Number

1 Press **TALK**.

2 Press **AUTO**.

3 Press the memory station number (0 to 9).

- The stored number is dialed.

- If your line has rotary or pulse service, any access numbers stored after pressing **TONE** will not be dialed.

Caller ID Service

This unit is compatible with a Caller ID service offered by your telephone company. After you subscribe to a Caller ID service, the calling party information will be displayed on the handset after the first ring.

The unit can record information of up to 50 different callers, including the time and date received and the number of times called, in the Caller List. The Caller List information is sorted from the most recent to the oldest call. When the 51st call is received, the first call is deleted.

Using the list, you can automatically call back a caller. You can store the callers' numbers from the Caller List into the handset's Speed Dialer memory.

If you subscribe to a Visual Call Waiting (Call Waiting ID) service, when a second call is received, the new caller's name and phone number will be displayed (p. 44).

How caller information is displayed when a call is received

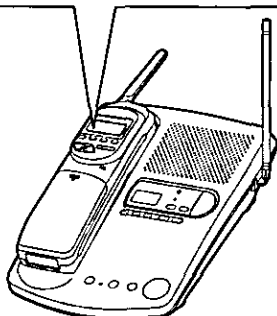
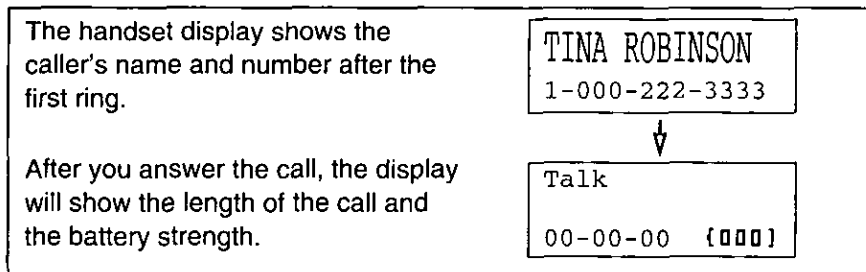

- Caller information cannot be displayed in the following cases:
 - If the caller dialed from an area which does not provide a Caller ID service, the display will show "Out of area".
 - If the caller has requested not to display his/her information, the display will show "Private caller".

- If your unit is connected to a PBX which does not support Caller ID services, you cannot access those services.
- In some calling areas, the name display service may not be available. For further information, please contact your telephone company.

To check the number of new calls

When new calls have been received, the CALLER ID indicator flashes on the base unit.

While the handset is on the base unit:

If you have received 10 new calls, the display will show the following.

```
10 new calls
  [000]
```

When you lift the handset, the display changes to the following.

```
10 new calls
v=New    ^=Old
```

- After 10 seconds, the display changes to the stand-by mode (p. 15).

CALLER ID Indicator

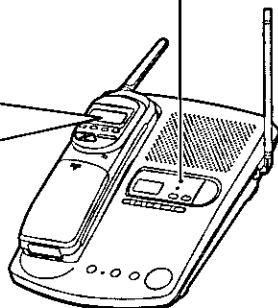

Cordless Telephone

While the handset is off the base unit:

Press **SEARCH** or to turn the display on. If you have received 10 new calls, the display will show the following.

```
10 new calls
v=New    ^=Old
```

SEARCH

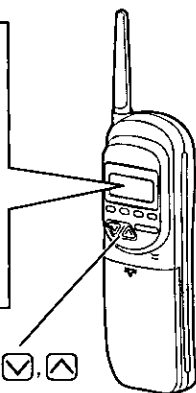

Using the Caller List

Viewing the Caller List

To confirm who has called you, follow the steps below.

The **TALK** indicator light must be off.

- 1 Lift the handset off the base unit.
OR
If the handset is off the base unit, press **SEARCH** or to enter the list.

- The display will show the following.

2 new calls	
v=New	^=Old

- 2 To search from the most recent to oldest call, press **SEARCH**
(New key).
To search from the oldest to most recent call, press **SEARCH**
(Old key).

- To scroll between callers, press **SEARCH** or .

- 3 To exit the list, press **EXIT**.

- The handset will return to the stand-by mode.

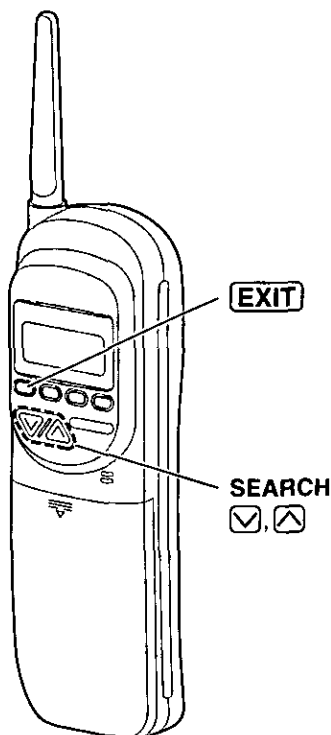

- Once new calls have been checked, "√" will be added.
- If "No items stored" is displayed in step 1, the Caller List is empty. Press **EXIT** to exit the list.
- If more than one call is received from the same caller, the date and time of the last call will be recorded. Also, when the same caller calls again, the call entry with "√" will be deleted.



Ex. When you search from the most recent call:

Lift the handset off the base unit.

OR

If the handset is off the base unit, press **SEARCH** or .

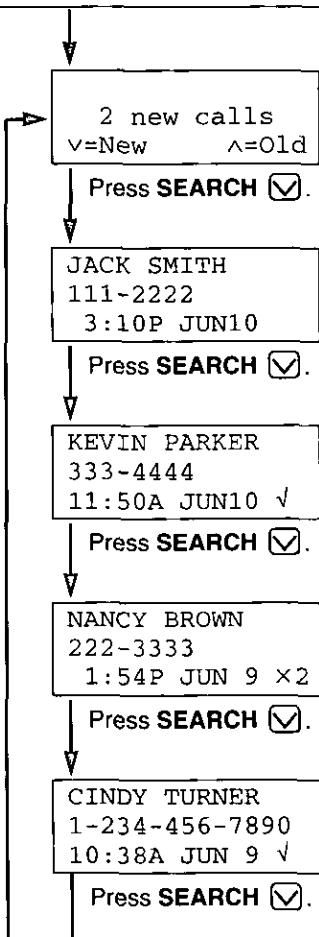

To return to the previous caller, press **SEARCH** .

To exit the Caller List, press **EXIT**.

- The handset will return to the stand-by mode.

- If the caller does not have name information, the display will only show the phone number.

Cordless Telephone

Display meaning:

- ✓ : You have checked this caller information, answered the call, called back the caller or played back the message.
- ×2-×9 : The number of times the same caller called (up to 9). After checking, "×2" - "×9" will be replaced with "✓".

Calling Back from the Caller List

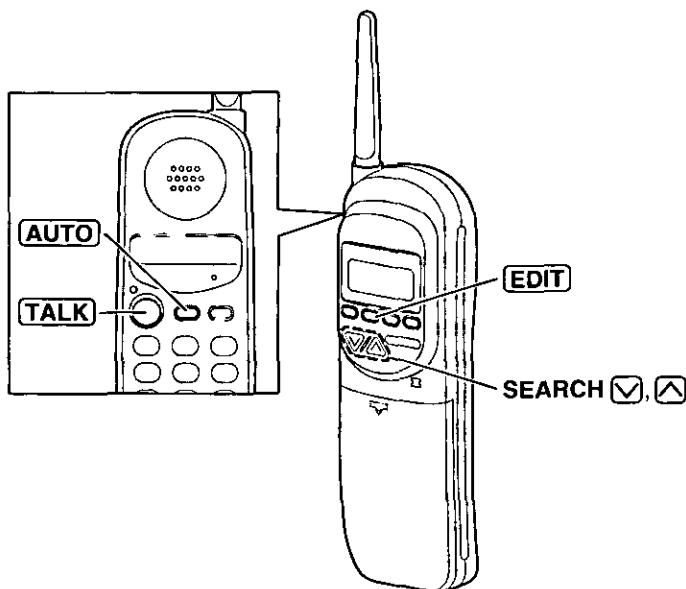

- 1 Lift the handset off the base unit.
OR
If the handset is off the base unit,
press **SEARCH** or to enter the list.

3 new calls
v=New ^=Old

- 2 Press **SEARCH** or repeatedly to find
the desired caller.

CINDY TURNER
1-234-456-7890
11:20A JAN12 x3

- 3 Press **TALK**.
• The displayed phone number is dialed
automatically.

Talk
12344567890
CH11

Talk
00-00-00 {000}

- In some cases you may have to edit the number before dialing (p. 39).
(Ex. You may have to add "1" for long distance calls.)
If you have not stored your area code (p. 18), the edited number will not
be saved in the Caller List.
- If a phone number is not displayed in the caller information, you cannot
call back that caller.



Editing the Caller's Phone Number

The unit can edit a phone number into one of 4 patterns.

The **TALK** indicator light must be off.

- 1 Lift the handset off the base unit.
OR
If the handset is off the base unit, press **SEARCH** or to enter the list.

5 new calls	
v=New	^=Old

- 2 Press **SEARCH** or repeatedly to find the desired caller.

FRED PARKER
321-5555
11:20A JAN12 x3

- 3 Press **EDIT** to select a pattern. Each time you press **EDIT**, the number is rearranged into one of 4 different patterns.

a

FRED PARKER
1-321-5555
11:20A JAN12 x3

- a 1 - Phone no.
- b 1 - Area code - Phone no.
- c Area code - Phone no.
- d Phone no.

- The order in which patterns a - d are displayed depends on which pattern the telephone number is displayed in step 2.

b

FRED PARKER
1-234-321-5555
11:20A JAN12 x3

c

FRED PARKER
234-321-5555
11:20A JAN12 x3

d

FRED PARKER
321-5555
11:20A JAN12 x3

Cordless Telephone

- 4 After editing the number, you can continue with calling back or storing procedures.
To call back, press **TALK** (p. 38).
To store the number in the handset's Speed Dialer memory, press **AUTO**, then press a memory station number (0 to 9) (p. 40).

Using the Caller List

Storing Caller List Information in Speed Dialer Memory

You can store numbers that are in the Caller List into the Speed Dialer memory.

The TALK indicator light must be off.

- 1 Lift the handset off the base unit.
OR
If the handset is off the base unit, press **SEARCH** or to enter the list.

```
10 new calls
v=New      ^=Old
```

- 2 Press **SEARCH** or repeatedly to find the caller you want to store in memory.
- If the number requires editing, see page 39.

```
CINDY TURNER
1-234-456-7890
11:20A JAN12 x3
```

- 3 Press **AUTO**.

```
Save in AUTO
Select 0-9
```

- 4 Press a memory station number (**0** to **9**).
- A beep sounds.
 - The display will return to step 2. You can continue storing another item. To return to the stand-by mode, press **EXIT** or wait for 60 seconds.

```
12344567890
Save in AUTO 0
```

- To cancel during programming, press **EXIT**. Start again from step 1.
- You cannot store caller information in the Speed Dialer memory when a phone number is not displayed.

Erasing the Caller List Information

After checking the Caller List, you can erase some or all of the entries.
The TALK indicator light must be off.

To erase a specific caller from the Caller List

- 1 Lift the handset off the base unit.
OR
If the handset is off the base unit, press **SEARCH** or to enter the list.
- 2 Press **SEARCH** or repeatedly to find the caller you want to erase from the Caller List.
- 3 Press **CLEAR**.
 - A beep sounds and the information is erased.
 - In a few seconds, the display will show the previous caller information.
 - To return to the stand-by mode, press **EXIT** or wait for 60 seconds.

10 new calls
v=New ^=Old

TOM REAGAN
444-5555
12:20A JAN12 ✓

Clear

To erase all entries in the Caller List

- 1 Lift the handset off the base unit.
OR
If the handset is off the base unit, press **SEARCH** or to enter the list.
- 2 Press **CLEAR**.
- 3 Press **CLEAR** again.
 - A beep sounds and all entries are erased.
 - The handset will return to the stand-by mode.

Be sure this display is shown.

0 new call
v=New ^=Old

Press CLEAR for all clear

All clear

Intercom

A 2-way intercom is available between the handset and the base unit.

Paging the base unit from the handset

- 1 Handset:
Press **INTERCOM**. Talk to the paged party after the beep.
 - The indicator lights and "Intercom" is displayed.
- 2 Base unit:
When the other party's voice is heard, answer using the **MIC**.
- 3 Handset:
To end the intercom, press **INTERCOM**.

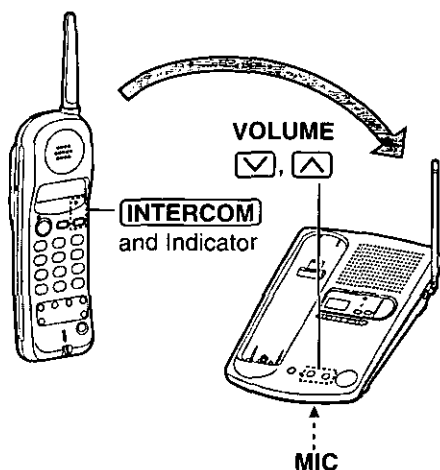



Paging the handset from the base unit (Handset locator)

Using this feature, you can locate a misplaced handset.

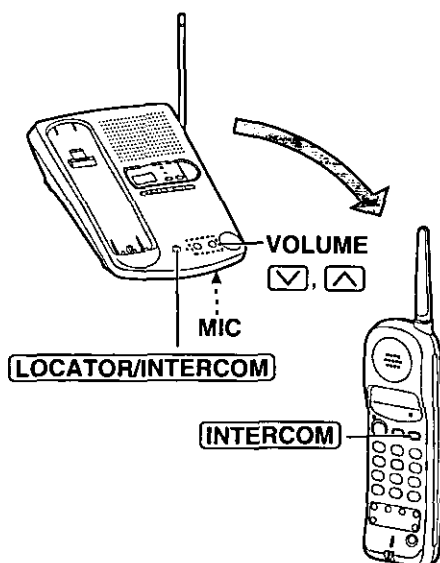
- 1 Base unit:
Press **LOCATOR/INTERCOM**.
 - The handset beeps for 1 minute and "Paging Press INTERCOM" is displayed.
 - To stop paging, press **LOCATOR/INTERCOM** again.
- 2 Handset:
Press **INTERCOM** to answer.
 - "Intercom" is displayed.
- 3 Base unit:
Talk into the **MIC**.
- 4 Handset:
To end the intercom, press **INTERCOM**.



To adjust the speaker volume (8 levels) while talking:

To increase, press **VOLUME** . To decrease, press **VOLUME** .

During the intercom call:

- Intercom calls can only be ended with the handset.
- If the handset user has difficulty hearing the base unit user, decrease the base unit speaker volume by pressing **VOLUME** .
- If an incoming call is received, the intercom call stops and the unit starts to ring.

Special Features

How to Use the PAUSE Button

(For Analog PBX Line/Long Distance Service Users)

We recommend you press **REDIAL/PAUSE** if a pause is required for dialing with a PBX or to access a long distance service.

Ex. Line access number **9** (PBX)

9 ⇨ **REDIAL/PAUSE** ⇨ Phone number

- Pressing **REDIAL/PAUSE** once creates a 3.5 second pause. This prevents misdialing when you redial or dial a stored number.
- Pressing **REDIAL/PAUSE** more than once increases the length of the pause between numbers.

Temporary Tone Dialing

(For Rotary or Pulse Service Users)

Press **TONE** before entering access numbers which require tone dialing.

- The dialing mode changes to tone. You can enter numbers to access an answering service, electronic banking service, etc. When you hang up, the mode will return to pulse.
- Access numbers entered after pressing **TONE** will not be included when redialing.

Automatic Security Code Setting

Whenever you place the handset on the base unit, the unit automatically selects one of a million security codes. These codes help prevent the unauthorized use of your telephone line by another cordless telephone user.

For Call Waiting Service Users

Press **CALL WAIT** if you hear a call-waiting tone while talking.

- The first call is put on hold and you can answer the second call.
- To return to the first caller, press **CALL WAIT** again.
- You can press **FLASH** instead of **CALL WAIT** on the handset.
- The call waiting service cannot be used when:
 - the answering system is recording someone's message, or
 - a parallel connected telephone is in use.
- If this function does not operate properly, consult your telephone company for details.

Visual Call Waiting (Call Waiting ID) Service

Visual Call Waiting (Call Waiting ID) Service allows your handset to display the second caller's information. After you hear a call-waiting tone while talking, the handset will display the caller's name with the phone number and "----Waiting----".

NANCY BROWN 1-000-222-3333 ----Waiting----
--

- Please contact your telephone company for details and availability in your area.

FLASH Button

Pressing **FLASH** allows you to use special features of your host PBX such as transferring an extension call or accessing special telephone services (optional) such as call waiting.

- You can press **CALL WAIT** instead of **FLASH** on the handset.

Selecting the flash time (call waiting time)

The flash time (call waiting time) depends on your telephone exchange or host PBX. You can select the following flash times (call waiting times) "700, 600, 400, 300, 250, 110, 100 or 90 ms (milliseconds)", **using the handset near the base unit**. Your phone comes from the factory set to "700 ms".

The TALK indicator light must be off before programming.

- 1 Press **PROGRAM**.
 - The TALK indicator flashes.

SAVE AUTO# ?
v=Next ^=Yes

- 2 Press **SEARCH** (Next key) repeatedly until "Set flash time?" is displayed.

Set flash time?
v=Next ^=Yes

- 3 Press **SEARCH** (Yes key).

Flash time
:700ms
v=Next ^=Save

- 4 Press **SEARCH** (Next key) repeatedly until the desired time is displayed.

- 5 Press **SEARCH** (Save key).

- A long beep sounds.
- The display will return to the stand-by mode.
- To cancel during programming, press **EXIT** or **PROGRAM**. Start again from step 1.
- If 3 beeps sound and the display shows "Save error", move closer to the base unit and try again. If "Save error" is still displayed, place the handset on the base unit. Start again from step 1.
- If you are connected via a PBX, a longer flash time may be necessary to use PBX functions (transferring a call, etc.). Consult your PBX installer for the correct setting.

Automatic Answering Operation

When the unit answers a call, a greeting message is played and the caller's message is recorded.

- The total recording time (including greeting message) is **about 15 minutes**. If messages are recorded in noisy rooms, the time may be shortened by up to 3 minutes.
- A maximum of 64 messages (including greeting message) can be recorded.

Setting the Unit to Answer Calls

Press **ANSWER ON** to turn on the answering system.

- The indicator lights and "Answer set" is heard.
- The unit will announce the remaining recording time if it is less than 5 minutes.
- If you hear "Memory full", "**FULL**" is displayed on the base unit and the ANSWER ON indicator flashes rapidly, erase some or all of the messages (p. 49).

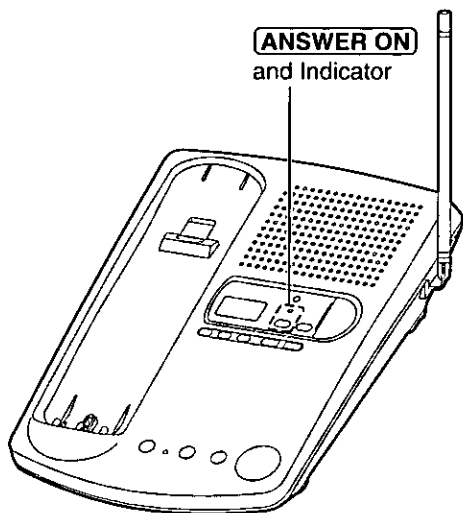

- If you do not want the unit to answer calls, press **ANSWER ON** again to turn off the answering system. The indicator light goes out and "Answer off" is heard.
- You can also turn on the answering system remotely using any other phone (p. 61).

Monitoring incoming calls

While a call is being recorded, you can monitor it through the speaker. To answer the call, lift the handset off the base unit or press **TALK**. The unit stops recording.

Listening to Messages



You can see the total number of recorded messages on the base unit display. If the ANSWER ON indicator flashes, new messages have been recorded.

Listening to only new messages

Press **NEW MESSAGE** briefly.

- The unit announces the number of new messages and plays them back.

Listening to all recorded messages

Press and hold **NEW MESSAGE** until playback starts.

- At the end of the last message, "End of final message" is heard. The unit will announce the remaining recording time if it is less than 5 minutes.

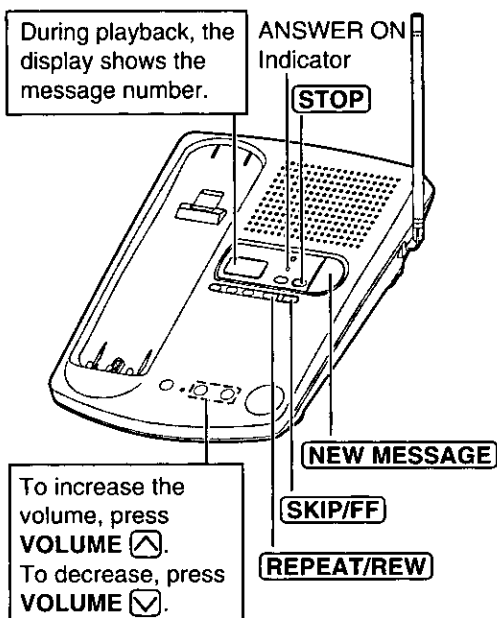

During playback

To repeat/ rewind message	To repeat from the beginning of the message: Press REPEAT/REW briefly. (If you press within 5 seconds of playback, the previous message will be played.) To rewind part of the message: Press and hold REPEAT/REW until you reach the desired place. <ul style="list-style-type: none">• At the beginning of the message, 3 beeps will sound.
To skip/cue message	To skip to the next message: Press SKIP/FF briefly. To cue to part of the message: Press and hold SKIP/FF until you reach the desired place. <ul style="list-style-type: none">• The message will be heard at twice the normal speed.• At the end of the message, 3 beeps will sound.
To stop operation	Press STOP . <ul style="list-style-type: none">• To resume playback, press NEW MESSAGE.• If you do not press any button for 60 seconds or if you press STOP again, the unit will return to the stand-by mode.

➔ Listening to Messages

For Caller ID service users (p. 34)

- During playback, when the handset is on the base unit, the handset display will show the name and/or number of the caller whose message is being played.

To call back the displayed number:

1. During playback, lift the handset.
 2. Press **TALK** within 10 seconds.
 - The unit stops playback and automatically dials the displayed phone number.
- After listening to new incoming messages, “√” will be added to the call entries in the Caller ID Caller List (p. 37).

From the Handset

If someone else is in the room and you want to listen to the recorded messages privately, you can use the handset.

- 1 Handset:
Press **PLAYBACK**.
 - The number of new messages is heard on the handset.

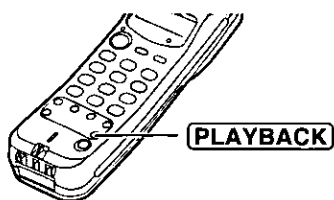

- 2 Base unit:
To listen to new messages, press **NEW MESSAGE** briefly.
To listen to all messages, press and hold **NEW MESSAGE** until playback starts.

- The messages will be heard on the handset.
- **REPEAT/REW**, **SKIP/FF** and **STOP** are also available during playback (p. 47).

- 3 When finished, press **PLAYBACK** or place the handset on the base unit.

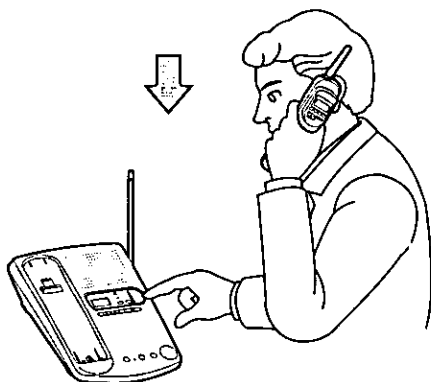

- You can also listen to messages without using the base unit. See page 62.

Erasing Messages

The unit will announce the remaining recording time after playback, if it is less than 5 minutes. New messages cannot be recorded when:

- "Memory full" is heard.
- "**FULL**" is displayed on the base unit.
- the ANSWER ON indicator flashes rapidly.

Erase some or all of the messages. We recommend you erase unnecessary messages after each playback.

Erasing a specific message

Press **ERASE** while the message you want to erase is being played.

- The unit erases the message.
- A short beep will sound and the unit will continue to play the next message.

Erasing all messages

All recorded messages, except the greeting message, can be erased at one time.

- 1 Press **ERASE**.
 - "Press ERASE again to erase all messages" is heard.
- 2 Within 5 seconds, press **ERASE** again.
 - A long beep sounds and "No messages" is heard. The base unit display shows "0".

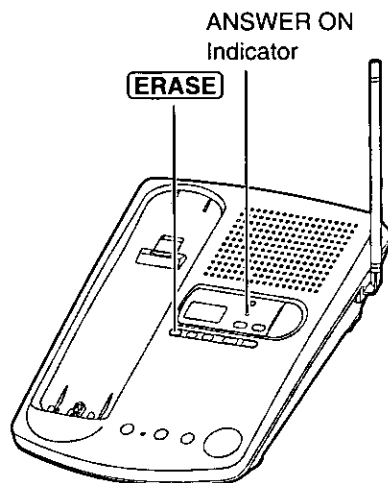

- The information in the caller list will not be erased.
To erase the Caller List information, see page 41.

Pager Call

This feature allows you to alert your pager when the unit records an incoming message or receives a Caller ID call (p. 54). You can retrieve the message from a touch tone telephone (p. 56). If you subscribe to a Caller ID service, the caller's telephone number will be displayed on your pager. First program the following settings (p. 50–54), then set the unit to call the pager. **The TALK indicator light must be off before programming.**

Storing a Pager Number

If you use a 1–800 pager number, see the next page for the storing procedure.

- 1 Press **PROGRAM**.
 - The TALK indicator flashes.
- 2 Press **PLAYBACK**.
 - “P” is displayed on the base unit.
- 3 Press **#**.
 - “-” is displayed on the base unit.
- 4 Enter your pager number, and press **REDIAL/PAUSE** twice.* Enter the access code, if required by your pager company, and press **REDIAL/PAUSE** twice again.*
 - The entered number is displayed on the base unit.
 - If you misdial, press **PROGRAM** and start again from step 1.
 - You can enter a total of 44 digits.
- 5 Press **PROGRAM**.
 - A beep sounds.

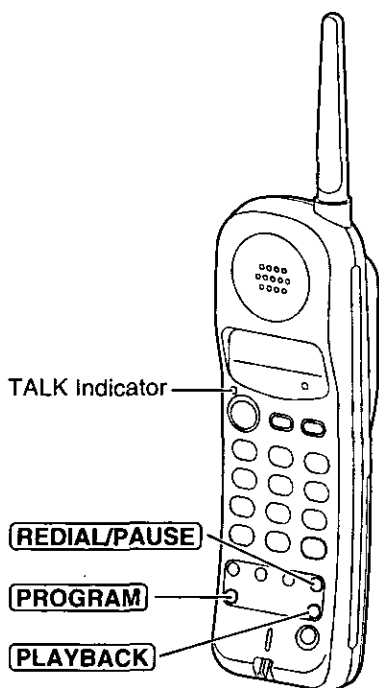

* Pager companies require a delay after the pager number and/or the access code is dialed. Contact your pager company regarding the required pause time. Pressing **REDIAL/PAUSE** once creates a 3.5 second delay and counts as one digit.

- If the line has rotary or pulse service, press ***** between the pager number and **REDIAL/PAUSE** in step 4.



Storing a 1-800 pager number

If you use a 1-800 pager number with a PIN code, store the pager number as follows.

- 1 Press **PROGRAM**.
 - The TALK indicator flashes.
- 2 Press **PLAYBACK**.
 - "P" is displayed on the base unit.
- 3 Press **#**.
 - "-" is displayed on the base unit.
- 4
 - ① Enter the 1-800 pager number, and press **REDIAL/PAUSE** 3 times.*
 - ② Enter the PIN code, and press **REDIAL/PAUSE** twice.*
 - If you misdial, press **PROGRAM** and start again from step 1.
 - You can enter a total of 44 digits.
- 5 Press **PROGRAM**.
 - A beep sounds.

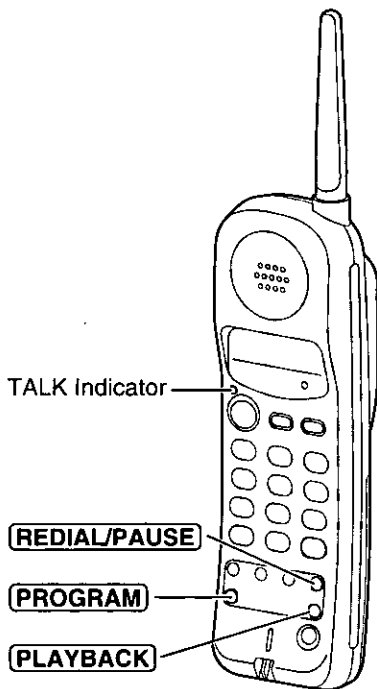

* Pager companies require a delay after the pager number and the PIN code are dialed. Contact your pager company regarding the required pause time. Pressing **REDIAL/PAUSE** once creates a 3.5 second delay and counts as one digit.

- If the line has rotary or pulse service, press ***** between the pager number and **REDIAL/PAUSE** in step 4.
- Alphanumeric voice dispatch pager services will not work with this function.

Storing Your Home Telephone Number

After storing your home telephone number, it will then be displayed on your pager when your family wants you to call home. (See useful information on page 53.)

- 1 Press **PROGRAM**.
 - The TALK indicator flashes.
- 2 Press **PLAYBACK**.
 - "P" is displayed on the base unit.
- 3 Press **7**.
 - "-" is displayed on the base unit.
- 4 Enter your home telephone number up to 10 digits.
 - The entered number is displayed on the base unit.
 - If you misdial, press **PROGRAM** and start again from step 1.
- 5 Press **PROGRAM**.
 - A beep sounds.

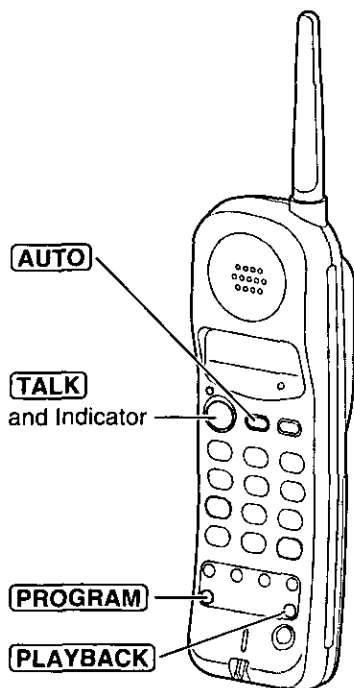

- Your pager will also display your home number if the unit receives a call from an area which does not provide the Caller ID service or the caller requests not to show their information. Please call home to check who alerted your pager.



To confirm the stored pager and home numbers

Press **TALK** ⇒ **AUTO** ⇒ **#**.

- The unit dials the stored pager number.
- The pager beeps, and displays your home number and "11".*
- If the pager does not beep or does not display your home number and "11", store the pager and home numbers again (p. 50–52).

Useful Information

Your family can let you know when they want you to call home by pressing **TALK** ⇒ **AUTO** ⇒ **#**.

* What "11" means

When your unit alerts your pager, "11" will be displayed after the caller's telephone number. "11" will not be displayed when another phone alerts your pager.

Ex. When the unit records a caller's message whose number is "2345678":

"234567811" will be displayed on your pager. If you select pager mode "2" (p. 54) and a caller does not leave a message, "00" will be displayed instead of "11".

Ex. When the caller whose number is "2345678" alerts your pager directly:

"2345678" will be displayed on your pager.

To erase the stored pager number

Press **PROGRAM** ⇒ **PLAYBACK** ⇒ **#** ⇒ **PROGRAM**.

- The pager call mode will automatically return to OFF (p. 55).

To erase the stored home telephone number

Press **PROGRAM** ⇒ **PLAYBACK** ⇒ **7** ⇒ **PROGRAM**.

Pager Mode Setting

After subscribing to a Caller ID service (p. 34), you can select one of the following pager mode settings. The unit will alert your pager:

1. after the unit records an incoming message (factory preset),
OR
2. each time the unit receives a Caller ID call, even if the caller does not leave a message.

If you want to change the mode, proceed as follows.

- 1 Press **PROGRAM**.
 - The TALK indicator flashes.
- 2 Press **PLAYBACK**.
 - "P" is displayed on the base unit.
- 3 Press **6**.
 - The current setting is displayed on the base unit.
- 4 To select "2", press **2**.
OR
To select "1", press **1**.
 - The entered number is displayed on the base unit.
- 5 Press **PROGRAM**.
 - A beep sounds.

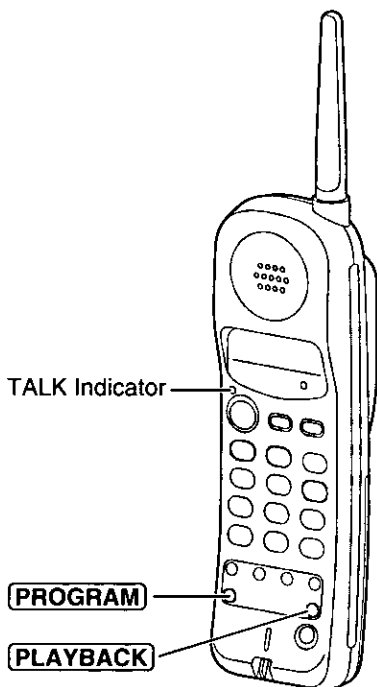

- If you select "2" and set the unit to call a pager (p. 55), the unit will alert your pager even if the answering system is not turned on.
- Even if you select "2", the unit will not alert your pager when a Caller ID call which does not have a phone number is received.

Setting the Unit to Call a Pager

- 1 Press **PLAYBACK**.
 - The number of new messages is heard on the handset.
- 2 Press **3**.
 - "**PAGER**" is displayed on the base unit.
 - If "**PAGER**" is not displayed, the pager number is not stored. Store the number (p. 50, 51), and try again.
- 3 Press **PLAYBACK**.

To turn off the pager call mode, repeat steps 1 through 3.

- "**PAGER**" will disappear.
- Each time you press **3** in step 2, the mode will turn on or off.

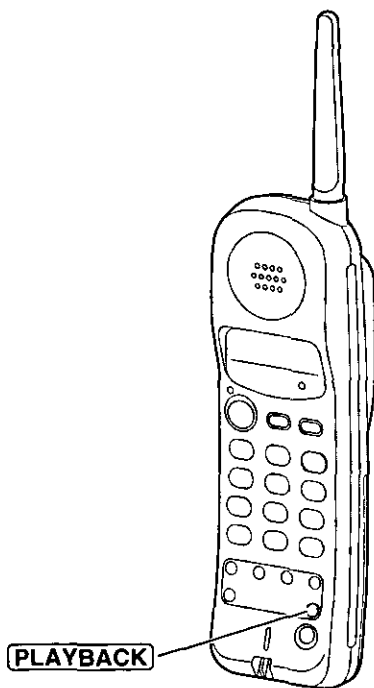

If you have not subscribed to a Caller ID service, the caller's telephone number will not be displayed on your pager.

- If another message (or Caller ID call) is received before the unit alerts your pager for a previous message (or Caller ID call), the previous caller information will not be sent to your pager. Only the last call received will be sent to your pager.
- If someone else makes or answers another call with the unit or a parallel connected phone before the unit alerts your pager for a previous message (or Caller ID call), the unit will stop alerting your pager for that message (Caller ID call).
- If you receive a caller's telephone number in your pager but cannot recognize the caller, you may have received a direct inward dial (DID) call, such as from a PBX. Please call your unit to check the caller's message.

Remote Operation from a Touch Tone Phone

You can operate the answering system from any touch tone phone. A synthesized voice menu will guide you on how to operate the unit (p. 58).

- To skip the voice menu and operate the unit directly, see page 60.

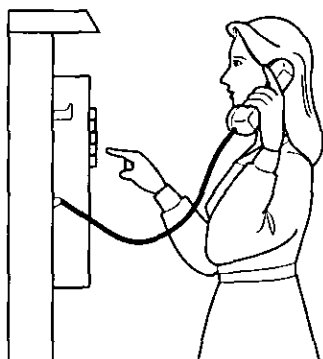

Summary of remote operation

Call your unit from a touch tone phone.



Enter your remote code (p. 57) during or after the greeting message.

- The number of new messages is heard.



After 3 seconds, the voice menu will start (p. 58).
Follow the menu or enter the direct commands (p. 60).



To end remote operation, hang up.

- The messages are saved.

- The unit will announce the remaining recording time after playback, if it is less than 5 minutes.



Setting the Remote Code

The remote code prevents unauthorized people from accessing your unit and listening to your messages. Choose any **2-digit number (00–99)**. The factory preset remote code number is “11”. If you do not program your own remote code number, you can use “11”.

The TALK indicator light must be off before programming.

- 1 Press **PROGRAM**.
 - The TALK indicator flashes.
- 2 Press **PLAYBACK**.
 - “P” is displayed on the base unit.
- 3 Press **1**.
 - The current remote code is displayed on the base unit.
- 4 Enter a remote code using a **2-digit number (00–99)**.
 - The entered number is displayed on the base unit.
- 5 Press **PROGRAM**.
 - A beep sounds.

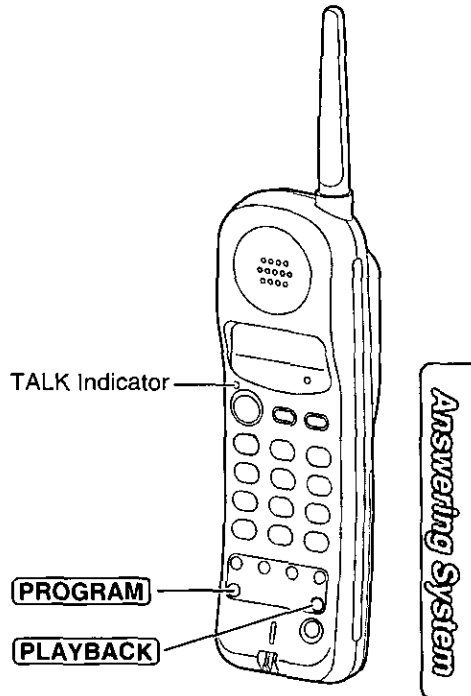

- If 6 beeps sound during programming, a wrong key was pressed. Enter the correct number.

To check the remote code

Press **PROGRAM** ⇒ **PLAYBACK** ⇒ **1**.

- The current remote code is displayed on the base unit. When finished, press **PROGRAM**.

➔ Remote Operation from a Touch Tone Phone

Voice Menu

The shaded boxes are voice prompts.

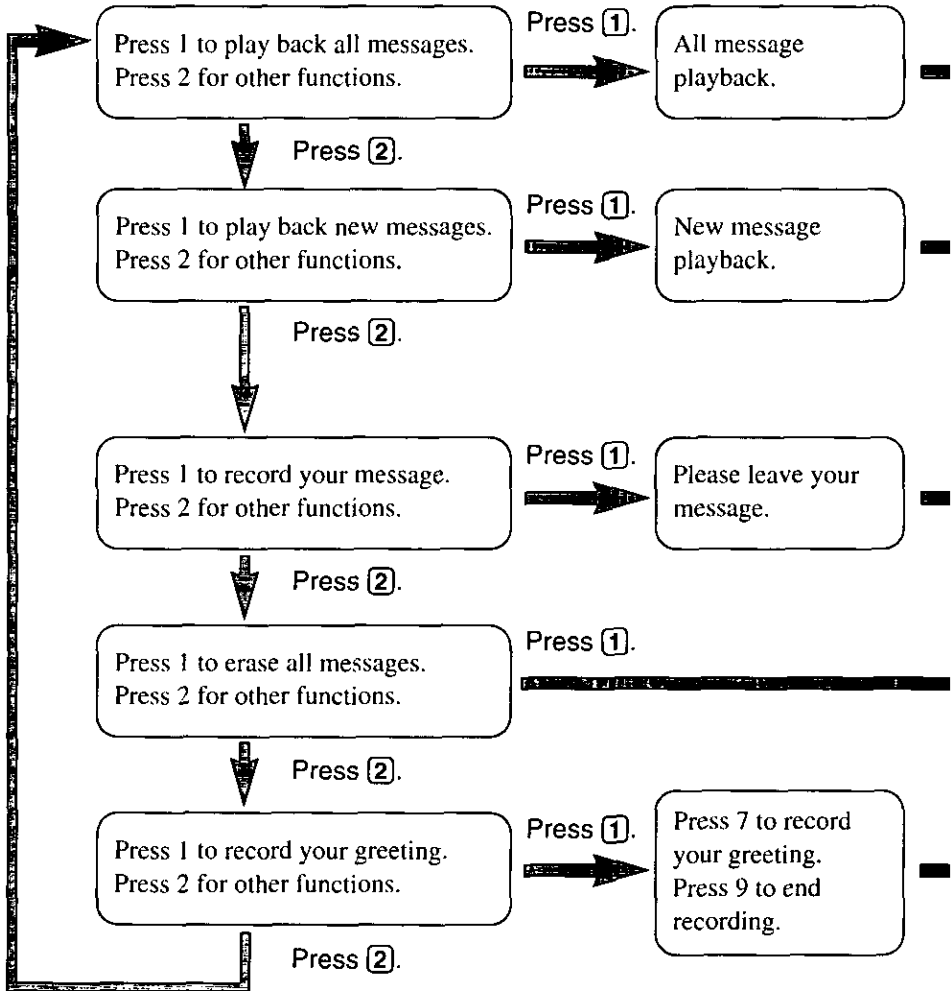



All Message Playback

All recorded messages are played back. At the end of the last message, "End of final message" is heard. The unit will announce the remaining recording time if it is less than 5 minutes.

New Message Playback

Only new messages are played back. At the end of the last message, "End of final message" is heard. The unit will announce the remaining recording time if it is less than 5 minutes.

Recording a Memo Message

You can leave a personal message.

1. Talk after you hear "Please leave your message."
2. When you finish recording, hang up.

Erase All Messages

All recorded messages (except greeting message) are erased.

Recording a Greeting Message

You can re-record your greeting message.

1. Press **[7]**.
You will hear a voice prompt followed by a long beep.
2. After the beep, talk for up to 2 minutes.
3. When you finish recording, press **[9]**.
4. Your greeting will be played back for confirmation.

- 3 seconds after playback, the voice menu will start again from the beginning.
- If you hear "Memory full" after playback, erase some or all of the messages (p. 60).

Direct Remote Operation

Once you have entered the remote code, you can also control your unit by direct commands instead of using the voice menu. To end the remote operation, hang up anytime.

Direct commands

NEW MESSAGE
PLAYBACK

4

- Only new messages are played back.

ALL MESSAGE
PLAYBACK

5

- All messages are played back.

REPEAT
(During playback)

1

- The current message is repeated.

SKIP
(During playback)

2

- The current message is skipped.
The next message is played.

STOP

9

- Operation is stopped temporarily.
- To resume operation, enter a direct command within 15 seconds, or the voice menu will start.

GREETING
MESSAGE
RECORDING

7

- A long beep sounds.

↓
RECORD

- After the beep, talk immediately for up to 2 minutes.

↓
9

- The recording is stopped.
- The recorded message is played.

ERASING A
SPECIFIC
MESSAGE
(During playback)

* 4

- The current message is erased.
- A short beep will sound and the next message will be played.

ERASING ALL
MESSAGES

* 5

- All recorded messages are erased.
 - A long beep sounds and "No messages" is heard.
-

PAGER CALL
ON/OFF

3

- Each time you press **3**, "on/off" is heard and the mode will turn on or off.
- If you have not stored a pager number, 6 beeps will sound and the mode will not turn on.

ANSWERING
SYSTEM OFF

0

- The unit hangs up and will not answer calls until turned on again.
-

Turning on the answering system

Call your unit and wait for 15 rings.

- The unit will answer and the greeting message will be played.
- The answering system will turn on. Hang up or enter the remote code for other options.
- When turning on the answering system using a rotary or pulse service telephone, you cannot enter the remote code for other options.

Skipping the greeting message

After calling your unit, press ***** during the greeting message.

- The unit skips the rest of the greeting message and you can start recording your message after the long beep.

Remote Operation with the Handset

You can operate your answering system with the handset.

The announcements and recorded messages can only be heard with the handset.

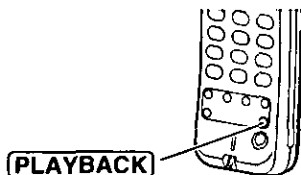

Summary of remote operation

Press **PLAYBACK**.

- The number of new messages is heard.
- "Remote operation" is displayed on the handset.



Enter the desired direct commands (p. 63)

- If you do not enter a command, the voice menu below will start.
- After the voice menu, all message playback will start.



To end remote operation, press **PLAYBACK**.

- The messages are saved.

- The unit will announce the remaining recording time after playback, if it is less than 5 minutes.
- If the unit starts to ring during the remote operation, press **TALK** to answer the call. The remote operation is ended.
- If you hear "Memory full" after playback, erase some or all of the messages (p. 63).

Voice menu

If no commands are entered after you press **PLAYBACK**, the unit will start the following voice menu.

"Press 4 to play back new messages; Press 5 to play back all messages."

- You can enter direct commands even when the voice menu has started.

Direct commands

NEW MESSAGE PLAYBACK	4	<ul style="list-style-type: none">• Only new messages are played back.
ALL MESSAGE PLAYBACK	5	<ul style="list-style-type: none">• All messages are played back.
REPEAT (During playback)	1	<ul style="list-style-type: none">• The current message is repeated.
SKIP (During playback)	2	<ul style="list-style-type: none">• The current message is skipped. The next message is played.
STOP	9	<ul style="list-style-type: none">• Operation is stopped temporarily.• To resume operation, enter a direct command within 15 seconds, or the voice menu will start (p. 62).
ERASING A SPECIFIC MESSAGE (During playback)	* 4	<ul style="list-style-type: none">• The current message is erased.• A short beep will sound and the next message will be played.
ERASING ALL MESSAGES	* 5	<ul style="list-style-type: none">• All recorded messages are erased.• A long beep sounds and "No messages" is heard.
PAGER CALL ON/OFF	3	<ul style="list-style-type: none">• Each time you press 3, the mode will turn on or off.• If you have not stored a pager number, "PAGER" will not be displayed on the base unit and the mode will not turn on.
ANSWERING SYSTEM OFF	0	<ul style="list-style-type: none">• "Answer off" is heard and the answering system is turned off.
ANSWERING SYSTEM ON	8	<ul style="list-style-type: none">• "Answer set" is heard and the answering system is turned on.

Battery Replacement

If "Recharge" is displayed and/or "[]" flashes after being fully charged, replace the battery with a new Panasonic P-P501 (KX-A36) battery. To order, call the accessories telephone number on page 2. To avoid loss of memory, replace within 3 minutes.

- 1 Remove the cover by sliding while pressing the arrow.
- 2 Replace the battery, and close the cover.
- 3 Be sure to charge the new battery for about 4 hours in order to display the battery strength prompt correctly (p. 14).



Attention:

The product you have purchased is powered by a nickel cadmium battery which is recyclable. At the end of its useful life, under various state and local laws, it is illegal to dispose of this battery into your municipal waste stream. Please call 1-800-8-BATTERY for information on how to recycle this battery.



Adding Another Phone

This unit will not function during a power failure. To connect a standard telephone on the same line, use the Panasonic T-adaptor KX-J66. To order, call the accessories telephone number on page 2.

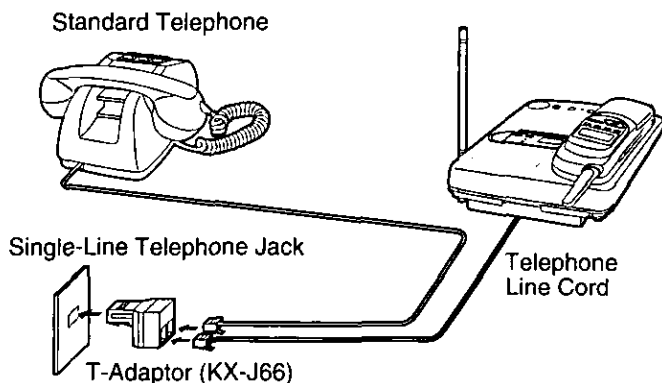



Cordless Telephone

Problem	Remedy
"Out of range" is displayed and an alarm tone sounds when you press TALK , INTERCOM or PLAYBACK .	<ul style="list-style-type: none">• You are too far from the base unit. Move closer and try again.• Place the handset on the base unit and try again.• Plug in the AC adaptor.• Raise the base unit antenna.
Static, sound cuts in/out, fades. Interference from other electrical units.	<ul style="list-style-type: none">• Locate the handset and the base unit away from other electrical appliances (p. 3).• Move closer to the base unit.• Raise the base unit antenna.• Press CH to select a clearer channel.
The handset does not ring.	<ul style="list-style-type: none">• The ringer volume is set to OFF. Press RINGER while the TALK indicator light is off (p. 21).
The handset display is blank.	<ul style="list-style-type: none">• The handset is in the stand-by mode (p. 15). Press SEARCH <input checked="" type="checkbox"/> or <input checked="" type="checkbox"/> to turn the display on.
The handset display is still blank after pressing SEARCH <input checked="" type="checkbox"/> or <input checked="" type="checkbox"/> .	<ul style="list-style-type: none">• Charge the battery fully (p. 14).
You cannot program items, such as the dialing mode.	<ul style="list-style-type: none">• Programming is not possible while the unit is in the talk or intercom mode, when viewing caller information, or while the answering system is in use.• Do not pause for over 60 seconds while programming.• Move closer to the base unit.• SEARCH <input checked="" type="checkbox"/> or <input checked="" type="checkbox"/> may have been pressed when you picked up the handset. Press EXIT, then try again.

➔ Before Requesting Help

Problem	Remedy
You cannot store a phone number in memory.	<ul style="list-style-type: none">• You cannot store a number while the unit is in the talk or intercom mode, or while the answering system is in use.• Do not pause for over 60 seconds while storing.
While programming or searching, the unit starts to ring and stops the program/search.	<ul style="list-style-type: none">• To answer the call, press TALK. Start from the beginning after hanging up.
The unit does not display the caller's name and/or phone number.	<ul style="list-style-type: none">• Other telephone equipment may be interfering with your phone. Disconnect them and try again.• Other electrical appliances connected to the same outlet may be interfering with the Caller ID information.• Telephone line noise may be affecting the Caller ID information.
The handset display goes to the stand-by mode while viewing the Caller List.	<ul style="list-style-type: none">• Do not pause for over 60 seconds while searching.
When a second call is received during a conversation, the unit does not display the new caller's name and/or phone number.	<ul style="list-style-type: none">• The line mode selection is incorrect. See page 17.
LOCATOR/INTERCOM does not function.	<ul style="list-style-type: none">• The handset is too far from the base unit.• The handset is engaged in an outside call or is viewing the Caller List. Wait until the IN USE/CHARGE indicator light goes out.



Problem

REDIAL/PAUSE does not function properly.

Remedy

- The button has a double function as either redial or pause. It will redial the last number dialed if pressed at the outset of a call (p. 30). If another number has been dialed first, it will operate as a pause button (p. 43).

You cannot redial by pressing **REDIAL/PAUSE**.

- Access numbers entered after pressing **TONE** will not be included when redialing.
- If the last number dialed was more than 32 digits long, the number will not be redialed.

Before Requesting Help

Answering system

Problem	Remedy
The answering system is on, but incoming messages are not recorded.	<ul style="list-style-type: none">• The recording time is set to “greeting only”. Select “1 minute” or “3 minutes” (p. 27).• Memory is full. Erase some or all of the messages (p. 49).
You cannot listen to the recorded messages.	<ul style="list-style-type: none">• Be sure that the unit is in the stand-by mode.
“ FULL ” is displayed and the ANSWER ON indicator flashes rapidly, and no new messages are recorded.	<ul style="list-style-type: none">• Memory is full. Erase some or all of the messages (p. 49).
You cannot operate the answering system at the base unit.	<ul style="list-style-type: none">• The handset user is operating the answering system. Wait until the IN USE/CHARGE indicator light goes out.
You cannot operate the answering system from a touch tone phone.	<ul style="list-style-type: none">• Make sure you enter the correct remote code.• The answering system may not respond if the tones are too short to activate the unit. Press each button firmly.• The answering system is off. Turn it on (p. 61).
You cannot operate the answering system with the handset.	<ul style="list-style-type: none">• Someone is operating the answering system.• You are too far from the base unit. Move closer to the base unit.• The unit is recording a message. To answer the call, press TALK.



Problem	Remedy
While recording a greeting message, the unit starts to ring and stops recording.	<ul style="list-style-type: none">• To answer the call, lift the handset off the base unit or press TALK. The recording will stop. Start from the beginning after hanging up.
During playback, the unit starts to ring and stops playback.	<ul style="list-style-type: none">• To answer the call, lift the handset off the base unit or press TALK. To resume playback, press NEW MESSAGE after hanging up.
The handset does not display the name and/or number of the caller whose message is being played.	<ul style="list-style-type: none">• Place the handset on the base unit correctly (p. 48).• If the caller is not stored in the caller list, the handset will not display the caller's information.
The unit does not alert your pager.	<ul style="list-style-type: none">• The line mode selection is incorrect. See page 17.

➔ Before Requesting Help

General

Problem	Remedy
The unit does not work.	<ul style="list-style-type: none">• Check the settings (p. 13–22).• Charge the battery fully (p. 14).• Clean the charge contacts and charge again (p. 15).• Install the battery properly (p. 64).• Place the handset on the base unit and unplug the AC adaptor to reset. Plug in and try again.• Re-install the handset battery within 3 minutes to avoid loss of memory and place the handset on the base unit. Try again.
You cannot program items, such as the time/day adjustment (p. 25).	<ul style="list-style-type: none">• Programming is not available while the unit is in the talk or intercom mode, when viewing the caller information, or while the answering system is in use.• Move closer to the base unit.
Previously programmed information is erased.	<ul style="list-style-type: none">• If a power failure occurs, programmed information may be erased. Reprogram if necessary.
"Recharge" is displayed, "{ []" flashes or the unit beeps intermittently.	<ul style="list-style-type: none">• Charge the battery fully (p. 14).
You charged the battery fully, but "Recharge" is still displayed and/or "{ []" continues to flash.	<ul style="list-style-type: none">• Clean the charge contacts and charge again (p. 15).• Install a new battery (p. 64).

Free Manuals Download Website

<http://myh66.com>

<http://usermanuals.us>

<http://www.somanuals.com>

<http://www.4manuals.cc>

<http://www.manual-lib.com>

<http://www.404manual.com>

<http://www.luxmanual.com>

<http://aubethermostatmanual.com>

Golf course search by state

<http://golfingnear.com>

Email search by domain

<http://emailbydomain.com>

Auto manuals search

<http://auto.somanuals.com>

TV manuals search

<http://tv.somanuals.com>