

Panasonic®

Operating Instructions

Digital Cordless Answering System

Model No. **KX-TG4221**
KX-TG4222
KX-TG4223
KX-TG313SK
KX-TG4224
KX-TG4225



DECT
6.0

Model shown is KX-TG4221.

*Before initial use, see “Getting Started”
on page 9.*

Thank you for purchasing a Panasonic product.

Please read these operating instructions before using the unit and save them for future reference.

Consulte “Guía Rápida Española”, página 40.

For assistance, visit our Web site: <http://www.panasonic.com/help> for customers in the U.S.A. or Puerto Rico.

Please register your product: <http://www.panasonic.com/prodreg>

Table of Contents

Introduction

Model composition	3
Accessory information	3

Important Information

For your safety	5
Important safety instructions	6
For best performance	6
Other information	7
Specifications	8

Getting Started

Setting up	9
Note when setting up	10
Intelligent eco mode	10
Controls	11
Display	12
Initial settings	12

Making/Answering Calls

Making calls	14
Answering calls	14
Useful features during a call	15

Shared Phonebook

Shared phonebook	17
------------------------	----

Programming

Programmable settings	19
Registering a unit	21

Caller ID Service

Using Caller ID service	22
Caller list	22

Answering System

Answering system	24
Turning the answering system on/ off	24
Greeting message	24
Listening to messages using the base unit	25
Listening to messages using the handset	25
Remote operation	26
Answering system settings	27

Voice Mail Service

Voice mail service	29
--------------------------	----

Intercom/Locator

Intercom	30
Handset locator	30
Transferring calls, conference calls	30

Useful Information

Wall mounting	31
Error messages	33
Troubleshooting	33
FCC and other information	37

Guía Rápida Española

Guía Rápida Española	40
----------------------------	----

Appendix

Customer services	44
Warranty (For United States and Puerto Rico)	45

Index

Index	47
-------------	----

Model composition

Series	Model No.	Base unit	Handset	
		Part No.	Part No.	Quantity
KX-TG4221 series	KX-TG4221	KX-TG4221	KX-TGA421	1
	KX-TG4222	KX-TG4221	KX-TGA421	2
	KX-TG4223	KX-TG4221	KX-TGA421	3
	KX-TG313SK	KX-TG4221	KX-TGA421	3
	KX-TG4224	KX-TG4221	KX-TGA421	4
	KX-TG4225	KX-TG4221	KX-TGA421	5

- Single handset models: Intercom calls can be made between handsets by purchasing and registering one or more optional handsets (page 4).

Accessory information

Supplied accessories

No.	Supplied handset qty.	1 unit* ¹	2 units* ²	3 units* ³	4 units* ⁴	5 units* ⁵
	Accessory item/ Order number	Accessory quantity				
①	AC adaptor/ PNLV226Z	1	1	1	1	1
②	Telephone line cord/ PQJA10075Z	1	1	1	1	1
③	Wall mounting adaptor* ⁶	1	1	1	1	1
④	Rechargeable batteries/ HHR-4DPA	2	4	6	8	10
⑤	Handset cover* ^{7, *8}	1	2	3	4	5
⑥	Charger* ⁹	–	1	2	3	4

*1 KX-TG4221

*2 KX-TG4222

*3 KX-TG4223/KX-TG313SK

*4 KX-TG4224

*5 KX-TG4225

*6 PQKL10088Z1: Black, PQKL10088Z3: Champagne gold

*7 The handset cover comes attached to the handset.

*8 PNYNTGA652BR: Black, PNYNTGA652GR: Champagne gold

*9 PNLC1041ZB: Black, PNLC1041ZN: Champagne gold

Introduction

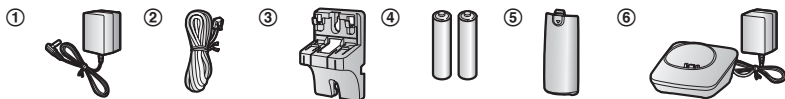

Additional/replacement accessories

Please contact your nearest Panasonic dealer for sales information (page 44).

Accessory item	Order number
Rechargeable batteries	HHR-4DPA*1 ● To order, please call 1-800-332-5368 or visit http://www.panasonic.com/batterystore
	Battery type: – Nickel metal hydride (Ni-MH) – 2 x AAA (R03) size for each handset
T-adaptor	KX-J66
Range extender	KX-TGA405*2

*1 Replacement batteries may have a different capacity from that of the supplied batteries.

*2 By installing this unit, you can extend the range of your phone system to include areas where reception was previously not available. This product can be purchased online. Please visit our Web site:
<http://www.panasonic.com/RangeExtender>

Expanding your phone system

Handset (optional): KX-TGA421	
<p>You can expand your phone system by registering optional handsets (6 max.) to a single base unit.</p> <ul style="list-style-type: none">● Optional handsets may be a different color from that of the supplied handsets.	

For your safety

To prevent severe injury and loss of life/property, read this section carefully before using the product to ensure proper and safe operation of your product.

WARNING

Power connection

- Use only the power source marked on the product.
- Do not overload power outlets and extension cords. This can result in the risk of fire or electric shock.
- Completely insert the AC adaptor/power plug into the power outlet. Failure to do so may cause electric shock and/or excessive heat resulting in a fire.
- Regularly remove any dust, etc. from the AC adaptor/power plug by pulling it from the power outlet, then wiping with a dry cloth. Accumulated dust may cause an insulation defect from moisture, etc. resulting in a fire.
- Unplug the product from power outlets if it emits smoke, an abnormal smell, or makes an unusual noise. These conditions can cause fire or electric shock. Confirm that smoke has stopped emitting and contact the Panasonic Call Center at 1-800-211-PANA (1-800-211-7262).
- Unplug from power outlets and never touch the inside of the product if its casing has been broken open.
- Never touch the plug with wet hands. Danger of electric shock exists.

Installation

- To prevent the risk of fire or electrical shock, do not expose the product to rain or any type of moisture.
- Do not place or use this product near automatically controlled devices such as automatic doors and fire alarms. Radio waves emitted from this product may cause such devices to malfunction resulting in an accident.

- Do not allow the AC adaptor or telephone line cord to be excessively pulled, bent or placed under heavy objects.

Operating safeguards

- Unplug the product from power outlets before cleaning. Do not use liquid or aerosol cleaners.
- Do not disassemble the product.
- Do not spill liquids (detergents, cleansers, etc.) onto the telephone line cord plug, or allow it to become wet at all. This may cause a fire. If the telephone line cord plug becomes wet, immediately pull it from the telephone wall jack, and do not use.

Medical

- Consult the manufacturer of any personal medical devices, such as pacemakers or hearing aids, to determine if they are adequately shielded from external RF (radio frequency) energy. (The product operates in the frequency range of 1.92 GHz to 1.93 GHz, and the RF transmission power is 115 mW (max..))
- Do not use the product in health care facilities if any regulations posted in the area instruct you not to do so. Hospitals or health care facilities may be using equipment that could be sensitive to external RF energy.

CAUTION

Installation and location

- Never install telephone wiring during an electrical storm.
- Never install telephone line jacks in wet locations unless the jack is specifically designed for wet locations.
- Never touch uninsulated telephone wires or terminals unless the telephone line has been disconnected at the network interface.
- Use caution when installing or modifying telephone lines.
- The AC adaptor is used as the main disconnect device. Ensure that the AC outlet is installed near the product and is easily accessible.
- This product is unable to make calls when:

Important Information

- the handset batteries need recharging or have failed.
- there is a power failure.

Battery

- We recommend using the batteries noted on page 4. **USE ONLY rechargeable Ni-MH batteries AAA (R03) size.**
- Do not mix old and new batteries.
- Do not open or mutilate the batteries. Released electrolyte from the batteries is corrosive and may cause burns or injury to the eyes or skin. The electrolyte is toxic and may be harmful if swallowed.
- Exercise care when handling the batteries. Do not allow conductive materials such as rings, bracelets, or keys to touch the batteries, otherwise a short circuit may cause the batteries and/or the conductive material to overheat and cause burns.
- Charge the batteries provided with or identified for use with this product only, in accordance with the instructions and limitations specified in this manual.
- Only use a compatible base unit (or charger) to charge the batteries. Do not tamper with the base unit (or charger). Failure to follow these instructions may cause the batteries to swell or explode.

Attention:



A nickel metal hydride battery that is recyclable powers the product you have purchased. Please call 1-800-8-BATTERY (1-800-822-8837) for information on how to recycle this battery.

Important safety instructions

When using your product, basic safety precautions should always be followed to reduce the risk of fire, electric shock, and injury to persons, including the following:

1. Do not use this product near water for example, near a bathtub, washbowl, kitchen sink, or laundry tub, in a wet basement or near a swimming pool.
2. Avoid using a telephone (other than a cordless type) during an electrical storm. There may be a remote risk of electric shock from lightning.
3. Do not use the telephone to report a gas leak in the vicinity of the leak.
4. Use only the power cord and batteries indicated in this manual. Do not dispose of batteries in a fire. They may explode. Check with local codes for possible special disposal instructions.

SAVE THESE INSTRUCTIONS

For best performance

Base unit location/avoiding noise

The base unit and other compatible Panasonic units use radio waves to communicate with each other.

- For maximum coverage and noise-free communications, place your base unit:
 - at a convenient, high, and central location with no obstructions between the handset and base unit in an indoor environment.
 - away from electronic appliances such as TVs, radios, personal computers, wireless devices, or other phones.
 - facing away from radio frequency transmitters, such as external antennas of mobile phone cell stations. (Avoid putting the base unit on a bay window or near a window.)
- Coverage and voice quality depends on the local environmental conditions.

- If the reception for a base unit location is not satisfactory, move the base unit to another location for better reception.

Environment

- Keep the product away from electrical noise generating devices, such as fluorescent lamps and motors.
- The product should be kept free from excessive smoke, dust, high temperature, and vibration.
- The product should not be exposed to direct sunlight.
- Do not place heavy objects on top of the product.
- When you leave the product unused for a long period of time, unplug the product from the power outlet.
- The product should be kept away from heat sources such as heaters, kitchen stoves, etc. It should not be placed in rooms where the temperature is less than 0 °C (32 °F) or greater than 40 °C (104 °F). Damp basements should also be avoided.
- The maximum calling distance may be shortened when the product is used in the following places: Near obstacles such as hills, tunnels, underground, near metal objects such as wire fences, etc.
- Operating the product near electrical appliances may cause interference. Move away from the electrical appliances.

Routine care

- **Wipe the outer surface of the product with a soft moist cloth.**
- Do not use benzine, thinner, or any abrasive powder.

Other information

CAUTION: Risk of explosion if battery is replaced by an incorrect type. Dispose of used batteries according to the instructions.

Notice for product disposal, transfer, or return

- This product can store your private/confidential information. To protect your privacy/confidentiality, we recommend that you erase information such as phonebook or caller list entries from the memory before you dispose of, transfer, or return the product.

Notice

- This product is designed for use in the United States of America. Sale or use of this product in other countries may violate local laws.
- Cet appareil est conçu pour être utilisé aux États-Unis d'Amérique. La vente ou l'emploi de cet appareil dans certains autres pays peut constituer une infraction à la législation locale.
- Este producto está diseñado para usarse en los Estados Unidos de América. La venta o el empleo de este producto en ciertos países puede constituir violación de la legislación local.
- 本產品專為美國使用而設。若在其他國家銷售或使用，可能會違反當地法例。
- この製品は、日本国外での使用を目的として設計されており、日本国内での使用は法律違反となります。従って、当社では日本国内においては原則として修理などのサービスは致しかねます。

ENERGY STAR

As an ENERGY STAR® Partner, Panasonic has determined that this product meets the ENERGY STAR guidelines for energy efficiency. ENERGY STAR is a U.S. registered mark.



Specifications

- **Standard:**
DECT 6.0 (Digital Enhanced
Cordless Telecommunications 6.0)
- **Frequency range:**
1.92 GHz to 1.93 GHz
- **RF transmission power:**
115 mW (max.)
- **Power source:**
120 V AC, 60 Hz
- **Power consumption:**
Base unit:
Standby: Approx. 0.7 W
Maximum: Approx. 3.5 W
Charger:
Standby: Approx. 0.1 W
Maximum: Approx. 1.8 W
- **Operating conditions:**
0 °C – 40 °C (32 °F – 104 °F), 20 % – 80 %
relative air humidity (dry)

Note:

- Design and specifications are subject to change without notice.
- The illustrations in these instructions may vary slightly from the actual product.

Setting up

Connections

■ Base unit

- Use only the supplied Panasonic AC adaptor PNLV226.

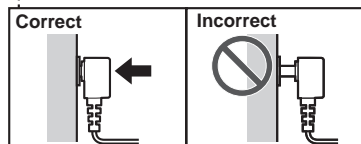
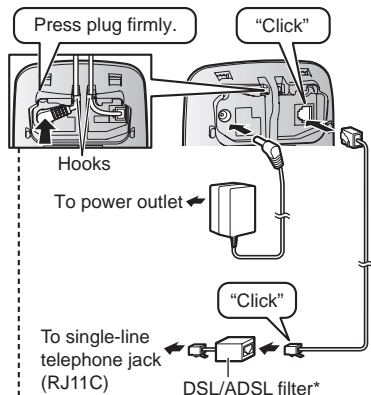

*DSL/ADSL filter (not supplied) is required if you have DSL/ADSL service.

■ Charger

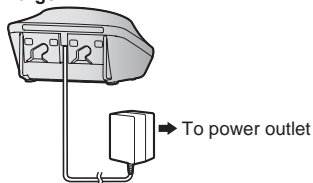

Battery installation

- USE ONLY Ni-MH batteries AAA (R03) size.
- Do NOT use Alkaline/Manganese/Ni-Cd batteries.
- Confirm correct polarities (+, -).

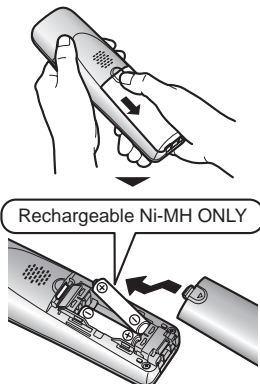

Battery charging

Charge for about 7 hours.

- When the batteries are fully charged, the charge indicator goes off and "Fully charged" is displayed.

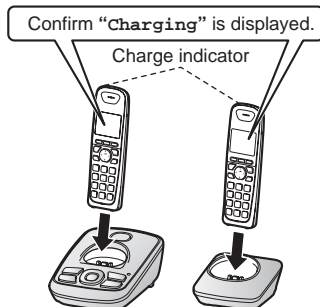

Note when setting up

Note for connections

- The AC adaptor must remain connected at all times. (It is normal for the adaptor to feel warm during use.)
- The AC adaptor should be connected to a vertically oriented or floor-mounted AC outlet. Do not connect the AC adaptor to a ceiling-mounted AC outlet, as the weight of the adaptor may cause it to become disconnected.

During a power failure

- The unit will not work during a power failure. We recommend connecting a corded-type telephone (without AC adaptor) to the same telephone line or to the same telephone line jack using a Panasonic T-adaptor (page 4).

Note for battery installation



- Use the supplied rechargeable batteries. For replacement, we recommend using the Panasonic rechargeable batteries noted on page 4, 6.
- Wipe the battery ends (+, -) with a dry cloth.
- Avoid touching the battery ends (+, -) or the unit contacts.

Note for battery charging

- It is normal for the handset to feel warm during charging.
- Clean the charge contacts of the handset, base unit, and charger with a soft and dry cloth once a month. Before cleaning the unit, disconnect from power outlets and any telephone line cords. Clean more often if the unit is exposed to grease, dust, or high humidity.

Battery level

Icon	Battery level
	High

Icon	Battery level
	Medium
	Low
	Needs charging.

Panasonic Ni-MH battery performance (supplied batteries)

Operation	Operating time
In continuous use	10 hours max.*1
Not in use (standby)	6 days max.*1

*1 If eco mode is on.

Note:

- Actual battery performance depends on usage and ambient environment.
- Even after the batteries are fully charged, the handset can be left on the base unit or charger without any ill effect on the batteries.
- The battery level may not be displayed correctly after you replace the batteries. In this case, place the handset on the base unit or charger and let it charge for at least 7 hours.

Intelligent eco mode

This feature automatically reduces handset power consumption by suppressing handset transmission power when the handset is close to the base unit.

- When this feature is activated, "ECO" is displayed.
- Eco mode is turned off when the clarity booster is activated (page 15).

Controls

Handset

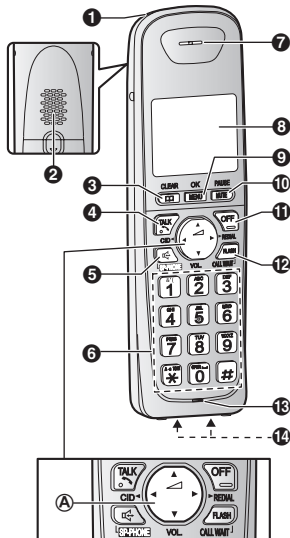

- 1 Charge indicator
Ringer indicator
- 2 Speaker
- 3 [☰] (Phonebook) [CLEAR]
- 4 [☎] (TALK)
- 5 [☎] (SP-PHONE: Speakerphone)
- 6 Dial keypad (☎: TONE)
- 7 Receiver
- 8 Display
- 9 [MENU][OK]
- 10 [MUTE][PAUSE]
- 11 [OFF]
- 12 [FLASH][CALL WAIT]
- 13 Microphone
- 14 Charge contacts

A Navigator key

- [▲], [▼], [◀], or [▶]: Scroll through various lists and items.
- ◀ VOL. (Volume: [▲] or [▼]): Adjust the receiver or speaker volume while talking.
- [◀] CID (Caller ID): View the caller list.
- [▶] REDIAL: View the redial list.

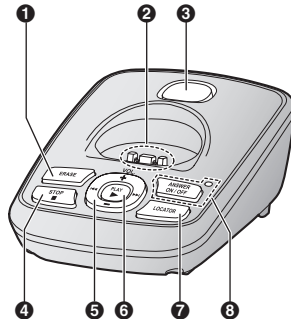

Base unit



- 1 [ERASE]
- 2 Charge contacts
- 3 Speaker
- 4 [■] (STOP)
- 5 [+] / [-] (VOL.: Volume up/down)
[◀◀] / [▶▶] (Repeat/Skip)
- 6 [▶] (PLAY)
Message indicator
- 7 [LOCATOR]
- 8 [ANSWER ON/OFF]
ANSWER ON/OFF indicator

Display

Handset display items

Item	Meaning
	Within base unit range <ul style="list-style-type: none">When flashing: Handset is searching for the base unit. (page 34)
ECO	Eco mode is on. (page 10)
[P]	Privacy mode is on. (page 20)
[1]	Handset number
	Battery level
In use	<ul style="list-style-type: none">Someone is using the line.Answering system is being used by the base unit.

Initial settings

■ Symbol meaning:

Symbol	Meaning
Example: [↕]: "OFF"	Press [▼] or [▲] to select the words in quotations.

Date and time

- [MENU]
- [↕]: "Date and time" → [OK]
- Enter the current month, date, and year by selecting 2 digits for each.
Example: July 15, 2013
[0][7] [1][5] [1][3]
- Enter the current hour and minute (12-hour clock format) by selecting 2 digits for each.
Example: 9:30
[0][9] [3][0]
- [X]: Select "AM" or "PM".
- [OK] → [OFF]

Note:

- When English is selected as the display language, 12-hour clock format is used. When Spanish is selected, 24-hour clock format is used.
- The date and time may be incorrect after a power failure. In this case, set the date and time again.

Display language

You can select either "English" or "Español" as the display language. The default setting is "English".

- [MENU]
- [↕]: "Initial setting" → [OK]
- [↕]: "Display settings" → [OK]
- [↕]: "Change language" → [OK]
- [↕]: Select the desired setting. → [OK]
- [OFF]

Note:

- How to change from Spanish back to English:

- [MENU]
- [↕]: "Ajuste inicial" → [OK]
- [↕]: "Ajuste pantalla" → [OK]
- [↕]: "Cambiar idioma" → [OK]
- [↕]: "English" → [OK] → [OFF]

Voice guidance language

You can select either "English" or "Español" as the voice guidance language of the answering system. The default setting is "English".

- [MENU]
- [↕]: "Answering device" → [OK]
- [↕]: "Settings" → [OK]
- [↕]: "Voice prompt" → [OK]
- [↕]: Select the desired setting.
- [OK] → [OFF]

Dialing mode

If you cannot make calls, change this setting according to your telephone line service. The default setting is "Tone".

"Tone": For tone dial service.

"Pulse": For rotary/pulse dial service.

- 1 [MENU]
- 2 [↕]: "Initial setting" → [OK]
- 3 [↕]: "Set tel line" → [OK]
- 4 [↕]: "Set dial mode" → [OK]
- 5 [↕]: Select the desired setting.
- 6 [OK] → [OFF]

Making calls

- 1 Lift the handset and dial the phone number.
 - To correct a digit, press **[CLEAR]**.
- 2 Press **[↶]**.
- 3 When you finish talking, press **[OFF]** or place the handset on the base unit or charger.

Using the speakerphone

- 1 Dial the phone number and press **[📞]**.
 - Speak alternately with the other party.
- 2 When you finish talking, press **[OFF]**.

Note:

- For best performance, use the speakerphone in a quiet environment.
- To switch back to the receiver, press **[↶]**.

Adjusting the receiver or speaker volume

Press **[▲]** or **[▼]** repeatedly while talking.

Making a call using the redial list

The last 5 phone numbers dialed are stored in the redial list (each 48 digits max.).

- 1 **[▶]** REDIAL
- 2 **[↕]**: Select the desired phone number.
- 3 **[↶]**

Erasing a number in the redial list

- 1 **[▶]** REDIAL
- 2 **[↕]**: Select the desired phone number.
→ **[CLEAR]**
- 3 **[↕]**: "Yes" → **[OK]**
- 4 **[OFF]**

Pause (for PBX/long distance service users)

A pause is sometimes required when making calls using a PBX or long distance service.

When storing a calling card access number and/or PIN in the phonebook, a pause is also needed (page 18).

Example: If you need to dial the line access number "9" when making outside calls with a PBX:

- 1 **[9]** → **[PAUSE]**
- 2 Dial the phone number. → **[↶]**

Note:

- A 3.5 second pause is inserted each time **[PAUSE]** is pressed.

Answering calls

When a call is being received, the ringer indicator flashes rapidly.

- 1 Lift the handset and press **[↶]** or **[📞]** when the unit rings.
 - You can also answer the call by pressing any dial key from **[0]** to **[9]**, **[*]**, or **[#]**. (**Any key answer feature**)
- 2 When you finish talking, press **[OFF]** or place the handset on the base unit or charger.

Auto talk

You can answer calls simply by lifting the handset off the base unit or charger. You do not need to press **[↶]**. To turn this feature on, see page 20.

Adjusting the handset ringer volume

- **While the handset is ringing for an incoming call:**
Press **[▲]** or **[▼]** repeatedly to select the desired volume.
- **Programming the volume beforehand:**
 - 1 **[MENU]**
 - 2 **[↕]**: "Initial setting" → **[OK]**
 - 3 **[↕]**: "Ringer settings" → **[OK]**
 - 4 **[↕]**: "Ringer volume" → **[OK]**
 - 5 **[↕]**: Select the desired volume.
 - 6 **[OK]** → **[OFF]**

Temporary handset ringer off

While the handset is ringing for a call, you can turn the ringer off temporarily by pressing **[OFF]**.

Adjusting the base unit ringer volume

Press **[+]** or **[-]** repeatedly to select the desired volume.

- To turn the ringer off, press and hold **[-]** until the unit beeps.

Useful features during a call

Hold

This feature allows you to put an outside call on hold.

- 1 Press **[MENU]** during an outside call.
- 2 **[↕]**: "Hold" → **[OK]**
- 3 To release hold, press **[↶]**.
 - Another handset user can take the call by pressing **[↶]**.

Note:

- If a call is kept on hold for more than 9 minutes, the call rings at your unit again. After 1 additional minute on hold, the call is disconnected.
- If another phone is connected to the same line, you can also take the call by lifting its handset.

Mute

While mute is turned on, you can hear the other party, but the other party cannot hear you.

- 1 Press **[MUTE]** during conversation.
- 2 To return to the conversation, press **[MUTE]** again.

Flash

[FLASH] allows you to use the special features of your host PBX such as transferring an extension call, or accessing optional telephone services.

Note:

- To change the flash time, see page 20.

For call waiting or Call Waiting Caller ID service users

To use call waiting or Call Waiting Caller ID, you must first subscribe with your service provider/telephone company.

This feature allows you to receive calls while you are already talking on the phone. If you receive a call while on the phone, you will hear a call waiting tone.

If you subscribe to both Caller ID and Call Waiting with Caller ID services, the 2nd caller's information is displayed after you hear the call waiting tone on the handset.

- 1 Press **[CALL WAIT]** to answer the 2nd call.
- 2 To switch between calls, press **[CALL WAIT]**.

Note:

- Please contact your service provider/telephone company for details and availability of this service in your area.

Temporary tone dialing (for rotary/pulse service users)

You can temporarily switch the dialing mode to tone when you need to access touch-tone services (for example, answering services, telephone banking services, etc.). Press **[*]** (TONE) before entering access numbers which require tone dialing.

Handset clarity booster

This feature can improve sound clarity when the handset is used in an area where there may be interference. During an outside call, this feature is turned on automatically when necessary.

Call share

You can join an existing outside call.

To join the conversation, press [] when the other handset is on an outside call.

Note:

- A maximum of 4 parties (including 1 outside party) can join a conversation using 3 extensions. **(4-way conference)**
- To prevent other users from joining your conversations with outside callers, turn privacy mode on (page 20).

Shared phonebook

The shared phonebook allows you to make calls without having to dial manually. Any handset registered to the base unit can use the shared phonebook. You can add 50 names and phone numbers to the shared phonebook.

Important:

- Only 1 person can access the shared phonebook at a time.

Adding entries

- [] → [MENU]
- []: "Add new entry" → [OK]
- Enter the party's name (16 characters max.). → [OK]
- Enter the party's phone number (24 digits max.). → [OK] 2 times
 - To add other entries, repeat from step 3.
- [OFF]

Character table for entering names

While entering characters, you can switch between uppercase and lowercase by pressing (A→a).

Key	Character
[1]	_ # & ' () * , - . / 1
[2]	A B C 2 a b c 2
[3]	D E F 3 d e f 3
[4]	G H I 4 g h i 4
[5]	J K L 5 j k l 5
[6]	M N O 6 m n o 6

Key	Character
[7]	P Q R S 7 p q r s 7
[8]	T U V 8 t u v 8
[9]	W X Y Z 9 w x y z 9
[0]	_ 0

- To enter another character that is located on the same dial key, first press [] to move the cursor to the next space.
- _ in the above table represents a single space.

Erasing the character or number

Press [] or []. → [CLEAR]

- Press and hold [CLEAR] to erase all characters or numbers.

Finding and calling from a phonebook entry

Scrolling through all entries

- []
- []: Select the desired entry.
- []

Searching by first character

- []
- Press the dial key ([0] – [9]) which contains the character you are searching for (page 17).
 - Press the same dial key repeatedly to display the first entry corresponding to each character located on that dial key.
 - If there is no entry corresponding to the character you selected, the next entry is displayed.
- []: Scroll through the phonebook if necessary.
- []

Shared Phonebook

Editing entries

- 1 Find the desired entry (page 17). → **[MENU]**
- 2 **[↕]**: “**E**dit” → **[OK]**
- 3 Edit the name if necessary (16 characters max.; page 17). → **[OK]**
- 4 Edit the phone number if necessary (24 digits max.). → **[OK]**
- 5 **[↕]**: “**S**ave” → **[OK]** → **[OFF]**

Erasing entries

Erasing an entry

- 1 Find the desired entry (page 17).
- 2 **[CLEAR]**
- 3 **[↕]**: “**Y**es” → **[OK]** → **[OFF]**

Chain dial

This feature allows you to dial phone numbers in the phonebook while you are on a call. This feature can be used, for example, to dial a calling card access number or bank account PIN that you have stored in the phonebook, without having to dial manually.

- 1 During an outside call, press **[□□]**.
- 2 **[↕]**: Select the desired entry.
- 3 Press **[OK]** to dial the number.

Note:

- When storing a calling card access number and your PIN in the phonebook as one phonebook entry, press **[PAUSE]** to add pauses after the number and PIN as necessary (page 14).
- If you have rotary/pulse service, you need to press **[☒]** (TONE) before pressing **[□□]** in step 1 to change the dialing mode temporarily to tone. When adding entries to the phonebook, we recommend adding **[☒]** (TONE) to the beginning of phone numbers you wish to chain dial (page 17).

Programmable settings

You can customize the unit by programming the following features using the handset.

Scrolling through the display menus

- 1 **[MENU]**
- 2 Press **[▼]** or **[▲]** to select the desired main menu. → **[OK]**
- 3 Press **[▼]** or **[▲]** to select the desired item from the next sub-menus. → **[OK]**
- 4 Press **[▼]** or **[▲]** to select the desired setting. → **[OK]**
 - This step may vary depending on the feature being programmed.
 - To exit the operation, press **[OFF]**.

Note:

- In the following table, <> indicates the default settings.
- In the following table,  indicates the reference page number.
- Display menu order and sub-menu may vary depending on your model.

Main menu	Sub-menu 1	Sub-menu 2		
Caller list	–	–	22	
Answering device	Play new msg. (msg.: message)	–	25	
	Play all msg.	–	25	
	Erase all msg.* ¹	–	26	
	Greeting	Record greeting* ¹		24
		Check greeting		25
		Pre-recorded* ¹ (Reset to pre-recorded greeting)		25
		Settings	Remote code* ¹ <111>	26
		Ring count* ¹ <4 rings>	27	
		Recording time* ¹ <3 min>	28	
		Screen call <On>	24	
		Voice prompt* ¹ <English>	12	
	Answer on* ¹	–	24	
	Answer off* ¹	–	24	
Intercom	–	–	30	

Programming

Main menu	Sub-menu 1	Sub-menu 2	
Ph.book settings (Ph.book: phonebook)	Add new entry ^{*1}	–	17
Initial setting	Ringer settings	Ringer volume <Level 6>	14
		Ringer tone ^{*2, *3, *4} <Tone 1>	–
	Display settings	Change language <English>	12
		Contrast <Level 3>	–
	Set tel line	Set dial mode ^{*1} <Tone>	13
		Set flash time ^{*1, *5} <700 ms>	15
	Privacy mode ^{*1} <Off>	–	16
	Registration	HS registration (HS: handset)	21
		Deregistration	21
	Key tone ^{*6} <On>	–	–
Auto talk ^{*7} <Off>	–	14	
Caller ID edit <On>	–	23	
Date and time ^{*1}	–	–	12
Customer support	–	–	–

*1 If you program these settings using one of the handsets, you do not need to program the same item using another handset.

*2 If you subscribe to a distinctive ring service (such as IDENTIA-RING), select a tone (tone 1 to 3). If you select a melody, you cannot distinguish lines by their ringers.

*3 If you select one of the melody ringer tones, it will continue to play for several seconds even if the caller has already hung up. You may either hear a dial tone or no one on the line when you answer the call.

*4 The preset melodies in this product are used with permission of © 2007 Copyrights Vision Inc.

*5 The flash time depends on your telephone exchange or host PBX. Contact your PBX supplier if necessary. The setting should stay at “700 ms” unless pressing **[FLASH]** fails to pick up the waiting call.

*6 Turn this feature off if you prefer not to hear key tones while you are dialing or pressing any keys, including confirmation tones and error tones.

*7 If you subscribe to a Caller ID service and want to view the caller's information after lifting up the handset to answer a call, turn off this feature.

Registering a unit

Operating additional units

Additional handsets

Up to 6 handsets can be registered to the base unit.

Important:

- See page 4 for information on the available model.

Registering a handset to the base unit

The supplied handset and base unit are pre-registered. If for some reason the handset is not registered to the base unit, re-register the handset.

- 1 Handset:**
[MENU]
- [↕]: “Initial setting” → [OK]
- [↕]: “Registration” → [OK]
- [↕]: “HS registration” → [OK]
- 5 Base unit:**
Press and hold [LOCATOR] for about 5 seconds until the registration tone sounds.
 - If all registered handsets start ringing, press [LOCATOR] again to stop, then repeat this step.
 - The next step must be completed within 90 seconds.
- 6 Handset:**
Press [OK], then wait until a long beep sounds.

Note:

- While registering, “Base in registering mode” is displayed on all registered handsets.
- When you purchase an additional handset, refer to the additional handset’s installation manual for registration.

Deregistering a handset

A handset can cancel its own registration to the base unit, or other handsets registered to the same base unit. This allows the handset to end its wireless connection with the system.

- 1 [MENU]**
- [↕]: “Initial setting” → [OK]
- [↕]: “Registration” → [OK]
- [↕]: “Deregistration” → [OK]
- 5 [3][3][5] → [OK]**
- Select the handset(s) you want to cancel by pressing the desired handset number (**1** – **6**). → [OK]
 - The selected handset number(s) flashes.
 - To undo a selection, press the handset number again. The number stops flashing.
- [↕]: “Yes” → [OK]
- 8 [OFF]**

Using Caller ID service

Important:

- This unit is Caller ID compatible. To use Caller ID features, you must subscribe to a Caller ID service. Contact your service provider/telephone company for details.

Caller ID features

When an outside call is being received, the caller information is displayed.

Caller information for the last 50 callers is logged in the caller list from the most recent call to the oldest.

- If the unit cannot receive caller information, the following is displayed:
 - “**Out of area**”: The caller dials from an area which does not provide a Caller ID service.
 - “**Private caller**”: The caller requests not to send caller information.
 - “**Long distance**”: The caller makes a long distance call.
- If the unit is connected to a PBX system, caller information may not be properly received. Contact your PBX supplier.

Missed calls

If a call is not answered, the unit treats it as a missed call. The display shows “**Missed call**”.

Note:

- Even when there are unviewed missed calls, “**Missed call**” disappears from the standby display if the following operation is performed by one of the registered handsets:
 - Being replaced on the base unit or charger.
 - Pressing **[OFF]** on a handset.

Phonebook name display

When caller information is received and it matches a phone number stored in the phonebook, the stored name in the phonebook is displayed and logged in the caller list.

Caller list

Important:

- Only 1 person can access the caller list at a time.
- Make sure the unit's date and time setting is correct (page 12).

Viewing the caller list and calling back

- 1 **[◀]** CID
- 2 Press **[▼]** to search from the most recent call, or **[▲]** to search from the oldest call.
- 3 To call back, press **[↶]**.
To exit, press **[OFF]**.

Note:

- If the entry has already been viewed or answered, “**✓**” is displayed, even if it was viewed or answered using another handset.
- In step 2, if **▶** is displayed, not all of the information is shown. To see the remaining information, press **[▶]**. To return to the previous screen, press **[◀]**.

Editing a caller's phone number before calling back

You can edit a phone number in the caller list by removing its area code and/or the long distance code “1”.

- 1 **[◀]** CID
- 2 **[↕]**: Select the desired entry.
- 3 **[MENU]** → **[↕]**: “**Edit & Save**” → **[OK]**
- 4 Press **[MENU]** repeatedly until the phone number is shown in the desired format.

- ① Local phone number
Example: 321-5555
- ② Area code – Local phone number
Example: 555-321-5555
- ③ 1 – Area code – Local phone number
Example: 1-555-321-5555

5 [↶]

Caller ID number auto edit feature

Once you call back an edited number, the handset which was used to call back remembers the area code and format of the edited number. The next time someone calls from the same area code, caller information is customized by the handset as follows:

- When the call is being received, the Caller ID number is displayed in the same format as the edited number.
- After the call has ended, the caller's phone number is displayed in the same format as the edited number, when reviewed from the caller list.

For example, you can use this feature to set the handset to ignore the area code of callers in your area, so that you can call these local numbers using caller information without dialing the area code.

To activate this feature, you must edit an entry in the caller list, then call that number. After that, phone numbers from that caller's area code are edited automatically.

This feature can be set for each handset (page 20). The default setting is "On".

Note:

- Phone numbers from the 4 most recently edited area codes are automatically edited.

Erasing selected caller information

- 1 [↶] CID
- 2 [↕]: Select the desired entry.
- 3 [CLEAR] → [↕]: "Yes"
- 4 [OK] → [OFF]

Erasing all caller information

- 1 [↶] CID
- 2 [↕]: Select the desired entry. → [OK]
- 3 [↕]: "Erase all" → [OK]
- 4 [↕]: "Yes" → [OK] → [OFF]

Storing caller information to the phonebook

- 1 [↶] CID
- 2 [↕]: Select the desired entry. → [MENU]
- 3 [↕]: "Edit & Save" → [OK]
 - To edit the number, press [MENU] repeatedly until the phone number is shown in the desired format.
- 4 [MUTE]
- 5 Continue from step 3, "Editing entries", page 18.

Answering system

The answering system can answer and record calls for you when you are unavailable to answer the phone.

Important:

- Only 1 person can access the answering system (listen to messages, record a greeting message, etc.) at a time.
- When callers leave messages, the unit records the day and time of each message. Make sure the date and time have been set correctly (page 12).

Memory capacity (including your greeting message)

The total recording capacity is about 18 minutes. A maximum of 64 messages can be recorded.

Note:

- When message memory becomes full:
 - “Messages full” is shown on the handset display.
 - The ANSWER ON/OFF indicator on the base unit flashes rapidly if the answering system is turned on.
 - If you use the pre-recorded greeting message, the unit automatically switches to another pre-recorded greeting message asking callers to call again later.
 - If you recorded your own greeting message, the same message is still announced to callers even though their messages are not recorded.

Turning the answering system on/off

Base unit

Press [ANSWER ON/OFF] to turn on/off the answering system.

Handset

- 1 [MENU]

- 2 [↕]: “Answering device” → [OK]

- 3 [↕]: “Answer on” or “Answer off” → [OK] → [OFF]

Note for base unit and handset:

- When the answering system is turned on, the ANSWER ON/OFF indicator on the base unit lights up.

Call screening

While a caller is leaving a message, you can listen to the call through the handset’s speaker. To adjust the speaker volume, press [▲] or [▼] repeatedly. You can answer the call by pressing [↵]. Call screening can be set for each handset. The default setting is “on”.

- 1 [MENU]
- 2 [↕]: “Answering device” → [OK]
- 3 [↕]: “Settings” → [OK]
- 4 [↕]: “Screen call” → [OK]
- 5 [↕]: Select the desired setting. → [OK] → [OFF]

Greeting message

When the unit answers a call, a greeting message is played to callers.

You can use either:

- your own greeting message
- a pre-recorded greeting message

Recording your greeting message

- 1 [MENU]
- 2 [↕]: “Answering device” → [OK]
- 3 [↕]: “Greeting” → [OK]
- 4 [↕]: “Record greeting” → [OK]
- 5 [↕]: “Yes” → [OK]
- 6 After a beep sounds, hold the handset about 20 cm (8 inches) away and speak clearly into the microphone (2 minutes max.).
- 7 Press [OK] to stop recording.
- 8 [OFF]

Using a pre-recorded greeting message

If you erase or do not record your own greeting message, the unit plays a pre-recorded greeting asking callers to leave a message.

Resetting to a pre-recorded greeting message

If you want to use a pre-recorded greeting message once you record your own greeting message, you need to erase your own greeting message.

- 1 [MENU]
- 2 [↕]: "Answering device" → [OK]
- 3 [↕]: "Greeting" → [OK]
- 4 [↕]: "Pre-recorded" → [OK]
- 5 [OK] → [OFF]

Playing back the greeting message

- 1 [MENU]
- 2 [↕]: "Answering device" → [OK]
- 3 [↕]: "Greeting" → [OK]
- 4 [↕]: "Check greeting" → [OK]
- 5 To exit, press [OFF].

Listening to messages using the base unit

When new messages have been recorded, [▶] on the base unit flashes.

Press [▶] (PLAY).

- If new messages have been recorded, the base unit plays back new messages.
- If there are no new messages, the base unit plays back all messages.

Operating the answering system during playback

Key	Operation
[+] or [-]	Adjust the speaker volume
[◀◀]	Repeat message*1
[▶▶]	Skip message
[■] (STOP)	Stop playback
[ERASE]	Erase currently playing message

*1 If pressed within the first 5 seconds of a message, the previous message is played.

Erasing all messages

Press [ERASE] 2 times while the unit is not in use.

Listening to messages using the handset

When new messages have been recorded, "New message" is displayed.

- 1 [MENU]
- 2 [↕]: "Answering device" → [OK]
- 3 [↕]: "Play new msg." or "Play all msg." → [OK]
- 4 When finished, press [OFF].

Note:

- To switch to the receiver, press [📞].

Operating the answering system

[MENU] → [↕]: "Answering device" → [OK]

Key	Operation
[▲] or [▼]	Adjust the receiver/speaker volume (during playback)

Answering System

Key	Operation
[1] or [◀]	Repeat message (during playback)*1
[2] or [▶]	Skip message (during playback)
[3]	Enter the "Settings" menu
[4]	Play new messages
[5]	Play all messages
[6]	Play greeting message
[7] [6]	Record greeting message
[8]	Turn answering system on
[MENU]	Pause message*2
[9]	Stop recording Stop playback
[0]	Turn answering system off
[*] [4]*3	Erase currently playing message
[*] [5]*4	Erase all messages
[*] [6]	Reset to a pre-recorded greeting message

*1 If pressed within the first 5 seconds of a message, the previous message is played.

*2 To resume playback:
[↕]: "Playback" → [OK]

*3 You can also erase as follows:
[CLEAR] → [↕]: "Yes" → [OK]

*4 During playback, you can also erase as follows:
[MENU] → [↕]: "Erase all" → [OK]
→ [↕]: "Yes" → [OK]

Calling back (Caller ID subscribers only)

If caller information is received for the call, you can call the caller back while listening to a message.

1 Press [MENU] during playback.

2 [↕]: "Edit & Call" → [OK]
• To edit the number before calling back, press [MENU] repeatedly until the

phone number is shown in the desired format (page 22).

3 [↩]

Erasing all messages

1 [MENU]

2 [↕]: "Answering device" → [OK]

3 [↕]: "Erase all msg." → [OK]

4 [↕]: "Yes" → [OK] → [OFF]

Remote operation

Using a touch-tone phone, you can call your phone number from outside and access the unit to listen to messages or change answering system settings. The unit's voice guidance prompts you to press certain dial keys to perform different operations.

Remote access code

A 3-digit remote access code must be entered when operating the answering system remotely. This code prevents unauthorized parties from listening to your messages remotely. The default setting is "111".

Important:

- To prevent unauthorized access to this product, we recommend that you regularly change the remote code.

1 [MENU]

2 [↕]: "Answering device" → [OK]

3 [↕]: "Settings" → [OK]

4 [↕]: "Remote code" → [OK]

5 Enter the desired 3-digit remote access code.

6 [OK] → [OFF]

Deactivating remote operation

Press [*] in step 5 on "Remote access code", page 26.

- The entered remote access code is deleted.

Using the answering system remotely

- 1 Dial your phone number from a touch-tone phone.
- 2 After the greeting message starts, enter your remote access code.
- 3 Follow the voice guidance prompts as necessary or control the unit using remote commands (page 27).
- 4 When finished, hang up.

Voice guidance

■ When the English voice guidance is selected

During remote operation, the unit's voice guidance starts and prompts you to press **[1]** to perform a specific operation, or press **[2]** to listen to more available operations.

■ When the Spanish voice guidance is selected

To start the voice guidance, press **[9]**. The voice guidance announces the available remote commands (page 27).

Note:

- If you do not press any dial keys within 10 seconds after a voice guidance prompt, the unit disconnects your call.

Remote commands

You can press dial keys to access certain answering system functions without waiting for the voice guidance to prompt you.

Key	Operation
[1]	Repeat message (during playback) ^{*1}
[2]	Skip message (during playback)
[4]	Play new messages
[5]	Play all messages
[9]	Stop playback ^{*2} Start voice guidance ^{*3}
[0]	Turn answering system off
[*][4]	Erase currently playing message

Key	Operation
[*][5]	Erase all messages
[*][#]	End remote operation (or hang up)

*1 If pressed within the first 5 seconds of a message, the previous message is played.

*2 For English voice guidance only

*3 For Spanish voice guidance only

Turning on the answering system remotely

If the answering system is off, you can turn it on remotely.

- 1 Dial your phone number from a touch-tone phone.
- 2 Let the phone ring 15 times.
 - A long beep is heard.
- 3 Enter your remote access code within 10 seconds after the long beep.
 - The greeting message is played back.
 - You can either hang up, or enter your remote access code again and begin remote operation (page 26).

Answering system settings

Number of rings before the unit answers a call

You can change the number of times the phone rings "**Ring count**" before the unit answers calls. You can select 2 to 7 rings, or "**Toll saver**".

The default setting is "**4 rings**".

"**Toll saver**": The unit's answering system answers at the end of the 2nd ring when new messages have been recorded, or at the end of the 5th ring when there are no new messages. If you call your phone from outside to listen to new messages (page 26), you know that there are no new messages when the phone rings for the 3rd time. You can then hang up without being charged for the call.

Answering System

- 1 [MENU]
- 2 [↕]: "Answering device" → [OK]
- 3 [↕]: "Settings" → [OK]
- 4 [↕]: "Ring count" → [OK]
- 5 [↕]: Select the desired setting. → [OK]
→ [OFF]

- 4 [↕]: "Recording time" → [OK]
- 5 [↕]: Select the desired setting. → [OK]
→ [OFF]

For voice mail service subscribers

If you subscribe to a flat-rate service package that includes Caller ID, call waiting, voice mail, and unlimited local/regional/long distance calls, please note the following:

- To use the voice mail service provided by your service provider/telephone company rather than the unit's answering system, turn off the answering system (page 24).
- To use this unit's answering system rather than the voice mail service provided by your service provider/telephone company, please contact your service provider/telephone company to deactivate your voice mail service.
If your service provider/telephone company cannot do this:

- Set this unit's "Ring count" setting so that this unit's answering system answers calls before the voice mail service of your service provider/telephone company does. It is necessary to check the number of rings required to activate the voice mail service provided by your service provider/telephone company before changing this setting.
- Change the number of rings of the voice mail service so that the answering system can answer the call first. To do so, contact your service provider/telephone company.

Caller's recording time

You can change the maximum message recording time allowed for each caller. The default setting is "3 min".

- 1 [MENU]
- 2 [↕]: "Answering device" → [OK]
- 3 [↕]: "Settings" → [OK]

Voice mail service

Voice mail is an automatic answering service offered by your service provider/telephone company. After you subscribe to this service, your service provider/telephone company's voice mail system answers calls for you when you are unavailable to answer the phone or when your line is busy. Messages are recorded by your service provider/telephone company, not your telephone. Please contact your service provider/telephone company for details of this service.

Important:

- To use the voice mail service provided by your service provider/telephone company rather than the unit's answering system, turn off the answering system (page 24). For details, see page 28.

Voice mail message indication

When you have new voice mail messages, "**New Voice Mail**" is displayed on the handset if message indication service is available.

In order to listen to your voice mail messages, you must dial the voice mail access number of your service provider/telephone company.

Note:

- If the handset still indicates there are new messages even after you have listened to all new messages, turn it off by pressing and holding **[#]** until the handset beeps.

Intercom

Intercom calls can be made between handsets.

Note:

- When paging the handset, the paged handset beeps for 1 minute.
- If you receive an outside call while talking on the intercom, you hear 2 tones. To answer the call with the handset, press **[OFF]**, then press **[↶]**.

Making an intercom call

- 1 **[MENU]**
- 2 **[↕]: "Intercom" → [OK]**
- 3 Select the handset you want to page by pressing the desired handset number (**[1]** – **[6]**).
 - To stop paging, press **[OFF]**.
- 4 When you finish talking, press **[OFF]**.

Answering an intercom call

- 1 Press **[↶]** to answer the page.
- 2 When you finish talking, press **[OFF]**.

Handset locator

You can locate a misplaced handset by paging it.

- 1 **Base unit:** Press **[LOCATOR]**.
 - All registered handsets beep for 1 minute.
- 2 To stop paging:
Base unit:
Press **[LOCATOR]**.
Handset:
Press **[OFF]**.

Transferring calls, conference calls

Outside calls can be transferred or a conference call with an outside party can be made between 2 handsets.

- 1 During an outside call, press **[MENU]** to put the call on hold.
- 2 **[↕]: "Intercom" → [OK]**
- 3 Select the handset you want to page by pressing the desired handset number (**[1]** – **[6]**).
- 4 Wait for the paged party to answer.
 - If the paged party does not answer, press **[↶]** to return to the outside call.
- 5 **To complete the transfer:**
Press **[OFF]**.
 - The outside call is being routed to the destination unit.**To establish a conference call:**
[MENU] → [↕]: "Conference" → [OK]
 - To leave the conference, press **[OFF]**. The other 2 parties can continue the conversation.
 - To put the outside call on hold: **[MENU] → [↕]: "Hold" → [OK]**
To resume the conference: **[MENU] → [↕]: "Conference" → [OK]**

Answering a transferred call

Press **[↶]** to answer the page.

Wall mounting

Note:

- Make sure that the wall and the fixing method are strong enough to support the weight of the unit.

Base unit

- 1 Thread the AC adaptor cord and telephone line cord through the hole in the wall mounting adaptor in the direction of the arrow.

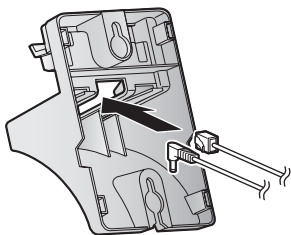

- 2 Tuck the telephone line cord inside the wall mounting adaptor (1). Connect the AC adaptor cord and telephone line cord (2).

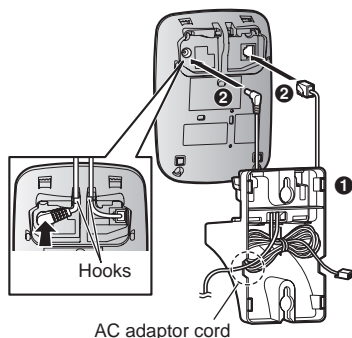

- 3 Insert the hooks on the wall mounting adaptor into holes **A** and **B** on the base unit.

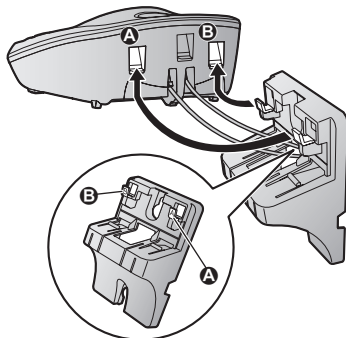

- 4 Adjust the adaptor to hold the base unit, then push it in the direction of the arrow until it clicks into place.

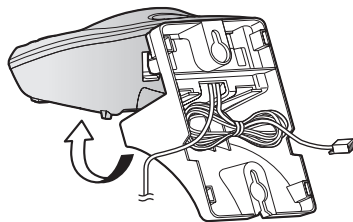
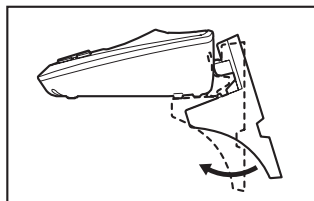

Useful Information

- 5 Mount the unit on a wall then slide down to secure in place.

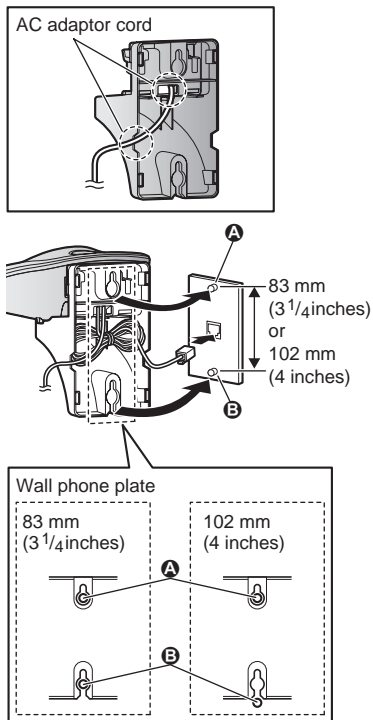

To remove the wall mounting adaptor

While pushing down the release levers (1), remove the adaptor (2).

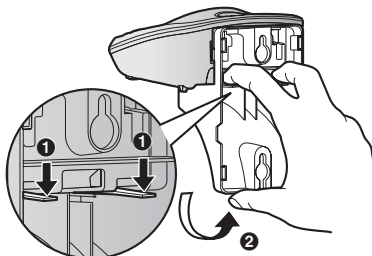

Charger

Drive the screws (not supplied) into the wall.

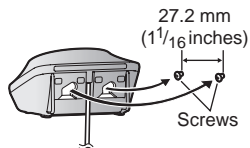

Error messages

Display message	Cause/solution
Busy	<ul style="list-style-type: none"> • The called unit is in use. • Other units are in use and the system is busy. Try again later. • The handset you are using is too far from the base unit. Move closer and try again. • There is no handset registered to the base unit matching the handset number you entered.
Error!!	<ul style="list-style-type: none"> • Recording was too short. Try again.
No link to base. Reconnect main base AC adaptor.	<ul style="list-style-type: none"> • The handset has lost communication with the base unit. Move closer to the base unit and try again. • Unplug the base unit's AC adaptor to reset the unit. Reconnect the adaptor and try again. • The handset's registration may have been canceled. Re-register the handset (page 21).

Troubleshooting

If you still have difficulties after following the instructions in this section, disconnect the base unit's AC adaptor, then reconnect the base unit's AC adaptor. Remove the batteries from the handset, and then insert the batteries into the handset again.

General use

Problem	Cause/solution
The handset does not turn on even after installing charged batteries.	<ul style="list-style-type: none"> • Place the handset on the base unit or charger to turn on the handset.
The unit does not work.	<ul style="list-style-type: none"> • Make sure the batteries are installed correctly (page 9). • Fully charge the batteries (page 9). • Check the connections (page 9). • Unplug the base unit's AC adaptor to reset the unit. Reconnect the adaptor and try again. • The handset has not been registered to the base unit. Register the handset (page 21).



Useful Information

Problem	Cause/solution
I cannot hear a dial tone.	<ul style="list-style-type: none">• The base unit's AC adaptor or telephone line cord is not connected. Check the connections.• Disconnect the base unit from the telephone line and connect the line to a known working telephone. If the working telephone operates properly, contact our service personnel to have the unit repaired. If the working telephone does not operate properly, contact your service provider/ telephone company.

Programmable settings

Problem	Cause/solution
The display is in a language I cannot read.	<ul style="list-style-type: none">• Change the display language (page 12).
I cannot register a handset to a base unit.	<ul style="list-style-type: none">• The maximum number of handsets (6) is already registered to the base unit. Cancel unused handset registrations from the base unit (page 21).

Battery recharge

Problem	Cause/solution
The handset beeps and/or  flashes.	<ul style="list-style-type: none">• Battery charge is low. Fully charge the batteries (page 9).
I fully charged the batteries, but –  still flashes, or – the operating time seems to be shorter.	<ul style="list-style-type: none">• Clean the battery ends (\oplus, \ominus) and the charge contacts with a dry cloth and charge again.• It is time to replace the batteries (page 9).

Making/answering calls, intercom

Problem	Cause/solution
 is flashing.	<ul style="list-style-type: none">• The handset is too far from the base unit. Move closer.• The base unit's AC adaptor is not properly connected. Reconnect AC adaptor to the base unit.• The handset is not registered to the base unit. Register it (page 21).
Noise is heard, sound cuts in and out.	<ul style="list-style-type: none">• You are using the handset or base unit in an area with high electrical interference. Re-position the base unit and use the handset away from sources of interference.• Move closer to the base unit.• If you use a DSL/ADSL service, we recommend connecting a DSL/ADSL filter between the base unit and the telephone line jack. Contact your DSL/ADSL provider for details.

Problem	Cause/solution
The handset does not ring.	<ul style="list-style-type: none"> The ringer volume is turned off. Adjust the ringer volume (page 14, 20).
The base unit does not ring.	<ul style="list-style-type: none"> The ringer volume is turned off. Adjust the ringer volume (page 15).
I cannot make a call.	<ul style="list-style-type: none"> The dialing mode may be set incorrectly. Change the setting (page 13).
I cannot make long distance calls.	<ul style="list-style-type: none"> Make sure that you have long distance service.

Caller ID

Problem	Cause/solution
Caller information is not displayed.	<ul style="list-style-type: none"> You must subscribe to Caller ID service. Contact your service provider/telephone company for details. If your unit is connected to any additional telephone equipment such as a Caller ID box or cordless telephone line jack, plug the unit directly into the wall jack. If you use a DSL/ADSL service, we recommend connecting a DSL/ADSL filter between the base unit and the telephone line jack. Contact your DSL/ADSL provider for details. The name display service may not be available in some areas. Contact your service provider/telephone company for details. Other telephone equipment may be interfering with this unit. Disconnect the other equipment and try again.
Caller information is displayed late.	<ul style="list-style-type: none"> Depending on your service provider/telephone company, the unit may display the caller's information at the 2nd ring or later. Move closer to the base unit.
The caller list/incoming phone numbers are not edited automatically.	<ul style="list-style-type: none"> The Caller ID number auto edit feature is turned off. Turn it on and try again (page 20). You need to call back the edited number to activate Caller ID number auto edit.
I cannot dial the phone number edited in the caller list.	<ul style="list-style-type: none"> The phone number you dialed might have been edited incorrectly (for example, the long distance "1" or the area code is missing). Edit the phone number with another pattern (page 22).
The 2nd caller's information is not displayed during an outside call.	<ul style="list-style-type: none"> In order to use Caller ID, call waiting, or Call Waiting Caller ID (CWID), you must first contact your service provider/telephone company and subscribe to the desired service. After subscribing, you may need to contact your service provider/telephone company again to activate this specific service, even if you already subscribed to both Caller ID and Call Waiting with Caller ID services (CWID).

Useful Information

Answering system

Problem	Cause/solution
The unit does not record new messages.	<ul style="list-style-type: none">● The answering system is turned off. Turn it on (page 24).● The message memory is full. Erase unnecessary messages (page 25).● If you subscribe to a voice mail service, messages are recorded by your service provider/telephone company, not your telephone. Change the unit's number of rings setting or contact your service provider/telephone company (page 28).
I cannot operate the answering system remotely.	<ul style="list-style-type: none">● The remote access code is not set. Set the remote access code (page 26).● You are entering the wrong remote access code. If you have forgotten your remote access code, enter the remote access code setting to check your current code (page 26).● The answering system is turned off. Turn it on (page 27).

Liquid damage

Problem	Cause/solution
Liquid or other form of moisture has entered the handset/base unit.	<ul style="list-style-type: none">● Disconnect the AC adaptor and telephone line cord from the base unit. Remove the batteries from the handset and leave to dry for at least 3 days. After the handset/base unit are completely dry, reconnect the AC adaptor and telephone line cord. Insert the batteries and charge fully before use. If the unit does not work properly, contact an authorized service center.

Caution:

- To avoid permanent damage, do not use a microwave oven to speed up the drying process.

FCC and other information

This equipment complies with Part 68 of the FCC rules and the requirements adopted by the ACTA. On the bottom of this equipment is a label that contains, among other information, a product identifier in the format US:ACJ-----.

If requested, this number must be provided to the telephone company.

- Registration No.....(found on the bottom of the unit)
- Ringer Equivalence No. (REN).....0.1B

A plug and jack used to connect this equipment to the premises wiring and telephone network must comply with the applicable FCC Part 68 rules and requirements adopted by the ACTA. A compliant telephone cord and modular plug is provided with the product. It is designed to be connected to a compatible modular jack that is also compliant.

The REN is used to determine the number of devices that may be connected to a telephone line. Excessive RENs on a telephone line may result in the devices not ringing in response to an incoming call. In most but not all areas, the sum of RENs should not exceed five (5.0). To be certain of the number of devices that may be connected to a line, as determined by the total RENs, contact the local telephone company. For products approved after July 23, 2001, the REN for the product is part of the product identifier that has the format US:AAAEQ##TXXXX. The digits represented by ## are the REN without a decimal point (e.g., 03 is a REN of 0.3).

If this equipment causes harm to the telephone network, the telephone company will notify you in advance that temporary discontinuance of service may be required. But if advance notice isn't practical, the telephone company will notify the customer as soon as possible. Also, you will be

advised of your right to file a complaint with the FCC if you believe it is necessary.

The telephone company may make changes in its facilities, equipment, operations or procedures that could affect the operation of the equipment. If this happens the telephone company will provide advance notice in order for you to make necessary modifications to maintain uninterrupted service.

If trouble is experienced with this equipment, for repair or warranty information, please contact a Factory Service Center or other Authorized Servicer. If the equipment is causing harm to the telephone network, the telephone company may request that you disconnect the equipment until the problem is resolved.

Connection to party line service is subject to state tariffs. Contact the state public utility commission, public service commission or corporation commission for information.

If your home has specially wired alarm equipment connected to the telephone line, ensure the installation of this equipment does not disable your alarm equipment. If you have questions about what will disable alarm equipment, consult your telephone company or a qualified installer.

This equipment is hearing aid compatible as defined by the FCC in 47 CFR Section 68.316.

When you hold the phone to your ear, noise might be heard in your Hearing Aid. Some Hearing Aids are not adequately shielded from external RF (radio frequency) energy. If noise occurs, use an optional headset accessory or the speakerphone option (if applicable) when using this phone. Consult with your audiologist or Hearing Aid

Useful Information

manufacturer about the availability of Hearing Aids which provide adequate shielding to RF energy commonly emitted by digital devices.

WHEN PROGRAMMING EMERGENCY NUMBERS AND/OR MAKING TEST CALLS TO EMERGENCY NUMBERS:

- 1) Remain on the line and briefly explain to the dispatcher the reason for the call.
- 2) Perform such activities in the off-peak hours, such as early morning or late evenings.

This device complies with Part 15 of the FCC Rules. Operation is subject to the following two conditions:

(1) This device may not cause harmful interference, and (2) this device must accept any interference received, including interference that may cause undesired operation.

Privacy of communications may not be ensured when using this phone.

CAUTION:

Any changes or modifications not expressly approved by the party responsible for compliance could void the user's authority to operate this device.

NOTE:

This equipment has been tested and found to comply with the limits for a Class B digital device, pursuant to Part 15 of the FCC Rules. These limits are designed to provide reasonable protection against harmful interference in a residential installation. This equipment generates, uses, and can radiate radio frequency energy and, if not installed and used in accordance with the instructions, may cause harmful interference to radio communications. However, there is no guarantee that interference will not occur in a particular installation. If this equipment does cause harmful interference to radio or television reception, which can be determined by turning the equipment off and on, the user is

encouraged to try to correct the interference by one or more of the following measures:

- Reorient or relocate the receiving antenna.
- Increase the separation between the equipment and receiver.
- Connect the equipment into an outlet on a circuit different from that to which the receiver is connected.
- Consult the dealer or an experienced radio/TV technician for help.

Some cordless telephones operate at frequencies that may cause interference to nearby TVs and VCRs. To minimize or prevent such interference, the base of the cordless telephone should not be placed near or on top of a TV or VCR. If interference is experienced, move the cordless telephone further away from the TV or VCR. This will often reduce or eliminate interference.

FCC RF Exposure Warning:

- This product complies with FCC radiation exposure limits set forth for an uncontrolled environment.
- To comply with FCC RF exposure requirements, the base unit must be installed and operated 20 cm (8 inches) or more between the product and all person's body (excluding extremities of hands, wrist and feet).
- This product may not be collocated or operated in conjunction with any other antenna or transmitter.
- For body-worn operation, the handset must be used only with a non-metallic accessory. Use of other accessories may not ensure compliance with FCC RF exposure requirements.

Notice:

- FCC ID can be found inside the battery compartment or on the bottom of the units.

Compliance with TIA-1083 standard:

Telephone handsets identified with this logo have reduced noise and interference when used with T-Coil equipped hearing aids and cochlear implants.



Guía Rápida Española

Instalación

Unidad base

- Use solo el adaptador de corriente Panasonic PNLV226 incluido.

Oprima firmemente el contacto.

Correcto Incorrecto

A la toma de teléfono de línea única (RJ11C)

Filtro DSL/ADSL*

Ganchos

A la toma de corriente

"Clic"

*Se requiere un filtro DSL/ADSL (no incluido) si tiene servicio de DSL/ADSL.

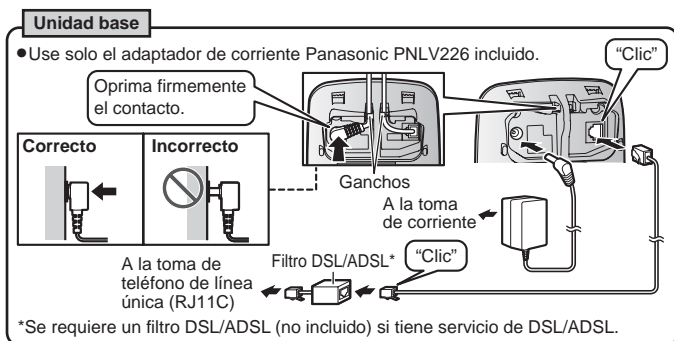

Auricular

- UTILICE SOLO baterías de Ni-MH tamaño AAA (R03).
- NO utilice baterías Alcalinas, de Manganeseo o de Ni-Cd.
- Compruebe que las polaridades son las correctas (+, -).

SOLO baterías Ni-MH recargables

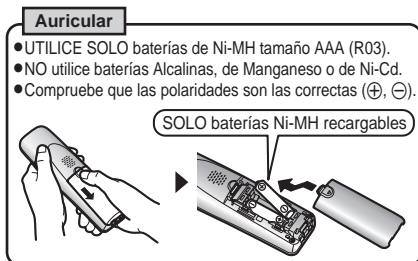

Cargador

A la toma de corriente

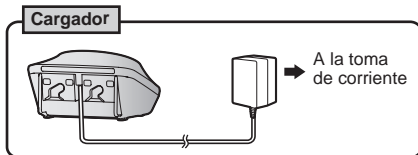

CARGUE APROXIMADAMENTE DURANTE 7 HORAS

Confirme que aparezca "Cargando".



Sugerencias de operación

Tecla navegadora

- **[▲], [▼], [◀], o [▶]**: Navegue por diversas listas y elementos.
- **↵ VOL.** (Volumen: **[▲]** o **[▼]**): Ajuste el volumen del receptor o el altavoz mientras habla.
- **[◀] CID** (Identificador de llamadas): Vea la lista de personas que llamaron.
- **[▶] REDIAL** (Remarcación): Vea la lista de remarcación.

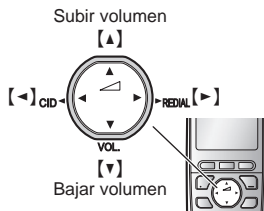

Cambio de idiomas (predeterminado: "English") (Auricular)

Idioma de la pantalla

- 1 **[MENU]** → **[↕]**: "Initial setting" → **[OK]**
- 2 **[↕]**: "Display settings" → **[OK]**
- 3 **[↕]**: "Change language" → **[OK]**
- 4 **[↕]**: "Español" → **[OK]** → **[OFF]**

Idioma de la guía de voz

- 1 **[MENU]** → **[↕]**: "Contestadora" → **[OK]**
- 2 **[↕]**: "Ajustes" → **[OK]**
- 3 **[↕]**: "Menú de voz" → **[OK]**
- 4 **[↕]**: "Español" → **[OK]** → **[OFF]**

Fecha y hora (Auricular)

- 1 **[MENU]** → **[↕]**: "Fecha y hora" → **[OK]**
- 2 Introduzca el día, mes y año actuales.
- 3 Introduzca la hora y minuto actuales (formato de reloj de 24 horas).
- 4 **[OK]** → **[OFF]**

Operaciones básicas

Cómo hacer y contestar llamadas (Auricular)

Para hacer llamadas	Marque el número telefónico. → [📞]/[☎]
Para contestar llamadas	[📞]/[☎]
Para colgar	[OFF]

Operaciones básicas

Cómo hacer y contestar llamadas (Auricular)

Para ajustar el volumen del receptor o del altavoz	Oprima [▲] o [▼] repetidamente mientras habla.
Cómo hacer una llamada usando la lista de remarcación	[►] REDIAL → [↕]: Seleccione el número telefónico deseado. → [↶]
Para ajustar el volumen del timbre del auricular	<ol style="list-style-type: none"> 1 [MENU] → [↕]: "Ajuste inicial" → [OK] 2 [↕]: "Ajuste de timbre" → [OK] 3 [↕]: "Vol. de timbre" → [OK] 4 [↕]: Seleccione el volumen deseado. → [OK] → [OFF]

Directorio telefónico compartido (Auricular)

Para añadir entradas	<ol style="list-style-type: none"> 1 [□] → [MENU] → [↕]: "Agr Ent Nueva" → [OK] 2 Introduzca el nombre de la persona (máx. 16 caracteres). → [OK] 3 Introduzca el número telefónico de la persona (máx. 24 dígitos). → [OK] 2 veces → [OFF]
Para hacer llamadas	[□] → [↕]: Seleccione la entrada deseada. → [↶]

Contestador de llamadas (Unidad base)

Contestador encendido/apagado	Oprima [ANSWER ON/OFF] para encender y apagar el contestador de llamadas.
Para escuchar mensajes	[►] (PLAY)

Sistema contestador de llamadas (Auricular)

Para escuchar mensajes	<ol style="list-style-type: none"> 1 [MENU] → [↕]: "Contestadora" → [OK] 2 [↕]: "Reprod. nuevos" o "Reprod. todos" → [OK]
------------------------	--

Preguntas frecuentes

Pregunta	Causa y solución
¿Por qué está parpadeando Ψ ?	<ul style="list-style-type: none"> ● El auricular está demasiado lejos de la unidad base. Acérquelo. ● El adaptador para corriente de la unidad base no está conectado correctamente. Conecte de nuevo el adaptador para corriente a la unidad base. ● El auricular no está registrado en la unidad base. Regístrelo. <ol style="list-style-type: none"> 1 Auricular: [MENU] → [⊕]: "Ajuste inicial" → [OK] → [⊕]: "Registrar" → [OK] → [⊕]: "Registrar Auric." → [OK] 2 Unidad base: Oprima y mantenga oprimido [LOCATOR] durante aproximadamente 5 segundos hasta que suene el tono de registro. 3 Auricular: Oprima [OK], y después espere hasta que suene un pitido largo.
¿Cómo se incrementa el nivel de volumen del auricular?	<ul style="list-style-type: none"> ● Oprima la tecla de navegación [▲] repetidamente mientras habla.
¿Por qué hay ruido o se corta la conversación?	<ul style="list-style-type: none"> ● Trate de reubicar la unidad base de forma que se minimice la distancia al auricular. ● Si ocurre el mismo problema aunque el auricular se encuentre enseguida de la unidad base, llame a soporte al cliente de Panasonic al 1-800-211-PANA (1-800-211-7262).
¿Es posible añadir otro auricular accesorio a mi unidad base?	<ul style="list-style-type: none"> ● Sí, puede añadir hasta 6 auriculares (incluyendo los que se venden con su unidad base) a una sola unidad base. ● Para adquirir auriculares accesorios adicionales (KX-TGA421), visite http://www.pstc.panasonic.com o llame al 1-800-332-5368. Los usuarios TTY (usuarios con impedimentos auditivos o del habla) pueden llamar al 1-866-605-1277.
¿Es posible mantener cargando las baterías todo el tiempo?	<ul style="list-style-type: none"> ● Puede dejar el auricular en la unidad base o el cargador en cualquier momento. Esto no daña las baterías.
¿Cómo se contestan las llamadas en espera (segunda llamada)?	<ul style="list-style-type: none"> ● Oprima [CALL WAIT] cuando escuche el tono de llamada en espera.

Para obtener más información acerca del registro, visite <http://www.panasonic.com/RegisterYourHandset> (solo en inglés)

Customer services

Customer Services Directory (United States and Puerto Rico)

Obtain Product Information and Operating Assistance; locate your nearest Dealer or Service Center; purchase Parts and Accessories; or make Customer Service and Literature requests by visiting our Web Site at:

<http://www.panasonic.com/help>

or, contact us via the web at:

<http://www.panasonic.com/contactinfo>

You may also contact us directly at: 1-800-211-PANA (1-800-211-7262), Monday - Friday 9 am to 9 pm; Saturday - Sunday 10 am to 7 pm, EST.

TTY users (hearing or speech impaired users) can call 1-877-833-8855.

Accessory Purchases (United States and Puerto Rico)

Purchase Parts, Accessories and Instruction Books online for all Panasonic Products by visiting our Web Site at:

<http://www.pstc.panasonic.com>

or, send your request by E-mail to:

npcparts@us.panasonic.com

You may also contact us directly at:

1-800-332-5368 (Phone) 1-800-237-9080 (Fax Only)

(Monday - Friday 9 am to 9 pm, EST.)

Panasonic Service and Technology Company

20421 84th Avenue South, Kent, WA 98032

(We Accept Visa, MasterCard, Discover Card, American Express, and Personal Checks.)

TTY users (hearing or speech impaired users) can call 1-866-605-1277.

Warranty (For United States and Puerto Rico)

PANASONIC CORPORATION OF NORTH AMERICA
One Panasonic Way, Secaucus, New Jersey 07094

Panasonic Telephone Products Limited Warranty

Limited Warranty Coverage

If your product does not work properly because of a defect in materials or workmanship, Panasonic Corporation of North America (referred to as "the warrantor") will, for the length of the period indicated on the chart below, which starts with the date of original purchase ("Limited Warranty period"), at its option either (a) repair your product with new or refurbished parts, or (b) replace it with a new or a refurbished product. The decision to repair or replace will be made by the warrantor.

Parts	Labor
One (1) Year	One (1) Year

During the "Labor" Limited Warranty period there will be no charge for labor. During the "Parts" Limited Warranty period, there will be no charge for parts. You must mail-in your product prepaid during the Limited Warranty period. This Limited Warranty excludes both parts and labor for batteries, antennas, and cosmetic parts (cabinet). This Limited Warranty only applies to products purchased and serviced in the United States or Puerto Rico. This Limited Warranty is extended only to the original purchaser and only covers products purchased as new.

Ship-In Service

For assistance in the continental United States and Puerto Rico in obtaining repairs please ship the product prepaid to:

Panasonic Exchange Center,
4900 George McVay Drive, Suite B Door #12, McAllen, TX 78503
panacare@us.panasonic.com

Online Repair Request

To submit a new repair and for quick repair status visit our web site at
<http://www.panasonic.com/help>

When shipping the unit carefully pack in a padded shipping carton, include all accessories, and send it prepaid. Include a letter detailing the complaint, a return address and provide a day time phone number where you can be reached. P.O. Boxes are not acceptable. Keep the tracking number for your records. A copy of valid registered receipt is required under the 1 year parts and labor Limited Warranty.

For Limited Warranty service for headsets if a headset is included with this product please follow instructions above.

IF REPAIR IS NEEDED DURING THE LIMITED WARRANTY PERIOD THE PURCHASER WILL BE REQUIRED TO FURNISH A SALES RECEIPT/PROOF OF PURCHASE INDICATING DATE OF PURCHASE, AMOUNT PAID AND PLACE OF PURCHASE. CUSTOMER WILL BE CHARGED FOR THE REPAIR OF ANY UNIT RECEIVED WITHOUT SUCH PROOF OF PURCHASE.

Limited Warranty Limits And Exclusions

This Limited Warranty ONLY COVERS failures due to defects in materials or workmanship, and DOES NOT COVER normal wear and tear or cosmetic damage. The Limited Warranty ALSO DOES NOT COVER damages which occurred in shipment, or failures which are caused by products not supplied by the warrantor, or failures which result from accidents, misuse, abuse, neglect, bug infestation, mishandling, misapplication, alteration, faulty installation, set-up adjustments, misadjustment of consumer controls, improper maintenance, power line surge, lightning damage, modification, introduction of sand, humidity or liquids, commercial use such as hotel, office, restaurant, or other business or rental use of the product, or service by anyone other than a Factory Service Center or other Authorized Servicer, or damage that is attributable to acts of God.

THERE ARE NO EXPRESS WARRANTIES EXCEPT AS LISTED UNDER "LIMITED WARRANTY COVERAGE". THE WARRANTOR IS NOT LIABLE FOR INCIDENTAL OR CONSEQUENTIAL DAMAGES RESULTING FROM THE USE OF THIS PRODUCT, OR ARISING OUT OF ANY BREACH OF THIS LIMITED WARRANTY. (As examples, this excludes damages for lost time, lost calls or messages, cost of having someone remove or re-install an installed unit if applicable, travel to and from the servicer. The items listed are not exclusive, but are for illustration only.) **ALL EXPRESS AND IMPLIED WARRANTIES, INCLUDING THE WARRANTY OF MERCHANTABILITY, ARE LIMITED TO THE PERIOD OF THE LIMITED WARRANTY.**

Some states do not allow the exclusion or limitation of incidental or consequential damages, or limitations on how long an implied warranty lasts, so the exclusions may not apply to you.

This Limited Warranty gives you specific legal rights and you may also have other rights which vary from state to state. If a problem with this product develops during or after the Limited Warranty period, you may contact your dealer or Service Center. If the problem is not handled to your satisfaction, then write to the warrantor's Consumer Affairs Department at the addresses listed for the warrantor.

PARTS AND SERVICE, WHICH ARE NOT COVERED BY THIS LIMITED WARRANTY, ARE YOUR RESPONSIBILITY.

When you ship the product

- Carefully pack your unit, preferably in the original carton.
- Attach a letter, detailing the symptom.
- Send the unit to Panasonic Exchange Center, prepaid and adequately insured.
- Do not send your unit to Panasonic Corporation of North America listed on the back cover or to executive or regional sales offices. These locations do not repair consumer products.

Index

- # 4-way conference: 16
- A** Additional handset: 21
- Answering calls: 14
- Answering system
 - Call screening: 24
 - Erasing messages: 25, 26, 27
 - Greeting message: 24
 - Listening to messages: 25, 27
 - Number of rings: 27
 - Recording time: 28
 - Remote access code: 26
 - Remote operation: 26
 - Ring count: 27
 - Toll saver: 27
 - Turning on/off: 24
- Auto talk: 14, 20
- B** Battery: 9, 10
- Booster (Clarity booster): 15
- C** Call share: 16
- Call waiting: 15
- Call Waiting Caller ID: 15
- Caller ID number auto edit: 20, 23
- Caller ID service: 22
- Caller list: 22
- Caller list edit: 22
- Chain dial: 18
- CID (Caller ID): 22
- Conference calls: 30
- Customer support: 20
- D** Date and time: 12
- Dialing mode: 13
- Display
 - Contrast: 20
 - Language: 12
- E** Eco mode: 10
- Error messages: 33
- F** Flash: 15, 20
- H** Handset
 - Deregistration: 21
 - Locator: 30
 - Registration: 21
- Hold: 15
- I** Intercom: 30
- K** Key tone: 20
- M** Making calls: 14
- Missed calls: 22
- Mute: 15
- P** Pause: 14
- Phonebook: 17
- Power failure: 10
- Privacy mode: 20
- R** Redialing: 14
- Ringer tone: 20
- Rotary/pulse service: 15
- S** SP-PHONE (Speakerphone): 14
- T** Temporary tone dialing: 15
- Transferring calls: 30
- Troubleshooting: 33
- TTY: 44
- V** Voice guidance language: 12
- Voice mail: 28, 29
- Volume
 - Receiver: 14
 - Ringer (Base unit): 15
 - Ringer (Handset): 14, 20
 - Speaker: 14
- W** Wall mounting: 31

IMPORTANT!

If your product is not working properly. . .

- ① **Reconnect AC adaptor to the base unit.**
- ② **Check if telephone line cord is connected.**
- ③ **Use rechargeable Ni-MH batteries.**
(Alkaline/Manganese/Ni-Cd batteries CANNOT be used.)
- ④ Read **troubleshooting** page in the **Operating Instructions**.



Visit our Web site: <http://www.panasonic.com/help>

- **FAQ and troubleshooting hints are available.**

For your future reference

We recommend keeping a record of the following information to assist with any repair under warranty.

Serial No. (found on the bottom of the base unit)	Date of purchase
Name and address of dealer	

Attach your purchase receipt here.

Panasonic Corporation of North America
One Panasonic Way, Secaucus, New Jersey 07094

© Panasonic System Networks Co., Ltd. 2012

Printed in Malaysia



PNQX5754ZA

PNQX5754ZA PT1212MU0

Free Manuals Download Website

<http://myh66.com>

<http://usermanuals.us>

<http://www.somanuals.com>

<http://www.4manuals.cc>

<http://www.manual-lib.com>

<http://www.404manual.com>

<http://www.luxmanual.com>

<http://aubethermostatmanual.com>

Golf course search by state

<http://golfingnear.com>

Email search by domain

<http://emailbydomain.com>

Auto manuals search

<http://auto.somanuals.com>

TV manuals search

<http://tv.somanuals.com>