

Table of Contents

Introduction

Introduction	3
About these operating instructions	4
Expanding your phone system	7
Accessory information	9
Important safety instructions	12
For best performance	14

Preparation

Setting up the base unit	15
Setting up the handset	16
Controls	19
Displays	22
Symbols used in these operating instructions	24
Setting the unit before use	25

Making/Answering Calls

Making calls	26
Answering calls	27
Useful features during a call	28

Phonebook

Handset phonebook	31
-----------------------------	----

Base Unit Speed Dialer

Base unit speed dialer	36
----------------------------------	----

Caller ID Service

Using Caller ID service	37
Caller list	39

Programming

Programmable settings	41
Customizing handset ringer tone and display	49

Answering System

Answering system	54
Listening to messages using the base unit	55

Listening to messages using the handset	56
Voice memo	57
Remote operation	58
Answering system settings	59

Voice Mail Service

Using Voice Mail service	62
------------------------------------	----

Multi-unit Operation

Intercom	63
Transferring calls	65
Conference calls	66
Registering a handset	67

Useful Information

Additional accessories	68
Error messages	69
Troubleshooting	71
FCC and other information	75
Specifications	78
Warranty	79
Customer services	81

Index

Index	82
-----------------	----

Introduction

Thank you for purchasing a Panasonic cordless telephone.

We recommend keeping a record of the following information for future reference.

Serial No. (found on the bottom of the base unit)	Date of purchase
Name and address of dealer	

Attach your purchase receipt here.

About these operating instructions



Notable differences among KX-TG5771, KX-TG5776, KX-TG5777, and KX-TG5779

These operating instructions can be used for the following models:

- KX-TG5771 features a monochrome display handset (KX-TGA570).
- KX-TG5776 and KX-TG5779 feature a color display handset with USB-support (KX-TGA571).
- KX-TG5777 features 2 color display handsets with USB-support (KX-TGA571).
- KX-TG5779 also features the 5.8 GHz cordless camera (KX-TGA573). For operations related to this cordless camera, refer to the included cordless camera's operating instructions.

Important:

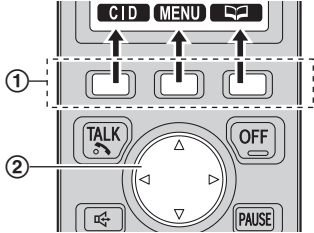
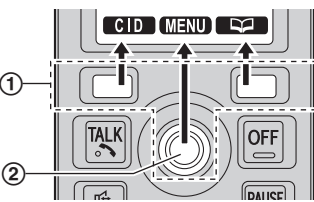
- Features and operations indicated by “**monochrome display models**” are for KX-TG5771 users and KX-TGA570 (accessory handset) users only.
- Features and operations indicated by “**color display models**” are for KX-TG5776 users, KX-TG5777 users, KX-TG5779 users, and KX-TGA571 (accessory handset) users only.
- For the differences between the monochrome display handset (KX-TGA570) and the color display handset (KX-TGA571), see page 8.
- References in these operating instructions to “a charger” or “other handsets” are for accessory handset users and KX-TG5777 users only. See “Expanding your phone system” on page 7.

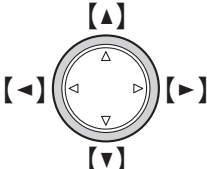
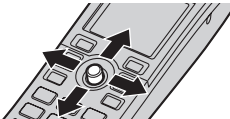
Monochrome display model: KX-TGA570 (included with KX-TG5771)	Color display model: KX-TGA571 (included with KX-TG5776/ KX-TG5777/KX-TG5779)
 <p>The diagram shows a monochrome handset keypad. At the top, three soft keys are labeled 'CID', 'MENU', and a book icon. Below them are three rectangular keys. A dashed box labeled '1' encloses these three keys. Below that is a circular joystick with four directional arrows (up, down, left, right). A dashed box labeled '2' encloses the joystick and the 'TALK' and 'OFF' keys on either side.</p>	 <p>The diagram shows a color handset keypad. At the top, three soft keys are labeled 'CID', 'MENU', and a book icon. Below them are three rectangular keys. A dashed box labeled '1' encloses these three keys. Below that is a circular joystick with four directional arrows. A dashed box labeled '2' encloses the joystick and the 'TALK' and 'OFF' keys on either side.</p>
<p>① Using the soft keys The handset features 3 soft keys. By pressing a soft key, you can select the feature shown directly above it on the display.</p>	<p>① Using the soft keys The handset features 2 soft keys and joystick (middle soft key). By pressing a soft key, you can select the feature shown directly above it on the display.</p> <p>Middle soft key: The joystick can be used to select the center soft key icon, by pressing down on the center of the joystick.</p>  <p>A close-up diagram of the joystick with a downward-pointing arrow and the text 'Middle soft key'.</p>
<p>② Using the navigator key The handset navigator key can be used to navigate through menus and to select items shown on the display, by pressing [▲], [▼], [◀], or [▶].</p>  <p>A diagram of the joystick with four arrows pointing up, down, left, and right, each enclosed in a square bracket. The joystick itself is shown in the center with its four directional arrows.</p>	<p>② Using the joystick The handset joystick can be used to navigate through menus and to select items shown on the display, by pushing it up [▲], down [▼], left [◀], or right [▶].</p>  <p>A close-up diagram of the joystick with four arrows pointing up, down, left, and right, each enclosed in a square bracket. The joystick itself is shown in the center with its four directional arrows.</p>





Expanding your phone system

You can expand the phone system by registering the following handsets and other devices to a single base unit (KX-TG5771, KX-TG5776, KX-TG5777, or KX-TG5779): **max. 8**

For further information or to order these handsets and devices, visit

<http://www.panasonic.com>

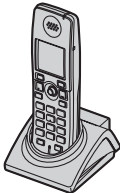
or call the phone number noted on page 11.

Handsets and other devices: max. 8	
5.8 GHz expandable digital cordless handset KX-TGA570 (Monochrome display type) 	5.8 GHz expandable digital cordless camera KX-TGA573 (For camera monitoring from a color display handset KX-TGA571) max. 7 
5.8 GHz expandable digital cordless handset KX-TGA571 (Color display type with USB support) 	5.8 GHz USB adaptor KX-TGA575 (For calls over the Internet)* ¹ max. 1 
5.8 GHz expandable digital cordless handset KX-TGA572 (Monochrome display type with amplified volume) 	

*1 By registering the 5.8 GHz USB adaptor KX-TGA575 to your base unit and installing Skype™ software to your computer, you can make calls with your handset over the Internet via the computer. For operations related to this USB adaptor, refer to the operating instructions included with the USB adaptor.

Trademark

- Skype, SkypeIn, SkypeOut and the S logo are trademarks of Skype Limited.

Introduction

Handset feature overview for KX-TGA570 and KX-TGA571

Operations and features of the 2 different accessory handsets have certain differences as indicated in the table below.

Feature	KX-TGA570	KX-TGA571	Page
Description	Same handset supplied with KX-TG5771	Same handset supplied with KX-TG5776/ KX-TG5777/KX-TG5779	–
Display type	Monochrome	Color	–
Display size	1.4 inch	1.5 inch	–
Control type	Navigator key	Joystick	6
USB-support ^{*1*2}	–	●	–
Custom ring	●	●	49
Melody Utility ^{*2}	–	●	–
Picture ID	–	●	38
Picture Utility ^{*2}	–	●	–
Wallpaper	–	●	52
Phonebook Utility ^{*2}	–	●	–
Memory status display	–	●	52
Camera monitoring ^{*3}	–	●	–

*1 USB-support allows you to connect the handset to your computer and send images and melodies from your computer to the handset, as well as create and edit phonebook entries using your computer.

*2 For information on using this feature, refer to the help section of the GIGARANGE USB Utility software. If you have not installed the GIGARANGE USB Utility software, refer to the included “Installation Guide for GIGARANGE USB Utility” for details.

*3 Requires the 5.8 GHz expandable Digital cordless camera KX-TGA573. KX-TG5779 includes a cordless camera. For operations related to this cordless camera, refer to the included cordless camera’s operating instructions.

Accessory information

Included accessories

No.	Accessory item	Order number	Quantity			
			KX-TG 5771	KX-TG 5776	KX-TG 5777	KX-TG 5779
①	AC adaptor	PQLV207V	1	1	2	1
②	Telephone line cord	PQJA10075Z	1	1	1	1
③	Battery	HHR-P105	1	1	2	1
④	Handset cover ^{*1}	PQYNTG5771SR	1	1	2	1
⑤	Audio cable	PQJA10165Z	1	1	1	1
⑥	USB cable	PQJA10166Z ^{*2} or PQJA10177Z	–	1	1	1
⑦	CD-ROM ^{*3}	PQJKTG5776Z	–	1	1	1
⑧	Charger	PQLV30043ZS	–	–	1	–
⑨	5.8 GHz cordless camera	KX-TGA573S	–	–	–	1
⑩	AC adaptor for cordless camera	PQLV235Z	–	–	–	1
⑪	Wall-mounting adaptor for cordless camera	PQLP10267Z	–	–	–	1
⑫	Call button for cordless camera	PQLP10270Z	–	–	–	1

Introduction

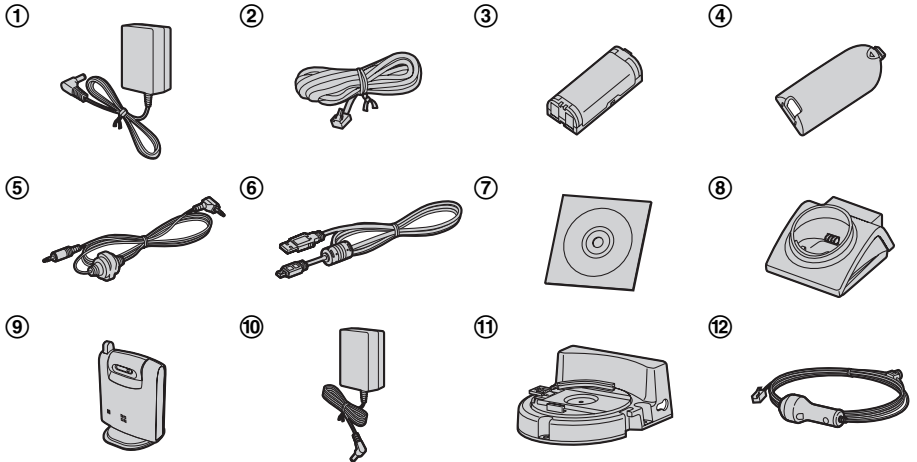

*1 The handset cover comes attached to the handset.

*2 Both of the USB cables function well.

*3 Allows you to install the GIGARANGE USB Utility software on a compatible computer.

Additional/replacement accessories

Accessory item	Order number
Rechargeable nickel metal hydride (Ni-MH) battery	HHR-P105
Headset	KX-TCA60, KX-TCA86, KX-TCA88HA, KX-TCA92, KX-TCA93, KX-TCA94, or KX-TCA95
Belt clip	PQKE10457Z1
Wall-mounting adaptor for base unit	PQKL10078Z1
T-adaptor	KX-J66

Note:

- You can expand your phone system by registering additional compatible Panasonic units (page 7).

Sales and support information

- To order additional/replacement accessories, call 1-800-332-5368.
- TTY users (hearing or speech impaired users) can call 1-866-605-1277.

GIGARANGE® USB utility (Color display models only)

The CD-ROM included with KX-TG5776, KX-TG5777, KX-TG5779, and KX-TGA571 contains the GIGARANGE USB Utility.

Allows you to use your computer to:

- Add, edit, erase, and copy phonebook entries
- Send images stored in your computer to your phone
- Send melodies stored in your computer to your phone
- To install the GIGARANGE USB Utility software in your computer, refer to the “Installation Guide for GIGARANGE USB Utility” for installation details.

Important safety instructions

When using the product, basic safety precautions should always be followed to reduce the risk of fire, electric shock, or personal injury.

1. Read all instructions carefully.
2. Follow all warnings and instructions marked on the product.
3. Unplug the product from power outlets before cleaning. Do not use liquid or aerosol cleaners. Use a moist cloth for cleaning.
4. Do not use the product near water, for example near a bathtub, wash bowl, kitchen sink, etc.
5. Place the product securely on a stable surface. Serious damage and/or injury may result if the product falls.
6. Do not cover slots and openings on the product. They are provided for ventilation and protection against overheating. Never place the product near radiators, or in a place where proper ventilation is not provided.
7. Use only the power source marked on the product. If you are not sure of the type of power supplied to your home, consult your dealer or local power company.
8. Do not place objects on the power cord. Install the product where no one can step or trip on the cord.
9. Do not overload power outlets and extension cords. This can result in the risk of fire or electric shock.
10. Never push any objects through slots in the product. This may result in the

risk of fire or electric shock. Never spill any liquid on the product.

11. To reduce the risk of electric shock, do not disassemble the product. Take the product to an authorized service center when service is required. Opening or removing covers may expose you to dangerous voltages or other risks. Incorrect reassembly can cause electric shock when the product is subsequently used.
12. Unplug the product from power outlets and take to an authorized service center when the following conditions occur:
 - A. When the power cord is damaged or frayed.
 - B. If liquid has been spilled into the product.
 - C. If the product has been exposed to rain or water.
 - D. If the product does not work normally by following the operating instructions. Adjust only controls covered by the operating instructions. Improper adjustment may require extensive work by an authorized service center.
 - E. If the product has been dropped or physically damaged.
 - F. If the product exhibits a distinct change in performance.
13. During thunderstorms, avoid using telephones except cordless types. There may be a remote risk of an electric shock from lightning.
14. Do not use the product to report a gas leak, when in the vicinity of the leak.

SAVE THESE INSTRUCTIONS

CAUTION:

Installation

- Never install telephone wiring during a lightning storm.
- Never install telephone jacks in wet locations unless the jack is specifically designed for wet locations.
- Never touch uninsulated telephone wires or terminals unless the telephone line has been disconnected at the network interface.
- Use caution when installing or modifying telephone lines.
- Do not touch the plug with wet hands.
- The AC adaptor is used as the main disconnect device. Ensure that the AC outlet is installed near the product and is easily accessible.
- To prevent electric shock, use only the included audio cable with the transformer when connecting the unit to an audio device.

Battery

To reduce the risk of fire or injury to persons, read and follow these instructions.

- Use only the battery(ies) specified.
- Do not dispose of the battery(ies) in a fire. They may explode. Check with local waste management codes for special disposal instructions.
- Do not open or mutilate the battery(ies). Released electrolyte is corrosive and may cause burns or injury to the eyes or skin. The electrolyte may be toxic if swallowed.
- Exercise care when handling the battery(ies). Do not allow conductive materials such as rings, bracelets or

keys to touch the battery(ies), otherwise a short circuit may cause the battery(ies) and/or the conductive material to overheat and cause burns.

- Charge the battery(ies) provided, or identified for use with the product only, in accordance with the instructions and limitations specified in this manual.

WARNING:

- To prevent the risk of fire or electrical shock, do not expose the product to rain or any type of moisture.
- Unplug the product from power outlets if it emits smoke, an abnormal smell, or makes an unusual noise. These conditions can cause fire or electric shock. Confirm that smoke has stopped emitting and contact the Panasonic Call Center at 1-800-211-PANA (1-800-211-7262).
- Do not spill liquids (detergents, cleansers, etc.) onto the telephone line cord plug, or allow it to become wet at all. This may cause a fire. If the telephone line cord plug becomes wet, immediately pull it from the telephone wall jack, and do not use.
- Do not place or use this product near automatically controlled devices such as automatic doors and fire alarms. Radio waves emitted from this product may cause such devices to malfunction resulting in an accident.
- Completely insert the AC adaptor/power plug into the power outlet. Failure to do so may cause electric shock and/or excessive heat resulting in a fire.
- Regularly remove any dust, etc. from the AC adaptor/power plug by pulling it from

Introduction

the power outlet, then wiping with a dry cloth. Accumulated dust may cause an insulation defect from moisture, etc. resulting in a fire.

Medical

- Consult the manufacturer of any personal medical devices, such as pacemakers or hearing aids, to determine if they are adequately shielded from external RF (radio frequency) energy. (The product operates in the frequency range of 5.76 GHz to 5.84 GHz, and the power output is 200 mW (max.)) Do not use the product in health care facilities if any regulations posted in the area instruct you not to do so. Hospitals or health care facilities may be using equipment that could be sensitive to external RF energy.

For best performance

Base unit location/avoiding noise

The base unit and other compatible Panasonic units use radio waves to communicate with each other.

For maximum distance and noise-free operation, we recommend the following:

- Placing the product away from electrical appliances.
- Placing the base unit in a HIGH and CENTRAL location with no obstructions such as walls.
- Raising the antennas vertically.
- If you use the handset near a microwave oven which is being used, noise may be heard. Move away from the microwave oven and closer to the base unit.

- If you use the handset near another cordless phone's base unit, noise may be heard. Move away from the other cordless phone's base unit and closer to your base unit.

Environment

- Keep the product away from electrical noise generating devices, such as fluorescent lamps and motors.
- The product should be kept free from excessive smoke, dust, high temperature, and vibration.
- The product should not be exposed to direct sunlight.
- Do not place heavy objects on top of the product.
- When you leave the product unused for a long period of time, unplug the product from the power outlet.
- The product should be kept away from heat sources such as heaters, kitchen stoves, etc. It should not be placed in rooms where the temperature is less than 5 °C (41 °F) or greater than 40 °C (104 °F). Damp basements should also be avoided.
- The maximum calling distance may be shortened when the product is used in the following places: Near obstacles such as hills, tunnels, underground, near metal objects such as wire fences, etc.
- Operating the product near electrical appliances may cause interference. Move away from the electrical appliances.

Routine care

- Wipe the outer surface of the product with a soft moist cloth. Do not use benzene, thinner, or any abrasive powder.

Setting up the base unit

Connecting the AC adaptor and telephone line cord

Connect the telephone line cord until it clicks into the base unit (❶) and telephone line jack (❷). Connect the AC adaptor cord by pressing the plug firmly (❸).

- Use only the included Panasonic AC adaptor PQLV207.

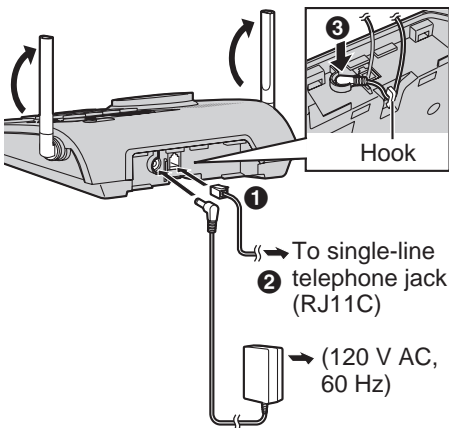

Note:

- The AC adaptor must remain connected at all times. (It is normal for the adaptor to feel warm during use.)
- The AC adaptor should be connected to a vertically oriented or floor-mounted AC outlet. Do not connect the AC adaptor to a ceiling-mounted AC outlet, as the weight of the adaptor may cause it to become disconnected.
- The unit will not work during a power failure. We recommend connecting a corded telephone to the same telephone

line or to the same telephone jack using a Panasonic T-adaptor (page 11).

If you subscribe to a DSL service

Please attach a noise filter (contact your DSL provider) to the telephone line between the base unit and the telephone line jack in the event of the following:

- Noise is heard during conversations.
- Caller ID features (page 37) do not function properly.

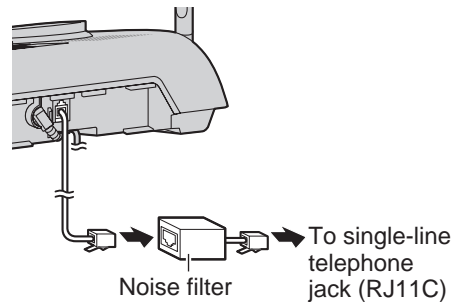

Please call 1-800-8-BATTERY (1-800-822-8837) for information on how to recycle this battery.

Battery charge

Place the handset on the base unit or charger for **7 hours** before initial use.

While charging, the charge indicator on the handset lights in amber. When the battery is fully charged, the indicator lights in green.

Base unit

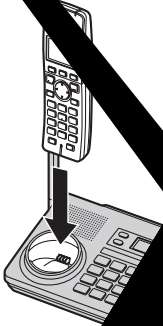

- Model shown

Charger (KY)

Note:

- If you want to use the handset immediately, charge it for at least 1 hour.
- To ensure proper operation, the handset should be fully charged before use.

Preparation

Panasonic battery performance

Operation	Operating time
While in use (talking)	Up to 5 hours
While not in use (standby)	Up to 7 days
While using the clarity booster feature (page 29)	Up to 3 hours

Note:

- Battery operating time may be shortened over time depending on usage conditions and surrounding temperature.
- Battery power is consumed whenever the handset is off the base unit or charger, even when the handset is not in use. Hence the longer you leave the handset off the base unit or charger, the less time you may actually talk using the handset.
- After the handset is fully charged, displaying “Charge completed”, it may be left on the base unit or charger without any ill effect on the battery.
- The battery level may not be displayed correctly after you replace the battery. In this case, place the handset on the base unit or charger and let charge for 7 hours.

Wall mounting for charger (KX-TG5777 only)

- 1 Drive the screws (not included) into the wall using the wall mount template as a guide.
- 2 Mount the charger (❶), then slide it down (❷) and to the right (❸) until it is secure.

Controls

Base unit



- | | |
|-------------------------------------|---|
| 1 [ERASE] | 13 [PAUSE] [REDIAL] |
| 2 [MEMO] | 14 [FLASH] [CALL WAIT] |
| 3 Display | 15 [MUTE] |
| 4 [GREETING CHECK] | 16 [SP-PHONE] (Speakerphone)
SP-PHONE indicator |
| 5 [GREETING REC] (Recording) | 17 MIC (Microphone) |
| 6 [STOP] | 18 Navigator key ([▲] [▼] [◀◀] [▶▶]) |
| 7 [ANSWER ON] | 19 [AUTO] [PROGRAM] |
| 8 [MESSAGE] | 20 [CONF] (Conference) |
| 9 Antenna | 21 [HOLD] |
| 10 Speaker | 22 IN USE indicator |
| 11 Charge contacts | 23 [TRANSFER] [INTERCOM] |
| 12 [*] (TONE) | |

Preparation

Monochrome display model: KX-TGA570 (included with KX-TG5771)

Handset

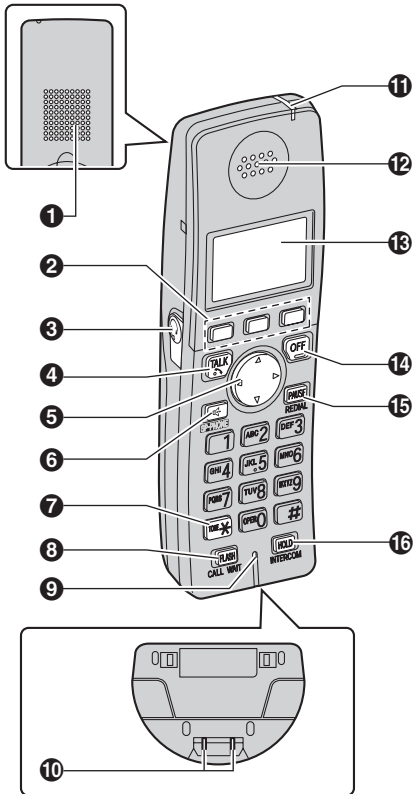

- ❶ Speaker
- ❷ Soft keys
- ❸ Headset jack/Audio jack
- ❹ [↶] (TALK)
- ❺ Navigator key ([▲] [▼] [◀] [▶])
- ❻ [☎] (SP-PHONE)
- ❼ [*] (TONE)
- ❽ [FLASH] [CALL WAIT]
- ❾ Microphone
- ❿ Charge contacts
- ⓫ Charge indicator
Ringer indicator
Message indicator
- ⓬ Receiver
- ⓭ Display
- ⓮ [OFF]
- ⓯ [PAUSE] [REDIAL]
- ⓰ [HOLD] [INTERCOM]

Color display model:
KX-TGA571 (included with
KX-TG5776/KX-TG5777/KX-
TG5779)

Handset

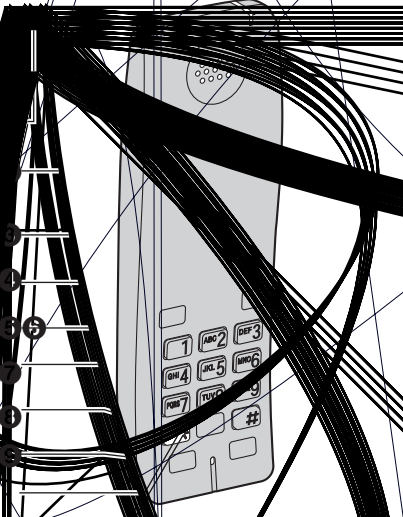
- 
- 1** Speaker
 - 2** Soft keys
 - 3** Headset jack/Audio jack
 - 4** [↶] (TALK)
 - 5** Joystick
 - [▲] [▼]: Push the joystick up or down.
 - [←] [→]: Push the joystick left or right.
 - **Middle soft key**: Push the center of joystick.
 - 6** [☎] (SP. PHONE)
 - 7** [✳] (TONE)
 - 8** [FLASH] [CALL WAIT]
 - 9** Microphone
 - 10** Charge indicator
Ringer indicator
Message indicator
 - 11** Redial
 - 12** Display
 - 13** [OFF]
 - 14** [PAUSE] [REDIAL]
 - 15** [HOLD] [INTERCOM]
 - 16** USB port
 - 17** Charge contacts

Base

Display item	
FULL	m
RINGER OFF	Bas
<i>E</i>	Greeting message
<i>g</i>	Answering greeting only (messages cannot be recorded).
Example: <i>H 1</i>	Handset number: 0 when paging, or being paged (example shown here: handset 1).
<i>H</i>	Paging all handsets
<i>P</i>	Base unit is in programming mode.

E



g
(displayed in the top center)

*1 Monochrome
KX-TG5771/KX-

*2 Color display model
KX-TG5776/KX-TG
KX-TGA571













Handset menu icons

When in standby mode, pressing **[MENU]** (middle soft key) on the handset reveals the main menu. From here you can access various features and settings.

Note:













- The menu icons shown in these operating instructions vary slightly from the actual icons shown on the display.

Monochrome display models: KX-TG5771/KX-TGA570

Menu icon		Menu/feature
		Answering device
		Ringer setting
		Phonebook
		Set date & time
		Initial setting
		Customer support

- Each menu icon on the left changes to the one on the right when selected.

Color display models: KX-TG5776/KX-TG5777/KX-TG5779/KX-TGA571

Menu icon		Menu/feature
		Answering device
		Ringer setting
		Display setting
		Set date & time
		Initial setting
		Customer support

- Each menu icon on the left changes to the one on the right when selected.

Handset screen saver (Color display models only)

Important:



- Only KX-TG5776, KX-TG5777, KX-TG5779, and KX-TGA571 support this feature.

After 1 minute of inactivity, the handset enters screen saver mode if the handset is not on the base unit or charger. The display is turned off in order to preserve the life of the battery.

To cancel screen saver mode

To use the handset when it is in screen saver mode, first press **[OFF]** to turn the display on again.

Symbols used in these operating instructions

Symbol	Meaning
<p>[]: button name/soft key name</p> <p>Example: Unit keys: [], [OFF] Soft keys: [CID], []</p>	<p>The words in the brackets indicate button names/soft key names on the handset and base unit.</p>
→	Proceed to the next operation.
<p>Example: “Ringer ID”</p>	<p>The words in quotations indicate the menu on the display.</p>
<p>Example:</p> <p>1 [MENU] (middle soft key) → [≡][1][2][0]</p> <p>2 Select the desired setting.</p> <p>3 [SAVE] → [OFF]</p>	<p>1 Press [MENU] (middle soft key), then press [≡], [1], [2], [0].</p> <p>2 Press [▲] or [▼] to select the desired setting.</p> <p>3 Press [SAVE], then press [OFF].</p>
<p>Handset: [▲] [▼]</p>	<p>Monochrome display models (KX-TG5771/KX-TGA570): Press up or down on the handset navigator key.</p> <p>Color display models (KX-TG5776/KX-TG5777/KX-TG5779/KX-TGA571): Push the joystick up or down.</p>
<p>Handset: [◀] [▶]</p>	<p>Monochrome display models (KX-TG5771/KX-TGA570): Press left or right on the handset navigator key.</p> <p>Color display models (KX-TG5776/KX-TG5777/KX-TG5779/KX-TGA571): Push the joystick left or right.</p>
<p>Base unit: [▲] [▼] [◀◀] [▶▶]</p>	<p>Press up, down, left, or right on the base unit navigator key.</p>

Setting the unit before use

Important:

- To program features by scrolling through the display menus, see page 41.

Display language

The default setting is "English".

Handset

- 1 **[MENU]** (middle soft key) →
[#][1][1]
- 2 Select the desired setting.
- 3 Press the middle soft key to
[OFF]

Dialing mode

If you cannot make calls, check the dialing mode setting according to your service. The default is "Tone":
"Tone": For tone dialing
"Pulse": For rotary dialing

Handset

- 1 **[MENU]** (middle soft key) →
[#][1][1]

- 2 Select the desired setting.

Date and time

Set the correct date and time for the play back function. The system menu is displayed every day and

Handset

1

Making calls

Using the handset

- 1 Lift the handset and dial the phone number.
 - To correct a digit, press **[CLEAR]**.
- 2 Press **[↶]** or **[CALL]**.
- 3 When you finish talking, press **[OFF]** or place the handset on the base unit or charger.

Note:

- The IN USE indicator on the base unit lights when someone is talking on the handset or another phone.

Using the speakerphone

- 1 Lift the handset, dial the phone number, and press **[☎]**.
 - Speak alternately with the other party.

- 2 When you finish talking, press **[OFF]**.

Note:

- Use the speakerphone in a quiet environment.
- To switch to the receiver, press **[↶]**.

Adjusting the receiver/speaker volume

Press **[▲]** or **[▼]** repeatedly while talking.

Making a call using the redial list

The last 10 phone numbers dialed are stored in the redial list.

- 1 **[REDIAL]**

- 2 Press **[▲]** or **[▼]** to select the desired number.

- 3 **[↶]**

Note:

- The caller's name is not stored in the redial list when calling back from the caller list.

Erasing a number in the redial list

- 1 **[REDIAL]**

- 2 Press **[▲]** or **[▼]** to select the desired number. → **[ERASE]**

- 3 "Yes" → **[SELECT]** → **[OFF]**

PAUSE button (for PBX/long distance service users)

A pause is sometimes required when making calls using a PBX or long distance service. When storing a calling card access number and/or PIN in the phonebook, a pause is also needed (page 35).

For example, if you need to dial the line access number "9" when making outside calls with a PBX:

- 1 **[9]** → **[PAUSE]** → Dial the phone number.

- 2 **[↶]**

Use

- 1 [SP-PHONE]
- 2 Speak into the handset.
- 3 When you finish talking, press [END CALL] or [PHONE].

Adjusting the ringer volume

Press [▲] or [▼] repeatedly to select the desired volume when in standby mode.

- To turn the ringer off, press and hold [▼] until the unit beeps.
- To stop ringing, press [STOP].

Setting the ringer tone

There are 3 tones and 3 melodies.

- 1 Press [▲] or [▼].
- 2 Within 10 seconds, press [◀◀] or [▶▶] repeatedly to select the desired tone.
 - To stop ringing, press [STOP].

Note:

- If you subscribe to a distinctive ring service (such as IDENT-A-RING), select a tone (tone 1 to 3) for the base unit's ringer tone. If you select a melody, you cannot distinguish lines by their ringers.
- If you select a melody for the base unit's ringer tone, the ringer continues to sound for several seconds if:
 - the caller hangs up before you answer the call.
 - another person answers the call using another phone connected to the same line.

- 2 Press [END CALL] or [PHONE].
 - To release the hold, press [SP-PHONE].
 - The base unit can take the call by pressing [END CALL] or [PHONE].
 - Another handset can take the call by pressing [END CALL] or [PHONE].

Base unit

Press [HOLD] during an outside call.

- To release the hold, press [SP-PHONE].
- Handset users can take the call by pressing [END CALL].

Note for handset and base unit:

- While an outside call is on hold, the IN USE indicator on the base unit flashes.
- If another phone is connected to the same line (page 15), you can also take the call by lifting its handset.
- If a call is kept on hold for more than 9 minutes, an alarm tone starts to sound. After 1 additional minute on hold, the call is disconnected.

Mute

While mute is turned on, you can hear the other party, but the other party cannot hear you.

Handset

To mute your voice, press **[MUTE]**.

- To return to the conversation, press **[MUTE]** or **[↶]**.

Note:

- **[MUTE]** is a soft key visible on the handset display during a call.

Base unit

To mute your voice, press **[MUTE]**.

- To return to the conversation, press **[MUTE]** or **[SP-PHONE]**.

FLASH button

Pressing **[FLASH]** allows you to use special features of your host PBX such as transferring an extension call, or accessing optional telephone services such as Call Waiting.

Note:

- To change the flash time, see page 47.

For Call Waiting service users

To use Call Waiting, you must subscribe to Call Waiting service of your telephone service provider.

This feature allows you to receive calls while you are already talking on the phone. If you receive a call while on the phone, you will hear a Call Waiting tone. Please contact your telephone service provider for details and availability of this service in your area.

Press **[CALL WAIT]** to answer the 2nd call after the tone.

- To switch between calls, press **[CALL WAIT]**.

Temporary tone dialing (for rotary/pulse service users)

You can temporarily switch the dialing mode to tone when you need to access touch tone services (for example, answering services, telephone banking services, etc.).

Press **[*]** (TONE) before entering access numbers which require tone dialing.

Handset clarity booster

This feature can improve sound clarity when the handset is used in an area where there may be interference. During an outside call, this feature is turned on automatically when necessary. You can also turn this feature on or off manually.

- 1 Press **[MENU]** during an outside call.
- 2 Press **[2]** to select "Booster on" or "Booster off".

Note:

- When this feature is turned off manually during a call, it does not turn on automatically during the same call.
- While this feature is turned on;
 - the battery operating time is shortened (page 18).
 - the maximum number of extensions that can be used at a time may decrease.

Making/Answering Calls

Handset voice enhancer

This feature clarifies the voice of the person you are talking to, reproducing a more natural-sounding voice that is easier to hear and understand.

- 1 Press **[MENU]** during an outside call.
- 2 Press **[3]** to select “**Voice enhancer**” or “**V.E. off**”.
 - When this feature is turned on, **VE** is displayed.

Note:

- Depending on the condition and quality of your telephone line, this feature may emphasize existing line noise. If it becomes difficult to hear, turn this feature off.

Call share

This feature allows the handset and base unit to join an existing outside call.

Handset

To join the conversation, press **[↶]** when the other extension is on an outside call.

Base unit

To join the conversation, press **[SP-PHONE]** when the handset is on an outside call.

Note for handset and base unit:

- A maximum of 4 parties (including 1 outside party) can join a conversation using 3 extensions.

Call privacy

Call privacy allows you to prevent other users from joining your conversations with outside callers. To allow other users to join your conversations, leave this feature off.

Handset

- 1 Press **[MENU]** during an outside call.
- 2 Press **[1]** to select “**Privacy on**” or “**Privacy off**”.
 - When this feature is turned on, “**PRIV.**” is displayed.

Note:

- This feature will turn off after you hang up the call.

Handset phonebook

You can add up to 50 items to the handset phonebook and search for phonebook items by name.

Important:

- Caller ID subscribers can use ringer ID and light-up ID features (page 38).
- Color display models only (KX-TG5776/KX-TG5777/KX-TG5779/KX-TGA571):
 - Caller ID subscribers can use picture ID feature (page 38).
 - You can also create and edit phonebook items using your computer and send them to the handset. Refer to the help section of the GIGARANGE USB Utility application for more information.

Adding items to the handset phonebook

Monochrome display models:

KX-TG5771/KX-TGA570

- 1  (right soft key)
- 2 **[ADD]**
- 3 Enter the name (max. 16 characters; page 33). → **[OK]**
- 4 Enter the phone number (max. 32 digits). → **[OK]**
 - If you do not need to assign the ringer ID and light-up ID, go to step 11.
- 5 “Set Ringer ID” → **[SELECT]**
- 6 Select the desired item.

No Ringer ID	Turns the ringer ID off. Press [SELECT] , then go to step 9.
Tone & Melody	Tone and melodies stored in the handset at the time of purchase.
Custom ring	Melodies you stored in the handset (page 49). 2 melodies are already stored at the time of purchase (page 49).

7 **[SELECT]**

- 8 Select the desired ringer ID (page 38). → **[OK]**

9 “Set Light-up ID” → **[SELECT]**

- 10 Select the desired light-up ID (page 38). → **[OK]**

11 **[SAVE]**

- To add other items, repeat from step 3.

12 **[OFF]**

Note:

- In step 2, you can also press **[MENU]** → “New entry” → **[SELECT]** instead of pressing **[ADD]**.
- To assign a melody in “Custom ring” as ringer ID, you can record it from an audio device (page 49).
- If you select “No Ringer ID” (default), the handset uses the ringer tone you selected on page 47 when a call is received from that caller.

Phonebook

- If you select “No Light-up ID” (default), the handset uses the ringer indicator color you selected on page 47 when a call is received from that caller.

Color display models:

KX-TG5776/KX-TG5777/KX-TG5779/KX-TGA571

1 [📖] (right soft key)

2 [ADD]

3 Enter the name (max. 16 characters; page 33). → [OK]

4 Enter the phone number (max. 32 digits). → [OK]

- If you do not need to assign the ringer ID, light-up ID, and picture ID, go to step 15.

5 “Set Ringer ID” → [SELECT]

6 Select the desired item.

No Ringer ID	Turns the ringer ID off. Press [SELECT], then go to step 9.
Tone & Melody	Tone and melodies stored in the handset at the time of purchase.
Custom ring	Melodies you stored in the handset (page 49). 2 melodies are already stored at the time of purchase (page 49).

7 [SELECT]

8 Select the desired ringer ID (page 38). → [OK]

9 “Set Light-up ID” → [SELECT]

10 Select the desired light-up ID (page 38). → [OK]

11 “Set Picture ID” → [SELECT]

12 Select the desired item.

No Picture ID	Turns the picture ID off. Press [SELECT], then go to step 15.
Sample pictures	Images stored in the handset at the time of purchase.
My pictures	Images you stored in the handset.

13 [SELECT]

14 Select the desired picture ID (page 38). → [OK]

15 [SAVE]

- To add other items, repeat from step 3.

16 [OFF]

Note:

- In step 2, you can also press [MENU] → “New entry” → [SELECT] instead of pressing [ADD].
- To assign a melody in “Custom ring” as ringer ID, you can record it from an audio device (page 49) or copy it from your computer (refer to the help section of the GIGARANGE USB Utility application).
- If you select “No Ringer ID” (default), the handset uses the ringer tone you selected on page 47 when a call is received from that caller.

- If you select “No Light-upID” (default), the handset uses the ringer indicator color you selected on page 47 when a call is received from that caller.
- To assign an image in “My pictures” as picture ID, you can copy it from your computer (refer to the help section of the GIGARANGE USB Utility application).

Character table for entering names

Key	Character
[1]	# & ' () * , - . / 1
[2]	a b c A B C 2
[3]	d e f D E F 3
[4]	g h i G H I 4
[5]	j k l J K L 5
[6]	m n o M N O 6
[7]	p q r s P Q R S 7
[8]	t u v T U V 8
[9]	w x y z W X Y Z 9
[0]	Space 0
[#]	#

Note:

- To enter another character that is located on the same dial key, first press [▶] to move the cursor to the next space.

Editing/correcting a mistake

Press [◀] or [▶] to move the cursor to the character or number you want to erase, then press [CLEAR]. Enter the appropriate character or number.

Note:

- Press and hold [CLEAR] to erase all characters or numbers.

Finding and calling a handset phonebook item

Phonebook items can be searched for alphabetically by scrolling through the phonebook items or by initial.

Searching for a name alphabetically by scrolling through all items

- 1 [📖] (right soft key) → [SEARCH]
- 2 Press [▲] or [▼] to select the desired item.
- 3 Press [↶] or [CALL] to dial the phone number.

Searching for a name by initial

- 1 [📖] (right soft key) → [SEARCH]
- 2 Press the dial key ([0] – [9], or [#]) that corresponds to the first letter you are searching for (see the character table on the left).

Example: “LISA”

Press [5] repeatedly to display the first phonebook entry starting with the initial “L” and go to step 3.

- If there is no item corresponding to the letter you selected, the next item is displayed.
- 3 Press [▼] to select the desired item.
 - 4 Press [↶] or [CALL] to dial the phone number.

Editing items in the handset phonebook

- 1 **[]** (right soft key) → **[SEARCH]**
- 2 Find the desired item (page 33). → **[EDIT]**
- 3 Select the information you want to edit.

To change the name or phone number	Select the name or phone number. → [SELECT] → Edit the information (page 33). → [OK]
To change the ringer ID	Select the current ringer ID. → [SELECT] → Select the desired item.*1 → [SELECT] → Select the desired ringer ID. → [OK] *1 To turn the ringer ID off, select "No Ringer ID". → [SELECT]
To change the light-up ID	Select the current light-up ID. → [SELECT] → Select the desired light-up ID.*2 → [OK] *2 To turn the light-up ID off, select "No Light-upID".

To change the picture ID (Colordisplay models only: KX-TG5776/ KX-TG5777/ KX-TG5779/ KX-TGA571)	Select the current picture ID. → [SELECT] → Select the desired item.*3 → [SELECT] → Select the desired picture ID. → [OK] *3 To turn the picture ID off, select "No Picture ID". → [SELECT]
---	--

- 4 **[SAVE]** → **[OFF]**

Erasing an item in the handset phonebook

- 1 **[]** (right soft key) → **[SEARCH]**
- 2 Find the desired item (page 33).
- 3 **[MENU]** → "Erase" → **[SELECT]**
- 4 "Yes" → **[SELECT]** → **[OFF]**

Chain dial

This feature allows you to dial phone numbers in the handset phonebook while you are on a call. This feature can be used, for example, to dial a calling card access number or bank account PIN that you have stored in the handset phonebook, without having to dial manually.

- 1 During an outside call, press **[📖]**.
- 2 Find the desired item (page 33). → **[CALL]**

Note:

- When storing a calling card access number and your PIN in the phonebook as one phonebook item, press **[PAUSE]** to add pauses after the number and PIN as necessary (page 26).
- If you have rotary or pulse service, you need to press **[*]** before pressing **[📖]** in step 1 to change the dialing mode temporarily to tone.

Copying handset phonebook items

You can copy one or all of the phonebook items from the handset to the phonebook of a compatible Panasonic handset (KX-TGA570/KX-TGA571/KX-TGA572).

Important:

- Ringer ID and light-up ID for phonebook items are not copied.
- Color display models only (KX-TG5776/KX-TG5777/KX-TG5779/KX-TGA571): Picture ID for phonebook items is not copied.

Copying an item

- 1 **[📖]** (right soft key) → **[SEARCH]**
- 2 Find the desired item (page 33). → **[MENU]**
- 3 “Copy” → **[SELECT]**
- 4 Select the handset to copy to. → **[SEND]**
 - To continue copying another item: “Yes” → **[SELECT]** → Find the desired handset phonebook item. → **[SEND]**
- 5 Press **[OFF]** after the long beep.

Copying all items

- 1 **[📖]** (right soft key)
- 2 **[MENU]**
- 3 “Copy all items” → **[SELECT]**
- 4 Select the handset to copy to. → **[SEND]**
- 5 Press **[OFF]** after the long beep.

Base unit speed dialer

You can assign one phone number to each of the 10 dial keys ([0] – [9]) on the base unit.

Adding phone numbers to the speed dialer

Important:

- Before adding phone numbers, make sure the base unit is not being used.

1 [PROGRAM]

2 Enter the phone number (max. 32 digits).

- If a pause is required for dialing, press [PAUSE] where needed.
- If you misdial, press [STOP] and repeat from step 1.

3 [PROGRAM]

4 Press a dial key ([0] – [9]).

Note:

- If a phone number is assigned to a dial key which already contains a phone number, the old number will be erased.
- We recommend you make a note of which phone numbers are stored in which dial keys.

PAUSE button (for PBX/long distance service users)

A pause is sometimes required when making calls using a PBX or long distance service.

For example, if you need to dial the line access number “9” when making outside calls with a PBX:

In step 2, press [9], [PAUSE], then enter the phone number.

Note:

- A 3.5 second pause is inserted each time [PAUSE] is pressed. Press repeatedly to insert longer pauses. “P” is displayed when [PAUSE] is pressed.
- When [✖] is pressed, “L” is displayed. When [≡] is pressed, “≡” is displayed.

To erase a stored phone number

1 Press [PROGRAM] 2 times.

2 Press the desired dial key ([0] – [9]).

Calling someone with the speed dialer

1 [SP-PHONE] → [AUTO]

2 Press the desired dial key ([0] – [9]).

Note:

- Speed dial numbers assigned to the base unit dial keys can only be dialed from the base unit.

Using Caller ID service

This unit is Caller ID compatible. To use Caller ID features, you must subscribe to Caller ID service of your telephone service provider.

Caller ID features

When an outside call is being received, the calling party's name and telephone number are displayed.

Caller information for the last 50 callers is logged in the caller list by the most recent call to the oldest.

- Generally caller information is displayed from the 2nd ring.
- If the unit cannot receive caller information, the following is displayed:
 - “**Out of area**”: The caller dialed from an area which does not provide Caller ID service.
 - “**Private caller**”: The caller requested not to send caller information.
 - “**Long distance**”: The caller called you long distance.
- If the unit is connected to a PBX system, caller information may not be received properly. Consult your PBX supplier.

Missed calls

If a call is not answered, the unit treats the call as a missed call. “**Missed call**” is displayed on the handset display. This lets you know if you should view the caller list to see who called while you were out. You can view the number of missed calls by pressing [**CID**] (left soft key).

Note:

- If you press [**CID**], then press [**OFF**] without viewing all missed calls in the caller list, “**Missed call**” disappears from the display. When you receive another new call, it is displayed again.

Call Waiting Caller ID display

If you subscribe to both Caller ID and Call Waiting with Caller ID services, the 2nd caller's information is displayed after you hear a Call Waiting tone (page 29). Please contact your telephone service provider for details and availability of this service in your area.

Talking Caller ID

This feature lets you know who is calling without looking at the display. When a call comes in, the handset and base unit announce the caller's name displayed on the handset following every ring.

To use this feature, you must subscribe to Caller ID service of your telephone service provider.

- Name pronunciation may vary. This feature may not pronounce all names correctly.
- Caller ID supports names of up to 15 letters. If the caller's name has more than 15 letters, the name is not displayed or announced correctly.
- Usually the unit announces the caller's name after the 2nd ring. If you turn on the answering system and set the ring count to “**2 rings**” (page 59), the unit does not announce the caller's name. If “**Toll saver**” is selected and there is a new message, the unit does not announce the caller's name.

Caller ID Service

- When you receive a call while on the phone, the 2nd caller's name is not announced even if you subscribe to both Caller ID and Call Waiting with Caller ID services.
- The announcement is heard at the same level as the ringer volume (page 28, 47).
- This feature can be turned on or off (page 47).

Picture ID (only)

Important

- Only

TO

f

Ringer ID

This feature can help you identify who is calling by using different ringers for different callers stored in the phonebook (page 31). You can assign a different ringer to each phonebook item. When a call is received from a caller stored in the phonebook, the assigned ringer and Caller ID information is displayed.

Light-up ID

This feature can help you identify who is calling by using different light-up colors for different callers stored in the handset phonebook. You can assign a different light-up color to each handset phonebook item. When a call is received from a caller stored in the handset phonebook, the light-up indicator color and Caller ID information is displayed.

Caller list

Important:

- Only 1 person can access the caller list at a time.

Viewing the caller list and calling back

1 [CID] (left soft key)

2 Press [▼] to search from the most recent call, or [▲] to search from the oldest call.

3 [↶]

Note:

- A ✓ is displayed in caller information which has already been viewed or answered by any handset.

Editing a caller's phone number before calling back

You can edit a phone number in the caller list by removing its area code and/or the long distance code "1".

1 [CID] (left soft key)

2 Select the desired item.

3 Press [EDIT] repeatedly until the phone number is shown in the desired format.

① Local phone number

Example:

② Area code – Local phone number

Example:

③ 1 – Area code – Local phone number

Example:

4 [↶]

Caller ID number auto edit feature

Once you call back an edited number, the unit will remember the Area Code and Format of the Edited Number. Next time when someone calls from the same Area Code, caller information will be customized by the unit as follows:

- When the call is being received, the Caller ID number will be displayed in the same Format as the Edited Number.
- After the call is ended, the telephone number of the caller, when reviewed from the Caller list, will be displayed in the same Format as the Edited Number.

For example, you can use this feature to set the unit to ignore the area code of callers in your area code, so that you can call these local numbers using caller information without dialing the area code. To activate this feature, you must edit an item in the caller list, then call that number. After that, phone numbers from that caller's area code are edited automatically. This feature can be turned on or off (page 46).

Note:

- Phone numbers from the 4 most recently edited area codes are automatically edited.
- If you move to another area, you can turn this feature off to erase previously edited area codes. To use this feature

again, turn it on and reprogram the area codes you want to edit once again.

Storing caller information into the handset phonebook

- 1 [CID]** (left soft key)
- 2** Select the desired item.
 - To edit the number, press **[EDIT]** repeatedly until the phone number is shown in the desired format.
- 3 [SAVE]**
- 4** Continue from step 3, “Editing items in the handset phonebook”, page 34.

Erasing selected caller information

- 1 [CID]** (left soft key)
- 2** Select the desired item.
- 3 [ERASE]** → “Yes” → **[SELECT]** → **[OFF]**

Erasing all caller information

- 1 [CID]** (left soft key)
- 2 [ERASE]** → “Yes” → **[SELECT]**

of features using the handset. To

these operating instructions.

one, see page 28.

Through the display menus

to select the desired menu. → **[SELECT]**

as **[▲]** or **[▼]** to select the desired

handset ringer volume setting



[SELECT] to select **♪**. → **[SELECT]**



to select "Ringer volume". →

at the desired setting.

Depending on the feature b

Ring count ^{*1}	
Recording time ^{*1}	
Remote code ^{*1}	
Call screening ^{*1}	61
-	-
Melody	49
	49

Phonebook 	
Set date & time 	Date and time
	Time adjustment





Main menu	Sub-menu 1	Sub-menu 2	Page	
Initial setting 	Auto Intercom	–	64	
	Talking CallerID	–	37	
	Caller ID edit	–	–	
	LCD contrast	–	–	
	Key tone	–	–	
	Auto talk	–	27	
	Set base unit	Talking CallerID ^{*1}		37
		VM tone detect ^{*1}		62
	Set tel line	Set dial mode ^{*1}		25
		Set flash time ^{*1}		–
		Set line mode ^{*1}		–
	Registration	HS registration		67
		Deregistration		67
	Set date & time	Date and time ^{*1}		25
		Time adjustment ^{*1}		–
Change language	–		25	
Handset name	–		51	
Customer support 	–	–	46	

Programming

Color display models: KX-TG5776/KX-TG5777/KX-TG5779/KX-TGA571

● When you find “*1” in the following table, refer to the note below.

*1 If you program these settings using one of the handsets, you do not need to program the same item using another handset.

Main menu	Sub-menu 1	Sub-menu 2	Page	
Answering device 	To play new	–	–	
	To play all	–	–	
	To erase all	–	–	
	Settings	Message alert		61
		Ring count ^{*1}		59
		Recording time ^{*1}		60
		Remote code ^{*1}		59
	Call screening ^{*1}		61	
Ringer setting 	Ringer volume	–	–	
	Ringer tone	Tone & Melody	49	
		Custom ring	49	
	Custom ring	Record	49	
		List	50	
		Memory status	53	
Ring color	–	–		
Display setting 	Wallpaper	Turn off	52	
		Set picture	52	
		Memory status	53	
	Appearance	–	–	
	LCD contrast	–	–	
Set date & time 	Date and time ^{*1}	–	25	
	Time adjustment ^{*1}	–	–	

Programming using the direct commands

1 **[MENU]** (middle soft key) → **[#]**

2 Enter the desired feature code.

3 Enter the desired setting code.

- This step may vary depending on the feature being programmed.

4 **[SAVE]** → **[OFF]**

Note:

- In the following table, < > indicates the default setting.
- If you make a mistake or enter the wrong code, press **[OFF]**, then start again from step 1.

Feature	Feature code	Setting code	System setting ^{*1}	Page
Auto talk ^{*2}	[2][0][0]	[1]: On [0]: <Off>	–	27
Auto Intercom	[2][7][3]	[1]: On (Ringer On) [2]: On (Ringer Off) [0]: <Off>	–	64
Call screening	[3][1][0]	[1]: <On> [0]: Off	●	61
Caller ID edit (Caller ID number auto edit)	[2][1][4]	[1]: <On> [0]: Off	–	39
Change language (Display language)	[1][1][0]	[1]: <English> [2]: Español	–	25
Custom ring (Customized ringer tone for handset)	[1][6][6]	–	–	49
Customer support ^{*3}	[6][8][0]	www.panasonic.com/phonehelp	–	–
Date and time	[1][0][1]	–	●	25
Deregistration	[1][3][1]	–	–	67
Handset name	[1][0][4]	–	–	51
HS registration (Handset registration)	[1][3][0]	–	–	67

Feature	Feature code	Setting code	System setting ^{*1}	Page
Key tone ^{*4}	[1][6][5]	[1]: <On> [0]: Off	–	–
LCD contrast (Display contrast)	[1][4][5]	[1]–[6]: Level 1–6 <3>	–	–
Message alert	[3][4][0]	[1]: On [0]: <Off>	–	61
Recording time	[3][0][5]	[1]: 1 min [2]: 2 min [3]: <3 min> [0]: Greeting only	●	60
Remote code	[3][0][6]	Default: 111	●	59
Ring count	[2][1][1]	[2]–[7]: Rings <4 rings> [0]: Toll saver	●	59
Ring color (Ringer indicator color)	[2][3][5]	[1]: <Color1> [2]: Color2 [3]: Color3 [4]: Multicolor	–	–
Ringer tone (Handset)	[1][6][1]	–	–	49
Ringer volume (Handset)	[1][6][0]	[1]–[6]: Level 1–6 <6> [0]: Off	–	–
Set dial mode	[1][2][0]	[1]: Pulse [2]: <Tone>	●	25
Set flash time ^{*5}	[1][2][1]	[1]: <700 ms> [2]: 600 ms [3]: 400 ms [4]: 300 ms [5]: 250 ms [6]: 110 ms [7]: 100 ms [8]: 90 ms	●	–
Set line mode ^{*6}	[1][2][2]	[1]: A [2]: 	●	–
Talking CallerID (Handset)	[1][6][2]	[1]: <On> [0]: Off	–	37
Talking CallerID (Base unit)	[*][1][6] [2]	[1]: <On> [0]: Off	●	37
Time adjustment ^{*7} (Caller ID subscribers only)	[2][2][6]	[1]: <Caller ID[auto]> [2]: Manual	●	–
To erase all (Erasing all messages)	[3][2][5]	–	–	57

Programming

Feature	Feature code	Setting code	System setting ^{*1}	Page
To play all (All message playback)	[3][2][4]	–	–	56
To play new (New message playback)	[3][2][3]	–	–	56
VM tone detect	[3][3][2]	[1]: <On> [0]: Off	●	62

*1 If “System setting” column is checked, you do not need to program the same item using another handset.

*2 If you subscribe to Caller ID service and want to view the caller’s information after lifting up the handset to answer a call, turn off this feature.

*3 The handset can display the Internet address where you can download operating instructions or get further information for this product using your computer.

*4 Turn this feature off if you prefer not to hear key tones while you are dialing or pressing any keys, including confirmation tones and error tones.

*5 The flash time depends on your telephone exchange or host PBX. Consult your PBX supplier if necessary. The setting should stay at “700 ms” unless pressing **[FLASH]** fails to pick up the call waiting call.

*6 Generally, the line mode setting should not be adjusted. If **IN USE** is not displayed or the IN USE indicator on the base unit does not light properly when another phone connected to the same line is in use, you need to change the line mode to “A”.

*7 This feature allows the unit to automatically adjust the date and time setting when caller information is received. To use this feature, set the date and time first.

Color display models only: KX-TG5776/KX-TG5777/KX-TG5779/KX-TGA571

Feature	Feature code	Setting code	System setting ^{*1}	Page
Appearance (Display color)	[1][8][2]	[1]: <Color1> [2]: Color2 [3]: Color3 [4]: Color4 [5]: Color5	–	–
Memory status	[6][7][0]	–	–	52
Wallpaper	[1][8][1]	–	–	52

*1 If “System setting” column is checked, you do not need to program the same item using another handset.

Customizing handset ringer tone and display

Handset ringer tone (for outside calls)

You can change the ringer tone heard when an outside call is received.

- You can record melodies for the handset ringer tone from an audio device (page 49).
- Color display models only (KX-TG5776/ KX-TG5777/KX-TG5779/KX-TGA571): You can copy melodies (in WAV file format using a computer) to be used for the handset ringer tone. Refer to the help section of the GIGARANGE USB Utility application for more information.

Handset

1 **[MENU]** (middle soft key) → **[#][1][6][1]**

2 Select the desired item. → **[SELECT]**

Tone & Melody	Tones and melodies stored in the handset at the time of purchase.
Custom ring	Melodies you stored in the handset (page 49). 2 melodies are already stored at the time of purchase.

3 Select the desired item. → **[SAVE]** → **[OFF]**

Note:

- If you subscribe to a distinctive ring service (such as IDENTA-RING), select a tone (tone 1 to 3) for the handset ringer tone. If you select a melody, you cannot distinguish lines by their ringers.
- If you select a melody for the handset ringer tone, the ringer continues to sound for several seconds if:
 - the caller hangs up before you answer the call.
 - another person answers the call using another phone connected to the same line.
- The preset song “Demo1” in this product is used with the permission of © 2005 Speed Crazy.
- The preset song “Demo2” in this product is used with the permission of © 2006 Copyrights Vision Inc.

Recording melodies from an audio device for ringer tones using the handset (“Custom ring”)

You can record melodies (max. 30 seconds each) from an audio device by connecting the included audio cable. These melodies can be assigned as the handset ringer tone (page 49, 50) and the ringer ID (page 38) for phone numbers stored in the handset phonebook.

Important:

- If a call is received while a melody is being recorded or played back, recording or playback stops automatically. Disconnect the audio cable from the handset to answer the call.

Programming

- 1 Connect the handset to the audio device (such as a CD player or computer) using the included audio cable.

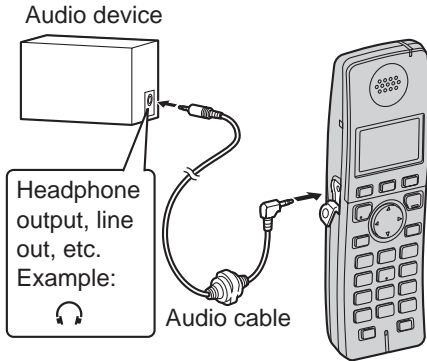

- Handset shown is KX-TGA570.
- 2 **[MENU]** (middle soft key) → **[#][1][6][6]**
 - 3 “Record” → **[SELECT]**
 - 4 Start playing the audio device.
 - 5 Press **[REC.]** to start recording.
 - 6 To stop recording, press **[STOP]**.
 - To listen to the recording, select “Playback”, then press **[SELECT]**.
 - To re-record, select “Retry”, press **[SELECT]**, then start from step 3.
 - 7 “save” → **[SELECT]**
 - 8 Enter the desired name (max. 14 characters; page 33).
 - 9 **[SAVE]** → **[OFF]**
 - 10 Disconnect the audio cable from the handset.

Note:

- Monochrome display models (KX-TG5771/KX-TGA570):
The total recording time is about 90 seconds.
- Color display models (KX-TG5776/KX-TG5777/KX-TG5779/KX-TGA571):
The total recording time is about 7 minutes. The recording time may decrease depending on the size of images and melodies already stored in the handset.

Assigning a customized ring to the handset

Handset

- 1 **[MENU]** (middle soft key) → **[#][1][6][6]**
- 2 “List” → **[SELECT]**
- 3 Select the desired item. → **[MENU]**
- 4 “set ringer tone” → **[SELECT]** → **[OFF]**

Changing the name of a melody

Handset

- 1 **[MENU]** (middle soft key) → **[#][1][6][6]**
- 2 “List” → **[SELECT]**
- 3 Select the desired item. → **[MENU]**
- 4 “Rename” → **[SELECT]**
- 5 Edit the name (max. 14 characters; page 33). → **[SAVE]** → **[OFF]**

Erasing a melody

Handset

- 1** **[MENU]** (middle soft key) → **[#][1][6][6]**
- 2** "List" → **[SELECT]**
- 3** Select the desired item. → **[MENU]**
- 4** "Erase" → **[SELECT]**
- 5** "Yes" → **[SELECT]** → **[OFF]**

Note:

- If the erased melody was used for the handset ringer tone (page 49), "Tone 1" (default) is used instead of that melody.
- If the erased melody was assigned to certain callers as ringer ID (page 38), the ringer ID assignment is canceled, and the handset ringer tone (page 49) is used instead of that song.

Changing the handset name

Each handset can be given a customized name ("Bob", "Kitchen", etc.), this is useful when you make intercom calls between handsets. The default setting is "Handset 1" to "Handset 8".

You can also select whether or not the handset name is displayed in standby mode. The default setting is "OFF".

Handset

- 1** **[MENU]** (middle soft key) → **[#][1][0][4]**
- 2** Enter the desired name (max. 10 characters; page 33).
 - If not required, go to step 3.
- 3** **[OK]**
- 4** Select the desired setting. → **[SAVE]** → **[OFF]**

Handset wallpaper (Color display models only)

You can select the “wallpaper” pattern shown on the handset display in standby mode. There are 3 preset patterns.

Important:

- Only KX-TG5776, KX-TG5777, KX-TG5779, and KX-TGA571 support this feature.
-

Viewing the handset memory status

Handset

- 1 **[MENU]** (middle soft key) → **[#][6][7][0]**
- 2 When finished, press **[OFF]**.

Erasing melodies or images

Handset

- 1 **[MENU]** (middle soft key) → **[#][6][7][0]**
- 2 **[MENU]**
- 3 Select the desired option.

To erase only one melody	"1 Custom ring" → [SELECT] → Select the desired item. → [ERASE]
To erase only one image	"1 picture" → [SELECT] → Select the desired item. → [ERASE]
To erase all melodies	"All Custom ring" → [SELECT]
To erase all images	"All pictures" → [SELECT]

- 4 "Yes" → **[SELECT]**
- 5 When finished, press **[OFF]**.

Note:

- If the erased melody was used for the handset ringer tone (page 49), "Tone 1" (default) is used instead of that melody.
- If the erased melody was assigned to certain callers as ringer ID (page 38), the

- ringer ID assignment is canceled, and the handset ringer tone (page 49) is used instead of that song.
- If the erased image was selected for the wallpaper, the sample picture "Wallpaper1" is used instead of that image.
 - If the erased image was assigned to handset phonebook items, the picture ID assignment is canceled.

Answering system

Important:

- Only 1 person can access the answering system at a time.
- When callers leave messages, the unit records the day and time of each message. Make sure the date and time have been correctly set (page 25).

Memory capacity

The total recording capacity (including caller messages and voice memos) is about 21 minutes.

A maximum of 64 messages can be recorded.

- If the message memory becomes full, the **[MESSAGE]** button on the base unit flashes rapidly. Erase unnecessary messages (page 55).
- If less than 3 minutes of recording time are available, the unit announces the remaining recording time when operating the answering system. Erase unnecessary messages (page 55).

Turning the answering system on/off

Base unit

Press **[ANSWER ON]** to turn on/off the answering system.

- When the answering system is turned on, the **[ANSWER ON]** button lights.
- When the answering system is turned off, the **[ANSWER ON]** button turns off.

Screening calls

While a caller is leaving a message, you can listen to the call through the base unit and handset speakers. To adjust the speaker volume, press **[▲]** or **[▼]** repeatedly.

You can answer the call by pressing **[SP-PHONE]** on the base unit, or by pressing **[↶]** on the handset.

Note:

- To temporarily mute call screening on the handset, press **[SILENCE]**. To raise the volume from mute, press **[▲]** accordingly.
- To turn this feature off, see page 61.

Recording your greeting message

You can record your own greeting message (max. 2 minutes) that is played when the answering system answers a call. If you do not record a greeting message, a prerecorded greeting message is used.

Base unit

1 **[GREETING REC]**

2 Within 10 seconds, press **[GREETING REC]** again.

3 After the base unit beeps, speak clearly about 20 cm (8 inches) away from the MIC.

4 To stop recording, press **[STOP]**.

Playing back the greeting message

Press **[GREETING CHECK]**.

Erasing your greeting message

Press **[GREETING CHECK]**, and then press **[ERASE]** while your greeting message is playing.

Prerecorded greeting message

If you erase or do not record your own greeting message, the unit plays a prerecorded greeting message for callers and asks them to leave messages.

If the message recording time (page 60) is set to "Greeting only", caller messages are not recorded and the unit plays a different prerecorded greeting message asking callers to call again.

Base unit

To play back the prerecorded greeting message, press **[GREETING CHECK]**.

Note:

- If you changed the caller's recording time to "Greeting only" to listen to its prerecorded message, remember to reset your original setting (page 60).

Listening to messages using the base unit

When new messages have been recorded, the **[MESSAGE]** button on the base unit flashes.

Press **[MESSAGE]**.

- The base unit plays new messages.
- When you have no new messages, the base unit plays back all messages.

Adjusting the speaker volume

Press **[▲]** or **[▼]** repeatedly to increase or decrease the volume to a message.

Repeating a message

Press **[◀◀]** during a message.

- If pressed while a message is being played, the message is played again.

Skipping a message

Press **[▶▶]**.

Erasing

Listening to messages using the handset

When new messages have been recorded:

- “New message” is displayed.
- the message indicator on the handset slowly flashes blue if the message alert feature is turned on (page 61).

1 [MENU] (middle soft key) → [PLAY]

- The handset plays new messages including memo messages.
- When you have no new messages, the handset plays back all messages.

2 When finished, press [OFF].

Note:

- You can also listen to the messages as follows:
To play new messages:
[MENU] → [⊕][3][2][3]
To play all messages:
[MENU] → [⊕][3][2][4]
- To switch to the receiver, press [↶].

Adjusting the receiver/speaker volume

Press [▲] or [▼] repeatedly while listening to a message.

Calling back (Caller ID subscribers only)

If Caller ID information was received for the call, you can call the caller back while listening to the message.

- 1 Press [SELECT] during playback.
 - To edit the number before calling back, press [EDIT] repeatedly to select the desired format (page 39).

2 [CALL]

Answering system commands

You can also operate the answering system by pressing dial keys on the handset during playback.

Key	Command
[1] or [◀]	Repeat message (during playback)*1
[2] or [▶]	Skip message (during playback)
[4]	Play new messages
[5]	Play all messages
[8]	Turn answering system on
[9] or [STOP]	Stop playback
[0]	Turn answering system off
[*][4]	Erase currently playing message
[*][5]	Erase all messages

*1 If pressed within the first 5 seconds of a message, the previous message is played.

Erasing a message

1 Press **[ERASE]** during playback.

2 "Yes" → **[SELECT]**

Erasing all messages

1 **[MENU]** (middle soft key) →
[#][3][2][5]

2 "Yes" → **[SELECT]**

Voice memo

Recording a voice memo

You can use the base unit to leave a voice memo (voice message) for yourself or someone else (max. 3 minutes). Voice memos can be played back later with the same operation used to play back answering system messages.

Base unit

1 **[MEMO]**

2 After the unit beeps, speak clearly about 20 cm (8 inches) away from the MIC.

3 To stop recording, press **[STOP]**.

Remote operation

Using a touch tone phone, you can call your phone number from outside and access the unit to listen to messages. The unit's voice guidance prompts you to press certain dial keys to perform different operations.

Important:

- In order to operate the answering system remotely, you must first set a remote code (page 59). This code must be entered each time you operate the answering system remotely.

Using the answering system remotely

- 1 Dial your phone number from a touch tone phone.
- 2 After the greeting message starts, enter your remote code (page 59).
 - The unit plays back new messages.
 - After playing back new messages, the voice guidance starts.
- 3 Follow the voice guidance as necessary.
- 4 When finished, hang up.

Note:

- You can ignore the voice guidance and control the unit using remote commands (page 58).

Voice guidance

During remote operation, the unit's voice guidance prompts you to press **[1]** to perform a specific operation, or press **[2]** to listen to more available operations. Operations are presented by voice guidance in the following order:

- Play back all messages
- Play back new messages
- Record your message
- Erase all messages
- Record your greeting message

Note:

- If you do not press any dial keys within 10 seconds after a voice guidance prompt, the unit disconnects your call.
- If less than 3 minutes of recording time is available, the unit announces the remaining recording time after the last message is played back.

Remote commands

You can press dial keys to access certain answering system functions without waiting for the voice guidance to prompt you.

Key	Remote command
[1]	Repeat message (during playback) ^{*1}
[2]	Skip message (during playback)
[4]	Play new messages
[5]	Play all messages
[7]	Recording a greeting message

Key	Remote command
[9]	Stop recording/ playback*2
[0]	Turn answering system off
[*][4]	Erase currently playing message
[*][5]	Erase all messages

*1 If pressed within the first 5 seconds of a message, the previous message is played.

*2 To resume operation, enter a remote command within 3 seconds, or the voice guidance starts.

Turning on the answering system remotely

If the answering system is off, you can turn it on remotely.

- 1 Dial your phone number.
- 2 Let the phone ring 15 times.
 - The unit answers your call with the greeting message.
 - You can hang up, or if you call from a touch tone phone, you can enter your remote code and begin remote operation (page 58).

Skipping the greeting message to leave a message

You can leave a message just as any outside caller can. Call your phone number. When the answering system picks up, press [*] to skip the greeting message and record your message after the beep.

Answering system settings

Remote code

A remote code must be entered when operating the answering system remotely. This code prevents unauthorized parties from listening to your messages remotely. The default setting is "111".

Handset

1 [MENU] (middle soft key) →
[#][3][0][6]

2 Enter the desired 3-digit remote code.
→ [SAVE] → [OFF]

Ring count

You can change the number of times the phone rings before the unit answers calls. The default setting is "4 rings".

"Toll saver": The unit answers on the 2nd ring when new messages have been recorded, and on the 4th ring when there are no new messages. If you call your phone from outside to listen to new messages (page 58), you will know that there are no new messages when the phone rings for the 3rd time. You can then hang up without being charged for the call.

Handset

1 [MENU] (middle soft key) →
[#][2][1][1]

2 Select the desired setting. → [SAVE]
→ [OFF]

For Voice Mail service subscribers

If you subscribe to a flat-rate service package that includes Caller ID, Call Waiting, Voice Mail, and unlimited local/regional/long distance calls, please note the following:

- To use the Voice Mail service provided by your telephone service provider rather than the unit's answering system, turn off the answering system (page 54).
- To use this unit's answering system rather than the Voice Mail service provided by your telephone service provider, please contact your telephone service provider to deactivate your Voice Mail service.

If your telephone service provider cannot do this:

- Set this unit's "Ring count" setting so that this unit's answering system answers calls before the Voice Mail service of your telephone service provider does. It is necessary to check the ring count required to activate the Voice Mail service provided by your telephone service provider before changing this setting.
- Change the ring count of the Voice Mail service so that the answering system can answer the call first. To do so, consult your telephone service provider.

Caller's recording time

You can change the maximum message recording time allotted to each caller.

The default setting is "3 min".

"Greeting only": The unit plays the greeting message but does not record caller messages.

Handset

1 [MENU] (middle soft key) →
[⇄][3][0][5]

2 Select the desired setting. → [SAVE]
→ [OFF]

Note:

- If the message memory becomes full, the unit automatically switches to the "Greeting only" mode and no new messages are recorded. If you have recorded your own greeting message, that same greeting message is announced to callers even though their messages are not recorded. If you have not recorded your own greeting message, the prerecorded message used for "Greeting only" mode is announced to callers (page 55).
- "Greeting only" cannot be set by scrolling through the display menu (page 41). If you want to select "Greeting only", follow the steps above and press [0] for desired setting in step 2.

Message alert

You can select whether or not the message indicator on the handset slowly flashes blue when new messages are recorded (page 56). The default setting is "Off".

Important:

- If there are new messages in your mailbox service (page 62), the message indicator also slowly flashes blue.

Handset

1 **[MENU]** (middle soft key) →
[#][3][4][0]

2 Select the desired setting. → **[SAVE]**
→ **[OFF]**

Note:

- While message alert feature is on, battery operating time is shortened (page 18).
- If you have new messages and message alert feature is on, the message indicator does not indicate battery charge status (page 17). The indicator slowly flashes blue until you listen to all new messages.

Call screening

This feature allows you to monitor a message from the base unit and handset speakers when the answering system is recording the message. The default setting is "On".

Handset

1 **[MENU]** (middle soft key) →
[#][3][1][0]

2 Select the desired setting. → **[SAVE]**
→ **[OFF]**

Using Voice Mail service

Voice Mail is an automatic answering service offered by your telephone service provider. After you subscribe to this service, the telephone service provider's Voice Mail system will answer calls for you when you are unavailable to answer the phone or when your line is busy. Messages are recorded by the telephone service provider, not your telephone.

Important:

- To use the Voice Mail service provided by your telephone service provider rather than the unit's answering system, turn off the answering system (page 54).

Voice Mail message indication

The unit lets you know that you have new Voice Mail messages in the following ways:

- “**New Voice Mail**” is displayed on the handset.
- The message indicator on the handset slowly flashes blue if the message alert feature is turned on (page 61).

In order to listen to your Voice Mail messages, you must dial your telephone service provider's Voice Mail access number.

Note:

- If the handset still indicates there are new messages even after you have listened to all new messages, turn it off by pressing and holding **[OFF]** on the handset until the handset beeps.
- If your Voice Mail service uses Voice Mail tones and the message is over 3

minutes long, the handset may not indicate new messages.

Voice Mail (VM) tone detection

Your telephone service provider sends special signals (sometimes called “Voice Mail tones” or “stutter tones”) to the unit to let you know you have new Voice Mail messages. If you hear a series of dial tones followed by a continuous dial tone after you press **[↶]** or **[SP-PHONE]**, you have new Voice Mail messages. Minutes after you hang up a call or after the phone stops ringing, your unit will check the phone line to see if new Voice Mail messages have been recorded.

Turn this feature off when:

- you do not subscribe to Voice Mail service.
 - your telephone service provider does not send Voice Mail tones.
 - your phone is connected to a PBX.
- If you are not sure which setting is required, consult your telephone service provider.

Turning VM tone detection on/off

The default setting is “on”.

Handset

- 1 **[MENU]** (middle soft key) → **[#][3][3][2]**
- 2 Select the desired setting. → **[SAVE]** → **[OFF]**

om

calls can be made:
 the handset and base unit
 handsets

ceive an outside call while
 n the intercom, you hear 2
 o answer the call with the
 press **[OFF]**, then press **[↶]**.
 er the call with the base unit,
[SP-PHONE] 2 times.

locate a misplaced handset by
 (handset locator).

an intercom call

COM]

he desired unit.
 estination unit
 e.

op paging, press

ou finish

ad
 ed
 division
 handset.
 A573) is
 its extension
 on the
 models (KX-
 70).

Base unit

1 [INTERCOM]

2 To page
 extensi
 To pa

- T

answer the page.

working, press **[OFF]**.

[SP-PHONE] or **[INTERCOM]**

er the page.

hen you finish talking, press **[SP-PHONE]**.

Note for handset and base unit:

- When the ringer volume is set to off, the handset or the base unit rings at the low level for intercom calls.

Multi-unit Operation

Auto intercom/Room monitor

This feature allows you to:

- answer an intercom call without pressing any buttons on the handset.
- listen to the sound in a room where the handset is located.

Turning auto intercom on/off

“**OFF**” (Default): Turns this feature off.

“**On (Ringer On)**”: When an intercom call is received, the handset rings 2 times then the speakerphone is automatically turned on.

“**On (Ringer Off)**”: When an intercom call is received, the handset does not ring and the speakerphone is automatically turned on. This allows you to easily monitor a baby’s room, for example, from different areas of the house.

Handset

1 **[MENU]** (middle soft key) → **[#][2][7][3]**

2 Select the desired setting.

3 **[SAVE]** → **[OFF]**

Note:

- This feature cannot be used when the base unit is paging all handsets, or when receiving a transferred call.

Answering an intercom call using auto intercom

Handset

1 When you are paged by the base unit or another handset, speak into the microphone.

- To switch to the receiver, press **[↶]**.

2 To end the intercom, press **[OFF]**.

Note:

- Auto intercom cannot be used when:
 - all handsets are being paged by the base unit.
 - your handset is receiving a transferred outside call.

Monitoring audio in a room

With a handset or the base unit, you can listen to the sound in a room where another handset is located.

Important:

- Before using this feature, set auto intercom of the destination handset to “**On (Ringer Off)**” to allow access by other handsets.

Handset

1 Call the destination handset (page 63).

- You can listen to the audio.

2 To mute your sound output, press **[MUTE]** if necessary.

3 Press **[OFF]** to stop monitoring.

Base unit

1 Call the destination handset (page 63).

- You can listen to the audio.

2 To mute your sound output, press **[MUTE]** if necessary.

3 Press **[INTERCOM]** to stop monitoring.

Transferring calls

Outside calls can be transferred between the handset and base unit, and between 2 handsets.

- 1** During an outside call, press **[INTERCOM]** to put the call on hold.
- 2** Select the desired unit. → **[CALL]**
- 3** Wait for the paged party to answer.
 - If the paged party does not answer, press **[↶]** to return to the outside call.
- 4** To complete the transfer, press **[OFF]**.
 - The outside call is being routed to the unit.

- 1** During an outside call, press **[INTERCOM]** to put the call on hold.
- 2**

Conference calls

The handset and base unit, or 2 handsets can have a conference call with an outside party.

Handset

- 1** During an outside call, press **[INTERCOM]** to put the call on hold.
- 2** Select the desired unit. → **[CALL]**
- 3** Wait for the paged party to answer.
- 4** When the paged party answers, press **[CONF]** to make a conference call.
 - To leave the conference, press **[OFF]**. The other parties can continue the conversation.
 - To put the outside call on hold, press **[HOLD]**. To resume the conference, press **[CONF]**.

Base unit

- 1** During an outside call, press **[INTERCOM]** to put the call on hold.
- 2** To page a specified handset, enter its extension number (**[1]** – **[8]**). To page all handsets, press **[0]**.
- 3** Wait for the paged party to answer.
- 4** When the paged party answers, press **[CONF]** to make a conference call.
 - To leave the conference, press **[SP-PHONE]**. The other parties can continue the conversation.
 - To put the outside call on hold, press **[HOLD]**. To resume the conference, press **[CONF]**.

Note for handset and base unit:

- One more extension can join a conference call. To join the conference call using the handset, press **[↶]**. To join using the base unit, press **[SP-PHONE]**. A maximum of 4 parties can join a conference call.

Registering a handset

The included handset and base unit are preregistered. If for some reason the handset is not registered to the base unit, register the handset.

Important:

- If you have already deregistered the handset, perform steps 2 and 3 only.

1 Handset:

[MENU] (middle soft key) →
[#][1][3][0]

2 Base unit:

Press and hold **[INTERCOM]** until the IN USE indicator flashes.

- After the IN USE indicator starts flashing, the rest of the procedure must be completed within 90 seconds.

3 Handset:

Press **[OK]**, then wait until a beep sounds.

Registering an additional handset

See page 7 for information on the available models and extension numbers. Start from step 2.

Deregistering a handset

Handset

1 [MENU] (middle soft key) →
[#][1][3][1]

2 [3][3][5] → [OK]

Deregistering other devices

The base unit can cancel the registration of a registered device (KX-TGA573/KX-TGA575, page 7).

Deregistering the cordless camera (KX-TGA573)

Important:

- Before deregistering, confirm the cordless camera's extension number (color display models only: KX-TG5776/KX-TG5777/KX-TG5779/KX-TGA571). Press **[INTERCOM]** on the handset to display its extension.

Base unit

- 1** Press and hold **[INTERCOM]** until the IN USE indicator flashes.
- 2** Press and hold the cordless camera's extension number (**[1] – [8]**) until a beep sounds.

Deregistering the USB adaptor (KX-TGA575)

Base unit

- 1** Press and hold **[INTERCOM]** until the IN USE indicator flashes.
- 2** Press and hold **[*]** until a beep sounds.

Additional accessories

Sales and support information

- To order replacement accessories, call 1-800-332-5368.
 - TTY users (hearing or speech impaired users) can call 1-866-605-1277.
-

Headset (optional)

Connecting a headset to the handset allows hands-free phone conversations. We recommend using the Panasonic headset noted on page 11.



- Headset shown is KX-TCA86.
- Handset shown is KX-TGA570.

Wall mounting (optional)

By purchasing the optional wall-mounting adaptor PQLK10078Z1, you can mount the base unit on a wall.

Belt clip (optional)

By purchasing the optional belt clip PQKE10457Z1, you can hang the handset on your belt or pocket.

Error messages

If the unit detects a problem, one of the following messages is shown on the display.

Display message	Cause/solution
Busy	<ul style="list-style-type: none"> • The called handset or base unit is in use. • Privacy mode is on for the call you tried to join (page 30). • Other units are in use and the system is busy. Try again later.
Error!!	<ul style="list-style-type: none"> • The handset's registration has failed. Move the handset and base unit away from all electrical appliances and try again. • 8 handsets have already been registered to the base unit. A previously deregistered handset number may still be retained in the base unit. To register an additional handset, erase the unnecessary handset number using the base unit: Press and hold [INTERCOM] until the IN USE indicator flashes. → Press and hold the handset's extension number ([1] – [8]) that you want to cancel/delete from the base unit until a beep sounds.
Failed	<ul style="list-style-type: none"> • The handset you tried to copy phonebook items to is in use. • The handset you tried to copy phonebook items to is out of area.
Incomplete	<ul style="list-style-type: none"> • The destination handset's phonebook memory is full. Erase unnecessary items from the destination handset's phonebook (page 34).
Invalid. Please register to the base unit	<ul style="list-style-type: none"> • The handset is not registered to the base unit. Register the handset (page 67).
No items stored	<ul style="list-style-type: none"> • Your phonebook or redial list is empty. • Color display models only (KX-TG5776/KX-TG5777/ KX-TG5779/KX-TGA571): "My pictures" is empty.

Useful Information

Display message	Cause/solution
No link to base. Move closer to base, try again.	<ul style="list-style-type: none">● The handset has lost communication with the base unit. Move closer to the base unit, and try again.● Unplug the base unit's AC adaptor to reset the unit. Reconnect the adaptor and try again.● Raise the base unit antennas.● The handset's registration may have been canceled. Re-register the handset (page 67).
Phonebook Memory full	<ul style="list-style-type: none">● There is no space to store new items in the phonebook. Erase unnecessary items (page 34).
Please lift up and try again.	<ul style="list-style-type: none">● A handset button was pressed while the handset was on the base unit or charger. Lift the handset and press the button again.

Troubleshooting

General use

Problem	Cause/solution
The unit does not work.	<ul style="list-style-type: none">• Make sure the battery is fully charged (page 14)• Check the connection of the handset• Unplug the battery pack and reconnect it• The handset is not registered
I cannot hear a dial tone.	<ul style="list-style-type: none">• Confirm the handset is fully charged (page 14)• Disconnect the handset from the base station

Programmable settings

Problem
I cannot program the handset.
While programming the handset, the handset starts to vibrate.

Battery recharging

Problem
I fully charged the battery pack, but the battery level indicator shows a low level.

Useful Information

Making/answering calls, intercom

Problem	Cause/solution
∇ is displayed, but I cannot make a call.	<ul style="list-style-type: none">● The handset and base unit could not communicate for some reason, such as interference from other electrical appliances. Perform the following:<ul style="list-style-type: none">– Move the handset and base unit away from other electrical appliances.– Move closer to the base unit.– Raise the base unit antennas.
Static is heard, sound cuts in and out. Interference from other electrical units.	<ul style="list-style-type: none">● Move the handset and base unit away from other electrical appliances.● Move closer to the base unit.● Raise the base unit antennas.● Turn on the clarity booster feature (page 29).● If your unit is connected to a telephone line with DSL service, we recommend connecting a noise filter between the base unit and the telephone line jack. Contact your DSL provider for details.
The handset and base unit do not ring.	<ul style="list-style-type: none">● The ringer volume is turned off. Adjust it (page 28, 47).
I cannot make a call.	<ul style="list-style-type: none">● The dialing mode may be set incorrectly. Change the setting (page 25).● The base unit or another handset is in use. Try again later.
I cannot redial by pressing [REDIAL] .	<ul style="list-style-type: none">● If the last number dialed was more than 48 digits long, the number will not be redialed correctly. Dial the number manually.
I cannot have a conversation using the headset.	<ul style="list-style-type: none">● Make sure that an optional headset is connected properly (page 68).
I cannot make long distance calls.	<ul style="list-style-type: none">● Make sure that you have long distance service.
I cannot page the handset or base unit.	<ul style="list-style-type: none">● The called handset is too far from the base unit.● The called unit is in use. Try again later.
I cannot turn the clarity booster on.	<ul style="list-style-type: none">● Another handset is already using this feature.

Caller ID

Problem	Cause/solution
The handset does not display the caller's name and/or phone number.	<ul style="list-style-type: none"><li data-bbox="378 201 998 258">● You have not subscribed to Caller ID service. Contact your telephone service provider to subscribe.<li data-bbox="378 258 998 372">● If your unit is connected to any additional telephone equipment such as a Caller ID box or cordless telephone jack, disconnect the unit from the equipment and plug the unit directly into the wall jack.<li data-bbox="378 372 998 486">● If your unit is connected to a telephone line with DSL service, we recommend connecting a noise filter between the base unit and the telephone line jack. Contact your DSL provider for details.<li data-bbox="378 486 998 522">● The name display service may not be available in some

Useful Information

Problem	Cause/solution
I cannot dial the phone number edited in the caller list.	<ul style="list-style-type: none">• The phone number you dialed is incorrect (for example, the area code is missing), or you dialed another pattern (page 100).
The 2nd caller's information is not displayed during an outside call.	<ul style="list-style-type: none">• In order to use Call Forwarding with Caller ID (CWID), you must have a service provided by your telephone service provider. After subscribing to the service, you must select a specific service for each number in the Caller ID list (page 100) (CWID).
I cannot access the caller list.	<ul style="list-style-type: none">• Some features may not be available in all areas.

Answering system

Problem
I cannot listen to messages from a remote location.
The unit does not receive new messages.
I cannot answer messages.
I cannot delete messages.

FCC and other information

This equipment complies with Part 68 of the FCC rules and the requirements adopted by the ACTA. On the bottom of this equipment is a label that contains, among other information, a product identifier in the format US:ACJ-----.

If requested, this number must be provided to the telephone company.

- Registration No
.....(found on the bottom of the unit)
- Ringer Equivalence No.
(REN).....0.1B

A plug and jack used to connect this equipment to the premises wiring and telephone network must comply with the applicable FCC Part 68 rules and requirements adopted by the ACTA. A compliant telephone cord and modular plug is provided with the product. It is designed to be connected to a compatible modular jack that is also compliant.

The REN is used to determine the number of devices that may be connected to a telephone line. Excessive RENs on a telephone line may result in the devices not ringing in response to an incoming call. In most but not all areas, the sum of RENs should not exceed five (5.0). To be certain of the number of devices that may be connected to a line, as determined by the total RENs, contact the local telephone company. For products approved after July 23, 2001, the REN for the product is part of the product identifier that has the format US:AAAEQ##TXXXX. The digits represented by ## are the REN without a

decimal point (e.g., 03 is a REN of 0.3).

If this equipment causes harm to the telephone network, the telephone company will notify you in advance that temporary discontinuance of service may be required. But if advance notice isn't practical, the telephone company will notify the customer as soon as possible. Also, you will be advised of your right to file a complaint with the FCC if you believe it is necessary.

The telephone company may make changes in its facilities, equipment, operations or procedures that could affect the operation of the equipment. If this happens the telephone company will provide advance notice in order for you to make necessary modifications to maintain uninterrupted service.

If trouble is experienced with this equipment, for repair or warranty information, please contact a Factory Servicenter or other Authorized Servicer. If the equipment is causing harm to the telephone network, the telephone company may request that you disconnect the equipment until the problem is resolved.

Connection to party line service is subject to state tariffs. Contact the state public utility commission, public service commission or corporation commission for information.

If your home has specially wired alarm equipment connected to the telephone

Useful Information

line, ensure the installation of this equipment does not disable your alarm equipment. If you have questions about what will disable alarm equipment, consult your telephone company or a qualified installer.

This equipment is hearing aid compatible as defined by the FCC in 47 CFR Section 68.316.

When you hold the phone to your ear, noise might be heard in your Hearing Aid. Some Hearing Aids are not adequately shielded from external RF (radio frequency) energy. If noise occurs, use an optional headset accessory or the speakerphone option (if applicable) when using this phone. Consult with your audiologist or Hearing Aid manufacturer about the availability of Hearing Aids which provide adequate shielding to RF energy commonly emitted by digital devices.

WHEN PROGRAMMING EMERGENCY NUMBERS AND/OR MAKING TEST CALLS TO EMERGENCY NUMBERS:

- 1) Remain on the line and briefly explain to the dispatcher the reason for the call.
- 2) Perform such activities in the off-peak hours, such as early morning or late evenings.

This device complies with Part 15 of the FCC Rules. Operation is subject to the following two conditions:

(1) This device may not cause harmful interference, and (2) this device must accept any interference received, including interference that may cause undesired operation.

Privacy of communications may not be ensured when using this phone.

CAUTION:

Any changes or modifications not expressly approved by the party responsible for compliance could void the user's authority to operate this device.

NOTE:

This equipment has been tested and found to comply with the limits for a Class B digital device, pursuant to Part 15 of the FCC Rules. These limits are designed to provide reasonable protection against harmful interference in a residential installation. This equipment generates, uses, and can radiate radio frequency energy and, if not installed and used in accordance with the instructions, may cause harmful interference to radio communications. However, there is no guarantee that interference will not occur in a particular installation. If this equipment does cause harmful interference to radio or television reception, which can be determined by turning the equipment off and on, the user is encouraged to try to correct the interference by one or more of the following measures:

- Reorient or relocate the receiving antenna.
- Increase the separation between the equipment and receiver.
- Connect the equipment into an outlet on a circuit different from that to which the receiver is connected.
- Consult the dealer or an experienced radio/TV technician for help.

Some cordless telephones operate at frequencies that may cause interference to nearby TVs and VCRs. To minimize or prevent such interference, the base of the cordless telephone should not be placed near or on top of a TV or VCR. If interference is experienced, move the cordless telephone further away from the TV or VCR. This will often reduce, or eliminate, interference.

FCC RF Exposure Warning:

The product complies with FCC radiation exposure limits set forth for an uncontrolled environment. To comply with FCC RF exposure requirements, the base unit must be installed and operated with its antenna located 20 cm (8 inches) or more between the antenna and all person's body (excluding extremities of hands, wrist and feet). The handset may be carried and operated with only the optional specific belt-clip. Other non-tested belt-clips or similar body-worn accessories may not comply and must be avoided. The product must not be collocated or operated in conjunction with any other antenna or transmitter.

Responsible party:

Panasonic Corporation of North America
One Panasonic Way,
Secaucus, New Jersey 07094
Phone number: 1-800-211-PANA (1-800-211-7262)

FCC Warning (KX-TG5776, KX-TG5777, KX-TG5779, and KX-TGA571 only):

To ensure compliance with FCC emissions limits, use only the included USB cable with the ferrite core when connecting the unit to a computer.

Notice

- This product is designed for use in the United States of America. Sale or use of this product in other countries may violate local laws.
- Cet appareil est conçu pour être utilisé aux États-Unis d'Amérique. La vente ou l'emploi de cet appareil dans certains autres pays peut constituer une infraction à la législation locale.
- Este producto está diseñado para usarse en los Estados Unidos de América.
La venta o el empleo de este producto en ciertos países puede constituir violación de la ley
- この製品は、日本国外での使用を目的として設計されており、日本国内での使用は法律違反となります。従って、当社では日本国内においては原則として修理などのサービスは致しかねます。

Specifications

General

Operating environment	5 °C – 40 °C (41 °F – 104 °F)
Frequency	5.76 GHz – 5.84 GHz

Base unit

Dimensions	Approx. height 55 mm x width 230 mm x depth 140 mm (2 ⁵ / ₃₂ inches x 9 ¹ / ₁₆ inches x 5 ¹ / ₂ inches)
Mass (Weight)	Approx. 420 g (0.93 lb.)
Power consumption	Standby: Approx. 2.1 W Maximum: Approx. 5.2 W
Power output	200 mW (max.)
Power supply	AC adaptor (120 V AC, 60 Hz)

Handset

Dimensions	Approx. height 156 mm x width 49 mm x depth 35 mm (6 ¹ / ₈ inches x 1 ¹⁵ / ₁₆ inches x 1 ³ / ₈ inches)
Mass (Weight)	Approx. 150 g (0.33 lb.)
Power output	200 mW (max.)
Power supply	Ni-MH battery (2.4 V, 830 mAh)

Charger (KX-TG5777 only)

Dimensions	Approx. height 58 mm x width 87 mm x depth 95 mm (2 ⁹ / ₃₂ inches x 3 ⁷ / ₁₆ inches x 3 ³ / ₄ inches)
Mass (Weight)	Approx. 90 g (0.20 lb.)
Power consumption	Standby: Approx. 1.1 W Maximum: Approx. 3.4 W
Power supply	AC adaptor (120 V AC, 60 Hz)

Note:

- Design and specifications are subject to change without notice.
- The illustrations in these instructions may vary slightly from the actual product.

Warranty

PANASONIC CONSUMER
ELECTRONICS COMPANY, DIVISION
OF PANASONIC CORPORATION OF
NORTH AMERICA
One Panasonic Way,
Secaucus, New Jersey 07094

PANASONIC PUERTO RICO, INC.
San Gabriel Industrial Park,
Ave. 65 de Infantería, Km. 9.5,
Carolina, Puerto Rico 00985

Panasonic Telephone Products Limited Warranty

Limited Warranty Coverage

If your product does not work properly because of a defect in materials or workmanship, Panasonic Consumer Electronics Company or Panasonic Puerto Rico, Inc. (collectively referred to as "the warrantor") will, for the length of the period indicated on the chart below, which starts with the date of original purchase ("Limited Warranty period"), at its option either (a) repair your product with new or refurbished parts, or (b) replace it with a new or a refurbished product. The decision to repair or replace will be made by the warrantor.

Parts	Labor
One (1) Year	One (1) Year

During the "Labor" Limited Warranty period there will be no charge for labor. During the "Parts" Limited Warranty period, there will be no charge for parts. You must mail-in your product prepaid during the Limited Warranty period. This Limited Warranty excludes both parts and labor for batteries, antennas, and cosmetic parts (cabinet). This Limited Warranty only applies to products purchased and serviced in the United States or Puerto Rico. This Limited Warranty is extended only to the original purchaser and only covers products purchased as new.

Mail-In Service

For assistance in the continental U.S.A. in obtaining repairs please ship the product prepaid to:

Panasonic Service and Technology Company Customer Service Center
4900 George McVay Drive Suite B Door #12 McAllen, TX 78503

For assistance in Puerto Rico call Panasonic Puerto Rico, Inc. (787)-750-4300 or fax (787)-768-2910.

For Limited Warranty service for headsets if a headset is included with this product please call Panasonic at 1-800-332-5368.

When shipping the unit carefully pack, include all accessories, and send it prepaid, adequately insured and preferably in the original carton. Include a letter detailing the complaint, a return address and provide a day time phone number where you can be reached.

IF REPAIR IS NEEDED DURING THE LIMITED WARRANTY PERIOD THE PURCHASER WILL BE REQUIRED TO FURNISH A SALES RECEIPT/PROOF OF PURCHASE INDICATING DATE OF PURCHASE, AMOUNT PAID AND PLACE OF PURCHASE. CUSTOMER WILL BE CHARGED FOR THE REPAIR OF ANY UNIT RECEIVED WITHOUT SUCH PROOF OF PURCHASE.

Limited Warranty Limits And Exclusions

This Limited Warranty ONLY COVERS failures due to defects in materials or workmanship, and DOES NOT COVER normal wear and tear or cosmetic damage. The Limited Warranty ALSO DOES NOT COVER damages which occurred in shipment, or failures which are caused by products not supplied by the warrantor, or failures which result from accidents, misuse, abuse, neglect, bug infestation, mishandling, misapplication, alteration, faulty installation, set-up adjustments, misadjustment of consumer controls, improper maintenance, power line surge, lightning damage, modification, introduction of sand, humidity or liquids, commercial use such as hotel, office, restaurant, or other business or rental use of the product, or service by anyone other than a Factory Service Center or other Authorized Servicer, or damage that is attributable to acts of God.

THERE ARE NO EXPRESS WARRANTIES EXCEPT AS LISTED UNDER "LIMITED WARRANTY COVERAGE". THE WARRANTOR IS NOT LIABLE FOR INCIDENTAL OR CONSEQUENTIAL DAMAGES RESULTING FROM THE USE OF THIS PRODUCT, OR ARISING OUT OF ANY BREACH OF THIS LIMITED WARRANTY. (As examples, this excludes damages for lost time, lost calls or messages, cost of having someone remove or re-install an installed unit if applicable, travel to and from the servicer. The items listed are not exclusive, but are for illustration only.) **ALL EXPRESS AND IMPLIED WARRANTIES, INCLUDING THE WARRANTY OF MERCHANTABILITY, ARE LIMITED TO THE PERIOD OF THE LIMITED WARRANTY.**

Some states do not allow the exclusion or limitation of incidental or consequential damages, or limitations on how long an implied warranty lasts, so the exclusions may not apply to you.

This Limited Warranty gives you specific legal rights and you may also have other rights which vary from state to state. If a problem with this product develops during or after the Limited Warranty period, you may contact your dealer or Service Center. If the problem is not handled to your satisfaction, then write to the warrantor's Consumer Affairs Department at the addresses listed for the warrantor.

PARTS AND SERVICE, WHICH ARE NOT COVERED BY THIS LIMITED WARRANTY, ARE YOUR RESPONSIBILITY.

Customer services

Customer Services Directory

Obtain Product Information and Operating Assistance; locate your nearest Dealer or Service Center; purchase Parts and Accessories; or make Customer Service and Literature requests by visiting our Web Site at:

<http://www.panasonic.com/help>

or, contact us via the web at:

<http://www.panasonic.com/contactinfo>

You may also contact us directly at: 1-800-211-PANA (1-800-211-7262), Monday-Friday 9 am to 9 pm; Saturday - Sunday 10 am to 7 pm, EST.

TTY users (hearing or speech impaired users) can call 1-877-833-8855.

Accessory Purchases

Purchase Parts, Accessories and Instruction Books online for all Panasonic Products by visiting our Web Site at:

<http://www.pasc.panasonic.com>

or, send your request by E-mail to:

npcparts@us.panasonic.com

You may also contact us directly at:

1-800-332-5368 (Phone) 1-800-237-9080 (Fax Only)

(Monday - Friday 9 am to 9 pm, EST.)

Panasonic Service and Technology Company

20421 84th Avenue South, Kent, WA 98032

(We Accept Visa, MasterCard, Discover Card, American Express, and Personal Checks.)

TTY users (hearing or speech impaired users) can call 1-866-605-1277.

Service in Puerto Rico

Panasonic Puerto Rico, Inc.

San Gabriel Industrial Park, Ave. 65 de Infantería, Km. 9.5,

Carolina, Puerto Rico 00985

Phone (787)750-4300, Fax (787)768-2910

Index

- A** Answering calls: 27
 - Answering system
 - Erasing messages: 55, 57, 59
 - Listening to messages: 55, 56, 58
 - Turning on/off: 54, 56, 59
 - Appearance (display color): 48
 - Audio cable: 49
 - Auto intercom: 64
 - Auto talk: 27
- B** Battery
 - Charge: 17
 - Installation: 16
 - Level: 17
 - Performance: 18
 - Replacement: 16
- Belt clip: 11, 68
- Booster (Clarity booster): 29
- C** Call screening: 54, 61
 - Call share: 30
 - Call Waiting: 29
 - Call Waiting Caller ID: 37
 - Caller ID edit: 39
 - Caller ID number auto edit: 39
 - Caller ID service: 37
 - Caller list
 - Calling back: 39
 - Editing: 39
 - Erasing: 40
 - Storing: 40
 - Viewing: 39
 - Chain dial: 35
 - CID (Caller ID): 37
 - Conference calls: 66
 - Connections: 15, 16
 - Custom ring: 49
 - Customer support: 46
- D** Date and time: 25
 - Deregistration: 67, 69
 - Dialing mode: 25
 - Direct commands: 46
 - Display
 - Contrast: 47
 - Language: 25
- E** Error messages: 69
- F** Flash: 29
 - Flash time: 47
 - Four way conference: 30, 66
- G** Greeting message: 54
- H** Handset locator: 63
 - Handset name: 51
 - Headset, optional: 68
 - Hold: 28
- I** Installation
 - Base unit: 15
 - Handset: 16
 - Intercom: 63
- J** Joystick: 6
- K** Key tone: 47
- L** Light-up ID: 38
 - Line mode: 47
- M** Making calls: 26
 - MEMO: 57
 - Memory capacity (message recording): 54
 - Memory status (images and melodies): 52
 - Message alert: 61
 - Missed calls: 37
 - Mute: 29
- N** Navigator key: 6
- P** Pause: 26, 36
 - Phonebook: 31
 - Phonebook copy: 35
 - Picture ID: 38
 - Power failure: 15
 - Pulse service: 29
- R** Recording time: 60
 - Redial list: 26

Registration: 67
Remote code: 59
Remote operation: 58
Ring color: 47
Ring count: 59
Ringer ID: 38
Ringer off
 Base unit: 28
 Handset: 27, 47
Ringer tone
 Base unit: 28
 Handset: 47
Room monitor: 64
Rotary service: 29

S SILENCE: 54
Speed dialer: 36
SP-phone: 26

T Talking Caller ID: 37
Time adjustment: 47
Toll saver: 59
Tone: 29
Transferring calls: 65
Troubleshooting: 71
TTY: 11, 68, 81

U USB cable: 9, 11

V VE (Voice Enhancer): 30
VM (Voice Mail) tone detect: 62
Voice guidance: 58
Voice Mail service: 60, 62
Volume
 Base unit ringer: 28
 Base unit speaker: 27
 Handset receiver: 26
 Handset ringer: 47
 Handset speaker: 26

W Wall-mounting
 Base unit: 11, 68
 Charger: 18
Wallpaper: 52
Warranty: 79

If you need assistance with setup or operation

- 1** Visit our website: <http://www.panasonic.com/help>
- 2** Contact us via the web at: <http://www.panasonic.com/contactinfo>
- 3** Call us at: 1-800-211-PANA (1-800-211-7262)
TTY users (hearing or speech impaired users) can call 1-877-833-8855.

When you ship the product

- Carefully pack your unit, preferably in the original carton.
- Attach a letter, detailing the symptom, to the outside of the carton.
- Send the unit to Panasonic Service and Technology Company Customer Service Center, prepaid and adequately insured.
- Do not send your unit to Panasonic Consumer Electronics Company listed below or to executive or regional sales offices. These locations do not repair consumer products.

**Panasonic Consumer Electronics Company,
Division of Panasonic Corporation of North America**
One Panasonic Way, Secaucus, New Jersey 07094

Panasonic Puerto Rico, Inc.
San Gabriel Industrial Park, Ave. 65 de Infantería, Km. 9.5,
Carolina, Puerto Rico 00985

Copyright:

This material is copyrighted by Panasonic Communications Co., Ltd., and may be reproduced for internal use only. All other reproduction, in whole or in part, is prohibited without the written consent of Panasonic Communications Co., Ltd.
© 2006 Panasonic Communications Co., Ltd. All Rights Reserved.



TG5771

PQQX14980YA DM0206SN3027

Free Manuals Download Website

<http://myh66.com>

<http://usermanuals.us>

<http://www.somanuals.com>

<http://www.4manuals.cc>

<http://www.manual-lib.com>

<http://www.404manual.com>

<http://www.luxmanual.com>

<http://aubethermostatmanual.com>

Golf course search by state

<http://golfingnear.com>

Email search by domain

<http://emailbydomain.com>

Auto manuals search

<http://auto.somanuals.com>

TV manuals search

<http://tv.somanuals.com>