

# Panasonic

## Operating Instructions

---

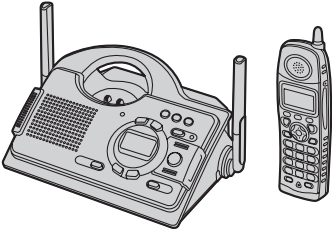

Model shown is KX-TG5838AL.

5.8 GHz Digital Cordless Answering System

Model No. **KX-TG5838AL**

5.8 GHz Digital Cordless Answering System  
with Dual Handsets

Model No. **KX-TG5839AL**



This unit is compatible with Caller ID. To use this feature, you must subscribe to the appropriate service offered by your service provider.

**Charge the battery for 6 hours before initial use.**

Please read these Operating Instructions before using the unit and save for future reference.

## Table of Contents

### Introduction

Your phone	4
Accessory information	5
Important safety instructions	6
For best performance	8

### Preparation

Connections	10
Battery installation	11
Battery charge	12
Battery replacement	13
Controls and displays	14
Controls	14
Display	16
Setting the date and time	17

### Making/Answering Calls

Making calls	18
Answering calls	19
Useful features during a call	20
HOLD button	20
MUTE button	20
Voice enhancer	20
Clarity booster	21
Call share (KX-TG5839AL only)	21
PAUSE button (for PBX/long distance service users)	21
Recall button	21

### Phonebook

Using the phonebook	22
Adding items to the phonebook	22
Calling someone in the phonebook	23
Editing items in the phonebook	23
Erasing items in the phonebook	23
Chain dial feature	24
Copying phonebook items (KX-TG5839AL only)	24
Copying an item	24
Copying all items	25

### Caller ID Service

Using Caller ID service	26
Call waiting and Caller ID compatible	26
Ringer ID and light-up ID	26
Caller list	27

Viewing the caller list and calling back	27
Editing a caller's phone number before calling back	28
Storing caller information into the phonebook	28
Erasing caller information	29

### Intercom Features

Intercom	30
For KX-TG5838AL users	30
For KX-TG5839AL users	31
Transferring a call (KX-TG5839AL only)	32
Conference calls (KX-TG5839AL only)	32

### Programmable Settings

Guide to handset programming	33
Ringer settings	34
Handset ringer volume	34
Handset ringer tone	35
Handset interrupt tone	35
Call options	36
Auto talk	36
Voice enhancer	36
Display options	36
Handset LCD contrast	36
Telephone settings	37
Recall time	37
Line mode	37
Storing your area code	37
Other options	38
Dial lock	38
Handset key tone	38
Re-registering the handset	38
Time adjustment (Caller ID subscribers only)	39
Programming via direct commands	40
Direct commands chart	40

### Answering System Features

Answering system	42
Recording your greeting message	42
Erasing your greeting message	43
Pre-recorded greeting message	43
Turning the answering system on/off	43
Screening your calls	43

Listening to messages . . . . . 44  
  Listening to messages using the base  
  unit . . . . . 44  
  Listening to messages using the  
  handset . . . . . 45  
Memory capacity . . . . . 46  
Remote operation . . . . . 47  
  Using the answering system  
  remotely . . . . . 47  
Answering system settings . . . . . 48  
  Remote code . . . . . 48  
  Ring count . . . . . 49  
  Caller's recording time . . . . . 50  
  Message alert . . . . . 50

**Useful Information**

Belt clip . . . . . 51  
Headset (optional) . . . . . 51  
Wall mounting . . . . . 52  
  Base unit . . . . . 52  
  Charger (KX-TG5839AL only) . . . . . 55  
Error messages . . . . . 56  
Troubleshooting . . . . . 57  
  General use . . . . . 57  
  Programmable settings . . . . . 57  
  Making/answering calls, Intercom . . . . . 58  
  Phonebook . . . . . 59  
  Caller ID . . . . . 59  
  Answering system . . . . . 60  
  Battery charge . . . . . 60  
  Power failure . . . . . 61  
Instructions to customer . . . . . 62  
Technical information . . . . . 64  
  Base unit . . . . . 64  
  Handset . . . . . 64  
  Charger (KX-TG5839AL only) . . . . . 64

**Index**

Index . . . . . 65

## Introduction

Thank you for purchasing a Panasonic cordless telephone.

We recommend keeping a record of the following information for future reference.

Serial No. \_\_\_\_\_

Date of purchase \_\_\_\_\_

(found on the bottom of the unit)

Name and address of dealer \_\_\_\_\_

**Attach your purchase receipt here.**

## Your phone

KX-TG5838AL

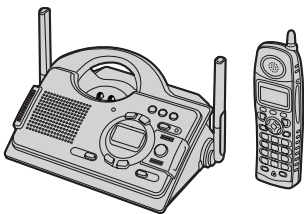

KX-TG5839AL

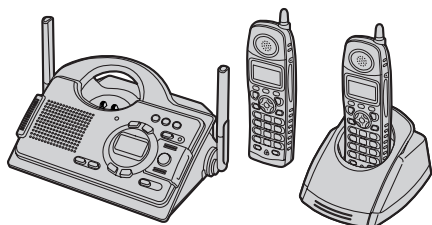

- References in these operating instructions to the charger and to the other handset are for KX-TG5839AL users only.

## Accessory information

### Included accessories

No.	Accessory items	Quantity	
		KX-TG5838AL	KX-TG5839AL
①	AC adaptor for base unit	1	1
②	Telephone line cord	1	1
③	Telephone plug	1	1
④	Wall mounting adaptor	1	1
⑤	Battery	1	2
⑥	Handset cover	1	2
⑦	Belt clip	1	2
⑧	Charger	–	1
	AC adaptor for charger	–	1

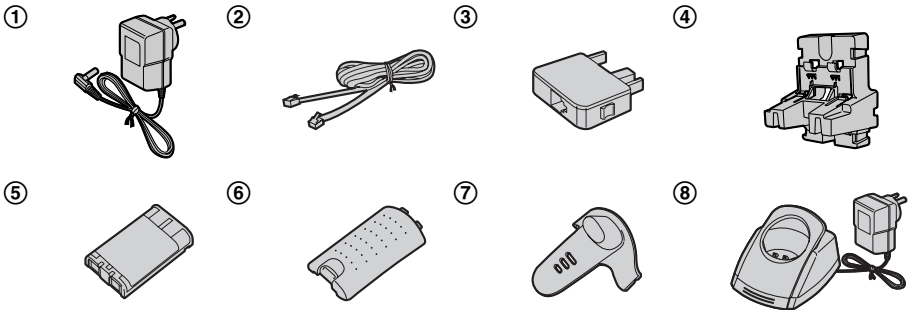

### Additional/replacement accessories

Accessory items	Order number
Rechargeable nickel metal hydride (Ni-MH) battery	HHR-P104
Headset	KX-TCA88AL

---

---

# Important safety instructions

When using this unit, basic safety precautions should always be followed to reduce the risk of fire, electric shock, or personal injury.

1. Read and understand all instructions.
2. Follow all warnings and instructions marked on this unit.
3. Unplug this unit from power outlets before cleaning. Do not use liquid or aerosol cleaners. Use a damp cloth for cleaning.
4. Do not use this unit near water, for example near a bathtub, wash bowl, kitchen sink, etc.
5. Place the unit securely on a stable surface. Serious damage and/or injury may result if the unit falls.
6. Do not cover slots and openings on the unit. They are provided for ventilation and protection against overheating. Never place the unit near radiators, or in a place where proper ventilation is not provided.
7. Use only the power source marked on the unit. If you are not sure of the type of power supplied to your home, consult your dealer or local power company.
8. Do not place objects on the power cord. Install the unit where no one can step or trip on the cord.
9. Do not overload power outlets and extension cords. This can result in the risk of fire or electric shock.
10. Never push any objects through slots in this unit. This may result in the risk of fire or electric shock. Never spill any liquid on the unit.
11. To reduce the risk of electric shock, do not disassemble this unit. Take the unit to an authorised service centre when service is required. Opening or removing covers may expose you to dangerous voltages or other risks.

Incorrect reassembly can cause electric shock when the unit is subsequently used.

12. Unplug this unit from power outlets and refer servicing to an authorised service centre when the following conditions occur:
  - A. When the power cord is damaged or frayed.
  - B. If liquid has been spilled into the unit.
  - C. If the unit has been exposed to rain or water.
  - D. If the unit does not work normally by following the operating instructions. Adjust only controls covered by the operating instructions. Improper adjustment may require extensive work by an authorised service centre.
  - E. If the unit has been dropped or physically damaged.
  - F. If the unit exhibits a distinct change in performance.
13. During thunderstorms, avoid using telephones except cordless types. There may be a remote risk of an electric shock from lightning.
14. Do not use this unit to report a gas leak, when in the vicinity of the leak.

## SAVE THESE INSTRUCTIONS

### CAUTION:

#### Installation

- Never install telephone wiring during a lightning storm.
- Never install telephone jacks in wet locations unless the jack is specifically designed for wet locations.
- Never touch uninsulated telephone wires or terminals unless the telephone line has been disconnected at the network interface.
- Use caution when installing or modifying telephone lines.

- Do not touch the plug with wet hands.
- The AC adaptor is used as the main disconnect device. Ensure that the AC outlet is installed near the unit and is easily accessible.

### Battery

To reduce the risk of fire or injury to persons, read and follow these instructions.

- Use only the battery(ies) specified.
- Do not dispose of the battery(ies) in a fire. They may explode. Check with local waste management codes for special disposal instructions.
- Do not open or mutilate the battery(ies). Released electrolyte is corrosive and may cause burns or injury to the eyes or skin. The electrolyte may be toxic if swallowed.
- Exercise care when handling the battery(ies). Do not allow conductive materials such as rings, bracelets or keys to touch the battery(ies), otherwise a short circuit may cause the battery(ies) and/or the conductive material to overheat and cause burns.
- Charge the battery(ies) provided with or identified for use with this product only in accordance with the instructions and limitations specified in this manual.

### WARNING:

- To prevent the risk of fire or electrical shock, do not expose this product to rain or any type of moisture.

### Medical

- Consult the manufacturer of any personal medical devices, such as pacemakers or hearing aids, to determine if they are adequately shielded from external RF (radio frequency) energy. (The unit operates in the frequency range of 5.76 GHz to 5.84 GHz, and the power output level can range from 0.25 to 0.5 watts.) Do not use

the unit in health care facilities if any regulations posted in the area instruct you not to do so. Hospitals or health care facilities may be using equipment that could be sensitive to external RF (radio frequency) energy.

### Splash-resistant (handset only)

The handset is designed to be splash-resistant.

You can use the handset with wet hands.

- Do not immerse in water or leave under running water.
- Keep the handset away from salt water.
- Avoid exposure to prolonged high humidity.
- Since water in headset jack may cause damage, close the headset jack cover when the optional headset is not in use. When the optional headset is connected, do not use the handset with wet hands.
- If the handset is wet, wipe with a soft dry cloth.
- The base unit is not designed to be splash resistant. Do not place the handset on the base unit if the handset is wet.

### Shock-resistant (handset only)

The handset is designed to be shock-resistant, however, it should not be thrown or stepped on.

### Notice

- Please ensure that a separate telephone, not dependent on local power, is available for emergency use.
- This equipment will be inoperable when mains power fails.
- When a failure occurs which results in the internal parts becoming accessible, disconnect the power supply cord immediately and return this unit to an authorised service centre.
- To minimise the possibility of lightning damage, when you know that a

thunderstorm is coming, we recommend that you:

- Unplug the telephone line cord from the phone jack.
- Unplug the power supply cord from the AC power outlet.
- No “000” or other calls can be made from this device during a mains power failure.
- The earcap on the handset is magnetised and may retain metallic objects.
- This equipment has been tested and found to comply with AS/NZS 3548: 1995 limits for electromagnetic interference. Any modifications to any part of the system or to any peripherals may void the EMC compliance of the system or the peripherals.

---

---

## For best performance

### Base unit location/noise

The base unit and handset use radio waves to communicate with each other. For maximum distance and noise-free operation, we recommend the following:

- Placing the unit away from electrical appliances such as a TV, personal computer or another cordless phone.
- Placing the base unit in a HIGH and CENTRAL location with no obstructions such as walls.
- Raising the antennas vertically.
- If you use the handset near a microwave oven which is being used, noise may be heard. Move away from the microwave oven and closer to the base unit.
- If you use the handset near another cordless phone’s base unit, noise may be heard. Move away from the other cordless phone’s base unit and closer to your base unit.

### Environment

- Keep the unit away from electrical noise generating devices, such as fluorescent lamps and motors.
- The unit should be kept free from excessive smoke, dust, high temperature and vibration.
- The unit should not be exposed to direct sunlight.
- Do not place heavy objects on top of the unit.
- When you leave the unit unused for a long period of time, unplug this unit from power outlet.
- The unit should be kept away from heat sources such as heaters, kitchen stoves, etc. It should not be placed in rooms where the temperature is less than 5 °C or greater than 40 °C. Damp basements should also be avoided.
- The maximum calling distance may be shortened when the unit is used in the



following places: Near obstacles such as hills, tunnels, undergrounds, near metal objects such as wire fences, etc.

- Operating near 5.8 GHz electrical appliances may cause interference. Move away from the electrical appliances.

### **Routine care**

- Wipe the outer surface of the unit with a soft cloth. Do not use benzine, thinner or any abrasive powder.

## Connections

### Base unit

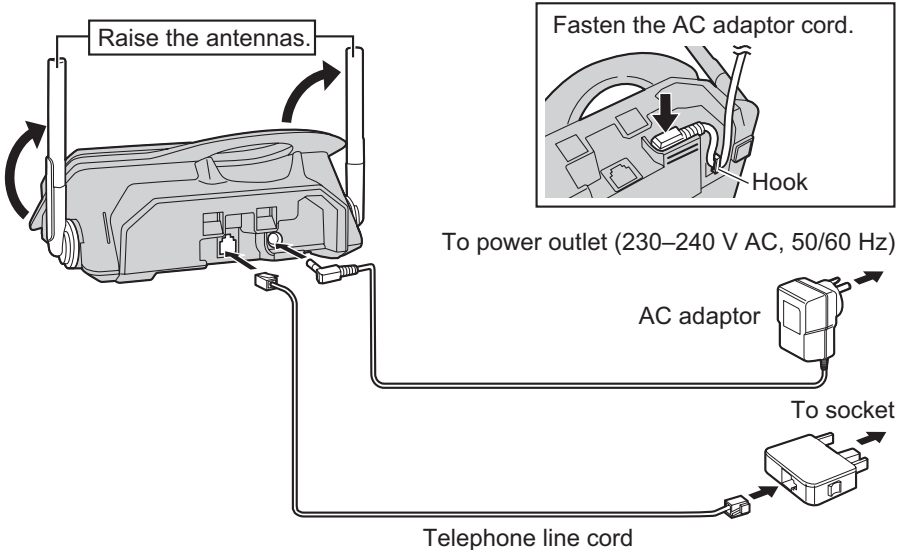

### Charger (KX-TG5839AL only)

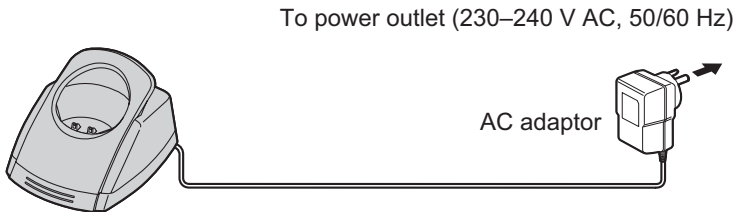

### Note:

- Base unit: Use only the included Panasonic AC adaptor PQLV1AL.
- Charger: Use only the included Panasonic AC adaptor KX-TCA1AL.
- The AC adaptor must remain connected at all times. (It is normal for the adaptor to feel warm during use.)
- The AC adaptor should be connected to a vertically oriented or floor-mounted AC outlet. Do not connect the AC adaptor to a ceiling-mounted AC outlet, as the weight of the adaptor may cause it to become disconnected.
- The unit will not work during a power failure. We recommend connecting a standard telephone to the same telephone line or to the same telephone jack using a telephone double adaptor.
- The unit is not designed to be used with rotary (pulse dialling) services.

### If you subscribe to an ADSL service

- Please attach a noise filter (contact your ADSL provider) to the telephone line between the base unit and the telephone line jack in the event of the following:
  - Noise is heard during conversations.
  - Caller ID features (page 26) do not function properly.

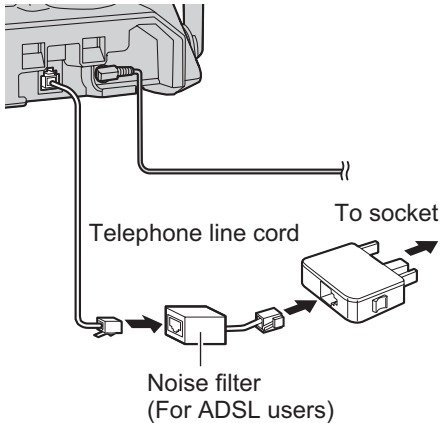

## Battery installation

- 1 Release the battery cover latch and lift the cover open.

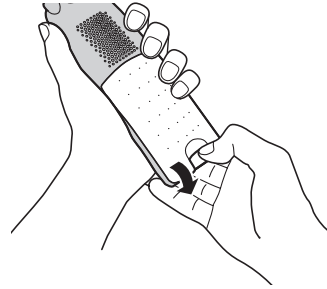

- 2 Insert the battery (①), and press it down until it snaps into the compartment (②).

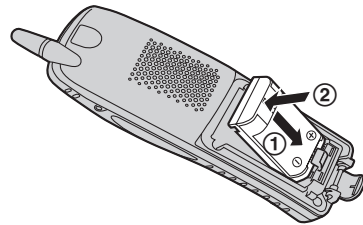

- 3 Close the handset cover.

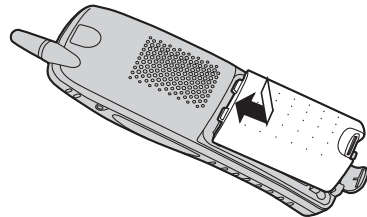

- 4 Fasten the battery cover latch.

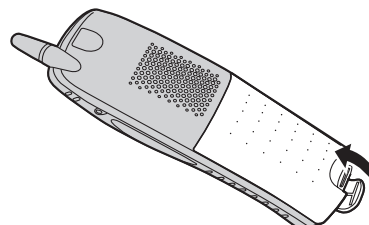

### Battery charge

Place the handset on the base unit or charger for **6 hours** before initial use.

- The unit will beep once, the CHARGE indicator will light, and “**charging**” will be displayed.
- “**Charge completed**” is displayed when the battery has been fully charged. The CHARGE indicator will remain lit.

#### Base unit

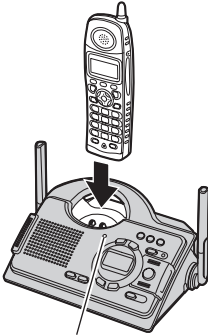

CHARGE indicator

#### Charger (KX-TG5839AL only)

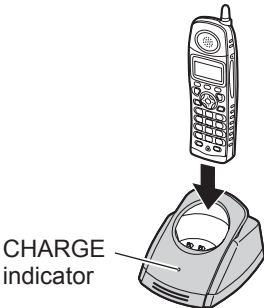

CHARGE indicator

#### Note:

- To ensure the battery charges properly, clean the charge contacts of the handset, base unit, and charger with a soft, dry cloth once a month. Clean more often if the unit is subject to grease, dust, or high humidity.

### Battery strength

You can confirm the battery strength on the handset display.

Battery icon	Battery strength
	Fully charged
	Medium
	Low When flashing: needs to be recharged.
	Discharged

### Recharging the battery

Recharge the battery when:

- “**Recharge battery**” is displayed or flashes on the handset display.
- the handset beeps intermittently while it is in use.

#### Note:

- Recharge the handset battery for more than 15 minutes, or the display will continue showing the indication.
- If the battery has been discharged, the handset will display “**Charge for 6h**” and when you place the handset on the base unit or charger.

### Battery performance

After your Panasonic battery is fully charged, you can expect approximately the following performance:

Operation	Operating time
While in use (talking)	Up to 5 hours
While not in use (standby) <sup>*1</sup>	Up to 11 days
While using the Clarity Booster feature (page 21)	Up to 3 hours

\*1 Handset is off the base unit or charger but not in use.

#### Note:

- Battery power is consumed whenever the handset is off the base unit or charger, even when the handset is not in use. The longer you leave the handset off the base unit or charger, the shorter you can actually talk on the handset. Actual battery performance depends on a combination of how often the handset is in use and how often it is not in use.
- Once the battery is fully charged, you do not have to charge it again until "Recharge battery" is displayed or  flashes. This will maximise the battery life.

## Battery replacement

If battery performance diminishes, make sure you have cleaned the charge contacts and fully charged the battery. The battery needs to be replaced if any of the following are displayed after a few phone calls even when you have fully charged the battery.

– "Recharge battery"

–  (flashing)

– "Charge for 6h"

– 

- Use only the rechargeable Panasonic battery noted on page 5.

- 1 Release the battery cover latch and lift the cover open.

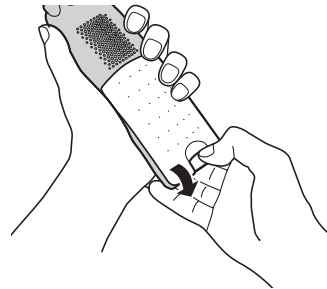

- 2 Replace the old battery with a new one, and close the cover (see page 11 for battery installation).

# Controls and displays

## Controls

### Base unit

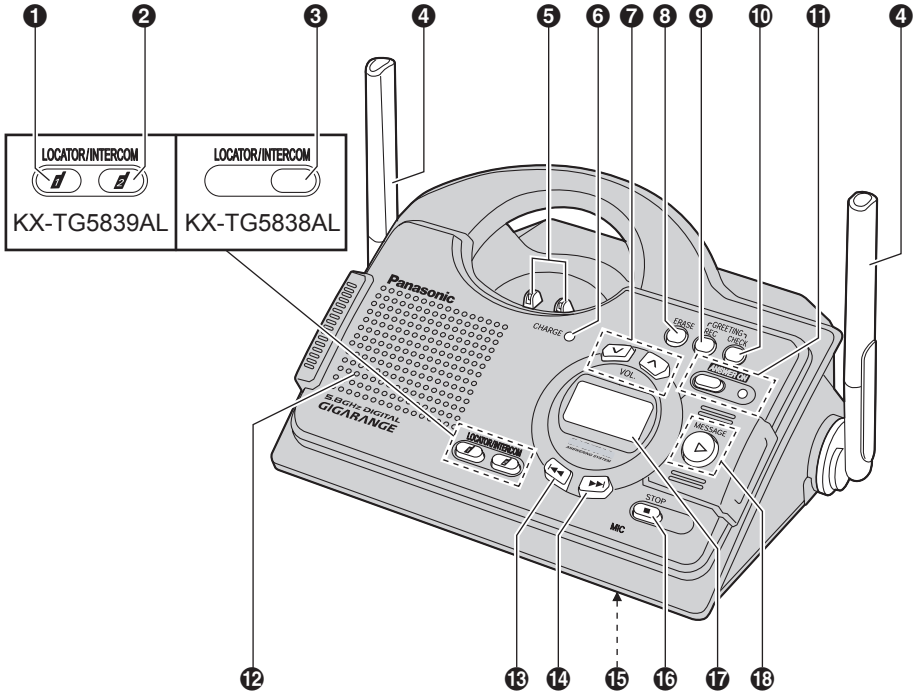

- 1 [LOCATOR/INTERCOM /]
- 2 [LOCATOR/INTERCOM /]
- 3 [LOCATOR/INTERCOM]
- 4 Antenna
- 5 Charge contacts
- 6 CHARGE indicator
- 7 VOL. (Volume) [V] [^]
- 8 [ERASE]
- 9 [GREETING REC] (Recording)
- 10 [GREETING CHECK]

- 11 [ANSWER ON]  
ANSWER ON indicator
- 12 Speaker
- 13 [◀◀] (Repeat)
- 14 [▶▶] (Skip)
- 15 MIC (Microphone)
- 16 [STOP]
- 17 Display
- 18 [MESSAGE]  
MESSAGE indicator

Handset

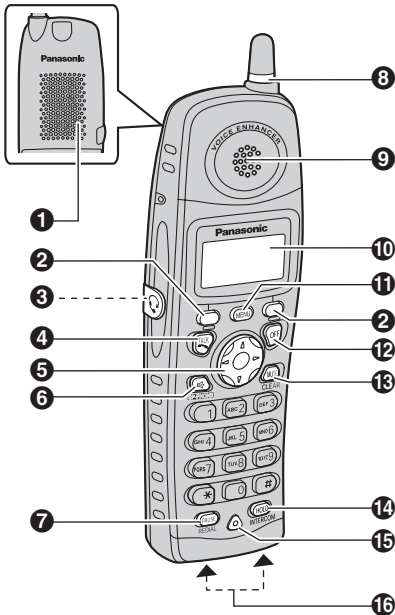

- 1 Speaker
- 2 Soft key
- 3 Headset jack
- 4 [ TALK ]
- 5 Navigator key
- 6 [ SP-PHONE ]
- 7 [ PAUSE ] [ REDIAL ]
- 8 Ringer indicator  
Message indicator
- 9 Receiver
- 10 Display
- 11 [ MENU ]
- 12 [ OFF ]
- 13 [ MUTE ] [ CLEAR ]
- 14 [ HOLD ] [ INTERCOM ]
- 15 Microphone
- 16 Charge contacts

Charger (KX-TG5839AL only)

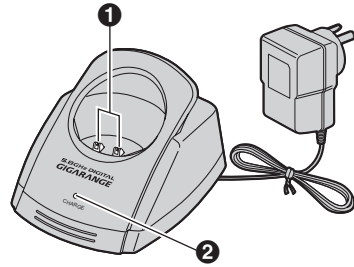

- 1 Charge contacts
- 2 CHARGE indicator

Using the navigator key

The handset navigator key can be used to navigate through menus and to select items shown on the display, by pressing [▲], [▼], [◀], or [▶].

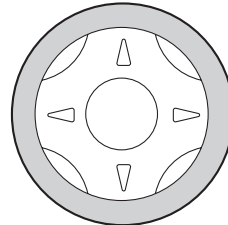

## Preparation

### Display

#### Base unit display items

Displayed item	Meaning
<b>FULL</b>	Flashes when message memory is full.
⌚	Flashes when the date and time need to be set.
<b>IN USE</b>	Base unit is on an intercom call, or handset is using the answering system. When flashing: base unit is paging or is being paged.
<b>LINE</b> <b>IN USE</b>	Line is in use. When flashing: a call is on hold or the answering system is answering a call. When flashing rapidly: a call is being received.
E	Greeting message recording error
☎	Answering system is in greeting only mode (caller messages will not be recorded).
H I	Handset number; displayed when paging or being paged. (example shown here: handset 1) <sup>*1</sup>

\*1 KX-TG5839AL only

#### Handset display items

Displayed item	Meaning
(((VE)))	Voice enhancer is on.
▢▢▢	Battery strength

### Soft keys

The handset features 2 soft keys. By pressing a soft key, you can select the function displayed directly above it.

- The functions displayed will vary depending on how you are using the unit.
- When a function does not appear above a soft key, the soft key has no function.

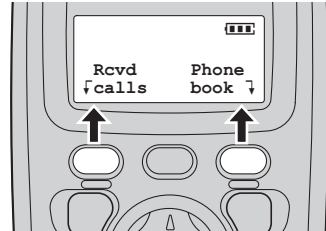

#### Soft key examples:

Display function	Action
Rcvd calls	Enters caller list
Conf	Establishes a conference call <sup>*1</sup>

\*1 KX-TG5839AL only

### Backlit display and handset keypad

The handset display and dialling buttons will light for a few seconds after pressing any of the handset's controls or lifting the handset off the base unit or charger. They will also light when a call is being received.



## Setting the date and time

Set the date and time so that the unit will announce the day and time each message was recorded by the answering system (page 42) when you play back messages.

**1** Press **[MENU]**.

**2** Scroll to "Date and time" by pressing **[▼]** or **[▲]**, then press **[▶]** or **[Select]**.

Date and time	
↓Back	Select↓

**3** Enter the current day, month, and year by selecting 2 digits for each.

Example: 15 June, 2005

Press **[1][5][0][6][0][5]**.

Date:	31.12.2005
Time:	12:00 AM
↓AM/PM	Save↓

**4** Enter the current hour and minute (12-hour clock format) by selecting 2 digits for each.

Example: 9:30 PM

Press **[0][9][3][0]**.

Date:	15.06.2005
Time:	12:00 AM
↓AM/PM	Save↓

**5** Select "AM" or "PM" by pressing **[AM/PM]**.

Date:	15.06.2005
Time:	09:30 AM
↓AM/PM	Save↓

**6** Press **[Save]**.

- When the date and time are set, ☹ disappears from the base unit display.
- If the handset beeps 3 times, the date and time were not set correctly. Enter the correct digits.

**7** Press **[OFF]**.

**Note:**

- If you make a mistake when entering the date and time, press **[◀]**, **[▶]**, **[▼]**, or **[▲]** to move the cursor, then make the correction.
- If a power failure occurs, ☹ will flash to indicate the date and time must be set again.

**To confirm the date and time**

Repeat steps 1 and 2. Press **[OFF]** when finished.

**Time adjustment (Caller ID subscribers only)**

When calls are received, Caller ID will automatically adjust the date and time (including daylight saving time).

- If you have not set the date and time manually, Caller ID will not adjust the date and time.
- You can turn this feature off (page 39).

## Making calls

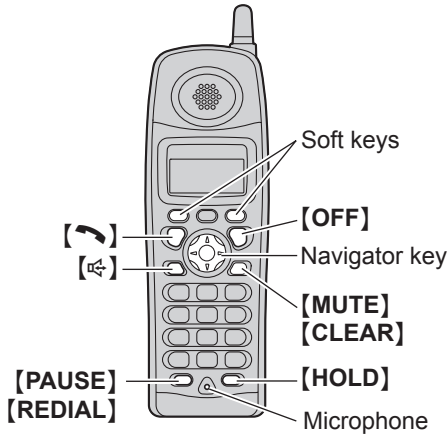

- 1 Lift the handset and press [📞].
  - "Talk" will be displayed.
- 2 Dial the phone number.
- 3 When finished talking, press [OFF] or place the handset on the base unit or charger.

### Note:

- "Line in use" is displayed when someone is talking on the other handset (KX-TG5839AL only) or another phone.

### To adjust the receiver volume

3 levels (high/medium/low) are available. While using the receiver, press [▼] or [▲] repeatedly.

### To use the speakerphone

- 1 Lift the handset and press [📞].
  - "SP-phone" will be displayed.
- 2 Dial the phone number.
- 3 When the other party answers, speak into the microphone.

- 4 When finished talking, press [OFF] or place the handset on the base unit or charger.

### Note:

- Talk alternately with the caller in a quiet room.
- If the other party has difficulty hearing you, press [▼] to decrease the speaker volume.
- While on a call, you can switch from the receiver to the speakerphone by pressing [📞]. To switch back to the receiver, press [📞].

### To adjust the speaker volume

6 levels (high to low) are available. While using the speaker, press [▼] or [▲] repeatedly.

### To dial after confirming the entered number

- 1 Enter the phone number.

Example:

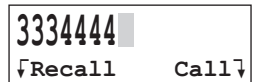

- To correct a digit, press [←] or [→] to move the cursor, then press [CLEAR]. Enter the correct number.
  - If a pause is required when dialling, press [PAUSE] where needed (page 21).
  - To cancel, press [OFF].
- 2 Press [📞], [📞], or [Call].
  - 3 When finished talking, press [OFF] or place the handset on the base unit or charger.

### To redial the last number dialled

- 1 Press [📞] or [📞].
- 2 Press [REDIAL].

### To make a call using the redial list

The last 5 phone numbers dialled are stored in the redial list.

- 1 Press **[REDIAL]**.
  - The last number dialled will be displayed.
- 2 Press **[▼]** or **[▲]** repeatedly to display the desired number.
  - To delete the displayed number, press **[CLEAR]**.
  - To exit the list, press **[OFF]**.
- 3 Press **[↶]**, **[☎]**, or **[Call]**.

## Answering calls

When a call is being received, the ringer indicator flashes rapidly.

- 1 Lift the handset and press **[↶]** or **[☎]**.
  - You can also answer a call by pressing any button except **[▼]**, **[▲]**, **[←]**, **[→]**, or **[OFF]**. (**Any key talk feature**)
- 2 When finished talking, press **[OFF]** or place the handset on the base unit or charger.

### Auto talk

This feature allows you to answer a call by simply lifting the handset off the base unit or charger. You do not need to press **[↶]**. To activate this feature, see page 36.

### Temporary ringer off

While the handset is ringing for an outside call, you can turn the ringer off temporarily by pressing **[OFF]**. The handset will ring the next time a call is received.

### Useful features during a call

#### HOLD button

This feature allows you to put an outside call on hold.

##### KX-TG5838AL:

Press **[HOLD]** during an outside call.

- “Hold” will be displayed.
- To return to the call, press **[↶]** or **[↷]**.

##### KX-TG5839AL:

**1** Press **[HOLD]** during an outside call.

- To transfer the call to the other handset, see page 32, step 2.

**2** Press **[HOLD]** again.

- “Hold” will be displayed.
- To return to the call, press **[↶]** or **[↷]**.
- The other handset user can take the call by pressing **[↶]** or **[↷]**.

#### Note:

- “Line on hold” will be displayed on the other handset (KX-TG5839AL only).
- If another phone is connected on the same line (page 10), you can also take the call by lifting its handset.
- If a call is kept on hold for more than 6 minutes, an alarm tone will start to sound and the ringer indicator will flash rapidly. After 4 additional minutes on hold, the call will be disconnected.

#### MUTE button

You can mute your voice during a conversation. While mute is turned on you will be able to hear the other party, but the other party will not be able to hear you.

To mute your voice, press **[MUTE]**.

Example: 

Talk 00-00-30 <Mute>
-------------------------

- “<Mute>” will flash on the display.
- To return to the conversation, press **[MUTE]**, **[↶]**, or **[↷]**.

#### Voice enhancer

This feature can simulate a band signal above the normal bandwidth limitations, achieving a sound which is close to the actual voice. You can turn this feature on or off, depending on the circumstance.

**1** Press **[MENU]** during an outside call.

**2** To turn this feature on or off, press **[3]**.

- You can also select “V.E. on” or “V.E. off” by pressing **[▼]** or **[▲]** then pressing **[▶]**.

▶3=V.E. on
------------

- When turned on, “**(VE)**” will be displayed.

#### Note:

- Once you turn voice enhancer on, it will be activated for all outside calls until turned off.
- You can also turn this feature on or off by programming (page 36).
- Depending on the condition and quality of your telephone line, this feature may emphasise existing line noise. If it becomes difficult to hear, turn this feature off.

## Clarity booster

This feature can improve sound clarity when the handset is used in an area where there may be interference. During an outside call, this feature will be turned on automatically when necessary. This feature will turn off when you hang up or put a call on hold. It will not turn off automatically during a call. You can also turn this feature on or off manually.

- 1 Press **[MENU]** during an outside call.
- 2 Press **[2]** to select "Booster on" or "Booster off".
  - You can also select "Booster on" or "Booster off" by pressing **[v]** or **[^]** then pressing **[>]**.

1=Phonebook ▶2=Booster on
------------------------------

- While this feature is turned on, "BOOST" will flash on the display.

### Note:

- If this feature is turned off manually during a call, it will not be turned on automatically during the same call.
- While this feature is turned on, battery operating time will be shortened (page 13).

## Call share (KX-TG5839AL only)

When the other handset is on an outside call, this feature allows you to join that call. To join a conversation, press **[↶]** or **[↷]** when the other handset is on an outside call.

- "Conference" will be displayed.

## PAUSE button (for PBX/long distance service users)

A pause is sometimes required when making calls using a PBX or long distance service.

For example, if you need to dial the line access number "9" when making outside calls with a PBX:

- 1 Press **[9]**.
- 2 Press **[PAUSE]**, then dial the phone number.

Example:

920555666777
↵Recall Call↵

- 3 Press **[↶]**, **[↷]**, or **[Call]**.

### Note:

- A 3.5 second pause is inserted each time **[PAUSE]** is pressed. Press repeatedly to insert longer pauses.

## Recall button

Pressing **[Recall]** allows you to use special features of your host PBX such as transferring an extension call, or accessing optional telephone services such as Call Waiting.

Example:

Talk
00-00-20
↵Recall

### Note:

- To change the recall time, see page 37.

## Using the phonebook

The handset phonebook allows you to make calls without having to dial manually. You can add 50 names and phone numbers to the handset phonebook and search for phonebook entries by name.

### Adding items to the phonebook

**1** Press **[Phonebook]**.



**2** Press **[Add]**.

- The display shows the number of items in the phonebook.

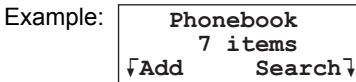

**3** Enter the name (max. 16 characters). See the character table for entry.

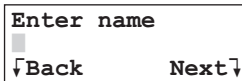

**4** Press **[Next]**.

**5** Enter the phone number (max. 32 digits).

- If a pause is required when dialling, press **[PAUSE]** where needed (page 21).



**6** Press **[Next]**.

- If you want to change the name and number, press **[Edit]**, then repeat from step 3.

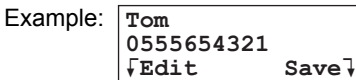

**7** Press **[Save]**.

- To add other items, repeat from step 2.

**8** Press **[OFF]**.

**Note:**

- Caller ID subscribers can use ringer ID and light-up ID features (page 26).

### To store emergency numbers

Emergency numbers are numbers stored in the phonebook that can be dialled using the phonebook even when dial lock is turned on (page 38).

To store a number as an emergency number, add # at the beginning of the name (see "Adding items to the phonebook").

### Character table

The dial keys can be used to enter characters. To enter a character, press the appropriate dial key, repeatedly if necessary. To enter another character that is located on the same dial key, first press **[▶]** to move the cursor to the next space.

Key	Characters
[1]	& ' ( ) , - . / 1
[2]	a b c A B C 2
[3]	d e f D E F 3
[4]	g h i G H I 4
[5]	j k l J K L 5
[6]	m n o M N O 6
[7]	p q r s P Q R S 7
[8]	t u v T U V 8
[9]	w x y z W X Y Z 9
[0]	0 Space
[*]	*
[#]	#
[CLEAR]	To delete a character or number

**To edit/correct a mistake**

Press [◀] or [▶] to move the cursor to the character or number you wish to erase, then press [CLEAR]. Enter the appropriate character or number.

**Note:**

- Press and hold [CLEAR] to erase all characters or numbers.

**Calling someone in the phonebook**

Phonebook items can be searched for alphabetically by scrolling through the phonebook items.

- 1 Press [Phonebook].
  - For quick search, you can skip to step 3.

- 2 Press [Search].

0-9=Name search  
▼▲=Scroll list

- 3 Press [▼] or [▲] repeatedly to display the desired item.
  - To exit the phonebook, press [OFF].

- 4 Press [↶] or [↷].

**Note:**

- To view a phone number over 16 digits long, follow steps 1 to 3, then press [Edit] and [Next]. Press [OFF] when finished.

**To search for a name by initial**

- 1 Press [Phonebook], then press [Search].
- 2 Press the dialling button ([0] to [9], [⊞], or [✳]) which corresponds to the first letter you are searching for (see the character table, page 22).  
Example: "LISA"  
Press [5] repeatedly to display any name with the initial "L".

- If there is no item corresponding to the letter you selected, the next item will be displayed.

- 3 Press [▼] repeatedly to display the desired item.
  - To exit the phonebook, press [OFF].
  - To dial the displayed number, press [↶] or [↷].

**Editing items in the phonebook**

- 1 Press [Phonebook], then press [Search].
- 2 Press [▼] or [▲] repeatedly to display the desired item.
- 3 Press [Edit].
- 4 Edit the name if necessary. See the character table on page 22 for character entry.
- 5 Press [Next].
- 6 Edit the phone number if necessary.
- 7 Press [Next], then press [Save].
  - To edit other items, repeat from step 2.
- 8 Press [OFF].

**Erasing items in the phonebook**

- 1 Press [Phonebook], then press [Search].
- 2 Press [▼] or [▲] repeatedly to display the desired item.
- 3 Press [CLEAR].
- 4 Press [Yes].
  - To cancel erasing, press [No].
  - To erase other items, repeat from step 2.
- 5 Press [OFF].

### Chain dial feature

This feature allows you to dial phone numbers from the phonebook while you are on a call.

Example: Using a long distance calling card

- ① Dial from the phonebook:  
18000123456 (Calling card access number).
- ② When prompted, dial from the phonebook:  
1234 (Calling card PIN).
- ③ When prompted, dial from the phonebook:  
15550123456 (the person you want to call).

**1** During an outside call, press **[MENU]**.

**2** Press **[1]** to select "Phonebook".

**3** Press **[▼]** or **[▲]** repeatedly to display the desired item.

**4** Press **[Call]**.

- Repeat from step 1 to dial other numbers.

#### Note:

- When storing a calling card access number and your PIN in the phonebook as one phonebook item, press **[PAUSE]** to add pauses after the number and PIN as necessary (page 21).

## Copying phonebook items (KX-TG5839AL only)

You can copy one or all of the phonebook items of one handset to the phonebook of the other handset.

#### Important:

- Make sure the destination handset is not in use.
- Do not place your handset on the base unit or charger until copying has finished, otherwise copying will stop.
- If an outside call is received during the phonebook copy, copying will stop. You will need to copy the item(s) later.
- Ringer ID and light-up ID settings for phonebook items are not copied (page 26).

### Copying an item

**1** Press **[MENU]**.

**2** Scroll to "Copy phonebook" by pressing **[▼]** or **[▲]**, then press **[▶]**.

**3** Scroll to "Copy 1 item" by pressing **[▼]** or **[▲]**, then press **[▶]**.

**4** Press **[▼]** or **[▲]** repeatedly to display the desired item.

- To search for the item by initial, see page 23.

**5** Press **[Send]**.

- When the item has been copied, "Complete" will be displayed.
- The destination handset display will show "Phonebook Receiving", then "Phonebook Received".
- To copy another item, repeat from step 4.

**6** Press **[OFF]**.



---

## **Copying all items**

- 1** Press **[MENU]**.
- 2** Scroll to "Copy phonebook" by pressing **[▼]** or **[▲]**, then press **[▶]**.
- 3** Scroll to "Copy all items" by pressing **[▼]** or **[▲]**, then press **[▶]**.
  - When all items have been copied, "Complete" will be displayed.
  - The destination handset display will show "Phonebook Receiving", then "Phonebook Received".
- 4** Press **[OFF]**.

---

### Using Caller ID service

This unit is Caller ID compatible. To use Caller ID features, you must subscribe to your telephone company's Caller ID service.

---

#### Caller ID features

When an outside call is being received, the calling party's phone number will be displayed.

Phone numbers for the last 50 different callers will be logged in the caller list, allowing you to return missed calls. Caller information is stored by the most recent call to the oldest.

- When Caller ID information is received and it matches a phone number stored in the phonebook:
  - The stored name will be displayed and logged in the caller list. (**Private name display**)
  - The handset will use the ringer tone and the ringer indicator colour you assigned to the caller. (**Ringer ID and light-up ID**)
- While listening to a message recorded by the answering system, using the handset, you can call back the caller without having to dial the phone number (page 46).
- If the unit cannot receive caller information, the following will be displayed:
  - "**Out of area**": The caller dialled from an area which does not provide Caller ID service.
  - "**Private caller**": The caller requested not to send caller information.
- If the unit is connected to a PBX system, caller information may not be received properly. Consult your PBX supplier.
- If the name display service is available in your area, the display will show callers' names. For further information, please contact your telephone company.

---

### Call waiting and Caller ID compatible

If you subscribe to Caller ID service, your handset displays the 2nd caller's information while talking. After you hear a call waiting tone, the caller's phone number will be displayed.

You can answer the 2nd call, keeping the 1st call on hold.

Follow Telstra or your service provider instructions using [**Recall**].

- If the phone number is stored in the phonebook with its name, the caller's name will also be displayed.
- Please contact Telstra or your service provider for details and availability in your area.

---

#### For Caller ID Type II users

When you receive a 2nd call during a conversation, you will hear a signal tone following the call waiting tone and the **conversation will be interrupted or muted for a short period of time**. This is not fault of the product as these events are normal.

- The tones are generated by the telephone company.

---

#### Ringer ID and light-up ID

This feature can help you identify who is calling by using different ringers and ringer indicator colours for different callers stored in the phonebook. You can assign a different ringer and indicator colour to each phonebook item. When a call is received from a caller stored in the phonebook, the ringer and indicator colour are used after Caller ID information is displayed.

- The ringer and indicator colour may be changed after the 2nd ring.

---

#### Ringer ID

You can assign a different ringer tone to each caller in the phonebook. If you select "**No Ringer ID**", the unit will use the

ringer tone you set on page 35 when a call is received from that caller. The default setting is "No Ringer ID".

- 1 Press **[Phonebook]**, then press **[Search]**.
- 2 Press **[v]** or **[^]** repeatedly to display the desired item.
- 3 Press **[Option]**.
- 4 Press **[1]** to select "Ringer ID".
- 5 Press **[v]** or **[^]** repeatedly to select the desired ringer tone.
  - You can also select the ringer tone by pressing **[1]** to **[7]**, or **[0]** ("No Ringer ID").
- 6 Press **[Save]**, then press **[OFF]**.

#### Light-up ID

You can assign a different ringer indicator colour to each caller in the phonebook. Select "Color1-Default" (Amber), "Color2" (Green), "Color3" (Red), or "Multicolor".

- 1 Press **[Phonebook]**, then press **[Search]**.
- 2 Press **[v]** or **[^]** repeatedly to display the desired item.
- 3 Press **[Option]**.
- 4 Press **[2]** to select "Light-up ID".
- 5 Press **[v]** or **[^]** repeatedly to select the desired ringer indicator colour.
  - You can also select the colour by pressing **[1]** to **[4]**.
- 6 Press **[Save]**, then press **[OFF]**.

## Caller list

Caller information for the last 50 different callers will be logged in the caller list. You can use this list to return missed calls.

- Caller information includes phone numbers, the date and time of calls, and the number of times the caller called.

#### Missed calls

If a call is not answered, the unit treats the call as a missed call. The number of missed calls is shown on the handset display. This lets you know if you should view the caller list to see who called while you were out.

Example: Handset off the base unit or charger

10 missed calls	
Rcvd	Phone
↓ calls	book ↓

#### Note:

- When the unit has new messages, "New message" will be displayed in place of "missed calls".

## Viewing the caller list and calling back

- 1 Press **[v]** or **[^]** to enter the caller list.
- 2 Press **[v]** to search from the most recent call, or press **[^]** to search from the oldest call.
  - To exit the caller list, press **[OFF]**.
- 3 Press **[↶]** or **[↷]**.

#### Note:

- You can also press **[Rcvd calls]** to enter the caller list.
- Calling back will not be possible if the caller information does not include a phone number.
- In some cases, you may have to edit the number before dialling.

## Caller ID Service

- If the caller's name and phone number are stored in the phonebook, the caller's name and phone number are displayed alternately.

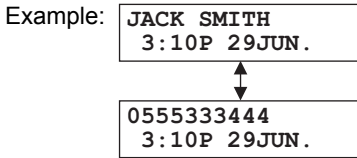

- If an arrow (→) is displayed after the number, the whole phone number will not be shown. Press **[\*]** to see the remaining numbers or to return to the previous display. Each time you press **[\*]**, the display will change alternately.

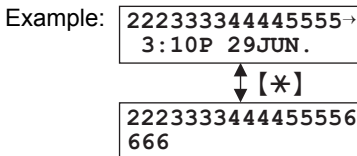

- KX-TG5839AL only:  
Each handset has its own caller list. If you viewed the caller list or answered a call on one handset, the same information in the other handset will be displayed as "missed calls".

### Displayed symbols

- If the same caller calls more than once, it will be displayed with the number ("x2" to "x9"). Only the date and time of the most recent call will be stored.
- A ✓ is displayed next to items which have already been viewed or answered on this handset.

## Editing a caller's phone number before calling back

You can edit a phone number in the caller list.

- 1 Press **[▼]** or **[▲]** to enter the caller list.
- 2 Press **[▼]** or **[▲]** repeatedly to display the desired item.
- 3 Press **[Edit]**.
- 4 Add or erase digits to the beginning of the number as necessary.
  - To add a digit, press the desired dial key.
  - To erase a digit, press **[CLEAR]** or **[#]**.
- 5 Press **[↶]** or **[↷]** to call back.

### Note:

- The edited phone number will not be saved in the caller list.

## Storing caller information into the phonebook

Items in the caller list can be stored into each handset's phonebook.

- 1 Press **[▼]** or **[▲]** to enter the caller list.
- 2 Press **[▼]** or **[▲]** repeatedly to display the desired item.
  - To edit the number, press **[Edit]**, then edit the number (see "Editing a caller's phone number before calling back", step 4).
- 3 Press **[Save]**.
  - "Enter name" will be displayed.
  - If the caller has name information, the name and phone number will be saved. Skip to step 6.
- 4 Enter the name if necessary (see page 22, step 3).
- 5 Press **[Next]**, then press **[Save]**.

- To continue storing other items, repeat from step 2.

**6** Press **[OFF]**.

**Note:**

- If the caller information does not include a phone number, you cannot store it in the phonebook.

---

## Erasing caller information

---

### Erasing a selected item

- 1** Press **[▼]** or **[▲]** to enter the caller list.
- 2** Press **[▼]** or **[▲]** repeatedly to display the desired item.
- 3** Press **[CLEAR]**.
  - To erase other items, repeat from step 2.
  - To exit the caller list, press **[OFF]**.

---

### Erasing all items

Make sure that you have no missed calls.

- 1** Press **[▼]** or **[▲]** to enter the caller list.
- 2** Press **[All erase]**.
  - To cancel erasing, press **[No]**.
- 3** Press **[Yes]**.

---

### Intercom

Intercom calls can be made between a handset and the base unit (and between 2 handsets, KX-TG5839AL only).

**Note:**

- If you have difficulty hearing the other party while using the speaker, decrease the speaker volume.
- If you receive a phone call while talking on the intercom, you will hear 2 tones (page 35). To answer the call, press **[OFF]**, then press **[↶]** or **[↷]**.
- You cannot change the ringer tone for intercom calls.

---

### For KX-TG5838AL users

---

#### From the handset to the base unit

**1 Handset:**

Press **[INTERCOM]**.

- The base unit will beep for 1 minute.
- To stop paging, press **[OFF]**.

**2 Base unit:**

Press **[LOCATOR/INTERCOM]** to answer the page.

**3 Handset:**

When finished talking, press **[OFF]**.

**Note:**

- During an intercom call, the handset user can switch to the speaker by pressing **[↷]**. To switch back to the receiver, press **[↶]**.
- To adjust the base unit's speaker volume, press **[∧]** or **[∨]** repeatedly. 8 levels (high to low) are available.

---

#### From the base unit to the handset

**1 Base unit:**

Press **[LOCATOR/INTERCOM]**.

- The handset will beep for 1 minute.
- To stop paging, press **[LOCATOR/INTERCOM]**.

**2 Handset:**

Press **[↶]**, **[↷]**, or **[INTERCOM]** to answer the page.

**3 Base unit:**

When the paged party answers, speak into the MIC.

**4 Base unit:**

When finished talking, press **[LOCATOR/INTERCOM]**.

**Note:**

- You can locate a misplaced handset by paging it. (**Handset locator**)

### For KX-TG5839AL users

Call the desired unit by selecting the extension number, shown in the upper right of each handset's display. The base unit's extension number is 0.

- To confirm the handset's extension number ([1] or [2]), place the handset on the base unit or charger.
- The base unit will display the paging or paged handset number (*H 1* or *H 2*).

### From the handset to the base unit

#### 1 Handset:

Press **[INTERCOM]**, then press **[0]**.

- You can also select the base unit by pressing **[▼]** or **[▲]** then pressing **[▶]**.
- The base unit will ring for 1 minute.
- To stop paging, press **[OFF]**.

#### 2 Base unit:

Press either **[LOCATOR/INTERCOM ⚡]** or **[LOCATOR/INTERCOM ⚡]** to answer the page.

#### 3 Handset:

When finished talking, press **[OFF]** or place the handset on the charger.

#### Note:

- During an intercom call, the handset user can switch to the speaker by pressing **[📞]**. To switch back to the receiver, press **[📞]**.
- To adjust the base unit's speaker volume, press **[▲]** or **[▼]** repeatedly. 8 levels (high to low) are available.

### From the base unit to a handset

#### 1 Base unit:

Press **[LOCATOR/INTERCOM ⚡]** or **[LOCATOR/INTERCOM ⚡]**.

- The handset will beep for 1 minute.
- To stop paging, press either **[LOCATOR/INTERCOM ⚡]** or **[LOCATOR/INTERCOM ⚡]**.

#### 2 Handset:

Press **[📞]**, **[📞]**, or **[INTERCOM]** to answer the page.

#### 3 Base unit:

When the paged party answers, speak into the MIC.

#### 4 Base unit:

When finished talking, press either **[LOCATOR/INTERCOM ⚡]** or **[LOCATOR/INTERCOM ⚡]**.

#### Note:

- You can locate a misplaced handset by paging it. (**Handset locator**)

### From one handset to the other handset

Example: When handset 1 calls handset 2.

#### 1 Handset 1:

Press **[INTERCOM]**, then press the other handset number **[2]**.

- You can also select the handset by pressing **[▼]** or **[▲]** then pressing **[▶]**.
- The paged handset will beep for 1 minute.
- To stop paging, press **[OFF]**.

#### 2 Handset 2:

Press **[📞]**, **[📞]**, or **[INTERCOM]** to answer.

- 3 When finished talking, press **[OFF]** or place the handset on the base unit or charger.

### Transferring a call (KX-TG5839AL only)

Outside calls can be transferred from one handset to the other.

- 1 During an outside call, press **[INTERCOM]**.
  - The call will be put on hold.
- 2 To page the other handset, press **[handset[1]]** or **[handset[2]]**.
- 3 Wait for the paged party to answer.
  - The paged handset user can answer by pressing **[📞]**, **[📞]**, or **[INTERCOM]**.
  - If there is no answer, press **[📞]** or **[📞]** to return to the outside call.
- 4 To complete the transfer, press **[OFF]**.

### Transferring a call without speaking to the paged party

- 1 During an outside call, press **[INTERCOM]**, then press **[handset[1]]** or **[handset[2]]**.
- 2 Press **[OFF]**.
  - The outside call rings at the other handset.

#### Note:

- If the paged party does not answer the call, press **[📞]** or **[📞]** to return to the call. If not answered within 1 minute, the call will ring at your handset again. If you still do not answer the call within 4 minutes, the call will be disconnected.

### Conference calls (KX-TG5839AL only)

A conference call allows 2 handsets to speak together with an outside party.

- 1 During an outside call, press **[INTERCOM]**.
  - The call will be put on hold.
- 2 To page the other handset, press **[handset[1]]** or **[handset[2]]**.
- 3 When the paged party answers, press **[Conf]** on your handset to establish a conference call.
  - “**Conference**” will be displayed.
  - To leave the conference, press **[OFF]**. The other 2 parties can continue the conversation.

#### Note:

- The outside call can be put on hold by pressing **[HOLD]** during a conference call. Communications between extensions are not suspended. Only the person who placed the call on hold can resume the conference by pressing **[Conf]**.



## Guide to handset programming

For your reference, a chart of all programmable functions is printed below. Details for each item can be found on the corresponding pages. To programme, press **[MENU]**, press **[▼]** or **[▲]** to scroll through the menu, and press **[▶]** or **[Select]** when the desired menu item or setting is displayed.

**Important:**

- Before programming, make sure the handset and base unit are not being used. The handset must be operated near the base unit and while off the base unit or charger.

Main menu	Sub-menu 1	Sub-menu 2	Page
Message play	–	–	page 45
Ringer setting	Ringer volume	–	page 34
	Ringer tone	–	page 35
	Interrupt tone	–	page 35
Date and time <sup>*1</sup>	–	–	page 17
Voice enhancer	–	–	page 36
Dial lock <sup>*1</sup>	–	–	page 38
Copy phonebook <sup>*2</sup>	Copy 1 item	–	page 24
	Copy all items	–	page 25
Initial setting	Set answering	Ring count <sup>*1</sup>	page 49
		Recording time <sup>*1</sup>	page 50
		Remote code <sup>*1</sup>	page 48
	Message alert	–	page 50
	LCD contrast	–	page 36
	Key tone	–	page 38
	Auto talk	–	page 36
	Set area code	–	page 37
	Time adjustment <sup>*1</sup>	–	page 39
	Set tel line	Set dial mode <sup>*1</sup>	page 58
		Set recall time <sup>*1</sup>	page 37
		Set line mode <sup>*1</sup>	page 37
	Registration	–	page 38

\*1 If you programme these settings using one of the handsets, you will not need to programme the same item using the other handset (KX-TG5839AL only).

\*2 KX-TG5839AL only

**Note:**

- To exit programming, press **[OFF]** at any time.

- To go back to the previous menu, press [**←**] or [**Back**], or press [**▶**] or [**Select**] while “(Go back)” is displayed.

## Ringer settings

### Handset ringer volume

4 levels (high/medium/low/off) are available. The default setting is HIGH.

- 1 Press [**MENU**].
- 2 Scroll to “Ringer setting” by pressing [**▼**] or [**▲**], then press [**▶**].

Ringer setting

- 3 Scroll to “Ringer volume” by pressing [**▼**] or [**▲**], then press [**▶**].

Ringer volume

- 4 Press [**▼**] or [**▲**] repeatedly to select the desired volume.

Ringer volume  
Low ■■■■■■ High  
↓Back ▼▲ Save↓

- To turn the ringer off, press [**▼**] repeatedly until “off ?” is displayed.

- 5 Press [**Save**].

### Note:

- When the ringer volume is set to off, the handset will display “Ringer off”, and will not ring for outside calls. The handset will ring at the low level for intercom calls.

## Handset ringer tone

You can change the ringer tone heard when an outside call is received. There are 3 tones and 4 melodies. The default setting is "Tone 1".

- 1 Press **[MENU]**.
- 2 Scroll to "Ringer setting" by pressing **[▼]** or **[▲]**, then press **[▶]**.

Ringer setting

- 3 Scroll to "Ringer tone" by pressing **[▼]** or **[▲]**, then press **[▶]**.

Ringer tone

- 4 Press **[▼]** or **[▲]** repeatedly to select the desired setting.

Ringer tone  
1=Tone 1  
↓Back ▼▲ Save↓

- You can also select the ringer tone by pressing **[1]** to **[7]**.
- If the ringer volume has been turned off, the handset will not ring.

- 5 Press **[Save]**, then press **[OFF]**.

### Note:

- If you select one of the melody ringer patterns, the ringer will continue to sound for several seconds if:
  - the caller hangs up before you answer the call.
  - another person answers the call using another phone connected on the same line.

## Handset interrupt tone

This tone lets you know when you receive a call while you are on an intercom call (page 30).

"2" (default): The tone will sound 2 times.  
 "on": The tone will sound for as long as the line rings.  
 "off": Turns this feature off.

- 1 Press **[MENU]**.
- 2 Scroll to "Ringer setting" by pressing **[▼]** or **[▲]**, then press **[▶]**.
- 3 Scroll to "Interrupt tone" by pressing **[▼]** or **[▲]**, then press **[▶]**.
- 4 Press **[▼]** or **[▲]** repeatedly to select the desired setting.
- 5 Press **[Save]**, then press **[OFF]**.

---

### Call options

---

#### Auto talk

When this feature is turned on, you can answer a call by lifting the handset off the base unit or charger without pressing [↵]. The default setting is OFF.

- 1 Press [MENU].
- 2 Scroll to "Initial setting" by pressing [▼] or [▲], then press [▶].
- 3 Scroll to "Auto talk" by pressing [▼] or [▲], then press [▶].
- 4 Press [▼] or [▲] repeatedly to select "On" or "Off".
- 5 Press [Save], then press [OFF].

#### Note:

- If you subscribe to Caller ID service and want to view the caller's information on the handset display after lifting up the handset to answer a call, turn off this feature.

---

### Voice enhancer

You can turn the voice enhancer feature on or off. The default setting is OFF.

- 1 Press [MENU].
- 2 Scroll to "voice enhancer" by pressing [▼] or [▲], then press [▶].
- 3 Press [▼] or [▲] repeatedly to select "On" or "Off".
- 4 Press [Save], then press [OFF].
  - When turned on, "((VE))" will be displayed.

---

### Display options

---

#### Handset LCD contrast

You can adjust the handset display contrast. There are 6 levels. The default setting is level 3.

- 1 Press [MENU].
- 2 Scroll to "Initial setting" by pressing [▼] or [▲], then press [▶].
- 3 Scroll to "LCD contrast" by pressing [▼] or [▲], then press [▶].
- 4 Press [▼] or [▲] repeatedly to select the desired setting.
- 5 Press [Save], then press [OFF].

---



---

## Telephone settings

---

### Recall time

The recall time depends on your telephone exchange or host PBX.

You can select: "90ms" (milliseconds), "100ms" (default), "110ms", "250ms", "300ms", "400ms", "600ms", or "700ms".

- 1 Press **[MENU]**.
- 2 Scroll to "Initial setting" by pressing **[▼]** or **[▲]**, then press **[▶]**.
- 3 Scroll to "Set tel line" by pressing **[▼]** or **[▲]**, then press **[▶]**.
- 4 Scroll to "Set recall time" by pressing **[▼]** or **[▲]**, then press **[▶]**.
- 5 Press **[▼]** or **[▲]** repeatedly to select the desired setting.
- 6 Press **[Save]**, then press **[OFF]**.

#### Note:

- You can access Telstra's "EASY CALL" service by having the recall time set at 100 ms, and then follow Telstra's "EASY CALL" instructions to operate this service.
- If the unit is connected via a PBX, certain PBX functions (call transferring, etc.) may not work correctly. Consult your PBX supplier for the correct setting.

---

### Line mode

The line mode is preset to "B" and generally should not be adjusted. If "Line in use" on the handset is not displayed properly, the line mode selection is incorrect. Set line mode to "A".

- 1 Press **[MENU]**.
- 2 Scroll to "Initial setting" by pressing **[▼]** or **[▲]**, then press **[▶]**.

- 3 Scroll to "Set tel line" by pressing **[▼]** or **[▲]**, then press **[▶]**.
- 4 Scroll to "Set line mode" by pressing **[▼]** or **[▲]**, then press **[▶]**.
- 5 Press **[▼]** or **[▲]** repeatedly to select the desired setting.
- 6 Press **[Save]**, then press **[OFF]**.

---

### Storing your area code

We recommend storing your area code before using Caller ID (page 26). Calls from the same area will be recorded in the caller list without the area code. You do not have to remove it before calling back the caller or storing in the phonebook.

- 1 Press **[MENU]**.
- 2 Scroll to "Initial setting" by pressing **[▼]** or **[▲]**, then press **[▶]**.
- 3 Scroll to "Set area code" by pressing **[▼]** or **[▲]**, then press **[▶]**.
- 4 Enter your area code (max. 8 digits).
  - To correct a digit, press **[←]** or **[→]** to move the cursor, then press **[CLEAR]**. Enter the correct number.
- 5 Press **[Save]**, then press **[OFF]**.

---

### To erase your area code

Press and hold **[CLEAR]** in step 4, press **[Save]**, then press **[OFF]**.

---

### Other options

---

#### Dial lock

This feature prohibits making outside calls. The default setting is OFF.

#### Important:

- When dial lock is turned on, only phone numbers stored in the phonebook as emergency numbers (numbers stored with a # at the beginning of the name) can be dialled using the phonebook (page 22). We recommend storing emergency numbers in the phonebook before using this feature.
- When dial lock is turned on, you cannot store, edit, or erase items in the phonebook.

---

#### To turn dial lock on

- 1 Press **[MENU]**.
- 2 Scroll to "Dial lock" by pressing **[▼]** or **[▲]**, then press **[▶]**.
- 3 Enter a 4-digit password.
  - This password is required when turning dial lock off. We recommend writing the password down.
- 4 Press **[Save]**.
- 5 Press **[Yes]**.
  - "Dial lock on" will be displayed.
- 6 Press **[OFF]**.

#### Note:

- If dial lock is turned on, the handset displays "Dial lock". While there are missed calls, "Dial lock" is not displayed.

---

#### To turn dial lock off

- 1 Press **[MENU]**.
- 2 Scroll to "Dial lock" by pressing **[▼]** or **[▲]**, then press **[▶]**.
- 3 Enter the same password that was entered when dial lock was turned on.
- 4 Press **[Save]**.
- 5 Press **[Yes]**.
  - "Dial lock off" will be displayed.
- 6 Press **[OFF]**.

#### Note:

- If you forget the password, consult your nearest Panasonic service centre.

---

#### Handset key tone

You can select whether or not key tones are heard when keys are pressed. Includes confirmation tones and error tones. The default setting is ON.

- 1 Press **[MENU]**.
- 2 Scroll to "Initial setting" by pressing **[▼]** or **[▲]**, then press **[▶]**.
- 3 Scroll to "Key tone" by pressing **[▼]** or **[▲]**, then press **[▶]**.
- 4 Press **[▼]** or **[▲]** repeatedly to select "On" or "Off".
- 5 Press **[Save]**, then press **[OFF]**.

---

#### Re-registering the handset

If "No link to base. Move closer to base, try again." is displayed even when the handset is near the base unit, you may need to re-register the handset to the base unit.

#### Important:

- Make sure the base unit is not being used.

- Have the handset and base unit near each other when re-registering the handset.
- KX-TG5839AL only:  
Confirm the extension number of the handset which has lost the communication by placing the handset on the base unit or charger.  
If you re-register the handset using the other handset's extension number [1] or [2], the other handset will not function.

### 1 Handset:

Press **[MENU]**.

**2** Scroll to "Initial setting" by pressing **[▼]** or **[▲]**, then press **[▶]**.

**3** Scroll to "Registration" by pressing **[▼]** or **[▲]**, then press **[▶]**.

### 4 KX-TG5838AL base unit:

Press and hold **[LOCATOR/INTERCOM]** until the CHARGE indicator flashes.

#### KX-TG5839AL base unit:

Press and hold the locator/intercom button that corresponds to the handset you want to re-register (**[LOCATOR/INTERCOM 1]** or **[LOCATOR/INTERCOM 2]**) until the registering handset number (*H 1* or *H 2*) is displayed.

- After the CHARGE indicator starts flashing, the rest of the procedure must be completed within 1 minute.

### 5 Handset:

Press **[OK]**, then wait until the handset beeps.

- Registration is complete.

## Time adjustment (Caller ID subscribers only)

Using this feature, the unit's date and time setting will be automatically adjusted when caller information is received. To turn this feature on, select "Caller ID [auto]" (default). To turn off, select "Manual".

**1** Press **[MENU]**.

**2** Scroll to "Initial setting" by pressing **[▼]** or **[▲]**, then press **[▶]**.

**3** Scroll to "Time adjustment" by pressing **[▼]** or **[▲]**, then press **[▶]**.

**4** Press **[▼]** or **[▲]** repeatedly to select "Manual" or "Caller ID [auto]".

**5** Press **[Save]**, then press **[OFF]**.

### Note:

- To use this feature, set the date and time manually first (page 17).

### Programming via direct commands

You can also programme most features using “direct commands”—special codes that take you directly to the feature you wish to programme and allow you to select the desired setting. There is no need to scroll through the unit’s menus.

Details of each feature can be found on the corresponding pages.

- 1** Press **[MENU]**.
- 2** Enter the desired feature code (shown below).
- 3** Enter the desired setting code (shown below).
  - This step may vary depending on the feature being programmed.
- 4** Press **[Save]**.
- 5** Press **[OFF]** to exit programming mode.

---

#### Direct commands chart

Feature	Feature code	Setting code	Page
Ringer volume	<b>[1] [1]</b>	<b>[1]</b> : Low <b>[2]</b> : Medium <b>[3]</b> : High <b>[0]</b> : Off	page 34
Ringer tone	<b>[1] [2]</b>	<b>[1]–[3]</b> : Tone pattern 1–3 <b>[4]–[7]</b> : Melody pattern 1–4	page 35
Interrupt tone	<b>[1] [3]</b>	<b>[1]</b> : On <b>[2]</b> : 2 times <b>[0]</b> : Off	page 35
Message play	<b>[2]</b>	–	page 45
Date and time	<b>[4]</b>	Go to step 3 on page 17.	page 17
Voice enhancer	<b>[5]</b>	<b>[1]</b> : On <b>[0]</b> : Off	page 36
Dial lock	<b>[6]</b>	Go to step 3 on page 38.	page 38
LCD contrast	<b>[0] [1]</b>	<b>[1]–[6]</b> : Level 1–6	page 36
Key tone	<b>[0] [2]</b>	<b>[1]</b> : On <b>[0]</b> : Off	page 38
Auto talk	<b>[0] [3]</b>	<b>[1]</b> : On <b>[0]</b> : Off	page 36
Set area code	<b>[0] [4]</b>	Go to step 4 on page 37.	page 37
Set dial mode	<b>[0] [5] [1]</b>	–	page 58
Set recall time	<b>[0] [5] [2]</b>	<b>[1]</b> : 700 ms <b>[2]</b> : 600 ms <b>[3]</b> : 400 ms <b>[4]</b> : 300 ms <b>[5]</b> : 250 ms <b>[6]</b> : 110 ms <b>[7]</b> : 100 ms <b>[8]</b> : 90 ms	page 37
Set line mode	<b>[0] [5] [3]</b>	<b>[1]</b> : A <b>[2]</b> : B	page 37
Ring count	<b>[0] [6] [1]</b>	<b>[2]–[7]</b> : 2–7 rings <b>[0]</b> : Toll saver	page 49



Feature	Feature code	Setting code	Page
Recording time	<b>[0] [6] [2]</b>	<b>[1]</b> : 1 minute <b>[2]</b> : 2 minutes <b>[3]</b> : 3 minutes <b>[0]</b> : Greeting only	page 50
Remote code	<b>[0] [6] [3]</b>	Go to step 5 on page 48.	page 48
Time adjustment	<b>[0] [9]</b>	<b>[1]</b> : Caller ID[auto] <b>[0]</b> : Manual	page 39
Handset registration	<b>[0] [0]</b>	Go to step 4 on page 38.	page 38
Message alert	<b>[0] [≡]</b>	<b>[1]</b> : On <b>[0]</b> : Off	page 50
Copy phonebook (1 item) <sup>*1</sup>	<b>[≡] [1]</b>	Go to step 4 on page 24.	page 24
Copy phonebook (all items) <sup>*1</sup>	<b>[≡] [2]</b>	–	page 25

\*1 KX-TG5839AL only

**Note:**

- If you make a mistake or enter the wrong code, press **[OFF]** then start again by pressing **[MENU]**.

### Answering system

The unit contains an answering system which can answer and record calls for you when you are unavailable to answer the phone.

For details about memory capacity, see page 46.

#### Important:

- Only 1 person can access the answering system (listen to messages, record a greeting message, etc.) at a time.
- When callers leave messages, the unit records the day and time of each message. Make sure the date and time have been set (page 17).
- You can select the caller's recording time (page 50).

### Recording your greeting message

You can record your own greeting message (max. 2 minutes) that will be played when the answering system answers a call. If you do not record a greeting message, a pre-recorded greeting message will be used.

**Sample greeting message:** *"This is (your name). We are unable to answer the phone right now. Please leave a message after the beep. Thank you."*

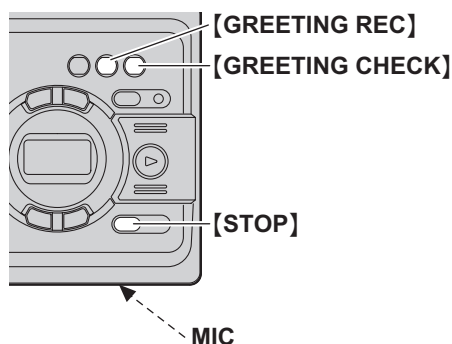

- 1** Press **[GREETING REC]**.
  - The unit announces "To record greeting, press record again."
- 2** Within 10 seconds, press **[GREETING REC]** again.
- 3** After the unit beeps, speak clearly about 20 cm away from the MIC.
  - The display will show the elapsed recording time.
- 4** To stop recording, press **[GREETING REC]** or **[STOP]**.

#### Note:

- If the greeting message is less than 1 second long, the unit beeps 6 times and announces, "Your greeting was not recorded. Record your greeting again."

### To play back the greeting message

Press **[GREETING CHECK]**.

### Erasing your greeting message

Press **[GREETING CHECK]**, and then press **[ERASE]** while your greeting message is playing.

- If you do not re-record your greeting message, the unit will use a pre-recorded greeting message.

### Pre-recorded greeting message

If you do not record a greeting message, one of 2 pre-recorded messages will be played when a call is received depending on the caller's recording time (page 50).

- When the recording time is set to "1min", "2min", or "3min":  
*"Hello, we are not available now. Please leave your name and phone number after the beep. We will return your call."*
- When the recording time is set to "Greeting only":  
*"Hello, we are not available now. Please call again. Thank you for your call."*

To play back the pre-recorded greeting, press **[GREETING CHECK]**.

## Turning the answering system on/off

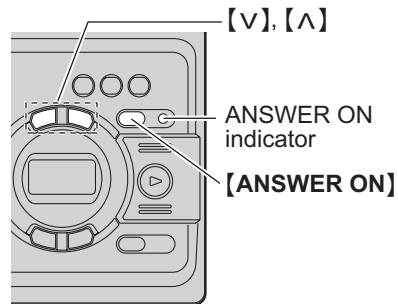

Press **[ANSWER ON]**.

- When the answering system is turned on, the ANSWER ON indicator lights and the unit announces "Answer set" and the day and time.
- When the answering system is turned off, the ANSWER ON indicator turns off and the unit announces "Answer off".

## Screening your calls

While a caller is leaving a message, you can listen to the call through the base unit's speaker. To adjust the speaker volume, press **[^]** or **[v]** repeatedly. You can answer the call by pressing **[hook]** or **[phone]**.

### To turn off the call screening feature

Turn the base unit's speaker volume off by pressing **[v]** until "0" is displayed.

#### Note:

- If you adjust the speaker volume while listening to messages or talking on the intercom, the speaker volume for call screening will be turned on again.

### Listening to messages

When new messages have been recorded:

- The MESSAGE indicator on the base unit will flash.
- The message indicator on the handset will flash slowly if the message alert feature is turned on (page 50).

The base unit display will show the number of messages (old and new) recorded by the answering system.

Example: The total number of recorded messages is 10.

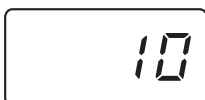

### Listening to messages using the base unit

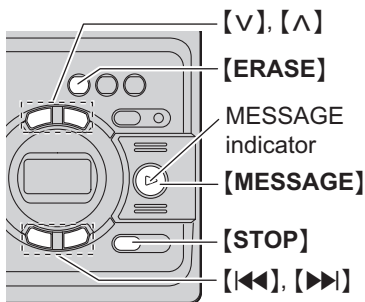

Press **[MESSAGE]**.

- The unit will announce the number of new messages and will play back the new messages.
- When you have no new messages, the unit will announce “No new messages. All message playback”, and will play back all messages.

#### Note:

- The display shows the message number during playback.
- During playback, the unit will announce the day and time that each message was recorded. (**Voice time/day stamp**)
- At the end of the last message, the unit announces “End of final message”.

#### To adjust the speaker volume

9 levels (high to off) are available. Press **[^]** or **[v]** repeatedly while using the answering system.

#### Repeating a message

Press **[<<]** while listening to the message.

- If pressed within the first 5 seconds of a message, the previous message will be played.

#### Skipping a message

Press **[>>]** to play the next message.

#### Pausing message playback

Press **[STOP]**.

- To resume playback, press **[MESSAGE]**.
- To stop playback completely, press **[STOP]** again.

#### Erasing a specific message

Press **[ERASE]** while listening to the message you want to erase.

#### Erasing all messages

- 1 Press **[ERASE]** while the base unit is not being used.
  - The unit will announce “To erase all messages, press ERASE again.”
- 2 Within 10 seconds, press **[ERASE]** again.
  - The unit will announce “No messages”.

**Note:**

- Caller information for the erased messages will remain in the caller list.

## Listening to messages using the handset

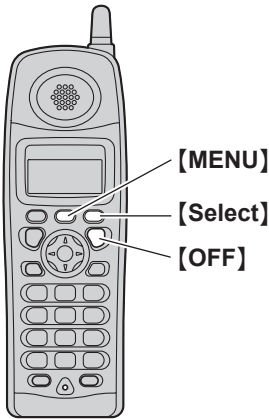

When new messages have been recorded, "New message" is displayed.

**1** Press **[MENU]**.

**2** Press **[Select]** at "Message play".

- The unit will announce the number of new messages, and will play back the new messages.
- To switch to the receiver and to listen to the messages with privacy, press **[v]**. You can switch back to the speaker by pressing **[u]**.
- When you have no new messages, the unit will announce "No new messages. All message playback", and will play back all messages.
- After the last message is played back, the unit's voice guidance starts. Follow the guidance as necessary.

**3** Press **[OFF]** when finished.

**Note:**

- Adjust the speaker or receiver volume using **[v]** or **[u]**.

- At the end of the last message, the unit announces "End of final message".

### Voice guidance

If you do not press any buttons after the last message is played back, the unit's voice guidance starts. Operate the answering system by following the guidance as necessary.

The unit will announce "Press 4 to play back new messages. Press 5 to play back all messages."

- You can press buttons for other playback options (see below) even if the voice guidance has started.
- If you do not press any button within 10 seconds after the voice guidance, the handset returns to standby mode.

### Answering system commands

You can also operate the answering system by pressing dial keys.

To use the following commands, press **[MENU]**, then press **[Select]** at "Message play".

Key	Command
<b>[1]</b> or <b>[&lt;]</b>	Repeat message (during playback) <sup>*1</sup>
<b>[2]</b> or <b>[&gt;]</b>	Skip message (during playback)
<b>[4]</b>	Play new messages
<b>[5]</b>	Play all messages
<b>[8]</b>	Turn answering system on
<b>[9]</b>	Stop playback <sup>*2</sup>
<b>[0]</b>	Turn answering system off
<b>[CLEAR]</b> or <b>[*][4]</b>	Erase this message (during playback)
<b>[*][5]</b>	Erase all messages

<sup>\*1</sup> If pressed within the first 5 seconds of a message, the previous message will be played.

<sup>\*2</sup> To resume operation, press a command key within 15 seconds, or the voice guidance will start.

### Calling back (Caller ID subscribers only)

If Caller ID information was received for the call, you can call the caller back while listening to a message.

Press **[Call]** during playback.

#### Note:

- To edit the number before calling back, press **[Edit]** and edit the number (page 28). Press **[Call]**, **[↶]**, or **[↷]**.

---

## Memory capacity

The total recording capacity (including your greeting message and caller messages) is about 15 minutes. A maximum of 64 messages (including a greeting message) can be recorded.

- If message memory becomes full:
  - “**FULL**” flashes on the base unit.
  - the ANSWER ON indicator flashes rapidly (if the answering system is turned on).
  - the unit announces “*Memory full*” when operating the answering system.

To record additional messages, erase unnecessary messages.

- If less than 3 minutes of recording time is available, the unit will announce the remaining recording time when operating the answering system.
- Messages are retained even if a power failure occurs. All messages are saved until you erase them. (**Flash memory message backup**)
- The total recording capacity may be reduced by the calling party's background noise.

## Remote operation

Using a touch tone phone, you can call your phone number from outside and access the unit to listen to messages. The unit's voice guidance will prompt you to press certain dial keys to perform different operations.

### Important:

- In order to operate the answering system remotely, you must first set a remote code (page 48). This code must be entered each time you operate the answering system remotely.

## Using the answering system remotely

- 1 Dial your phone number from a touch tone phone.
  - If the ring count is set to "T<sub>0</sub>11 saver" (page 49), the number of rings you hear will indicate whether or not you have new messages.
- 2 After the greeting message starts, enter your remote code.
  - The unit will announce the number of new messages, and will play back the new messages.
- 3 After 3 seconds, the voice guidance will start. Follow the voice guidance as necessary.
- 4 When finished, hang up.

### Note:

- When you press a key, press firmly.
- You can hang up at any time.
- You can ignore the voice guidance and control the unit using remote commands.

## Voice guidance

During remote operation, the unit's voice guidance will prompt you to press **[1]** to perform a specific operation, or press **[2]** to listen to more available operations. Operations are presented by voice guidance in the following order:

- Play back all messages
- Play back new messages
- Record a message
- Erase all messages

### Note:

- If you do not press any dial keys within 10 seconds after a voice guidance prompt, the unit will announce, "Thank you for your call" then disconnect your call.
- If less than 3 minutes of recording time is available, the unit will announce the remaining recording time after the last message is played back.
- If the unit announces "Memory full", erase unnecessary messages.

## Remote commands

You can press dial keys to access certain answering system functions without waiting for the voice guidance to prompt you.

Key	Remote command
<b>[1]</b>	Repeat message (during playback) <sup>*1</sup>
<b>[2]</b>	Skip message (during playback)
<b>[4]</b>	Play new messages
<b>[5]</b>	Play all messages
<b>[9]</b>	Stop <sup>*2</sup>
<b>[0]</b>	Turn answering system off
<b>[*][4]</b>	Erase this message (during playback)
<b>[*][5]</b>	Erase all messages

- \*1 If pushed within the first 5 seconds of a message, the previous message will be played.
- \*2 To resume operation, enter a remote command within 15 seconds, or the voice guidance will start.

---

### Turning on the answering system remotely

If the answering system is off, you can turn it on remotely.

- 1 Dial your phone number.
- 2 Let the phone ring 15 times.
  - The unit will answer your call with the greeting message.
  - You can hang up, or if you call from a touch tone phone, you can enter your remote code and begin remote operation (page 47).

---

### Skipping the greeting message to leave a message

You can leave a message just as any outside caller can. Call your phone number, then press [**\***] to skip the greeting message and record your message after the beep.

---

---

## Answering system settings

---

### Remote code

A remote code must be entered when operating the answering system remotely. This code prevents unauthorised parties from listening to your messages remotely. Store any 2-digit number (00–99). The default setting is “11”.

- 1 Press [**MENU**].
- 2 Scroll to “Initial setting” by pressing [**▼**] or [**▲**], then press [**▶**].
- 3 Scroll to “set answering” by pressing [**▼**] or [**▲**], then press [**▶**].
- 4 Scroll to “Remote code” by pressing [**▼**] or [**▲**], then press [**▶**].
- 5 Select the desired remote code by entering a 2-digit number (00–99).
- 6 Press [**Save**], then press [**OFF**].

#### Note:

- To confirm the remote code, repeat steps 1 to 4. Press [**OFF**] when finished.



### Ring count

You can change the number of times the phone rings before the unit answers calls. You can select "2", "3", "4" (default), "5", "6", "7", or "Toll saver".

"Toll saver": The unit answers on the 2nd ring when new messages have been recorded, and on the 4th ring when there are no new messages. If you call your phone from outside to listen to new messages (page 47), you will know that there are no messages when the phone rings for the 3rd time. You can then hang up without being charged for the call.

- 1 Press **[MENU]**.
- 2 Scroll to "Initial setting" by pressing **[▼]** or **[▲]**, then press **[▶]**.
- 3 Scroll to "Set answering" by pressing **[▼]** or **[▲]**, then press **[▶]**.
- 4 Scroll to "Ring count" by pressing **[▼]** or **[▲]**, then press **[▶]**.
- 5 Press **[▼]** or **[▲]** repeatedly to select the desired setting.
  - You can also select the ring count by pressing **[0]** ("Toll saver"), or **[2]** to **[7]**.
- 6 Press **[Save]**, then press **[OFF]**.

### For Telstra Homeline service subscribers

To receive Voice Mail and use answering system properly, please note the following:

- "Voice Mail" is a service provided by your Service Provider. You will need to first subscribe or activate this service through your Service Provider. Consult your Service Provider on how to operate this service and how you will be notified that you have messages on your Voice Mail.

To use this service you will be required to leave your answering machine off on your unit.

This will allow the Voice Mail to receive any messages.

This unit does not have a visual indicator to indicate if there are new messages in your Voice Mail service. Your Service Provider may use a "Stutter" dial tone to indicate that you have Voice Mail left.

- To use the unit's answering machine rather than the Voice Mail service provided by your Service Provider, please consult your Service Provider to have it removed or deactivated permanently or temporarily. Alternatively you can leave this service connected and change the "Ring count" to a shorter duration on your unit so your unit's answering machine can pick up the call prior to the Voice Mail provided by your Service Provider.

#### Note:

- Provider Voice Mail can capture messages that can be missed while the customer is on the Internet.

### Caller's recording time

You can change the maximum message recording time allotted to each caller.

"1min", "2min", or "3min" (default): Caller messages are limited to 1 minute to 3 minutes.

"Greeting only": The unit plays the greeting message but does not record caller messages.

- 1 Press **[MENU]**.
- 2 Scroll to "Initial setting" by pressing **[▼]** or **[▲]**, then press **[▶]**.
- 3 Scroll to "Set answering" by pressing **[▼]** or **[▲]**, then press **[▶]**.
- 4 Scroll to "Recording time" by pressing **[▼]** or **[▲]**, then press **[▶]**.
- 5 Press **[▼]** or **[▲]** repeatedly to select the desired setting.
  - You can also select the recording time by pressing **[1]** to **[3]**, or **[0]** ("Greeting only").
- 6 Press **[Save]**, then press **[OFF]**.

#### Note:

- If message memory becomes full, the unit will automatically switch to the "Greeting only" mode.

### Message alert

You can select whether or not the message indicator on the handset will flash when new messages have been recorded (page 44). The default setting is OFF.

- 1 Press **[MENU]**.
- 2 Scroll to "Initial setting" by pressing **[▼]** or **[▲]**, then press **[▶]**.
- 3 Scroll to "Message alert" by pressing **[▼]** or **[▲]**, then press **[▶]**.
- 4 Press **[▼]** or **[▲]** repeatedly to select "On" or "Off".
- 5 Press **[Save]**, then press **[OFF]**.

#### Note:

- The message indicator will not flash for new messages while the handset is in use.
- While message alert is on, battery operating time will be shortened (page 13).

## Belt clip

You can hang the handset on your belt or pocket using the included belt clip.

### To attach the belt clip

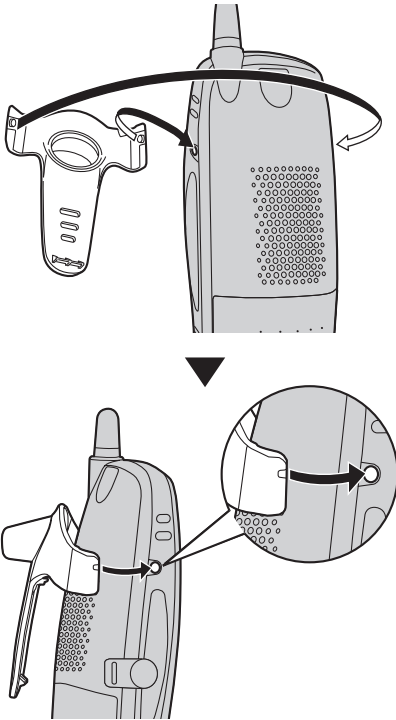

### To remove the belt clip

While pressing the top of the clip (①), pull the right edge in the direction of the arrow (②).

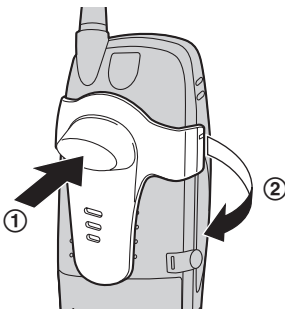

## Headset (optional)

Connecting an optional headset to the handset allows hands-free phone conversations. Please use only a Panasonic headset. See page 5 for compatible headset and ordering information.

### To connect an optional headset to the handset

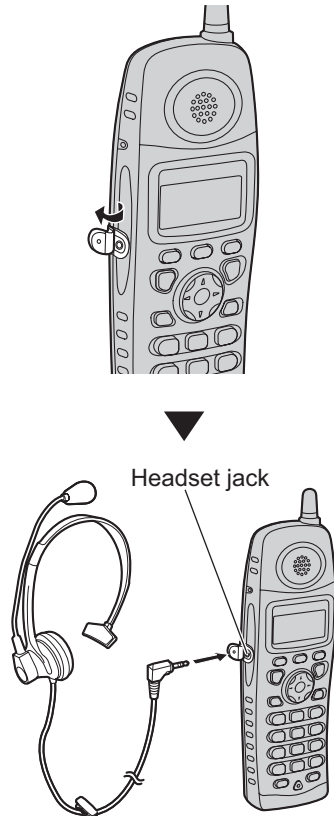

### Note:

- Only telecommunications compliance labelled headsets should be plugged into the headset jack on the handset.
- To switch to the speakerphone, press [☎]. To return to the headset, press [📞].

## Wall mounting

### Base unit

The base unit can be mounted on a wall.

- 1 Connect the AC adaptor.

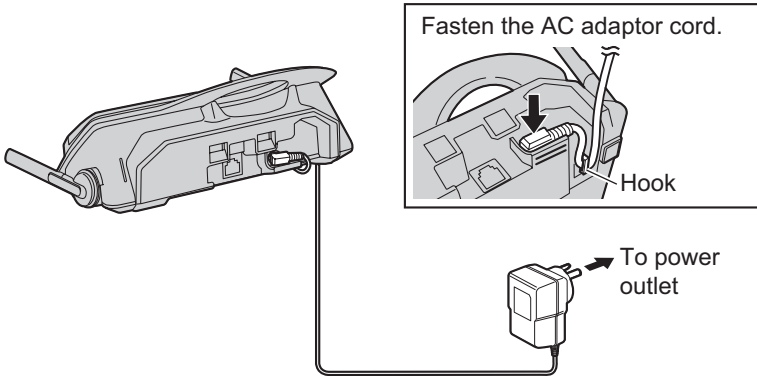

- 2 Tuck the telephone line cord inside the wall mounting adaptor (①).  
Connect the telephone line cord (②).

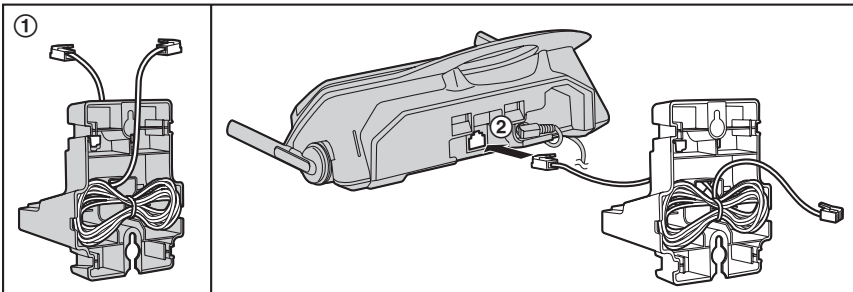

- 3 Insert the hooks on the wall mounting adaptor into the holes (A) and (B) on the base unit.

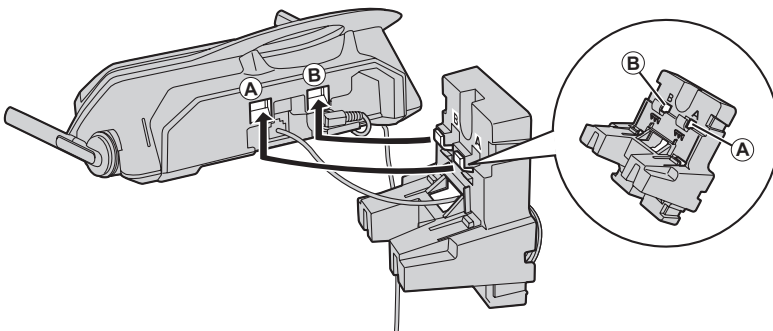

- 4** Adjust the adaptor to hold the base unit, then push it in the direction of the arrow until it clicks into place.

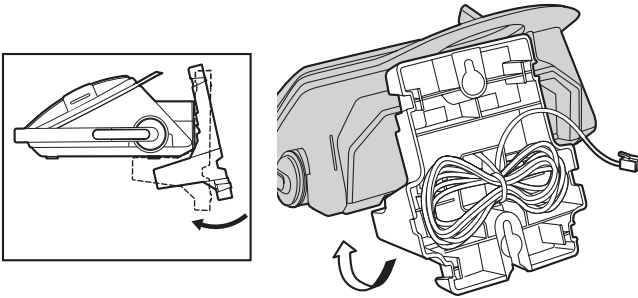

- 5** Drive the screws (not included) into the wall using the wall mount template (see below). Connect the telephone line cord. Mount the unit, then slide it down.

- Raise the antennas.

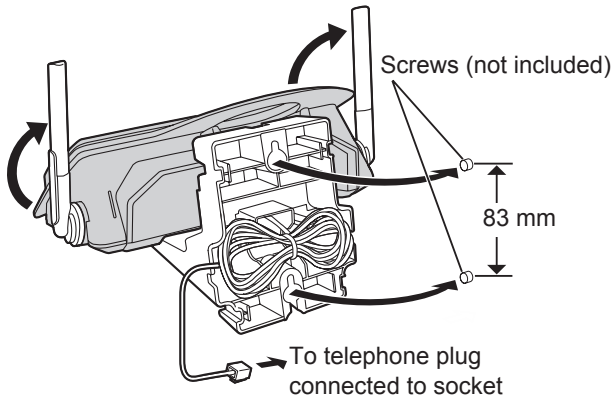

**Wall mount template for the base unit**

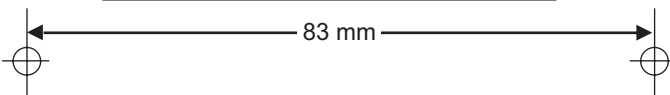

## Useful Information

---

### To remove the wall mounting adaptor

While pushing down the release levers (①), remove the adaptor (②).

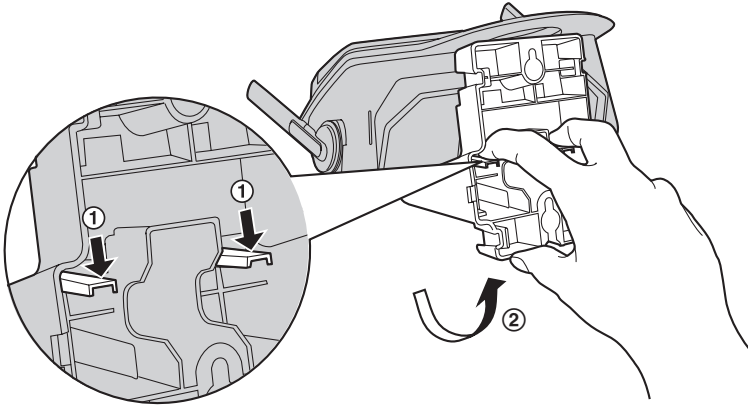

### Charger (KX-TG5839AL only)

The charger can be wall mounted, as shown below.

- 1 Connect the AC adaptor.
- 2 Drive the screws (not included) into the wall using the wall mount template (see below).
- 3 Mount the charger (①).
- 4 Slide it down (②) and to the right (③) until it is secure.

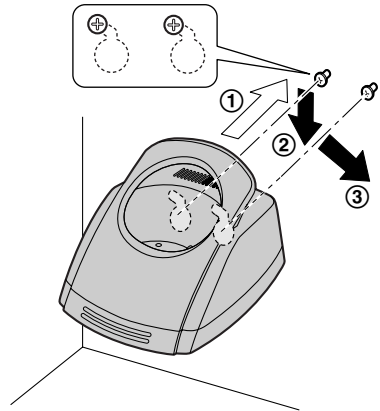
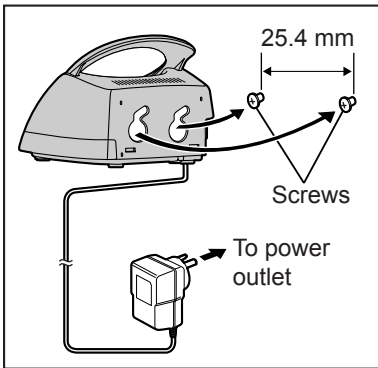

#### Wall mount template for the charger

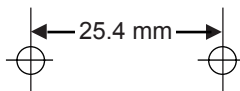

## Error messages

If the unit detects a problem, one of the following messages will be displayed on the handset.

Display message	Cause & solution
Busy	<ul style="list-style-type: none"> <li>● The called handset is in use.*1</li> <li>● The handset you tried to copy phonebook items to is in use.*1</li> <li>● The handset you are calling is too far from the base unit.*1</li> </ul>
Error!!	<ul style="list-style-type: none"> <li>● When you tried to register the handset, the handset and the base unit could not link for some reason, such as interference from electrical appliances. Move the handset and the base unit away from the electrical appliances and try again.</li> <li>● The other handset tried to send phonebook items to you but there was an error. Have the other handset user re-send the items to you (page 24).*1</li> <li>● The entered password was wrong in programming dial lock. Enter the correct password.</li> </ul>
---Incomplete--- Phonebook full	<ul style="list-style-type: none"> <li>● When the phonebook item(s) was(were) sent to another handset, the handset's phonebook memory was full and copying stopped. Press <b>[OFF]</b> to exit. Erase items from the other handset's phonebook (page 23). When phonebook memory is available, you can copy all phonebook items (page 25) or individual items one by one (page 24).*1</li> </ul>
No link to base. Move closer to base, try again.	<ul style="list-style-type: none"> <li>● The handset has lost communication with the base unit. Move closer to the base unit, and try again.</li> <li>● Confirm that the base unit's AC adaptor is plugged in.</li> <li>● Raise the base unit antennas.</li> <li>● The handset's registration may have been cancelled. Re-register the handset (page 38).</li> </ul>
Phonebook full	<ul style="list-style-type: none"> <li>● There is no space to store new items in the phonebook. Erase unnecessary items (page 23).</li> </ul>
No items stored	<ul style="list-style-type: none"> <li>● Your phonebook or redial list is empty.</li> </ul>
Please lift up and try again.	<ul style="list-style-type: none"> <li>● A handset button was pressed while the handset was on the base unit or charger. Lift the handset and press the button again.</li> </ul>
System is busy. Please try again later.	<ul style="list-style-type: none"> <li>● The handset has lost communication with the base unit. Move closer to the base unit and try again.</li> <li>● More than one unit is in use. Try again later.*1</li> <li>● Another user is listening to messages. Try again later.</li> </ul>
Dial locked	<ul style="list-style-type: none"> <li>● Dial lock is turned on. To turn it off, see page 38.</li> </ul>

\*1 KX-TG5839AL only



## Troubleshooting

### General use

Problem	Cause & solution
The unit does not work.	<ul style="list-style-type: none"> <li>● Make sure that the battery is installed correctly (page 11).</li> <li>● Check the connections (page 10).</li> <li>● Fully charge the battery (page 12).</li> <li>● Clean the charge contacts and charge again (page 12).</li> <li>● Unplug the base unit's AC adaptor to reset the unit. Reconnect the adaptor and try again.</li> <li>● Re-install the battery (page 11) and fully charge it.</li> </ul>
The display shows "No link to base. Move closer to base, try again." and an alarm tone sounds.	<ul style="list-style-type: none"> <li>● The handset is too far from the base unit. Move closer and try again.</li> <li>● Plug in the base unit's AC adaptor.</li> <li>● Raise the base unit antennas.</li> <li>● If the above remedies do not solve the problem, the handset may have lost communication with the base unit. Register the handset again (page 38).</li> </ul>
I cannot hear a dial tone.	<ul style="list-style-type: none"> <li>● Confirm that the telephone line cord is connected (page 10).</li> <li>● Disconnect the unit from the telephone line and connect a known working telephone. If the working telephone operates properly, contact our service personnel to have the unit repaired. If the working telephone does not operate properly, contact your telephone company.</li> </ul>

### Programmable settings

Problem	Cause & solution
I cannot programme items.	<ul style="list-style-type: none"> <li>● Programming is not possible while the handset and base unit are being used.</li> <li>● Do not pause for over 1 minute while programming.</li> <li>● Move closer to the base unit.</li> <li>● While another user is listening to messages or the answering system is answering a call, you cannot programme. Try again later.</li> </ul>
While programming, the handset starts to ring.	<ul style="list-style-type: none"> <li>● A call is being received. Answer the call and start again from the beginning after hanging up.</li> </ul>

### Making/answering calls, Intercom

Problem	Cause & solution
Static is heard, sound cuts in and out. Interference from other electrical units.	<ul style="list-style-type: none"><li>● Move the handset and the base unit away from other electrical appliances.</li><li>● Move closer to the base unit.</li><li>● Raise the base unit antennas.</li><li>● Turn on the clarity booster feature (page 21).</li><li>● If your unit is connected to a telephone line with ADSL service, we recommend connecting a noise filter between the base unit and the telephone line jack. Contact your ADSL provider for details.</li></ul>
The handset does not ring.	<ul style="list-style-type: none"><li>● The ringer volume is turned off. Adjust it (page 34).</li></ul>
I cannot make a call.	<ul style="list-style-type: none"><li>● If the base unit (including answering system) or the other handset is in use, you may not be able to make a call. Try again later.</li><li>● While listening to messages using the handset, you cannot make a call. Exit by pressing <b>[OFF]</b>.</li><li>● Dial lock is turned on. To turn it off, see page 38.</li><li>● If the above remedies do not solve the problem, set the dialling mode. Press <b>[MENU] [0] [5] [1] [Save] [OFF]</b>.</li><li>● The unit is not designed to be used with rotary (pulse dialling) services.</li></ul>
I cannot redial by pressing <b>[REDIAL]</b> .	<ul style="list-style-type: none"><li>● If the last number dialled was more than 48 digits long, the number will not be redialled correctly.</li><li>● If you press <b>[REDIAL]</b> after you have started dialling, this button functions as the <b>[PAUSE]</b> button. To redial, do not dial any numbers before pressing <b>[REDIAL]</b>.</li><li>● Dial lock is turned on. To turn it off, see page 38.</li></ul>
I cannot have a conversation using the headset.	<ul style="list-style-type: none"><li>● Make sure that an optional headset is connected properly (page 51).</li><li>● If "SP-phone" is displayed on the handset, press <b>[</b> to switch to the headset.</li><li>● Use only the Panasonic KX-TCA88AL headset.</li></ul>
I cannot page the handset or base unit.	<ul style="list-style-type: none"><li>● The called handset is too far from the base unit.</li><li>● The called unit is in use. Try again later.</li></ul>

## Phonebook

Problem	Cause & solution
I cannot store an item in the phonebook.	<ul style="list-style-type: none"> <li>You cannot store an item in the phonebook while the handset is in talk, speakerphone or intercom mode, or while listening to messages.</li> <li>Do not pause for over 1 minute while storing.</li> <li>Dial lock is turned on. To turn it off, see page 38.</li> </ul>
While storing an item in the phonebook, the handset starts to ring.	<ul style="list-style-type: none"> <li>A call is being received. Answer the call and start again from the beginning after hanging up.</li> </ul>
Copying stopped with an item displayed.	<ul style="list-style-type: none"> <li>The destination handset may have lost communication with the base unit, or the destination handset user may have pressed <b>[↶]</b> or <b>[📞]</b>. The displayed phonebook item was not copied to the handset. Press <b>[OFF]</b>. Confirm that the destination handset is in standby mode (i.e., not in use) and try again.</li> </ul>
The display exits the phonebook while searching.	<ul style="list-style-type: none"> <li>The handset automatically exits after 1 minute of inactivity.</li> </ul>



## Caller ID



Problem	Cause & solution
The handset does not display the caller's phone number.	<ul style="list-style-type: none"> <li>You have not subscribed to Caller ID service. Contact your telephone company to subscribe.</li> <li>If your unit is connected to any additional telephone equipment such as Caller ID box or wireless telephone jack, disconnect the unit from the equipment and plug the unit directly into the wall jack.</li> <li>If your unit is connected to a telephone line with ADSL service, we recommend connecting a noise filter between the base unit and the telephone line jack. Contact your ADSL provider for details.</li> <li>Other telephone equipment may be interfering with this unit. Disconnect the other equipment and try again.</li> <li>The caller requested not to send caller information (page 26).</li> <li>If a call is being transferred to you, the caller information will not be displayed.</li> </ul>
The display exits the caller list while searching.	<ul style="list-style-type: none"> <li>The handset automatically exits after 1 minute of inactivity.</li> </ul>

### Answering system

Problem	Cause & solution
I cannot listen to messages from a remote location.	<ul style="list-style-type: none"><li>● A touch tone phone is required for remote operation.</li><li>● Press the remote code correctly and press each key firmly (page 47).</li><li>● The answering system is off. Turn it on (page 48).</li></ul>
The other party complains that they cannot leave a voice message.	<ul style="list-style-type: none"><li>● The recording time is set to "Greeting only". Select "1min", "2min", or "3min" (page 50).</li><li>● The memory is full. Erase unnecessary messages (page 44).</li></ul>
"FULL" flashes and the ANSWER ON indicator flashes rapidly. No new messages are recorded.	<ul style="list-style-type: none"><li>● Message memory is full. Erase unnecessary messages (page 44).</li></ul>
I cannot operate the answering system.	<ul style="list-style-type: none"><li>● Someone is operating the answering system.</li><li>● If someone is talking on a conference call, you cannot operate the answering system. Try again later.</li></ul>
During message playback, the unit rings and cancels playback.	<ul style="list-style-type: none"><li>● A call is being received. Answer the call and start again from the beginning after hanging up.</li></ul>
The message indicator on the handset flashes slowly.	<ul style="list-style-type: none"><li>● New messages have been recorded. Listen to the new messages (page 44) or turn the message alert off (page 50).</li></ul>
When you play back messages or turn on the answering system, the base unit and handset announce the day and time incorrectly.	<ul style="list-style-type: none"><li>● Set the date and time again (page 17).</li></ul>

### Battery charge

Problem	Cause & solution
"Recharge battery" is displayed,  flashes or the handset beeps intermittently.	<ul style="list-style-type: none"><li>● Fully charge the battery (page 12).</li></ul>
"Charge for 6h" and  are displayed and the handset does not work.	<ul style="list-style-type: none"><li>● The battery has been discharged. Fully charge the battery (page 12).</li></ul>

<b>Problem</b>	<b>Cause &amp; solution</b>
I charged the battery fully, but "Recharge battery" is still displayed and/or  , continues to flash, or "Charge for 6h" and  are displayed.	<ul style="list-style-type: none"><li>● Clean the charge contacts and charge again (page 12).</li><li>● The battery may need to be replaced (page 13). If you install a new battery, fully charge it (page 12).</li></ul>
The CHARGE indicator does not go out after the battery has been charged.	<ul style="list-style-type: none"><li>● This is normal.</li></ul>
The handset display is blank.	<ul style="list-style-type: none"><li>● Confirm that the battery is properly installed.</li><li>● Fully charge the battery (page 12).</li></ul>

## Power failure

<b>Problem</b>	<b>Cause &amp; solution</b>
The unit will not function.	<ul style="list-style-type: none"><li>● This product is not designed to make calls in the event of a power failure. We recommend connecting a standard telephone to the same telephone line in the event that emergency calls need to be made during a power failure (page 10).</li></ul>

## Instructions to customer

### Installation

Attached to this apparatus is an approval label. This label is evidence that it is a "Permitted Attachment" which has been authorised to be connected to your telephone service.

Conditions relating to connection and operation of this Permitted Attachment are contained in Telecommunications General By-Law 220 (5).

You are authorised to install this Permitted Attachment yourself by plugging it into the line socket of any regular telephone. You may connect it in place of your existing telephone or to any spare telephone socket installed in your premises.

To disconnect your existing telephone you must first remove its plug from the line socket. You can then insert the plug of your Permitted Attachment into the socket and use your equipment.

If the plug of your existing telephone cannot be readily removed, you will have to remove the screw securing it. To do this proceed as follows:

1. Loosen screw "A" sufficiently to remove the socket cover. (See Fig. 1.)
2. Remove screw "B" and withdraw the plug. (See Fig. 2.)
3. Replace screw "B". (See Fig. 3.) Ensure that it screws completely into the socket recess. (If the screw is too long, increase the hole depth or replace the screw with one 5 mm shorter.)
4. Replace socket cover and tighten screw "A". (See Fig. 4.)

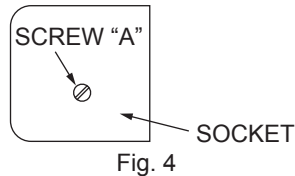
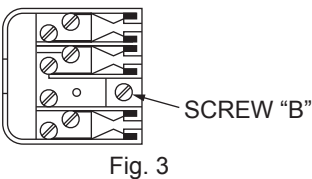
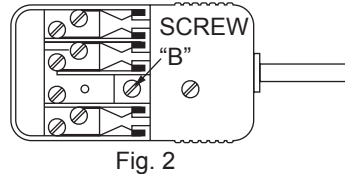
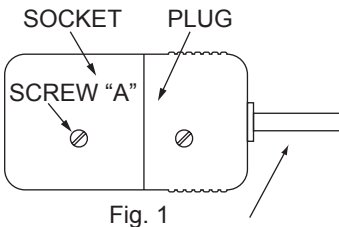

If you are satisfied with the operation of your telephone service after plugging in your Permitted Attachment, your installation is completed.

You will be unable to connect this Permitted Attachment if your telephone service consists only of a wall phone or an old style telephone which is not connected by means of a modern plug and socket. In such cases a new socket will need to be installed.

Should the Permitted Attachment not operate when plugged into a socket, it is either faulty or unsuitable for operation with your telephone service. It should be returned to the store where purchased or an Authorised Service Centre.

### **Service difficulties**

If at any time a fault occurs on your telephone service, carry out the following checks before you call for service:

- Disconnect the Permitted Attachment and try using the service with the normal telephone.
- If the telephone service then operates satisfactorily, the fault is in your Permitted Attachment. Leave the Permitted Attachment disconnected and report the fault to its supplier or agent to arrange for repair.
- If when using the telephone the service is still faulty, report the fault to “Service Difficulties and Faults” for attention.

You are required to keep this Permitted Attachment in good working order while it is connected to your telephone service. Its construction or internal circuit must not be modified in any way without permission.

### **WARNING:**

This cordless telephone system does not incorporate provision for secrecy of conversations. Appropriately tuned radio equipment and other cordless telephone systems in close proximity may be used by a third party to monitor and possibly interrupt conversations in progress when this system is on radio operation.

---

---

## Technical information

---

### Base unit

**Operating environment:**

5 °C – 40 °C

**Frequency:**

5.76 GHz – 5.84 GHz

**Dimensions:**

Approx. height 75 mm x width 185 mm x depth 119 mm

**Mass (Weight):**

Approx. 395 g

**Power consumption:**

Standby: Approx. 2.4 W  
Maximum: Approx. 5.5 W

**Power supply:**

AC adaptor (230–240 V AC, 50/60 Hz)

---

### Handset

**Operating environment:**

5 °C – 40 °C

**Frequency:**

5.76 GHz – 5.84 GHz

**Dimensions:**

Approx. height 178 mm x width 53 mm x depth 37 mm

**Mass (Weight):**

Approx. 190 g

**Power supply:**

Ni-MH battery (3.6 V, 830 mAh)

**Security codes:**

1,000,000

---

### Charger (KX-TG5839AL only)

**Operating environment:**

5 °C – 40 °C

**Dimensions:**

Approx. height 71 mm x width 89 mm x depth 105 mm

**Mass (Weight):**

Approx. 130 g

**Power consumption:**

Standby: Approx. 1.5 W  
Maximum: Approx. 3.5 W

**Power supply:**

AC adaptor (230–240 V AC, 50/60 Hz)

**Note:**

- Design and specifications are subject to change without notice.
- The illustrations in these instructions may vary slightly from the actual product.



---



---

## Index

- A** Accessories: 5  
 Answering calls: 19  
 Answering system: 42  
 Area code: 37  
 Auto talk: 19, 36
- B** Backlit display: 16  
 Backlit handset keypad: 16  
 Base unit location: 8  
 Battery  
   Charge: 12  
   Installation: 11  
   Performance: 13  
   Replacement: 13  
   Strength: 12  
 Belt clip: 51
- C** Caller ID service: 26  
 Caller list  
   Calling back: 27  
   Editing: 28  
   Erasing: 29  
   Storing: 28  
   Viewing: 27  
 Call screening: 43  
 Call share: 21  
 Call waiting Caller ID: 26  
 Call waiting tone: 26  
 Chain dial: 24  
 Clarity booster: 21  
 Conf (Conference): 32  
 Conference calls: 32  
 Controls: 14  
 Copy phonebook: 24, 25
- D** Date and time: 17  
 Dial lock: 38  
 Display  
   Base unit: 16  
   Handset: 16
- E** Emergency numbers: 22  
 Erasing all messages: 44, 45, 47  
 Erasing a message: 44, 45, 47  
 Error messages: 56  
 Extension number: 31
- F** Function menu  
   Direct commands: 40  
   Table: 33
- G** Greeting message: 42
- H** Handset locator: 30, 31  
 Headset, optional: 51  
 Hold: 20
- I** Installation  
   AC adaptor: 10  
   Base unit: 10  
   Charger: 10  
   Telephone line cord: 10  
 Intercom  
   Call: 30  
   Paging: 30  
 Interrupt tone: 35
- K** Key tone: 38
- L** LCD contrast: 36  
 Light-up ID: 27  
 Line mode: 37  
 Listening to messages  
   Base unit: 44  
   Handset: 45  
   Touch tone phone: 47
- M** Making calls: 18  
 Memory capacity: 46  
 Message alert: 50  
 Microphone  
   Base unit: 30, 42  
   Handset: 18  
 Mute: 20
- N** Navigator key: 15  
 Noise: 8
- P** Pause: 21  
 Phonebook  
   Adding: 22  
   Calling: 23  
   Copying: 24, 25  
   Editing: 23  
   Erasing: 23  
   Names: 22  
 Power failure: 10, 17, 61
- R** Recall button: 21  
 Recall time: 37  
 Recording time: 50  
 Redial: 18  
 Redial list: 19  
 Registration: 38  
 Remote code: 48  
 Remote operation: 47

- Ring count: 49
- Ringer
  - Tone: 35
  - Volume: 34
- Ringer ID: 26
- Ringer off: 19, 34
- S** Safety instructions: 6
- Soft keys: 16
- SP-phone: 18
- T** Technical information: 64
- Time adjustment: 39
- Toll saver: 49
- Transferring a call: 32
- Troubleshooting
  - Answering system: 60
  - Battery charge: 60
  - Caller ID: 59
  - General use: 57
  - Making/answering calls, Intercom: 58
  - Phonebook: 59
  - Power failure: 61
  - Programmable settings: 57
- V** VE (voice enhancer): 20
- Voice enhancer: 20, 36
- Voice guidance: 45, 47
- Volume control
  - Base unit: 44
  - Handset receiver: 18
  - Handset speaker: 18
- W** Wall mounting
  - Base unit: 52
  - Charger: 55



Customer Support Centre Tel. No.: 132600 or website [www.panasonic.com.au](http://www.panasonic.com.au)

 N52

**Copyright:**

This material is copyrighted by Panasonic Communications Co., Ltd., and may be reproduced for internal use only. All other reproduction, in whole or in part, is prohibited without the written consent of Panasonic Communications Co., Ltd.  
© 2005 Panasonic Communications Co., Ltd. All Rights Reserved.

**Sales Department:**

**Panasonic Australia Pty. Limited**

Austlink Corporate Park, 1 Garigal Road, Belrose NSW 2085, Australia

**Manufacturer:**

**Panasonic Communications Co., Ltd.**

1-62, 4-chome, Minoshima, Hakata-ku, Fukuoka 812-8531, Japan

**PQQX14657ZA** DM0305PN0

## Free Manuals Download Website

<http://myh66.com>

<http://usermanuals.us>

<http://www.somanuals.com>

<http://www.4manuals.cc>

<http://www.manual-lib.com>

<http://www.404manual.com>

<http://www.luxmanual.com>

<http://aubethermostatmanual.com>

Golf course search by state

<http://golfingnear.com>

Email search by domain

<http://emailbydomain.com>

Auto manuals search

<http://auto.somanuals.com>

TV manuals search

<http://tv.somanuals.com>