

Panasonic

Operating Instructions

5.8 GHz Expandable Digital Cordless
Answering System

Model No. **KX-TG5971AL**

Model No. **KX-TG5976AL**

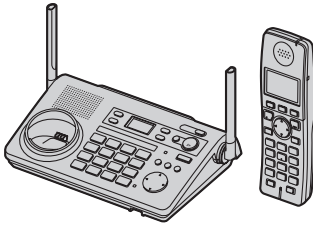

Model shown is KX-TG5971AL.

This unit is compatible with Caller ID. To use this feature, you must subscribe to the appropriate service offered by your telephone service provider.

Charge the handset battery for 7 hours before initial use.

Please read these Operating Instructions before using the unit and save for future reference.

Table of Contents

Introduction

Introduction	3
About these operating instructions	4
Expanding your phone system	6
Accessory information	8
Important safety instructions	10
For best performance	12

Preparation

Setting up the base unit	14
Setting up the handset	15
Controls	17
Displays	20
Symbols used in these operating instructions	22
Setting the unit before use	23

Making/Answering Calls

Making calls	24
Answering calls	25
Useful features	26

Phonebook

Handset phonebook	30
-----------------------------	----

Base Unit Speed Dialer

Base unit speed dialer	35
----------------------------------	----

Caller ID Service

Using Caller ID service	36
Caller list	38

Programming

Programmable settings	40
Customizing handset ringer tone and display	48

Answering System

Answering system	53
Listening to messages using the base unit	54

Listening to messages using the handset	55
Voice memo	56
Remote operation	57
Answering system settings	58

Voice Mail Service

Using Voice Mail service	61
------------------------------------	----

Multi-unit Operation

Intercom	62
Transferring calls	64
Conference calls	65
Registering a handset	65

Useful Information

Wall mounting	67
Additional accessories	70
Error messages	71
Troubleshooting	73
Instructions to customer	77
Specifications	79

Index

Index	80
-----------------	----

Introduction

Thank you for purchasing a Panasonic cordless telephone.

We recommend keeping a record of the following information for future reference.

Serial No. _____ Date of purchase _____

(found on the bottom of the base unit)

Name and address of dealer _____

┌-----┐
│ **Attach your purchase receipt here.** │
└-----┘

About these operating instructions

Notable differences between KX-TG5971AL and KX-TG5976AL

These operating instructions can be used for the following models:

KX-TG5971AL features a monochrome display handset (KX-TGA590AL).

KX-TG5976AL features a color display handset with USB-support (KX-TGA591AL).

Important:

- Features and operations indicated by “**monochrome display models**” are for KX-TG5971AL users and KX-TGA590AL (accessory handset) users only.
- Features and operations indicated by “**color display models**” are for KX-TG5976AL users and KX-TGA591AL (accessory handset) users only.
- For the differences between the monochrome display handset (KX-TGA590AL) and the color display handset (KX-TGA591AL), see page 7.

KX-TG5971AL

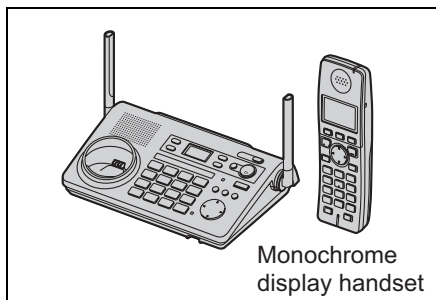

KX-TG5976AL

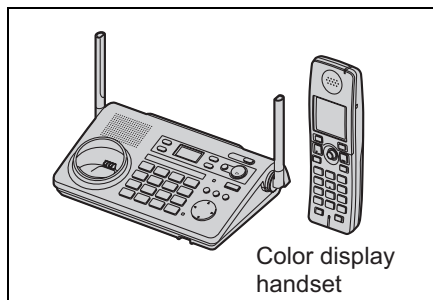

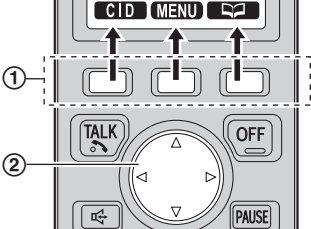
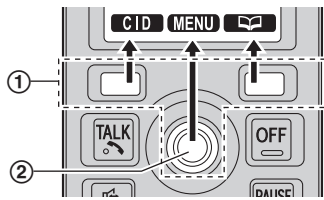
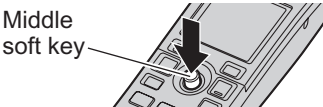
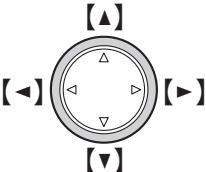
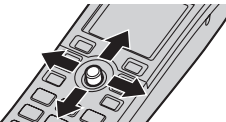
Monochrome display model: KX-TGA590AL (included with KX-TG5971AL)	Color display model: KX-TGA591 (included with KX-TG5976AL)
	
<p>① Using the soft keys The handset features 3 soft keys. By pressing a soft key, you can select the feature shown directly above it on the display.</p>	<p>① Using the soft keys The handset features 2 soft keys and joystick (middle soft key). By pressing a soft key, you can select the feature shown directly above it on the display.</p> <p>Middle soft key: The joystick can be used to select the center soft key icon, by pressing down on the center of the joystick.</p> 
<p>② Using the navigator key The handset navigator key can be used to navigate through menus and to select items shown on the display, by pressing [▲], [▼], [◀], or [▶].</p> 	<p>② Using the joystick The handset joystick can be used to navigate through menus and to select items shown on the display, by pushing it up [▲], down [▼], left [◀], or right [▶].</p> 



Expanding your phone system

You can expand the phone system by registering the following handsets and other devices to a single base unit (KX-TG5971AL, KX-TG5976AL): **max. 8**

For further information or to order these handsets and devices, visit

<http://www.panasonic.com>

or call the phone number noted on page xx.

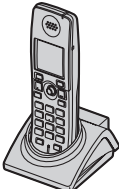
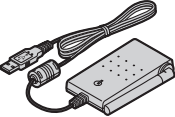
Handsets and other devices: max. 8	
<p>5.8 GHz expandable digital cordless handset KX-TGA590AL (Monochrome display type)</p> 	<p>5.8 GHz expandable digital cordless camera KX-TGA593AL (For camera monitoring from a color display handset KX-TGA591AL) max. 7</p> 
<p>5.8 GHz expandable digital cordless handset KX-TGA591AL (Color display type with USB support)</p> 	<p>5.8 GHz USB adaptor KX-TGA595AL (For calls over the Internet)*¹ max. 1</p> 

*1 By registering the 5.8 GHz USB adaptor KX-TGA595AL to your base unit and installing Skype software to your computer, you can make calls with your handset over the Internet via the computer. For operations related to this USB adaptor, refer to the operating instructions included with the USB adaptor.

Trademark

- Skype is a registered brand or trademark of Skype technology in the United States and/or other countries.

Handset feature overview for KX-TGA590AL and KX-TGA591AL

Operations and features of the 2 different accessory handsets have certain differences as indicated in the table below.

Feature	KX-TGA590AL	KX-TGA591AL	Page
Description	Same handset supplied with KX-TG5971AL	Same handset supplied with KX-TG5976AL	–
Display type	Monochrome	Color	–
Display size	1.4 inch	1.5 inch	–
Control type	Navigator key	Joystick	5
USB-support ^{*1*2}	–	●	–
Custom ring	●	●	48
Melody Utility ^{*2}	–	●	–
Picture ID	–	●	37
Picture Utility ^{*2}	–	●	–
Wallpaper	–	●	51
Phonebook Utility ^{*2}	–	●	–
Memory status display	–	●	51
Camera monitoring ^{*3}	–	●	–

*1 USB-support allows you to connect the handset to your computer and send images and melodies from your computer to the handset, as well as create and edit phonebook entries using your computer.

*2 For information on using this feature, refer to the help section of the GIGARANGE USB Utility software. If you have not installed the GIGARANGE USB Utility software, refer to the included “Installation Guide for GIGARANGE USB Utility” for details.

*3 Requires the 5.8 GHz expandable cordless camera KX-TGA593AL.

Accessory information

Included accessories

No.	Accessory item	Quantity	
		KX-TG5971AL	KX-TG5976AL
①	AC adaptor	1	1
②	Telephone line cord	1	1
③	Wall mounting adaptor	1	1
④	Battery	1	1
⑤	Handset cover* ¹	1	1
⑥	Audio cable	1	1
⑦	USB cable	–	1
⑧	CD-ROM* ³	–	1

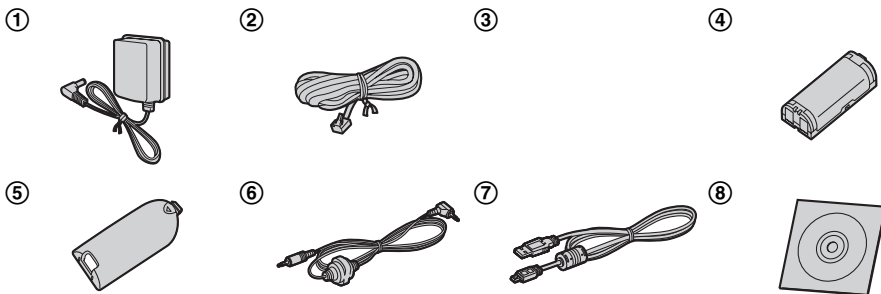

*1 The handset cover comes attached to the handset.

*2 Both of the USB cables function well.

*3 Allows you to install the GIGARANGE USB Utility software on a compatible computer.

Additional/replacement accessories

Accessory item	Order number
Rechargeable nickel metal hydride (Ni-MH) battery	HHR-P105
Headset	KX-TCA86AL or KX-TCA92AL
Belt clip	PQKE10457ZA1

Note:

- You can expand your phone system by registering additional compatible Panasonic units (page 6).

GIGARANGE® USB utility (Color display models only)

The CD-ROM included with KX-TG5976AL and KX-TGA591AL contains the GIGARANGE USB Utility.

Allows you to use your computer to:

- Add, edit, erase, and copy phonebook entries
- Send images stored in your computer to your phone
- Send melodies stored in your computer to your phone
- To install the GIGARANGE USB Utility software in your computer, refer to the “Installation Guide for GIGARANGE USB Utility” for installation details.

Important safety instructions

When using the product, basic safety precautions should always be followed to reduce the risk of fire, electric shock, or personal injury.

1. Read all instructions carefully.
2. Follow all warnings and instructions marked on the product.
3. Unplug the product from power outlets before cleaning. Do not use liquid or aerosol cleaners. Use a moist cloth for cleaning.
4. Do not use the product near water, for example near a bathtub, wash bowl, kitchen sink, etc.
5. Place the product securely on a stable surface. Serious damage and/or injury may result if the product falls.
6. Do not cover slots and openings on the product. They are provided for ventilation and protection against overheating. Never place the product near radiators, or in a place where proper ventilation is not provided.
7. Use only the power source marked on the product. If you are not sure of the type of power supplied to your home, consult your dealer or local power company.
8. Do not place objects on the power cord. Install the product where no one can step or trip on the cord.
9. Do not overload power outlets and extension cords. This can result in the risk of fire or electric shock.
10. Never push any objects through slots in the product. This may result in the

risk of fire or electric shock. Never spill any liquid on the product.

11. To reduce the risk of electric shock, do not disassemble the product. Take the product to an authorised service centre when service is required. Opening or removing covers may expose you to dangerous voltages or other risks. Incorrect reassembly can cause electric shock when the product is subsequently used.
12. Unplug the product from power outlets and take to an authorised service centre when the following conditions occur:
 - A. When the power cord is damaged or frayed.
 - B. If liquid has been spilled into the product.
 - C. If the product has been exposed to rain or water.
 - D. If the product does not work normally by following the operating instructions. Adjust only controls covered by the operating instructions. Improper adjustment may require extensive work by an authorised service centre.
 - E. If the product has been dropped or physically damaged.
 - F. If the product exhibits a distinct change in performance.
13. During thunderstorms, avoid using telephones except cordless types. There may be a remote risk of an electric shock from lightning.
14. Do not use the product to report a gas leak, when in the vicinity of the leak.

SAVE THESE INSTRUCTIONS

CAUTION:

Installation

- Never install telephone wiring during a lightning storm.
- Never install telephone jacks in wet locations unless the jack is specifically designed for wet locations.
- Never touch uninsulated telephone wires or terminals unless the telephone line has been disconnected at the network interface.
- Use caution when installing or modifying telephone lines.
- Do not touch the plug with wet hands.
- The AC adaptor is used as the main disconnect device. Ensure that the AC outlet is installed near the product and is easily accessible.
- To prevent electric shock, use only the included audio cable with the transformer when connecting the unit to an audio device.

Battery

To reduce the risk of fire or injury to persons, read and follow these instructions.

- Use only the battery(ies) specified.
- Do not dispose of the battery(ies) in a fire. They may explode. Check with local waste management codes for special disposal instructions.
- Do not open or mutilate the battery(ies). Released electrolyte is corrosive and may cause burns or injury to the eyes or skin. The electrolyte may be toxic if swallowed.
- Exercise care when handling the battery(ies). Do not allow conductive materials such as rings, bracelets or

keys to touch the battery(ies), otherwise a short circuit may cause the battery(ies) and/or the conductive material to overheat and cause burns.

- Charge the battery(ies) provided, or identified for use with the product only, in accordance with the instructions and limitations specified in this manual.

WARNING:

- To prevent the risk of fire or electrical shock, do not expose the product to rain or any type of moisture.
- Unplug the product from power outlets if it emits smoke, an abnormal smell, or makes an unusual noise. These conditions can cause fire or electric shock. Confirm that smoke has stopped emitting and contact an authorised service centre.

Medical

- Consult the manufacturer of any personal medical devices, such as pacemakers or hearing aids, to determine if they are adequately shielded from external RF (radio frequency) energy. (The product operates in the frequency range of 5.76 GHz to 5.84 GHz, and the power output is 200 mW (max.)) Do not use the product in health care facilities if any regulations posted in the area instruct you not to do so. Hospitals or health care facilities may be using equipment that could be sensitive to external RF energy.

Notice

- Please ensure that a separate telephone, not dependent on local power, is available for emergency use.
- This equipment will be inoperable when mains power fails.
- When a failure occurs which results in the internal parts becoming accessible, disconnect the power supply cord immediately and return the product to an authorised service centre.
- To minimise the possibility of lightning damage, when you know that a thunderstorm is coming, we recommend that you:
 - Unplug the telephone line cord from the phone socket.
 - Unplug the AC adaptor from the AC power outlet.
- No “000” or other calls can be made from this device during a mains power failure.
- The earpiece on the handset is magnetised and may retain small metallic objects.
- This equipment has been tested and found to comply with AS/NZS 3548: 1995 limits for electromagnetic interference. Any modifications to any part of the system or to any peripherals may void the EMC compliance of the system or the peripherals.

For best performance

Base unit location/avoiding noise

The base unit and other compatible Panasonic units use radio waves to communicate with each other.

For maximum distance and noise-free operation, we recommend the following:

- Placing the product away from electrical appliances.
- Placing the base unit in a HIGH and CENTRAL location with no obstructions such as walls.
- Raising the antennas vertically.
- If you use the handset near a microwave oven which is being used, noise may be heard. Move away from the microwave oven and closer to the base unit.
- If you use the handset near another cordless phone's base unit, noise may be heard. Move away from the other cordless phone's base unit and closer to your base unit.

Environment

- Keep the product away from electrical noise generating devices, such as fluorescent lamps and motors.
- The product should be kept free from excessive smoke, dust, high temperature, and vibration.
- The product should not be exposed to direct sunlight.
- Do not place heavy objects on top of the product.
- When you leave the product unused for a long period of time, unplug the product from the power outlet.

- The product should be kept away from heat sources such as heaters, kitchen stoves, etc. It should not be placed in rooms where the temperature is less than 5 °C or greater than 40 °C. Damp basements should also be avoided.
- The maximum calling distance may be shortened when the product is used in the following places: Near obstacles such as hills, tunnels, underground, near metal objects such as wire fences, etc.
- Operating the product near 5.8 GHz electrical appliances may cause interference. Move away from the electrical appliances.

Routine care

- Wipe the outer surface of the product with a soft moist cloth. Do not use benzine, thinner, or any abrasive powder.

Setting up the base unit

Connecting the AC adaptor and telephone line cord

Connect the telephone line cord until it clicks into the base unit (❶) and telephone line socket (❷). Connect the AC adaptor cord by pressing the plug firmly (❸).

- Use only the included Panasonic AC adaptor PQLV207AL.

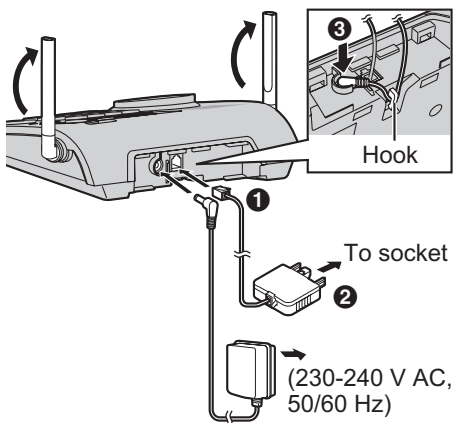

Note:

- The AC adaptor must remain connected at all times. (It is normal for the adaptor to feel warm during use.)
- The AC adaptor should be connected to a vertically oriented or floor-mounted AC outlet. Do not connect the AC adaptor to a ceiling-mounted AC outlet, as the weight of the adaptor may cause it to become disconnected.
- The unit will not work during a power failure. We recommend connecting a corded telephone to the same telephone

line or to the same telephone jack using a T-adaptor (page 9).

If you subscribe to an ADSL service

Please attach a noise filter (contact your DSL provider) to the telephone line between the base unit and the telephone line socket in the event of the following:

- Noise is heard during conversations.
- Caller ID features (page 36) do not function properly.

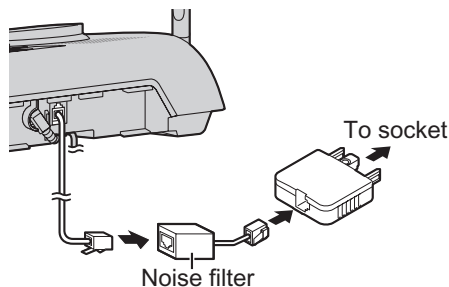

Setting up the handset

Battery installation/replacement

1 Press the notch of the handset cover firmly, and slide it in the direction of the arrow.

- If necessary, remove the old battery.

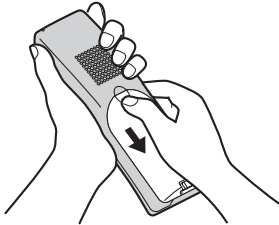

2 Insert the battery (1), and press it down until it snaps into position (2). Then close the handset cover (3, 4).

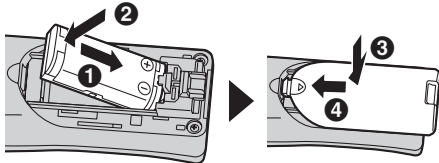

Important:

- Use only the rechargeable Panasonic battery noted on page 9.

Battery charge

Place the handset on the base unit for **7 hours** before initial use.

While charging, the charge indicator on the handset lights in amber. When the battery is fully charged, the indicator lights in green.

Base unit











- Model shown is KX-TG5971AL.

Note:

- If you want to use the handset immediately, charge the battery for at least 15 minutes.
- To ensure that the battery charges properly, clean the charge contacts of the handset, base unit, and charger with a soft, dry cloth once a month. Clean more often if the unit is subject to the exposure of grease, dust, or high humidity.

Preparation

Battery level

Battery icon		Battery level
Monochrome display models *1	Color display models *2	
		Fully charged
		Medium
		Low Flashing: needs to be recharged.
		Empty

*1 KX-TG5971AL/KX-TGA590AL

*2 KX-TG5976AL/KX-TGA591AL

Note:

- When the battery needs to be charged, the handset beeps intermittently during use.

Panasonic battery performance

Operation	Operating time
While in use (talking)	Up to 5 hours
While not in use (standby)	Up to 7 days
While using the clarity booster feature (page 27)	Up to 3 hours

Note:

- Battery operating time may be shortened over time depending on usage conditions and surrounding temperature.
- Battery power is consumed whenever the handset is off the base unit or charger, even when the handset is not in use. Hence the longer you leave the handset off the base unit or charger, the less time you may actually talk using the handset.
- After the handset is fully charged, displaying "Charge completed", it may be left on the base unit or charger without any ill effect on the battery.
- The battery level may not be displayed correctly after you replace the battery. In this case, place the handset on the base unit or charger and let charge for 7 hours.

Controls

Base unit

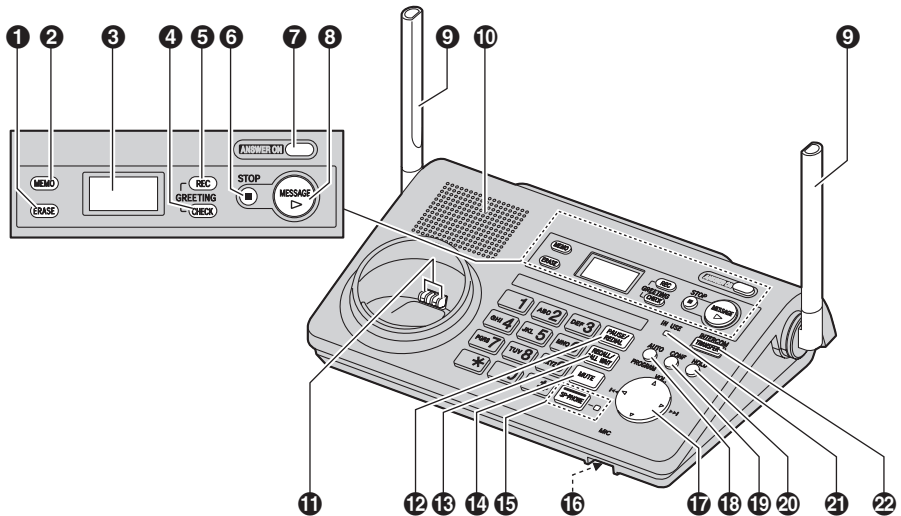

- | | |
|-------------------------------------|---|
| 1 [ERASE] | 18 [RECALL] [CALL WAIT] |
| 2 [MEMO] | 14 [MUTE] |
| 3 Display | 15 [SP-PHONE] (Speakerphone)
SP-PHONE indicator |
| 4 [GREETING CHECK] | 16 MIC (Microphone) |
| 5 [GREETING REC] (Recording) | 17 Navigator key ([Δ] [∇] [\ll] [\gg]) |
| 6 [STOP] | 18 [AUTO] [PROGRAM] |
| 7 [ANSWER ON] | 19 [CONF] (Conference) |
| 8 [MESSAGE] | 20 [HOLD] |
| 9 Antenna | 21 IN USE indicator |
| 10 Speaker | 22 [TRANSFER] [INTERCOM] |
| 11 Charge contacts | |
| 12 [PAUSE] [REDIAL] | |

Preparation

Monochrome display model: KX-TGA590AL (included with KX-TG5971AL)

Handset

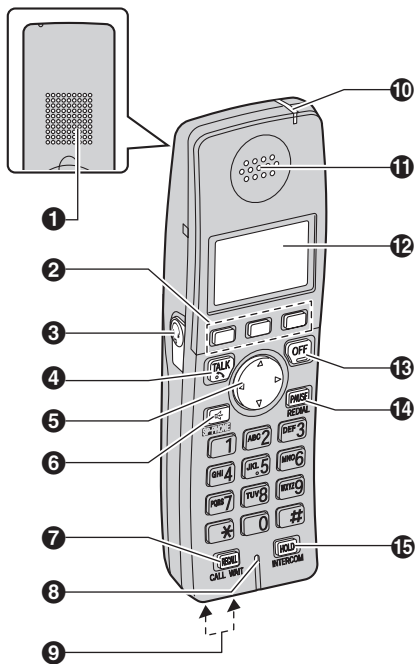

- 1 Speaker
- 2 Soft keys
- 3 Headset jack/Audio jack
- 4 [TALK]
- 5 Navigator key ([▲] [▼] [◀] [▶])
- 6 [SP-PHONE]
- 7 [RECALL] [CALL WAIT]
- 8 Microphone
- 9 Charge contacts

- 10 Charge indicator
- Ringer indicator
- Message indicator
- 11 Receiver
- 12 Display
- 13 [OFF]
- 14 [PAUSE] [REDIAL]
- 15 [HOLD] [INTERCOM]

**Color display model:
KX-TGA591AL (included with
KX-TG5976AL)**

Handset

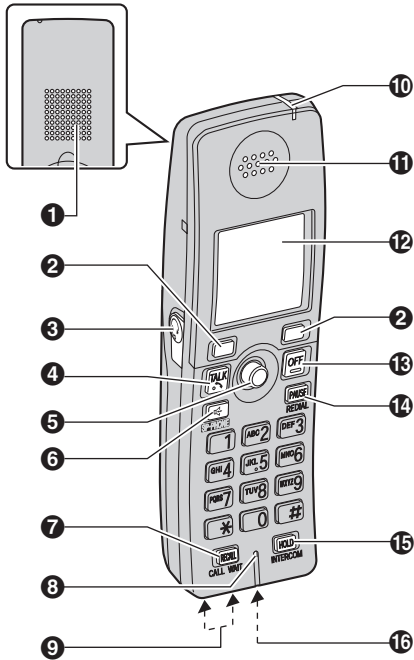

- 1** Speaker
- 2** Soft keys
- 3** Headset jack/Audio jack
- 4** [TALK]
- 5** Joystick
 - [▲] [▼]: Push the joystick up or down.
 - [◀] [▶]: Push the joystick left or right.
 - **Middle soft key**: Push the center of joystick.





- 6** [SP-PHONE]
- 7** [RECALL] [CALL WAIT]
- 8** Microphone
- 9** Charge contacts
- 10** Charge indicator
Ringer indicator
Message indicator
- 11** Receiver
- 12** Display
- 13** [OFF]
- 14** [PAUSE] [REDIAL]
- 15** [HOLD] [INTERCOM]
- 16** USB port

Displays

Base unit display items

Displayed item	Meaning
FULL	Flashes when message memory is full.
RINGER OFF	Base unit ringer is off.
<i>E</i>	Greeting or memo message recording error
<i>g</i> 	Answering system is in greeting only mode (caller messages cannot be recorded).
Example: <i>H 1</i>	Handset number: displayed when paging, or being paged (example shown here: handset 1).
<i>H</i>	Paging all handsets
<i>P</i>	Base unit is in programming mode.

Handset display items

Displayed item	Meaning
--:-- ^{*2}	The date and time need to be set.
	Within range of the base unit
	Handset has no link to base unit (out of range of base unit, handset is not registered to base unit, or no power on base unit).
VE	Voice enhancer is on.
 ^{*1}	Battery level
INUSE	Line is in use. When flashing: a call is on hold. When flashing rapidly: a call is being received.
SP ^{*1} SP ^{*2}	Speaker is on.
PRIV. ^{*1} PRIV. ^{*2}	Call Privacy mode is on.
Example: 1 ^{*1}  ^{*2}	The handset's extension number (example shown here: handset 1)
 (displayed in the top center)	Handset ringer is off.

*1 Monochrome display models:
KX-TG5971/KX-TGA590AL

*2 Color display models:
KX-TG5976AL/KX-TGA591AL

Handset menu icons











When in standby mode, pressing **[MENU]** (middle soft key) on the handset reveals the main menu. From here you can access various features and settings.

Note:

- The menu icons shown in these operating instructions vary slightly from the actual icons shown on the display.

Monochrome display models:











KX-TG5971AL/KX-TGA590AL

Menu icon		Menu/feature
		Answering device
		Ringer setting
		Phonebook
		Set date & time
		Initial setting

- Each menu icon on the left changes to the one on the right when selected.

Color display models:

KX-TG5976AL/KX-TGA591AL

Menu icon		Menu/feature
		Answering device
		Ringer setting
		Display setting
		Set date & time
		Initial setting

- Each menu icon on the left changes to the one on the right when selected.

Handset screen saver (Color display models only)

Important:

- Only KX-TG5976AL and KX-TGA591AL support this feature.

After 1 minute of inactivity, the handset enters screen saver mode if the handset is not on the base unit or charger. The display is turned off in order to preserve the life of the battery.

To cancel screen saver mode

To use the handset when it is in screen saver mode, first press **[OFF]** to turn the display on again.

Symbols used in these operating instructions

Symbol	Meaning
<p>[]: button name/soft key name</p> <p>Example: Unit keys: [↶], [OFF] Soft keys: [CID], [☎]</p>	<p>The words in the brackets indicate button names/soft key names on the handset and base unit.</p>
→	Proceed to the next operation.
<p>Example: "Ringer ID"</p>	<p>The words in quotations indicate the menu on the display.</p>
<p>Example:</p> <p>1 [MENU] (middle soft key) → [≡][1][2][0]</p> <p>2 Select the desired setting.</p> <p>3 [SAVE] → [OFF]</p>	<p>1 Press [MENU] (middle soft key), then press [≡], [1], [2], [0].</p> <p>2 Press [▲] or [▼] to select the desired setting.</p> <p>3 Press [SAVE], then press [OFF].</p>
<p>Handset: [▲] [▼]</p>	<p>Monochrome display models (KX-TG5971AL/KX-TGA590AL): Press up or down on the handset navigator key.</p> <p>Color display models (KX-TG5976AL/KX-TGA591AL): Push the joystick up or down.</p>
<p>Handset: [◀] [▶]</p>	<p>Monochrome display models (KX-TG5971AL/KX-TGA590AL): Press left or right on the handset navigator key.</p> <p>Color display models (KX-TG5976AL/KX-TGA591AL): Push the joystick left or right.</p>
<p>Base unit: [▲] [▼] [◀◀] [▶▶]</p>	<p>Press up, down, left, or right on the base unit navigator key.</p>

Setting the unit before use

Important:

- To program features by scrolling through the display menus, see page 40.

Date and time

Set the correct date and time. When you play back a message from the answering system (page 54), the unit announces the day and time it was recorded.

Handset

- 1** **[MENU]** (middle soft key) → **[#][1][0][1]**
- 2** Enter the current month, day, and year by selecting 2 digits for each.
Example: 15, August 2006
[1][5] [0][8] [0][6]
- 3** Enter the current hour and minute (12-hour clock format) by selecting 2 digits for each.
Example: 9:30
[0][9] [3][0]
- 4** Press **[AM/PM]** to select “AM” or “PM”.
→ **[SAVE]** → **[OFF]**

Note:

- If you make a mistake when entering the date and time, press **[◀]**, **[▶]**, **[▲]**, or **[▼]** to move the cursor, then make the correction.

Making calls

Using the handset

- 1 Lift the handset and dial the phone number.
 - To correct a digit, press **[CLEAR]**.
- 2 Press **[↶]** or **[CALL]**.
- 3 When you finish talking, press **[OFF]** or place the handset on the base unit or charger.

Note:

- The IN USE indicator on the base unit lights when someone is talking on the handset or another phone.

Using the speakerphone

- 1 Lift the handset, dial the phone number, and press **[📞]**.
 - Speak alternately with the other party.

- 2 When you finish talking, press **[OFF]**.

Note:

- Use the speakerphone in a quiet environment.
- To switch to the receiver, press **[↶]**.

Adjusting the receiver/speaker volume

Press **[▲]** or **[▼]** repeatedly while talking.

Making a call using the redial list

The last 10 phone numbers dialed are stored in the redial list.

1 **[REDIAL]**

- 2 Press **[▲]** or **[▼]** to select the desired number.

3 **[↶]**

Note:

- The caller's name is not stored in the redial list when calling back from the caller list.

Erasing a number in the redial list

1 **[REDIAL]**

- 2 Press **[▲]** or **[▼]** to select the desired number. → **[ERASE]**

3 "Yes" → **[SELECT]** → **[OFF]**

PAUSE button (for PBX/long distance service users)

A pause is sometimes required when making calls using a PBX or long distance service. When storing a calling card access number and/or PIN in the phonebook, a pause is also needed (page 34).

For example, if you need to dial the line access number "9" when making outside calls with a PBX:

- 1 **[9]** → **[PAUSE]** → Dial the phone number.

2 **[↶]**

Note:

- A 3.5 second pause is inserted each time **[PAUSE]** is pressed. Press repeatedly to insert longer pauses.

Using the base unit

1 **[SP-PHONE]**

2 Dial the phone number.

3 When the other party answers, speak into the MIC.

- Speak alternately with the other party.

4 When you finish talking, press **[SP-PHONE]**.

Note:

- Use the speakerphone in a quiet environment.
- While on a call, you can switch from the base unit to the handset:
 - Press **[↶]** on the handset, then press **[SP-PHONE]** on the base unit.
 - If the handset is on the base unit, simply lift it.

Adjusting the speaker volume

Press **[▲]** or **[▼]** repeatedly while talking.

Redialing the last number dialed **[SP-PHONE]** → **[REDIAL]**

Answering calls

When a call is being received, the ringer indicator on the handset and the IN USE indicator on the base unit flash rapidly.

Using the handset

1 Lift the handset and press **[↶]** or **[↷]**.

- You can also answer the call by pressing any button except joystick, navigator key, or **[OFF]**. (**Any key talk feature**)

2 When you finish talking, press **[OFF]**.

Note:

- You can change the ringer indicator light colour (page 46) and the ringer tone (page 48). You can also adjust the handset ringer volume (page 46).

Auto talk

This feature allows you to answer a call by simply lifting the handset off the base unit or charger. You do not need to press **[↶]**. To activate this feature, see page 45.

Note:

- If you subscribe to Caller ID service and want to view the caller's information after lifting up the handset to answer a call, leave this feature off.

Temporary ringer off

While the handset is ringing for a call, you can turn the ringer off temporarily by pressing **[⌘]** or **[OFF]**.

Using the base unit

1 [SP-PHONE]

2 Speak into the MIC.

3 When you finish talking, press [SP-PHONE].

Adjusting the ringer volume

Press [▲] or [▼] repeatedly to select the desired volume when in standby mode.

- To turn the ringer off, press and hold [▼] until the unit beeps.
- To stop ringing, press [STOP].

Setting the ringer tone

There are 3 tones and 3 melodies.

1 Press [▲] or [▼].

2 Within 10 seconds, press [◀◀] or [▶▶] repeatedly to select the desired tone.

- To stop ringing, press [STOP].

Note:

- If you select a melody for the base unit's ringer tone, the ringer continues to sound for several seconds if:
 - the caller hangs up before you answer the call.
 - another person answers the call using another phone connected to the same line.

Useful features

Useful features during a call

HOLD button

This feature allows you to put an outside call on hold.

Handset

1 Press [HOLD] during an outside call.

- To transfer the call to the base unit or another handset, continue from step 2, "Transferring calls", page 64.

2 Press [HOLD] again.

- To release the hold, press [↶].
- The base unit user can take the call by pressing [SP-PHONE].
- Another handset user can take the call by pressing [↶].

Base unit

Press [HOLD] during an outside call.

- To release the hold, press [SP-PHONE].
- Handset users can take the call by pressing [↶].

Note for handset and base unit:

- While an outside call is on hold, the IN USE indicator on the base unit flashes.
- If another phone is connected to the same line (page 14), you can also take the call by lifting its handset.
- If a call is kept on hold for more than 9 minutes, an alarm tone starts to sound. After 1 additional minute on hold, the call is disconnected.

Mute

While mute is turned on, you can hear the other party, but the other party cannot hear you.

Handset

To mute your voice, press **[MUTE]**.

- To return to the conversation, press **[MUTE]** or **[↶]**.

Note:

- **[MUTE]** is a soft key visible on the handset display during a call.

Base unit

To mute your voice, press **[MUTE]**.

- To return to the conversation, press **[MUTE]** or **[SP-PHONE]**.

RECALL button

Pressing **[RECALL]** allows you to use special features of your host PBX such as transferring an extension call, or accessing optional telephone services such as Call Waiting.

Note:

- To change the flash time, see page 46.

Handset clarity booster

This feature can improve sound clarity when the handset is used in an area where there may be interference. During an outside call, this feature is turned on automatically when necessary. You can also turn this feature on or off manually.

- 1 Press **[MENU]** during an outside call.

- 2 Press **[2]** to select “**Booster on**” or “**Booster off**”.

Note:

- When this feature is turned off manually during a call, it does not turn on automatically during the same call.
- While this feature is turned on;
 - the battery operating time is shortened (page 16).
 - the maximum number of extensions that can be used at a time may decrease.

Handset voice enhancer

This feature can simulate a band signal above the normal bandwidth limitations, achieving a sound which is close to the actual voice. You can turn this feature on or off, depending on the circumstance.

- 1 Press **[MENU]** during an outside call.
- 2 Press **[3]** to select “**Voice enhancer**” or “**V.E. off**”.
 - When this feature is turned on, **[VE]** is displayed.

Note:

- Depending on the condition and quality of your telephone line, this feature may emphasize existing line noise. If it becomes difficult to hear, turn this feature off.

Making/Answering Calls

Call share

This feature allows the handset and base unit to join an existing outside call.

Handset

To join the conversation, press [**↶**] when the other extension is on an outside call.

Base unit

To join the conversation, press [**SP-PHONE**] when the handset is on an outside call.

Note for handset and base unit:

- A maximum of 4 parties (including 1 outside party) can join a conversation using 3 extensions.

Call privacy

Call privacy allows you to prevent other users from joining your conversations with outside callers. To allow other users to join your conversations, leave this feature off.

Handset

1 Press [**MENU**] during an outside call.

2 Press [**1**] to select “Privacy on” or “Privacy off”.

- When this feature is turned on, “PRIV.” is displayed.

Note:

- This feature will turn off after you hang up the call.

Dial lock

This feature prohibits making outside calls. The default setting is OFF.

Important:

- **When dial lock is turned on, only phone numbers stored in the phonebook as emergency numbers (numbers stored with a # at the beginning of the name) can be dialled using the phonebook (page 32). We recommend storing emergency numbers in the phonebook before using this feature.**
- When dial lock is turned on, you cannot store, edit, or erase items in the phonebook.

To turn dial lock on/off

Handset

1 [**MENU**] (middle soft key) → [**≡**] → [**2**][**5**][**1**]

2 To turn dial lock on:

Enter a 4-digit password.

To turn dial lock off:

Enter the same password that was entered when dial lock was turned on.

3 [**SAVE**] → [**YES**] → [**OFF**]

Note:

- If dial lock is turned on, the handset displays “Dial lock on”. While there are missed calls, “Dial lock on” is not displayed when the handset is off the base unit or charger.
- If you forget the password, consult your nearest Panasonic service center.

Base unit

1 [DIAL LOCK]

2 To turn dial lock on:

Enter a 4-digit password.

To turn dial lock off:

Enter the same password that was entered when dial lock was turned on.

3 [DIAL LOCK]

Note:

- If dial lock is turned on, the DIAL LOCK indicator lights.
- If you forget the password, consult your nearest Panasonic service center.

Handset phonebook

You can add up to 50 items to the handset phonebook and search for phonebook items by name.

Important:

- Caller ID subscribers can use ringer ID and light-up ID features (page 37).
- Color display models only (KX-TG5976AL/KX-TGA591AL):
 - Caller ID subscribers can use picture ID feature (page 37).
 - You can also create and edit phonebook items using your computer and send them to the handset. Refer to the help section of the GIGARANGE USB Utility application for more information.

Adding items to the handset phonebook

Monochrome display models:

KX-TG5971AL/KX-TGA590AL

- 1**  (right soft key)
- 2** **[ADD]**
- 3** Enter the name (max. 16 characters; page 32). → **[OK]**
- 4** Enter the phone number (max. 32 digits). → **[OK]**
 - If you do not need to assign the ringer ID and light-up ID, go to step 11.
- 5** “Set Ringer ID” → **[SELECT]**
- 6** Select the desired item.

No Ringer ID	Turns the ringer ID off. Press [SELECT] , then go to step 9.
Tone & Melody	Tone and melodies stored in the handset at the time of purchase.
Custom ring	Melodies you stored in the handset (page 48). 2 melodies are already stored at the time of purchase (page 48).

7 **[SELECT]**

- 8** Select the desired ringer ID (page 37). → **[OK]**

9 “Set Light-up ID” → **[SELECT]**

- 10** Select the desired light-up ID (page 37). → **[OK]**

11 **[SAVE]**

- To add other items, repeat from step 3.

12 **[OFF]**

Note:

- In step 2, you can also press **[MENU]** → “New entry” → **[SELECT]** instead of pressing **[ADD]**.
- To assign a melody in “Custom ring” as ringer ID, you can record it from an audio device (page 48).
- If you select “No Ringer ID” (default), the handset uses the ringer tone you selected on page 46 when a call is received from that caller.

- If you select “No Light-up ID” (default), the handset uses the ringer indicator color you selected on page 46 when a call is received from that caller.

**Color display models:
KX-TG5976AL/KX-TGA591AL**

- 1 [📖] (right soft key)
- 2 [ADD]
- 3 Enter the name (max. 16 characters; page 32). → [OK]
- 4 Enter the phone number (max. 32 digits). → [OK]
 - If you do not need to assign the ringer ID, light-up ID, and picture ID, go to step 15.
- 5 “Set Ringer ID” → [SELECT]
- 6 Select the desired item.

No Ringer ID	Turns the ringer ID off. Press [SELECT], then go to step 9.
Tone & MeLOdy	Tone and melodies stored in the handset at the time of purchase.
Custom ring	Melodies you stored in the handset (page 48). 2 melodies are already stored at the time of purchase (page 48).

- 7 [SELECT]
- 8 Select the desired ringer ID (page 37). → [OK]

- 9 “Set Light-up ID” → [SELECT]
- 10 Select the desired light-up ID (page 37). → [OK]
- 11 “Set Picture ID” → [SELECT]
- 12 Select the desired item.

No Picture ID	Turns the picture ID off. Press [SELECT], then go to step 15.
Sample pictures	Images stored in the handset at the time of purchase.
My pictures	Images you stored in the handset.

- 13 [SELECT]
- 14 Select the desired picture ID (page 37). → [OK]
- 15 [SAVE]
 - To add other items, repeat from step 3.

16 [OFF]

Note:

- In step 2, you can also press [MENU] → “New entry” → [SELECT] instead of pressing [ADD].
- To assign a melody in “Custom ring” as ringer ID, you can record it from an audio device (page 48) or copy it from your computer (refer to the help section of the GIGARANGE USB Utility application).
- If you select “No Ringer ID” (default), the handset uses the ringer tone you selected on page 46 when a call is received from that caller.

Phonebook

- If you select “**No Light-upID**” (default), the handset uses the ringer indicator color you selected on page 46 when a call is received from that caller.
- To assign an image in “**My pictures**” as picture ID, you can copy it from your computer (refer to the help section of the GIGARANGE USB Utility application).

To store emergency numbers

Emergency numbers are numbers stored in the phonebook that can be dialed using the phonebook even when dial lock is turned on (page 28).

To store a number as an emergency number, add # at the beginning of the name (see “Adding items to the handset phonebook”).

Character table for entering names

Key	Character
[1]	# & ' () * , - . / 1
[2]	a b c A B C 2
[3]	d e f D E F 3
[4]	g h i G H I 4
[5]	j k l J K L 5
[6]	m n o M N O 6
[7]	p q r s P Q R S 7
[8]	t u v T U V 8
[9]	w x y z W X Y Z 9
[0]	Space 0
[#]	#

Note:

- To enter another character that is located on the same dial key, first press

[▶] to move the cursor to the next space.

Editing/correcting a mistake

Press [◀] or [▶] to move the cursor to the character or number you want to erase, then press [CLEAR]. Enter the appropriate character or number.

Note:

- Press and hold [CLEAR] to erase all characters or numbers.

Finding and calling a handset phonebook item

Phonebook items can be searched for alphabetically by scrolling through the phonebook items or by initial.

Searching for a name alphabetically by scrolling through all items

1 [📖] (right soft key) → [SEARCH]

2 Press [▲] or [▼] to select the desired item.

3 Press [📞] or [CALL] to dial the phone number.

Searching for a name by initial

1 [📖] (right soft key) → [SEARCH]

2 Press the dial key ([0] – [9], or [#]) that corresponds to the first letter you are searching for (see the character table on the left).

Example: “LISA”

Press **[5]** repeatedly to display the first phonebook entry starting with the initial "1" and go to step 3.

- If there is no item corresponding to the letter you selected, the next item is displayed.

3 Press **[v]** to select the desired item.

4 Press **[↶]** or **[CALL]** to dial the phone number.

Editing items in the handset phonebook

1 **[📖]** (right soft key) → **[SEARCH]**

2 Find the desired item (page 32). → **[EDIT]**

3 Select the information you want to edit.

To change the name or phone number	Select the name or phone number. → [SELECT] → Edit the information (page 32). → [OK]
To change the ringer ID	Select the current ringer ID. → [SELECT] → Select the desired item.*1 → [SELECT] → Select the desired ringer ID. → [OK] *1 To turn the ringer ID off, select "No Ringer ID". → [SELECT]

To change the light-up ID	Select the current light-up ID. → [SELECT] → Select the desired light-up ID.*2 → [OK] *2 To turn the light-up ID off, select "No Light-up ID".
To change the picture ID (Color display models only: KX-TG5976AL/ KX-TGA591AL)	Select the current picture ID. → [SELECT] → Select the desired item.*3 → [SELECT] → Select the desired picture ID. → [OK] *3 To turn the picture ID off, select "No Picture ID". → [SELECT]

4 **[SAVE]** → **[OFF]**

Erasing an item in the handset phonebook

1 **[📖]** (right soft key) → **[SEARCH]**

2 Find the desired item (page 32).

3 **[MENU]** → "Erase" → **[SELECT]**

4 "Yes" → **[SELECT]** → **[OFF]**

Chain dial

This feature allows you to dial phone numbers in the handset phonebook while you are on a call. This feature can be used, for example, to dial a calling card access number or bank account PIN that you have stored in the handset phonebook, without having to dial manually.

- 1 During an outside call, press **[]**.
- 2 Find the desired item (page 32). → **[CALL]**

Note:

- When storing a calling card access number and your PIN in the phonebook as one phonebook item, press **[PAUSE]** to add pauses after the number and PIN as necessary (page 24).

Copying handset phonebook items

You can copy one or all of the phonebook items from the handset to the phonebook of a compatible Panasonic handset (KX-TGA590AL/KX-TGA591AL).

Important:

- Ringer ID and light-up ID for phonebook items are not copied.
- Color display models only (KX-TG5976AL/KX-TGA591AL):
Picture ID for phonebook items is not copied.

Copying an item

- 1 **[]** (right soft key) → **[SEARCH]**
- 2 Find the desired item (page 32). → **[MENU]**

3 “Copy” → **[SELECT]**

4 Select the handset to copy to. → **[SEND]**

- To continue copying another item: “Yes” → **[SELECT]** → Find the desired handset phonebook item. → **[SEND]**

5 Press **[OFF]** after the long beep.

Copying all items

1 **[]** (right soft key)

2 **[MENU]**

3 “Copy all items” → **[SELECT]**

4 Select the handset to copy to. → **[SEND]**

5 Press **[OFF]** after the long beep.

Base unit speed dialer

You can assign one phone number to each of the 10 dial keys ([0] – [9]) on the base unit.

Adding phone numbers to the speed dialer

Important:

- Before adding phone numbers, make sure the base unit is not being used.

1 [PROGRAM]

2 Enter the phone number (max. 32 digits).

- If a pause is required for dialing, press [PAUSE] where needed.
- If you misdial, press [STOP] and repeat from step 1.

3 [PROGRAM]

4 Press a dial key ([0] – [9]).

Note:

- If a phone number is assigned to a dial key which already contains a phone number, the old number will be erased.
- We recommend you make a note of which phone numbers are stored in which dial keys.

PAUSE button (for PBX/long distance service users)

A pause is sometimes required when making calls using a PBX or long distance service.

For example, if you need to dial the line access number “9” when making outside calls with a PBX:

In step 2, press [9], [PAUSE], then enter the phone number.

Note:

- A 3.5 second pause is inserted each time [PAUSE] is pressed. Press repeatedly to insert longer pauses. “P” is displayed when [PAUSE] is pressed.
- When [✖] is pressed, “L” is displayed. When [≡] is pressed, “=” is displayed.

To erase a stored phone number

1 Press [PROGRAM] 2 times.

2 Press the desired dial key ([0] – [9]).

Calling someone with the speed dialer

1 [SP-PHONE] → [AUTO]

2 Press the desired dial key ([0] – [9]).

Note:

- Speed dial numbers assigned to the base unit dial keys can only be dialed from the base unit.

Using Caller ID service

This unit is Caller ID compatible. To use Caller ID features, you must subscribe to Caller ID service of your telephone service provider.

Caller ID features

When an outside call is being received, the calling party's telephone number is displayed.

Telephone numbers for the last 50 callers are logged in the caller list by the most recent call to the oldest.

- Generally caller information is displayed from the 2nd ring.
- If the unit cannot receive caller information, the following is displayed:
 - “**Out of area**”: The caller dialed from an area which does not provide Caller ID service.
 - “**Private caller**”: The caller requested not to send caller information.
- If the unit is connected to a PBX system, caller information may not be received properly. Consult your PBX supplier.
- If the name display service is available in your area, the display shows caller names. For further information, please contact your service provider/telephone company.

Missed calls

If a call is not answered, the unit treats the call as a missed call. “**Missed call**” is displayed on the handset display. This lets you know if you should view the caller list to see who called while you were out.

You can view the number of missed calls by pressing [**CID**] (left soft key).

Note:

- If you press [**CID**], then press [**OFF**] without viewing all missed calls in the caller list, “**Missed call**” disappears from the display. When you receive another new call, it is displayed again.

Phonebook name display

When caller information is received and it matches a phone number stored in the phonebook, the stored name is displayed and logged in the caller list.

Call waiting and Caller ID compatible

If you subscribe to Caller ID service, your handset displays the 2nd caller's information while talking. After you hear a call waiting tone, the caller's phone number will be displayed.

You can answer the 2nd call, keeping the 1st call on hold.

Follow your service provider/telephone company instructions using [**RECALL**].

- If the phone number is stored in the phonebook with its name, the caller's name will also be displayed.
- Please contact your service provider/telephone company for details and availability in your area.

For Caller ID Type II users

When you receive a 2nd call during a conversation, you will hear a signal tone following the call waiting tone and the **conversation will be interrupted or muted for a short period of time**. This is

not a fault of the product as these events are normal.

- The tones are generated by your service provider/telephone company.

Ringer ID

This feature can help you identify who is calling by using different ringers for different callers stored in the phonebook (page 30). You can assign a different ringer to each phonebook item. When a call is received from a caller stored in the phonebook, the assigned ringer rings after Caller ID information is displayed.

- The ringer may be changed after the 2nd ring.

Light-up ID

This feature can help you identify who is calling by using different ringer indicator colours for different callers stored in the handset phonebook (page 30). You can assign a different indicator colour to each handset phonebook item. When a call is received from a caller stored in the handset phonebook, the assigned indicator colour flashes after Caller ID information is displayed.

- The indicator colour may be changed after the 2nd ring.

Picture ID (Colour display models only)

Important:

- Only KX-TG5976AL and KX-TGA591AL support this feature.

This feature can help you identify who is calling by using different pictures for different callers stored in the handset phonebook (page 30). You can assign a different picture to each phonebook item. When a call is received from a caller stored in the phonebook, the assigned picture is displayed after Caller ID information is displayed.

Note:

- You can also download original images from your computer. Refer to the help section of the GIGARANGE USB Utility for details.

Caller list

Important:

- Only 1 person can access the caller list at a time.

Viewing the caller list and calling back

1 [CID] (left soft key)

2 Press [▼] to search from the most recent call, or [▲] to search from the oldest call.

3 [↶]

Note:

- If you do not want to dial the area codes when making calls from the Caller ID list, you can store the area codes which you want the unit to delete automatically (page 38).
- A ✓ is displayed in caller information which has already been viewed or answered by any handset.
- If an arrow (→) is displayed after the number, the whole phone number is not shown. Press [▶] to see the remaining numbers. To return to the previous display, press [◀].

Storing your area code

We recommend storing your area code before using Caller ID (page 36). Calls from the same area will be recorded in the caller list without the area code. You do not have to remove it before calling back the caller or storing in the phonebook.

1 [MENU] (middle soft key) → [⊕][2][5][5]

2 Enter your area code (max. 8 digits).

- To correct a digit, press [◀] or [▶] to move the cursor, then press [CLEAR]. Enter the correct number.

3 [SAVE] → [OFF]

To erase your area code

Press and hold [CLEAR] in step 2, press [SAVE], then press [OFF].

Editing a caller's phone number before calling back

You can edit a phone number in the caller list by removing its area code and/or the long distance code "1".

1 [CID] (left soft key)

2 Select the desired item. → [EDIT]

3 Add or erase digits to the beginning of the number as necessary.

- To add a digit, press the desired dial key.
- To erase a digit, press [CLEAR] or [⊕].

4 [↶]

Caller ID number auto edit feature

Once you call back an edited number, the unit will remember the Area Code and Format of the Edited Number. Next time when someone calls from the same Area Code, caller information will be customized by the unit as follows:

- When the call is being received, the Caller ID number will be displayed in the same Format as the Edited Number.
- After the call is ended, the telephone number of the caller, when reviewed from the Caller list, will be displayed in the same Format as the Edited Number.

For example, you can use this feature to set the unit to ignore the area code of callers in your area code, so that you can call these local numbers using caller information without dialing the area code. To activate this feature, you must edit an item in the caller list, then call that number. After that, phone numbers from that caller's area code are edited automatically. This feature can be turned on or off (page xx).

Note:

- Phone numbers from the 4 most recently edited area codes are automatically edited.
- If you move to another area, you can turn this feature off to erase previously edited area codes. To use this feature again, turn it on and reprogram the area codes you want to edit once again.

Storing caller information into the handset phonebook

- 1 [CID]** (left soft key)
- 2** Select the desired item.
 - To edit the number, press **[EDIT]**, then edit the number (see step 3 on page 38, "Editing a caller's phone number before calling back").

3 [SAVE]

- 4** Continue from step 3, "Editing items in the handset phonebook", page 33.

Erasing selected caller information

- 1 [CID]** (left soft key)
- 2** Select the desired item.
- 3 [ERASE]** → "Yes" → **[SELECT]** → **[OFF]**

Erasing all caller information

- 1 [CID]** (left soft key)
- 2 [ERASE]** → "Yes" → **[SELECT]**

Programmable settings

You can customize the unit by programming the following features using the handset. To access the features, there are 2 methods:

- scrolling through the display menus (page 40)
- using the direct commands (page 45)
- Mainly the direct command method is used in these operating instructions.
- To change the base unit ringer volume and tone, see page 26.

Programming by scrolling through the display menus

1 [MENU] (middle soft key)

2 Press **[▲]**, **[▼]**, **[◀]**, or **[▶]** to select the desired menu. → **[SELECT]**

- If there are sub-menu(s), press **[▲]** or **[▼]** to select the desired item. → **[SELECT]**

Example: To access the handset ringer volume setting

Press **[▲]**, **[▼]**, **[◀]**, or **[▶]** to select **♪**. → **[SELECT]**

Then press **[▲]** or **[▼]** to select **"Ringer volume"**. → **[SELECT]**

3 Press **[▲]** or **[▼]** to select the desired setting.





- This step may vary depending on the feature being programmed.

4 [SAVE] → **[OFF]**

Monochrome display models: KX-TG5971AL/KX-TGA590AL

● When you find “*1” in the following table, refer to the note below.

*1 If you program these settings using one of the handsets, you do not need to program the same item using another handset.

Main menu	Sub-menu 1	Sub-menu 2	Page	
Answering device 	To play new	–	–	
	To play all	–	–	
	To erase all	–	–	
	Settings	Message alert		60
		Ring count ^{*1}		58
		Recording time ^{*1}		60
Remote code ^{*1}			58	
	Call screening ^{*1}		60	
Ringer setting 	Ringer volume	–	–	
	Ringer tone	Tone & Melody	48	
		Custom ring	48	
	Custom ring	Record	48	
		List	49	
Ring colour	–	–		
Phonebook 	–	–	30	
Set date & time 	Date and time ^{*1}	–	23	
	Time adjustment ^{*1}	–	–	





Programming

Main menu	Sub-menu 1	Sub-menu 2	Page	
Initial setting 	Auto Intercom	–	63	
	Talking CallerID	–	XX	
	Caller ID edit	–	–	
	LCD contrast	–	–	
	Key tone	–	–	
	Auto talk	–	25	
	Set base unit	Talking CallerID ^{*1}		XX
		VM tone detect ^{*1}		61
	Set area code	–	38	
	Set tel line	Set dial mode ^{*1}		XX
		Set flash time ^{*1}		–
		Set line mode ^{*1}		–
	Registration	HS registration		65
		Deregistration		65
	Set date & time	Date and time ^{*1}		23
Time adjustment ^{*1}			–	
Change language	–	23		
Handset name	–	50		
Dial lock	–	–	28	

Color display models: KX-TG5976AL/KX-TGA591AL

● When you find “*1” in the following table, refer to the note below.

*1 If you programme these settings using one of the handsets, you do not need to program the same item using another handset.

Main menu	Sub-menu 1	Sub-menu 2	Page	
Answering device 	To play new	–	–	
	To play all	–	–	
	To erase all	–	–	
	Settings	Message alert		60
		Ring count ^{*1}		58
		Recording time ^{*1}		60
Remote code ^{*1}			58	
	Call screening ^{*1}		60	
Ringer setting 	Ringer volume	–	–	
	Ringer tone	Tone & Melody	48	
		Custom ring	48	
	Custom ring	Record	48	
		List	49	
		Memory status	52	
Ring color	–	–		
Display setting 	Wallpaper	Turn off	51	
		Set picture	51	
		Memory status	52	
	Appearance	–	–	
	LCD contrast	–	–	
Set date & time 	Date and time ^{*1}	–	23	
	Time adjustment ^{*1}	–	–	

Programming

Main menu	Sub-menu 1	Sub-menu 2	Page	
Initial setting 	Auto Intercom	–	63	
	Talking CallerID	–	XX	
	Caller ID edit	–	–	
	Key tone	–	–	
	Auto talk	–	25	
	Set base unit	Talking CallerID ^{*1}		XX
		VM tone detect ^{*1}		61
	Set area code	–	38	
	Set tel line	Set dial mode ^{*1}		–
		Set flash time ^{*1}		–
		Set line mode ^{*1}		–
	Registration	HS registration		65
		Deregistration		65
	Set date & time	Date and time ^{*1}		23
		Time adjustment ^{*1}		–
Handset name	–		50	
Dial lock	–	–	28	

Programming using the direct commands

1 [MENU] (middle soft key) → **[⇄]**

2 Enter the desired feature code.

3 Enter the desired setting code.

- This step may vary depending on the feature being programmed.

4 [SAVE] → [OFF]

Note:

- In the following table, < > indicates the default setting.
- If you make a mistake or enter the wrong code, press **[OFF]**, then start again from step 1.

Feature	Feature code	Setting code	System setting ^{*1}	Page
Auto talk ^{*2}	[2][0][0]	[1]: On [0]: <Off>	–	25
Auto Intercom	[2][7][3]	[1]: On (Ringer On) [2]: On (Ringer Off) [0]: <Off>	–	63
Call screening	[3][1][0]	[1]: <On> [0]: Off	●	60
Custom ring (Customized ringer tone for handset)	[1][6][6]	–	–	48
Dial lock	[6]	(page 28)	●	–
Date and time	[1][0][1]	–	●	23
Deregistration	[1][3][1]	–	–	65
Handset name	[1][0][4]	–	–	50
HS registration (Handset registration)	[1][3][0]	–	–	65
Key tone ^{*3}	[1][6][5]	[1]: <On> [0]: Off	–	–
LCD contrast (Display contrast)	[1][4][5]	[1]–[6]: Level 1–6 <3>	–	–
Message alert	[3][4][0]	[1]: On [0]: <Off>	–	60

Programming

Feature	Feature code	Setting code	System setting ^{*1}	Page
Recording time	[3][0][5]	[1]: 1 min [2]: 2 min [3]: <3 min> [0]: Greeting only	●	60
Remote code	[3][0][6]	Default: 111	●	58
Ring count	[2][1][1]	[2]–[7]: Rings <4 rings> [0]: Toll saver	●	58
Ring colour (Ringer indicator colour)	[2][3][5]	[1]: <Colour1> [2]: Colour2 [3]: Colour3 [4]: Multicolour	–	–
Ringer tone (Handset)	[1][6][1]	–	–	48
Set area code	[0][4]	(page 38)	–	–
Ringer volume (Handset)	[1][6][0]	[1]–[6]: Level 1–6 <6> [0]: Off	–	–
Set dial mode	[1][2][0]	–	–	XX
Set flash time ^{*4}	[1][2][1]	[1]: 700 ms [2]: 600 ms [3]: 400 ms [4]: 300 ms [5]: 250 ms [6]: <110 ms> [7]: 100 ms [8]: 90 ms	●	–
Set line mode ^{*5}	[1][2][2]	[1]: A [2]: 	●	–
Talking CallerID (Handset)	[1][6][2]	[1]: <On> [0]: Off	–	XX
Talking CallerID (Base unit)	[*][1][6] [2]	[1]: <On> [0]: Off	●	XX
Time adjustment ^{*6} (Caller ID subscribers only)	[2][2][6]	[1]: <Caller ID[auto]> [2]: Manual	●	–
To erase all (Erasing all messages)	[3][2][5]	–	–	56

Feature	Feature code	Setting code	System setting ^{*1}	Page
To play all (All message playback)	[3][2][4]	–	–	55
To play new (New message playback)	[3][2][3]	–	–	55
VM tone detect	[3][3][2]	[1]: <On> [0]: Off	●	61

- *1 If “System setting” column is checked, you do not need to program the same item using another handset.
- *2 If you subscribe to Caller ID service and want to view the caller’s information after lifting up the handset to answer a call, turn off this feature.
- *3 Turn this feature off if you prefer not to hear key tones while you are dialing or pressing any keys, including confirmation tones and error tones.
- *4 The recall time depends on your telephone exchange or host PBX. Consult your PBX supplier if necessary.
You can access your service provider/telephone company “Call Waiting” service by having the recall time set at 100 ms, and then follow your service provider/telephone company “Call Waiting” instructions to operate this service.
- *5 Generally, the line mode setting should not be adjusted. If **IN USE** is not displayed or the IN USE indicator on the base unit does not light properly when another phone connected to the same line is in use, you need to change the line mode to “A”.
- *6 This feature allows the unit to automatically adjust the date and time setting when caller information is received. To use this feature, set the date and time first.

Color display models only: KX-TG5976AL/KX-TGA591AL

Feature	Feature code	Setting code	System setting ^{*1}	Page
Appearance (Display color)	[1][8][2]	[1]: <Color1> [2]: Color2 [3]: Color3 [4]: Color4 [5]: Color5	–	–
Memory status	[6][7][0]	–	–	51
Wallpaper	[1][8][1]	–	–	51

- *1 If “System setting” column is checked, you do not need to program the same item using another handset.

Customizing handset ringer tone and display

Handset ringer tone (for outside calls)

You can change the ringer tone heard when an outside call is received.

- You can record melodies for the handset ringer tone from an audio device (page 48).
- Color display models only (KX-TG5976AL/KX-TGA591AL):
You can copy melodies (in WAV file format using a computer) to be used for the handset ringer tone. Refer to the help section of the GIGARANGE USB Utility application for more information.

Handset

1 [MENU] (middle soft key) →
[#][1][6][1]

2 Select the desired item. → **[SELECT]**

Tone & Melody	Tones and melodies stored in the handset at the time of purchase.
Custom ring	Melodies you stored in the handset (page 48). 2 melodies are already stored at the time of purchase.

3 Select the desired item. → **[SAVE]**
→ **[OFF]**

Note:

- If you select a melody for the handset ringer tone, the ringer continues to sound for several seconds if:
 - the caller hangs up before you answer the call.
 - another person answers the call using another phone connected to the same line.
- The preset song “Demo1” in this product is used with the permission of © 2005 Speed Crazy.
- The preset song “Demo2” in this product is used with the permission of © 2005 M-ZoNE Co., Ltd.

Recording melodies from an audio device for ringer tones using the handset (“Custom ring”)

You can record melodies (max. 30 seconds each) from an audio device by connecting the included audio cable. These melodies can be assigned as the handset ringer tone (page 48, 49) and the ringer ID (page 37) for phone numbers stored in the handset phonebook.

Important:

- If a call is received while a melody is being recorded or played back, recording or playback stops automatically. Disconnect the audio cable from the handset to answer the call.

- 1 Connect the handset to the audio device (such as a CD player or computer) using the included audio cable.

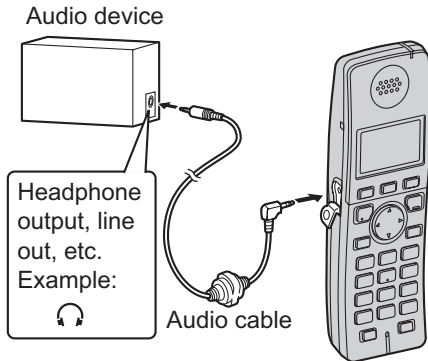

- Handset shown is KX-TGA590AL.
- 2 **[MENU]** (middle soft key) → **[#][1][6][6]**
 - 3 **“Record”** → **[SELECT]**
 - 4 Start playing the audio device.
 - 5 Press **[REC.]** to start recording.
 - 6 To stop recording, press **[STOP]**.
 - To listen to the recording, select **“Playback”**, then press **[SELECT]**.
 - To re-record, select **“Retry”**, press **[SELECT]**, then start from step 3.
 - 7 **“Save”** → **[SELECT]**
 - 8 Enter the desired name (max. 14 characters; page 32).
 - 9 **[SAVE]** → **[OFF]**
 - 10 Disconnect the audio cable from the handset.

Note:

- Monochrome display models (KX-TG5971AL/KX-TGA590AL):
The total recording time is about 90 seconds.
- Color display models (KX-TG5976AL/KX-TGA591AL):
The total recording time is about 7 minutes. The recording time may decrease depending on the size of images and melodies already stored in the handset.

Assigning a customized ring to the handset

Handset

- 1 **[MENU]** (middle soft key) → **[#][1][6][6]**
- 2 **“List”** → **[SELECT]**
- 3 Select the desired item. → **[MENU]**
- 4 **“Set ringer tone”** → **[SELECT]** → **[OFF]**

Changing the name of a melody

Handset

- 1 **[MENU]** (middle soft key) → **[#][1][6][6]**
- 2 **“List”** → **[SELECT]**
- 3 Select the desired item. → **[MENU]**
- 4 **“Rename”** → **[SELECT]**
- 5 Edit the name (max. 14 characters; page 32). → **[SAVE]** → **[OFF]**

Erasing a melody

Handset

- 1** **[MENU]** (middle soft key) → **[#][1][6][6]**
- 2** “List” → **[SELECT]**
- 3** Select the desired item. → **[MENU]**
- 4** “Erase” → **[SELECT]**
- 5** “Yes” → **[SELECT]** → **[OFF]**

Note:

- If the erased melody was used for the handset ringer tone (page 48), “**Tone 1**” (default) is used instead of that melody.
- If the erased melody was assigned to certain callers as ringer ID (page 37), the ringer ID assignment is canceled, and the handset ringer tone (page 48) is used instead of that song.

Changing the handset name

Each handset can be given a customized name (“Bob”, “Kitchen”, etc.), this is useful when you make intercom calls between handsets. The default setting is “**Handset 1**” to “**Handset 8**”.

You can also select whether or not the handset name is displayed in standby mode. The default setting is “**off**”.

Handset

- 1** **[MENU]** (middle soft key) → **[#][1][0][4]**
- 2** Enter the desired name (max. 10 characters; page 32).
 - If not required, go to step 3.
- 3** **[OK]**
- 4** Select the desired setting. → **[SAVE]** → **[OFF]**

Handset wallpaper (Color display models only)

You can select the “wallpaper” pattern shown on the handset display in standby mode. There are 3 preset patterns.

Important:

- Only KX-TG5976AL and KX-TGA591AL support this feature.
- You can also download original images from your computer. Refer to the help section of the GIGARANGE USB Utility for details.

Handset

1 [MENU] (middle soft key) → **[#][1][8][1]**

2 “Set picture” → **[SELECT]**

- To turn this feature off, select “Turn off”. → **[SELECT]** → **[OFF]**

3 Select the desired item. → **[SELECT]**

Sample pictures	Images stored in the handset at the time of purchase.
My pictures	Images you stored in the handset using your computer.

4 Select the desired image.

- To view the image list, press **[LIST]**.
To return to the image view, press **[VIEW]**.

5 [SAVE] → **[OFF]**

Note:

- The preset patterns “wallpaper1” and “wallpaper2” in this product are used

with permission of © 2005 Digital Archive Japan, Inc.

- The preset pattern “wallpaper3” in this product is used with permission of © 2005 MIXA Co., Ltd.

Memory status (Colour display models only)

Important:

- Only KX-TG5976AL and KX-TGA591AL support these features.

You can confirm the amount of handset memory used for your images and melodies. The images and melodies are stored in the same memory (in addition to the preset images and melodies). A maximum of 118 individual files can be stored. The number of stored images and melodies may decrease depending on the size of each file, the number of files, etc.

Memory usage

File type	Quantity	Memory used
Image (wallpaper)	1 image	about 2 %
Image (Picture ID)	3 images	about 1 %
Melody	30 seconds	about 8 %

Viewing the handset memory status

Handset

- 1 **[MENU]** (middle soft key) →
#[#][6][7][0]
- 2 When finished, press **[OFF]**.

Erasing melodies or images

Handset

- 1 **[MENU]** (middle soft key) →
#[#][6][7][0]
- 2 **[MENU]**
- 3 Select the desired option.

To erase only one melody	"1 Custom ring" → [SELECT] → Select the desired item. → [ERASE]
To erase only one image	"1 picture" → [SELECT] → Select the desired item. → [ERASE]
To erase all melodies	"All Custom ring" → [SELECT]
To erase all images	"All pictures" → [SELECT]

- 4 "Yes" → **[SELECT]**
- 5 When finished, press **[OFF]**.

Note:

- If the erased melody was used for the handset ringer tone (page 48), "Tone 1" (default) is used instead of that melody.
- If the erased melody was assigned to certain callers as ringer ID (page 37), the

ringer ID assignment is canceled, and the handset ringer tone (page 48) is used instead of that song.

- If the erased image was selected for the wallpaper, the sample picture "Wallpaper1" is used instead of that image.
- If the erased image was assigned to handset phonebook items, the picture ID assignment is canceled.

Answering system

Important:

- Only 1 person can access the answering system at a time.
- When callers leave messages, the unit records the day and time of each message. Make sure the date and time have been correctly set (page 23).

Memory capacity

The total recording capacity (including caller messages and voice memos) is about 16 minutes.

A maximum of 64 messages can be recorded.

- If the message memory becomes full, the **[MESSAGE]** button on the base unit flashes rapidly. Erase unnecessary messages (page 54).
- If less than 3 minutes of recording time are available, the unit announces the remaining recording time when operating the answering system. Erase unnecessary messages (page 54).

Turning the answering system on/off

Base unit

Press **[ANSWER ON]** to turn on/off the answering system.

- When the answering system is turned on, the **[ANSWER ON]** button lights.
- When the answering system is turned off, the **[ANSWER ON]** button turns off.

Screening calls

While a caller is leaving a message, you can listen to the call through the base unit and handset speakers. To adjust the speaker volume, press **[▲]** or **[▼]** repeatedly.

You can answer the call by pressing **[SP-PHONE]** on the base unit, or by pressing **[↶]** on the handset.

Note:

- To temporarily mute call screening on the handset, press **[SILENCE]**. To raise the volume from mute, press **[▲]** accordingly.
- To turn this feature off, see page 60.

Recording your greeting message

You can record your own greeting message (max. 2 minutes) that is played when the answering system answers a call. If you do not record a greeting message, a prerecorded greeting message is used.

Base unit

- 1 [GREETING REC]**
- 2** Within 10 seconds, press **[GREETING REC]** again.
- 3** After the base unit beeps, speak clearly about 20 cm away from the MIC.
- 4** To stop recording, press **[STOP]**.

Playing back the greeting message

Press **[GREETING CHECK]**.

Erasing your greeting message

Press **[GREETING CHECK]**, and then press **[ERASE]** while your greeting message is playing.

Prerecorded greeting message

If you erase or do not record your own greeting message, the unit plays a prerecorded greeting message for callers and ask them to leave messages. If the message recording time (page 60) is set to "Greeting only", caller messages are not recorded and the unit plays a different prerecorded greeting message asking callers to call again.

Base unit

To play back the pre-recorded greeting message, press **[GREETING CHECK]**.

Note:

- If you changed the caller's recording time to "Greeting only" to listen to its pre-recorded message, remember to reset your original setting (page 60).

Listening to messages using the base unit

When new messages have been recorded, the **[MESSAGE]** button on the base unit flashes.

Press **[MESSAGE]**.

- The unit plays new messages.
- When you have no new messages, the unit plays back all messages.

Adjusting the speaker volume

Press **[▲]** or **[▼]** repeatedly while listening to a message.

Repeating a message

Press **[|◀◀]** during playback.

- If pressed within the first 5 seconds of a message, the previous message is played.

Skipping a message

Press **[▶▶|]** during playback.

Pausing a message

Press **[STOP]** during playback.

- To resume playback, press **[MESSAGE]**.
- To stop playback completely, press **[STOP]** again.

Erasing a message

Press **[ERASE]** during playback.

Erasing all messages

Press **[ERASE]** 2 times while the unit is not being used.

Listening to messages using the handset

When new messages have been recorded:

- “**New message**” is displayed.
- the message indicator on the handset slowly flashes blue if the message alert feature is turned on (page 60).

1 [MENU] (middle soft key) → [PLAY]

- The handset plays new messages including memo messages.
- When you have no new messages, the handset plays back all messages.

2 When finished, press [OFF].

Note:

- You can also listen to the messages as follows:
To play new messages:
[MENU] → [⏏][3][2][3]
To play all messages:
[MENU] → [⏏][3][2][4]
- To switch to the receiver, press [↶].

Adjusting the receiver/speaker volume

Press [▲] or [▼] repeatedly while listening to a message.

Calling back (Caller ID subscribers only)

If Caller ID information was received for the call, you can call the caller back while listening to the message.

- 1 Press **[SELECT]** during playback.
 - To edit the number before calling back, press **[EDIT]** repeatedly to select the desired format (page 38).

2 [CALL]

Answering system commands

You can also operate the answering system by pressing dial keys on the handset during playback.

Key	Command
[1] or [◀]	Repeat message (during playback)* ¹
[2] or [▶]	Skip message (during playback)
[4]	Play new messages
[5]	Play all messages
[8]	Turn answering system on
[9] or [STOP]	Stop playback
[0]	Turn answering system off
[*][4]	Erase currently playing message
[*][5]	Erase all messages

*1 If pressed within the first 5 seconds of a message, the previous message is played.

Erasing a message

1 Press **[ERASE]** during playback.

2 “Yes” → **[SELECT]**

Erasing all messages

1 **[MENU]** (middle soft key) →
[#][3][2][5]

2 “Yes” → **[SELECT]**

Voice memo

Recording a voice memo

You can use the base unit to leave a voice memo (voice message) for yourself or someone else (max. 3 minutes). Voice memos can be played back later with the same operation used to play back answering system messages.

Base unit

1 **[MEMO]**

2 After the unit beeps, speak clearly about 20 cm (8 inches) away from the MIC.

3 To stop recording, press **[STOP]**.

Remote operation

Using a touch tone phone, you can call your phone number from outside and access the unit to listen to messages. The unit's voice guidance prompts you to press certain dial keys to perform different operations.

Important:

- In order to operate the answering system remotely, you must first set a remote code (page 58). This code must be entered each time you operate the answering system remotely.

Using the answering system remotely

- 1 Dial your phone number from a touch tone phone.
- 2 After the greeting message starts, enter your remote code (page 58).
 - The unit plays back new messages.
 - After playing back new messages, the voice guidance starts.
- 3 Follow the voice guidance as necessary.
- 4 When finished, hang up.

Note:

- You can ignore the voice guidance and control the unit using remote commands (page 57).

Voice guidance

During remote operation, the unit's voice guidance prompts you to press **[1]** to perform a specific operation, or press **[2]** to listen to more available operations. Operations are presented by voice guidance in the following order:

- Play back all messages
- Play back new messages
- Record your message
- Erase all messages
- Record your greeting message

Note:

- If you do not press any dial keys within 10 seconds after a voice guidance prompt, the unit disconnects your call.
- If less than 3 minutes of recording time is available, the unit announces the remaining recording time after the last message is played back.

Remote commands

You can press dial keys to access certain answering system functions without waiting for the voice guidance to prompt you.

Key	Remote command
[1]	Repeat message (during playback) ^{*1}
[2]	Skip message (during playback)
[4]	Play new messages
[5]	Play all messages
[7]	Recording a greeting message

Key	Remote command
[9]	Stop recording/ playback*2
[0]	Turn answering system off
[*][4]	Erase currently playing message
[*][5]	Erase all messages

*1 If pressed within the first 5 seconds of a message, the previous message is played.

*2 To resume operation, enter a remote command within 3 seconds, or the voice guidance starts.

Turning on the answering system remotely

If the answering system is off, you can turn it on remotely.

- 1 Dial your phone number.
- 2 Let the phone ring 15 times.
 - The unit answers your call with the greeting message.
 - You can hang up, or if you call from a touch tone phone, you can enter your remote code and begin remote operation (page 57).

Skipping the greeting message to leave a message

You can leave a message just as any outside caller can. Call your phone number. When the answering system picks up, press [*] to skip the greeting message and record your message after the beep.

Answering system settings

Remote code

A remote code must be entered when operating the answering system remotely. This code prevents unauthorised parties from listening to your messages remotely. The default setting is "111".

Handset

1 [MENU] (middle soft key) →
[#][3][0][6]

2 Enter the desired 3-digit remote code.
→ [SAVE] → [OFF]

Ring count

You can change the number of times the phone rings before the unit answers calls. The default setting is "4 rings".
"Toll saver": The unit answers on the 2nd ring when new messages have been recorded, and on the 4th ring when there are no new messages. If you call your phone from outside to listen to new messages (page 57), you will know that there are no new messages when the phone rings for the 3rd time. You can then hang up without being charged for the call.

Handset

1 [MENU] (middle soft key) →
[#][2][1][1]

2 Select the desired setting. → [SAVE]
→ [OFF]

For Service Provider Voice Mail Subscribers

To receive Voice Mail and use answering system properly, please note the following:

- “Voice Mail” is a service provided by your service provider/telephone company. You will need to first subscribe or activate this service through your service provider/telephone company. Consult your service provider/telephone company on how to operate this service and how you will be notified that you have messages on your Voice Mail. To use this service you will be required to leave your answering machine off on your unit. This will allow the Voice Mail to receive any messages. This unit does not have a visual indicator to indicate if there are new messages in your Voice Mail service. Your service provider/telephone company may use a “Stutter” dial tone (special dial tone) to indicate that there are new messages on your Voice Mail.
- To use the unit’s answering machine rather than the Voice Mail service provided by your service provider/telephone company, please consult your service provider/telephone company to have it removed or deactivated permanently or temporarily. Alternatively you can leave this service connected and change the “**Ring count**” to a shorter duration on your unit so your unit’s answering machine can pick up the call prior to the Voice Mail provided by your service provider/telephone company.

Note:

- Provider Voice Mail can capture messages that can be missed while the customer is on the Internet.

Caller's recording time

You can change the maximum message recording time allotted to each caller.

The default setting is "3 min".

"**Greeting only**": The unit plays the greeting message but does not record caller messages.

Handset

1 **[MENU]** (middle soft key) →
[#][3][0][5]

2 Select the desired setting. → **[SAVE]**
→ **[OFF]**

Note:

- If the message memory becomes full, the unit automatically switches to the "**Greeting only**" mode and no new messages are recorded. If you have recorded your own greeting message, that same greeting message is announced to callers even though their messages are not recorded. If you have not recorded your own greeting message, the prerecorded message used for "**Greeting only**" mode is announced to callers (page 54).
- "**Greeting only**" cannot be set by scrolling through the display menus (page 40).

Message alert

You can select whether or not the message indicator on the handset slowly flashes blue when new messages are recorded (page 55). The default setting is "off".

Important:

- If there are new messages in your mailbox service (page 61), the message indicator also slowly flashes blue.

Handset

1 **[MENU]** (middle soft key) →
[#][3][4][0]

2 Select the desired setting. → **[SAVE]**
→ **[OFF]**

Note:

- While message alert feature is on, battery operating time is shortened (page 16).
- If you have new messages and message alert feature is on, the message indicator does not indicate battery charge status (page 15). The indicator slowly flashes blue until you listen to all new messages.

Call screening

This feature allows you to monitor a message from the base unit and handset speakers when the answering system is recording the message. The default setting is "On".

Handset

1 **[MENU]** (middle soft key) →
[#][3][1][0]

2 Select the desired setting. → **[SAVE]**
→ **[OFF]**

Using Voice Mail service

Voice Mail is an automatic answering service offered by your telephone service provider. After you subscribe to this service, the telephone service provider's Voice Mail system will answer calls for you when you are unavailable to answer the phone or when your line is busy. Messages are recorded by the telephone service provider, not your telephone.

Important:

- To use the Voice Mail service provided by your telephone service provider rather than the unit's answering system, turn off the answering system (page 53).

Voice Mail message indication

The unit lets you know that you have new Voice Mail messages in the following ways:

- “**New Voice Mail**” is displayed on the handset.
- The message indicator on the handset slowly flashes blue if the message alert feature is turned on (page 60).

In order to listen to your Voice Mail messages, you must dial your telephone service provider's Voice Mail access number.

Note:

- If the handset still indicates there are new messages even after you have listened to all new messages, turn it off by pressing and holding **[OFF]** on the handset until the handset beeps.
- If your Voice Mail service uses Voice Mail tones and the message is over 3

minutes long, the handset may not indicate new messages.

Voice Mail (VM) tone detection

Your telephone service provider sends special signals (sometimes called “Voice Mail tones” or “stutter tones”) to the unit to let you know you have new Voice Mail messages. If you hear a series of dial tones followed by a continuous dial tone after you press **[** or **[SP-PHONE]**, you have new Voice Mail messages. Minutes after you hang up a call or after the phone stops ringing, your unit will check the phone line to see if new Voice Mail messages have been recorded.

Turn this feature off when:

- you do not subscribe to Voice Mail service.
 - your telephone service provider does not send Voice Mail tones.
 - your phone is connected to a PBX.
- If you are not sure which setting is required, consult your telephone service provider.

Turning VM tone detection on/off

The default setting is “On”.

Handset

1 **[MENU]** (middle soft key) → **[#][3][3][2]**

2 Select the desired setting. → **[SAVE]** → **[OFF]**

Intercom

Intercom calls can be made:

- between the handset and base unit
- between handsets

Note:

- If you receive an outside call while talking on the intercom, you hear 2 tones. To answer the call with the handset, press **[OFF]**, then press **[↶]**. To answer the call with the base unit, press **[SP-PHONE]** 2 times.
- You can locate a misplaced handset by paging it (handset locator).

Making an intercom call

Handset

1 [INTERCOM]

2 Select the desired unit. → [CALL]

- The destination unit beeps for 1 minute.
- To stop paging, press **[OFF]**.

3 When you finish talking, press **[OFF]**.

Note:

- If a USB adaptor (KX-TGA595AL) is registered to the base unit, its extension number is not displayed on the handset.
- If a cordless camera (KX-TGA593AL) is registered to the base unit, its extension number is not displayed on the monochrome display models (KX-TGA590AL).

Base unit

1 [INTERCOM]

2 To page a specified handset, enter its extension number (**[1]** – **[8]**).

To page all handsets, press **[0]**.

- The destination unit(s) beeps for 1 minute.
- To stop paging, press **[INTERCOM]**.

3 When you finish talking, press **[SP-PHONE]**.

Answering an intercom call

Handset

1 Press **[↶]** or **[↷]** to answer the page.

2 When you finish talking, press **[OFF]**.

Base unit

1 Press **[SP-PHONE]** or **[INTERCOM]** to answer the page.

2 When you finish talking, press **[SP-PHONE]**.

Note for handset and base unit:

- When the ringer volume is set to off, the handset or the base unit rings at the low level for intercom calls.

Auto intercom/Room monitor

This feature allows you to:

- answer an intercom call without pressing any buttons on the handset.
- listen to the sound in a room where the handset is located.

Turning auto intercom on/off

“off” (Default): Turns this feature off.

“On (Ringer On)”: When an intercom call is received, the handset rings 2 times then the speakerphone is automatically turned on.

“On (Ringer Off)”: When an intercom call is received, the handset does not ring and the speakerphone is automatically turned on. This allows you to easily monitor a baby’s room, for example, from different areas of the house.

Handset

1 [MENU] (middle soft key) →
[#][2][7][3]

2 Select the desired setting.

3 [SAVE] → **[OFF]**

Note:

- This feature cannot be used when the base unit is paging all handsets, or when receiving a transferred call.

Answering an intercom call using auto intercom

Handset

1 When you are paged by the base unit or another handset, speak into the microphone.

- To switch to the receiver, press **[↶]**.

2 To end the intercom, press **[OFF]**.

Note:

- Auto intercom cannot be used when:
 - all handsets are being paged by the base unit.
 - your handset is receiving a transferred outside call.

Monitoring audio in a room

With a handset or the base unit, you can listen to the sound in a room where another handset is located.

Important:

- Before using this feature, set auto intercom of the destination handset to **“On (Ringer Off)”** to allow access by other handsets.

Handset

1 Call the destination handset (page 62).

- You can listen to the audio.

2 To mute your sound output, press **[MUTE]** if necessary.

3 Press **[OFF]** to stop monitoring.

Base unit

1 Call the destination handset (page 62).

- You can listen to the audio.

2 To mute your sound output, press **[MUTE]** if necessary.

3 Press **[INTERCOM]** to stop monitoring.

Transferring calls

Outside calls can be transferred between the handset and base unit, and between 2 handsets.

Handset

- 1 During an outside call, press **[INTERCOM]** to put the call on hold.
- 2 Select the desired unit. → **[CALL]**
- 3 Wait for the paged party to answer.
 - If the paged party does not answer, press **[↶]** to return to the outside call.
- 4 To complete the transfer, press **[OFF]**.
 - The outside call is being routed to the unit.

Base unit

- 1 During an outside call, press **[INTERCOM]** to put the call on hold.
- 2 To page a specified handset, enter its extension number (**[1] – [8]**).
To page all handsets, press **[0]**.
 - Even if you call all handsets, only the handset user who answers first can take the transferred call.
- 3 Wait for the paged party to answer.
 - If the paged party does not answer, press **[INTERCOM]** to return to the outside call.
- 4 To complete the transfer, press **[SP-PHONE]**.

- The outside call is being routed to the handset.

Answering transferred calls

Handset

Press **[↶]** to answer the page.

Base unit

Press **[SP-PHONE]** to answer the page.

Note for handset and base unit:

- After the paging party disconnects, you can talk to the outside caller.

Conference calls

The handset and base unit, or 2 handsets can have a conference call with an outside party.

Handset

- 1 During an outside call, press **[INTERCOM]** to put the call on hold.
- 2 Select the desired unit. → **[CALL]**
- 3 Wait for the paged party to answer.
- 4 When the paged party answers, press **[CONF]** to make a conference call.
 - To leave the conference, press **[OFF]**. The other parties can continue the conversation.
 - To put the outside call on hold, press **[HOLD]**. To resume the conference, press **[CONF]**.

Base unit

- 1 During an outside call, press **[INTERCOM]** to put the call on hold.
- 2 To page a specified handset, enter its extension number (**[1]** – **[8]**). To page all handsets, press **[0]**.
- 3 Wait for the paged party to answer.
- 4 When the paged party answers, press **[CONF]** to make a conference call.
 - To leave the conference, press **[SP-PHONE]**. The other parties can continue the conversation.
 - To put the outside call on hold, press **[HOLD]**. To resume the conference, press **[CONF]**.

Registering a handset

The included handset and base unit are preregistered. If for some reason the handset is not registered to the base unit, register the handset.

Important:

- If you have already deregistered the handset, perform steps 2 and 3 only.

1 Handset:

[MENU] (middle soft key) → **[#][1][3][0]**

2 Base unit:

Press and hold **[INTERCOM]** until the IN USE indicator flashes.

- After the IN USE indicator starts flashing, the rest of the procedure must be completed within 90 seconds.

3 Handset:

Press **[OK]**, then wait until a beep sounds.

Registering an additional handset

See page 6 for information on the available models and extension numbers. Start from step 2.

Deregistering a handset

Handset

1 **[MENU]** (middle soft key) → **[#][1][3][1]**

2 **[3][3][5]** → **[OK]**

Deregistering other devices

The base unit can cancel the registration of a registered device (KX-TGA593AL/KX-TGA595AL, page 6).

Deregistering the cordless camera (KX-TGA593AL)

Important:

- Before deregistering, confirm the cordless camera's extension number (color display models only: KX-TG5976AL/KX-TGA591AL). Press **[INTERCOM]** on the handset to display its extension.

Base unit

- 1** Press and hold **[INTERCOM]** until the IN USE indicator flashes.
- 2** Press and hold the cordless camera's extension number (**[1]** – **[8]**) until a beep sounds.

Deregistering the USB adaptor (KX-TGA595AL)

Base unit

- 1** Press and hold **[INTERCOM]** until the IN USE indicator flashes.
- 2** Press and hold **[*]** until a beep sounds.

Wall mounting

Base unit

- 1** Tuck the telephone line cord inside the wall mounting adaptor (**1**).
Connect the AC adaptor and telephone line cord to the base unit (**2**).

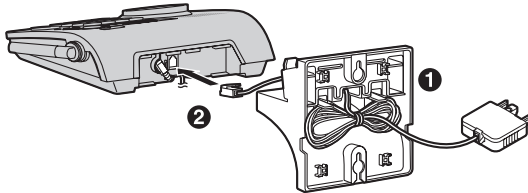

- 2** Insert the hooks on the wall mounting adaptor into the holes (**A**) and (**B**) on the base unit.

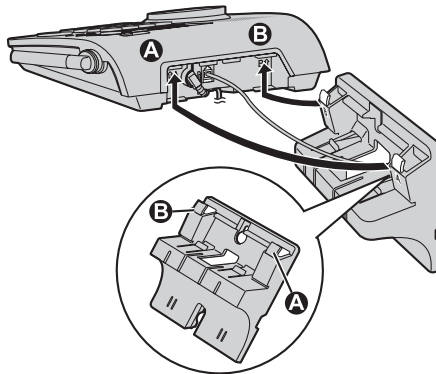

Useful Information

- 3** Adjust the adaptor to hold the base unit, then push it in the direction of the arrow until it clicks into place.

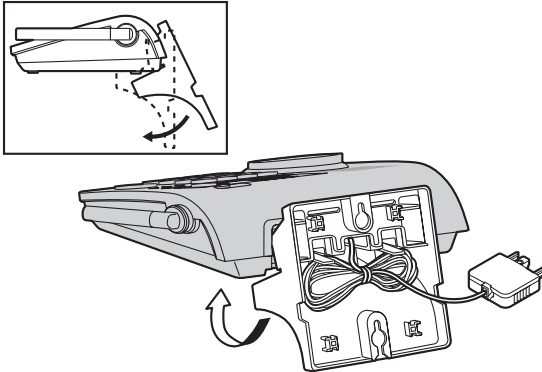

- 4** Drive the screws (not included) into the wall using the wall mount template (see below) as a guide. Mount the unit and slide it down into position. Connect the AC adaptor and telephone line cord to their respective outlets. Raise the antennas.

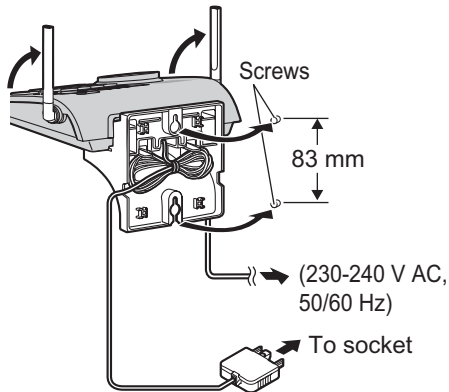

Wall mount template for the base unit

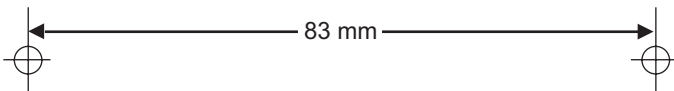

To remove the wall mounting adaptor

While pushing down the release levers (❶), remove the adaptor (❷).

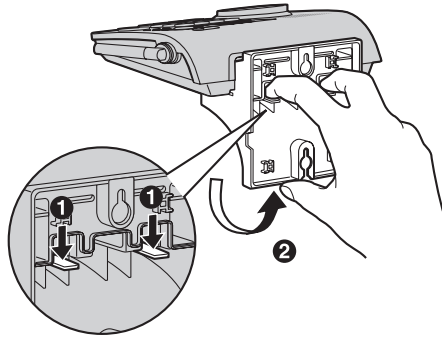

Additional accessories

Headset (optional)

Connecting a headset to the handset allows hands-free phone conversations. We recommend using the Panasonic headset noted on page 9.



- Headset shown is KX-TCA86AL.
- Handset shown is KX-TGA590AL.

Note:

- Only telecommunications compliance labelled headsets should be plugged into the headset jack on the handset.

Belt clip (optional)

By purchasing the optional belt clip PQKE10457ZA1, you can hang the handset on your belt or pocket.

Error messages

If the unit detects a problem, one of the following messages is shown on the display.

Display message	Cause/solution
Busy	<ul style="list-style-type: none"> • The called handset or base unit is in use. • Privacy mode is on for the call you tried to join (page 28). • Other units are in use and the system is busy. Try again later.
Dial locked	<ul style="list-style-type: none"> • Dial lock is turned on. To turn it off, see page 28.
Error!!	<ul style="list-style-type: none"> • The handset's registration has failed. Move the handset and base unit away from all electrical appliances and try again. • 8 handsets have already been registered to the base unit. A previously deregistered handset number may still be retained in the base unit. To register an additional handset, erase the unnecessary handset number using the base unit: Press and hold [INTERCOM] until the IN USE indicator flashes. → Press and hold the handset's extension number ([1] – [8]) that you want to cancel/delete from the base unit until a beep sounds. • The entered password was wrong in programming dial lock. Enter the correct password.
Failed	<ul style="list-style-type: none"> • The handset you tried to copy phonebook items to is in use. • The handset you tried to copy phonebook items to is out of area.
Incomplete	<ul style="list-style-type: none"> • The destination handset's phonebook memory is full. Erase unnecessary items from the destination handset's phonebook (page 33).
Invalid. Please register to the base unit	<ul style="list-style-type: none"> • The handset is not registered to the base unit. Register the handset (page 65).

Useful Information

Display message	Cause/solution
No items stored	<ul style="list-style-type: none">● Your phonebook or redial list is empty.● Color display models only (KX-TG5976AL/KX-TGA591AL): "My pictures" is empty.
No link to base. Move closer to base, try again.	<ul style="list-style-type: none">● The handset has lost communication with the base unit. Move closer to the base unit, and try again.● Confirm that the base unit's AC adaptor is plugged in.● Raise the base unit antennas.● The handset's registration may have been canceled. Re-register the handset (page 65).
Phonebook Memory full	<ul style="list-style-type: none">● There is no space to store new items in the phonebook. Erase unnecessary items (page 33).
Please lift up and try again.	<ul style="list-style-type: none">● A handset button was pressed while the handset was on the base unit or charger. Lift the handset and press the button again.

Troubleshooting



General use

Problem	Cause/solution
The unit does not work.	<ul style="list-style-type: none"> ● Make sure the battery is installed correctly and fully charged (page 15). ● Check the connections (page 14). ● Unplug the base unit's AC adaptor to reset the unit. Reconnect the adaptor and try again. ● The handset has not been registered to the base unit. Register the handset (page 65).
I cannot hear a dial tone.	<ul style="list-style-type: none"> ● Confirm the telephone line cord is properly connected (page 14). ● Disconnect the unit from the telephone line and connect a known working telephone. If the working telephone operates properly, contact our service personnel to have the unit repaired. If the working telephone does not operate properly, contact your telephone service provider.

Programmable settings

Problem	Cause/solution
I cannot programme items.	<ul style="list-style-type: none"> ● While another user is listening to messages, you cannot programme items. Try again later.
While programming, the handset starts to ring.	<ul style="list-style-type: none"> ● A call is being received. Answer the call and start again after hanging up.

Battery recharge

Problem	Cause/solution
I fully charged the battery, but  continues to flash, or  is displayed.	<ul style="list-style-type: none"> ● Clean the charge contacts and charge again (page 15). ● The battery may need to be replaced with a new one (page 15).
The handset display is blank.	<ul style="list-style-type: none"> ● Confirm that the battery is properly installed. ● Fully charge the battery (page 15).

Useful Information

Making/answering calls, intercom

Problem	Cause/solution
⚡ is displayed, but you cannot make a call.	<ul style="list-style-type: none">● The handset and base unit could not communicate for some reason, such as interference from other electrical appliances. Perform the following:<ul style="list-style-type: none">– Move the handset and base unit away from other electrical appliances.– Move closer to the base unit.– Raise the base unit antennas.
Static is heard, sound cuts in and out. Interference from other electrical units.	<ul style="list-style-type: none">● Move the handset and base unit away from other electrical appliances.● Move closer to the base unit.● Raise the base unit antennas.● Turn on the clarity booster feature (page 27).● If your unit is connected to a telephone line with ADSL service, we recommend connecting a noise filter between the base unit and the telephone line socket. Contact your ADSL provider for details.
The handset and base unit do not ring.	<ul style="list-style-type: none">● The ringer volume is turned off. Adjust it (page 26, 46).
I cannot make a call.	<ul style="list-style-type: none">● The base unit or another handset is in use. Try again later.● Dial lock is turned on. To turn it off, see page 28.● If the above remedies do not solve the problem, set the dialling mode. Press [MENU] [0] [5] [1] [Save] [OFF].● The unit is not designed to be used with rotary (pulse dialling) services.
I cannot redial by pressing [REDIAL] .	<ul style="list-style-type: none">● If the last number dialed was more than 48 digits long, the number will not be redialed correctly. Dial the number manually.● Dial lock is turned on. To turn it off, see page 28.
I cannot have a conversation using the headset.	<ul style="list-style-type: none">● Make sure that an optional headset is connected properly (page 70).● We recommend using the Panasonic headset noted on page xx.
I cannot page the handset or base unit.	<ul style="list-style-type: none">● The called handset is too far from the base unit.● The called unit is in use. Try again later.

Problem	Cause/solution
I cannot turn the clarity booster on.	<ul style="list-style-type: none"> ● Another handset is already using this feature.

Caller ID

Problem	Cause/solution
The handset does not display the caller's phone number.	<ul style="list-style-type: none"> ● You have not subscribed to Caller ID service. Contact your telephone service provider to subscribe. ● If your unit is connected to any additional telephone equipment such as a Caller ID box or cordless telephone jack, disconnect the unit from the equipment and plug the unit directly into the wall jack. ● If your unit is connected to a telephone line with ADSL service, we recommend connecting a noise filter between the base unit and the telephone line socket. Contact your ADSL provider for details. ● Other telephone equipment may be interfering with this unit. Disconnect the other equipment and try again. ● The caller requested not to send caller information (page 36). ● If a call is being transferred to you, the caller information is not displayed. ● Generally, caller information is displayed from the 2nd ring.
The caller list/incoming phone numbers are not edited automatically.	<ul style="list-style-type: none"> ● The Caller ID number auto edit feature is turned off. Turn it on and try again (page xx). ● You need to call back the edited number to activate Caller ID number auto edit.

Useful Information

Answering system

Problem	Cause/solution
I cannot listen to messages from a remote location.	<ul style="list-style-type: none">● A touch tone phone is required for remote operation.● Enter the remote code correctly (page 57).● The answering system is off. Turn it on (page 58).
The unit does not record new messages.	<ul style="list-style-type: none">● The answering system is off. Turn it on (page 53, 58).● The recording time is set to “Greeting only”. Select a different setting (page 60).● The message memory is full. Erase unnecessary messages (page 54).● If you subscribe to the Voice Mail service, messages are recorded by the telephone service provider not your telephone (page 59).
I cannot operate the answering system.	<ul style="list-style-type: none">● Someone is operating the answering system.● If someone is talking on a conference call, you cannot operate the answering system. Try again later.
The message indicator on the handset slowly flashes blue.	<ul style="list-style-type: none">● New messages have been recorded. Listen to the new messages (page 54, 55).

Instructions to customer

Installation

Attached to this apparatus is an approval label. This label is evidence that it is a "Permitted Attachment" which has been authorised to be connected to your telephone service.

Conditions relating to connection and operation of this Permitted Attachment are contained in Telecommunications General By-Law 220 (5).

You are authorised to install this Permitted Attachment yourself by plugging it into the line socket of any regular telephone. You may connect it in place of your existing telephone or to any spare telephone socket installed in your premises.

To disconnect your existing telephone you must first remove its plug from the line socket. You can then insert the plug of your Permitted Attachment into the socket and use your equipment.

If the plug of your existing telephone cannot be readily removed, you will have to remove the screw securing it. To do this proceed as follows:

1. Loosen screw "A" sufficiently to remove the socket cover. (See Fig. 1.)
2. Remove screw "B" and withdraw the plug. (See Fig. 2.)
3. Replace screw "B". (See Fig. 3.) Ensure that it screws completely into the socket recess. (If the screw is too long, increase the hole depth or replace the screw with one 5 mm shorter.)
4. Replace socket cover and tighten screw "A". (See Fig. 4.)

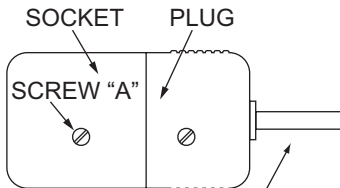

Fig. 1

TELEPHONE CORD
(Connect to the PLUG
as shown in Fig. 1.)

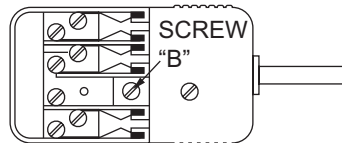

Fig. 2

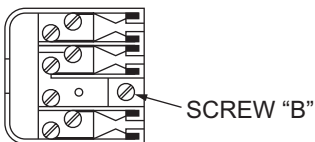

Fig. 3

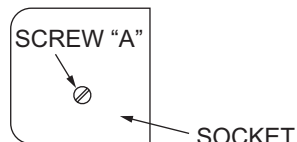

Fig. 4

Useful Information

If you are satisfied with the operation of your telephone service after plugging in your Permitted Attachment, your installation is completed.

You will be unable to connect this Permitted Attachment if your telephone service consists only of a wall phone or an old style telephone which is not connected by means of a modern plug and socket. In such cases a new socket will need to be installed.

Should the Permitted Attachment not operate when plugged into a socket, it is either faulty or unsuitable for operation with your telephone service. It should be returned to the store where purchased or an Authorised Service Centre.

Service difficulties

If at any time a fault occurs on your telephone service, carry out the following checks before you call for service:

- Disconnect the Permitted Attachment and try using the service with the normal telephone.
- If the telephone service then operates satisfactorily, the fault is in your Permitted Attachment. Leave the Permitted Attachment disconnected and report the fault to its supplier or agent to arrange for repair.
- If when using the telephone the service is still faulty, report the fault to "Service Difficulties and Faults" for attention.

You are required to keep this Permitted Attachment in good working order while it is connected to your telephone service. Its construction or internal circuit must not be modified in any way without permission.

WARNING:

This cordless telephone system does not incorporate provision for secrecy of conversations. Appropriately tuned radio equipment and other cordless telephone systems in close proximity may be used by a third party to monitor and possibly interrupt conversations in progress when this system is on radio operation.

Specifications

General

Operating environment	5 °C – 40 °C
Frequency	5.76 GHz – 5.84 GHz

Base unit

Dimensions	Approx. height 55 mm x width 230 mm x depth 140 mm
Mass (Weight)	Approx. 420 g
Power consumption	Standby: Approx. 2.1 W Maximum: Approx. 5.2 W
Power output	200 mW (max.)
Power supply	AC adaptor (230–240 V AC, 50/60 Hz)

Handset

Dimensions	Approx. height 156 mm x width 49 mm x depth 35 mm
Mass (Weight)	Approx. 150 g
Power output	200 mW (max.)
Power supply	Ni-MH battery (2.4 V, 830 mAh)

Note:

- Design and specifications are subject to change without notice.
- The illustrations in these instructions may vary slightly from the actual product.

Index

- A** Answering calls: 25
 - Answering system
 - Erasing messages: 54, 56, 58
 - Listening to messages: 54, 55, 57
 - Turning on/off: 53, 55, 58
 - Appearance (display color): 47
 - Area code: 38
 - Audio cable: 48
 - Auto intercom: 63
 - Auto talk: 25
- B** Battery
 - Charge: 15
 - Installation: 15
 - Level: 16
 - Performance: 16
 - Replacement: 15
 - Belt clip: 9, 70
 - Booster (Clarity booster): 27
- C** Call screening: 53, 60
 - Call share: 28
 - Call waiting and Caller ID compatible: 36
 - Caller ID service: 36
 - Caller list
 - Calling back: 38
 - Editing: 38
 - Erasing: 39
 - Storing: 39
 - Viewing: 38
 - Chain dial: 34
 - Conference calls: 65
 - Connections: 14
 - Custom ring: 48
- D** Date and time: 23
 - Deregistration: 65, 71
 - Dial lock: 28
- Display
 - Contrast: 45
 - Language: 23
- E** Error messages: 71
- F** Flash time: 46
- G** Greeting message: 53
- H** Handset locator: 62
 - Handset name: 50
 - Headset, optional: 70
 - Hold: 26
- I** Installation
 - Base unit: 14
 - Handset: 15
 - Intercom: 62
- J** Joystick: 5
- K** Key tone: 45
- L** Light-up ID: 37
 - Line mode: 46
- M** Making calls: 24
 - MEMO: 56
 - Memory capacity (message recording): 53
 - Memory status (images and melodies): 51
 - Message alert: 60
 - Missed calls: 36
 - Mute: 27
- N** Navigator key: 5
- P** Pause: 24, 35
 - Phonebook: 30
 - Phonebook copy: 34
 - Picture ID: 37
 - Power failure: 14
- R** Recall: 27
 - Recording time: 60
 - Redial list: 24
 - Registration: 65
 - Remote code: 58
 - Remote operation: 57
 - Ring colour: 46

-
- Ring count: 58
 - Ringer ID: 37
 - Ringer off
 - Base unit: 26
 - Handset: 25, 46
 - Ringer tone
 - Base unit: 26
 - Handset: 46
 - Room monitor: 63
 - S** Speed dialer: 35
 - SP-phone: 24
 - T** Time adjustment: 46
 - Toll saver: 58
 - Transferring calls: 64
 - Troubleshooting: 73
 - U** USB cable: 8, 9
 - V** VE (Voice Enhancer): 27
 - VM (Voice Mail) tone detect: 61
 - Voice guidance: 57
 - Voice Mail service: 61
 - Volume
 - Base unit ringer: 26
 - Base unit speaker: 25
 - Handset receiver: 24
 - Handset ringer: 46
 - Handset speaker: 24
 - W** Wall mounting: 67
 - Wallpaper: 51

Notes

Notes

Customer Support Centre Tel. No.: 132600 or website www.panasonic.com.au



Sales Department:

Panasonic Australia Pty. Limited

Austlink Corporate Park, 1 Garigal Road, Belrose NSW 2085, Australia

Manufacturer:

Panasonic Communications Co., Ltd.

1-62, 4-chome, Minoshima, Hakata-ku, Fukuoka 812-8531, Japan

Copyright:

This material is copyrighted by Panasonic Communications Co., Ltd., and may be reproduced for internal use only. All other reproduction, in whole or in part, is prohibited without the written consent of Panasonic Communications Co., Ltd.

© 2006 Panasonic Communications Co., Ltd. All Rights Reserved.



TG5971

Free Manuals Download Website

<http://myh66.com>

<http://usermanuals.us>

<http://www.somanuals.com>

<http://www.4manuals.cc>

<http://www.manual-lib.com>

<http://www.404manual.com>

<http://www.luxmanual.com>

<http://aubethermostatmanual.com>

Golf course search by state

<http://golfingnear.com>

Email search by domain

<http://emailbydomain.com>

Auto manuals search

<http://auto.somanuals.com>

TV manuals search

<http://tv.somanuals.com>