

Panasonic®

Upper Arm Blood Pressure Monitor
Monitor de presión arterial de brazo

Operating Instructions Instrucciones de funcionamiento

Model No. EW3122
Modelo No. EW3122

For questions or assistance with your blood pressure monitor, call us at 1-800-338-0552.

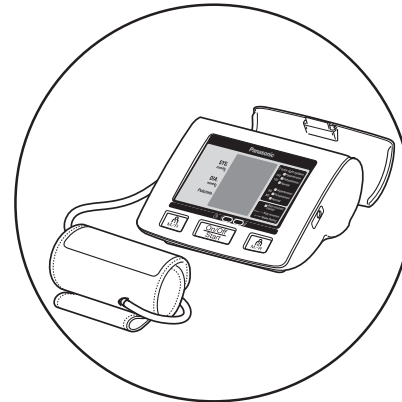

Panasonic Consumer Electronics Company
Division of Panasonic Corporation of North America
One Panasonic Way 3D-1
Secaucus, NJ 07094

Before operating this device, please read these instructions completely and save this manual for future use.

Antes de utilizar este dispositivo, lea completamente estas instrucciones y conserve este manual para futura referencia.

Table of Contents

Introduction	2
Basics of Blood Pressure	2
Important Instructions Before Use	3
Precautions to Ensure Safe, Reliable Operation	5
Easily Check Your Blood Pressure Readings Against the JNC 7*	
Classification	5
Parts Identification	7
Installing batteries	9
When using the AC adapter	10
Before starting measurements	11
Positioning the pressure cuff	12
For accurate measurements	13
Cautions during measurements	14
Taking a reading	15
Alarm function signals high blood pressure	17
Storing measurement values	18
Recalling stored measurement values	19
Setting (checking) the measurement notification time	20
After use/Specifications	23
Q & A	24
Caring for the device	27
Troubleshooting	28

Introduction

Thank you for purchasing the Panasonic Upper Arm Blood Pressure Monitor EW3122.

Measuring your own blood pressure is an important way of monitoring your health. High blood pressure (hypertension) is a major health problem which can be treated effectively once detected. Measuring your blood pressure between doctor visits on a regular basis in the comfort of your home, and keeping a record of the measurements, will help you monitor any significant changes in your blood pressure. Keeping an accurate record of your blood pressure will help your doctor diagnose and possibly prevent any health problems in the future.

Basic of Blood Pressure

Your heart acts like a pump, sending blood surging through your blood vessels each time it contracts. Blood pressure is the pressure exerted by blood pumped from the heart on the walls of blood vessels. Systolic pressure is the pressure exerted when the heart contracts and pumps blood into the arteries. Diastolic pressure is the pressure exerted when the heart expands, or relaxes. When you or your doctor take your blood pressure, both your systolic and diastolic pressures are measured. If your blood pressure measurement is 120 over 80 (120/80), for example, your systolic pressure is 120 while your diastolic pressure is 80.

Important Instructions Before Use

1. Do not confuse self-monitoring with self-diagnosis. Blood pressure measurements should only be interpreted by a health professional who is familiar with your medical history.
2. If you are taking medication, consult with your physician to determine the most appropriate time to measure your blood pressure. NEVER change a prescribed medication without first consulting with your physician.
3. Blood pressure can vary based on many factors, including age, gender, weight and physical condition. In general, a person's blood pressure is lower during sleep and higher when he or she is active. Blood pressure can change easily in response to physiological changes. The setting in which a person's blood pressure is measured can also affect the results. Having one's blood pressure measured by a healthcare professional in a hospital or clinic can cause nervousness and may result in a temporarily elevated reading. Because blood pressure measurements taken in a clinical setting can vary considerably from those taken at home, a person's blood pressure should be measured not only occasionally in the doctor's office, but also on a regular basis at home. Also, if you find that your blood pressure is lower at home, this is not unusual. To accurately compare with your physician's reading, take your Panasonic blood pressure monitor to your doctor's office and compare readings in this setting.
4. People suffering from cardiac arrhythmia, vascular constriction, liver disorders or diabetes, people with cardiac pacemakers or a weak pulse, and women who are pregnant should consult their physician before measuring their blood pressure themselves. Different values may be obtained due to their condition.
5. Try to take your blood pressure measurements at the same time and under the same conditions every day.
 - The ideal time to measure your blood pressure (to obtain your so-called "base blood pressure") is in the morning just after waking up, before having breakfast and before any major activity or exercise. If this is not possible, however, try to take measurements at a specified time prior to breakfast, and before you have become active. You should relax for about 5 minutes before taking the measurement.
 - The following situations may cause substantial variations in blood pressure readings and should therefore be avoided at least 30 minutes prior to taking your blood pressure.
 - Blood pressure will be higher than usual:
 - when you are excited or tense
 - when you are taking a bath
 - during exercising or soon after exercising
 - when it is cold
 - within one hour after eating
 - after drinking coffee, tea or other beverages containing caffeine
 - after smoking tobacco
 - when your bladder is full
 - Blood pressure will be lower than usual:
 - after taking a bath
 - after drinking alcohol
6. Measurements may be impaired if this unit is used near a television, microwave oven, X-ray equipment or other devices with strong electrical fields. To prevent such interference, use the unit at a sufficient distance from such devices or turn the devices off.
7. This unit is designed for use by adults. Consult with your physician before using this unit on a child. Do not use on infants or toddlers.
8. This unit is not suitable for continuous monitoring during medical emergencies or operations.
9. Do not use the unit for any purpose other than measuring blood pressure. Do not use the unit together with other devices.
10. Improper handling of batteries may result in battery rupture or in corrosion from battery leakage. Please observe the following to ensure proper use of batteries.
 - a. Be sure to turn off the power after use.
 - b. Do not mix different types or sizes of batteries.
 - c. Change all batteries at the same time. Do not mix old and new batteries.
 - d. Be sure to insert batteries with correct polarity, as instructed.
 - e. Remove batteries when they are worn out, and dispose of them properly according to all applicable environmental regulations.
 - f. Do not disassemble batteries or throw them into a fire.
 - g. Do not short-circuit batteries.
 - h. Do not attempt to recharge the batteries included with the unit.

Precautions to Ensure Safe, Reliable Operation

1. Do not drop the unit. Protect it from sudden jars or shocks.
2. Do not insert foreign objects into any openings.
3. Do not attempt to disassemble the unit.
4. Do not crush the pressure cuff.
5. If the unit has been stored at temperatures below 0°C (32°F), leave it in a warm place for about 15 minutes before using it. Otherwise, the cuff may not inflate properly.
6. Do not store the unit in direct sunlight, high humidity or dust.

IMPORTANT:

- Do not be alarmed by temporarily high or low readings because fluctuations in a person's blood pressure are not uncommon. If possible, measure and record your blood pressure at the same time every day, and consult your physician if you have questions or concerns.
- If abnormal variations in blood pressure are observed in measurement, please consult your physician.

Easily Check Your Blood Pressure Readings Against the JNC 7* Classification

Blood Pressure Categories

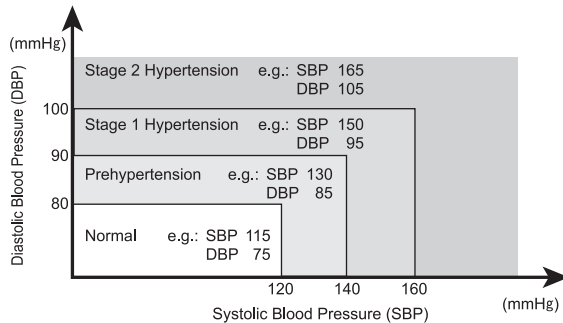

If your systolic pressure falls in one category but your diastolic pressure in another, your level is classified in the higher of the two categories.

* JNC 7: The Seventh Report of the Joint National Committee on Prevention, Detection, Evaluation and Treatment of High Blood Pressure National Institute of Health (NIH) Publication; No. 03-5233, May 2003

PARTS IDENTIFICATION

Please check the instrument.

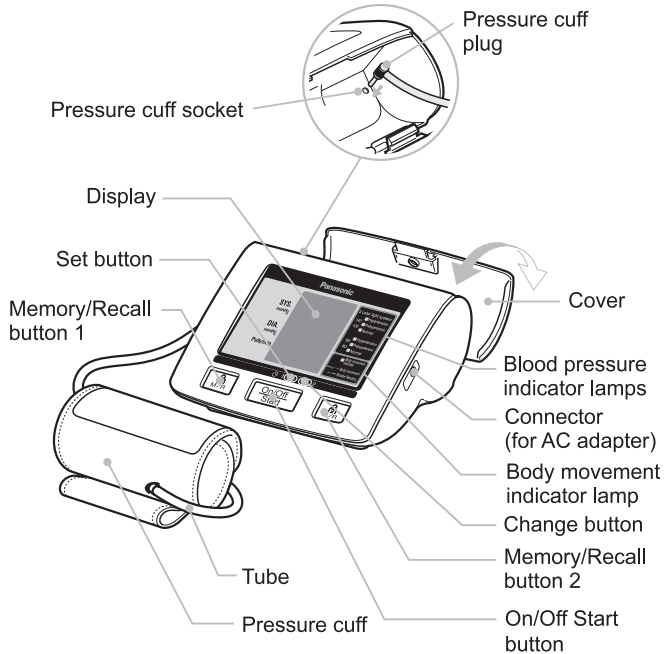

Bottom of main body

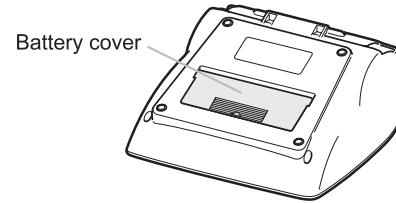

How to open the cover

(1) Press lightly on the Open/Close button.

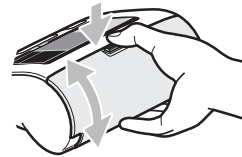

(2) Open the cover while holding the Open/Close button pressed.

Pressure cuff storage example

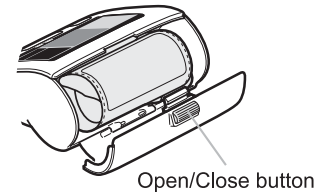

Optional accessory

○ AC Adapter
EW31225

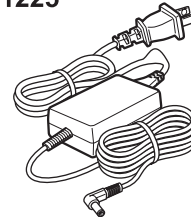

○ Large Cuff
(35cm - 44cm)
(13 3/4" to 17 1/4")
EW3900

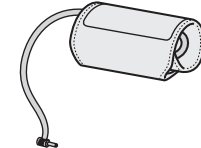

INSTALLING BATTERIES

* Always use alkaline batteries. (Four AA-size LR6 alkaline batteries)

Battery cover

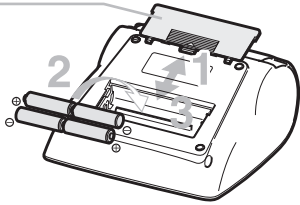

- 1 Turn the main body over, press lightly on the \triangle mark on the battery cover, and **remove** the cover by sliding it in the direction of the arrow.
- 2 Check the polarities of the batteries and **install** them correctly.
- 3 Replace the battery cover and slide it **closed**.

CAUTION:

- Always follow the cautions printed on the batteries.
- Check the polarities of the batteries and install them correctly.
- Remove exhausted batteries promptly.
- If the product will not be used for a long time, remove the batteries.
- Batteries should be used before their expiration date.

Use after the expiration date may result in injury or staining of the surrounding area due to generation of heat, bursting, or leakage.

Replace batteries when:

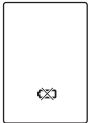

- The mark shown at left appears during use.
- All displays are lit for a moment after the Start/Stop button is pressed, and then the display goes blank.
- No display appears even if the Start/Stop button is pressed.

- Approximately 500 measurements (approximately 5 months when measurements are taken 3 times per day) can be taken with a set of fresh Panasonic alkaline batteries (four AA-size LR6 batteries). (Measurement conditions: Room temperature 22°C (72°F); Pressurized to 170mmHg; Upper arm circumference: 30cm (11-51/64"))
- When batteries other than Panasonic alkaline batteries are used, battery life may be shorter. When manganese batteries are used, battery life becomes as short as 1/6th the life of alkaline batteries.
- Even if the product is not used for a long time, be sure to replace batteries once a year. If battery replacement is delayed, damage due to battery leakage may occur.
- When replacing batteries, always use four fresh alkaline batteries of the same type from the same manufacturer.
- When room temperature is low, battery life may become shorter.

WHEN USING THE AC ADAPTER

* Use only the exclusive AC Adapter (EW31225). (See p. 8.)

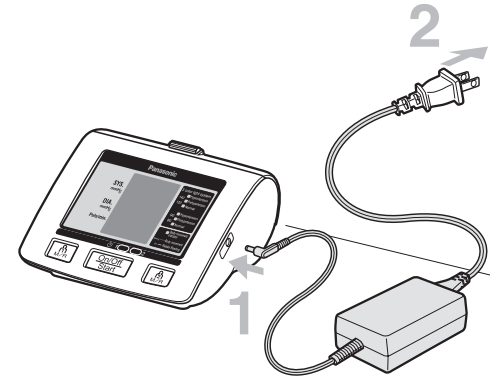

1 Insert the AC adapter plug into the connector on the side of the main body.

2 Plug the AC adapter fully into the AC outlet.

CAUTION:

Be sure to use only the exclusive AC adapter (sold separately).
Use of other AC adapters could cause an accident.

Caution when using only the AC adapter

When no batteries are installed in the main body and the AC adapter is unplugged from the AC outlet or main body, the set date and time will be reset and deleted. Because of this, even when using the AC adapter, it is recommended that batteries be installed in the main body. When the AC adapter is used, power is supplied from the AC adapter, so virtually no power from the batteries is used.

BEFORE STARTING MEASUREMENTS

Setting the date and time

* Please be sure to set the date and time before taking the first measurement after purchasing the blood pressure monitor or after changing the batteries.

- If measurements are taken without setting the date and time, the date and time will not be stored.
- Please read the "Caution when using only the AC adapter" on p. 10.



- 1** With the power switched off, hold the Set button "1" below the display **pressed for at least 3 seconds.**

The month value will blink.

If the time is already set, and the button is pressed for a short time, the alarm setting display will be shown.

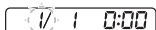

- 2** **Set the month.**
Press the Change button "2" repeatedly to set the correct month.



- 3** **Set the day.**
 - ① Press the Set button "1". The day value will blink.
 - ② Press the Change button "2" repeatedly to set the correct day.

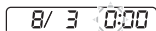

- 4** **Set the hour.**
 - ① Press the Set button "1". The hour value will blink.
 - ② Press the Change button "2" to set the correct hour.

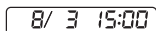

- 5** **Set the minute.**
 - ① Press the Set button "1". The minute value will blink.
 - ② Press the Change button "2" repeatedly to set the correct minute.

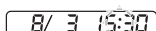

- 6** Press the Set button "1" at the exact time the minute changes **to finalize** the date/time setting.
- 7** Press the On/Off Start button **to switch off** the power.

When the date or time are blinking, the clock is stopped.

During leap years, 3/1 will be displayed on February 29. For this reason, reset the date to 2/29.

POSITIONING THE PRESSURE CUFF

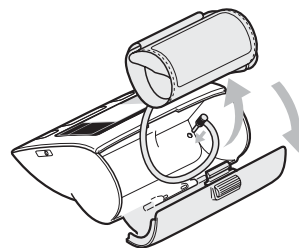

- 1** Open the cover and **remove the pressure cuff** from the main body. (See p. 8.)

- 2** **Insert** the plug into the socket.
 - Insert the pressure cuff plug all the way in.

- 3** **Wrap** around upper arm.
 - Wrap around bare arm.

The blood pressure monitor can be used by wrapping the cuff on either upper arm. However, since it has been said that the difference in blood pressure between the left and right arms may be around 10mmHg, be sure to always use the same arm for measurements.

<When wrapping around left arm>

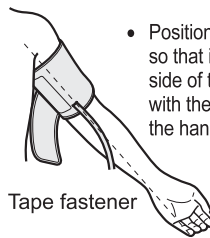

- Position the tube outlet so that it is on the palm side of the arm in line with the little finger of the hand.

Tape fastener

<When wrapping around right arm>

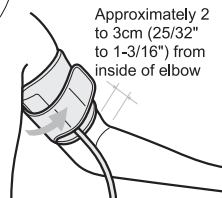
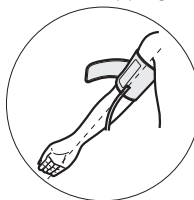

- 4** **Fasten** so that there is no gap between the cuff and the arm, but be careful that the cuff is not too tight.
 - Be careful not to catch your clothes when wrapping the cuff. (Doing so may lead to lower accuracy.)
 - Press the tape fastener down well.

FOR ACCURATE MEASUREMENTS

Take measurements while sitting quietly and relaxing.

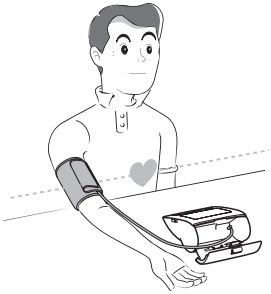

- 1 Rest your elbows**
on a table, etc.
- 2 Position your arm so that**
the pressure cuff is **at the same height** as your heart.
- 3 Position your palm upward,**
and **relax your hand.**

Take measurements using the same upper arm in the same position at the same time every day.

- Measurement values will vary according to the height of the pressure cuff.
- Take measurements in the morning immediately after you wake up, when there is no urge to urinate. If this is difficult, take measurements before breakfast and before you have moved a lot.

Relax and sit in a natural posture when taking measurements.

- Always sit quietly for approximately 4 to 5 minutes before taking measurements.
- Relax your body, arm, and fingers and do not move their muscles.
- Do not talk while taking measurements.
- Do not use a cellular phone near the main body.
- During measurement, do not touch the main body or the tube.

[CAUTION]

Keep away from cellular telephones and other sources of electromagnetic radiation. Failure to do so could result in malfunctioning.

CAUTIONS DURING MEASUREMENTS

In the following situations, accurate measurements cannot be taken.

- Within 1 hour of eating or drinking alcohol
- Immediately after drinking coffee or tea, or smoking
- Immediately after exercising or taking a bath
 - Wait at least 20 minutes and take a measurement while staying quiet.
- In a moving vehicle
- In cold places
 - Take measurements at ambient temperatures of 10°C to 40°C (50°F to 104°F).
- When you need to urinate
 - Wait several minutes after urinating before taking measurements.

TAKING A READING

Measurement

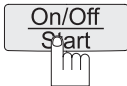

1 Press the On/Off Start button.

- The pressure cuff will automatically be pressurized and a measurement will be taken.

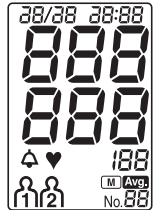

The entire display will light for approximately 1 second.

- If there is air left in the pressure cuff, the fully lit time will be longer.



The heart mark ♥ will blink when pulse is detected during pressurization.

- If the measurement notification time is set, the bell mark △ will be shown. (To set or check the measurement notification time, see pp. 19 to 21.)
- If your body moves during measurement, the body movement indicator lamp will blink. (See p. 15.)

2 When measurement has been completed, a series of beeps will sound and **the blood pressure and pulse values will be displayed.**

Beep
Beep
Beep
Beep

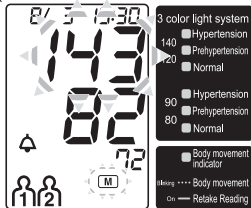

- Pressure will be automatically released from the pressure cuff.
 - The blood pressure indicator lamps will light (for approximately 6 seconds).
 - If the measured value is in the high blood pressure region, the values will blink (for approximately 6 seconds). (For how to read the blood pressure display, see p. 16.)
 - The marks will light.
 - The mark will blink. (For storing measurement values, see p. 17.)
- * The pulse rate value is the beats per minute calculated based on the pulse rate during measurement.

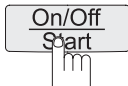

3 To switch off the blood pressure monitor, **press** the On/Off Start button.

- If you forget to switch it off, the blood pressure monitor will switch off automatically after approximately 5 minutes.

TAKING A READING (CONTINUED)

About the body movement indicator function

If your arm (to which the pressure cuff is attached), etc. moves during measurement (such as if you unconsciously bend your elbow), it may not be possible to take measurements correctly.

- The body movement indicator function uses the body movement indicator lamp and a warning sound to tell you when movement has occurred or when excessive pressure has been applied to the pressure cuff during measurement.
- If the body movement indicator lamp blinks, return your arm to the correct posture. (See p. 13.)
- When body movement has been detected, the body movement indicator lamp will blink when the blood pressure reading appears. (The lamp will also blink when measurements for which movement was detected are stored and later recalled.)

Body movement indicator lamp display	Warning sound	Explanation
Blinking	Beeeeep beeeep (long buzzer sounds)	<p>Body movement was detected.</p> <ul style="list-style-type: none"> You unconsciously bent your elbow. The upper arm became very tense. You moved your arm. Etc. <p>Return to the proper posture.</p>
Lit	Beep beep (short buzzer sounds)	<p>A movement which will cause large differences in measurement values occurred.</p> <ul style="list-style-type: none"> Body movement was large. Body movement occurred several times. Arm movement was large. <p>Remeasure (Remeasure mark is shown.)</p> <p>* It will also be lit in the following cases:</p> <ul style="list-style-type: none"> Pressure cuff tape fastener became unfastened. Tube came out. Etc. <p>(For details, see p. 28.)</p>

* This function is intended to help ensure correct measurements. (See p. 26.) Even if the remeasure mark does not appear (or body movement indicator lamp does not light), it is recommended that 2 or 3 measurements be taken in a quiet condition for best results.

Alarm function signals high blood pressure

Blood pressure values for both systolic and diastolic readings are determined and indicated via a three-color LED system as being within normal or hypertensive ranges based on definitions and classification of blood pressure levels by the JNC 7. Moreover, when blood pressure is in the high range, the reading displayed on screen flashes on and off to alert user.

According to JNC 7 Classification, values consistently in excess of 140 mmHg (Sys.) and/or 90 mmHg (Dia.) are considered to constitute high blood pressure.

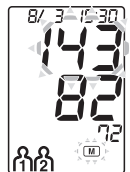
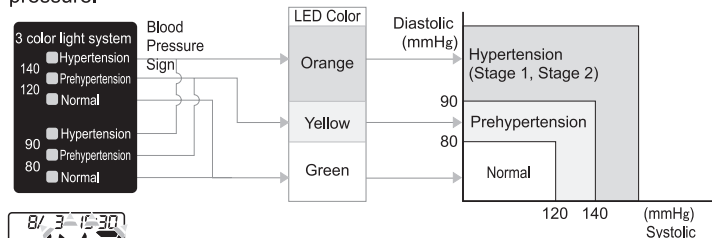

- Blood pressure readings will flash for approx. 6 seconds when in the high blood pressure range.
Systolic blood pressure: 140 mmHg and over
Diastolic blood pressure: 90 mmHg and over
(Only when measurement is complete)

If measurements could not be taken properly

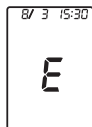

The re-measure mark E will be displayed.

When taking successive measurements, press the Start/Stop button to switch off the blood pressure monitor once and stay quiet for 4 to 5 minutes, and then take the next measurement.

Advice:

In general, blood pressure measurements are lower for the second measurement because you are less nervous and are more tranquil.
For people who easily get tense, measuring twice each time is very effective.
When two measurements are taken, normally the smaller measurement is stored.
When taking two measurements, always stay quiet for 4 to 5 minutes after the first measurement before taking the second measurement.

STORING MEASUREMENT VALUES

This product can separately store 42 measurements each for two persons.

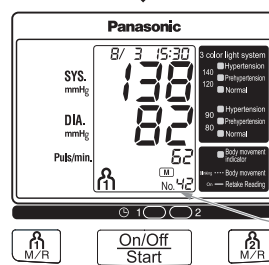
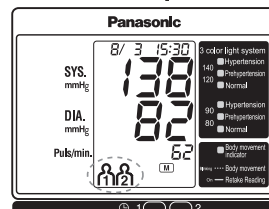

After measurement, the M/R will light.
Press the Memory/Recall button with the number corresponding to the person for which measurements should be stored.

Example: Person A: Press M/R
Person B: Press M/R

Storing is completed.

- Up to 42 measurement values can be stored. When the memory is full and additional values are stored, the oldest value in memory will be deleted and the new value will be stored.
- If measurements could not be taken properly (the E mark is shown instead of the blood pressure value), measurement values cannot be stored.
- However, even if the E mark is shown for the blood pressure value, the pulse value will still be stored.

Number of stored data

To erase all measured values stored in memory:

- Press the Memory/Recall button for the person whose data you want to delete. The stored measurement values will be displayed.
- Press the same Memory/Recall button again, and hold it pressed until the measurement values disappear (approximately 3 seconds or more).
* It is not possible to erase single measurement values.

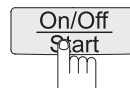

To switch off the blood pressure monitor, **press** the On/Off Start button.

- If you forget to switch it off, the blood pressure monitor will switch off automatically after approximately 5 minutes.

RECALLING STORED MEASUREMENT VALUES

Measurements can be recalled after measurement is completed or after the power has been switched off.

- If no measurement values are stored, no value will be shown.



1 Press the Memory/Recall button for the person whose data you want to recall.

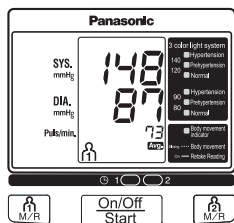

The average of all measured values in memory will be **shown**.

- **Avg.** will be shown at the bottom of the display.
- For example, if 42 measured values are stored, the average of the 42 measurements will be shown. (If only 1 measurement is stored, the **Avg.** will not be shown.)
- The blood pressure indicator lamps will light (for approximately 6 seconds).



2 Press the Memory/Recall button again.

Each time you press the Memory/Recall button, the previously stored measurement values will be **shown** in order, starting with the newest data.

- The blood pressure indicator lamps will light (for approximately 6 seconds).
- If your body moves during measurement, the body movement indicator lamp will blink (for approximately 6 seconds).

Press the Memory/Recall button lightly for only a short time. If you hold the button pressed for approximately 3 seconds or longer, all data in memory will be erased, so please be careful.

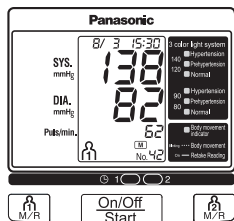

3 To cancel measurement value recall, **press** the On/Off Start button.

- If you forget to switch it off, the blood pressure monitor will switch off automatically after approximately 30 seconds.

SETTING (CHECKING) THE MEASUREMENT NOTIFICATION TIME

To let you take measurements at the same time every day, 3 times per day can be set as notification times.



1 Press the Set button "1" below the display.

- Notification Time 1 will blink.
- * If date and time have not been set, the display will change to the date/time setting display. (See p. 11 for setting the date/time.)



2 Press the Set button "1" again.

- The and OFF will blink.

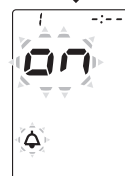

3 Press the Change button "2" to display on.

- The and on will blink.
- on ⇒ Notification sound will sound.
- OFF ⇒ Notification sound will not sound.
- When "on" is selected and the Set button is pressed, the time will show 0:00 and the hour value will blink, and " " and " on " will light.

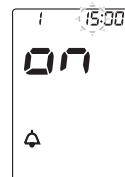

4 Press the Change button "2" repeatedly to set the desired hour.

SETTING (CHECKING) THE MEASUREMENT NOTIFICATION TIME (CONTINUED)



- 5** ① Press the Set button "1". The minute value will blink.
② Press the Change button "2" repeatedly to set the desired minute.
- To set only Notification Time 1, press the On/Off Start button to complete the setting.
 - To set Notification Times 2 and 3, follow steps 6 and 7 below.



- 6** Press the Set button "1". Notification Time 2 will blink. Repeat steps 2 to 5 to set the desired notification time.



- 7** When setting of Notification Time 2 has been completed, press the Set button "1". Notification Time 3 will blink. Repeat steps 2 to 5 to set the desired notification time.

- 8** When setting of Notification Time 3 has been completed, press the Set button "1". The times set for Notification Times 1 to 3 will be shown automatically at 2 second intervals.

- 9** To complete the setting, press the On/Off Start button.

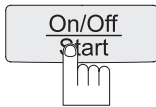

SETTING (CHECKING) THE MEASUREMENT NOTIFICATION TIME (CONTINUED)

To change the notification time setting:

- 1** Press the Set button "1" on the top surface of the blood pressure monitor. (Notification Time 1 will blink.)
- To change the setting for Notification Time 2 or 3, press the Change button to display Notification Time 2 or 3.
- 2** Press the Set button "1" twice. The hour value will blink.
- 3** Press the Change button "2" repeatedly to set the desired hour.
- 4** ① Press the Set button "1". The minute value will blink.
② Press the Change button "2" repeatedly to set the desired minute.
- 5** Press the On/Off Start button to complete the setting.

To cancel the measurement notification sound:

- 1** Press the Set button "1" on the top surface of the blood pressure monitor. (Notification Time 1 will blink.)
- To change the setting for Notification Time 2 or 3, press the Change button "2" to display Notification Time 2 or 3.
- 2** Press the Set button "1" once. The \triangle and ON will blink.
- 3** Press the Change button "2". OFF will be displayed.
- 4** Press the On/Off Start button to complete the setting.

- When the set time is reached, the measurement notification sound will sound to notify you that it's time to take a measurement.
- If the set time is reached in the middle of taking a measurement, the measurement notification sound will not sound.
- When the measurement notification sound sounds, it can be stopped by pressing the On/Off Start button. If the button is not pressed, the sound stops after 1 minute.
- If you store it in a desk, you may not be able to hear the indicator sound.

Advice:

If a record table is made out with the measurement values taken around the same time, you can easily see your own daily blood pressure changes.

AFTER USE/SPECIFICATIONS

Storage

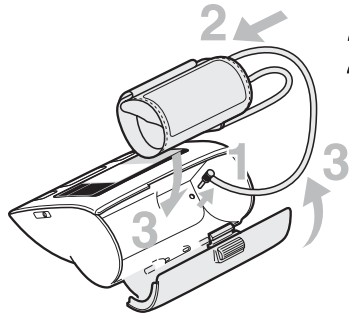

- 1 Unplug the plug from the main body.
- 2 Roll up the pressure cuff loosely, and **store** the tube inside the pressure cuff.
 - Do not wrap the tube around the main body, etc. Doing so may result in excessive force on the tube, and may result in a malfunction.
 - Be careful not to bend the tube.
- 3 Put the pressure cuff in the main body and close the cover.

Specifications

Power source	DC 6V (4 AA-size alkaline batteries) AC 100-240V 50/60Hz (when using optional AC adapter)
Display	Digital LCD
Measurement method	Oscillometric system
Measurement range	Blood pressure: 0 to 280mmHg Pulse rate: 30 to 160 beats per minute
Accuracy	Blood pressure: Within ± 3 mmHg Pulse rate: Within $\pm 5\%$
Operation temperature / humidity range	10 to 40°C (50°F to 104°F), 15 to 90% RH
Storage temperature/humidity range	-20 to 60°C (-14°F to 140°F), 10 to 95% RH
Measurable arm circumference	Approx. 20 to 40cm (7-3/4" to 15-3/4")
Weight	Approx. 18.7 oz. (530g) (not including batteries)
Dimensions	17.9 × 17.1 × 9.3cm (7-5/64" × 6-47/64" × 3-21/32")

Q & A

Q Why are the blood pressure values measured at home different from those measured at the doctor's office?

A Blood pressure varies 24 hours a day. In addition, it can change greatly depending on the weather, your mental state, exercise, etc. In particular, there is the phenomenon of "White uniform hypertension" at doctor's offices, where the blood pressure measured in a doctor's office is higher because of stress or worry.

In addition, if the blood pressure measured at home is sometimes higher and sometimes lower than the blood pressure measured at the doctor's office, the following can be considered. Please pay attention to these points when taking measurements.



- ① **Is the pressure cuff wrapped firmly?**
 - Make sure that the pressure cuff is not wrapped too loosely or too tightly.
 - Is the pressure cuff wrapped around the upper arm? Make sure it is not partly covering the elbow. For how to wrap the pressure cuff correctly, refer to p. 9.



- ② **Do you feel worried or irritated?**

Before taking measurements, take 2 or 3 deep breaths and relax to stabilize blood pressure. In addition, it is recommended that you sit quietly for about 4 to 5 minutes before taking measurements.

Q Why are measured blood pressure values different each time I take a measurement?

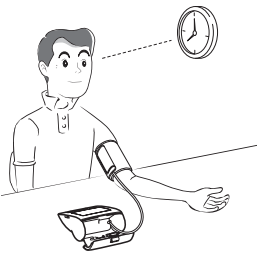
- A**
- 
- ① Blood pressure changes even within a single day, and it is different depending on the measurement posture. Because of this, when taking measurements, be sure to always take measurements under the same conditions.
 - ② For persons taking blood pressure medication, blood pressure may change greatly due to the effects of the medication.
 - ③ When taking 2 measurements in succession, be sure to stay quiet for 4 to 5 minutes after the first measurement before taking the next measurement.

Q Why are the measured values different for the left and right arm?

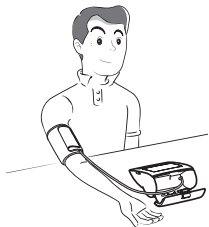
- A**
- 
- It is said that differences in blood pressure values between the left and right arms may be around 10mmHg. The blood pressure can be measured in either the left or right arm, but all measurements should be taken using the same arm.

Q Even though the arm was moved, the body movement indicator light did not come on.

A The body movement indicator function tells you that the elbow was bent or that excess pressure was applied to the pressure cuff. Because of this, if the movement resulted in no effect on the pressure cuff (such as lightly twisting your arm, bending your wrist, etc.), the indicator will not come on. If you still feel concerned about it, please take another measurement.

Q When the body movement indicator lamp became blinked, I returned my arm to the correct measurement position, but the measured value was higher than it always has been.

A The body movement indicator lamp is intended as only a measurement method indicator.

If you returned to the correct posture after the body movement indicator lamp became lit but the measured blood pressure is higher or lower than normal, please take another measurement.

The following possible causes can also be considered:

- Are measurements being taken properly (how cuff is wrapped, measurement posture, etc.)? Refer to pages 12 and 13 when taking measurements.
- Were measurements taken immediately after smoking?
- Were measurements taken when you were feeling irritated?
- Were measurements taken in a cold environment?
- Are you a person who has low pulse changes?
- If you feel concerned about it, please wait 4 to 5 minutes and then take another measurement.

CARING FOR THE DEVICE

Please do not attempt to disassemble, repair or modify the device. This may cause fire or cause the device to malfunction. It may also lead to injury.

Please do not fold the pressure cuff back against itself. Always use the pressure cuff on your upper arm and nowhere else.

- Either of these actions may cause the device to malfunction.

Do not apply excessive force on the device. Do not drop the device.

Measurements may be impaired if the device is used close to televisions, microwave ovens, X-ray equipment or other devices with strong electrical fields. Please measure your blood pressure at a sufficient distance from such devices or switch them off.

The cuff may lose some of its elasticity at temperatures below 0°C. If the device is exposed to such extreme temperatures, it is a good idea to leave it until it warms up to room temperature before taking the next measurement. As a basic principle, the device should not be exposed to extreme conditions (cold, heat, humidity, dust).

Do not allow dust or other foreign objects to enter the device as this may cause it to malfunction.

Cleaning the device

- Do not use anything other than a cloth with warm water and a little soapy to wipe the device.
- Do not use thinners, benzene, or alcohol on the device as this may cause discoloration and cracks.
- Cuff can not be washed.

Storage

- Avoid exposing the device to high temperatures, high humidity and direct sunlight as this can cause the device to malfunction.

Long-term storage

- Remove the batteries before storing the device for long periods of time. Failure to do so may result in the batteries leaking, which may cause the device to malfunction.

TROUBLESHOOTING

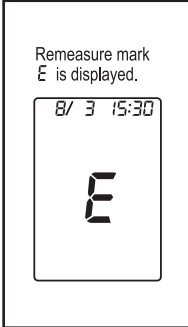
Display	Status before error	Cause and solution
	Pressurization to more than 280mmHg was performed.	Were measurements taken according to the proper procedure and in the correct posture? See pp. 12 and 13.
	Pressure decreased suddenly and the remeasure mark E appeared.	Was the pressurization cuff wrapped properly? See p. 12.
	Measurement was taken to 20mmHg and then the remeasure mark E appeared.	Tube may not be connected sufficiently. Check the tube connection. See p. 12.
	The heart mark ♥ blinked only a few times or not at all.	
	Pressurization doesn't occur even after waiting several dozen seconds.	
Symptom	Possible cause	
Systolic or diastolic blood pressure value is high or low.	<ul style="list-style-type: none"> • Position of pressure cuff is low. • Pressure cuff is not wrapped correctly. • Position of pressure cuff is high. • You moved or talked while measurements were being taken. See pp. 12 and 13.	If problem continues Ask your doctor for advice.
Blood pressure value is abnormally high or low.	<ul style="list-style-type: none"> • Posture is different for each measurement. See p. 13.	
Value is different from that measured by the doctor.	<ul style="list-style-type: none"> • Blood pressure varies in response to minute changes in your mental state, such as your reaction to a doctor's presence. • Sit quietly for 4 to 5 minutes and then take another measurement. See p. 13.	
Measurement values are different with each measurement.		
No display appears even when the Start/Stop button is pressed.	<ul style="list-style-type: none"> • Batteries are exhausted. • Batteries are installed with the polarities wrong. See p. 9.	
When the Start/Stop button was pressed, all displays became lit and then the display disappeared.		
Body movement indicator lamp blinks during measurement.	<ul style="list-style-type: none"> • Arm was moved. See p. 15.	
Even though the arm was not moved, the body movement indicator lamp blinks.	<ul style="list-style-type: none"> • The body movement indicator lamp may respond when the arm becomes tense. Relax all tension in the arm when taking measurements. See p. 13.	
Instrument is broken.	Take it to the store where it was purchased for testing and repairs.	

Free Manuals Download Website

<http://myh66.com>

<http://usermanuals.us>

<http://www.somanuals.com>

<http://www.4manuals.cc>

<http://www.manual-lib.com>

<http://www.404manual.com>

<http://www.luxmanual.com>

<http://aubethermostatmanual.com>

Golf course search by state

<http://golfingnear.com>

Email search by domain

<http://emailbydomain.com>

Auto manuals search

<http://auto.somanuals.com>

TV manuals search

<http://tv.somanuals.com>