

Panasonic

MP3 WMA CD Player/Receiver with CD Changer Control

CQ-C7300N



Operating Instructions
Bedienungsanleitung
Manuel d'instructions
Gebruiksaanwijzing
Bruksanvisning
Manuale di istruzioni
Manual de Instrucciones
Instrukcja obsługi



WMA MP3



Matsushita Electric Industrial Co., Ltd.

Web Site: <http://www.panasonic.co.jp/global/>

YEFM284145 NT1203-0 Printed in China

- Please read these instructions carefully before using this product and keep this manual for future reference.
- Bitte lesen Sie diese Bedienungsanleitung vor der Verwendung dieses Produktes aufmerksam durch und bewahren Sie sie danach für spätere Nachschlagzwecke sorgfältig auf.
- Prière de lire ces instructions attentivement avant d'utiliser le produit et garder ce manuel pour l'utilisation ultérieure.
- Leest u deze instructie alstublieft zorgvuldig door voor u dit product in gebruik neemt en bewaar deze handleiding voor later gebruik.
- Läs igenom denna bruksanvisning noga innan produkten tas i bruk. Spara bruksanvisningen för framtida behov.
- Si prega di leggere attentamente queste istruzioni prima di usare questo prodotto e di conservare questo manuale per usi futuri.
- Lea con atención estas instrucciones antes de utilizar el producto y guarde este manual para poderlo consultar en el futuro.
- Przeczytaj uważnie instrukcję obsługi przed rozpoczęciem używania urządzenia i zachowaj ją do użytku w przyszłości.

Panasonic welcomes you to their constantly growing family of electronic products owners.

We endeavor to give you the advantages of precise electronic and mechanical engineering, manufactured with carefully selected components, and assembled by people who are proud of the reputation their work has built for our company. We know this product will bring you many hours of enjoyment, and after you discover the quality, value and reliability we have built into it, you too will be proud to be a member of our family.

CQ-C7300N

MP3 WMA CD Player/Receiver with CD Changer Control

- Electric-controlled retractable front panel equipped (⇒ Page 12)
- Connecting the dual CD changer selector (CA-CD55EN) allows you to control two CD changers. (⇒ Page 30)
- Illumination color of the front panel can be changed with just one button operation. (⇒ Page 13)
- Adjustable 7-band preset equalizer (SQ) (⇒ Page 14, 15)
SQ is a function that can call up various sound types at the touch of button in accordance with your listening music type. For SQ7, you can also make fine adjustments for SQ presetting, P2-P6, according to your taste.
- Genuine subwoofer system achieved thanks to HPF (High Pass Filter) and LPF (Low Pass Filter) (⇒ Page 15)
- MP3/WMA playable (⇒ Page 26)

Delightful sound space thanks to system buildup

Dual CD changer selector CA-CD55EN (Option)

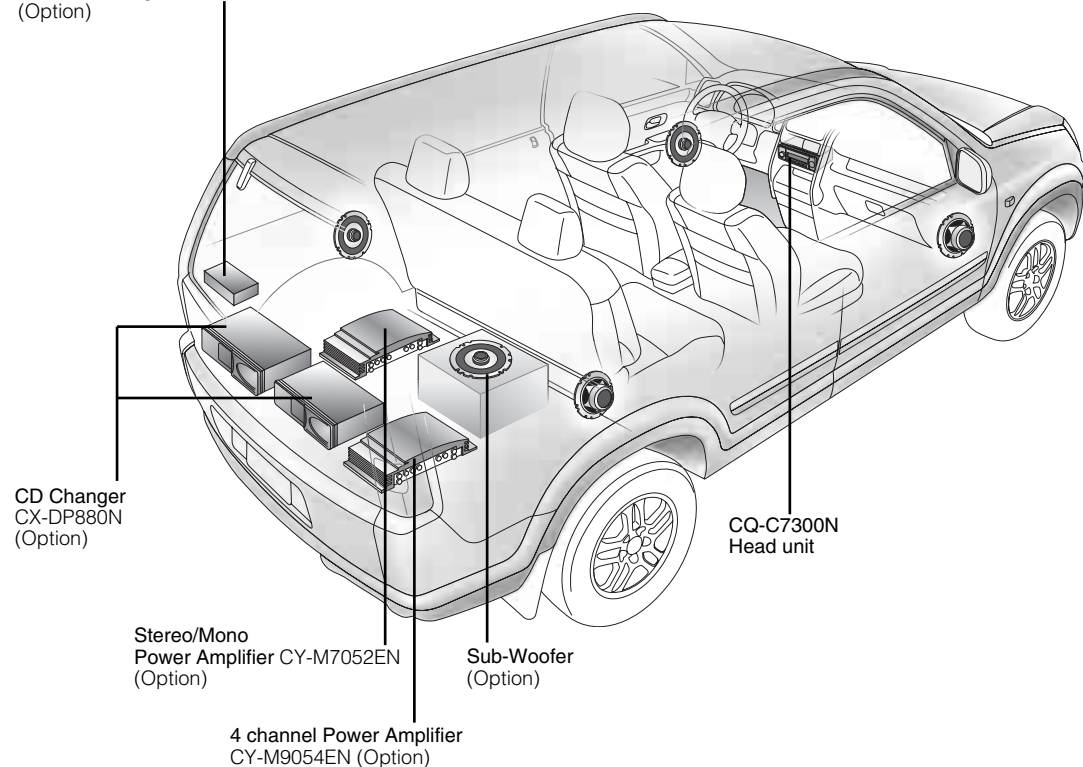

English

Deutsch	40
Français	78
Nederlands	116
Svenska	154
Italiano	192
Español	230
Polska	268

Common

● Features	2
● Before Use	4
● Controls Layout	6
● Preparation	8
● General	10
● Audio Setting	14
● Menu	16

Each Source

● Radio	18
● Radio Data System (RDS) in FM Broadcasting	20
● CD Player	24
● MP3/WMA Player	26
● CD Changer Control	30

As Needed

● Troubleshooting	32
● Error Display Messages	36
● Notes on Discs	37
● Maintenance	38
● Specifications	39

Volume Level

For your driving safety, keep the volume level low enough to be aware of road and traffic conditions.

Car Washing

To avoid electrical shorts which may cause fire, or other damage, do not expose this product (including the speakers and CDs) to water or excessive moisture.

Car Ventilation

If your car is parked for several hours in direct sunlight, the temperature inside the car may become very high. It is advisable to drive the car and give the interior a chance to cool down before switching the unit on.

Power Supply

This product is designed to be used in a car having a 12-Volt negative ground battery system.

Disc Mechanism

Do not insert coins or any small objects. Keep screwdrivers and other metallic objects away from the disc mechanism and disc.

Service

This product is made of precision parts. Do not attempt to disassemble or adjust any parts. For repair, please consult your nearest authorized Panasonic Service Centre.

Note: The preset memory is cleared to return to the original factory setting when the power connector or battery is disconnected.

Label Indications and Their Locations

CAUTION
LASER RADIATION WHEN OPEN. DO NOT STARE INTO BEAM.

Caution: This product utilizes a laser.
Use of controls or adjustments or performance of procedures other than those specified herein may result in hazardous radiation exposure.

Laser products:
Wave Length 780 nm
Laser Power No hazardous radiation is emitted with safety protection.

Do not take apart this unit or attempt to make any changes yourself.
This unit is a very intricate device that uses a laser pickup to retrieve information from the surface of compact discs. The laser is carefully shielded so that its rays remain inside the cabinet.
Therefore, never try to disassemble the player or alter any of its parts since you may be exposed to laser rays and dangerous voltages.

CLASS 1 LASER PRODUCT
• APPREIL À LASER DE CLASSE
• KLASS 1 LASER APPARAT
• LUOKAN 1 LASERPLAITE

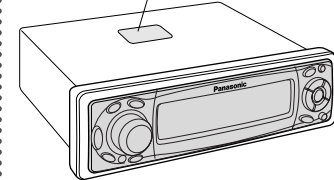

Caution Label

CAUTION LASER RADIATION WHEN OPEN. DO NOT STARE INTO BEAM.	VARO! AVATTAESSA OLET ALTTIINA LASER-SÄTEILYLLÄ. ÄLÄ TUJOTA SÄTEESEEN.
VORSICHT LASERSTRAHLUNG, WENN ABDECKUNG GEÖFFNET. NICHT IN DEN STRAHL BLICKEN.	VARNING LASERSTRÅLNING NÄR DENNA DEL ÄR ÖPPNAD. STIRRA EJ IN I STRÅLEN.
ATTENTION RAYONNEMENT LASER EN CAS D'OUVERTURE. NE PAS REGARDER DANS LE FAISCEAU.	ADVARSEL LASERSTRÅLING NÄR DEKSEL ÅPNES. STIRR IKKE INN I STRÅLEN.
ADVARSEL LASERSTRÅLING VED ÅBNING. SE IKKE INN I STRÅLEN.	

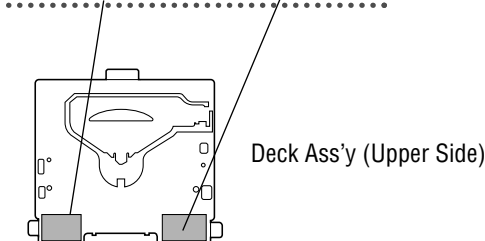

Deck Ass'y (Upper Side)

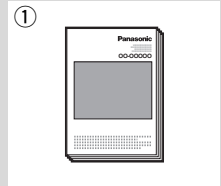
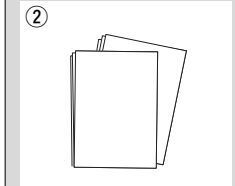
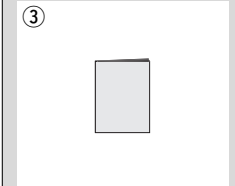
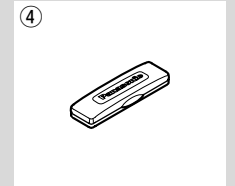
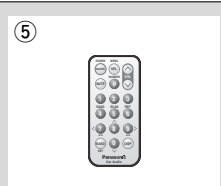
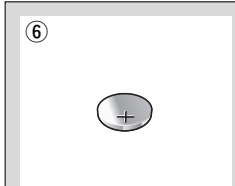
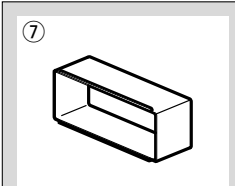
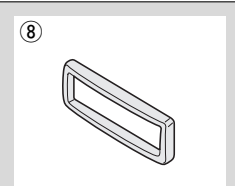
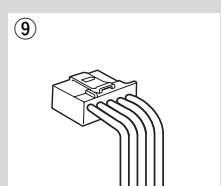
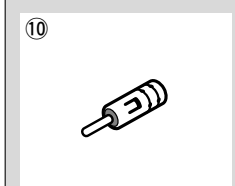
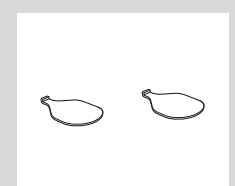
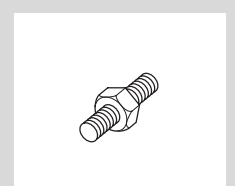
 <p>Operating Instructions (YEFM284145) Q'ty: 1</p>	 <p>Installation Instructions (YEFM293247) (YEFM293248) Q'ty: 1 set</p>	 <p>Warranty Card Q'ty: 1</p>	 <p>Removable Face Plate Case (YEFA131839) Q'ty: 1</p>
 <p>Remote Control Unit → Page 7 (YEFX9992663) Q'ty: 1</p>	 <p>Lithium Battery: CR2025 (CR2025/1F) Q'ty: 1</p>	 <p>Mounting Collar (YEFX0216165) Q'ty: 1</p>	 <p>Trim Plate (YEFX05606) Q'ty: 1</p>
 <p>Power Connector (YEAJ02872) Q'ty: 1</p>	 <p>ISO Antenna Adapter (YEP0FZ3316) Q'ty: 1 set</p>	 <p>Lock Cancel Plate</p>	 <p>Mounting Bolt</p>

- Notes:**
- The number in parenthesis underneath each accessory part name is the part number for maintenance and service.
 - Accessories and their parts numbers are subject to modification without prior notice due to improvements.
 - Mounting Collar ⑦ and Trim Plate ⑧ are mounted on the main unit at shipment.

Controls Layout

Note: This instruction manual explains operations for use with the buttons on the main unit. (Different operations excluded)

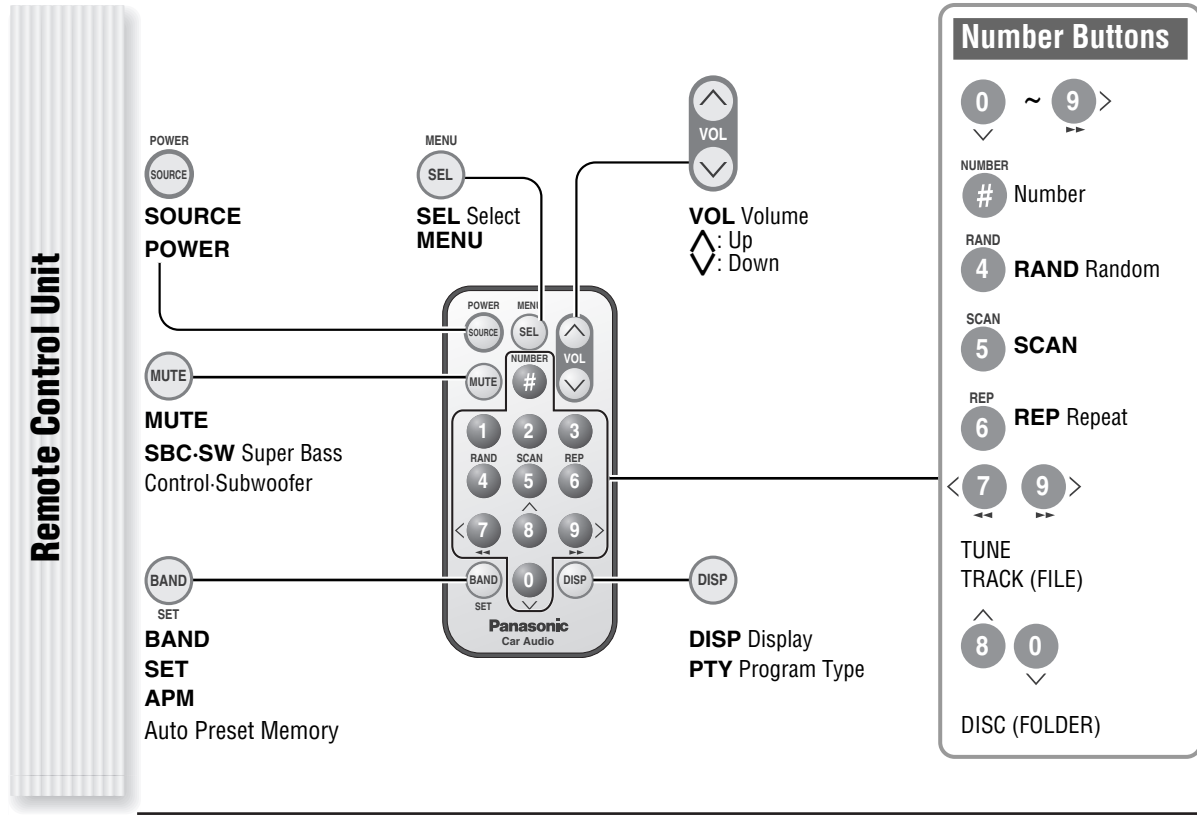
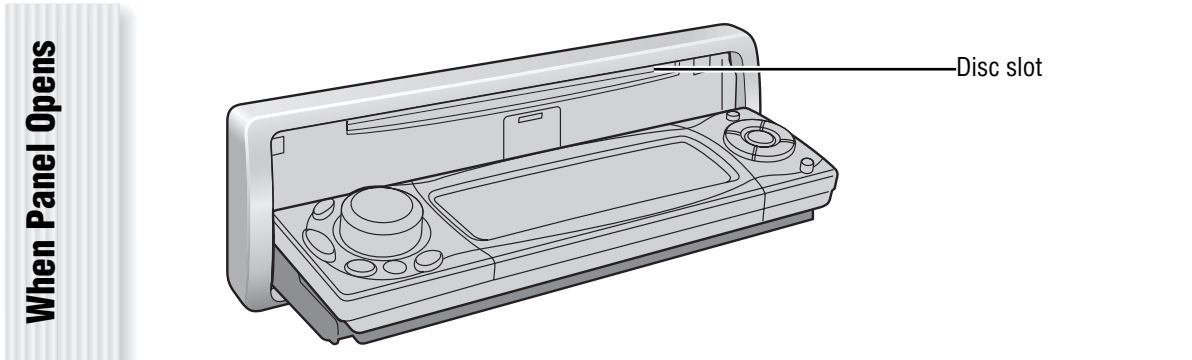
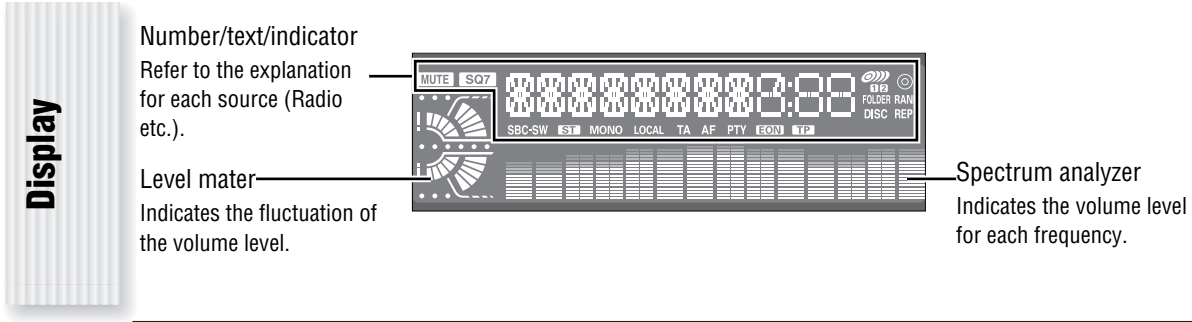
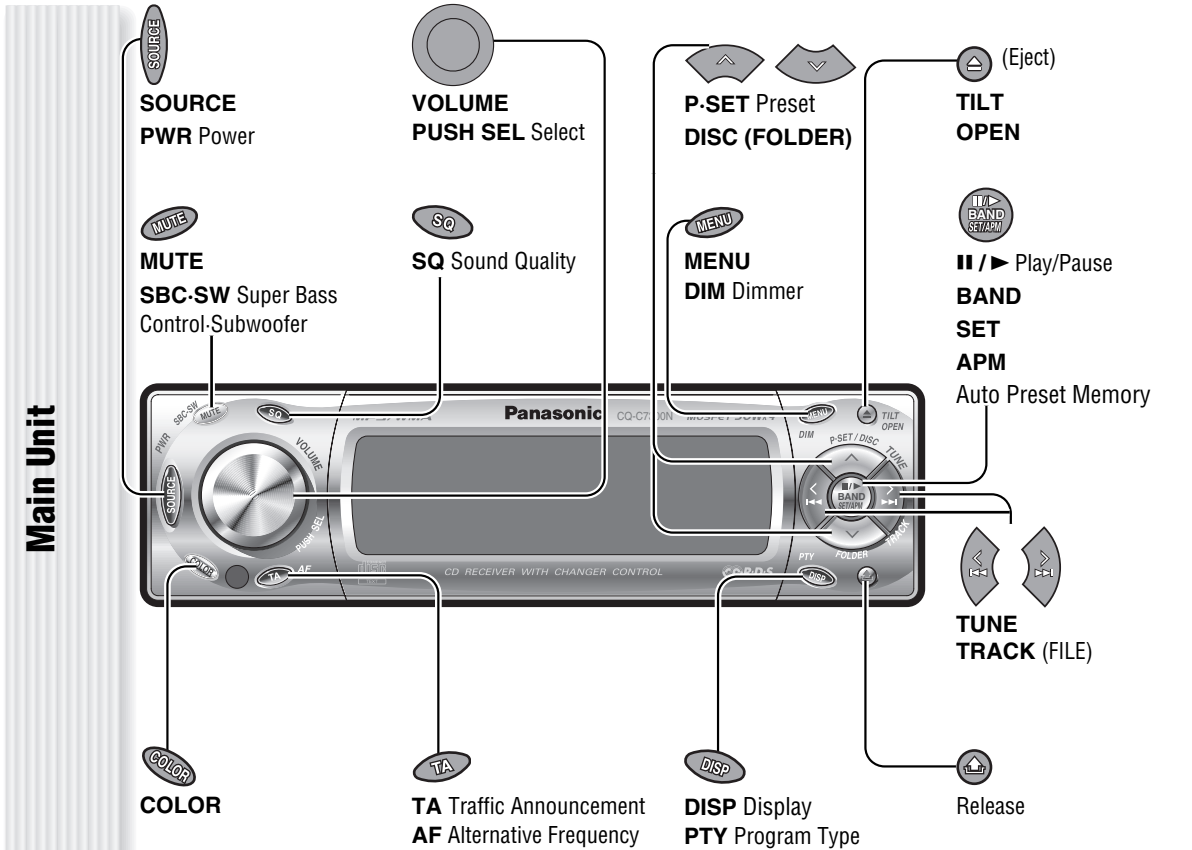

One-touch operation is available for selecting a track playing style by use of [4] (RAND: Random), [5] (SCAN), or [6] (REP: Repeat). (For a Folder/Disc playing style, hold down the same button for 2 sec. or more.)

Direct Access

A track (CD mode), disc (CD changer), file and folder (MP3/WMA mode) can be directly selected.
Example: File number 5

- 1 Press [#] (NUMBER).
- 2 Press [5].
- 3 Press [BAND] (SET).



English
Controls Layout

First Time Power On (DEMONSTRATION)

The demonstration message appears for first use.

- 1 Press **[SOURCE]** (PWR: Power).
The demonstration screen appears.



- 2 Press **[DISP]** (Display).
The demonstration screen is cancelled, and no more appears.

Note: If you would like to turn on the power and make the demonstration message appear, hold down **[SOURCE]** (PWR: Power) for 4 sec. or more. (at ACC on)

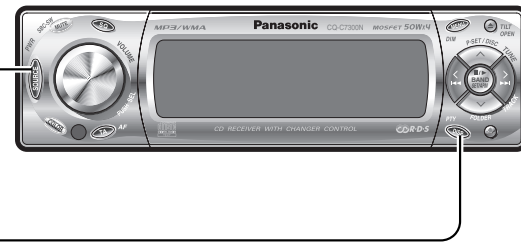

Caution: Improper use of batteries may cause overheating, an explosion or ignition, resulting in injury or a fire.

- 1 Pull out the battery case while pushing the tab.
- 2 Put a battery in the case with (+)-side facing up.
- 3 Put the case back.

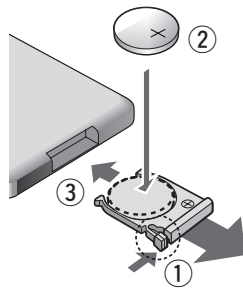

Battery Notes

- Remove and dispose of an old battery immediately.
- Battery Information:
Battery Type: Panasonic lithium battery (CR2025) (Included)
Battery Life: Approximately 6 months under normal use (at room temperature)
- Do not disassemble or short the battery. Do not throw a battery into a fire.
- Keep batteries away from children to avoid the risk of accidents.
- Follow local regulations when disposing of batteries.

Battery into Remote Control

Caution: Be sure to select OFF when your car has no ACC position in the ignition switch. Failure to do this could cause the battery to go dead.

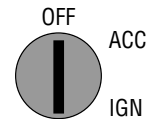

For a ACC-equipped car, select ON. (→ Page 17) The following functions are available. (default: off)

- The power is turned on automatically when inserting a disc or magazine.
- The clock can be displayed even if the power is off. (→ Page 13)
- After the security function (→ Page 17) is set to ON, the function works when turning the ignition key to OFF.
- The unit can be activated just at the push of a button.

ACC OFF : ACC not equipped (Default)

ACC ON : ACC equipped

ACC Setting

Security Function Setting

The following functions are activated when the Security Function is ON. (→ Page 17)

- The security indicator lights up when removing the face plate.

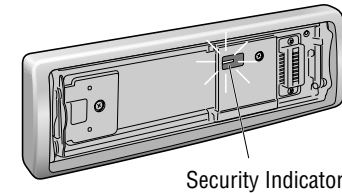

- The alarm sounds and the message appears on the screen to warn you to remove the face plate at power off.



Note: After the ACC setting is set to on, these functions work when turning the main power off. (→ Page 17)

Other Settings

You may need to set the following depending on the devices to be connected.

Using Subwoofer

- Subwoofer level adjustment (→ Page 15)
- Subwoofer low pass filter (→ Page 15)
- High pass filter (→ Page 15)

Notes:

- Adjust the clock when "NO CT" appears on the display.
- When a broadcast of FM Radio Data System is received, the clock is put right automatically by the Clock Time service. (→ Page 20)

Clock adjustment

- 1 Select the radio **AM** mode. (→ Page 18)

- 2 Press and hold **[DISP]** (Display) for more than 2 seconds.

- 3 Press **[<]** or **[>]** to adjust the hour.

[>]: Forward
[<]: Back



Press **[DISP]** (Display) to confirm the adjustment.

- 4 Press **[<]** or **[>]** to adjust the minute.

[>]: Forward
[<]: Back



Press **[DISP]** (Display) to confirm the adjustment.

This chapter explains how to turn on or off the power, how to adjust the volume, etc.

Power on

Press **[SOURCE]** (PWR: Power).

Notes:

- The opening screen appears.
- The demonstration message appears for first use. (→ Page 8)

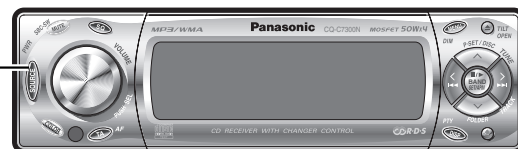

Power off

Hold down **[SOURCE]** (PWR) until you hear a beep (about 1 sec.), then release it.

Note: The ending screen appears at ACC on.



You can remove the face plate to prevent it from being stolen.



2 Put the face plate in the case.

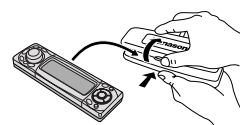

Removing

1 Press **[]** (Release).
(The face plate disengages with a click when it is removed.)



The front panel automatically closes after a lapse of 5 seconds while it is open.

The power is automatically turned off while the unit is active.

Mounting

1 Slide the left side of the removable face plate in place.

2 Press the right end of removable face plate until "click" is heard.
Press it until you hear a click.

Cautions:

- This face plate is not waterproof. Do not expose it to water or excessive moisture.
- Do not remove the face plate while driving your car.
- Do not place the face plate on the dashboard or nearby areas where the temperature rises to high levels.
- Do not touch the contacts on the face plate or on the main unit, since this may result in poor electrical contacts.
- If dirt or other foreign substances get on the contacts, wipe them off with clean and dry cloth.
- To avoid damaging the front panel, do not push it down or place objects on it while it is open.

The source changes as follows every time **[SOURCE]** is pressed.



Radio

FM1, FM2, FM3, AM (MW/LW) (→ Page 18)



FM



AM(MW/LW)

Player

CD-DA, MP3, WMA

Depends on the loaded disc (→ Page 24, 26)



CD



MP3/WMA

Auxiliary

Sound source connecting to the AUX input terminal (→ Installation Instructions)



CD Changer (Option)

Selectable only when a CD changer is connected (→ Page 30)



- ① Up
- ② Down

Setting Range: 0 to 40
Default: 18

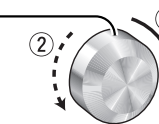

Notes:

- The volume level can be set independently for each source. (For radio, one volume setting for AM (MW/LW), one volume setting for all FMs)
- The volume is not adjustable while an error display is on the monitor. (→ page 36)

Volume off (down)

Press **[MUTE]**.



(MUTE lights.)

Cancel

Press **[MUTE]** again.

Note: Volume-down range can be specified. (→ Page 17)



Open/Eject

Press [⊕] (OPEN).

When a disc is already loaded, the disc will automatically be ejected.

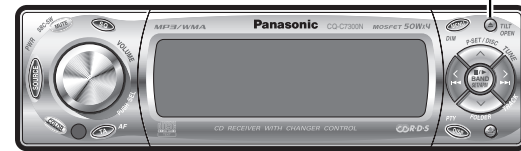
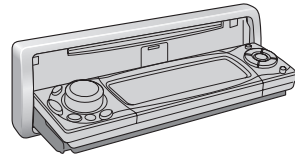

Cautions:

- To avoid damaging the front panel, do not push it down or place objects on it while it is open.
- Do not pinch your finger or hand in the front panel.
- Do not insert foreign objects into the disc slots.
- For the following cases, the front panel automatically closes. Use caution not to catch your finger.
 - After a lapse of 20 seconds
 - When a disc is inserted
 - When the face plate is removed (⇒ page 10)

Tilt

The display angle changes among 4 levels as follows every time you hold down [⊕] (TILT) for 1 sec. or more and release.

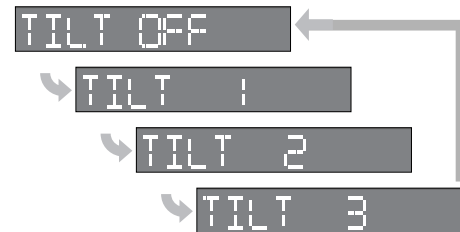

Note: The last selected angle is maintained even after turning off the power.

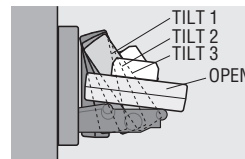

Close

Press [⊕] (OPEN).

The rear speaker can be used as a substitutional subwoofer when a subwoofer is not connected.

Holding down [MUTE] (SBC-SW) for 2 sec. or more toggles SBC-SW on and off.

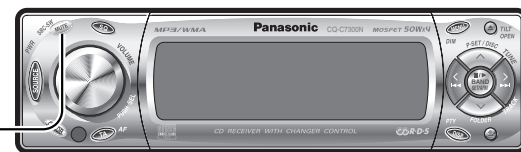

Off (default)



Notes:

- When ON has been selected, the settings resulting from the adjustments performed at the subwoofer level and subwoofer low pass filter settings are reflected in the output. (⇒ page 15)
- Depending on the speakers used and the type of music played, it may not be possible to achieve a satisfactory effect.

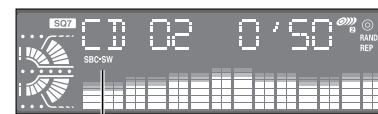

lights when activated.

Pressing [DISP] toggles clock display on and off.

Note: The clock appears only at ACC on.

Clock display (default)

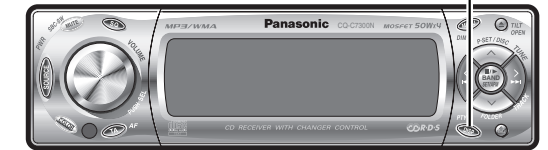
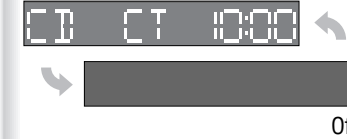

The dimmer level changes as follows every time you hold down [MENU] (DIM) 2 sec. or more.

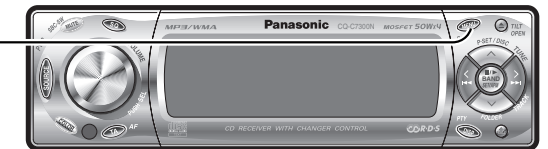
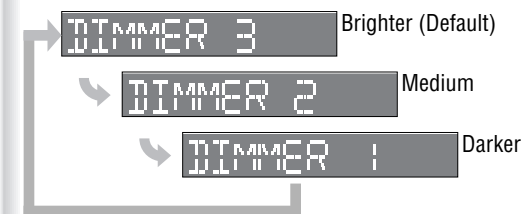

Note: This setting is not adjustable with the remote control.

The display color changes as follows every time [COLOR] is pressed.

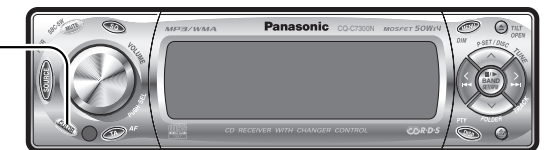
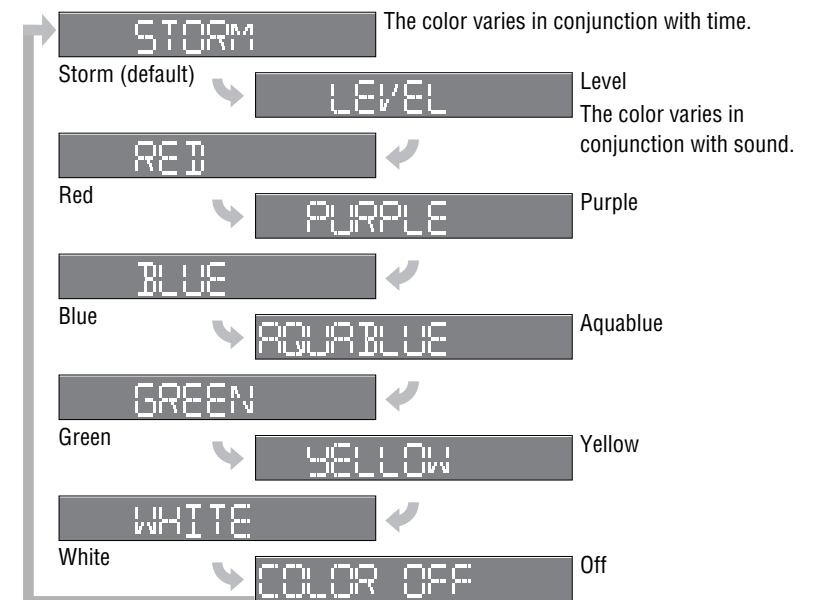

The color varies in conjunction with time.

The color varies in conjunction with sound.

The sound type changes every time you press [SQ].

SQ is a function that can call up various sound types at the touch of button in accordance with your listening music type.

For SQ7, you can also make fine adjustments for SQ presetting, P2-P6, according to your taste.

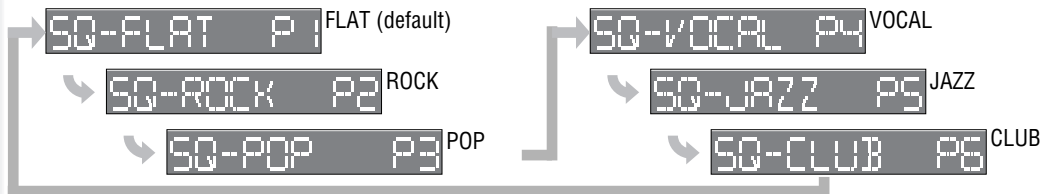

Notes:

- Each SQ level is changeable. (→ see below)
- Settings of SQ, bass/treble and volume are influenced one another. If the influence mentioned above causes distortion to the audio signal, readjust bass/treble or volume.

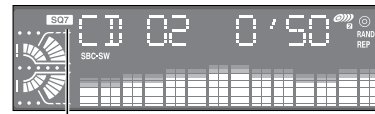

lights when activated.

You can make fine adjustment to the currently selected SQ presetting in each type (except FLAT).

- 1 Hold down [SQ] (Sound Quality) for 2 sec. or more.



The targeted SQ preset appears.

- 2 Adjust each frequency.



Note: If you press the [DISP] key, the presetting is canceled. The presetting is active until another SQ preset is called up.

- [>]: Higher frequency
- [<]: Lower frequency
- ① : Level up
- ② : Level down

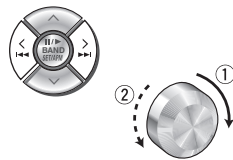

- 3 Hold down [^] or [v] for 2 sec. or more to confirm your adjustment.

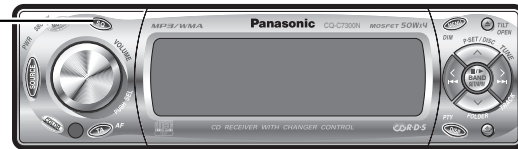

Note: You can select a SQ preset to be targeted with [^] and [v] (and [2]-[6] on the remote control).

- 4 Hold down [^] or [v] for 2 sec. or more to confirm your adjustment.

The existing adjustment is overwritten with new adjustment.

Notes:

- FLAT is not changeable.
- The call-up screen is unchanged even after adjusting any SQ preset.
- If no operation takes place for more than 10 seconds, the display returns to the regular mode and the current SQ setting is activated until switching to another SQ.
- If you hold down [BAND] for 2 sec. or more on the SQ call-up screen, the presetting that is called up can be initialized.
- Other audio settings should be adjusted here as well. (→ Page 15)

- 1 Press [VOLUME] (SEL: Select) to display the menu display.



- 2 Press [VOLUME] (SEL: Select) to select a mode to be adjusted.

- 3 Turn [VOLUME] (Volume) clockwise or counter-clockwise to adjust.

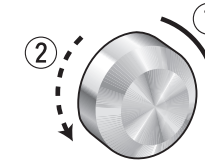

Note: If no operation takes place for more than 5 seconds in the audio menu (2 seconds in Main volume adjustment and 10 sec. in the SQ preset change operation), the display returns to Regular Mode.

Main volume adjustment

(Setting range: 0 to 40, Default: 18)

- ① : Up
- ② : Down



Bass adjustment

(Setting range: -12 dB to +12 dB, 2 dB Step, Default: Bass 0)

- ① : Up
- ② : Down



Treble adjustment

(Setting range: -12 dB to +12 dB, 2 dB Step, Default: Treble 0)

- ① : Up
- ② : Down



SQ preset change

(Adjustable frequency: 60 Hz, 160 Hz, 400 Hz, 1 kHz, 3 kHz, 6 kHz, 16 kHz, Setting range: -12 dB to +12 dB, 2 dB Step)

(Change of SQ Presetting → Page 14)



Balance adjustment

(Setting range: L15 to R15 and Centre, Default: Centre)

- ① : Right enhanced
- ② : Left enhanced



Fader adjustment

(Setting range: R15 to F15 and Centre, Default: Centre)

- ① : Front enhanced
- ② : Rear enhanced



Subwoofer level adjustment

(Setting range : MUTE, -6 dB to +6 dB, 2 dB Step, Default: 0)

- ① : Up
- ② : Down



Subwoofer Low Pass Filter

(Setting range: 80 Hz, 120 Hz, 160 Hz, Default: 80 Hz)

- ① : Up
- ② : Down



High Pass Filter

(Setting range: Filter OFF, 90 Hz, 135 Hz, 180 Hz, 225 Hz, Default: Filter OFF)

- ① : Up
- ② : Down



Operation items change as follows every time [MENU] is pressed.

Settings and playing variations of each source

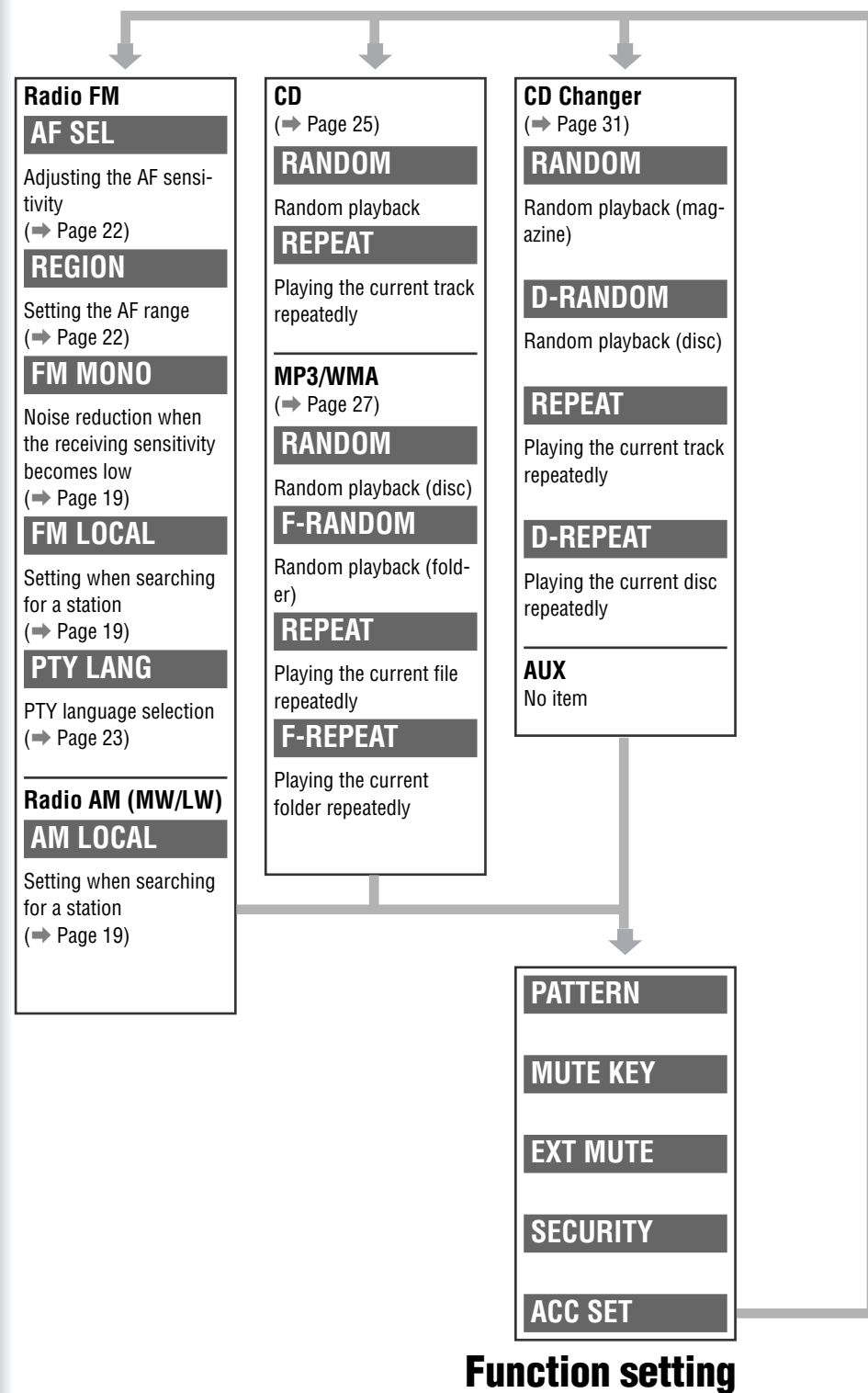

(=> Next page)

Menu Selection Order

Function Setting

- 1 Press [MENU] to open the menu.
(=> page 16)
For using the remote control, hold down [MENU] for 2 sec. or more.
- 2 Press [MENU] to select a mode to be adjusted.

The selection/adjustment screen appears 1 sec. after mode selection.
- 3 Press [BAND] (SET) to adjust the setting value.
- 4 Press [DISP] to return to the regular mode.

Note: If no operation takes place for more than 10 seconds, the display returns to Regular Mode.

PATTERN

Spectrum analyzer setting

- PATTERN 1 : Pattern 1 (Default)
- ⋮
- PATTERN 6 : Pattern 6
- PATT OFF : Off

Example: Pattern 1



MUTE KEY

Setting [MUTE] buttons' functions

- KEY MUTE : Volume off (Default)
- KEY ATT : Volume down by 10 steps

EXT MUTE (External Mute)

Volume adjustment when an interruption such as car navigation signal occurs

- MUTE LV0 : Volume off (Default)
- MUTE LV1 : Volume down by 15 steps
- MUTE LV2 : Volume down by 10 steps
- MUTE OFF : No change in volume

SECURITY

Setting the security function (=> Page 9)

- SLED ON : On (Default)
- SLED OFF : Off

ACC SET

Setting depending on your car

- ACC OFF : ACC not equipped (Default)
- ACC ON : ACC equipped

Caution:
Be sure to select OFF when your car has no ACC position in the ignition switch. Failure to do this could cause the battery to go dead.

English

Menu

This chapter explains how to listen to the radio.

1 Press **[SOURCE]** to select the radio mode.

2 Press **[BAND]** to select a band.

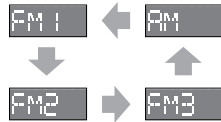

3 Select a station.

Frequency adjustment

[<] (TUNE): Lower
[>] (TUNE): Higher

Note: Hold down for 0.5 sec. or more and release for station search.

Preset station selection

[V] (P-SET: Preset): Lower preset number
[^] (P-SET: Preset): Higher preset number

Note: Direct selection can be executed with **[1]** to **[6]** buttons on remote control.

Notes:

- For tuning in on only stations whose receiving conditions are good in the station search, set LOCAL to ON. (→ page 19)
- For reducing noise when a receiving FM stereo wave is weak, set FM MONO to ON. (→ page 19)

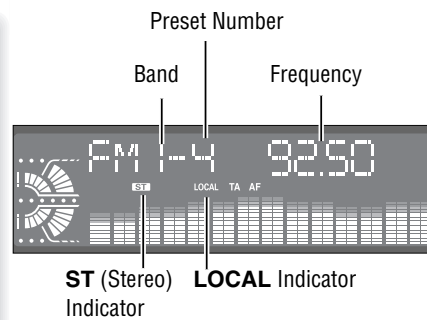

Display change

Press **[DISP]** (Display) to change.

AM (MW/LW) mode:



FM (not RDS) mode:

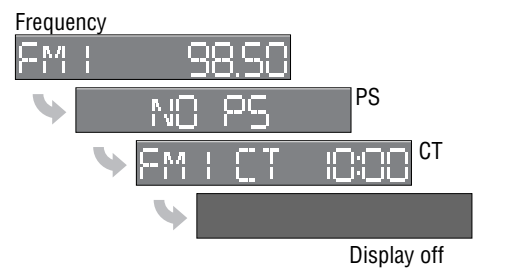

Up to 6 stations can be preset in AM (MW/LW), FM1, FM2, and FM3 respectively. Preset stations can be simply called up by pressing **[^]** (**P-SET**) or **[V]** (**P-SET**).
Note: Direct selection can be executed with **[1]** to **[6]** buttons on remote control.

Auto Preset Memory (APM)

- 1 Select a band.
- 2 Hold down **[BAND]** (**APM**) for 2 sec. or more.



Up to 6 best receiving stations are preset. The preset stations under best receiving conditions are received for 5 sec. each after presetting the stations (SCAN). To stop scanning, press **[^]** or **[V]**.

Notes:

- New stations overwrite existing saved stations.
- Only RDS stations will be saved at default setting (AF ON).

Note: In AM mode, only LOCAL can be selected.

- 1 Press **[MENU]** to open the menu. (→ page 16)
For using the remote control, hold down **[MENU]** for 2 sec. or more.
- 2 Press **[MENU]** to select a mode to be adjusted.
The selection/adjustment screen appears 1 sec. after mode selection.
- 3 Press **[BAND]** (**SET**) to adjust the setting value.
- 4 Press **[DISP]** to return to the regular mode.

Note: If no operation takes place for more than 10 seconds, the display returns to Regular Mode.

ON). To select non RDS stations too, set AF OFF. (→ Page 21)

Manual station preset

- 1 Tune in to a station.
- 2 Hold down **[^]** or **[V]** for 2 sec. or more.
- 3 Select a preset number by pressing **[^]** or **[V]**.
- 4 Preset the station by holding down **[^]** or **[V]** for 2 sec. or more.

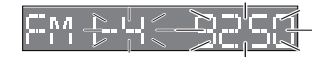

Frequency/preset number blinks once.

Notes:

- New stations overwrite existing saved stations.
- In step 2, a station can be registered by holding down the numeric button **[1]** to **[6]** for 2 sec. or more.
- To stop presetting stations, press **[DISP]** (Display).

FM MONO (Monaural)

Noise reduction when the receiving sensitivity becomes low

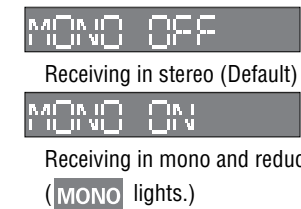

FM LOCAL/AM LOCAL

Setting when searching for a station

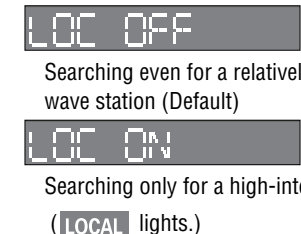

Radio Data System (RDS) in FM Broadcasting

Useful functions such as **AF**, **TA**, **PTY**, etc. are available in the RDS (Radio Data System)-ready areas.

Some FM stations are broadcasting added data compatible with RDS. This radio set offers convenient functions using such data.

RDS service availability varies with areas. Please understand if RDS service is not available in your area, the following service is not available, either.

The following functions are available when receiving RDS stations.

AF (Alternative Frequency)



The following functions are available when the AF mode is active (→ Page 21).

- When receiving conditions become bad, a station with better receiving conditions is automatically tuned in to.
- When executing APM, only RDS stations are selected.
- When calling up a preset station, a best receiving station is selected automatically. (**BSR** Best Stations Research)

Notes:

- The AF sensitivity can be adjusted. (→ Page 22)
- The AF available range can be adjusted. (→ Page 22)

TA (Traffic Announcement)

The following functions are available when the TA mode is active. (→ Page 22)

- A TP station is automatically searched for and received at the instant of toggling the TA mode on if you are receiving a non-TP station or TP station with poor reception.



- When executing station search or APM, only TP stations are selected.
- Setting to TA on with the unit in another mode, it will automatically switch to radio mode and output the traffic announcement when the traffic announcement begins. The traffic announcement having finished, the unit will return to the previous mode. (TA Standby Mode)

PTY (Program Type)



The following functions are available when the PTY mode is active (→ Page 23).

- The PTY of receiving station appears.
- Programs can be searched for by PTY.

Note: PTY language can be selected (→ Page 23).

Other functions of RDS

CT (Clock Time)

The clock is automatically adjusted.

PS (Program Service Name)

As well as the frequency, the name of the broadcast station appears.

EON (Enhanced Other Network)

RDS information is updated constantly in response to the current position.

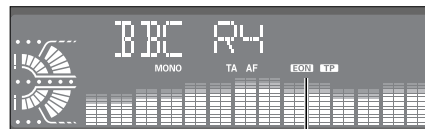

lights while receiving the EON signal.

EON-TA

Traffic information from the current and other network stations can be received.

Emergency Announcement Reception

Emergency announcement automatically appears on the display when it is received.



What is RDS?

RDS Mode Display

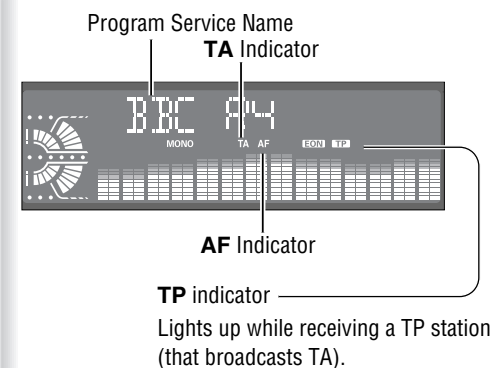

PTY on display



Receiving station PTY PTY mode indicator

AF ON/OFF

Holding down **[TA]** (**AF**) for 2 sec. or more toggles AF on and off.

Note: This operation is not adjustable by the remote control.

On (default)



Off

PI Seek (Program Identification Seek)

(only by remote control unit)

If reception becomes poor when tuning in a preset station, press the same preset number button. The same station with better reception will be searched for. Press the same preset number button again to cancel.



Note: For PI Seek, cancel the TA mode first, then execute PI Seek.

Display change

Press **[DISP]** (Display) to change.

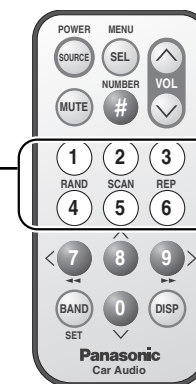

English

Radio Data System (RDS) in FM Broadcasting

TA ON/OFF

Pressing [TA] toggles TA on and off.

Note: This operation is not adjustable by the remote control.

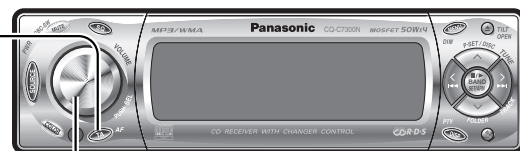

TA Volume Adjustment

The TA volume is adjustable.

Hold down [SEL] for 2 sec. or more while receiving an FM broadcast.

The current FM volume becomes the TA volume.

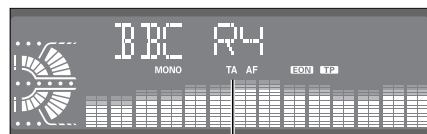

lights when TA is activated.



Traffic Information Only (TA Mute)

For listening to only traffic information, activate TA and set the volume to 0 in FM mode.

Once traffic information starts, the volume changes to the TA volume.

1 Press [MENU] to open the menu.

(→ page 16)

For using the remote control, hold down [MENU] for 2 sec. or more.

2 Press [MENU] to select a mode to be adjusted.

The selection/adjustment screen appears 1 sec. after mode selection.

3 Press [BAND] (SET) to adjust the setting value.

4 Press [DISP] to return to the regular mode.

Note: If no operation takes place for more than 10 seconds, the display returns to Regular Mode.

AF SEL

Adjusting the AF sensitivity

AF 1: Switching immediately after the receiving sensitivity becomes low (for a suburban area with a fine view) (Default)

AF 2: No switching even after the receiving sensitivity temporarily becomes low (for an area with a obstructed view)

REGION

Setting the AF range

REG OFF:

The frequency is changed also for programs outside the region. (Default)

REG ON:

The frequency is changed only for programs within the region.

PTY ON/OFF

Holding down [DISP] (PTY) for 2 sec. or more toggles PTY mode on and off.

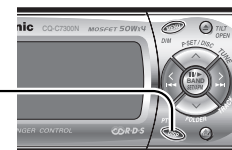

Note: This operation is not adjustable by the remote control.

Program Search by PTY

Programs can be searched for by use of PTY that has been originally preset.

Press [^] or [v] to select PTY in the PTY mode.

	Program Type	Contents
1	NEWS	NEWS
2	SPEECH	AFFAIRS, INFO, EDUCATE, DRAMA, CULTURE, SCIENCE, VARIED, WEATHER, FINANCE, CHILDREN, SOCIAL, RELIGION, PHONE IN, TRAVEL, LEISURE, DOCUMENT
3	SPORT	SPORT
4	POP M	POP M
5	CLASSICS	CLASSICS
6	MUSIC	ROCK M, EASY M, LIGHT M, OTHER M, JAZZ, COUNTRY, NATION M, OLDIES, FOLK M

Another station in the same PTY is searched for by pressing [BAND] (SET).

Notes:

- Direct selection can be executed with [1] to [6] buttons on remote control.
- When there is no corresponding program type station, "NONE" is displayed.
- A desired PTY appears for 5 seconds.
- Preset contents are changeable.

Detailed PTY Selection

1 Press [<] or [>] to select PTY.

→ SPEECH	→ MUSIC	→ NEWS	→ AFFAIRS
→ INFO	→ SPORT	→ EDUCATE	→ DRAMA
→ CULTURE	→ SCIENCE	→ VARIED	→ POP M
→ ROCK M	→ EASY M	→ LIGHT M	→ CLASSICS
→ OTHER M	→ WEATHER	→ FINANCE	→ CHILDREN
→ SOCIAL	→ RELIGION	→ PHONE IN	→ TRAVEL
→ LEISURE	→ JAZZ	→ COUNTRY	→ NATION M
→ OLDIES	→ FOLK M	→ DOCUMENT	

2 Press [BAND] (SET).
Search starts.

Notes:

- To stop searching, press [BAND] (SET).
- When there is no corresponding program type station, "NONE" is displayed.

PTY Preset Change

Original PTY presets can be changed as you like.

1 Select a PTY that you would like to preset.

2 Follow the procedure of ordinary presetting. (→ Page 19)

PTY LANG (language selection)

Note: PTY language is selectable only when PTY appears.

1 Press [MENU] to open the menu.

(→ page 16)

For using the remote control, hold down [MENU] for 2 sec. or more.

2 Press [MENU] to select a mode to be adjusted.

The selection/adjustment screen appears 1 sec. after mode selection.

3 Press [BAND] (SET) to adjust the setting value.

4 Press [DISP] to return to the regular mode.

Note: If no operation takes place for more than 10 seconds, the display returns to Regular Mode.

1 Press [OPEN] to open the front panel.

When a disc is already loaded, the disc will automatically be ejected.

2 Load a disc with the label-side facing up.

The front panel closes automatically, and the unit recognizes the disc and starts playing automatically, too.

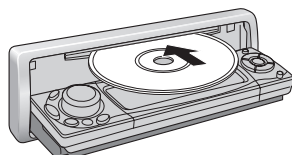

When a disc is already loaded, press [SOURCE] to select the CD mode.

Note: The power is turned on automatically when inserting a disc at ACC on.

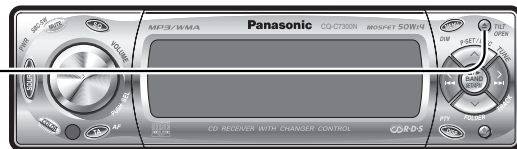

3 Select a desired portion.

Track selection

[▶▶] (TRACK): Next track

[◀◀] (TRACK): Preceding track (press twice.)

Note: Press and hold for fast forward/reverse.

Pause

Press [BAND] (||▶).

Press again to cancel.

Display change

Press [DISP] (Display) to change.

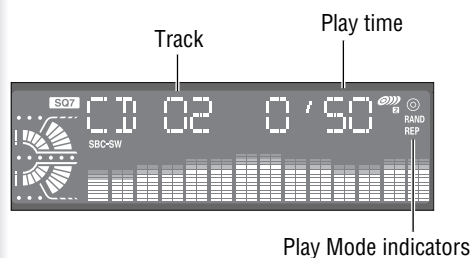
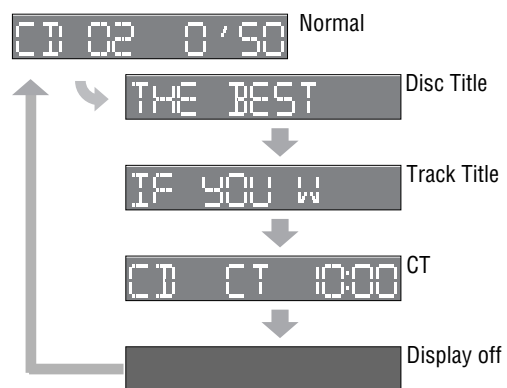

Notes:

- For scrolling text, hold down [BAND] for 2 sec. or more.
- If the number of displayed characters is 8 or less, the characters do not scroll.
- "NO TEXT" is displayed when there is no information on the disc.

Cautions:

- This unit does not support 8 cm discs.
- Do not use irregularly shaped discs.
- Do not use discs that have a seal or label attached.
- To avoid damaging the front panel, do not push it down or place objects on it while it is open.
- Do not pinch your finger or hand in the front panel.
- Do not insert foreign objects into the disc slots.
- Refer to the section on "Notes on CD/CD Media" (→ Page 37).

- A disc which has both CD-DA data and MP3/WMA data on it may not be reproduced normally. (For example, it may be reproduced without sound.)

Play Mode Selection (CD menu display)

(RANDOM, REPEAT)

Random and Repeat play can be set.

1 Press [MENU] to open the menu.

(→ page 16)

For using the remote control, hold down [MENU] for 2 sec. or more.

2 Press [MENU] to select a mode to be adjusted.

The selection/adjustment screen appears 1 sec. after mode selection.

3 Press [BAND] (SET) to adjust the setting value.

4 Press [DISP] to return to the regular mode.

Note: If no operation takes place for more than 10 seconds, the display returns to Regular Mode.

RANDOM



Random playback (RAND lights.)

REPEAT



Playing the current track repeatedly (REP lights.)

Functions Only by Remote Control Unit

Play Mode Selection

One-touch operation is available for selecting a track playing style by use of [RAND] (Random) or [REP] (Repeat).

RANDOM

Press [RAND] (Random).
Press again to cancel.

REPEAT

Press [REP] (Repeat).
Press again to cancel.

SCAN play

You can find your favorite track by playing first 10-sec. of each track.

Press [SCAN].

Press again to cancel.



Direct Access

A track can be directly selected.

Example: track number 5

1 Press [#] (NUMBER).

2 Press [5].

3 Press [SET].



Note: To suspend direct selection, press [DISP] (Display).

1 Press [OPEN] to open the front panel.

When a disc is already loaded, the disc will automatically be ejected.

2 Load a disc with the label-side facing up. The front panel closes automatically, and the unit recognizes the disc and starts playing automatically, too.

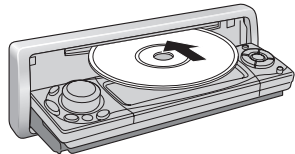

When a disc is already loaded, press [SOURCE] to select the CD mode.

Note: The power is turned on automatically when inserting a disc at ACC on.



3 Select a desired portion.

Folder selection

- [^] (FOLDER): Next folder
- [v] (FOLDER): Preceding folder

File selection

- [▶▶] (TRACK): Next file
- [◀◀] (TRACK): Preceding file (press twice.)

Note: Press and hold for fast forward/reverse.

Pause

- Press [BAND] (|| / ▶).
- Press again to cancel.

Notes:

- Refer to the section on “Notes on MP3/WMA” (→ Page 28-29)
- A disc which has both CD-DA data and MP3/WMA data on it may not be reproduced normally. (For example, it may be reproduced without sound.)

Random and Repeat play can be set.

1 Press [MENU] to open the menu. (→ page 16)

For using the remote control, hold down [MENU] for 2 sec. or more.

2 Press [MENU] to select a mode to be adjusted.

The selection/adjustment screen appears 1 sec. after mode selection.

3 Press [BAND] (SET) to adjust the setting value.

4 Press [DISP] to return to the regular mode.

Note: If no operation takes place for more than 10 seconds, the display returns to Regular Mode.

RANDOM

RAND ON

Random playback (disc) (RAND lights.)

F-RANDOM

F-RAND ON

Random playback (folder) (FOLDER RAND lights.)

REPEAT

REP ON

Playing the current file repeatedly (REP lights.)

F-REPEAT

F-REP ON

Playing the current folder repeatedly (FOLDER REP lights.)

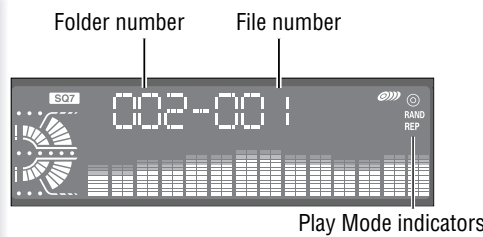

Display change

Press [DISP] (Display) to change.

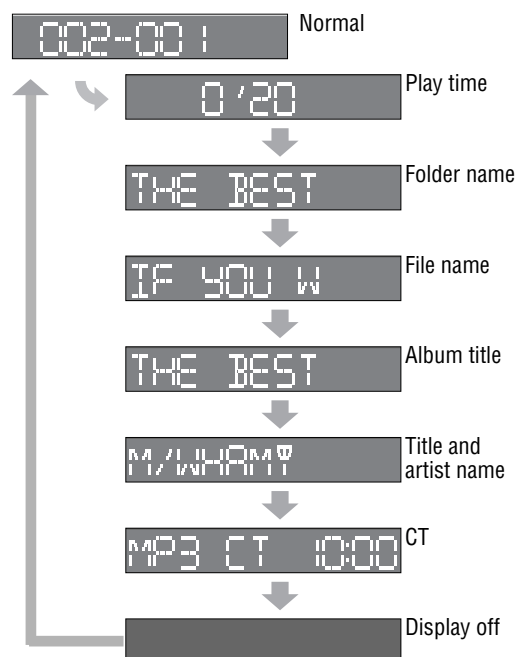

Notes:

- For scrolling text, hold down [BAND] for 2 sec. or more.
- If the number of displayed characters is 8 or less, the characters do not scroll.
- “NO TEXT” is displayed when there is no information on the disc.

Play Mode Selection

One-touch operation is available for selecting a file playing style by use of [RAND] (Random) or [REP] (Repeat).

- RANDOM, REPEAT
Press the button. Press again to cancel.
- FOLDER RANDOM, FOLDER REPEAT
Hold down the button for 2 sec. or more. Hold down again to cancel.

SCAN play

You can find your favorite file by playing first 10-sec. of each file.

- SCAN (All files)
Press [SCAN]. Press again to cancel.

- FOLDER SCAN (1st file in each folder)
Hold down [SCAN] for 2 sec. or more. Hold down again to cancel.

Direct Access

A file in the current folder can be directly selected.

Example: file number 5

- 1** Press [#] (NUMBER).
- 2** Press [5].
- 3** Press [SET].

Notes:

- For folder selection, enter a number after pressing [#] (NUMBER) twice.
- To suspend direct selection, press [DISP] (Display).

What is MP3/WMA?

MP3 (MPEG Audio Layer-3) and WMA (Windows Media™ Audio) are the compression formats of digital audio. The former is developed by MPEG (Motion Picture Experts Group), and the latter is developed by Microsoft Corporation. Using these compression formats, you can record the contents of about 10 music CDs on a single CD media (This figures refer to data recorded on a 650MB CD-R or CD-RW at a fixed bit rate of 128 kbps and a sampling frequency of 44.1 kHz).

Notes:

- MP3/WMA encoding and writing software is not supplied with this unit.
- CD writing software is not supplied with this unit.

Points to remember when making MP3/WMA files

Common

- High bit rate and high sampling frequency are recommended for high quality sounds.
- Selecting VBR (Variable Bit Rate) is not recommended because playing time is not displayed properly and sound may be skipped.
- The playback sound quality differs depending on the encoding circumstances. For details, refer to the user manual of your own encoding software and writing software.

MP3

- It is recommended to set the bit rate to "128 kbps or more" and "fixed".

WMA

- It is recommended to set the bit rate to "64 kbps or more" and "fixed".
- Do not set the copy protect attribute on the WMA file to enable this unit to play back.
- WMA Version 9 is supported. However, the new functions in Version 9 (WMA pro, Loss-less, and the combination of 64 kbps and 48 kHz) are excluded.

Caution: Never assign the ".mp3", or ".wma" file name extension to a file that is not in the MP3/WMA format. This may not only produce noise from the speaker damage, but also damage your hearing.

Display Information

Displayed items

- | | |
|---|---|
| • CD-TEXT
Disc title
Track title | • MP3 (ID3 tag)
Album name
Title and artist name |
| • MP3/WMA
Folder name
File name | • WMA (WMA tag)
Album name
Title and artist name |

Displayable characters

- Displayable length of file name/folder name: within 64 characters
- Name files and folders in accordance with the standard of each file system. Refer to the instructions of writing software for details.
- ASCII character set and special characters in each language can be displayed.

ASCII character set

A to Z, a to z, digits 0 to 9, and the following symbols:
(space) ! " # \$ % & ' () * + , - . / : ; < = > ? @ [\] ^ _ ` { | } ~

Special characters

À Á Â Ã Ä Å à á â ã ä å
Ä ä
Ò Ó Ô Õ Ö ò ó ô õ ö ö ö
Ù Ú Û Ü ù ú û ü

Notes:

- With some software in which MP3/WMA format files have been encoded, the character information may not be displayed properly.
- Undisplayable characters and symbols will be converted into an asterisk (*).

Recording MP3/WMA files on a CD-media

- You are recommended to minimize the chances of making a disc that contains both CD-DA files and MP3/WMA files.
- If CD-DA files are on the same disc as MP3 or WMA files, the songs may not play in the intended order, or some songs may not play at all.
- When storing MP3 data and WMA data on the same disc, use different folders for each data.
- Do not record files other than MP3/WMA files and unnecessary folder on a disc.
- The name of MP3/WMA file should be added by rules as shown in the following descriptions and also comply with the rules of each file system.
- You may encounter trouble in playing MP3/WMA files

- or displaying the information of MP3/WMA files recorded with certain writing software or CD recorders.
- The file extension ".mp3" or ".wma" should be assigned to each file depending on the file format.
- This unit does not have the play list function.
- Although Multi-session recording is supported, the use of Disc-at-Once is recommended.

Supported file systems

ISO 9660 Level 1/Level 2, Apple Extension to ISO 9660, Joliet, Romeo

Note: Apple HFS, UDF 1.50, Mix CD, CD Extra are not supported.

Compression formats

(Recommendation: "Points to remember when making MP3/WMA files" on the previous page)

Compression method	Bit rate	VBR	Sampling frequency
MPEG 1 audio layer 3 (MP3)	32 k-320 kbps	Yes	32, 44.1, 48 kHz
MPEG 2 audio layer 3 (MP3)	8 k-160 kbps	Yes	16, 22.05, 24 kHz
Windows Media Audio Ver. 2, 8, 9	64 k-192 kbps	No	32, 44.1, 48 kHz

Folder selection order/file playback order

Maximum number of files/folders

- Maximum number of files: 999
- Maximum number of files in one folder: 255
- Maximum depth of trees: 8
- Maximum number of folders: 255 (Root folder is included.)

Notes:

- This unit counts the number of folders irrespective of the presence or absence of MP3/WMA file.
- If the selected folder does not contain any MP3/WMA files, the nearest MP3/WMA files in the order of playback will be played.
- Playback order may be different from other MP3/WMA players even if the same disc is used.
- "ROOT" appears when displaying the root folder name.

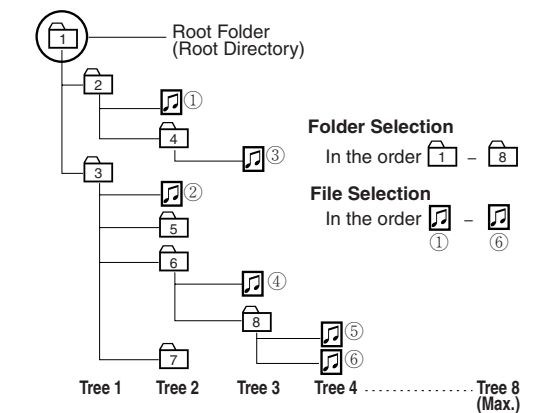

Windows Media, and the Windows logo are trademarks, or registered trademarks of Microsoft Corporation in the United States and/or other countries.



Copyright

It is prohibited by copyright laws to copy, distribute and deliver copyrighted materials such as music without the approval of copyright holder except enjoying yourself personally.

No warranty

Above description complies with our investigations as of December 2003. It has no warranty for reproducibility and displayability of MP3/WMA.

CD Changer Control

Connected optional CD changer can be controlled by this unit.

1 Load a magazine (CDs).

When a magazine is already loaded, press **[SOURCE]** to select the CD changer mode.

The unit recognizes the magazine and starts playing automatically.

Note: The power is turned on automatically when inserting a magazine at ACC on.



2 Select a desired portion.

Switch between CD changers

(in the case of connecting 2 changers)

Press **[BAND] (SET)**.

Note: To connect two CD changers to it, the dual CD changer selector CA-CD55EN is necessary.

Disc selection

[^]: Next disc

[v]: Preceding disc

Track selection

[>>>]: Next track

[<<<]: Preceding track (press twice.)

Note: Press and hold for fast forward/reverse.

Display change

Press **[DISP]** (Display) to change.

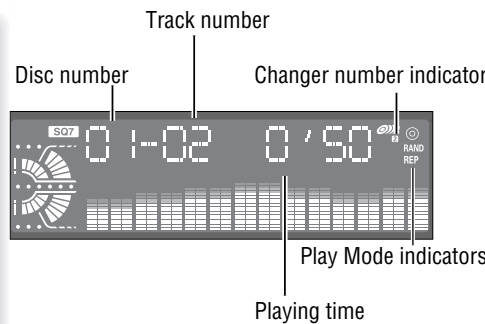
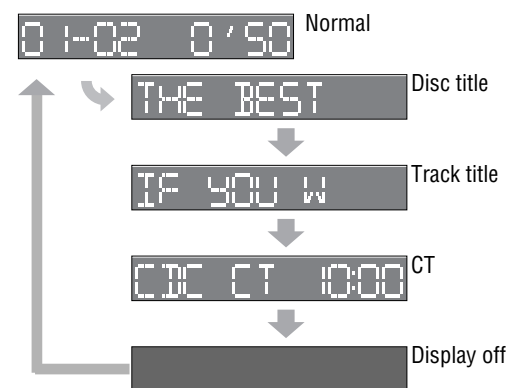

Notes:

- For scrolling text, hold down **[BAND]** for 2 sec. or more.
- If the number of displayed characters is 8 or less, the characters do not scroll.
- "NO TEXT" is displayed when there is no information on the disc.

Notes:

- CD text is displayed when the unit is connected to a CD changer capable of recognizing CD text (CX-DP9061EN, for example).
- Not compatible with CD-RW (except when CX-DP880N is connected).

- Trouble may occur while playing CD-Rs. Refer to the section on "Notes on CD/CD Media (CD-ROM, CD-R, CD-RW)" (→ Page 37).
- Not compatible with MP3/WMA.
- Pausing does not function in the CD changer mode.

Random and Repeat play can be set.

1 Press [MENU] to open the menu.

(→ page 16)

For using the remote control, hold down **[MENU]** for 2 sec. or more.

2 Press [MENU] to select a mode to be adjusted.

The selection/adjustment screen appears 1 sec. after mode selection.

3 Press [BAND] (SET) to adjust the setting value.

4 Press [DISP] to return to the regular mode.

Note: If no operation takes place for more than 10 seconds, the display returns to Regular Mode.

RANDOM



Random playback (magazine) (**RAND** lights.)

D-RANDOM



Random playback (disc) (**DISC RAND** lights.)

REPEAT



Playing the current track repeatedly (**REP** lights.)

D-REPEAT



Playing the current disc repeatedly (**DISC REP** lights.)

Play Mode Selection

One-touch operation is available for selecting a track playing style by use of **[RAND]** (Random) or **[REP]** (Repeat).

- RANDOM, REPEAT
Press the button. Press again to cancel.
- DISC RANDOM, DISC REPEAT
Hold down the button for 2 sec. or more. Hold down again to cancel.

- DISC SCAN (1st file in each disc)
Hold down **[SCAN]** for 2 sec. or more. Hold down again to cancel.



Direct Access

A disc can be directly selected.

Example: disc number 5

- 1 Press **[#] (NUMBER)**.
- 2 Press **[5]**.
- 3 Press **[SET]**.



Note: To suspend direct selection, press **[DISP]** (Display).

SCAN play

You can find your favorite track by playing first 10-sec. of each track.

- SCAN (All tracks)
Press **[SCAN]**. Press again to cancel.



If You Suspect Something Wrong

Check and take steps as described below.

If the described suggestions do not solve the problem, it is recommended to take the unit to your nearest authorized Panasonic Service Centre. The product should be serviced only by qualified personnel.

Cautions:

- Do not use the unit in an irregular condition, for example, without sound, or with smoke or foul smell, which can cause ignition or electric shock. Immediately stop using the unit and call the store where you purchased it.
- Never try to repair the unit by yourself because it is dangerous to do so.

Problem	Possible cause → Possible solution
No power to the unit	The power cord (battery, ACC and ground) is connected in the wrong way. → Check the wiring.
	Fuse blowout → Eliminate the cause of fuse blowout and replace the fuse with new one. Consult your dealer.
Sound is not generated.	MUTE is set to ON. → Set MUTE to OFF.
	There is contact between the external mute lead and the chassis. → Connect the external mute lead correctly. If the lead is unused, insulate it.
	The wiring of speaker lines are not correct, or a break or poor contact arises. → Check the wiring in accordance with the wiring diagram. (Installation Instructions)
The demonstration screen displayed and no operable	You cannot operate the unit while the demonstration screen appears. → Press [DISP] to end the demonstration screen.
	If the demonstration screen appears frequently, there is a possibility that poor contact or wrong wiring arises between the battery lead of the unit and the battery cable of the car. (The battery lead should be always powered.) → Check the battery wiring in accordance with the wiring diagram.
Noise	There is an electromagnetic-wave generator such as a cellular phone near the unit or its electrical lines. → Keep an electromagnetic-wave generator such as a cellular phone away from the unit and the wiring of the unit. In case that noise cannot be eliminated due to the wiring harness of the car, consult your dealer.
	The contact of the ground lead is poor. → Make sure that the ground lead is connected to an unpainted part of the chassis securely.
Noise is made in step with engine revolutions.	Alternator noise comes from the car. → Change the wiring position of the ground lead. → Mount a noise filter on the power supply.

Common (continued)

Problem	Possible cause → Possible solution
Some operations are not executable.	Some operations are not executable in particular modes such as menu mode. → Read the operating instructions carefully and cancel the mode. In case the unit is still out of order, consult the dealer.
No sound from speaker(s)	BAL/FAD setting is not appropriate. → Readjust BAL/FAD.
	There is a break, a short circuit, poor contact or wrong wiring regarding the speaker wiring. → Check the speaker wiring.
The speaker channels are reversed between right and left.	The speaker wiring is confused between right and left. → Perform the speaker wiring in accordance with the wiring diagram.
The sound field is not clear in the stereo mode. Central sound does not settled.	The plus and minus terminals at right and left channels of speakers are connected reversely. → Perform the speaker wiring in accordance with the wiring diagram.
The power fails unintentionally.	The safety device works. → Call the store where you purchased the unit, or your nearest Panasonic Service Centre.

Radio

Poor reception or noise	Antenna installation or wiring of antenna cable is faulty. → Check whether the antenna mounting position and its wiring are correct. In addition, check to see whether the antenna ground is securely connected to the chassis. No power is supplied to the antenna amplifier (when using a film antenna, etc.). → Check the wiring of the antenna battery lead.
Stereo broadcast is received only in mono.	The MONO mode is active. → Cancel the MONO mode.
Only nearby stations can be received.	The LOCAL mode is active. → Cancel the LOCAL mode.

Problem	Possible cause → Possible solution
The number of auto preset stations is less than 6.	The number of receivable stations is less than 6. → Move to an area where receivable stations number is maximum, and try pre-setting. The LOCAL mode is active. → Cancel the LOCAL mode.
Preset stations cannot be stored.	The contact of the battery lead is poor, or the battery lead is not always powered. → Make sure that the battery lead is connected securely, and preset stations again.



PS does not appear even if an RDS station is tuned into. ("NONE" appears.)	A PS code cannot be received for the reason of bad receiving conditions, etc. → A PS code appears if it is received. Wait for a while until conditions change.
Receiving programs differs from PTY that was already set up.	When the station changed between programs, the unit could not receive the PTY code. → An appropriate program is searched for and tuned into after receiving a corresponding PTY code. Therefore, wait for a while.
"NONE" appears when selecting PTY.	Any specified PTY programs cannot be received. There is no desired program being broadcast in your area. → Select another PTY, or wait until a desired program starts.
The clock (CT) does not indicate accurate time.	The unit received a station that broadcasting time that is not appropriate for you, or the unit is receiving a station that does not broadcast time. → Receive a station that broadcasting time that is appropriate for your area, or adjust CT manually.
An AF station cannot be received even if EON is set to ON.	There is little difference in receiving conditions between the current station and AF stations. Update of AF list ended in failure. → Wait until AF list is successfully updated. For unstable reception, tune into a stable station by hand.

Problem	Possible cause → Possible solution
No playback or disc ejected	The disc is inserted upside down. → Insert a disc correctly. There is a flaw or foreign material on the disc. → Remove the foreign material, or use a flawless disc.
Sound skipping or noise	There is a flaw or foreign material on the disc. → Remove the foreign material, or use a flawless disc.
Sound skipping due to vibration	The unit is not sufficiently secured. → Secure the unit to the console box with the rear support strap, etc. The unit is tilted at over 30° in the front-to-end direction. → Make the angle 30° or less.
Disc unejectable	Something such as a peeled label obstructs the disc coming out. → Hold down the [OPEN] button for 5 sec. or more when the front panel is open (disc forced ejection). In case that the disc forced ejection does not work, consult the dealer. The microcontroller in the unit operates abnormally due to noise or other factors. → Press the reset switch. If there is no reset switch, unplug the power cord and plug it again. In case the unit is still out of order, consult the dealer.

No playback or disc ejected	The disc has unplayable formatted data. → Refer to the description about MP3/WMA for playable sound data except CD-DA (i.e. music CD). The unit plays back the first track of a MIX mode CD. → Skip the first track.
The CD-R/RWs that are playable on other devices are not playable on this unit.	The playability of some CD-R/RWs may depend on the combination of media, recording software and recorder to be used even if these CD-R/RWs are playable on other devices such as a PC. → Make CD-R/RWs in different combination of media, recording software and recorder after referring to the description about MP3/WMA.
Sound skipping or noise	There is a flaw or foreign material on the disc. → Remove the foreign material, or use a flawless disc. For MP3/WMA, refer to the description about MP3/WMA.

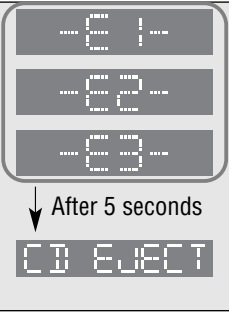
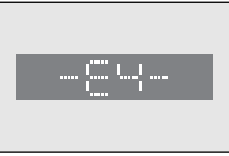
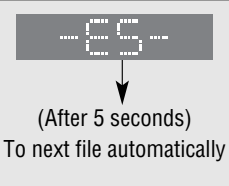
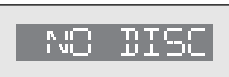
Note: Refer to "Notes on MP3/WMA" → Page 28

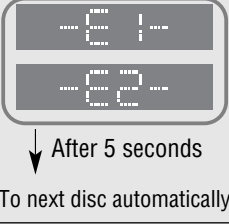
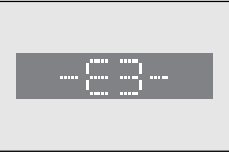
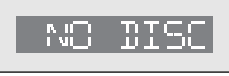
Display	Possible cause/Possible solution
 <p>After 5 seconds ↓ [EJECT]</p>	<p>Disc is dirty, or is upside down.</p> <p>Disc has scratches.</p> <p>! No operation by some cause. → Call the store where you purchased the unit, or your nearest Panasonic Service Centre.</p>
	<p>The file is not readable.</p> <p>Error display continues when there is no playable file in the specified folder at the direct folder selection. → Specify another folder.</p>
 <p>(After 5 seconds) ↓ To next file automatically</p>	<p>A WMA file can be copyrighted. → The file protected by copyright is not playable.</p>
	<p>No disc.</p>

 <p>After 5 seconds ↓ To next disc automatically</p>	<p>Disc is dirty, or is upside down.</p> <p>Disc has scratches.</p>
	<p>No operation by some cause. → Eject the magazine. If failure persists, press the reset switch on the CD changer. If normal operation is not restored, call the store where you purchased the unit or the nearest Panasonic Service Centre to ask for repairs.</p>
	<p>No disc (magazine).</p>
	<p>No changer.</p>

Note: Messages in the action and display sections of the error chart vary with changers. Refer to the operating instructions for the CD changer for details.

If you use commercial CDs, they must have either of these labels shown at right.



How to hold the disc

- Do not touch the underside of the disc.
- Do not scratch on the disc.
- Do not bend the disc.
- When not in use, keep disc in the case.

Label side



Do not use irregularly shaped discs.

Do not leave discs in the following places:

- Direct sunlight
- Near car heaters
- Dirty, dusty and damp areas
- Seats and dashboards

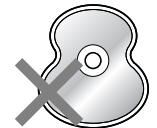
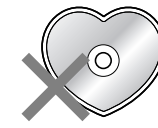

Do not use irregularly shaped discs.

Disc cleaning

Use a dry, soft cloth to wipe from the centre outward.

Do not attach any seals or labels to your discs.

Do not write on the disc label in a heavy pen or ballpoint pen.

<Correct>

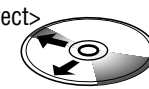

<Wrong>



- You may have trouble playing back some CD-R/RW discs recorded on CD recorders (CD-R/RW drives), either due to their recording characteristics or dirt, fingerprints, scratches, etc. on the disc surface.
- CD-R/RW discs are less resistant to high temperatures and high humidity than ordinary music CDs. Leaving them inside a car for extended periods may damage and make playback impossible.
- Some CD-R/RWs can not be played back successfully thanks to incompatibility among writing software, a CD recorder (CD-R/RW drive) and the discs.
- This player cannot play the CD-R/RW discs if the session is not closed.
- This player cannot play the CD-R/RW discs which contains other than CD-DA or MP3/WMA data (Video CD, etc.).
- Be sure to observe the instructions of CD-R/RW disc for handling it.

Your product is designed and manufactured to ensure the minimum of maintenance. Use a soft cloth for routine exterior cleaning. Never use benzene, thinner, or other solvents.

Use fuses of the same specified rating (15 A). Using different substitutes or fuses with higher ratings, or connecting the unit directly without a fuse, could cause fire or damage to the unit.

If the replacement fuse fails, contact your nearest authorized Panasonic Service Centre.

Power Supply	DC 12 V (11 V - 16 V), Test Voltage 14.4 V, Negative Ground
Tone Controls (Bass/Treble)	Bass; ± 12 dB at 60 Hz, Treble; ± 12 dB at 16 kHz
Current Consumption	Less than 2.2 A (CD mode, 0.5 W 4-Speaker)
Maximum Power Output	50 W x 4 (at 4 Ω)
Power Output	22 W x 4 (DIN45 324, at 4 Ω)
Speaker Impedance	4 - 8 Ω
Pre-out	5 V/60 Ω
Subwoofer-out	5 V/60 Ω
External Input Impedance	10 k Ω (AUX IN)
External Input Sensitivity	200 mV rms (AUX IN)
Dimensions (Main Unit)	178(W) x 50(H) x 155(D) mm
Weight (Main Unit)	1.6 kg

Sampling Frequency	8 times oversampling
DA Converter	MASH 1 bit/4 DAC System
Error Correction System	Panasonic Super Decoding Algorithm
Pick-Up Type	Astigma 3-beam
Light Source	Semiconductor laser
Wavelength	780 nm
Frequency Response	5 Hz - 20 kHz (± 1 dB)
Signal to Noise Ratio	96 dB
Total Harmonic Distortion	0.01 % (1 kHz)
Wow and Flutter	Below measurable limits
Channel Separation	75 dB

FM	
Frequency Range	87.5 - 108 MHz
Usable Sensitivity	6 dB/ μ V (S/N 30 dB)
Stereo Separation	35 dB (at 1 kHz)
AM (MW)	
Frequency Range	531 - 1 602 kHz
Usable Sensitivity	28 dB/ μ V (S/N 20 dB)
AM (LW)	
Frequency Range	153 - 279 kHz
Usable Sensitivity	32 dB/ μ V (S/N 20 dB)

Note: Specifications and design are subject to modification without notice due to improvements.

Sales and Support Information

Customer Care Centre

- For UK customers: 08705 357357
- For Republic of Ireland customers: 01 289 8333
- Visit our website for product information
- E-mail: customer.care@panasonic.co.uk

Direct Sales at Panasonic UK

- Order accessory and consumable items for your product with ease and confidence by phoning our Customer Care Centre Monday - Friday 9:00am - 5:30pm. (Excluding public holidays).
- Or go on line through our Internet Accessory ordering application at www.panasonic.co.uk.
- Most major credit and debit cards accepted.
- All enquiries transactions and distribution facilities are provided directly by Panasonic UK Ltd.
- It couldn't be simpler!
- Also available through our Internet is direct shopping for a wide range of finished products, take a browse on our website for further details.

Before Installation/Vor dem Einbau
Avant l'installation/Voor de installatie

Consult a professional for installation.
●Verify the radio using the antenna and speakers before installation.
Wenden Sie sich zum Einbau an einen Fachmann.
●Probieren Sie den Radiobetrieb vor dem Einbau mit Antenne und Lautsprechern aus.
Prenez contact avec un spécialiste pour le montage.
●Vérifiez l'autoradio avant de procéder au montage.
Vraag een vakman voor de installatie.
●Controleer voor de installatie of de radio werkt met de antenne en de luidsprekers.

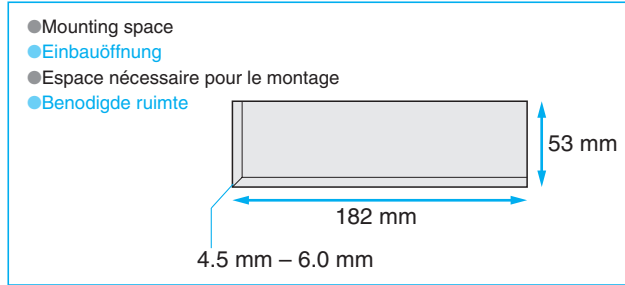
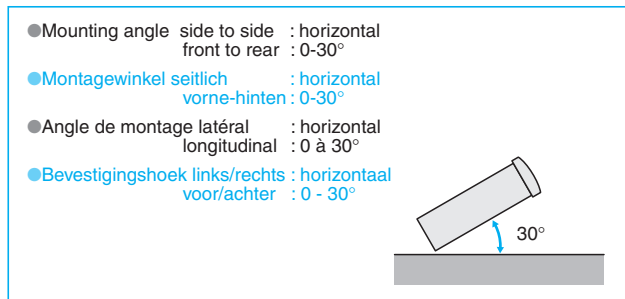

Remove Mounting Collar ① and Trim Plate ④ from the main unit temporarily, which are already mounted at shipment.
Die bei der Lieferung montierte Einbauhalterung ① und Abdeckplatte ④ vorübergehend vom Gerät abmontieren.
Démontez provisoirement le cadre de montage ① et la plaque de garniture ④ de l'appareil principal, qui sont déjà mis en place lors de l'expédition.
Verwijder de Bevestigingskraag ① en de Afwerkingsrand ④, die bij het verlaten van de fabriek gemonteerd zijn, tijdelijk van het hoofdtoestel.

Before Wiring/Vor der Verdrahtung
Avant le câblage/Voor het aansluiten van de bedrading

Exclusively operated with 12-volt battery with negative (-) ground.
Dieses Gerät ist ausschließlich für den Anschluss an Bordnetze mit 12 V Batterie und negativer (-) Klemme an Masse bestimmt.
Alimentez l'appareil absolument par la batterie de 12 volts avec sa polarité négative (-) mise à la masse.
Uitsluitend voor gebruik met een 12 Volt accusysteem met negatieve (-) aarding.

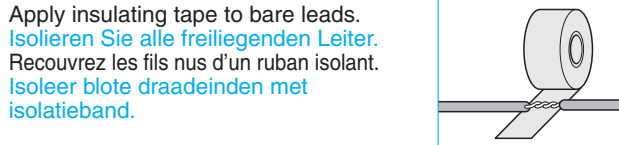
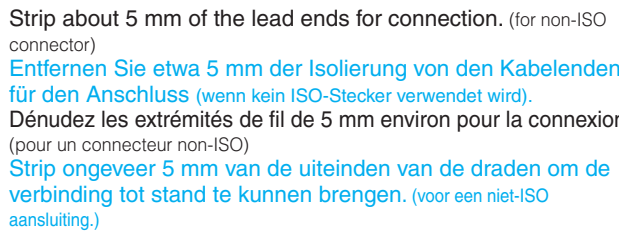
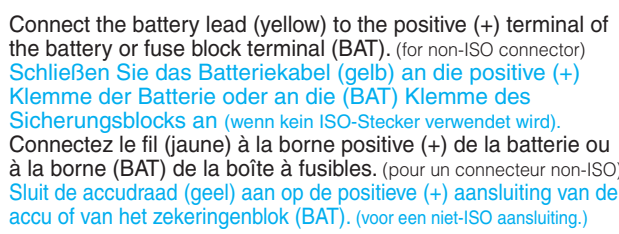
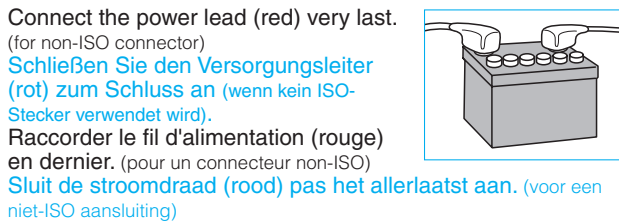

Secure loosened leads.
Sichern Sie alle losen Leiter.
Resserrez les connexions de fils.
Zet loshangende draden vast.

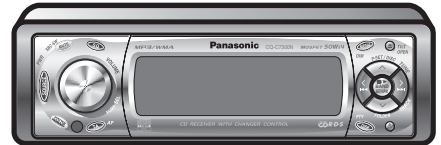

Supplied Hardware/Mitgelieferte Hardware/Matériel d'installation/Meegedeelde onderdelen

No.	Item	Diagram	Qty	No.	Item	Diagram	Qty
①	Mounting collar Einbauhalterung Cadre de montage Bevestigingskraag	YEFX0216165	1	④	Trim plate Abdeckplatte Plaque de garniture Afwerkingsrand	YEFC05606	1
②	Mounting bolt (5 mm) Befestigungsschraube (5 mm) Boulon (5 mm) Bout (5 mm)		1	⑤	ISO antenna adapter ISO-Antennenadapter Adaptateur d'antenne ISO ISO antenne-adapter		1
③	Power connector Versorgungsstecker Connecteur d'alimentation Stroomstekker	YEAJ02872	1	⑥	Lock cancel plate Verriegelungs freigabeplatte Plaque anti-blocage Ontgrendelingsplaat		2

* ②, ⑤ and ⑥ consist of a set. (YEP0FZ3316) * ②, ⑤ und ⑥ bestehen als Satz. (YEP0FZ3316)
* ②, ⑤ et ⑥ constituent un jeu. (YEP0FZ3316) * ②, ⑤ en ⑥ bestaan uit een set. (YEP0FZ3316)



●Please read these instructions carefully before using this product and keep this manual for future reference.
●Bitte lesen Sie diese Bedienungsanleitung vor der Verwendung dieses Produktes aufmerksam durch und bewahren Sie sie danach für spätere Nachschlagzwecke sorgfältig auf.
●Prière de lire ces instructions attentivement avant d'utiliser le produit et garder ce manuel pour l'utilisation ultérieure.
●Leest u deze instructie alstublieft zorgvuldig door voor u dit product in gebruik neemt en bewaar deze handleiding voor later gebruik.

Matsushita Electric Industrial Co., Ltd.
Web Site : <http://www.panasonic.co.jp/global/>

YEFM293247 NT1203-0 Printed in China

Installation/Einbau/Montage/Installatie

How to install the unit/Einbau des Gerätes/Mode de montage de l'appareil/Installeren van het toestel

Cautions : ●Wear gloves for safety.
●Make sure that wiring is completed before installation.
Vorsicht : ●Tragen Sie Handschuhe, um sich vor Verletzungen zu schützen.
●Achten Sie vor dem Einbau darauf, dass die Verdrahtung fertiggestellt ist.
Précautions : ●Porter des gants à des fins de sécurité.
●S'assurer que le câblage est terminé avant l'installation.
Let op : ●Draag handschoenen voor uw veiligheid.
●Controleer of de bedrading correct is aangelegd voor u gaat installeren.

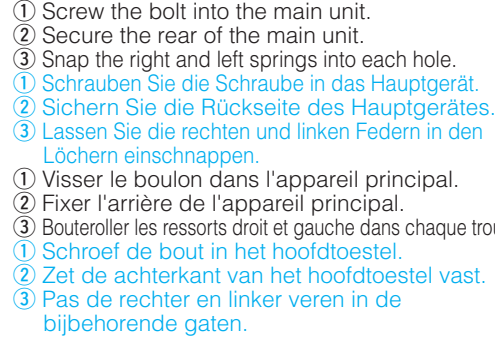
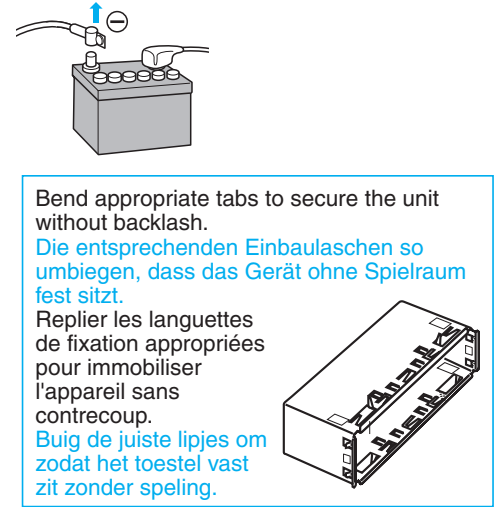
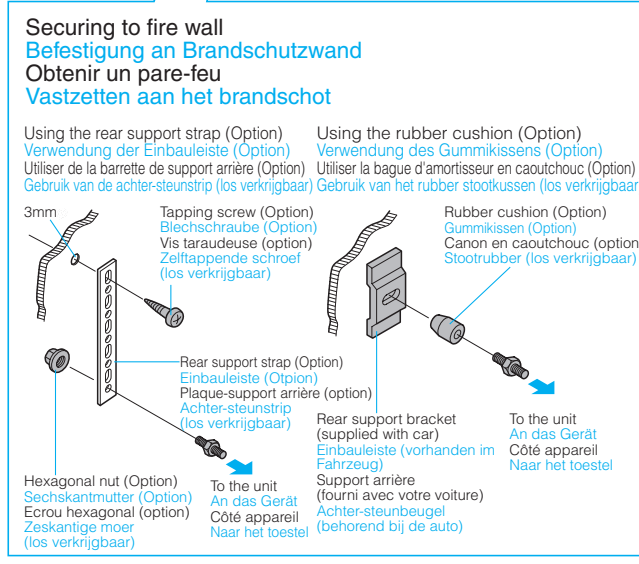
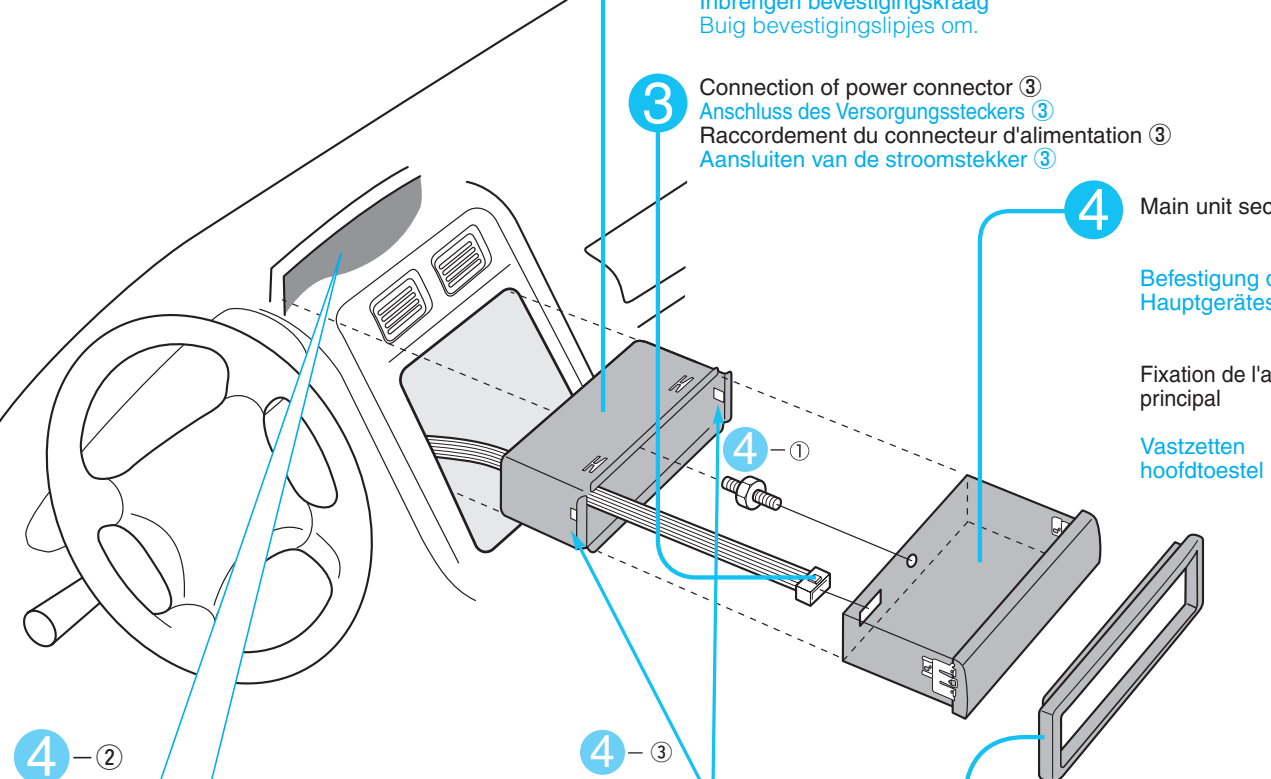

IMPORTANT
When this unit is installed in dashboard, ensure that there is sufficient air flow around the unit to prevent damage from overheating, do not block any ventilation holes on the unit.
WICHTIG
Bei Einbau des Geräts im Armaturenbrett sollte darauf geachtet werden, dass der Luftstrom um das Gerät nicht behindert ist, um Beschädigung durch Überhitzen zu verhindern, und die Belüftungsöffnungen des Geräts nicht blockiert sind.

IMPORTANT
Lorsque cet appareil est installé dans le tableau de bord, assurez-vous qu'il y a une circulation d'air suffisante autour de l'appareil afin d'éviter tout endommagement provoqué par une surchauffe et qu'aucun trou d'aération de l'appareil n'est obturé.
BELANGRIJK
Wanneer dit toestel in het dashboard wordt geïnstalleerd, moet u ervoor zorgen dat er voldoende ventilatie is rond het toestel. Om oververhitting te voorkomen mogen de ventilatie-Openingen in het toestel niet afgedekt worden.

How to remove the unit/Ausbau des Gerätes
Dépose de l'appareil/Verwijderen van het toestel

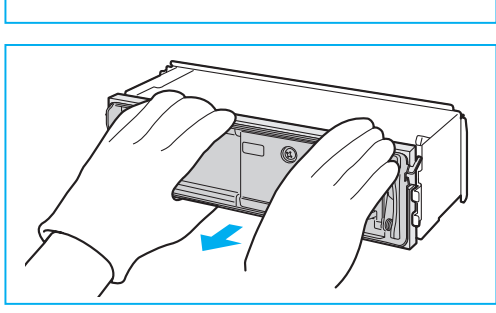
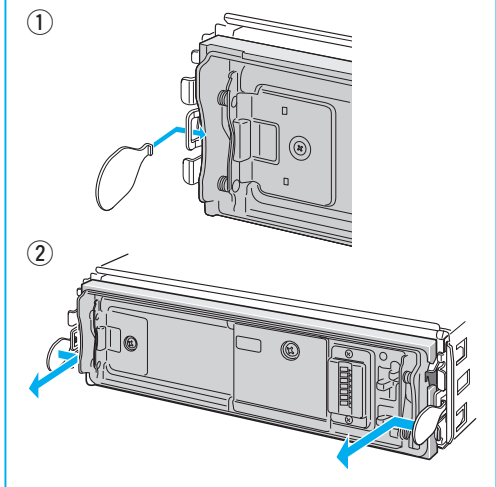
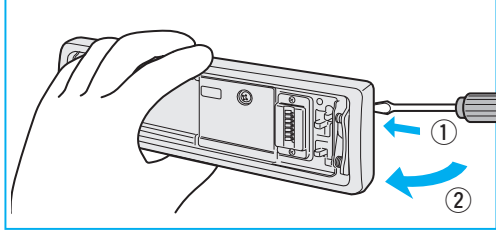
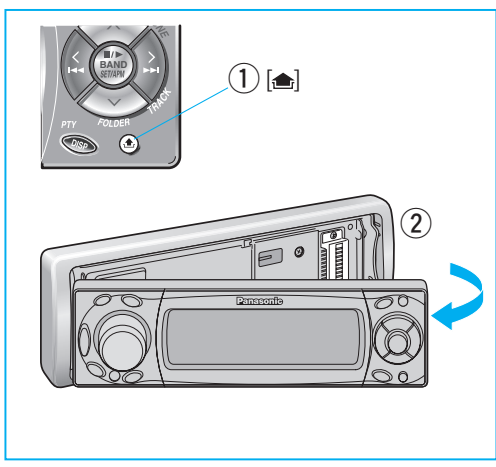

Wiring/Verdrahtung/Câblage/Bedrading

CD Changer Control Connector The DIN cord of a CD changer (ex. CX-DP880N) should be connected. The DIN cord of a dual CD changer selector (ex. CA-CD55EN) should be connected when the selector is incorporated into the system.
Steckverbinder der CD-Wechslersteuerung Hier das DIN-Kabel eines CD-Wechslers (z.B. CX-DP880N) anschließen. Hier das DIN-Kabel einer Doppelwechsler-Steuerung (z.B. CA-CD55EN) anschließen, wenn eine solche im System vorhanden ist.
Connecteur de commande de changeur de disque CD Le cordon DIN d'un changeur de disque CD (expl. CX-DP880N) doit être raccordé. Le cordon DIN d'un sélecteur de double changeur de disque CD (par expl. CA-CD55EN) doit être connecté lorsque le sélecteur est incorporé dans le système.
Stekker CD-wisselaar bediening Sluit het DIN snoer van de CD-wisselaar (bijv. CX-DP880N) aan.
Sluit het DIN snoer van een tweevoudige CD-wisselaar keuzeschakelaar (bijv. CA-CD55EN) aan wanneer de keuzeschakelaar deel uitmaakt van uw systeem.

Fuse (15A) Refer fuse replacement to your nearest authorized Panasonic Service centre. Do not try fuse replacement by yourself.
Sicherung (15A): Wenden Sie sich zum Austausch der Sicherung an eine autorisierte Panasonic-Kundendienststelle in Ihrer Nähe. Versuchen Sie nicht, den Austausch selbst vorzunehmen. Steckverbinder am Fahrzeug.
Fusible (15A) Confier le remplacement de fusible au centre de service de service après-vente Panasonic agréé le plus proche. Ne pas essayer de remplacer le fusible tout(e) seul(e).
Zekering (15A) Laat het vervangen van de zekering over aan uw dichtstbijzijnde Panasonic service-centrum. Probeer in geen geval zelf de zekering te vervangen.

(Orange)/(Orange)/(Orange)/(Oranje)

External Mute Lead
 To the Navi Mute lead of the Panasonic car navigation system or car telephone mute lead.

Externe-Stummschaltungskabel
 An das Navigationssystem-Stummschaltungskabel des Panasonic Navigationssystems oder an das Autotelefon-Stummschaltungskabel.

Fil de Mise en sourdine extérieure
 A raccorder au fil Navi Mute du système de navigation automobile de Panasonic ou au fil de mise en sourdine du téléphone pour véhicule.

Externe-geuldempingsdraad
 Naar de Navi Mute draad van een Panasonic auto-navigatiesysteem of naar de dempingsdraad voor de autotelefoon.

C1 :

(Brown w/white stripe)/(Braun mit weißem Streifen)/(Brun à rayures blanches)/(Bruin met witte streep)

C2 :
Dual CD Changer Control Lead
 The dual CD changer control lead of a dual CD changer selector (ex. CA-CD55EN) should be connected.
Kabel für Doppelwechsler-Steuerung
 Hier das Kabel für eine Doppelwechsler-Steuerung (z.B. CA-CD55EN) anschließen.

Fil de commande de double changeur de disque CD Le fil de commande d'un double changeur de disque CD d'un sélecteur de double changeur de disque CD (par expl. CA-CD55EN) doit être connecté.
Stuurdraad tweevoudige CD-wisselaar
 Sluit de tweevoudige CD-wisselaar stuurdraad van een tweevoudige CD-wisselaar keuzeschakelaar (bijv. CA-CD55EN) aan.

C3 : (Brown w/black stripe)/(Braun mit schwarzem Streifen)/(Brun à rayures noires)/(Bruin met zwarte streep)

External Remote Control Lead
 When using a non-Panasonic external remote control, refer to the manufacturer for their product before connecting.

Leitungsdraht für externe Fernbedienung
 Wenn Sie eine externe Fernbedienung verwenden, die nicht von Panasonic hergestellt wurde, wenden Sie sich vor dem Anschluss an den Hersteller des Produktes.

Fil de la télécommande extérieure
 En cas d'utilisation d'une télécommande extérieure non-Panasonic, se référer aux conseils du fabricant concerné pour les connexions électriques.

Externe afstandsbedieningsdraad
 Bij gebruik van een externe afstandsbediening die niet van Panasonic is, dient u voor aansluiting de handleiding of de fabrikant van het product in kwestie te raadplegen.

C4 : (Blue w/white stripe)/(Blau mit weißem Streifen)/(Bleu à rayures blanches)/(Blauw met witte streep)

External Amplifier Control Power Lead To an external amplifier.

Stromversorgungskabel für externen Verstärker An einen externen Verstärker.
Fil d'alimentation de commande d'amplificateur externe A un amplificateur externe.
Stroomdraad externe versterker bediening Naar een externe versterker.

ISO Connector
ISO-Stecker
Connecteur ISO
ISO aansluiting

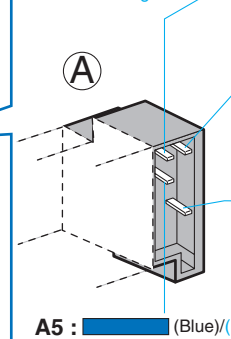

A7 : (Red)/(Rot)/(Rouge)/(Rood)

Power Lead (ACC or IGN) To ACC power, +12 V DC.
Versorgungskabel (ACC oder IGN) An die ACC-Stromklemme, +12 V Gleichspannung.
Fil d'alimentation (ACC ou IGN) A l'alimentation ACC, +12 V CC
Stroomdraad (ACC of IGN) Naar ACC stroomvoorziening, +12 V gelijkstroom.

A8 : (Black)/(Schwarz)/(Noir)/(Zwart)

Ground Lead To a clean, bare metallic part of the car chassis.
Massekabel An ein sauberes, metallisches Teil des Fahrzeugchassis.
Fil de mise à la masse A une partie métallique propre découverte du châssis de voiture
Aarding Naar een schoon, bloot metaal onderdeel van het chassis.

A4 : (Yellow)/(Gelb)/(Jaune)/(Geel)

Battery Lead To the car battery, continuous +12 V DC.
Batteriekabel An die Batterie des Fahrzeuges, kontinuierlich +12 V Gleichspannung.
Fil de batterie A la batterie de voiture, alimentation continue de +12 V CC
Accudraad Naar de accu van de auto, doorlopende stroomvoorziening +12 V gelijkstroom.

A5 : (Blue)/(Blau)/(Bleu)/(Blauw)

Motor Antenna Relay Control Lead

To Motor Antenna. (Max. 500 mA)
 (This lead is not intended for use with a switch actuated power antenna)
Steuerkabel für Relais der motorbetriebenen Antenne
 Zu motorbetriebenen Antenne (max. 500 mA)
 (Dieses Kabel dient nicht für die Verwendung mit einer über einen Schalter aktivierten motorbetriebenen Antenne.)
Fil de commande de relais d'antenne motorisée
 A l'antenne motorisée (500 mA maxi.)
 (Ce fil n'est pas conçu pour l'usage avec l'antenne commandée par interrupteur.)
Stuurdraad relais gemotoriseerde antenne
 Naar de gemotoriseerde antenne. (Max. 500 mA)
 (Deze draad is niet bedoeld voor een gemotoriseerde antenne die met een schakelaar wordt ingeschakeld.)

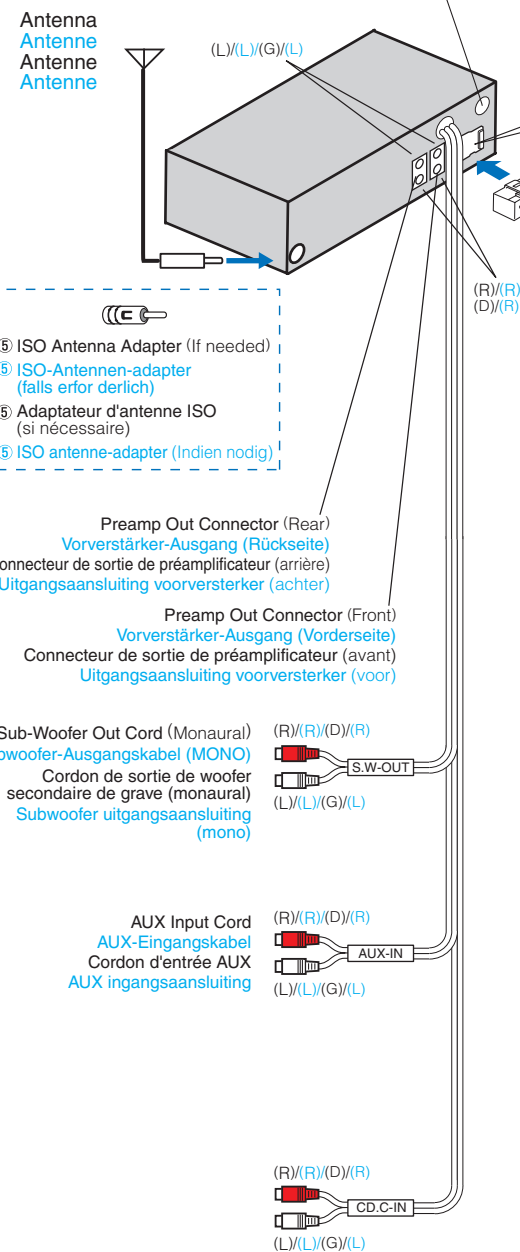

CD Changer Input Connector
 The RCA cord of a CD changer (ex. CX-DP880N) should be connected. The RCA cord of a dual CD changer selector (ex. CA-CD55EN) should be connected when the selector is incorporated into the system.
CD-Wechsler-Eingangssteckverbinder
 Hier das RCA-Kabel eines CD-Wechslers (z.B. CX-DP880N) anschließen. Hier das RCA-Kabel einer Doppelwechsler-Steuerung (z.B. CA-CD55EN) anschließen, wenn eine solche im System vorhanden ist.
Connecteur d'entrée de changeur de disque CD
 Le cordon RCA d'un sélecteur de changeur de disque CD (expl. CX-DP880N) doit être raccordé. Le cordon RCA d'un sélecteur de double changeur de disque CD (par expl. CA-CD55EN) doit être connecté lorsque le sélecteur est incorporé le système.
Ingangs aansluiting CD-wisselaar
 Sluit het RCA (tulpestekker) snoer van de CD-wisselaar (bijv. CX-DP880N) aan.
Sluit het RCA (tulpstekker) snoer van een tweevoudige CD-wisselaar keuzeschakelaar (bijv. CA-CD55EN) aan wanneer de keuzeschakelaar deel uitmaakt van uw systeem.

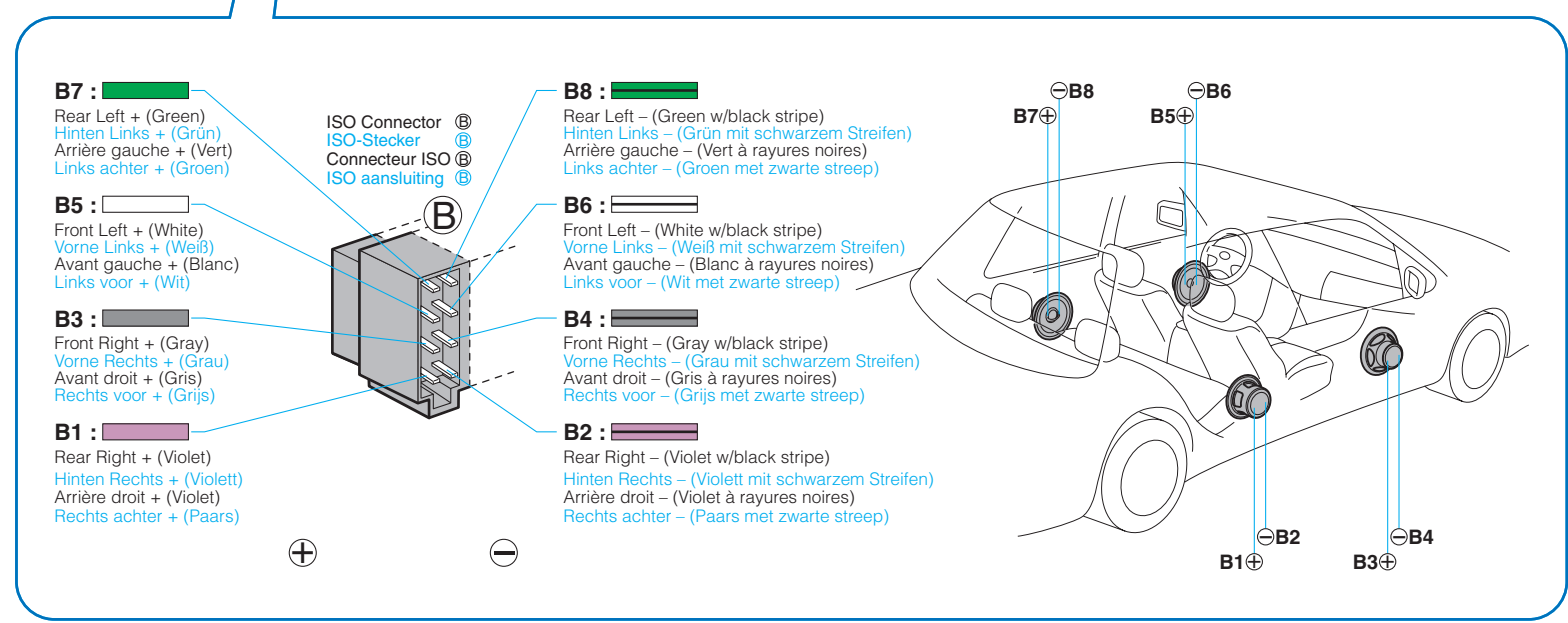
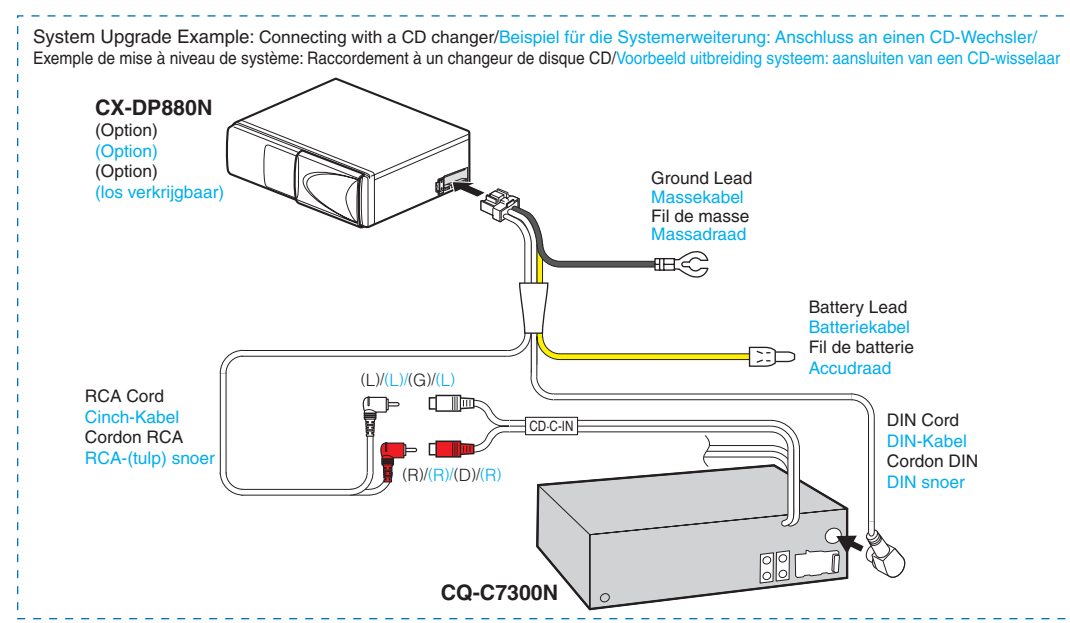

Power connector/Versorgungsstecker/Connecteur d'alimentation/Stroomstekker

Standard ISO/ISO-Standard/Normes ISO/Standaard ISO

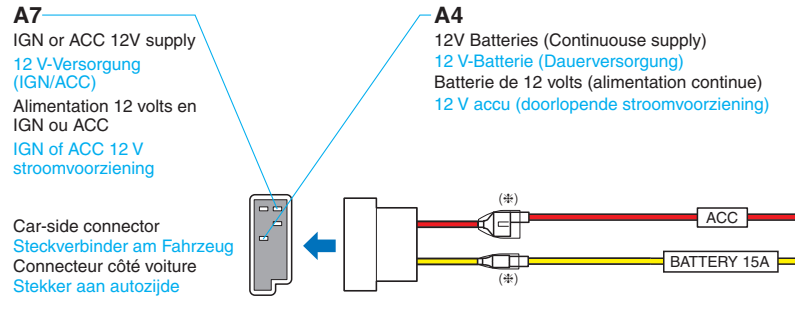

Car Type A/Kraftfahrzeug des Typs A/Type de voiture A/Autotype A

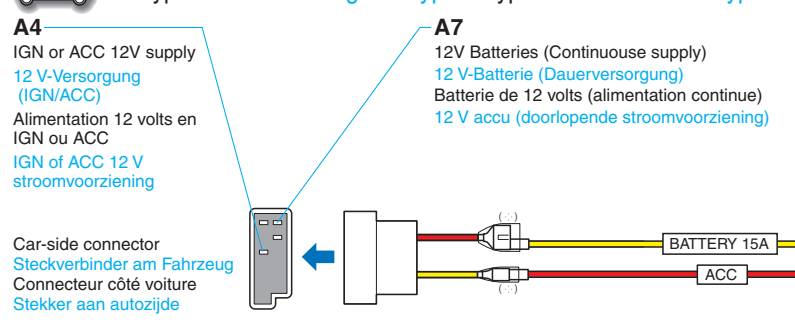

Car Type B/Kraftfahrzeug des Typs B/Type de voiture B/Autotype B

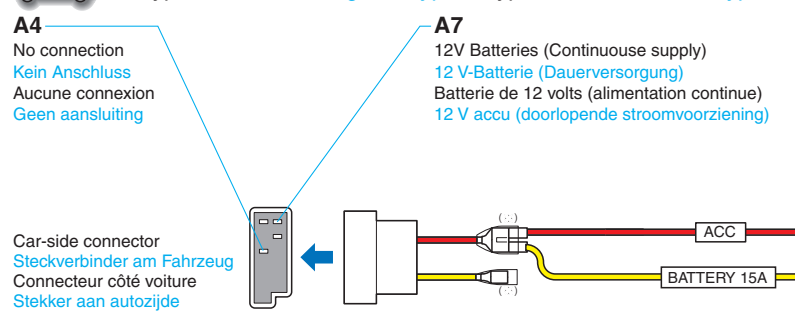

Precautions (ISO Connector)

- The pin arrangement of the power connector conforms to ISO standard.
- Please check that the pin arrangement of the connector in your car conforms to ISO standard.
- For car types A and B, change the wiring of the red and yellow leads as shown at below.
- After connection, insulate the portions marked (#) with insulating tape.

Vorsichtsmaßnahmen (ISO-Stecker)

- Die Stiftbelegung des Versorgungssteckers entspricht dem ISO-Standard.
- Bitte stellen Sie sicher, dass die Stiftbelegung des Steckers in Ihrem Fahrzeug dem ISO-Standard entspricht.
- Für Fahrzeuge der Typen A und B, ändern Sie die Verdrahtung der roten und gelben Leiter gemäß Abbildung.
- Nach dem Anschluss isolieren Sie die mit (#) markierten Abschnitte mit Isolierband.

Hinweis: Für andere Fahrzeuge als Typ A und B, wenden Sie sich bitte an eine örtliche Pkw-Werkstatt.

Précautions (Connecteur ISO)

- La disposition des broches du connecteur d'alimentation est conforme à la norme ISO.
- Veillez vérifier si la disposition des broches du connecteur d'alimentation dans votre voiture est conforme à la norme ISO.
- Pour les types de voiture A et B, changer le câblage des fils rouge et jaune comme indiqué ci-dessous.
- Après avoir fait les connexions, isoler les sections marquées (#) avec de la bande isolante.

Remarque: Pour les voitures autres que des types A et B, veuillez consulter votre magasin de matériel automobile local.

Voorzorgen (ISO stekker)

- De pin-configuratie van de stroomstekker voldoet aan de ISO standaard.
- Controleer of de pin-configuratie van de stekker in uw auto eveneens voldoet aan de ISO standaard.
- Voor auto's van type A en B, dient u de bedrading voor de rode en gele draden te wijzigen zoals hieronder staat aangegeven.
- Na het aansluiten dient u de gedeeltes die met (#) gemarkeerd zijn met isolatieband af te plakken.

Speaker Connection/Anschluss der Lautsprecher/Branchement avec les haut-parleurs/Aansluiten van de luidsprekers

Connect as follows.
 Nehmen Sie den Anschluss wie folgt vor.
 Branchez les haut-parleurs comme suit.
 Sluit de luidsprekers als volgt aan.

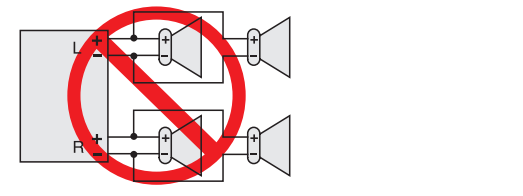
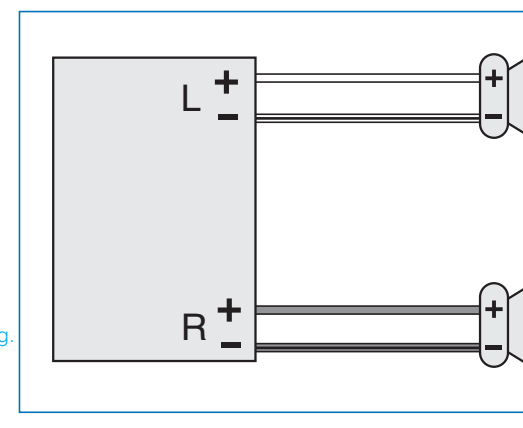

- Use ungrounded speakers only. Allowable input: 50W or more. Impedance: 4 - 8 Ω
- Distance between speaker and amplifier: 30 cm or more
- Verwenden Sie nicht geerdete Lautsprecher. Zulässige Belastbarkeit: 50 W oder mehr. Impedanz: 4 - 8 Ω
- Verwendet Sie nicht geerdete Lautsprecher. Zulässige Belastbarkeit: 50 W oder mehr. Impedanz: 4 - 8 Ω
- Distance entre le haut-parleur et l'amplificateur: 30 cm ou davantage
- Utilisez uniquement des haut-parleurs non reliés à la masse. Puissance d'entrée admissible: 50 W ou davantage. Impédance: 4 - 8 Ω
- Distance entre le haut-parleur et l'amplificateur: 30 cm ou davantage
- Gebruik uitsluitend ongeaarde luidsprekers. Toegestaan ingangsvormogen: 50 W of hoger. Impedantie: 4 - 8 Ω
- Afstand tussen luidspreker en versterker: 30 cm of meer

- Do not connect more than one speaker to one set of speaker leads. (except for connecting to a tweeter)
- Do not use a 3-wire type speaker system having a common earth lead.

- Verwenden Sie niemals Lautsprechersysteme mit Dreierverkabelung, die einen gemeinsamen Erdungsleiter aufweist.
- Ne pas utiliser pas de système de haut-parleur de type à 3 fils ayant un fil de mise à la masse commun.
- Gebruik geen luidsprekersysteem met drie draden en een gedeelde aarddraad.

Free Manuals Download Website

<http://myh66.com>

<http://usermanuals.us>

<http://www.somanuals.com>

<http://www.4manuals.cc>

<http://www.manual-lib.com>

<http://www.404manual.com>

<http://www.luxmanual.com>

<http://aubethermostatmanual.com>

Golf course search by state

<http://golfingnear.com>

Email search by domain

<http://emailbydomain.com>

Auto manuals search

<http://auto.somanuals.com>

TV manuals search

<http://tv.somanuals.com>