

Panasonic

MP3 CD Player/Receiver with CD Changer Control



CQ-RDP472N Operating Instructions

Bedienungsanleitung
Manuel d'instructions
Gebruiksaanwijzing
Bruksanvisning
Manuale di istruzioni
Manual de Instrucciones

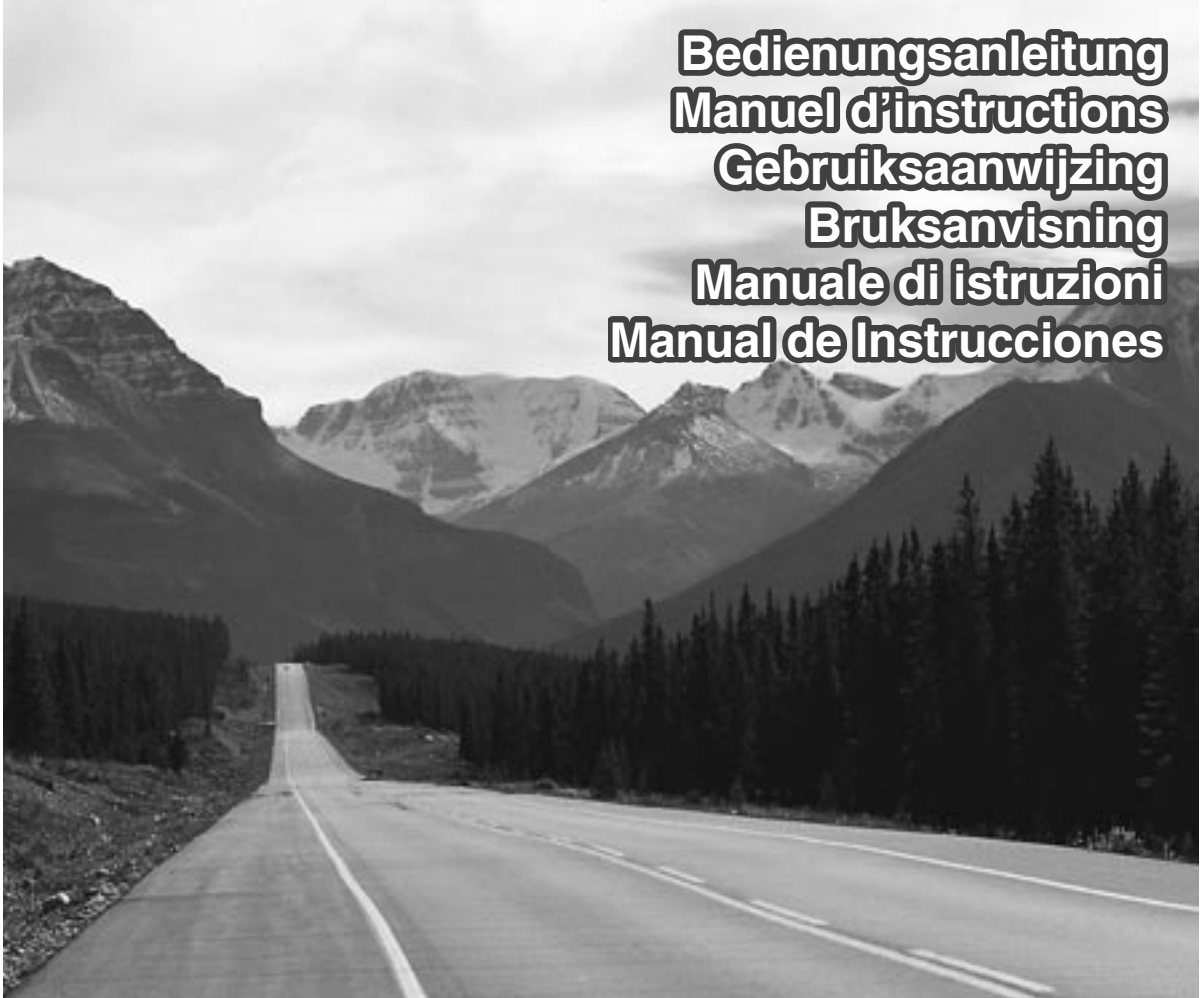

MP3



- Please read these instructions carefully before using this product and keep this manual for future reference.
- Bitte lesen Sie diese Bedienungsanleitung vor der Verwendung dieses Produktes aufmerksam durch und bewahren Sie sie danach für spätere Nachschlagzwecke sorgfältig auf.
- Prière de lire ces instructions attentivement avant d'utiliser le produit et garder ce manuel pour l'utilisation ultérieure.
- Leest u deze instructie alstublieft zorgvuldig door voor u dit product in gebruik neemt en bewaar deze handleiding voor later gebruik.
- Läs igenom denna bruksanvisning noga innan produkten tas i bruk. Spara bruksanvisningen för framtida behov.
- Si prega di leggere attentamente queste istruzioni prima di usare questo prodotto e di conservare questo manuale per usi futuri.
- Lea con atención estas instrucciones antes de utilizar el producto y guarde este manual para poderlo consultar en el futuro.

Label Indications and Their Locations
Warnetiketten und deren Anbringensort
Indications portées les étiquettes et emplacement
Aanduiding van de labels en hun plaats
Varningsskyltarna, och deras placering
Indicazioni delle etichette e le loro posizioni
Indicaciones de las etiquetas y su ubicación

VORSICHT!

UNSICHTBARE LASERSTRAHLUNG!
 WENN ABDECKUNG GEÖFFNET IST, NICHT
 DEM LASERSTRAHL AUSSETZEN.

- APPAREIL À LASER DE CLASSE 1
- KLASS 1 LASER APPARAT
- LUOKAN 1 LASERPLAITE

**CLASS 1
 LASER PRODUCT**

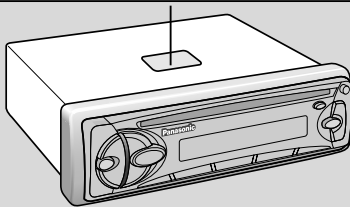

- Caution Mark
- Warnzeichen
- Marque d'avertissement
- Waarschuwingsteken
- Varningsmärke
- Etichetta di avvertimento
- Marka de advertencia

DANGER! Invisible laser radiation when open. Avoid direct exposure to beam.

ADVARSEL! Usynligt laserlys udstråles ved åbning. Undgå direkte bestråling.

VARO! Avattaessa ja suojalukitus ohitettaessa olet alttiina näkymättömälle lasersäteilylle. Älä katso säteeseen.

WARNING! Osynlig laserstrålning när denna del är öppnad och spårren är urkopplad. Betrakta ej strålen.

ADVERSEL! Usynlig laserstrålning når deksel åpnes og sikkerhedslås brytes. Unngå eksponering for strålen.

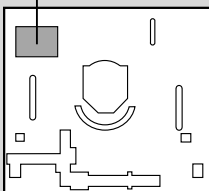

- Deck Ass'y (Upper Side)
- Geräteansicht (Oberseite)
- Assemblage de la table lecture (Côté supérieur)
- Dekkbevestig (Bovenkant)
- Däcksenhät (Topp)
- Gruppo della piastra (Lato superiore)
- Conjunto de la platina (Lado superior)

Contents

Page

Precautions	4
Laser Products	4
Components	4
Remote Control Unit Preparation	5
Power and Audio Controls	6
Radio Basics	8

Inhaltsverzeichnis

Seite

Vorsichtsmaßnahmen	36
Laserprodukte	36
Komponenten	36
Vorbereitung der Fernbedienung	37
Stromversorgung und Klangregler	38
Rundfunkempfang	40

Table des matières

Page

Mesures de précaution	68
Appareils à laser	68
Éléments constitutifs	68
Préparation de la télécommande	69
Commandes alimentation et audio	70
Utilisation de base du récepteur radio	72

Inhoudsopgave

Bladzijde

Voorzorgen	100
Laserproducten	100
Componenten	100
Vorbereiden van de afstandsbediening	101
Stroom en audio bedieningsorganen	102
Basisbediening radio	104

Innehåll

Sida

Observera	132
Om laserprodukter	132
Medföljande delar	132
Förberedelse av fjärrkontrollen	133
Strömpå/avslag och styrning av ljudåtergivning	134
Grundläggande manövrering av radion	136

Contenuto

Pag.

Precauzioni	164
Prodotto laser	164
Componenti	164
Preparazione del telecomando	165
Comandi di alimentazione e del suono	166
Funzionamento della radio	168

Indice

Pag.

Precauciones	196
Productos de láser	196
Componentes	196
Preparación de la unidad de control remoto	197
Alimentación y controles de audio	198
Operación básica de la radio	200

Radio Data System (RDS)	10	Electrical Connections	26
Clock Set	13	Speaker Connections	28
CD / MP3 Player	14	Fuse	28
CD Changer Control	20	Maintenance	29
Installation	22	Troubleshooting	30
Anti-Theft System	25	Specifications	35

Radio-Daten-System (RDS)-Empfang	42	Elektrischer Anschluß	58
Uhrzeit (CT)	45	Anschluß der Lautsprecher	60
CD / MP3-Spieler	46	Sicherung	60
Steuerung des CD-Wechslers	52	Pflege	61
Einbau	54	Störungsbeseitigung	62
Diebstahlschutz	57	Technische Daten	67

Réception radio RDS (Radio Data System)	74	Branchements électriques	90
Réglage de l'horloge	77	Branchement des haut-parleurs	92
Lecteur de CD / MP3	78	Fusible	92
Commande de changeur de CD	84	Entretien	93
Installation	86	En cas de difficulté	94
Système antivol	89	Données techniques	99

RDS (Radio Data System)	106	Elektrische aansluitingen	122
Gelijk zetten van de klok	109	Aansluitingen luidsprekers	124
CD-/MP3-speler	110	Zekering	124
Bediening van de CD-wisselaar	116	Onderhoud	125
Installatie	118	Verhelpen van storingen	126
Anti-diefstal systeem	121	Technische gegevens	131

RDS-mottagning (datastyrd radiomottagning)	138	Elektriska anslutningar	154
Tidsinställning	141	Anslutning av högtalare	156
CD-/MP3-spelare	142	Säkring	156
CD-växlarstyrning	148	Underhåll	157
Montering	150	Felsökning	158
Stöldskyddsanordning	153	Tekniska data	163

Ricezione RDS (Radio Data System)	170	Collegamenti elettrici	186
Regolazione dell'orologio	173	Collegamenti degli altoparlanti	188
Lettore CD / MP3	174	Fusibile	188
Controllo del cambia CD	180	Manutenzione	189
Installazione	182	Correzione dei difetti di funzionamento	190
Sistema antifurto	185	Dati tecnici	195

Recepción RDS (sistema de datos radiofónicos)	202	Conexiones de los altavoces	220
Ajuste de la hora	205	Fusible	220
Reproductor de CD / MP3	206	Mantenimiento	221
Control del cambiador de discos CD	212	Solución de problemas	222
Instalación	214	Especificaciones	227
Sistema antirrobo	217		
Conexiones eléctricas	218		

Panasonic welcomes you to their constantly growing family of electronic products owners. We endeavor to give you the advantages of precise electronic and mechanical engineering, manufactured with carefully selected components, and assembled by people who are proud of the reputation their work has built for our company. We know this product will bring you many hours of enjoyment, and after you discover the quality, value and reliability we have built into it, you too will be proud to be a member of our family.

Precautions

Volume Level

For your driving safety, keep the volume level low enough to be aware of road and traffic conditions.

Car Washing

To avoid electrical shorts which may cause fire, or other damage, do not expose this product (including the speakers and CDs) to water or excessive moisture.

Car Ventilation

If your car is parked for several hours in direct sunlight, the temperature inside the car may become very high. It is advisable to drive the car and give the interior a chance to cool down before switching the unit on.

Power Supply

This product is designed to be used in a car having a 12-volt negative ground battery system.

Disc Mechanism

Do not insert coins or any small objects. Keep screwdrivers and other metallic objects away from the disc mechanism and disc.

Service

This product is made of precision parts. Do not attempt to disassemble or adjust any parts. For repair, please consult your nearest authorized Panasonic Service Center.

Note: The preset memory is cleared to return to the original factory setting when the power connector or battery is disconnected.

Laser Products

Caution: This product utilizes a laser. Use of controls or adjustments or performance of procedures other than those specified herein may result in hazardous radiation exposure.

Laser products:

Wave Length 780 nm
Laser Power No hazardous radiation is emitted with safety protection.

Do not take apart this unit or attempt to make any changes yourself.

This unit is a very intricate device that uses a laser pickup to retrieve information from the surface of compact discs. The laser is carefully shielded so that its rays remain inside the cabinet.

Therefore, never try to disassemble the player or alter any of its parts since you may be exposed to laser rays and dangerous voltages.

Components

- Operating Instructions.....1
- Supplied Hardware.....1 set (➔ Page 22)
- Remote Control Unit.....1
- Lithium Battery (CR2025)1
- Warranty Card1

Remote Control Unit Preparation

Battery Installation

- ❶ Remove the battery holder.
Pull the holder out at position B while pushing position A as indicated.
- ❷ Install the battery on the battery holder.
Place the battery in the holder with its (+) side upwards as shown.
- ❸ Insert the battery holder.
Push in the battery holder back into its original position.

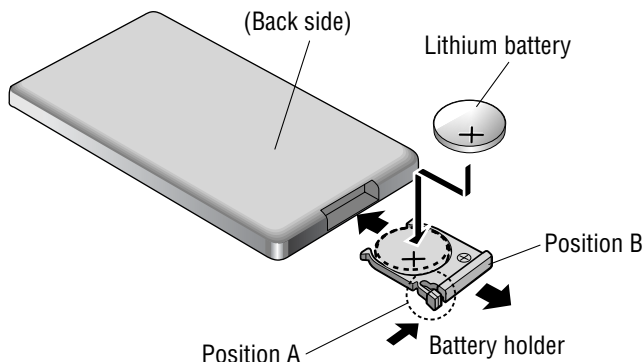

Battery Notes

Remove and dispose of an old battery immediately.

Battery Information:

- Battery Type: Panasonic lithium battery (CR2025) (Included)
- Battery Life: Approximately 6 months under normal use (at room temperature)

Caution: Improper use of batteries may cause overheating, an explosion or ignition, resulting in injury or a fire. Battery leakage may damage the unit.

- Do not disassemble or short the battery. Do not throw a battery into a fire.
- Keep batteries away from children to avoid the risk of accidents.
- Be careful to the disposal rules when you dispose of batteries.

Remote Controls

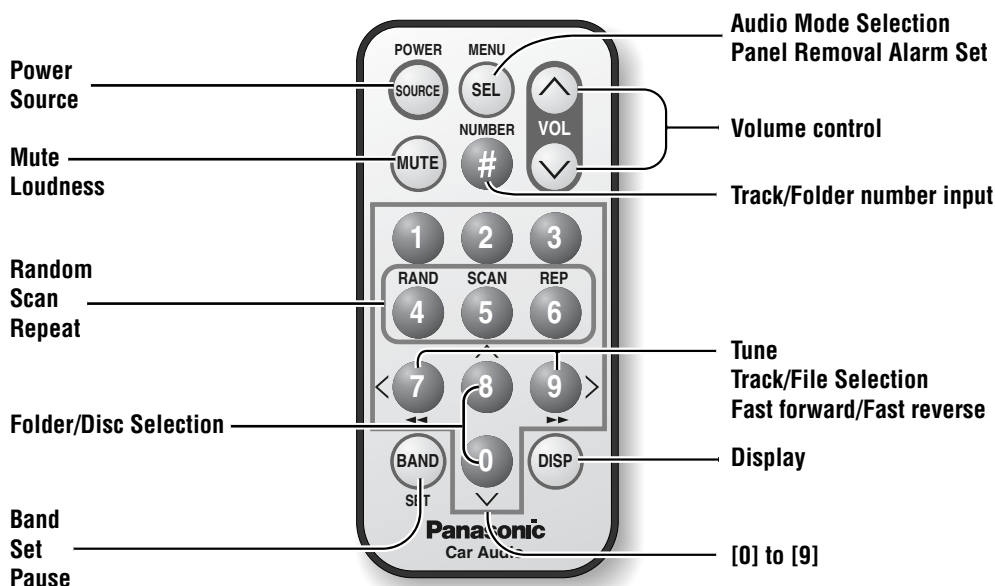

Power and Audio Controls

Power

Turn your car's ignition key to ACC or ON position.

Power on : Press **[SOURCE] (PWR)**.

Power off : Press **[SOURCE] (PWR)** again and hold.
The panel removal alarm sounds. (➔ Page 25).

Note: When the power is switched on for the first time, a demonstration message appears on the display. **To cancel this display, press [DISP].**

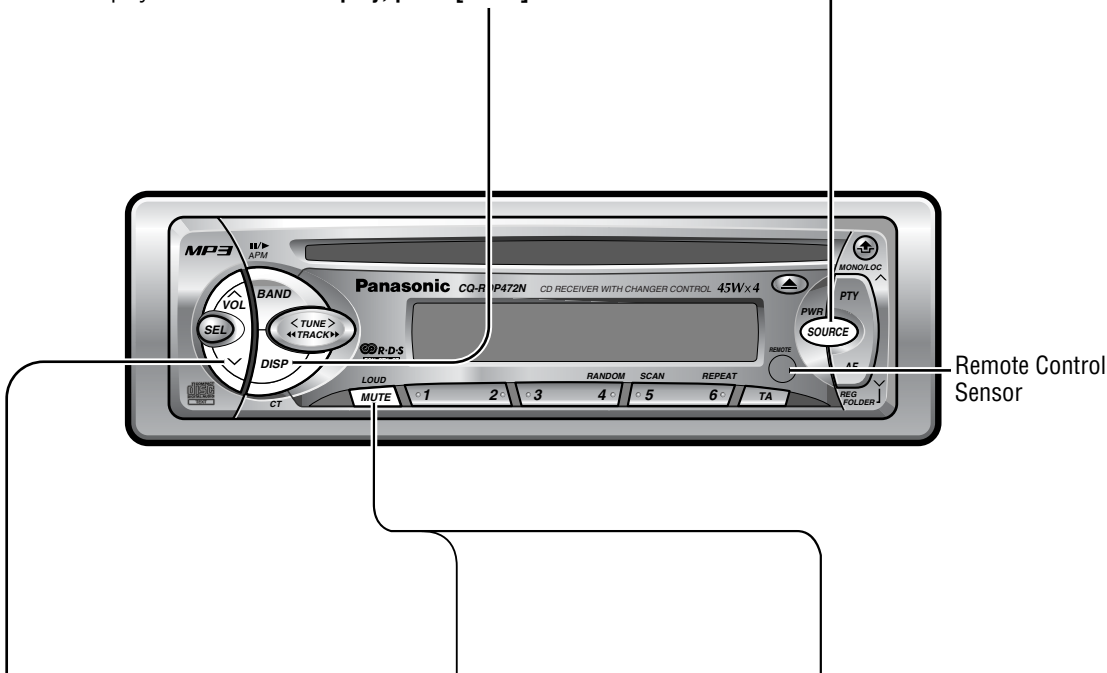

Volume

[▲VOL] : Up

[▼VOL] : Down

Press and hold for rapid adjustment.



Volume Level
(0 to 40)

Mute

Press **[MUTE]** to mute the sound completely.

Press **[MUTE]** again to cancel.



Loudness

Press and hold **[MUTE] (LOUD)** for more than 2 seconds to enhance bass and treble tones at low or medium volume.

Press and hold **[MUTE] (LOUD)** again to cancel.



Note: When the power is switched off and on again, the volume slowly rises to the previous level.

Mode Selection

Press [SOURCE] to change the mode.

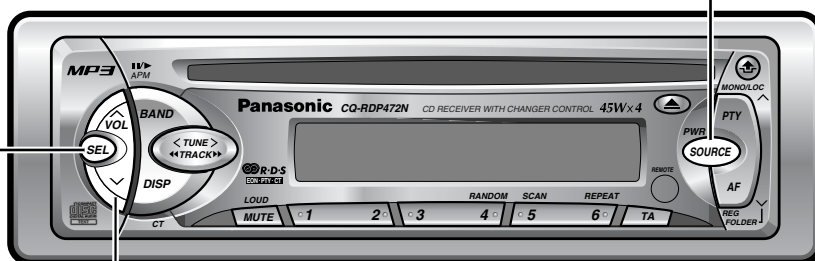
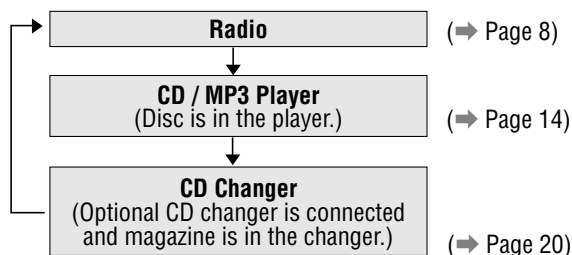

Audio Mode (Bass / Treble / Balance / Fader)

- 1 Press [SEL] to select the audio mode.
- 2 Press [▲VOL] or [▼VOL] to change each level.

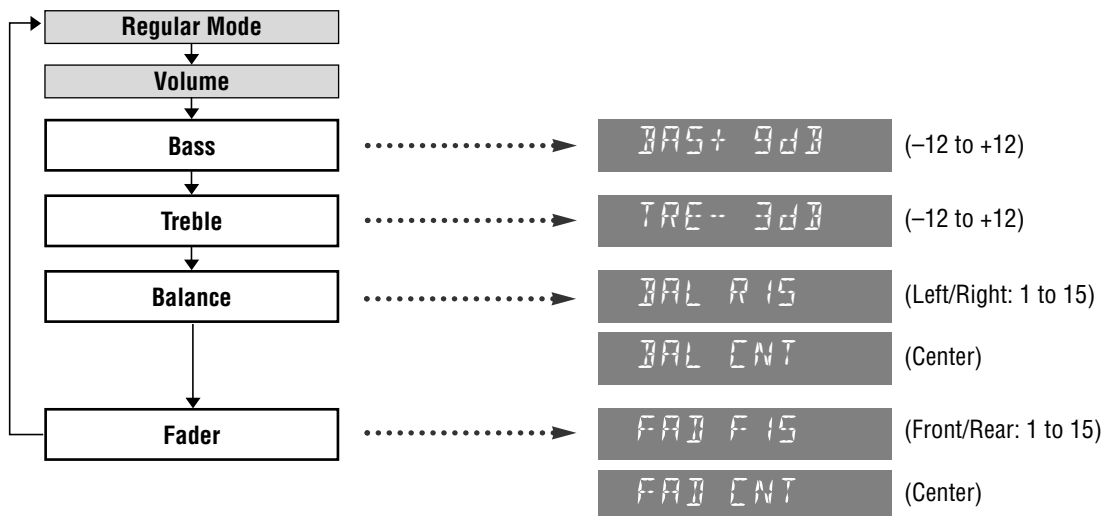

Note: If no operation takes place for more than 5 seconds in audio mode (2 seconds in Volume mode), the display return to regular mode.

Radio Basics

1 Mode Selection

Press [SOURCE] to select the radio mode.

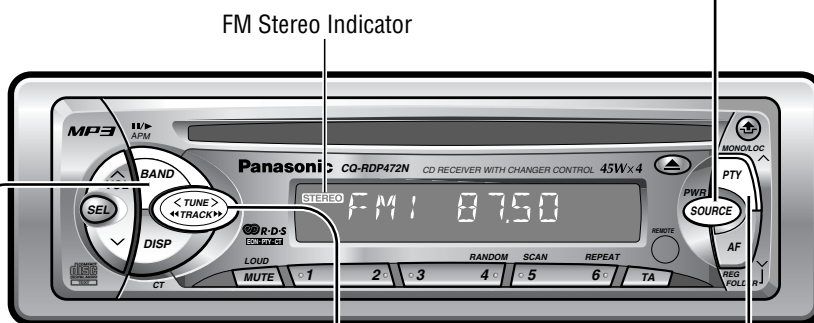

2 Band

Press [BAND] to change the bands.



Band

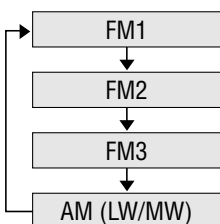

3 Manual Tuning

[>TUNE] : Higher frequency.
[<TUNE] : Lower frequency.

Seek Tuning

Press and hold [>TUNE] or [<TUNE] for more than 0.5 seconds, then release. Seeking will start.

4 Mono / Local Selection

MONO : Monaural reception. Select MONO to reduce noise when receiving a weak stereo broadcast.

LOCAL : Tunes in strong stations only.

FM broadcasts

Press and hold [PTY] (MONO/LOC) to change the mode. Release at the desired point.

AM broadcast

Press [PTY] (MONO/LOC) to switch LOCAL mode on and off.

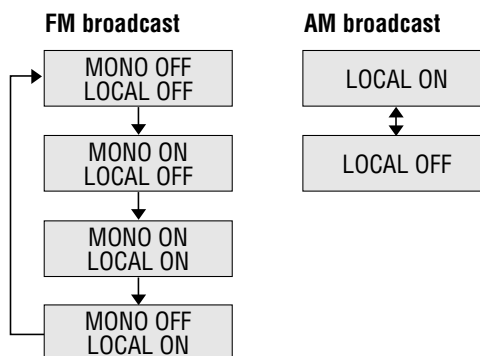

Preset Station Setting

Up to 6 stations each can be saved in the FM1, FM2, FM3 and AM (LW/MW) preset station memories.

Caution: To ensure safety, never attempt to preset stations while you are driving.

1 Band

Select a band. (⇒ Page 8)

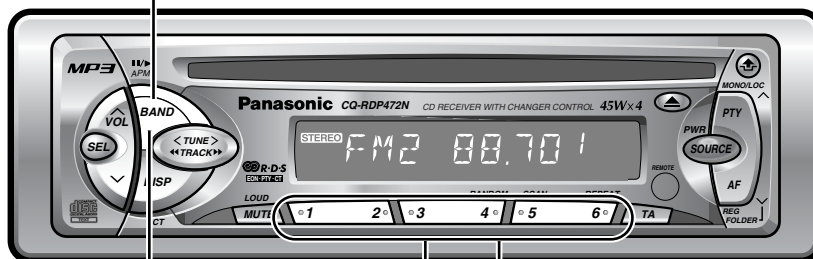

2 Auto Station Preset

Press and hold **[BAND] (APM)** (Auto Preset Memory) for more than 2 seconds.

- The 6 stations with good reception will be automatically saved in the memory under preset numbers **1** to **6**.
- Once set, the preset stations are sequentially scanned for 5 seconds each.

Notes:

- Only RDS stations will be saved at default setting (AF ON). To select non RDS stations too, set AF OFF. (⇒ Page 10)
- New stations are overwritten on existing saved stations after following this procedure.

Manual Station Preset

- 1 Use manual or seek tuning to find a station. (⇒ Page 8)
- 2 Press and hold one of the preset buttons from **[1]** to **[6]** until the display blinks once.



Preset Number

Tuning in to a Preset Station

Press the corresponding preset button from **[1]** to **[6]** to select a preset station.

Note: You can change the memory presetting by repeating the above procedure.

Radio Data System (RDS)

RDS Basics

The following functions are available when receiving RDS stations.

PS Display

(Program Service Name)

The name of station is displayed instead of the frequency.

CT Service

(Clock Time)

When receiving an RDS station, the CT (Clock Time) service automatically adjusts the time.

“NO CT” is displayed in areas where CT service is not available.

(→ Page 13 for Clock Set)

AF

(Alternative Frequency)

When reception is poor, an RDS station broadcasting the same program is tuned in automatically.

AF Mode

Press [AF] to select one of the following AF modes. **AF I**

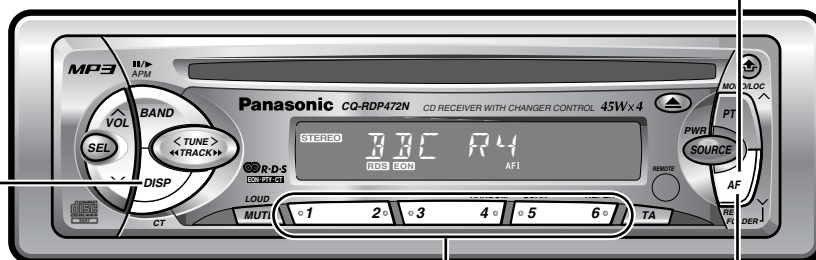
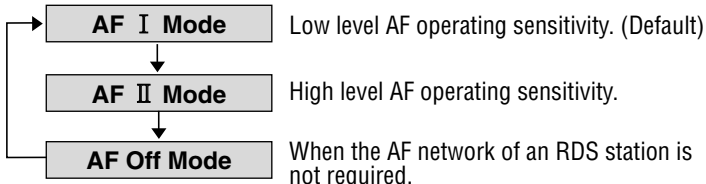

Display Change

Press [DISP] to change the display as follows.

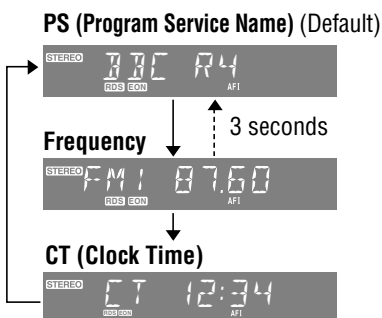

Preset Memory (AF mode on Setting)

Preset Station Calling (Best Station)

AF self-tuning selects a station with good reception when the preset tuning is activated.

For Poor Sound Quality (PI Seek)

If reception is poor when tuning in a preset station, press the same preset number button. The same station with better reception will be searched for.

Press the same preset number button again to cancel.

Note: When AF mode is on, only RDS stations will be memorized automatically. (→ Page 9)

REG (Region) Mode

Changes the selection range of AF and PI Seek.

Press and hold [AF] (REG) to switch on and off.



The frequency is changed only for programs within the region.



The frequency is changed also for programs outside the region.

RDS service availability varies with areas. Please understand if RDS service is not available in your area. This chapter explains the summary and operation regarding RDS.

Traffic Announcements (TA)

Some RDS FM stations periodically provide traffic information.

TP
(Traffic Program)
Broadcasting of traffic information.

TA
(Traffic Announcements)
Radio announcements on traffic conditions.

TA Mode

Press [TA] to switch TA mode on and off. **TA on**

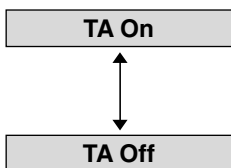

If the station received is not a TP station, the unit automatically searches for a TP station to tune in to. When the TP station received begins a traffic announcement, you can hear it from the unit.

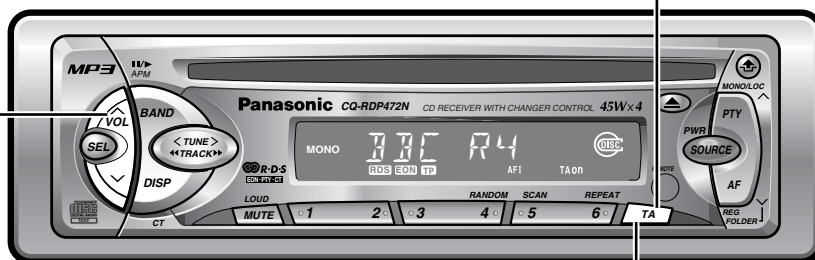

TA Volume Set

(Volume Level : 0 to 40)

Press [\wedge VOL] or [\vee VOL] while receiving traffic announcements. The TA volume differs from the regular volume (by up to 5 levels).

Muting in TA Mode

To listen only to traffic announcements while muting, press and hold [TA] for more than 2 seconds when TA is on. To cancel the muting TA on mode (muting in TA mode → TA mode), take either following two.

- Press [TA] again.
- Press [\wedge VOL] several times.

Note: To switch to TA off, press [TA] again.

TA Standby

When TA is on, CD / MP3 or CD changer will be interrupted by FM traffic announcements.

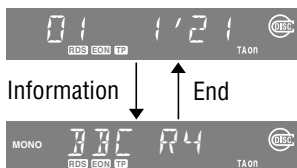

TP Auto Search

When reception of a TP station is poor, TP Auto Search will automatically search for a TP station with better reception.

Seek and Preset Station (TA on Setting)

- TP Seek Tuning:** Seek tunes only TP stations. (→ Page 8)
- Auto TP Station Preset:** The 6 strongest TP stations are saved in memory. (→ Page 9)
- Tuning in a TP Preset Station** (→ Page 9)

Radio Data System (RDS) (continued)

Program Type Reception (PTY)

RDS FM stations provide a program type identification signal.
Example: news, rock, classical music, etc.

PTY Mode

Press [PTY] to switch PTY display mode on or off.

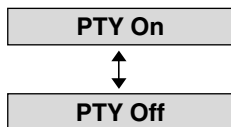

The PTY function described below becomes enabled after selecting to the PTY mode.

When there is no corresponding program type, "NO PTY" is displayed.

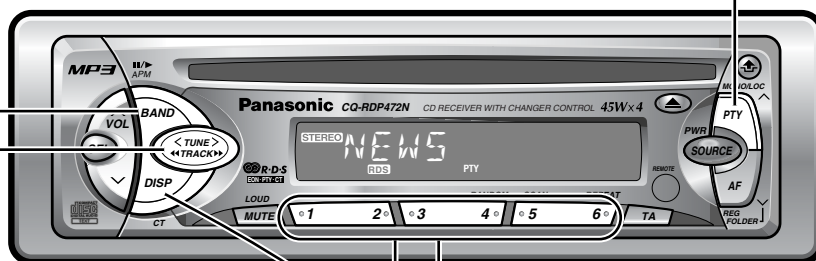

PTY Selection

1 Press [TUNE] to change the program type as follows. ([TUNE]: opposite direction)

SPEECH	→	MUSIC	→	NEWS	→	AFFAIRS	→
INFO	→	SPORT	→	EDUCATE	→	DRAMA	→
CULTURES	→	SCIENCE	→	VARIED	→	POP M	→
ROCK M	→	M_O_R_M	→	LIGHT M	→	CLASSICS	→
OTHER M	→	WEATHER	→	FINANCE	→	CHILDREN	→
SOCIAL A	→	RELIGION	→	PHONE IN	→	TRAVEL	→
LEISURE	→	JAZZ	→	COUNTRY	→	NATIONAL	→
OLDIES	→	FOLK M	→	DOCUMENT	→		

2 Select the desired program and press [BAND]. Seek will start to tune in to a station that broadcasting the selected program type.

PTY Search

1 Select a program type by pressing the preset button. The preset program type appears on the display for 5 seconds.

Example: Press preset button [1].



2 Press the same preset button again (or press [BAND]) to tune in the desired program type station.

Example: Press preset button [1] again.

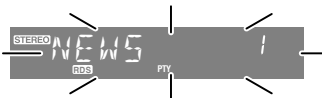

PTY display in Swedish

Press [DISP] to switch the PTY display language as follows.



PTY Preset Change

1 Select a program type by using PTY Selection or pressing PTY Preset buttons.



2 Press and hold one of the buttons from [1] to [6]. Example: Press and hold preset button [2].

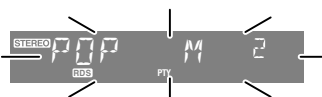

Clock Set

PTY Type Preset

Program types are stored in memory under preset buttons from [1] to [6] as shown in the table below.

To tune in the desired program type, press any of preset buttons from [1] to [6].

Preset No.	Program Type	Display	
1	News	NEWS 1	NEWS
2	Speech	SPEECH 2	AFFAIRS / INFO EDUCATE / DRAMA CULTURES / SCIENCE VARIED / WEATHER FINANCE / CHILDREN SOCIAL A / RELIGION PHONE IN / TRAVEL LEISURE / DOCUMENT
3	Sport	SPORT 3	SPORT
4	Pop. Music	POP M 4	POP.M
5	Classic Music	CLASSICS 5	CLASSICS
6	Other Music	MUSIC 6	ROCK M / M_O_R_M LIGHT M / OTHER M JAZZ / COUNTRY NATIONAL / OLDIES FOLK M

EON (Enhanced Other Networks)

When EON data is received, the EON indicator lights the TA and AF functions are expanded as follows.

TA : Traffic information from the current and other network stations can be received.

AF : The frequency list of preset RDS stations is updated by EON data.

EON enables the radio to make fuller use of RDS information. It constantly updates the AF list of preset stations, including that currently tuned in to. For example, if you preset a station far from home, you will later be able to receive the same station at an alternative frequency, or any other station serving the same program. EON also keeps track of locally available TP stations for quick reception.

Emergency Announcement Reception

When an emergency announcement is broadcast, the unit is automatically switched to receiving that broadcast. If this happens in a mode other than radio mode (CD / MP3 mode and CD changer mode) or in Muting in TA mode, "ALARM" blinks on the display.

When RDS CT service is not available, set the clock as follows. (24-hour system)

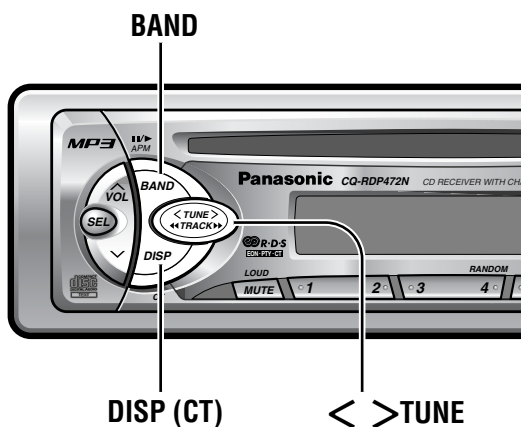

AM Mode

- Press [BAND] to change to AM mode.

AM 1305 (AM mode)

- Press [DISP] (CT).

NO CT (Clock display)

Hours

- Press and hold [DISP] (CT).

CT - 0:00 (Hour blinks)

- Press [>TUNE] or [<TUNE].

CT - 10:00 (Hour set)

Minutes

- Press [DISP] (CT).

CT 10:00 (Minute blinks)

- Press [>TUNE] or [<TUNE].

CT 10:35 (Minute set)

- Press [DISP] (CT).

CT 10:35 (End)

Note: Hold [>TUNE] or [<TUNE] to change numbers rapidly.

CD / MP3 Player

Disc Insert and Playback

Insert a disc.
The unit identifies CD-DA data or MP3 data, and plays it.

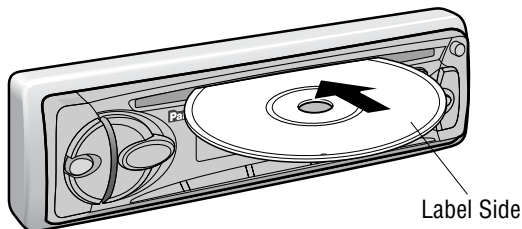

CD LOAD

(Disc loaded)

READING

(Data reading)

CD

CD

(Ordinary music CD recognized and playback starts)

MP3

MP3

(MP3 data recognized and playback starts → Page 16)

Notes:

- Do not insert a disc when this indicator lights  because a disc is already loaded.
- When a CD-R or CD-RW which has CD-DA formatted data is loaded, this unit recognizes it as an ordinary music CD.
- If you record many folders and MP3 files onto a disc, it may take up to a few minutes before playback starts.
- If a disc contains both CD-DA and MP3 data, only first-recorded data is played.

Stop and Disc Eject

Press [▲] to stop CD / MP3 play and eject the disc.



Note: The unit returns to the previous mode when the disc is ejected in the CD / MP3 player mode.

Cautions:

- Only 12 cm CD, CD-ROM, CD-R and CD-RW discs are available for this unit.
- Do not use irregular shaped discs.
- Do not use discs that have a seal or label attached.

Listening to a CD

(When a CD is in the player...)

Mode Selection

Press [SOURCE] to select the CD mode.

01 1'23

Track Selection

[▶▶TRACK]: Advance to the next track.

[◀◀TRACK]: Back to the beginning of the current track.
Back to the previous track. (Press twice)

Fast Forward / Fast Reverse

Press and hold

[▶▶TRACK]: Fast forward.

[◀◀TRACK]: Fast reverse.

Release to resume the playback.

Pause

Press [BAND] to pause.

Press [BAND] again to resume the playback.

PAUSE

Direct Track Selection

(Only for remote control)

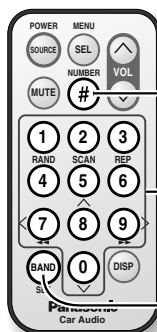

Example: Track number 12

1 Press [#] (NUMBER).

2 Press [1] [2].

3 Press [BAND] (SET).
The corresponding track starts playing.

Re-input the number: Press [#] (NUMBER).

Return to regular display: Press [DISP].

Note: Random, scan and repeat play are canceled when [#] is pressed.

Available Discs



Note: Refer to the section on “Points to remember when recording an MP3 disc” (→ Page 18) and “Notes on CD-Rs/RWs” (→ Page 29).

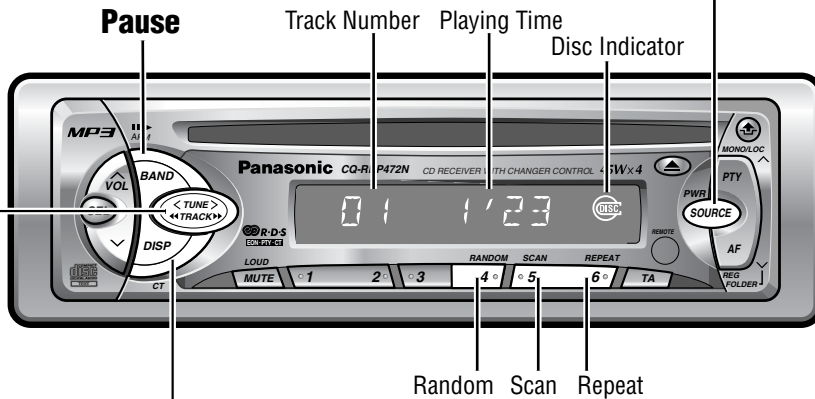

Display Change

Press [DISP] to change the display as follows.

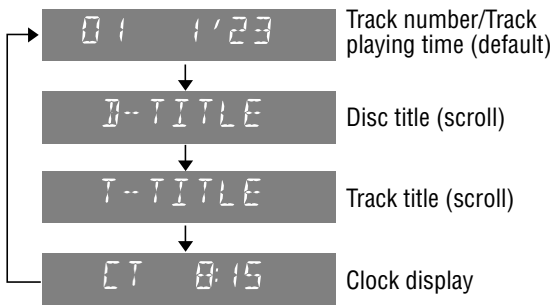

Disc / Track Title Scroll

Press and hold [DISP] or more than 2 seconds when track number/track playing time display or clock display is selected.

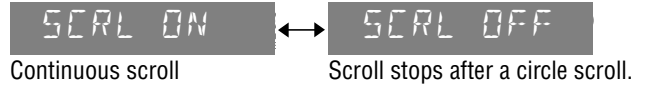

Notes:

- The display shows title information only when a disc which has CD text information is loaded. (Up to 30 letters can be displayed when scrolling. Some letters are not serviceable.)
- “NO TITLE” is displayed when there is no information on the disc.
- Do not watch the scroll display while driving.
- Press and hold [DISP] for more than 2 seconds to have another circle scroll when set to scroll off.

<p>Random Play</p>	<p>Press [4] (RANDOM). Press again to cancel.</p>	
<p>Scan Play First 10 sec. of each track</p>	<p>Press [5] (SCAN). Press again to cancel.</p>	
<p>Repeat Play</p>	<p>Press [6] (REPEAT). Press again to cancel.</p>	

CD / MP3 Player (continued)

Folder Selection Order / MP3 File Playback Order

Example:

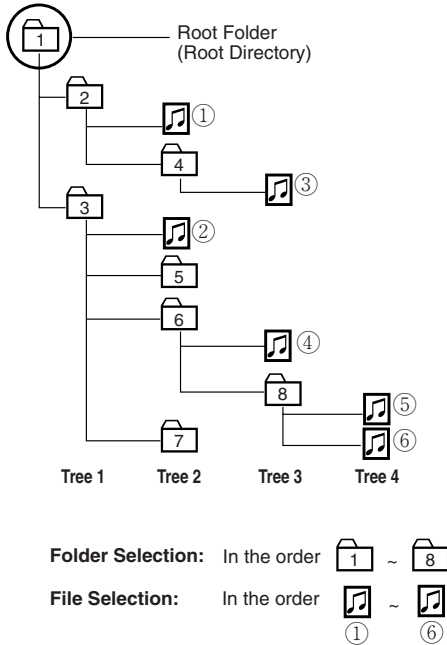

Notes:

- This unit counts the number of folders irrespective of the presence or absence of MP3 file.
- If the selected folder does not contain any MP3 files, the nearest MP3 files in the order of playback will be played.
- Playback order may be different from other MP3 players even if the same disc is used.

Listening to a MP3

(When an MP3 disc is in the player...)

Mode Selection

Press [SOURCE] to select the MP3 mode.



Folder Selection

[^] : Next folder.
[v] : Previous folder.

File Selection

[▶▶TRACK] : Advance to the next file.
[◀◀TRACK] : Back to the beginning of the current file.
Back to the previous file. (Press twice)

Fast Forward / Fast Reverse

Press and hold
[▶▶TRACK] : Fast forward.
[◀◀TRACK] : Fast reverse.
Release to resume the playback.

Pause

Press [BAND] to pause.
Press [BAND] again to resume the playback.



Direct Folder Selection

(Only for remote control)

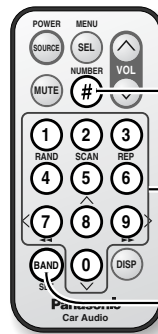

Example: Folder number 5

- 1 Press [#] (NUMBER).
- 2 Press [5].
- 3 Press [BAND] (SET).
The corresponding folder starts playing.

Re-input the number: Press [#] (NUMBER).

Return to regular display: Press [DISP].

Notes:

- If there is no file in the specified folder, error message "CD -E4-" appears. Select another folder which contains MP3 files.
- Random, scan and repeat play are canceled when [#] is pressed.

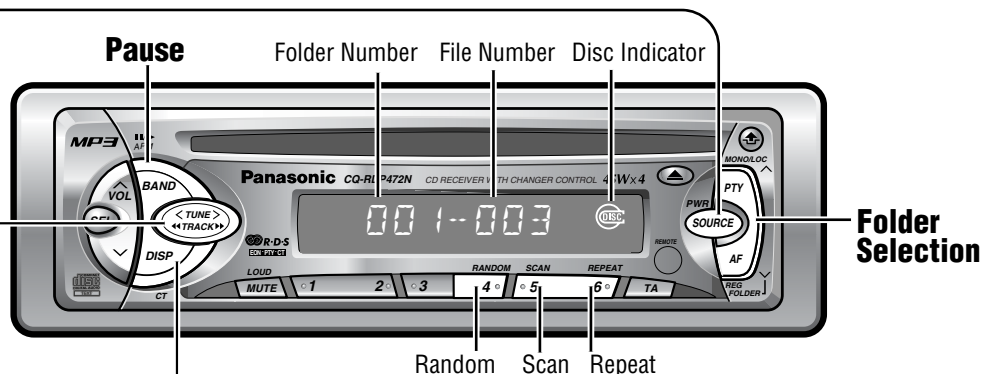

Display Change

Press [DISP] to change the display as follows.

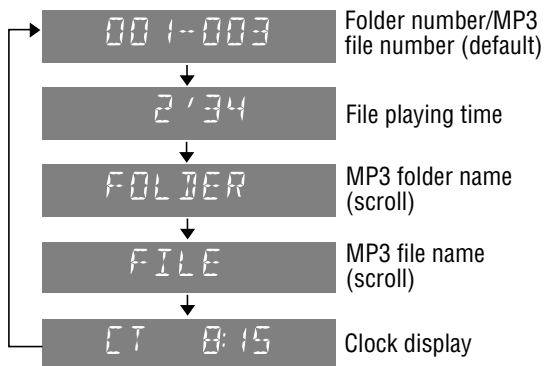

Folder / File Name Scroll

Press and hold [DISP] for more than 2 seconds when folder number/MP3 file number display, file playing time display or clock display is selected.

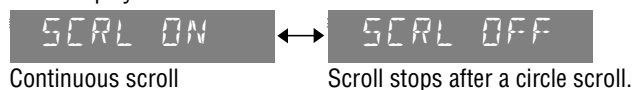

Notes:

- “NO TITLE” is displayed when there is no folder/file name.
- The “.mp3” file name extension is not displayed.
- “ROOT” appears when displaying the root folder’s folder name.
- Do not watch the scroll display while driving.
- Press and hold [DISP] for more than 2 seconds to have another circle scroll when set to scroll off.

Random Play	All Files	Press [4] (RANDOM). Press again to cancel.	003-006 Lights
	All files in the current folder	Press and hold [4] (RANDOM) for more than 2 seconds. Press and hold again to cancel.	001-010 Blinks
Scan Play First 10 sec. of each file	All Files	Press [5] (SCAN). Press again to cancel.	002-007 Blinks
	1st track in each folder	Press and hold [5] (SCAN) for more than 2 seconds. Press and hold again to cancel.	004-001 Blinks
Repeat Play	Current file	Press [6] (REPEAT). Press again to cancel.	001-003 Lights
	Current folder	Press and hold [6] (REPEAT) for more than 2 seconds. Press and hold again to cancel.	003-001 Blinks

CD / MP3 Player (continued)

Points to remember when recording an MP3 disc

This player allows you to play MP3 files recorded on CD-ROMs, CD-Rs (Recordable) and CD-RWs (Rewritable).

What is MP3

MP3, short for MPEG Audio Layer-3, is a standard for compressing digital audio data adopted for video CDs and similar media. It is one of the audio compression systems covered by MPEG's (Motion Picture Experts Group) digital audio compression standards. What it does is reduce the number of bytes in a song without detracting from the sound quality by eliminating big sound waves within the sound range that is imperceptible to the human ear. This compression allows you to reduce the contents of a conventional music CD by a factor of around 10. This means that you can record the contents of 10 music CDs on a single CD-R or CD-RW. (The figures refer to data recorded on a 650 MB CD-R or CD-RW at a fixed bit rate of 128 kbps and a sampling frequency of 44.1 kHz.)

■ Converting (encoding) audio data to an MP3 file

- It is recommended to set the bit rate to "128 kbps or more" and "Fixed".
- Bit rate 8 kbps of MPEG-2 and sampling frequency 16 kHz of MPEG-2 can not be reproduced.
- If set to VBR (Variable Bit Rate), the file playing time may not be displayed correctly.
- The playback sound quality differs depending on the encoding software and the bit rate. For details refer to the user manual of your encoding software.

■ Recording MP3 files on a CD-R/RW

- Do not record files other than MP3s or unnecessary folders on a disc. If many folders or files other than MP3s are recorded on a disc, it may take up to 150 seconds before playback starts, and you may have difficulties using fast forward and fast reverse.
- Use ISO 9660 file system (Extension of the ISO 9660 file systems are included.) APPLE HFS file system is not supported. If they do not conform to ISO 9660 file system, the file may not play normally, or the file or folder names may not be displayed correctly.
- Make sure to add the ".mp3" extension to each MP3 file name. A file with a different file name extension or none at all will not play.
- Although Multi session recording is supported, the use of Disc-at-Once is recommended. Make sure to close the session when you finished recording on a disc.
- ID3Tag character information is not displayed. A file in which character information was recorded by use of ID3Tag 2.0 or later version may not be reproduced normally. For example, the file playing time may not be displayed correctly.
- Packet writing software is not supported.
- A playlist function is not supported. Record files and folders in the order in which you want them to be played. Some writing software lets you specify the recording order by adding a prefix in the range of "01" - "99", etc. to the file name. For details refer to the user manual of your writing software.

Note: You may encounter trouble in playing MP3s or displaying the information of MP3 files recorded with certain writing softwares or CD recorders (CD-R/RW drives).

Caution: Never assign the ".mp3" file name extension to a file that is not in the MP3 format. This may not only produce noise from the speakers and speaker damage, but can damage your hearing.

Maximum number of files / folders

- Maximum number of trees: 8
- Maximum number of files / folders: 254 (files + folders. Root folder is not included.)

Note: If the total of files and folders exceeds 254, successful playback may not be performed.

Supported file systems and file names

Supported file system	Displayable folder names and file names								
ISO 9660 Level 1	<p>Name files and folders in accordance with the standard of each file system. Refer to the instructions of writing software for details.</p> <ul style="list-style-type: none"> • This player can display file names of up to 30 letters in scroll mode. * Up to 15 letters can be displayed when scrolling in the Joliet system. • The unit recognizes only ASCII character set and some of special characters. German special character (ß), French special characters (ç, é, è, ê, ë, î, ï, œ) etc. will be converted into an asterisk (*). <p>ASCII character set ASCII character set consisting of A to Z, a to z, digits 0 to 9, and the following symbols: (space) ! " # \$ % & ' () * + , - . / : ; < = > ? @ [\] ^ _ ` { } ~ (However, lowercase characters are represented as uppercase characters in this unit.)</p> <p>Special Characters</p> <table> <tr> <td></td> <td>À Á Â Ã Ä å á â ã ä</td> </tr> <tr> <td></td> <td>Ä ä</td> </tr> <tr> <td></td> <td>Ò Ó Ô Õ Ö ò ó ô õ ö</td> </tr> <tr> <td></td> <td>Ù Ú Û Ü ù ú û ü</td> </tr> </table>		À Á Â Ã Ä å á â ã ä		Ä ä		Ò Ó Ô Õ Ö ò ó ô õ ö		Ù Ú Û Ü ù ú û ü
		À Á Â Ã Ä å á â ã ä							
		Ä ä							
		Ò Ó Ô Õ Ö ò ó ô õ ö							
		Ù Ú Û Ü ù ú û ü							
ISO 9660 Level 2									
Joliet*									
Romeo									
Apple Extension to ISO 9660									

Glossary

ISO 9660

The most common international standard for the logical format for files and directories.

APPLE HFS

The file system used by the Macintosh operating system to organize data. **(Not supported)**

Multi-session

A method of adding data incrementally to a CD-R or CD-RW in more than one recording session.

Disc-at-Once

A method of writing data in a media by just one operation and no more writing after that.

ID3Tag

A function that allows character information (title, artist, album title, date, etc.) to be written onto the disc. **(Not displayed → Page 18).**

Packet writing

A method of writing data on a CD media in small increments. **(Not supported)**

Copyright

It is prohibited by copyright laws to copy, distribute and deliver copyrighted materials such as music without the approval of copyright holder except enjoying yourself personally.

Note: MP3 encode software and writing software are not supplied to this model.

CD Changer Control

CD changer functions are designed for optional Panasonic CD changer unit.
(→ Page 26 for connection)

Insert the Magazine

Playback starts.

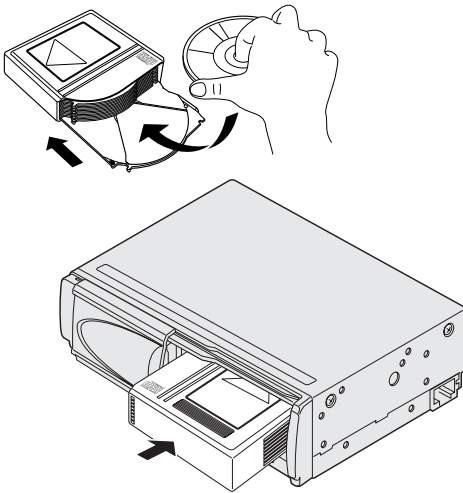

Example: CD Changer CX-DP88N (Option)

Notes:

- "CDC 0000" is displayed when no disc is loaded in the magazine.
- The unit returns to previous mode when the magazine is ejected in the CD changer mode.
- **CD text is not supported in the CD changer mode.** CD text can not be displayed even if a CD changer capable of recognizing CD text is connected. (CX-DP9061EN, for example.)

Listening to a CD Changer

(When the magazine is in the player...)

Mode Selection

Press [SOURCE] to select the CD changer mode.



Disc Selection

- [^] : Next disc.
- [v] : Previous disc.

Track Selection

- [▶▶TRACK] : Advance to the next track.
- [◀◀TRACK] : Back to beginning of the current track. Back to previous track. (Press twice)

Fast Forward / Fast Reverse

Press and hold

- [▶▶▶TRACK] : Fast forward.
 - [◀◀◀TRACK] : Fast reverse.
- Release to resume the playback.

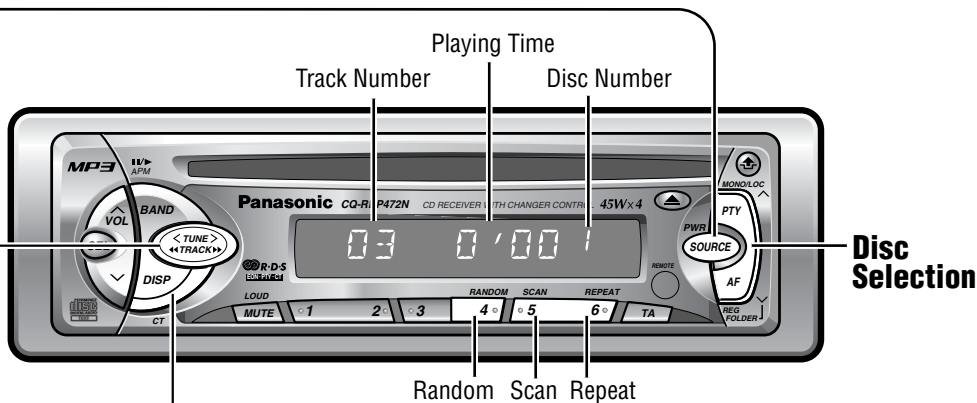

Display Change

Press **[DISP]** to switch the display as follows.

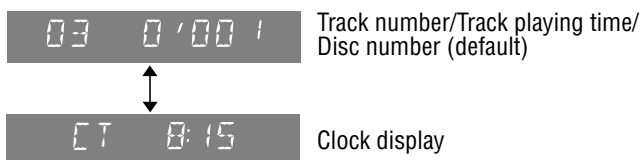

Random Play	All tracks	Press [4] (RANDOM) . Press again to cancel.	 Lights
	All tracks on the current disc	Press and hold [4] (RANDOM) for more than 2 seconds. Press and hold again to cancel.	 Blinks
Scan Play First 10 sec. of each track	All tracks	Press [5] (SCAN) . Press again to cancel.	 Blinks
	1st track on each disc	Press and hold [5] (SCAN) for more than 2 seconds. Press and hold again to cancel.	 Blinks
Repeat Play	Current track	Press [6] (REPEAT) . Press again to cancel.	 Lights
	Current disc	Press and hold [6] (REPEAT) for more than 2 seconds. Press and hold again to cancel.	 Blinks

Installation

Preparation

- Before installation, check the radio operation with antenna and speakers.
- Disconnect the cable from the negative (-) battery terminal (see caution below).
- Unit should be installed in a horizontal position with the front end up at a convenient angle, but not more than 30°.

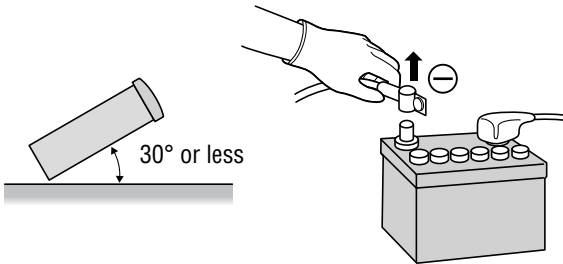

Caution: Do not disconnect the battery terminals of a car with trip or navigational computer since all user settings stored in memory will be lost. Instead take extra care with installing the unit to prevent shorts.

Dashboard Installation

Installation Opening

The unit can be installed in any dashboard having an opening as shown at right. The dashboard should be 4.5 mm - 6 mm thick in order to be able to support the unit.

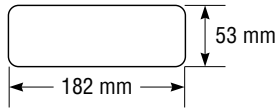

Installation Precautions

This product should be installed by a professional installer, if possible.

In case of difficulty, please consult your nearest authorized Panasonic Service Center.

1. This system is to be used only in a 12-volt, DC battery system (car) with negative ground.
2. Follow the electrical connections carefully (→ Page 26). Failure to do so may result in damage to the unit.
3. Connect the power lead (red) after all other connections are made.
4. Be sure to connect the battery lead (yellow) to the positive terminal (+) of the battery or fuse block (BAT) terminal.
5. Insulate all exposed wires to prevent short circuiting.
6. Secure all loose wires after installing the unit.
7. Please carefully read the operating and installation instructions of the respective equipment before connecting it to this unit.

Supplied Hardware

No.	Item	Diagram	Q'ty
①	Mounting Collar		1
②	Mounting Bolt (5 mmφ)		1
③	Power Connector		1
④	Removable Face Plate Case		1
⑤	Trim Plate		1
⑥	ISO Antenna Adapter		1

Methods for Fixing the Rear of the Unit

(a) Using the Rear Support Strap (Option)

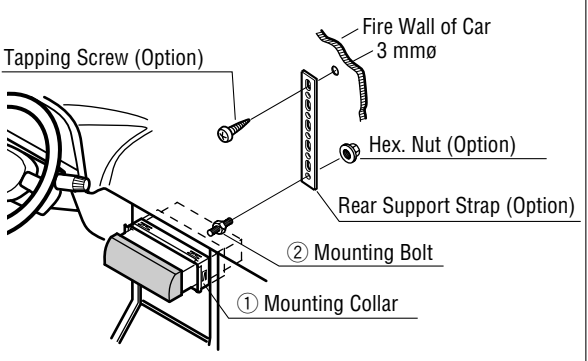

(b) Using the Rubber Cushion (Option)

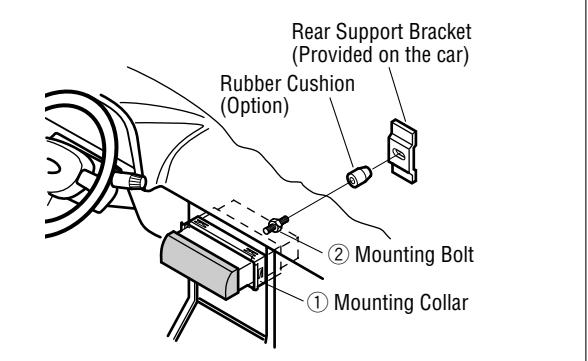

Cautions:

- We strongly recommend that you wear gloves for installation work to protect yourself from injuries.
- When bending the mounting tab of the mounting collar with a screwdriver, be careful not to injure your hands and fingers.

First complete the electrical connections, and then check them for correctness. (⇒ Page 26)

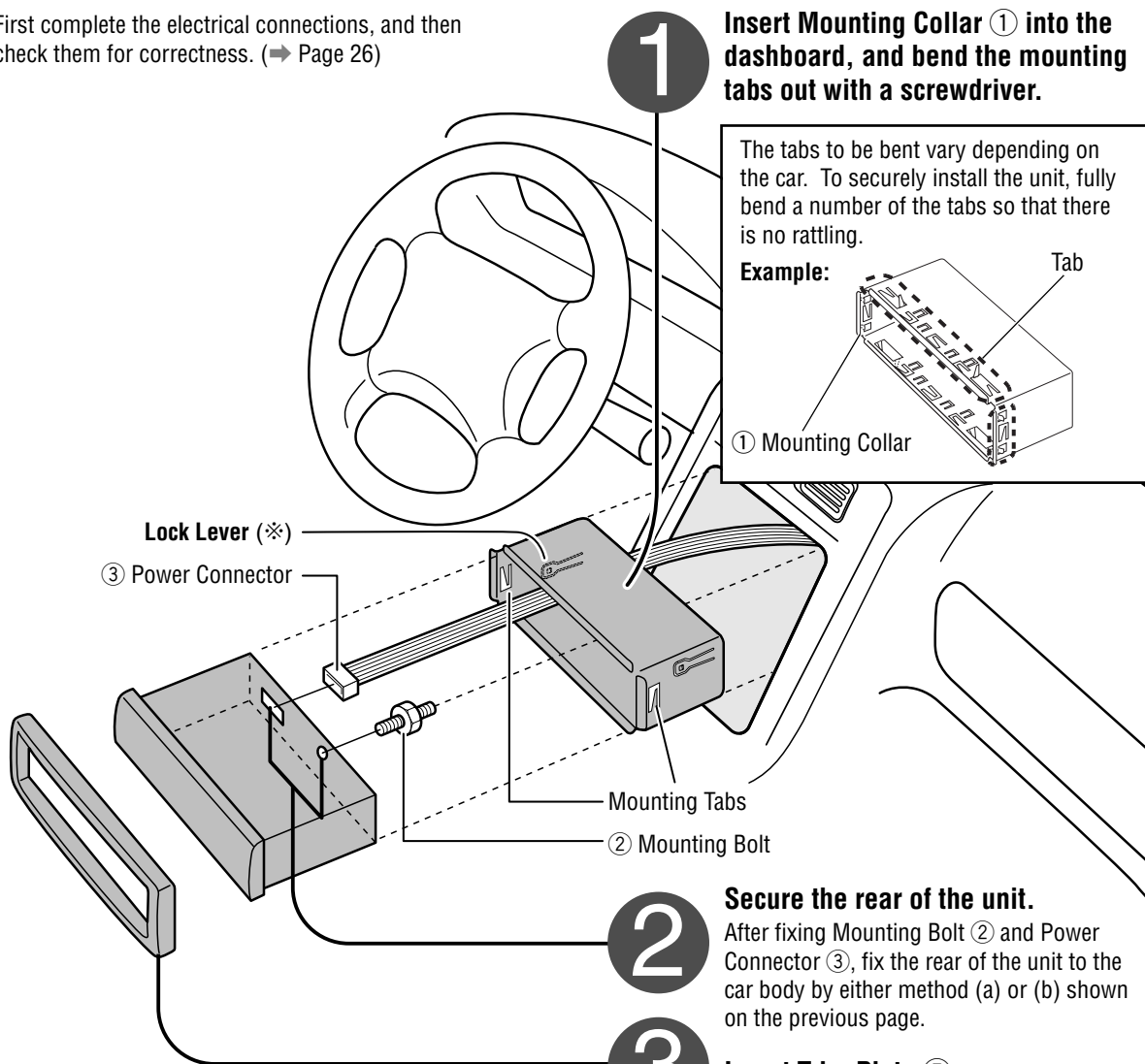

1 Insert Mounting Collar ① into the dashboard, and bend the mounting tabs out with a screwdriver.

The tabs to be bent vary depending on the car. To securely install the unit, fully bend a number of the tabs so that there is no rattling.

Example:

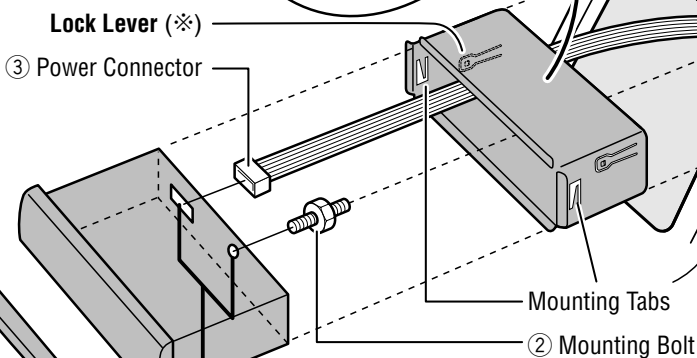
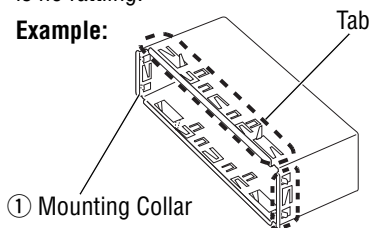

2 Secure the rear of the unit.
After fixing Mounting Bolt ② and Power Connector ③, fix the rear of the unit to the car body by either method (a) or (b) shown on the previous page.

3 Insert Trim Plate ⑤.

4 After installation reconnect the negative (-) battery terminal.

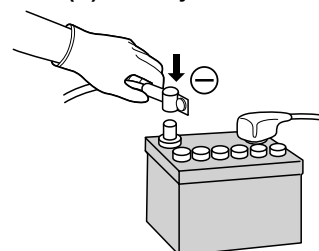

Make sure that the lock lever (*) is flush with the mounting collar (not projecting outward).

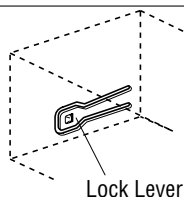

Installation (continued)

To Remove the Unit

1 Remove the removable face plate.
 (a) Press the release button [].

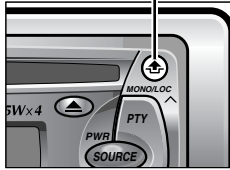

(b) Pull on the right side of the unit.

2 Remove the Trim Plate ⑤ with a screwdriver.

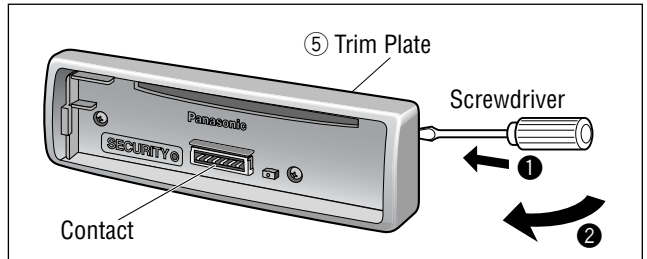
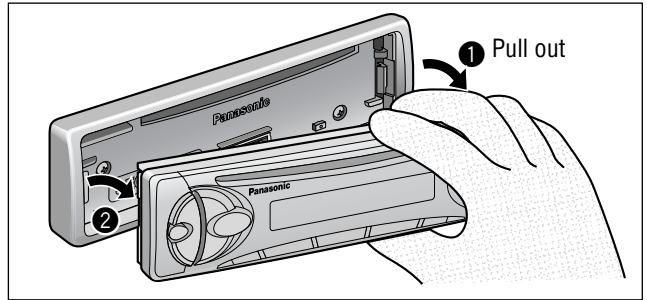

3 Pull out the unit while pushing down the lock lever with a screwdriver.

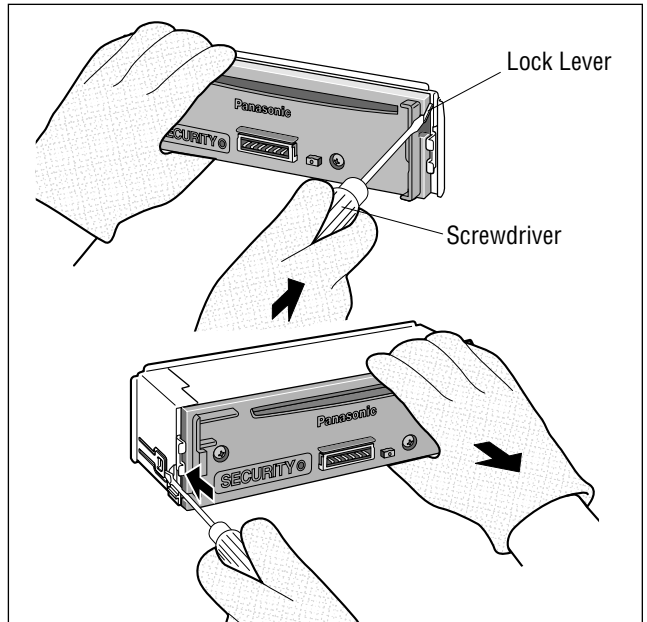

4 Remove the unit pulling with both hands.

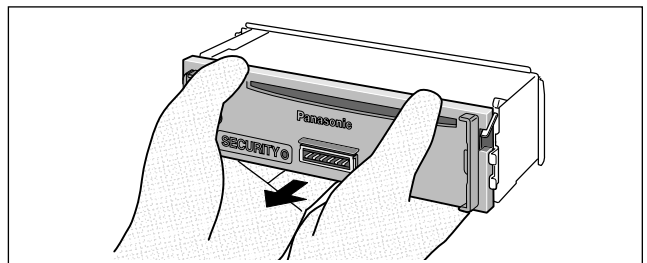

Cautions:

- Do not touch the contacts on the face plate or on the main unit, since this may result in poor electrical contacts.
- If dirt or other foreign substances get on the contacts, wipe them off with clean and dry cloth.

Anti-Theft System

This unit is equipped with a removable face plate. Removing this face plate makes the radio totally inoperable.

Place Removable Face Plate into Case

- 1 Switch off the power of the unit.
- 2 Remove the removable face plate. (→ Page 24)
- 3 Gently press the bottom of the case and open the cover. Place the face plate into the case and take it with you when you leave the car.

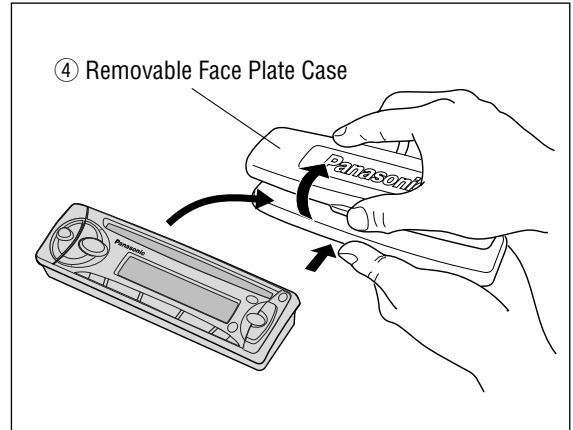

Cautions:

- This face plate is not water-proof. Do not expose it to water or excessive moisture.
- Do not remove the face plate while driving your car.
- Do not place the face plate on the dashboard or nearby areas where the temperature rises to high levels.

Install Removable Face Plate

- 1 Slide the left side of the removable face plate in place.
- 2 Press the right end of removable face plate until “click” is heard.

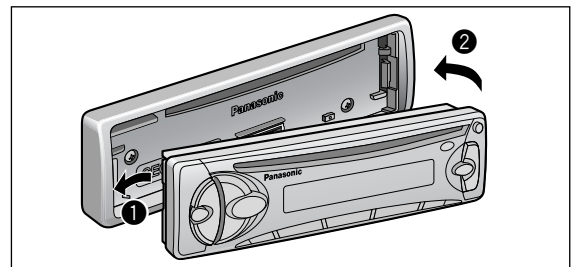

Panel Removal Alarm

This alarm sounds to warn you not to forget to remove the panel before leaving your car.

Press and hold [SEL] to switch between “ALRM ON” or “ALRM OFF” in turn.

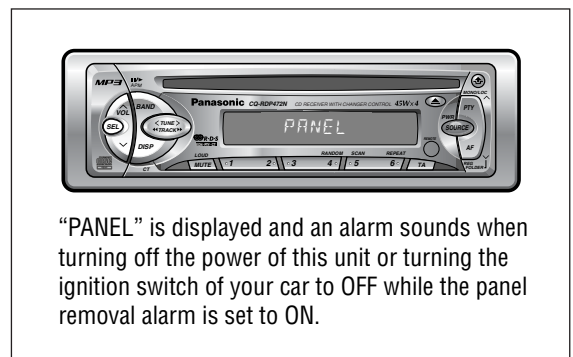
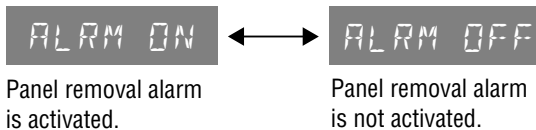

Electrical Connections

Cautions:

- Check the connectors provided on your car (see precaution below) before connecting the system.
- This unit is designed for use in a car having a 12-volt negative ground battery system.
- To prevent damage to the unit, be sure to follow the connection diagram.
- Strip about 5 mm of the lead ends for connection (only non-ISO connector cords).
- Do not insert the power connector into the unit until the wiring is completed.
- Be sure to insulate any exposed wires to prevent short circuiting with the car chassis. Bundle all cables, and prevent cable terminals from touching any metal parts.

Precautions (ISO Connector)

- The pin arrangement of the power connector conforms to ISO standard.
- The pin arrangement of ISO connectors in some cars may differ from the ISO standard.
- Please check that the pin arrangement of the connector in your car conforms to ISO standard.
- For car types A and B, change the wiring of the red and yellow leads as shown at below.
- After connection, insulate the portions marked (※) with insulating tape.

Note: For cars other than types A and B, please consult your local car shop.

ISO Standard ISO

A7: IGN or ACC switched 12 V supply

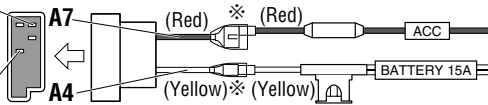

A4: +12 V Battery (Permanent supply)

A Car Type A

A7: +12 V Battery (Permanent supply)

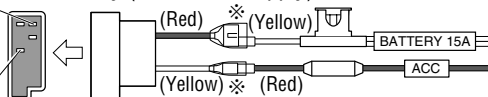

A4: IGN or ACC switched 12 V supply

B Car Type B

A7: +12 V Battery (Permanent supply)

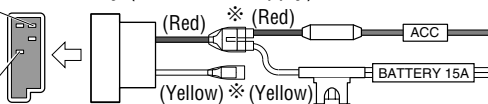

A4: No connection

Wiring Diagram

Example: Connection with CD changer CX-DP88N (Option)

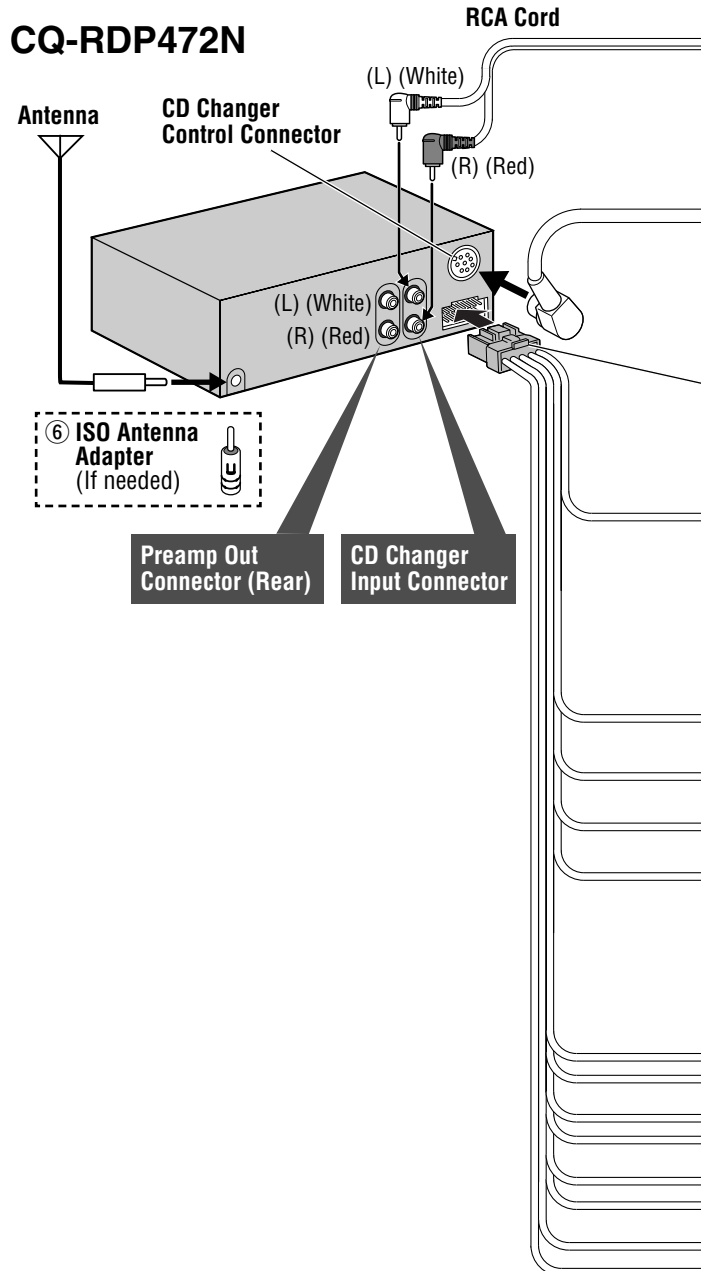

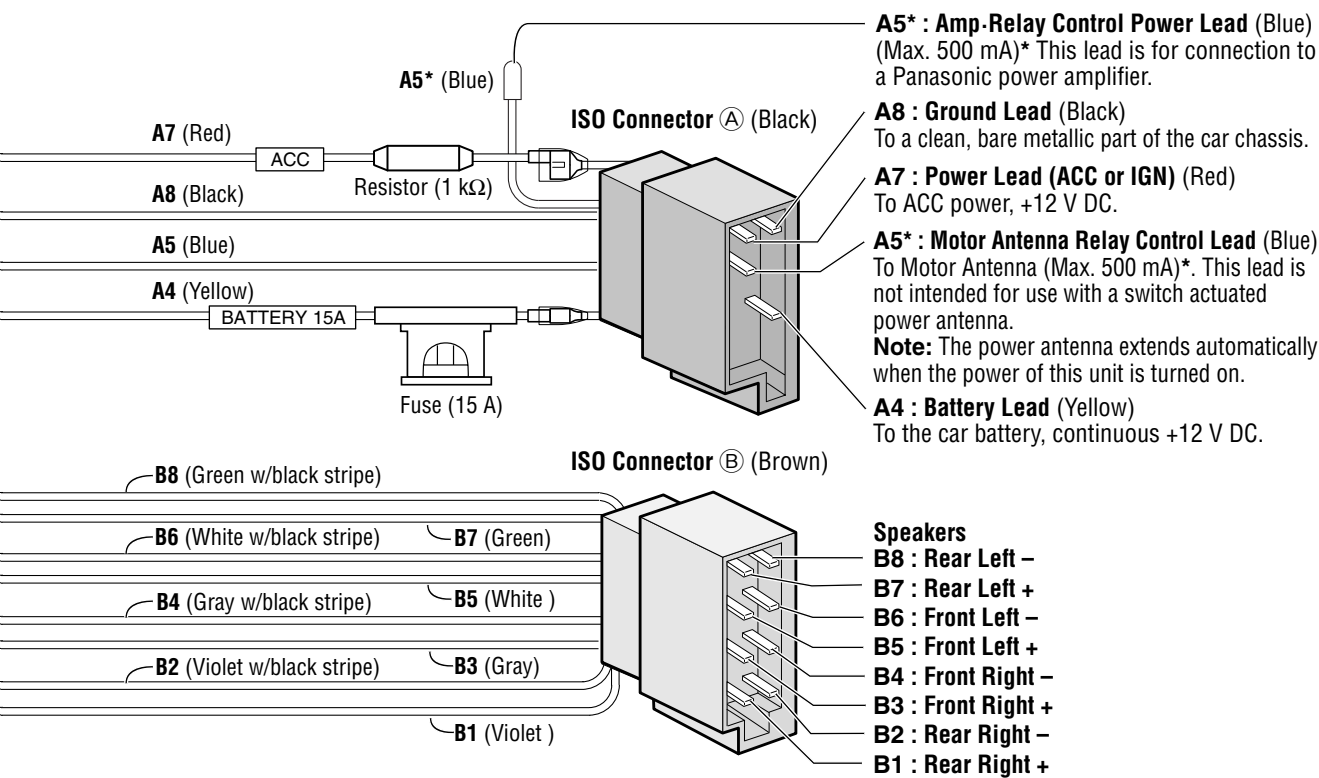
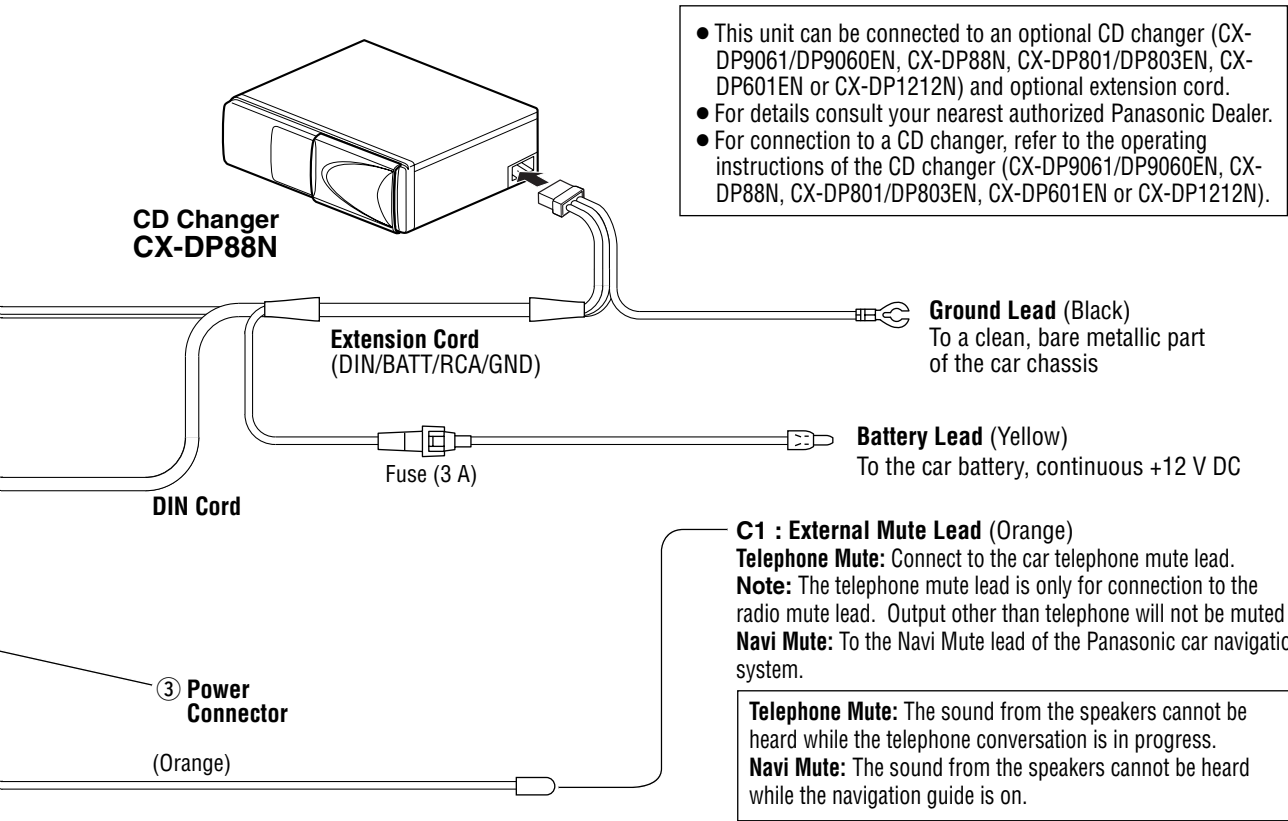

A5*: This lead can be used as either Amp-Relay Control Power Lead or Motor Antenna Relay Control Lead, or both at the same time. However, the current capacity of this lead is 500 mA.

Speaker Connections

Caution: Please follow the instructions given below. Failure to do so will cause damage to the unit and speakers.

<Right>

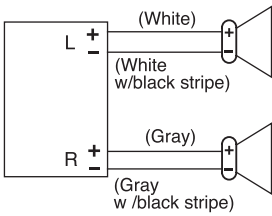

- Use ungrounded speaker only.
- The maximum speaker output should be 45 W or more. (If used with the optional power amplifier, the speaker output should be higher than the maximum amplifier output.)
- The speaker impedance should be 4 - 8 Ω.
- This unit uses the BTCL circuit, so each speaker should be connected separately using parallel vinyl insulated cords.
- The speaker cords and the power amplifier unit should be kept away (about 30 cm apart) from the antenna and antenna extension cord.

<Wrong>

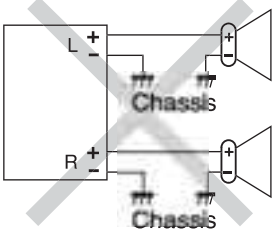

- Never connect the speaker cord to the body of the car.

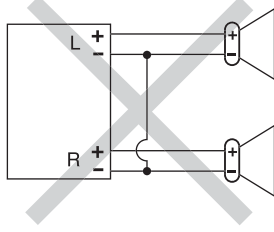

- Do not use a 3-wire type speaker system having a common earth lead.

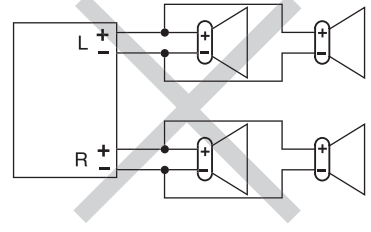

- Do not connect more than one speaker to one set of speaker leads.

Fuse

Use fuses of the same specified rating (15 A). Using different substitutes or fuses with higher ratings, or connecting the unit directly without a fuse, could cause fire or damage to the unit.

If the replacement fuse fails, contact your nearest authorized Panasonic Service Center.

Your product is designed and manufactured to ensure the minimum of maintenance. Use a soft cloth for routine exterior cleaning. Never use benzine, thinner, or other solvents.

Notes on CD / CD Media (CD-ROM, CD-R, CD-RW)

If you use commercial CDs, they must have either of these labels shown at right.



How to hold the disc

- Do not touch the underside of the disc.
- Do not scratch on the disc.
- Do not bend disc.
- When not in use, keep disc in the case.

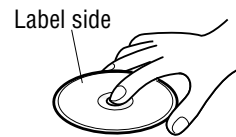

Do not use irregularly shaped discs.

Do not leave discs in the following places:

- Direct sunlight
- Near car heaters
- Dirty, dusty and damp areas
- Seats and dashboards



Do not use irregularly shaped discs.

Disc cleaning

Use a dry, soft cloth to wipe from the center outward.



Caution on new discs

A new disc may have rough edges on its inner and outer perimeter. These may cause malfunction. Remove the rough edges using a pencil, etc.

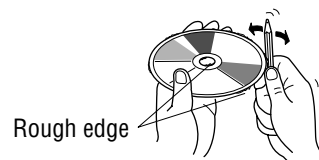

Do not attach any seals or labels to your discs.

Do not write on the disc label in a heavy pen or ballpoint pen.

Notes on CD-Rs/RWs

- You may have trouble playing back some CD-R/RW discs recorded on CD recorders (CD-R/RW drives), either due to their recording characteristics or dirt, fingerprints, scratches, etc. on the disc surface.
- CD-R/RW discs are less resistant to high temperatures and high humidity than ordinary music CDs. Leaving them inside a car for extended periods may damage and make playback impossible.
- Some CD-R/RWs cannot be played back successfully thanks to incompatibility among writing software, a CD recorder (CD-R/RW drive) and the discs.
- This player cannot play the CD-R/RW discs if the session is not closed.
- This player cannot play the CD-R/RW discs which contains other than CD-DA or MP3 data (Video CD, etc.).
- Be sure to observe the instructions of CD-R/RW disc for handling it.

Troubleshooting

Preliminary Steps

Check and take steps as described in the tables below.

If You Suspect Something Wrong

Immediately switch power off.

Disconnect the power cable and check that there is neither smoke nor heat from the unit before asking for repairs. Never try to repair the unit yourself because it is dangerous to do so.

Cautions:

- Do not use the unit if it malfunctions or something is wrong.
- Do not use the unit in an irregular condition, for example, without sound, or with smoke or foul smell, which can cause ignition or electric shock. Immediately stop using the unit and call the store where you purchased it.

Product Service

If the suggestions in the charts do not solve the problem, we recommend that you take it to your nearest authorized Panasonic Service Center. The product should be serviced only by a qualified technician.

Common

Problem	Possible cause / Possible solution
No power.	<p>Car's engine switch is not on. → Turn your car's ignition switch to ACC or ON.</p> <p>Cables are not correctly connected. → Connect cables correctly. Battery cable: Connect the battery cable to the terminal that is always live. Accessory cable: Connect the accessory cable to your car's ACC source. Grounding wire: Connect the grounding wire to a metal part of your car.</p> <p>Fuse is burnt. → Call the store where you purchased the unit, or your nearest Panasonic Service Center and ask for replacement fuse.</p>
No sound.	<p>Mute is set to ON. → Set it to OFF.</p> <p>Cables are not correctly connected. → Connect cables correctly.</p> <p>External Mute lead is not correctly connected. → Connect the External Mute lead correctly.</p> <p>Condensation (dew). → Wait for a while before use.</p>
Noise.	<p>A mobile phone is used near the unit. → Keep the mobile phone away from the unit.</p>
Audio sound is output but the display shows demonstration message.	<p>Demonstration mode is ON. → Press [DISP] to cancel demonstration mode.</p>

Radio

Problem	Possible cause / Possible solution
Poor reception of FM stereo and monaural broadcasts.	<p>Station is too far, or signals are too weak. → Select other stations of higher signal level.</p> <p>The radio antenna is not extended enough. → Extend the radio antenna enough.</p> <p>The motor antenna relay control lead is not connected correctly. → If there is a motor antenna in the car, connect the motor antenna relay control lead to the motor antenna lead that is installed in the car correctly.</p>
Preset station is reset.	<p>Battery cable is not correctly connected. → Connect the battery cable to the terminal that is always live.</p>

CD / MP3

Problem	Possible cause / Possible solution
Disc is in the CD compartment but no sound is made, or disc is ejected automatically.	<p>Disc is upside down. → Place disc in the correct direction with the label side up.</p> <p>Disc is dirty. → Clean disc, referring to the section on “Notes on CD / CD Media (CD-ROM, CD-R, CD-RW)” (→ Page 29).</p> <p>A disc that has data other than CD-DA or MP3 type is loaded. → Discs that have CD-DA or MP3 type data should be used.</p> <p>→ Some CD-R/RWs cannot be played back successfully thanks to incompatibility among writing software, a CD recorder (CD-R/RW drive) and the discs. Refer to instructions for the concerned devices for details.</p>
Sound skips, bad sound quality. (e.g. caused by noise)	<p>Disc is dirty. → Clean disc, referring to the section on “Notes on CD / CD Media (CD-ROM, CD-R, CD-RW)” (→ Page 29).</p> <p>→ Some CD-R/RWs cannot be played back successfully thanks to incompatibility among writing software, a CD recorder (CD-R/RW drive) and the discs. Refer to instructions for the concerned devices for details.</p>
Sound skip due to vibration.	<p>Mounting angle is over 30 degrees. → Adjust mounting angle to less than 30 degrees.</p> <p>Unstable mounting. → Mount the unit securely with the mounting parts, referring to the section on Installation.</p>
Disc is not ejected.	<ul style="list-style-type: none"> ● Disc is defective. ● Mechanical trouble. <p>→ Press [▲]. If normal operation is not restored, call the store where you purchased the unit or the nearest Panasonic Service Center to ask for repairs.</p>

Troubleshooting (continued)

■ CD

Problem	Possible cause / Possible solution
CD text is not displayed normally.	Disc is dirty, or has scratches. → Clean disc, referring to the section on “Notes on CD / CD Media (CD-ROM, CD-R, CD-RW)” (⇒ Page 29).
Time is counted but no sound comes out.	The 1st track of a mix mode disc was reproduced. (Mix mode is a format in which data except music is recorded on the 1st track and music data is recorded on other than the 1st track in a session.) → Playback music data recorded on other than the 1st track.

■ MP3

Problem	Possible cause / Possible solution
No playback.	The disc does not conform to any of the file systems supported by this player. → Insert a disc that conforms to the file systems supported by this player. For supported file systems, see “Points to remember when recording an MP3 disc” (⇒ Page 18).
	The MP3 file is missing the “.mp3” file name extension. → Make sure to add the “.mp3” extension to each MP3 file name.
It takes too long for playback to start.	The folders and files recorded on the disc are layered too much. → As checking of files takes longer in this case, do not record any unnecessary folders or files other than MP3s on the disc. (If there are many hierarchies of files and folders, it may take up to 150 seconds to start playback.)
Poor recording quality, sound skipping.	→ The recording quality differs depending on the encoding software used, and on settings such as the bit rate. Set the bit rate within the range specified in the specifications chart (⇒ Page 35). It is recommended to set the bit rate to “128 kbps or more” and “Fixed”.
	High-speed writing was executed when MP3 data was recorded on the disc. → Decrease writing speed as low as possible.
Files are not played in the desired order.	Files or folders are not recorded in the desired playback order. → Some writing software lets you specify the recording order by adding a prefix in the range of “01” - “99”, etc. to the file name. For details refer to the user manual of your writing software.
Folder / file name is not displayed correctly.	The disc does not conform to the file systems supported by this player. → Insert a disc that conforms to the file systems supported by this player. For supported file systems see “Points to remember when recording an MP3 disc” (⇒ Page 18).
	→ There may be a problem with your writing software or CD recorder (CD-R/RW drive). For details refer to the user manual of your writing software.

■ MP3 (Continued)

Problem	Possible cause / Possible solution
<p>File playing time is not displayed correctly.</p>	<p>You ran the file in fast forward or fast reverse during playback or turned off the ignition switch of the car during playback. →Playing another file will return the file playing time to normal.</p>
	<p>You played a VBR (Variable Bit Rate) format MP3 file. →The file playing time of VBR (Variable Bit Rate) format MP3 file is sometimes displayed incorrectly.</p>
	<p>You played a file in which character information had been recorded by use of ID3Tag 2.0 or later version. →A file in which character information was recorded by use of ID3Tag 2.0 or later version may not be reproduced normally. For example, the file playing time may not be displayed correctly.</p>

■ Sound Setting

Problem	Possible cause / Possible solution
<p>No sound from left, right, front, or rear speaker.</p>	<p>Left and right balance, or front and rear balance is off on one side. →Adjust balance / fader as appropriate (→ Page 7).</p>
<p>Left and right sounds are reversed.</p>	<p>Cables are not correctly connected. →Connect the cables correctly.</p>
	<p>The speaker leads are connected in reverse between right and left. →Connect the speaker leads to the correct one.</p>





■ Remote Control

Problem	Possible cause / Possible solution
<p>Buttons are invalid for operation.</p>	<p>Battery polarities (+) (-) are reversed. →Insert the battery correctly.</p>
	<p>Wrong battery. →Check the battery.</p>
	<p>Battery has run down. →Replace the battery.</p>
	<p>Remote control is in the wrong direction. →Direct the remote controller at REMOTE (sensor) on the panel.</p>





Troubleshooting (continued)

Error Display Messages

■ CD / MP3

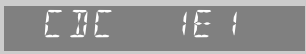
Display	Possible cause / Possible solution
  The disc ejected automatically	<ul style="list-style-type: none"> • Disc is dirty, or is upside down. • A disc that has data other than CD-DA or MP3 type is loaded. Disc has scratches. → Check disc.
 → Return to previous mode	No operation by some cause. → If normal operation is not restored, call the store where you purchased the unit or the nearest Panasonic Service Center to ask for repairs.
	When there is no MP3 files in the specified folder during direct MP3 folder selection. → Select another folder which contains MP3 files.
	The player for some reason cannot read the file you are trying to play. (File recorded in an unsupported file system, compression scheme, data format, file name extension, damaged data, etc.) → Select a file that the player can read. Confirm the type of data recorded on the disc. Create a new disc if necessary.

■ CD Changer

Display	Possible cause / Possible solution
  Disc Number To next disc automatically	<ul style="list-style-type: none"> • Disc is dirty, or is upside down. • A disc other than a music CD (CD-DA type) is loaded. Disc has scratches. → Check disc.
	No operation by some cause. → Press the reset switch on the CD changer. If normal operation is not restored, call the store where you purchased the unit or the nearest Panasonic Service Center to ask for repairs. The display continues if you cannot switch off the power.
	No disc is in the changer (magazine). → Insert discs into the changer (magazine).

Notes:

- Some CD changers will let this unit to be turned off after “CDC -E3-” error message appears.
- For details refer to the operating instructions of your CD changer.

Specifications

General		CD Player	
Power Supply	: DC 12 V (11 V - 16 V), Test Voltage 14.4 V, Negative Ground	Sampling Frequency	: 8 times oversampling
Tone Controls	: Bass; ± 12 dB at 100 Hz : Treble; ± 12 dB at 10 kHz	DA Converter	: MASH•1 bit/4 DAC System
Current Consumption	: Less than 2.5 A (CD mode, 0.5 W 4-Speaker)	Error Correction System	: Panasonic Super Decoding Algorithm
Maximum Power Output	: 45 W x 4 (at 4 Ω)	Pick-Up Type	: Astigma 3-beam
Power Output	: 20 W x 4 (DIN45 324, at 4 Ω)	Light Source	: Semiconductor laser
Pre-Amp Output Voltage	: 2 V (CD mode)	Wavelength	: 780 nm
Pre-Amp Output Impedance	: 200 Ω	Frequency Response	: 20 Hz - 20 kHz (± 1 dB)
Speaker Impedance	: 4 - 8 Ω	Signal to Noise Ratio	: 96 dB
Dimensions	: 178 (W) x 50 (H) x 150 (D) mm	Total Harmonic Distortion	: 0.01 % (1 kHz)
Weight	: 1.5 kg	Wow and Flutter	: Below measurable limits
FM Stereo Radio		Channel Separation	: 70 dB
Frequency Range	: 87.5 - 108 MHz	MP3 decoding	: MPEG 1 Audio Layer 3 MPEG 2 Audio Layer 3
Usable Sensitivity	: 6 dB/ μ V (S/N 30 dB)	Bit Rate	
Stereo Separation	: 35 dB (at 1 kHz)	(MPEG 1 Audio Layer 3)	: 32 kbps - 256 kbps, VBR (Variable Bit Rate)
MW Radio		(MPEG 2 Audio Layer 3)	: 16 kbps - 160 kbps, VBR (Variable Bit Rate)
Frequency Range	: 531 - 1,602 kHz	Sampling Frequency	
Usable Sensitivity	: 28 dB/ μ V (S/N 20 dB)	(MPEG 1 Audio Layer 3)	: 32 kHz, 44.1 kHz, 48 kHz
LW Radio		(MPEG 2 Audio Layer 3)	: 22.05 kHz, 24 kHz
Frequency Range	: 153 - 279 kHz		
Usable Sensitivity	: 32 dB/ μ V (S/N 20 dB)		

Note: Specifications and design are subject to modification without notice due to improvements.

Matsushita Electric Industrial Co., Ltd.
Central P.O. Box 288, Osaka 542-8588, Japan

Dalian Matsushita Communication Industrial Co., Ltd.
Daxinzhaizi, Ganjingzi District, Dalian, China P.C. 116033

YEFM283841 D0102-0 Printed in China

Free Manuals Download Website

<http://myh66.com>

<http://usermanuals.us>

<http://www.somanuals.com>

<http://www.4manuals.cc>

<http://www.manual-lib.com>

<http://www.404manual.com>

<http://www.luxmanual.com>

<http://aubethermostatmanual.com>

Golf course search by state

<http://golfingnear.com>

Email search by domain

<http://emailbydomain.com>

Auto manuals search

<http://auto.somanuals.com>

TV manuals search

<http://tv.somanuals.com>