

# Operating Instructions

## 操作说明书

### ИНСТРУКЦИЯ ПО ЭКСПЛУАТАЦИИ

[CQ-DP33EW]

High-Power CD Player/Receiver with Changer Control

附 CD 换片器控制的大功率镭射唱机 / 收音机

Высокомощный CD-плеер/приёмник с управлением ченджером

## CQ-DP33EW

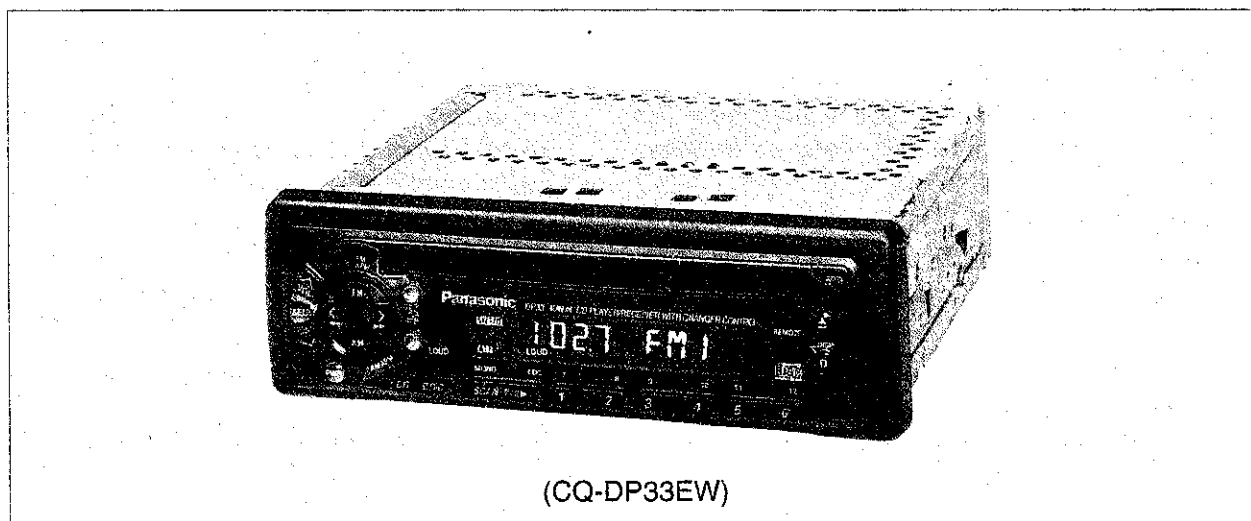

# Panasonic®

松下电器

Before operating this set, please read these instructions completely.

操作本机之前，请熟读本说明书。

Перед началом эксплуатации аппарата полностью прочитайте, пожалуйста, данную инструкцию.

# Contents

Precautions . . . . .	2	Electrical Connection . . . . .	19
Power and Sound Controls . . . . .	5	Speaker Connections . . . . .	20
Radio Basics . . . . .	7	Special Notes . . . . .	21
Compact Disc Player Basics . . . . .	9	Fuse . . . . .	21
CD Changer Basics . . . . .	11	Maintenance . . . . .	21
Clock Basics . . . . .	14	Specifications . . . . .	22
Installation Guide . . . . .	15		

*Panasonic welcomes you to our ever growing family of electronic product owners. We know that this product will bring you many hours of enjoyment. Our reputation is built on precise electronic and mechanical engineering, manufactured with carefully selected components and assembled by people who take pride in their work. Once you discover the quality, reliability, and value we have built into this product, you too will be proud to be a member of our family.*

## Precautions

### Volume Level

For your driving safety, keep the volume level low enough to be aware of road and traffic conditions.

### Car Washing

To avoid electrical short circuits which may cause fire or other damage, do not expose this equipment (including the speakers and CDs) to water or excessive moisture.

### Service

This unit is made of precision parts. Do not attempt to disassemble or adjust any parts. For repair, please consult your nearest authorized Panasonic Service Center.

### Power Supply

This equipment is designed to be used in a car having 12-Volt negative ground battery system.

### Disc Mechanism

Do not insert coins or any small objects. Keep screwdrivers and other metallic objects away from the disc mechanism and disc.

### Car Ventilation

If your car is parked for several hours in direct sun-light, the temperature inside the car may become very high. It is advisable to drive the car for a while until the interior cools down before switching the unit on.

### About Preset Memory

The preset memory is cleared to return to the original factory setting when the power connector or battery is disconnected.

Optional Remote Control Unit is available to this unit.

# Power and Sound Controls

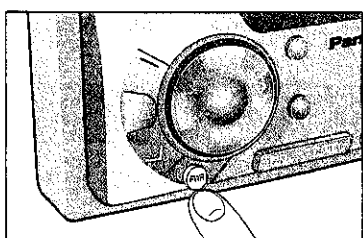
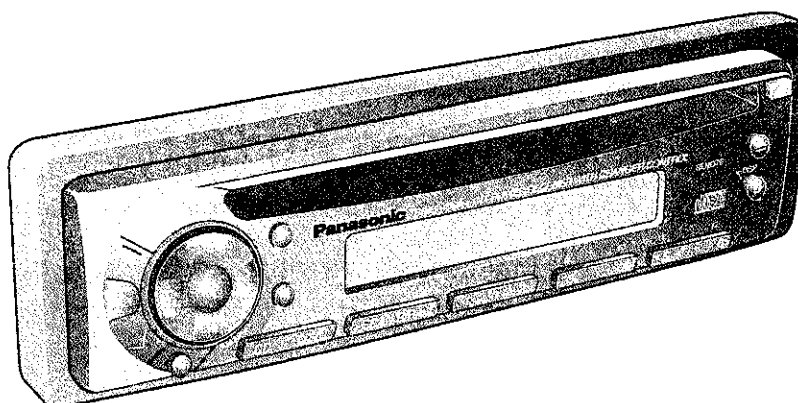

## Power

If the car is not already running, turn the key in the ignition until the accessory indicator lights.

Press **[PWR]** to switch on the power.

Press **[PWR]** again to switch off the power.

**Note:** When a CD is inserted with all power connected, the unit power will automatically turn on and CD loading begins and plays.

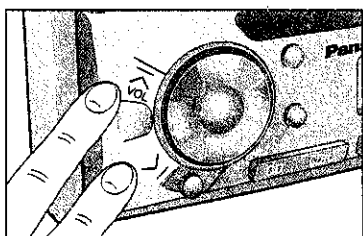

## Volume

- Press **[^ VOL]** or **[v VOL]** to increase or decrease volume.



- Press **[^ VOL]** or **[v VOL]** for more than 0.5 second to change numeric levels on the display rapidly.

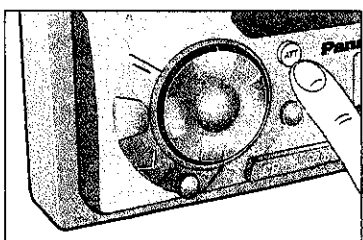

## Attenuator

- Press **[ATT]**. Volume will decrease to about 1/10 of its previous level.



- Press **[ATT]** again to deactivate when listening at normal volume.

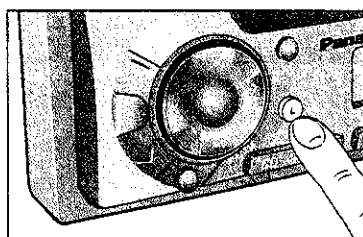

## Tone Enhancement

- Press **LOUD [L]** to enhance bass and treble tones when listening at low or medium volume.



- Press **LOUD [L]** again to deactivate.

**Note:** This unit is equipped with an anti-volume-blast circuit which serves as an automatic volume level adjuster so that you will not be deafened sudden loud volume.

This system operates as follows. When **[PWR]** is switched on, the volume level is low. After that, the volume level gradually returns to its previous level prior to switching off the unit.

# Power and Sound Controls

(continued)

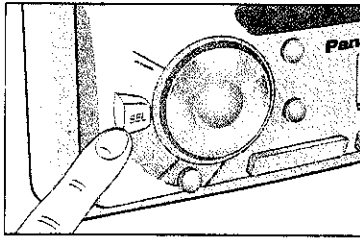

## Changing Audio Modes

Press [SEL] to switch the audio mode in the following order.

VOLUME → BASS → TREBLE → BALANCE → FADER

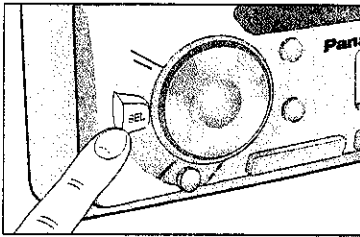

## Bass and Treble

- Press [SEL] to select the BASS (TREBLE) mode. Press [^ VOL] or [v VOL] to increase or decrease the bass/treble response.



- Press [^ VOL] or [v VOL] for more than 0.5 second to change numeric levels on the display rapidly.

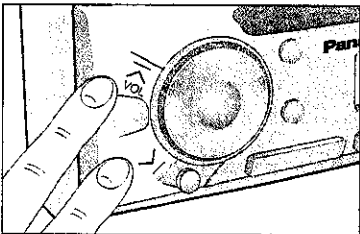

## Balance

- Press [SEL] to select the BALANCE mode. Press [^ VOL] or [v VOL] to shift the sound volume to right or left speakers.

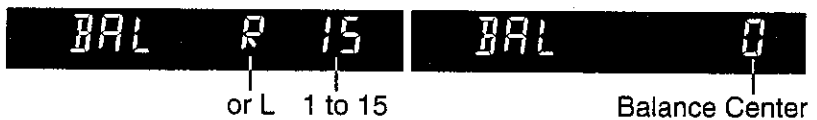

- Press [^ VOL] or [v VOL] for more than 0.5 second to change numeric levels on the display rapidly.

## Fader

- Press [SEL] to select the FADER mode. Press [^ VOL] or [v VOL] to shift the sound volume to the front or rear speakers.



- Press [^ VOL] or [v VOL] for more than 0.5 second to change numeric levels on the display rapidly.

**Note:** When a control mode (BAS/TRE/BAL/FAD) is selected but no operation is made within 5 seconds (2 seconds at volume mode), the display will return to the normal operation (Radio, CD, etc) mode. In such a case, press [SEL] again to select the control mode.

# Radio Basics

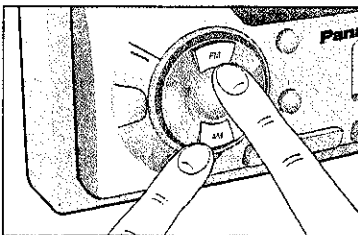
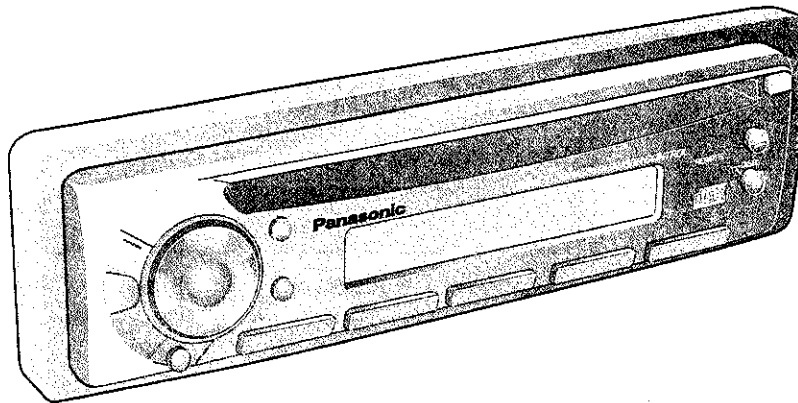

## To change Tuner Mode

You can select "FM" or "AM" directly.

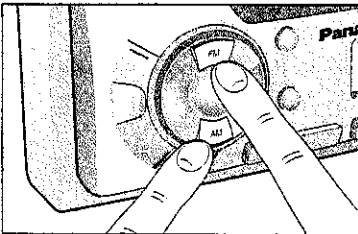

## Selecting a Band

- Press [FM] to select the bands in the following order.  
FM1→FM2→FM3



"STEREO" indicator lights if the station is broadcasting in stereo.

- Press [AM] to select the bands.

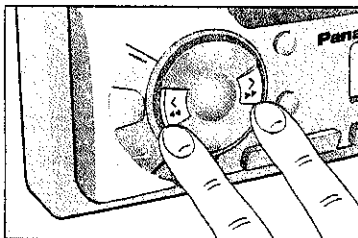

## Manual Tuning

Press [> TUNE] or [< TUNE] to move to a higher or lower frequency.

## Seek Tuning

Press and hold [> TUNE] or [< TUNE] for more than 0.5 second, then release. The radio automatically stops on the next station.

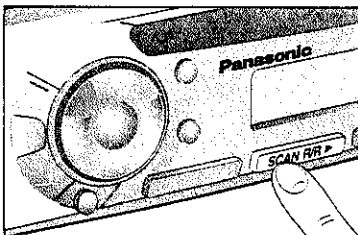

## MONO/LOCAL Selection

- Much interference is reduced during a weak FM stereo broadcasts when MONO is ON. (Only for FM mode)
- Searching stops automatically at a strong wave station only when LOCAL is ON.

Press [MONO] to switch on or off the MONO mode as follows.  
MONO OFF ↔ MONO ON

Press [LOC] to switch on or off the LOCAL mode as follows.  
LOCAL OFF ↔ LOCAL ON



# Radio Basics (continued)

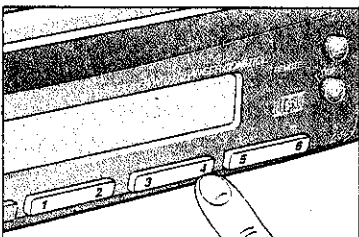
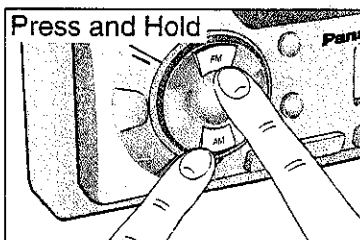
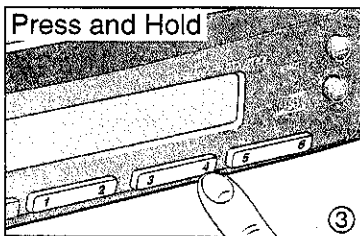
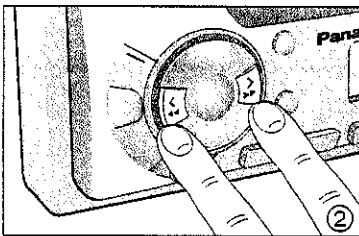
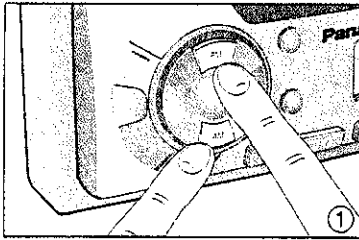

## Preset Station Setting

Up to 24 stations can be preset in the station memory as follows;

FM1	FM2	FM3	AM
6 stations	6 stations	6 stations	6 stations

## Manual Station Preset

- ① Press [FM] or [AM] to select a desired band.
- ② Use manual or seek tuning to find a station that you want to program into memory.
- ③ Press and hold one of the station selector buttons [1] through [6] until the display blinks.  
Repeat the process to set other stations for the FM1-3 and AM bands.

**Note:** You can change the memory setting by repeating the above procedure.

## Tuning in a Preset Station

Press any of the buttons [1] through [6] to tune in the station preset by the above steps ① to ③.

## Auto Station Preset

Press and hold [FM APM] or [AM APM] for more than 2 seconds.

- The 6 strongest available stations will be automatically set in memory preset buttons [1] through [6].
- Once set, the preset stations are sequentially scanned for 5 seconds.
- Press the appropriate preset button for the station you want to hear.

**Caution:** For safety reasons, do not attempt to program while driving.

# Compact Disc Player Basics

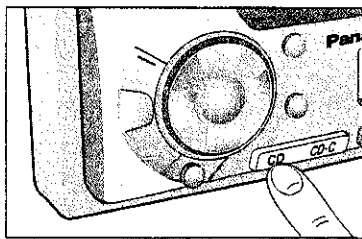
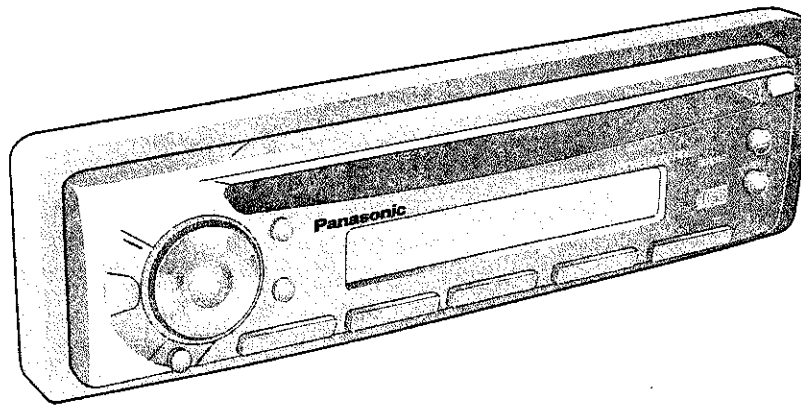

## Mode Selection

While the disc is inserted, press [CD] to select CD mode.

## To start the CD Player

Insert the disc (label side up) and playback starts automatically.



"LOAD" will be displayed until the disc is loaded. Play starts from first track.



Play time

Track number

**Note:** While the disc is inserted, "DISC" indicator will light. If you press [CD] after the disc is ejected, the disc will be re-inserted.

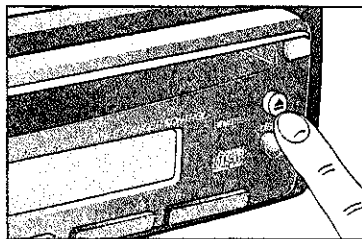

## Stopping and Ejecting a Disc

Press [▲] to stop CD play, and the disc will quietly eject from the CD slot. (During disc ejection, "EJ" (EJECT) will be displayed.)

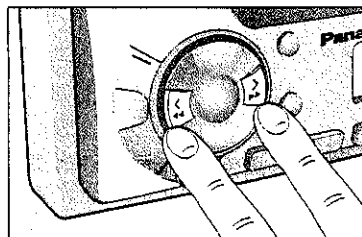

## Selecting a Track

Press [▶▶ TRACK] once to go to the next track. Press repeatedly to step forward through all the tracks.

Press [◀◀ TRACK] once to play from the beginning of the track you are listening to. Press twice to play the previous track. Press repeatedly to step backward through all the tracks.

# Compact Disc Player Basics

(continued)

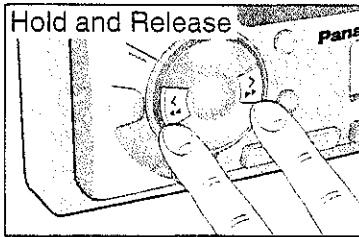

## Searching a Track

Press and hold [▶▶ TRACK] or [◀◀ TRACK] for more than 0.5 second to activate fast forward or reverse through a track. Release [▶▶ TRACK] or [◀◀ TRACK] to resume the normal CD play from that position.

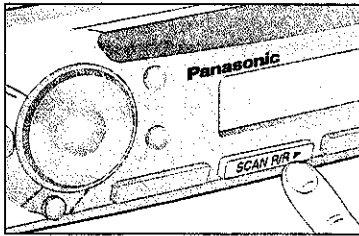

## Repeating a Track

Press [R/R ▶] to repeat the current selection. "REP" indicator will light.



The current selection will continue to repeat until you press [R/R ▶] again.

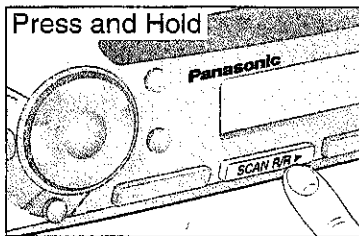

## Random Selection

Press and hold [R/R ▶] for more than 2 seconds. "R ▶" indicator will light. A random selection of music is played from all available tracks.



To turn off the random play feature, press and hold [R/R ▶] again for more than 2 seconds.

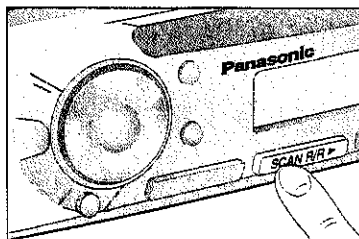

## Scanning Tracks

Press [SCAN]. The display will blink and the first 10 seconds of each track on the disc play in order.



To stop scanning and continue with the current track, press [SCAN] again.

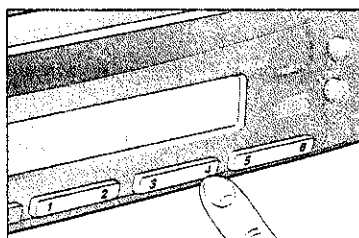

## Selecting by Track Number (Direct access)

- Press a number from [1] to [6] then the corresponding track will start.
- Press and hold a number from [7] to [12] ([1] to [6]) for more than 1 second and the corresponding track will start.



# CD Changer Basics

**Note:**

CD changer functions are applicable to units with optional CD changer unit. (sold separately)

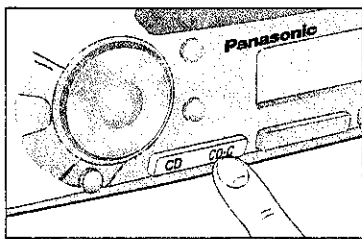
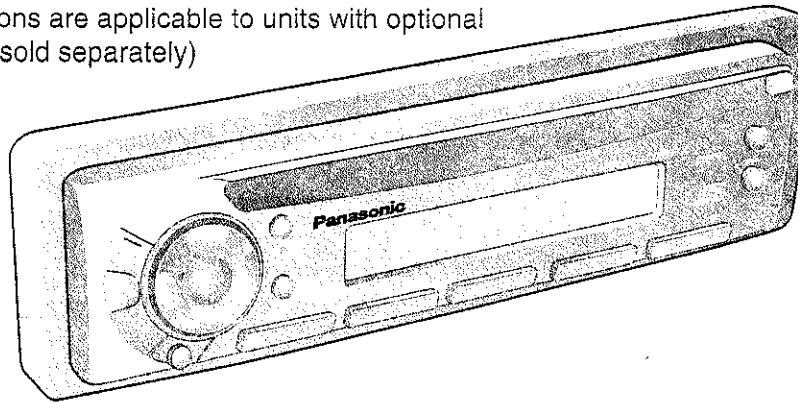

## To start the CD Changer

While a disc magazine inserted in the CD Changer, press [CD-C] to play starts from first track.

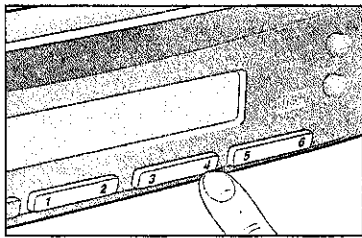

## Selecting a Disc (Direct Disc Access)

- Press a number from [1] to [6] then the corresponding disc will start.
- Press and hold a number from [7] to [12] ([1] to [6]) for more than 1 second and the corresponding disc will start.

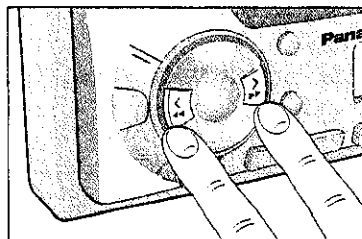

## Selecting a Track

- Press [▶▶ TRACK] once to go to the next track. Press repeatedly to step forward through all the tracks.
- Press [◀◀ TRACK] once to play from the beginning of the current track. Press twice to play the previous track. Press repeatedly to step backward through all the tracks.

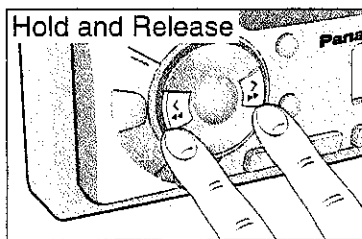

## Searching a Track

- Press and hold [▶▶ TRACK] or [◀◀ TRACK] for more than 0.5 second to activate fast forward or reverse through a track.
- Release [▶▶ TRACK] or [◀◀ TRACK] to resume the normal CD changer play from that position.

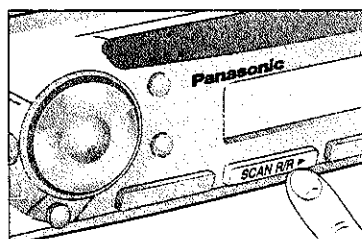

## Repeating a Track

Press [R/R▶] to repeat the current selection. "REP" indicator will light.



The current selection will continue to repeat until you press [R/R▶] again.

# CD Changer Basics (continued)

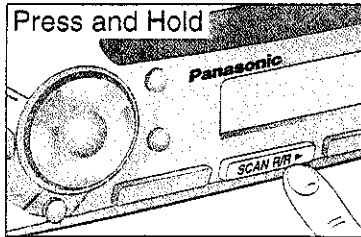

## Random Selection

Press and hold [R/R▶] for more than 2 seconds. "R▶" indicator will light. A random selection of music is played from all available tracks.



To turn it off, press and hold [R/R▶] for more than 2 seconds again.

**Note:**

- When [R/R▶] is pressed in the Random mode, the current track will continue to repeat until pressing [R/R▶] again.
- When [R/R▶] is pressed again, repeat play stops and returns to random play.
- Press and hold [R/R▶] for more than 2 seconds again, random play stops.

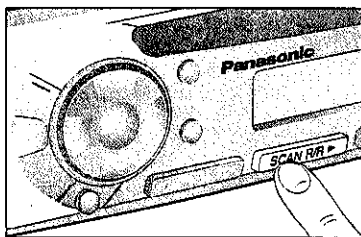

## Scanning Tracks

Press [SCAN]. The display blinks and the first 10 seconds of each track on the discs play in order.

To stop scanning and continue with the current track, press [SCAN] again.

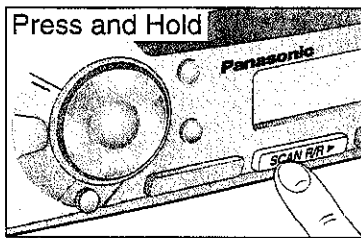

## Scanning Discs

Press and hold [SCAN] for more than 2 seconds. The 1st track of all the discs in the magazine is played for 10 seconds each. Also, disc number is displayed at the same time.

To stop scanning and continue with the current track, press and hold [SCAN] for more than 2 seconds again.

**Note:** You cannot change the current display while Scan plays in CD or CD Changer.

## Error Display Messages

### CD

E1	Displays when the compact disc is dirty or upside down. The disc eject automatically.
E2	Displays when compact disc is scratched. The disc eject automatically.
E3	Displays when the compact disc stops operating for some reason. Please turn off the car engine (ACC off) and remove the fuse from yellow lead for 1 minute. Then reinstall the fuse.

### CD-Changer

E1	Displays when the compact disc is dirty or upside down. Selects the next available compact disc.
E2	Displays when compact disc is scratched. Selects next available compact disc.
E3	Displays when the unit stops operating for some reason. Press <b>[RESET]</b> on the CD Changer (optional).
0000	Displays when there is no disc in the magazine.

# Clock Basics (The clock system is 12-hours.)

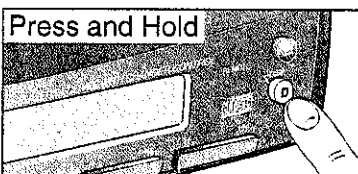
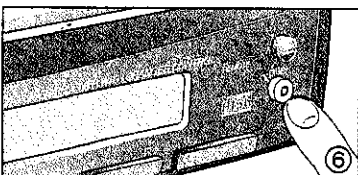
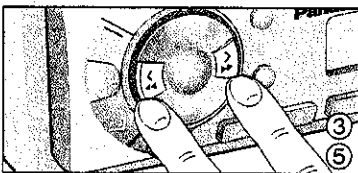
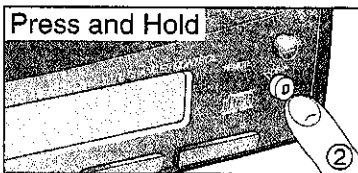
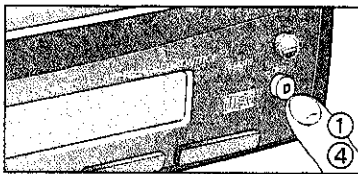
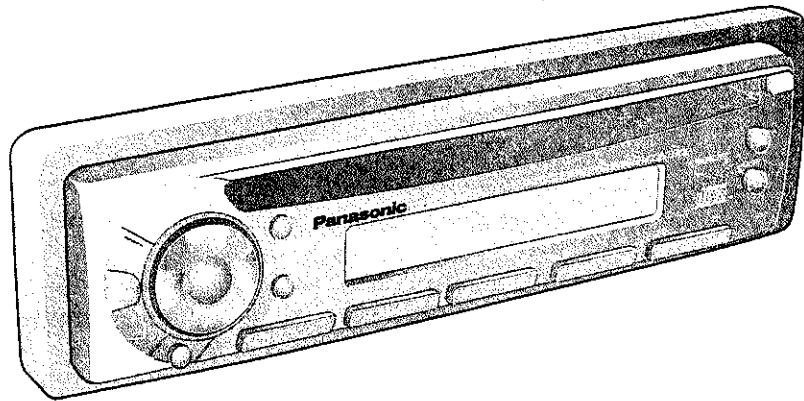

## Initial Time Setting

① Press **DISP [D]**. "Adj" is displayed.

② Press and hold **DISP [D]** again for more than 2 seconds, "12" blinks indicating the time setting mode is activated.

③ To set hours, press [**> TUNE**] or [**< TUNE**].

④ Press **DISP [D]** again for minute setting.

⑤ To set minutes, press [**> TUNE**] or [**< TUNE**].

Hold [**> TUNE**] or [**< TUNE**] to change numbers rapidly.

⑥ When you have set the time, press **DISP [D]**.



## Resetting the Time

When you want to reset the time, press and hold **DISP [D]** for more than 2 seconds to activate the time setting mode. Then, repeat steps ③ to ⑥ above.

## Selecting the Clock Display

Press **DISP [D]** for clock display.

Press **DISP [D]** once again, the current audio display mode resumes.

**Note:** Before you leave your car that has no ACC, be sure to switch power off.

# Installation Guide

## Preparation:

- Before installation check the radio operation with antenna and speakers.
- Disconnect the cable from the negative (-) battery terminal (see caution below).

## Caution:

For installation to cars with trip or navigational computer, all electronic memory settings previously registered in the computer will be lost when the battery terminal is disconnected. For this type of car, battery could not be disconnected. Therefore, extra care should be taken to prevent short circuiting.

## In dash installation

### Installation Opening

In-dash installation can be done if the car's dashboard has an opening for this unit as shown in Fig. 1. The car's dashboard should have a thickness of 4.5mm-6mm in order to make the installation of the unit.

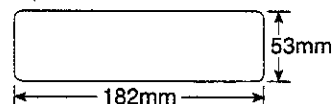

Fig. 1

## Installation Precautions

This equipment, if possible, should be installed by a professional installer.

In case of difficulty, please consult your nearest authorized Panasonic Service Center.

1. This system is to be used only in a 12-volt, DC battery system (car) with negative ground.
2. Follow the electrical connection (→ page 19) carefully. Failure to do so may result in damage to the unit.
3. Connect the power lead after other connections are made.
4. Be sure to connect the YELLOW lead to positive terminal (+) of the battery to fuse block (BAT) terminal.
5. Insulate all exposed wires to prevent short circuiting.
6. Secure all loose wires after installing the unit.
7. Please carefully read the operating and installation instructions of the respective equipment before connecting it to this unit.

## ☐ Installation Hardware

No.	Item	Diagram	Qty	No.	Item	Diagram	Qty
①	Mounting Collar		1	⑤	Mounting Bolt (5 mmφ)		1
②	Hex. Nut (5 mmφ)		1	⑥	Power Connector		1
③	Rear Support Strap		1	⑦	Trim Plate		1
④	Tapping Screw		1				

# Installation Guide (continued)

## □ Installation Procedures

### 1. Secure the Mounting Collar ①.

Insert Mounting Collar ① into the car's dashboard, and bend mounting tabs out with a screwdriver.

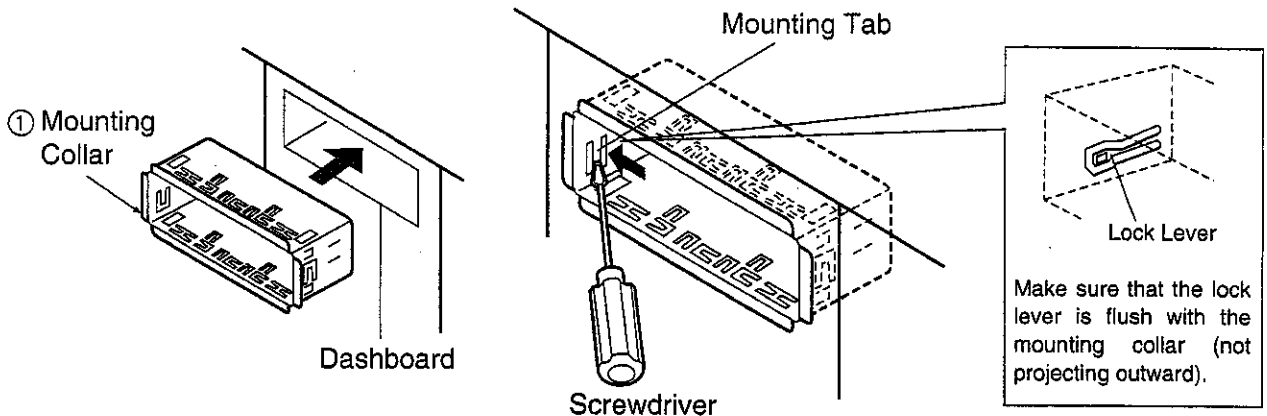

### 2. Secure the rear of the unit.

- Check the electrical connection by referring to this operating instructions.
- Connect the Mounting Bolt ⑤, using a suitable wrench.
- Insert the unit into Mounting Collar ① and push it in until "click" is heard.

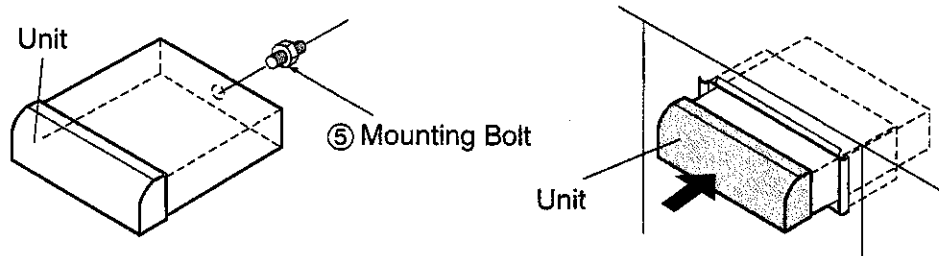

- Secure the rear of the unit to the car by either of the two recommended methods.

### ■ Using the Rear Support Strap ③

Affix one end of the Rear Support-Strap ③ to the rear of the unit, and the other end to the Fire Wall of Car, or some other metallic area.

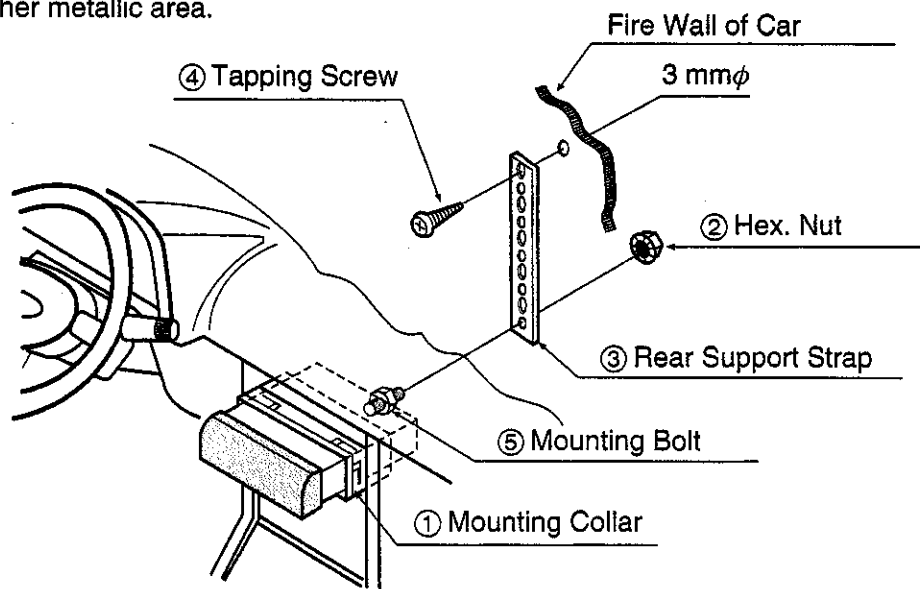

### ■ Using the Rubber Cushion (Optional)

(If there is an existing Rear Support Bracket on the Fire Wall of Car.)

Cover Mounting Bolt ⑤ on the rear of the unit with Rubber Cushion (Optional), and mount it into existing Rear Support Bracket.

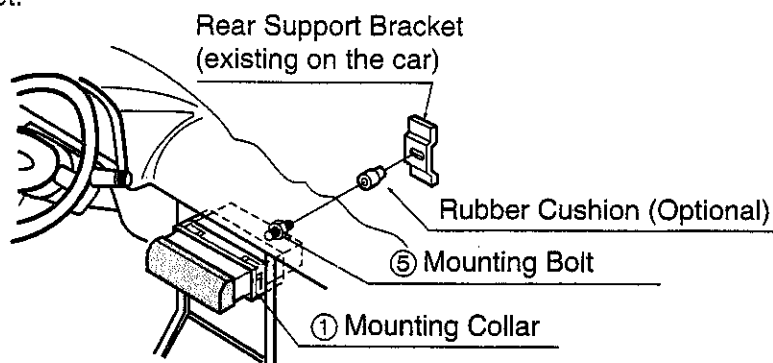

3. a) Plug the Power Connector ⑥.
- b) Install the Trim Plate ⑦.

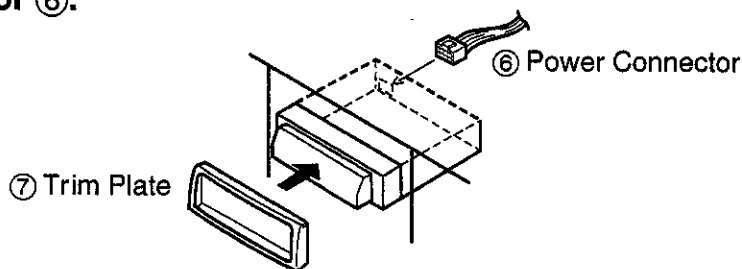

### 4. After installation reconnect the negative (-) battery terminal.

#### To Remove the Unit

- a) Remove the removable face plate. (→ Page 18.)
- b) Remove the trim plate ⑦ with a screwdriver as shown in the figure.

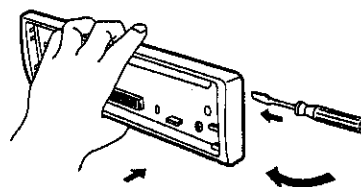

- c) Pull out the unit while pushing the lock lever using a screwdriver.
- d) Remove the unit pulling with both hands.

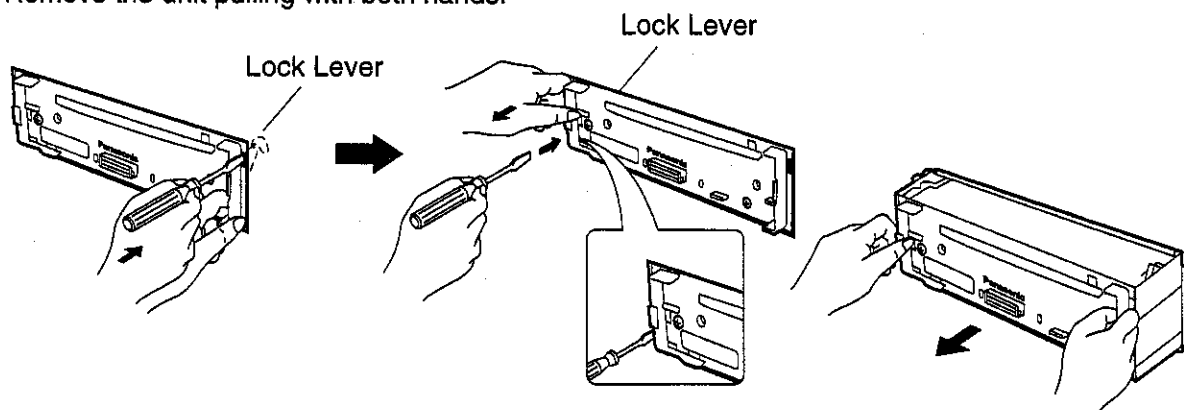

# Installation Guide (continued)

## Anti-Theft System

This unit is equipped with a removable face plate. By removing this face plate, the radio becomes totally inoperable.

### To Remove the Removable Face Plate

- ① Switch off the power.
- ② Press the release button [▲]. The removable face plate will be released. (⇒ Fig. 1)
- ③ Remove the removable face plate by pulling on the right side of the unit. (⇒ Fig. 2)

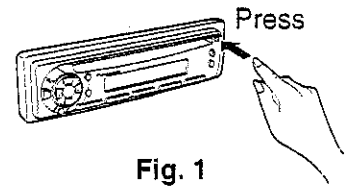

Fig. 1

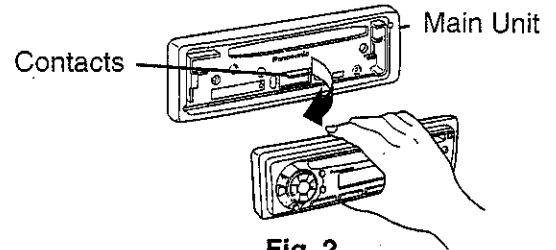

Fig. 2

### To install the Removable Face Plate

- ① Slide the left side of the removable face plate in place. (⇒ Fig. 3)
- ② Press the right end of the removable face plate until "click" is heard. (⇒ Fig. 4)

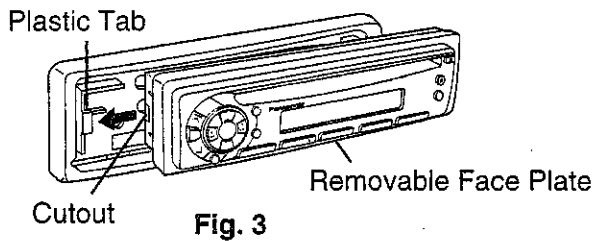

Fig. 3

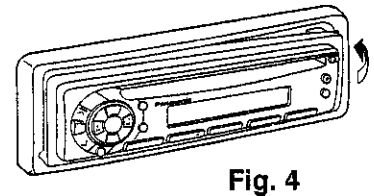

Fig. 4

**Caution:**

1. Before removing the removable face plate, make sure the power is off.
2. This removable face plate is not water-proof. Do not expose it to water or excessive moisture.
3. Do not remove the removable face plate, while driving your car.
4. Do not place the removable face plate on the dashboard or nearby areas where the temperature rises to high levels.
5. Do not touch the contacts on the removable face plate or on the main unit, since this may result in poor electrical contacts.
6. If dirt or other foreign substances get on the contacts, wipe them with a clean, dry cloth.



# Electrical Connection

**Caution:**

- To prevent damage to the unit, be sure to follow the connection diagram below.
- Remove the covering of the leads about 5 mm long from their end before connecting.
- Do not insert the power connector into the unit until the wiring is completed.
- Be sure to insulate any exposed wires from a possible short-circuit from the car chassis. Bundle all cables and keep cable terminals free from touching any metal parts.

- This unit can be connected to an optional CD changer (CX-DP801EN). For details consult your nearest Panasonic dealers.
- For connection to a CD changer, refer to the operating instructions of the CD Changer (CX-DP801EN).

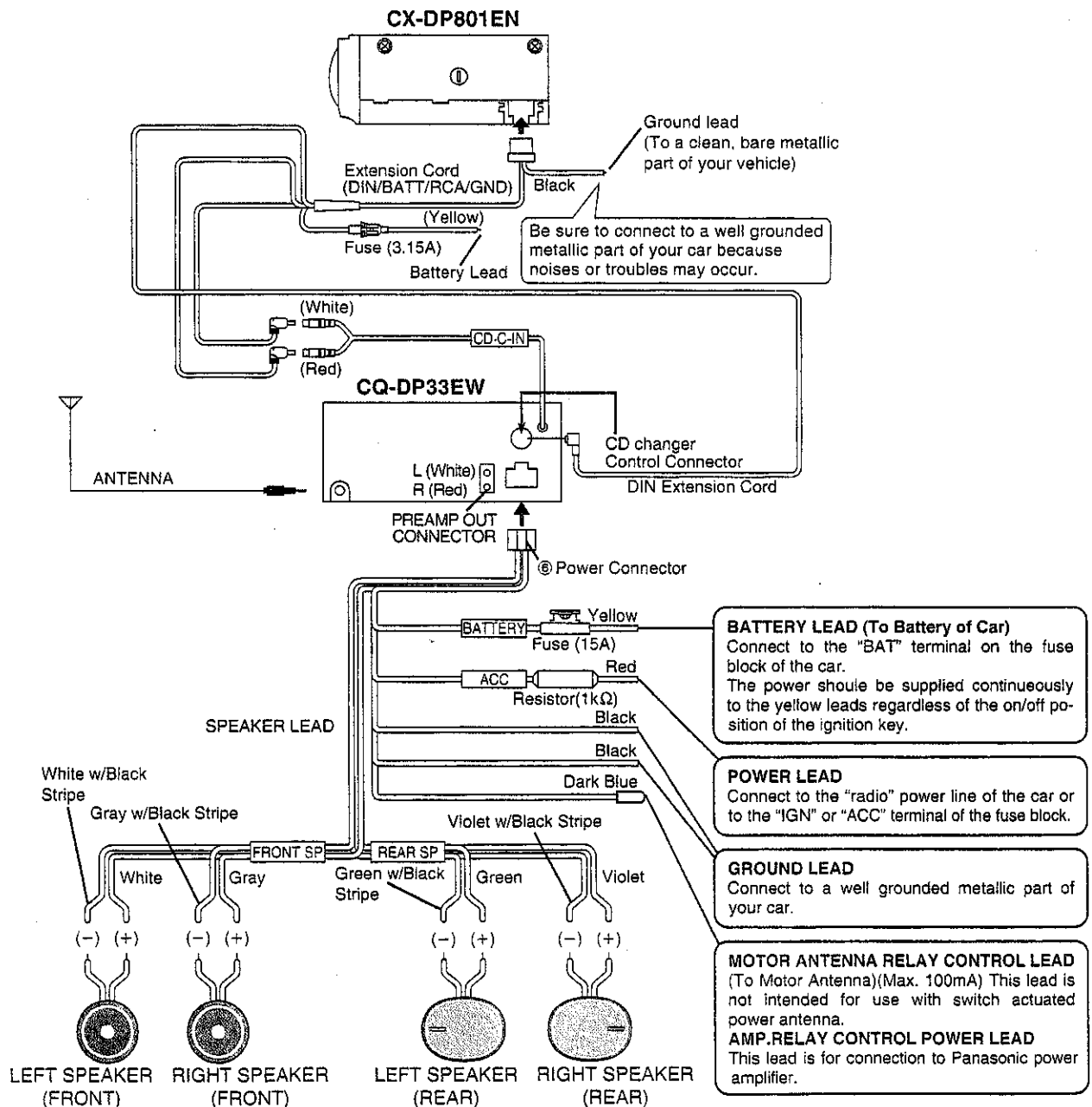

# Speaker Connections

**Caution:**

1. Use ungrounded speakers only.
2. The speakers to be used with this unit should be able to handle more than 40W of audio power. If an optional amplifier is used, the speakers should be able to handle the maximum output power of the amplifier. Use of speakers with small input ratings can cause damage to the speakers.
3. The speaker impedance should be 4-8 ohms. If the impedance is too large or too small, it affects the output and may cause damage to the speakers or this unit.
4. Do not use 3-wire type speaker system having a common earth lead. Never connect the speaker cord to the body of the car. This unit uses the BTCL circuit, so each speaker should be connected separately using parallel vinyl insulated cords.
5. The speaker cords and the power amplifier unit should be kept away (about 30cm apart) from the antenna and antenna extension cord.
6. Follow the connection diagram below carefully. Failure to do so may cause damage to both unit and speakers.

•Unit will be damaged if speakers (Front, Rear) are not connected properly.

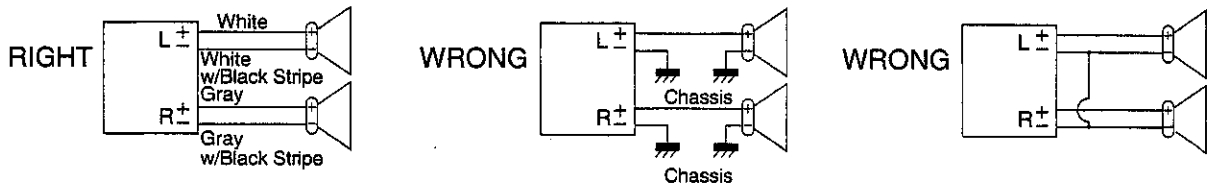

•Do not connect more than one speaker to one set of speaker leads.

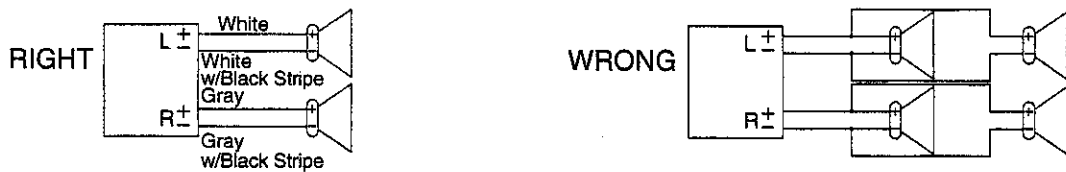

# Special Notes

## Notes on Compact Discs

ONLY USE DISCS CARRYING LABEL SHOWN ON THE RIGHT



- Dirt, dust, scratches and bending of disc will cause misoperation.
- Do not place stickers or make scratches on discs.
- Do not bend discs.
- Disc should always be kept in the case when not in use to prevent from damaging.
- Do not place discs in the following places:
  1. Direct sunlight.
  2. Dirty, dusty and damp areas.
  3. Near car heaters.
  4. Seats or dashboard.

### Disc Cleaning

Use a dry soft cloth to wipe the surface. If the disc is quite dirty, use a soft cloth slightly dampened in isopropyl (rubbing) alcohol. Never use solvents such as benzine, thinner, conventional record cleaner, or mopper as they may mar the surface of the disc.

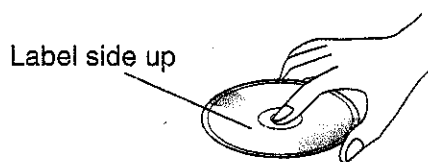

Label side up



Do not touch the underside of the disc.



Do not bend.



Wipe the disc from center to outside direction.

## Caution for use of a New Discs

A new disc may have rough edges on its inner and outer perimeter. If a disc with rough edges is used, proper setting will not be possible and the CD player will not play the disc. Therefore, remove the rough edges in advance by using a ball-point pen or pencil as shown on right. To remove the rough edges, press the side of the pen or pencil against the inner and outer perimeter of the disc.

Rough spots on outer edge

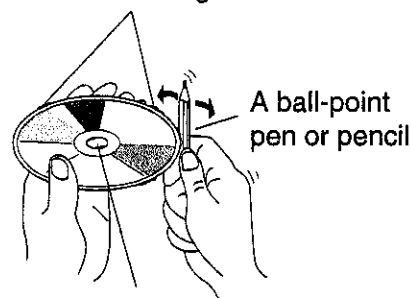

Rough spots on inner edge

## FUSE

Be sure to use a fuse of the specified rating (15A) when replacing a blown fuse. Fuses with higher capacity ratings, use of any substitute, or connection without a fuse may result in a fire hazard or damage to the unit. If the replacement fuse fails, consult your nearest authorized Panasonic Service Center.

## Maintenance

To clean the exterior of this unit, use a soft cloth to wipe the surface. Do not use benzine, thinner, or any other type of solvents.

# Specifications

## General

Power Supply	: 12 V DC (11 V–16 V), Test Voltage 14.4 V, Negative ground
Maximum Power Output	: 40 W×4 channels at 400 Hz, Volume Control maximum
Power Output	: 14W×4 (DIN 45 324, at 4Ω)
Tone Action	: Bass; ±12 dB at 100 Hz, Treble; ±12 dB at 10 kHz
Pre-Amp Output Voltage	: 2.0 V (CD Play Mode; 1 kHz 0 dB)
Output Impedance	: 600Ω
Current Consumption	: Less than 1.7 A (CD Play Mode)
Dimensions (W×H×D)	: 178(W)×50(H)×150(D) mm
Weight	: 1.4 kg

## AM Radio

Frequency Range	: 531–1,602 kHz
Useable Sensitivity	: 28 dB/μV (25 μV, S/N 20 dB)

## FM Stereo Radio

Frequency Range	: 87.5–108 MHz
Useable Sensitivity	: 6 dB/μV (S/N 30 dB)
Stereo Separation	: 42 dB at 1,000 Hz

## CD Player

Sampling Frequency	: 32 times oversampling
DA Converter	: MASH• 1 bit/4 DAC System
Error Correction System	: Panasonic Super Decoding Algorithm
Pick-Up Type	: Astigma 3-beam
Light Source	: Semiconductor laser
Wavelength	: 780 nm
Frequency Response	: 20 Hz – 20,000 Hz, ±1 dB
Signal/Noise Ratio	: 96 dB
Total Harmonic Distortion	: 0.01% (1,000 Hz)
Wow and Flutter	: Below measurable limits
Channel Separation	: 75 dB

### Note:

Specifications and design are subject to modification without notice due to improvements in technology.

## Free Manuals Download Website

<http://myh66.com>

<http://usermanuals.us>

<http://www.somanuals.com>

<http://www.4manuals.cc>

<http://www.manual-lib.com>

<http://www.404manual.com>

<http://www.luxmanual.com>

<http://aubethermostatmanual.com>

Golf course search by state

<http://golfingnear.com>

Email search by domain

<http://emailbydomain.com>

Auto manuals search

<http://auto.somanuals.com>

TV manuals search

<http://tv.somanuals.com>