

Panasonic®

Color Television Operating Instructions



CT-27SF24

Read these instructions completely before operating.
Contents subject to change without notice or obligation.



SPATIALIZER
3-D STEREO

Copyright 1997 by Matsushita Electric Corporation
of America. All rights reserved. Unauthorized
copying and distribution is a violation of law.

Printed in U.S.A.
TQB2AA0136

Safety Instructions

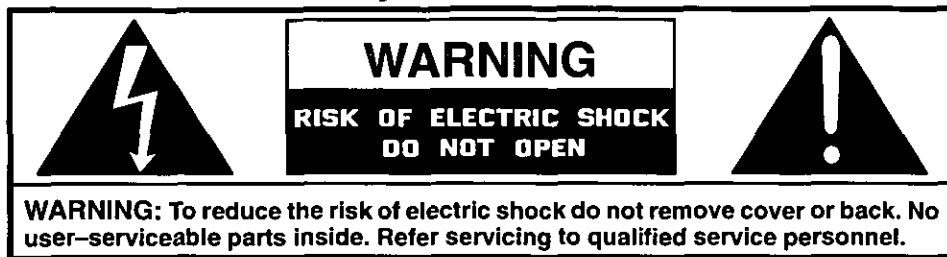

The lightning flash with arrow-head within a triangle is intended to tell the user that parts inside the product are a risk of electric shock to persons.



The exclamation point within a triangle is intended to tell the user that important operating and servicing instructions are in the papers with the appliance.

Note To CATV System Installer: This reminder is provided to call the CATV system installer's attention to Article 820-40 of the NEC that provides guidelines for proper grounding and, in particular, specifies that the cable ground shall be connected to the grounding system of the building, as close to the point of cable entry as practical.

Safety Instructions For Television Receivers

1. Read and apply the operating instructions provided with your television receiver.
2. Read all of the instructions given here and retain them for later use.
3. Unplug this television receiver from the wall outlet before cleaning. Do not use liquid or aerosol cleaners. Use a damp cloth for cleaning.
4. Do not use attachments not recommended by the television receiver manufacturer as they may cause hazards.
5. Do not use this television receiver near water. For example: Avoid placing it near a bathtub, washbowl, kitchen sink, or laundry tub, in a wet basement, or near a swimming pool, etc.
6. Do not place this television receiver on an unstable cart, stand or table. The television receiver may fall, causing serious injury to a child or adult, and serious damage to the appliance. Use only with a cart or stand recommended by the manufacturer, or sold with the television receiver. Wall or shelf mounting should follow the manufacturer's instructions, and should use a mounting kit approved by the manufacturer.
- 6A. An appliance and cart combination should be moved with care. Quick stops, excessive force, and uneven surfaces may cause the appliance and cart combination to overturn.
7. Slots and openings in the cabinet and the back or bottom are provided for ventilation, and to insure reliable operation of the television receiver and to protect it from overheating. These openings must not be blocked or covered. The openings should never be blocked by placing the television receiver on a bed, sofa, rug or other similar surface. This television receiver should never be placed near or over a radiator or heat register. This television receiver should not be placed in a built-in installation such as a bookcase unless proper ventilation is provided.
8. Operate only from the type of power source indicated on the marking label. If you are not sure of the type of power supplied to your home consult your television dealer or local power company. For television receivers designed to operate from battery power, refer to the operating instructions.
9. This television receiver is equipped with a polarized alternating-current line plug (a plug having one blade wider than the other). This plug will fit into the power outlet only one way. This is a safety feature. If you are unable to insert the plug fully into the outlet, try reversing the plug. If the plug should still fail to fit, contact your electrician to replace your obsolete outlet. Do not defeat the safety purpose of the polarized plug.
10. Do not allow anything to rest on the power cord. Do not locate this television receiver where the cord will be abused by persons walking on it.
11. Follow all warnings and instructions marked on the television receiver.
12. Do not overload wall outlets and extension cords as this can result in fire or electric shock.
13. Never push objects of any kind into this television receiver through cabinet slots as they may touch dangerous voltage points or short out parts that could result in a fire or electric shock. Never spill liquid of any kind on the television receiver.

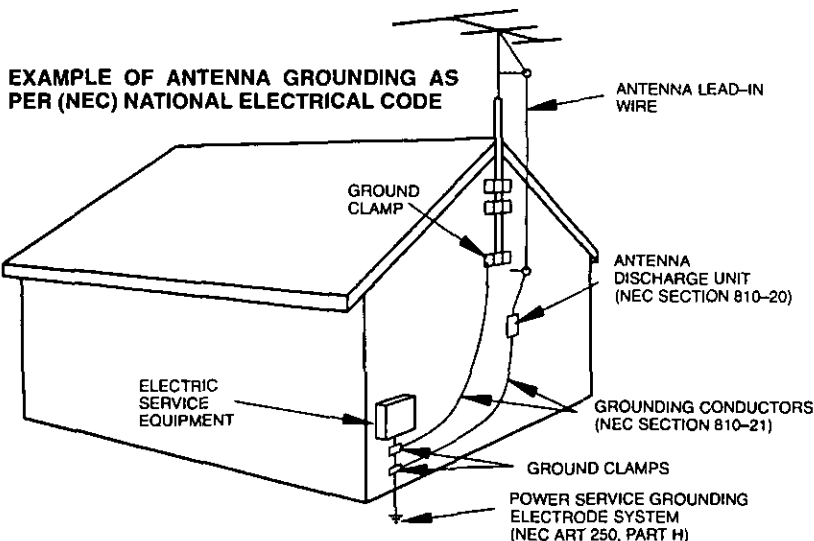

14. If an outside antenna is connected to the television equipment, be sure the antenna system is grounded so as to provide some protection against voltage surges and built up static charges. In the U.S. Section 810 of the National Electrical Code and in Canada Part 1 of the Canadian Electrical Code provides information with respect to proper grounding of the mast and supporting structure, grounding of the lead-in wire to an antenna discharge unit, size of grounding conductors, location of antenna-discharge unit, connection to grounding electrodes, and requirements for the grounding electrode. See Figure.
15. For added protection for this television receiver during a lightning storm, or when it is left unattended and unused for long periods of time, unplug it from the wall outlet and disconnect the antenna. This will prevent damage to the receiver due to lightning and power-line surges.
16. An outside antenna system should not be located in the vicinity of overhead power lines or other electric light or power circuits, or where it can fall into such power lines or circuits. When installing an outside antenna system extreme care should be taken to keep from touching such power lines or circuits as contact with them might be fatal.
17. Unplug this television receiver from the wall outlet, and refer servicing to qualified service personnel under the following conditions:
 - a. When the power cord or plug is damaged or frayed.
 - b. If liquid has been spilled into the television receiver.
 - c. If the television receiver has been exposed to rain or water.
 - d. If the television receiver does not operate normally by following the operating instructions. Adjust only those controls that are covered by the operating instructions as improper adjustment of other controls may result in damage and will often require extensive work by a qualified technician to restore the television receiver to normal operation.
 - e. If the television receiver has been dropped or the cabinet has been damaged.
 - f. When the television receiver exhibits a distinct change in performance – this indicates a need for service.
18. Do not attempt to service this television receiver yourself as opening or removing covers may expose you to dangerous voltage or other hazards. Refer all servicing to qualified service personnel.
19. When replacement parts are required, be sure the service technician has used replacement parts specified by the manufacturer that have the same characteristics as the original part. Unauthorized substitutions may result in fire, electric shock, or other hazards.
20. Upon completion of any service or repairs to this television receiver, ask the service technician to perform routine safety checks to determine that the television is in safe operating condition.
21. **WARNING: To prevent fire or shock hazard, do not expose this appliance to rain or moisture.**
22. **CAUTION: TO PREVENT ELECTRIC SHOCK DO NOT USE THIS (POLARIZED) PLUG WITH A RECEPTACLE OR OTHER OUTLET UNLESS THE BLADES CAN BE FULLY INSERTED TO PREVENT BLADE EXPOSURE.**

NOTE: This equipment is designed to operate in the U.S.A., Canada and other countries where the broadcasting system and AC house current is exactly the same as in the U.S.A. and Canada.

Important Information Regarding Use of Video Games, Computers, Teletext or Other Fixed Image Displays.

The extended use of fixed image program material can cause a permanent “shadow image” on the picture tube. This background image is viewable on normal programs in the form of a stationary fixed image. This type of irreversible picture tube deterioration can be limited by observing the following steps:

- A. Reduce the brightness/contrast setting to a minimum viewing level.
- B. Do not display the fixed image for extended periods of time.
- C. Turn the power off when not in actual use.

NOTE: The marking or retained image on the picture tube resulting from fixed image use is not an operating defect and as such is not covered by Warranty. This product is not designed to display fixed image patterns for extended periods of time.

Specifications

- Power Source:** 120V AC, 60Hz
- Channel Capability:** 181 channels (See chart)
VHF 2-13, UHF 14-69, Cable 125 channels
- Video Input Jacks (3):** 1V p-p, 75 ohm, phono jack type
- Audio Input Jacks (3):** 500mV rms, 47K ohm
- To Audio AMP Jacks:** 0-2.0V rms 4.7K ohm
- S-VHS Input Jack (2):** S-Video (Y-C) Connector
- Stereo Sound**
- Spatializer Surround Sound**
- Closed Caption Display**
- Picture In Picture:** 1 Tuner

Channel Capability Chart

BAND	CHANNELS
VHF	12
UHF	56
CABLE (Mid-Band)	15
CABLE (Super Band)	14
CABLE (Hyper Band)	28
CABLE (Ultra Band)	56
TOTAL CHANNELS	181

Specifications are subject to change without notice or obligation.

Introduction

Congratulations on Your New Purchase

Your new video component features an all solid state chassis which is designed to give you many years of enjoyment. It was thoroughly tested and adjusted at the factory for best performance.

In order for you to take full advantage of your new video component, please read and follow the installation and operating instructions supplied with this product.

Customer's Record

The model and serial number of this product may be found on its back cover. You should note the model and serial number in the space provided and retain this book as a permanent record of your purchase to aid in identification in the event of theft or loss.

Model Number: _____ Serial Number: _____

Table of Contents

Safety Instructions	2	Auto Color	18
Specifications	3	Video NR	18
Introduction	4	Audio Adjustments	
Installation		Audio Norm	19
Television Location	6	Bass, Treble and Balance	19
Optional External Equipment Connections	6	Mode – Stereo/SAP/Mono	19
AC Power Supply Cord	6	Speaker [TV]	20
Remote Control Battery Installation	6	Spatializer	20
Antenna/Cable Connections	7	AI Sound	20
Other Video Equipment	7	Input Select	
Care & Cleaning	7	Main (Picture) Input Selection	21
Optional Equipment Connection and Operation		PIP (Picture in Picture) Input Selection	21
Stereo Connection (To Audio AMP)	8	Timer Features	
Video/Audio Connection	8	Sleep Timer	21
S-Video Connection	9	Program Timer	21
PIP External Video & Antenna Connections	9	Lockout Features	
PIP External Video & Antenna Connections		Lockout Mode	22
Using Cable Box	10	Unlock	24
Location of Controls		Favorite Channel Features	
Location of Control for Television	11	Channel Scan	24
Quick Reference Control Operation	11	Favorite Channel Select	25
Basic Remote Control Functions for		Channel Caption Features	
Television Operation	12	Preset Caption	25
Remote Control Quick Reference Functional		Manual Caption	26
Key Chart	13	Set Up Features	
Special Functions		Clock (Auto)	26
Recall Button	15	Clock (Manual)	28
R-Tune (Rapid Tune) Button	15	Set Day	28
Multi Button	15	Mode (TV or Cable)	28
PIP (Picture in Picture) Button	16	Auto Programming	29
PIP Swap Button	16	Manual Programming	29
PIP Size Button	16	Auto Power On	30
PIP Freeze Button	16	Closed Caption with Mute Button	30
PIP Move Button	16	Closed Caption Mode	30
Main Menu (Trilingual Animated Icons)		Programming the Illuminated Remote Control	
Language Menu	17	Using Access Codes	31
Picture Adjustments	17	VCR Infrared Codes Index	32
Picture Norm	17	Cable Box and CD Players	
Color, Tint, Brightness, Picture and		Infrared Codes Index	33
Sharpness Adjustments	17	Cassette Deck, AV Receivers, and Amplifiers	
Color Temp (Temperature)	18	Infrared Codes Index	34
		Laser Disc, DSS, and DVD	
		Infrared Codes Index	35
		Troubleshooting Chart	36

Installation

Television Location

This television is intended to be used with an optional stand or entertainment center. Consult your dealer for available options. Locate for comfortable viewing. Avoid placing where sunlight or other bright light (including reflections) will fall on the screen. Use of some types of fluorescent lighting may reduce remote control transmitter range. Adequate ventilation is essential to prevent internal component failure. Keep away from areas of excessive heat or moisture. To insure optimum color purity do not position equipment containing magnets (motors, fans, external speakers, etc.) nearby.

Optional External Equipment Connections

The Video/Audio connections between components can be made with shielded video and audio cables. For best performance, video cables should be of 75 ohm type coaxial shielded cables. Cables are available from your dealer or electronic supply house.

Before you purchase any cables, check out the type of output and input connectors your various components require. Also determine the length of cable you will need.

AC Power Supply Cord

CAUTION: TO PREVENT ELECTRIC SHOCK, MATCH WIDE BLADE OF PLUG TO WIDE SLOT OF AC OUTLET AND FULLY INSERT. DO NOT USE THIS (POLARIZED) PLUG WITH A RECEPTACLE OR OTHER OUTLET UNLESS THE BLADES CAN BE FULLY INSERTED TO PREVENT BLADE EXPOSURE.

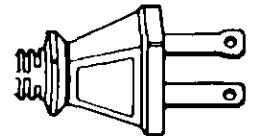

Polarized Plug

Remote Control Battery Installation

Batteries: Use two "AA" batteries.

1. Remove the battery compartment cover on back of the remote.
2. Install the batteries in the battery compartment. (Polarity (+) or (-) must be correct.)
3. Reattach the battery cover.

Helpful Hints:

For frequent Remote Control users, replace old batteries with Alkaline batteries for longer life.

Precaution on Battery Use

Incorrect installation can cause battery leakage and corrosion that will damage the Remote Control.

Observe the Following Precautions:

1. Batteries must be replaced as a pair.
2. Do not combine a used battery with a new one.
3. Do not mix battery types (Example: "Zinc Carbon" with "Alkaline").
4. Do not attempt to charge, short-circuit, disassemble, heat or burn used batteries.
5. Battery replacement is necessary when Remote Control reacts sporadically or stops operating the television.

Note: In order to maximize the life of the batteries, the lighted buttons on the Remote Control can be turned OFF and ON by pressing R-TUNE and RECALL simultaneously.

Helpful Hints:

Whenever you remove the batteries to replace them, you may need to reset the Remote Control Infrared Codes. We recommend that you initially record the codes in the Infrared Remote Codes for Specific Components section, prior to setting up the remote.

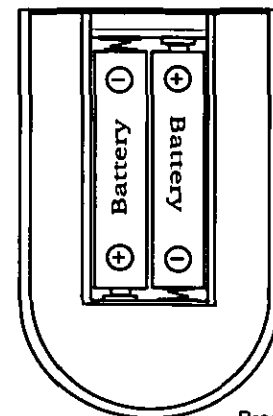

Press Down Here and Slide Cover Back

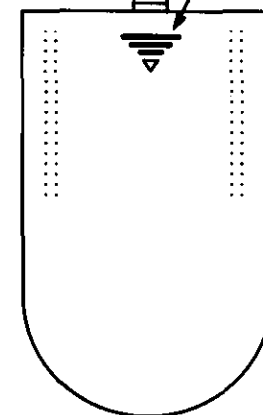

Installation (Cont.)

Antenna/Cable Connections

Antenna Connection – For proper reception of VHF/UHF channels, an external antenna is required. For best reception, an outdoor antenna is recommended. In the **SETUP** menu, set the **MODE** to **TV**. (Refer to Antenna Mode section.)

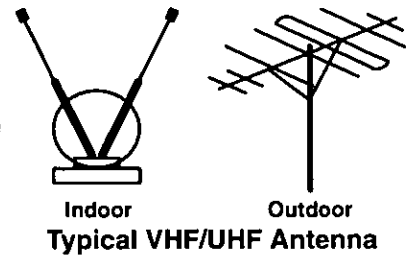

Incoming Cable from Home Antenna

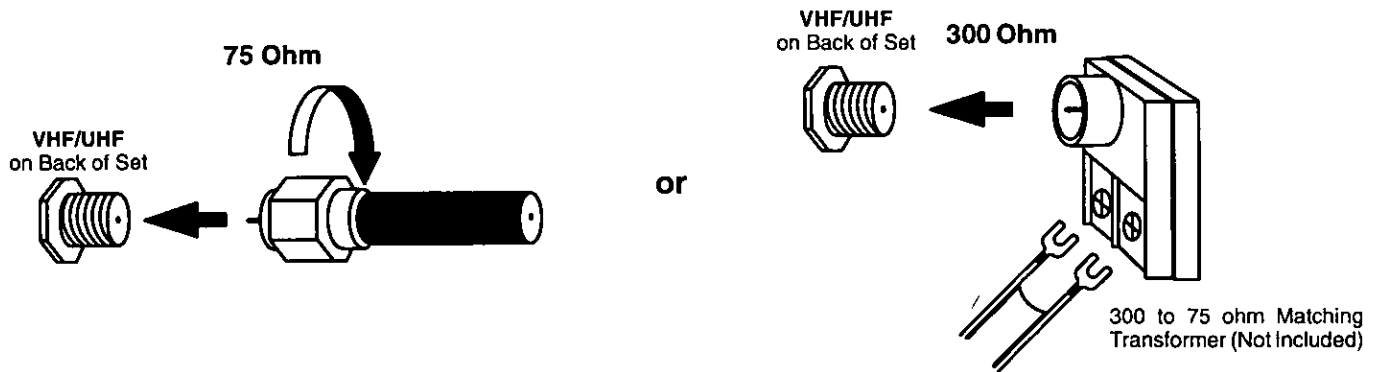

Cable Connection – For reception of cable channels, connect the cable supplied by your local cable company. In the **SETUP** menu, set the **MODE** to **CABLE**. (Refer to Antenna Mode section.)

Incoming Cable from Cable Company

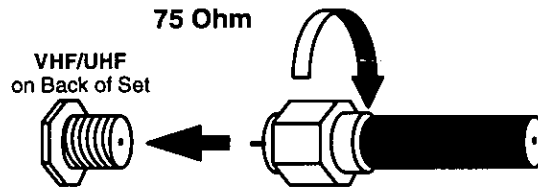

NOTE: Certain cable systems offset some channels to reduce interference, or have premium (scrambled) channels. A cable converter box is required for proper reception. Check with your local Cable company for compatibility requirements.

Other Video Equipment

VCRs, Video Disc Players, Computers, TV games, and DSS equipment can also be connected to the antenna input connection.

Care and Cleaning

Picture Tube (Turn television off)

Use a mild soap solution or window cleaner and a clean cloth. **DO NOT USE ABRASIVE CLEANERS.** Avoid excessive moisture and wipe dry.

Plastic Cabinet

Wipe the cabinet with a soft cloth dampened with water or a mild detergent solution and wipe dry with a soft clean cloth. Avoid excessive moisture. Do not use benzene, thinners or other petroleum based cleaners.

Wood Cabinet

When dusting or polishing the cabinet, use a clean soft cloth and stroke straight with the grain. An occasional coat of furniture polish will help preserve the finish. Do not use benzene, thinners or other petroleum based cleaners. Do not place objects made of plastic or rubber directly on top of the cabinet. A chemical reaction could result causing permanent marring of the finish.

Remote Control Transmitter

Use a soft cloth slightly moistened with a mild detergent and then wipe dry with a soft clean cloth. Avoid excessive moisture. Do not use benzene, thinners or other petroleum based cleaners.

Optional Equipment Connection and Operation

To Audio AMP Connection (Stereo)

Connect to an external audio amp auxiliary input for monitoring sound through a stereo system.

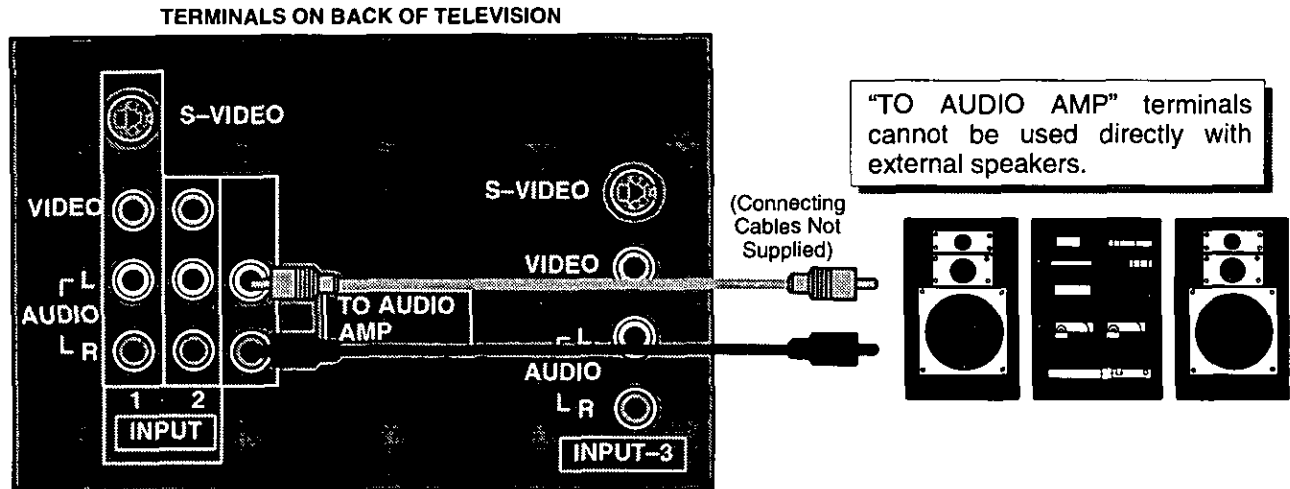

Adjustment – When an audio amp is connected to "TO AUDIO AMP" terminals:

1. Select TV SPEAKERS "ON" Mode. (Refer to the Audio Menu TV Speakers section.)
2. Set volume of audio amp to near minimum.
3. Adjust volume of TV to desired listening level.
4. Adjust volume of audio amp to match the level of TV.
5. Select TV SPEAKERS "OFF&VAO" Mode. (Refer to the Audio Menu TV Speakers section.)
6. Audio bass, treble, balance, volume and mute can now be controlled by the TV Remote Control.

NOTE: When Selecting TV SPEAKERS "OFF&FAO" Mode, the TV sound output is always at a constant level and cannot be changed (Refer to the Audio Menu TV Speakers section).

Audio/Video Input Connection

S-Video connection is optional and overrides the standard Video connection when connected.

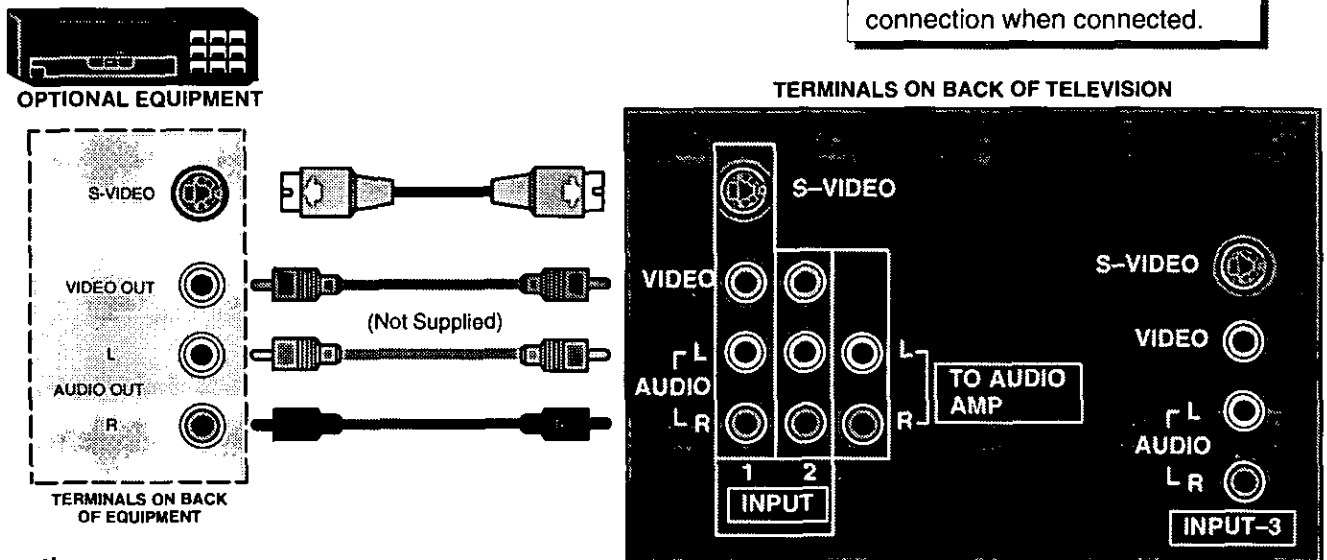

Operation

1. Connect optional equipment as shown to INPUT 1, 2 or 3 terminals. (Additional INPUT 3 terminals are located on the front of the television behind the door. Make sure that the INPUT 3 FRONT/REAR switch located behind the front door is set properly.) If S-Video is to be used, connect S-Video (YC) connector to S-Video terminal and connect audio cables to L & R Audio INPUT 1 or INPUT-3 terminals.
2. Select the desired Video mode by pressing the TV/VIDEO button.
3. Operate optional equipment (VCR-VDP) as instructed in Optional Equipment manual.

NOTE:

- You must select the proper VIDEO Input Mode where the equipment is connected.
- Connection of optional S-VIDEO jack automatically disconnects the Normal Video Input 1 or 3 jacks.

S-Video Connection

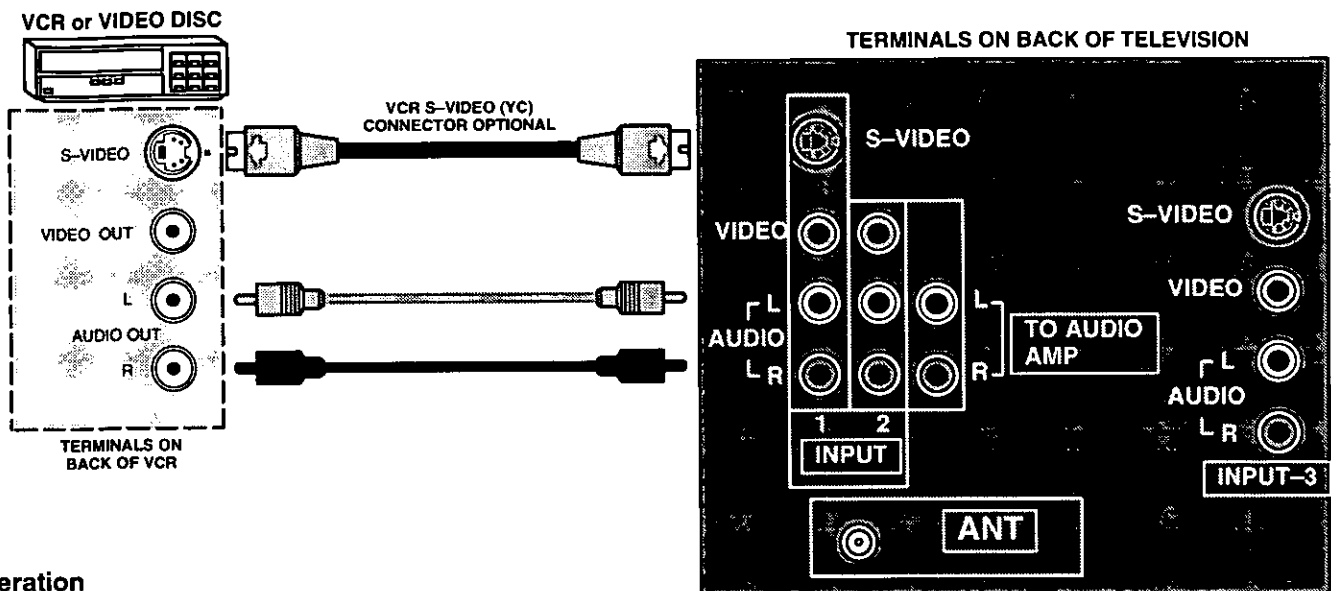

Operation

1. Connect S-Video (YC) connector to S-Video Terminals INPUT 1 or INPUT-3 (rear of television).
2. Connect the L and R Audio Input jacks. Use the terminal jacks located directly below the S-Video jack used.
3. When using the INPUT-3 jack, verify that the switch located behind the front door is set to REAR (unpressed).
4. Select Video1 mode by pressing the TV/VIDEO button (or refer to the Input Select Menu).
5. Operate optional equipment (VCR-VDP) as instructed in Optional Equipment manual.

NOTE:

- You must select the proper VIDEO Input Mode where the equipment is connected.
- Plugging into the optional S-VIDEO jack automatically disconnects the Normal Video Input 1 or Input 3 jacks.

Picture in Picture External Video and Antenna Connection

This television has the "PICTURE IN PICTURE" feature. For the proper operation of this feature a second video source is required (such as a VCR). We recommend that you make your antenna and External Video connection as shown below when a second video source is available.

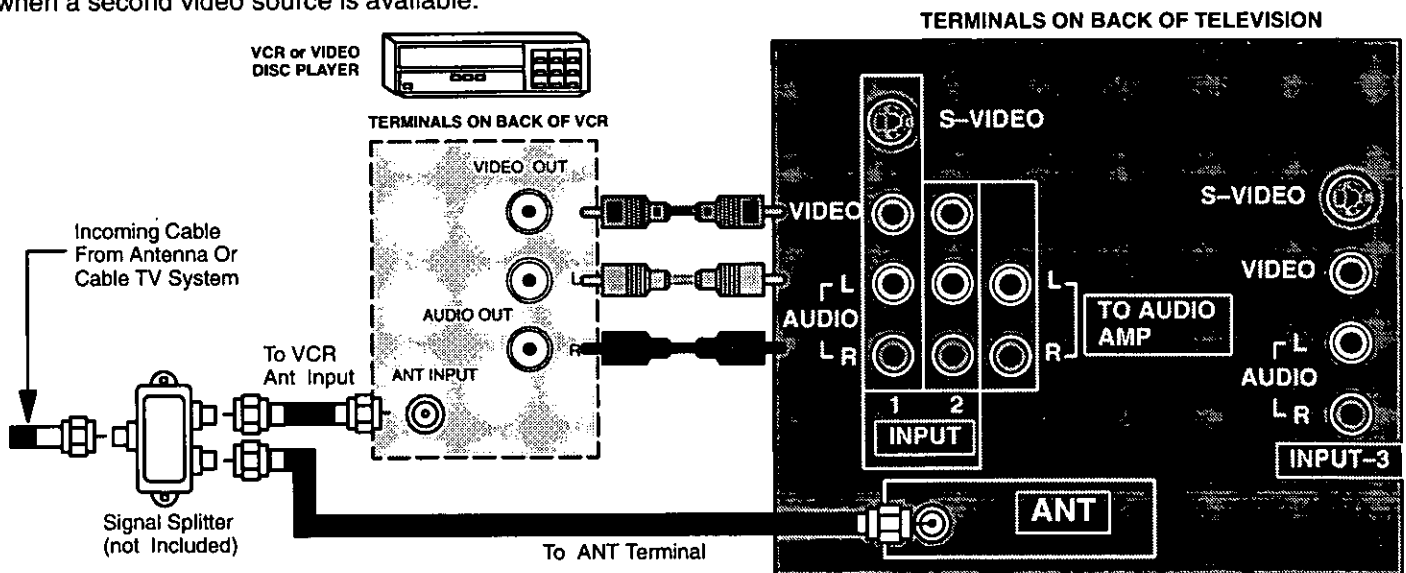

Helpful Hints:

- The PIP will operate using Audio/Video input terminals 1, 2 or 3 (additional input 3 is located on front of television).
- Use the TV/VIDEO button (when the PIP frame is displayed) to select proper mode.
- The PIP feature will operate using S-Video input terminal 1.

Picture in Picture and External Video and Antenna Connection (Optional Connection, Using Cable Box)

This television has the "PICTURE IN PICTURE" feature. For the proper operation of this feature a second video source is required (such as a VCR). We recommend that you make your antenna and External Video connection as shown below when a second video source is available.

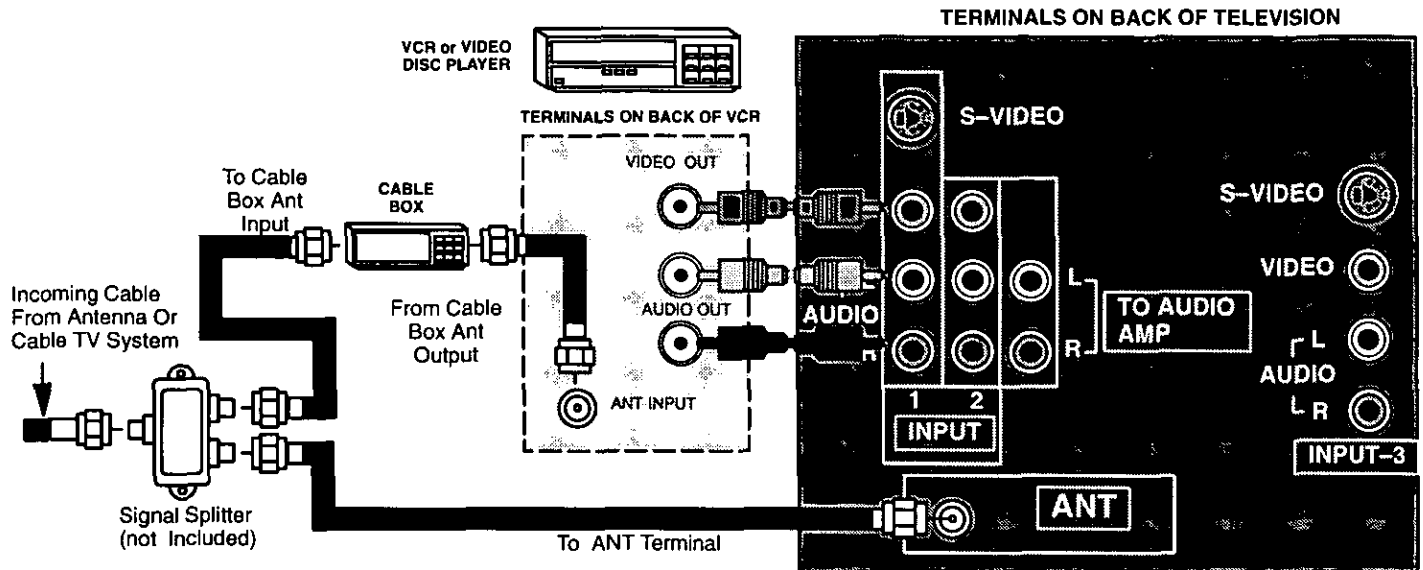

NOTE:

- Set your television to channel 3 or channel 4, as specified by your Cable Box manual.
- You must select the proper VIDEO Input Mode where the equipment is connected.
- Plugging into the optional S-VIDEO jack automatically disconnects the Normal Video Input 1 or Input 3 jacks.
- Select VIDEO for the PIP frame and ANT for the main picture, or vice versa.
- Use the Cable Box for channel selection.

Helpful Hints:

The PIP will operate using Audio/Video input terminals 1, 2 or 3 (additional input 3 is located on front of television). Use the TV/VIDEO button (when the PIP frame is displayed) to select proper mode. The PIP feature will operate using S-Video input terminal 1.

Location of Controls

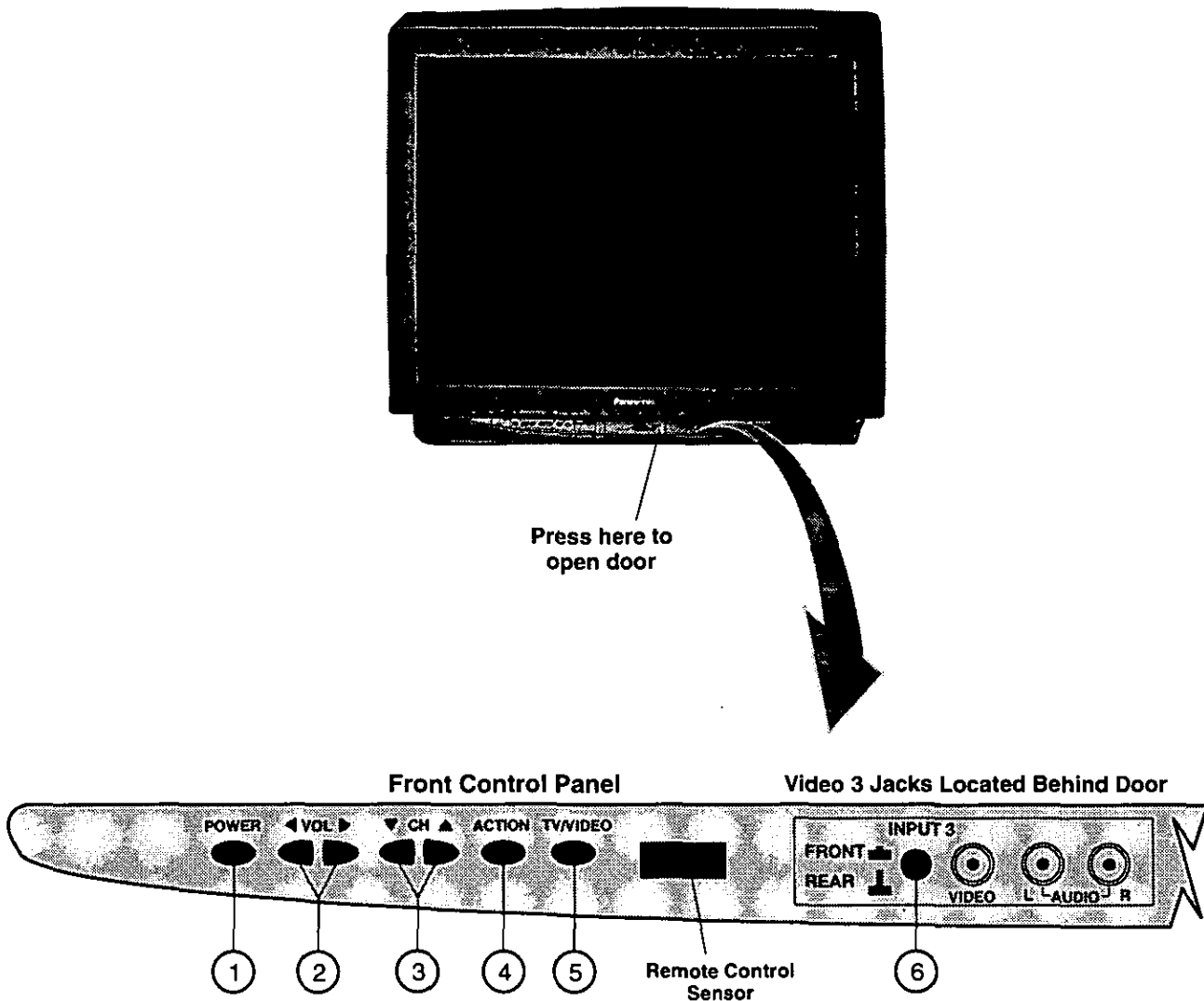

Quick Reference Control Operation

- ① **Power Button** – Press to turn television ON or OFF.
- ② **Volume Buttons** – Press to adjust Sound Level, Audio and Video Menus and to select operating features when menus are displayed.
- ③ **Channel Buttons** – Press to select programmed channels or to highlight desired features when menus are displayed.
- ④ **Action Button** – Press to display Main Menu and access or exit On Screen feature and Adjustment Menus.
- ⑤ **TV/Video Button** – Press to select TV or one of three Video Inputs, for the Main Picture or the PIP frame (when PIP frame is displayed).
- ⑥ **Front/Rear INPUT 3 Selection Switch** – Use to set the source of INPUT 3 (INPUT 3 can receive signal from either the front or the rear jacks)

Basic Remote Control Functions For Television Operation

The following is an overview of the Remote Control unit for television operation. Ensure the TV mode is selected by initially pressing . Please refer to the indicated pages for additional information.

Multi Button

Programmable to operate up to six Remote Function buttons simultaneously.

Power Button

Press to turn the TV ON or OFF.

Mode Selection Buttons

Select the operation mode for the remote control.

Volume Buttons

Press to adjust TV sound level. Use with Channel buttons to navigate in menus.

Action Button

Press to display Main Menu and enter or exit On Screen feature and Adjustment Menus.

R-Tune (Rapid Tune) Button

Press to switch to the previously viewed channel.

PIP Move Button

Press to position PIP frame to any corner of the Main Picture (when PIP frame is displayed).

PIP Freeze Button

Press to stop action in the Main Picture or PIP frame (when the PIP frame is displayed).

PIP Size Button

Press to select size of PIP frame (when the PIP frame is displayed).

To prolong the life of the batteries, the illumination of the keys can be toggled ON and OFF by pressing the R-TUNE and the RECALL buttons simultaneously.

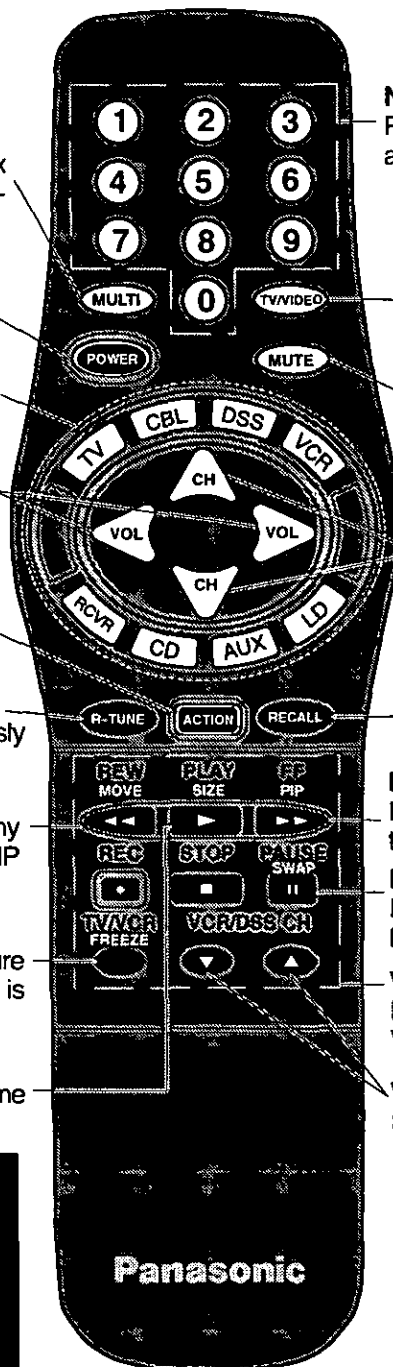

Numeric Keypad ("0 through 9" Buttons)

Press desired channel number to randomly access any channel.

TV/Video Button

Press to select TV or one of various Video Inputs, for the Main Picture or the PIP frame (when the PIP frame is displayed).

Mute Button

Press to mute sound. A second press resumes sound.

Channel Buttons

Press to select channels. Use with Volume buttons to navigate in menus.

Recall Button

Press to display Time, status of Sleep Timer, Channel, Video Mode, Channel Caption (Station Identifier) and Audio Mode.

PIP (Picture In Picture) Button

Press to display the PIP frame, press again to remove PIP frame.

PIP Swap Button

Press to interchange PIP frame with Main Picture (when the PIP frame is displayed).

VCR Function Buttons

Programmable to operate many brands of VCRs.

VCR/DSS Channel Buttons

Select VCR or DSS Up/Down channels.

Home Theater Remote Control
EUR511060

Helpful Hints:











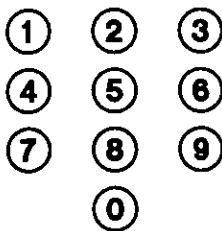











If the selected component does not respond to the remote control, ensure that the proper mode is selected. **First**, press the **Mode Selection Button** that corresponds to that component. For example, after first pressing the TV Mode Button, the remote will remain in the TV mode for the following commands. If a different mode button is pressed while operating the television, the TV mode button must be pressed again to enable the TV mode control.

NOTE:

For additional information on the Remote Control, please refer to the Remote Control Quick Reference Functional Key Chart.











Remote Control

Quick Reference Functional Key Chart

KEY	MODE	FUNCTION
	TV VCR, VCR 2 CABLE, DSS	Selects Channel Selects Channel Selects Channel
	RECEIVER/AMPLIFIER	 Selects Tuner  Selects CD Player  Selects Tape Cassette Player  VCR 1 / VIDEO 1  VCR 2 / VIDEO 2  VCR 3 / VIDEO 3
	CD PLAYER	Selects Track Number
	LD PLAYER	Selects Track Number
	ALL COMPONENTS	Programmable Button That Can Operate Up To Six (6) Remote Functions At Once
	TV	Selects the TV Input Mode
	ALL COMPONENTS	Turns On and Off Selected Components
	TV, DSS, VCR, VCR 2 LDP CABLE RECEIVER/AMPLIFIER	Mutes TV Audio Mutes Audio Mutes Audio
	TV	TV Mode Selection for Remote Control
	CABLE	Cable Mode Selection for Remote Control
	DSS (DIGITAL SATELLITE SYSTEM)	DSS Mode Selection for Remote Control
	VCR	VCR Mode Selection for Remote Control
	RECEIVER/AMPLIFIER	Receiver/Amplifier Mode Selection for Remote Control
	COMPACT DISC	CD Mode Selection for Remote Control
	CASSETTE PLAYER, VCR 2, DVD	AUX Mode Selection for Remote Control Enables User to Operate a Tape Cassette Player, Digital Video Disc or Second VCR
	LASER DISC PLAYER	LD Mode Selection for Remote Control
 	TV CABLE DSS LDP CD RECEIVER/AMPLIFIER DVD	Channel Up/Down, Menu Navigation Channel Up/Down DSS Guides and Menu Navigation Skip FF, REW Preset or Tuning Frequency Skip FWD/Skip REW
 	TV CABLE DSS RECEIVER/AMPLIFIER VCR, VCR 2 LDP	Volume Up/Down, Menu Navigation Volume Up/Down DSS Guides and Menu Navigation, Also Switches Between Normal Audio and SAP Volume Up/Down TV Volume Up/Down TV Volume Up/Down

Remote Control

Quick Reference Functional Key Chart (Cont.)

KEY	MODE	FUNCTION
	LDP TV CABLE VCR, VCR 2 DSS RECEIVER/AMPLIFIER CD TAPE CASSETTE PLAYER	Side A/B Switches Between Two (2) Channels Switches Between Two (2) Channels Switches Between Two (2) Channels Switches Between Two (2) Channels Switches between AM and FM Selects Next Disc Selects Tape Cassette Player A or B
	TV DSS	Activates TV Menus Acts as Menu Button for DSS
	TV DSS VCR, VCR 2 LDP	Displays Channel, Sleep Time, Channel Caption, Time, and Audio Mode Displays Current DSS Settings Displays Current VCR Settings Displays Current LDP Settings
	TV DSS VCR, VCR 2 LDP TAPE CD DVD	PIP Move DSS Guide Rewind Rewind Rewind Selects Previous Track Rewind
	TV DSS VCR, VCR 2 LDP TAPE CD DVD	PIP Size Enter/Select Play Play Play (in Normal Direction) Play Play
	TV DSS VCR, VCR 2 LDP TAPE CD DVD	PIP On/Off Exit/Clear Fast Forward Fast Forward Fast Forward Selects Next Track Fast Forward
	DSS VCR, VCR 2 TAPE CABLE	One Touch Record in DSS Mode Record Record VCR Record
	DVD VCR, VCR 2 LDP TAPE CD CABLE	Stop Stop Stop Stop Stop VCR Stop
	DVD TV VCR, VCR 2 LDP TAPE CD CABLE	Pause PIP Swap Pause Pause Pause Pause VCR Pause
	TV VCR, VCR 2 DSS CABLE	PIP Freeze Selects TV/VCR Mode Selects TV/DSS Mode Selects TV/VCR Mode
	VCR, VCR 2 DSS	Channel Up/Down Channel Up/Down

Special Functions

Recall Button

Press the RECALL button to review:

- ① Audio Mode status
- ② CH number or Video Input selected
- ③ Channel Caption (Station Identifier)
- ④ Clock time
- ⑤ Sleep Timer status

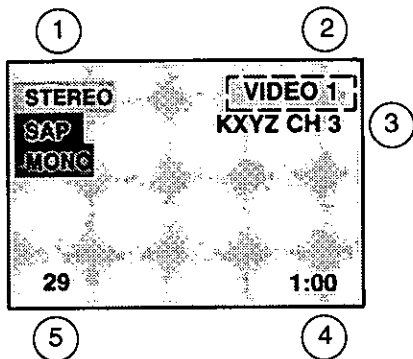

R-Tune Button

Pressing the R-TUNE (RAPID TUNE) button toggles to the previously tuned program.

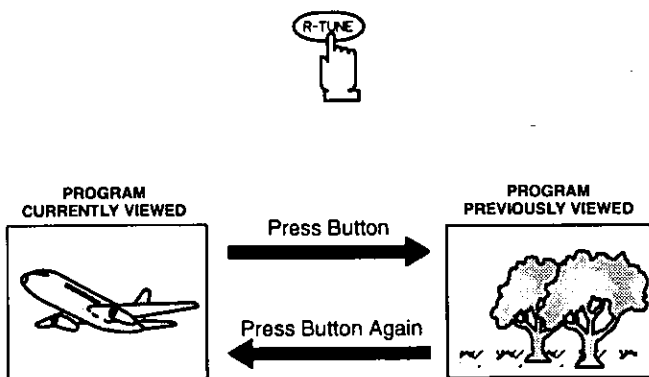

Multi Button

The MULTI button can be programmed to operate up to six (6) remote function buttons at the same time. For Example: TV Power/On, VCR Power/On, and Cable Box Power/On (selected brands) can be operated at the same time with one press of the MULTI button. (The VCR Mode button should be programmed before starting procedure).

Procedure

1. Program the Remote for the selected device Infrared access code. Confirm that the Remote Control is compatible with the device.
2. Face the Remote Control transmitter away from all equipment remote sensors.
3. Press and hold the Remote Control POWER button, then press and hold the ACTION button down simultaneously for three seconds. (All previous commands are erased.)

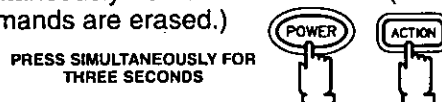

4. After three seconds, release the POWER and ACTION buttons.
5. Press the MULTI button. (Waiting more than 30 seconds without pressing another button will exit the programming mode.)
6. Press a maximum of six (6) function buttons on the Remote Control.

Each button pressed is equal to one function. If six (6) Remote button functions are entered, all will register in the MULTI button memory in the sequence entered. When finished, press the MULTI button to exit the programming mode.

The following is an example flow chart of remote functions that can be programmed into the MULTI button.

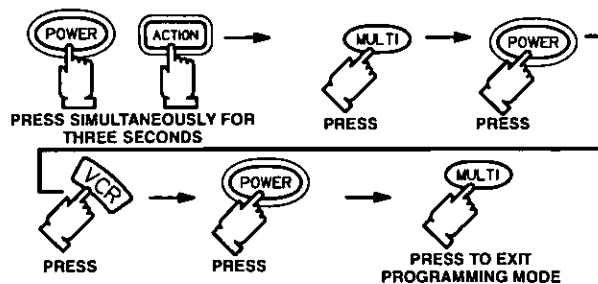

You can now turn the TV and VCR ON/OFF at the same time with one press of the MULTI button.

To delete entered functions – Press and hold the Remote Control POWER button, then press and hold the ACTION button down at the same time for three seconds. You can now enter from one to six different Remote functions.

Note: You can also program the MULTI button to perform most individual Remote Control button functions. Buttons which continuously perform a function as long as pressed (Volume Up/Down, Channel Up/Down, etc.) cannot be programmed; only those buttons which perform a function when initially pressed (Power On/Off, Mute, Direct Channel Entry, etc.) can be programmed.

Helpful Hints:

Press the TV Mode Selection button to operate TV Remote functions, if necessary.

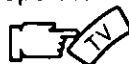

Special Functions

PIP (Picture in Picture) Button

This feature allows viewing one channel program while monitoring another. The monitored source (PIP) must be a different video source (such as a VCR) when connected to the input jacks.

- S-Video connection will also operate the PIP feature (refer to OPTIONAL S-VIDEO VHS CONNECTION section)
- When the Main Picture is in Video mode with no signal, the PIP will not operate properly.

PIP Operation

1. Turn VCR ON and select a desired channel.

2. Press  to operate TV Remote functions, if necessary.

3. Press  (set must be ON). The PIP frame will appear at the position it was last displayed. The Main Picture Video Source and PIP Video Source will display on screen momentarily. Audio will be that of Main Picture.

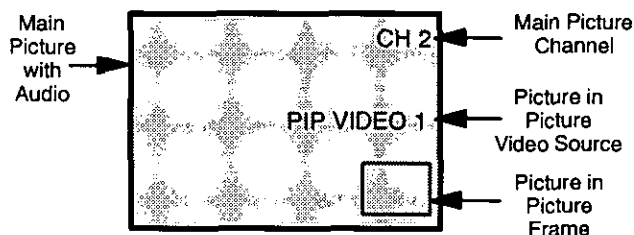

4. Press  again to cancel PICTURE IN PICTURE feature (if desired).

Note: For PIP Video source connection, refer to the PIP EXTERNAL VIDEO AND ANTENNA CONNECTIONS section.

Swap Button

Press  (when the PIP frame is displayed) to interchange what is being viewed on the Main Picture with that of the PIP frame.

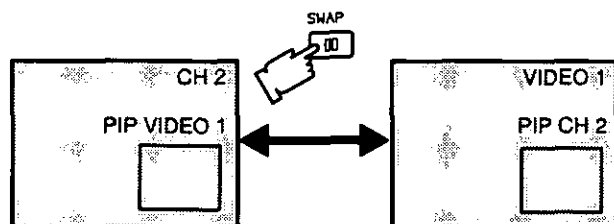

Note: Audio will be that of Main Picture.

Size Button

Press  (when the PIP frame is displayed) to choose either the large or small PIP frame.

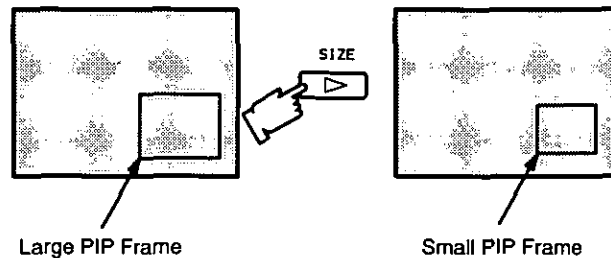

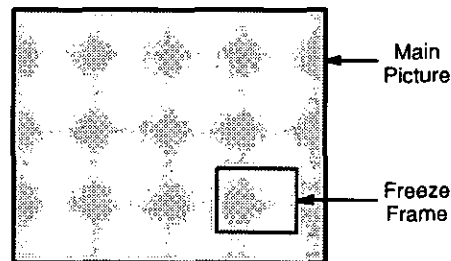

Freeze Button

Press  to stop action in the PIP frame.





Notes:

- Pressing  when the PIP frame is not displayed, will display a snapshot image of the main picture in the PIP frame.
- Pressing  when PIP frame is displayed, will stop action in the PIP frame. Press the FREEZE button again to continue action.
- Press  to remove PIP frame.

Move Button

The PIP frame may be placed at any corner of the Main

Picture by pressing the  PIP MOVE button (when the PIP frame is displayed).

Note: Each time  is pressed (when the PIP frame is displayed), the PIP frame will move counterclockwise as illustrated.

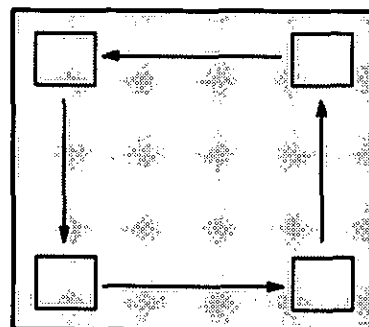

Main Menu

(Trilingual Animated Icons)

The MAIN MENU allows the user to configure the television according to their preference. It will also set up the television to operate with external components connected to the terminal jacks.

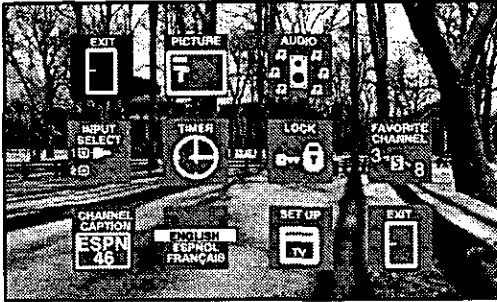

NOTE: Only the selected icon (red) will be animated.

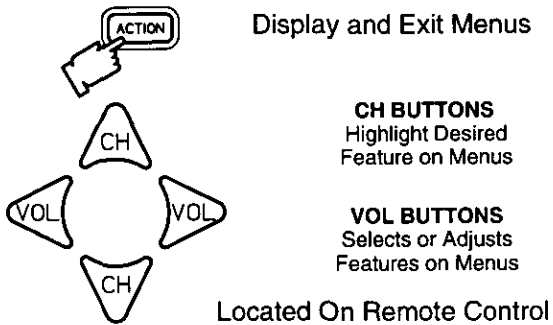

- Press **CH** or **CH** to select ENGLISH, ESPAÑOL or FRANÇAIS for the Language Menu.
- Press **ACTION** twice to exit menus.

Picture Adjustments

Picture Norm – Use to reset Color, Tint, Brightness, Picture, and Sharpness adjustments to the factory preset level.

- Press **ACTION**.
- Press **CH** or **CH** and **VOL** or **VOL** to highlight the Picture Icon.
- Press **ACTION** to display the Picture Adjustment Menu.

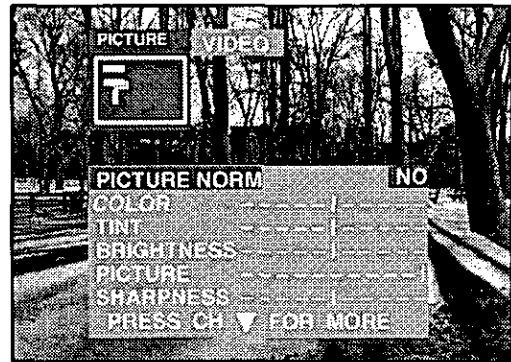

- Press **CH** or **CH** to highlight PICTURE NORM.
- Press **VOL** or **VOL** to select "SET" to normalize Color, Tint, Brightness, Picture, and Sharpness.
- Press **ACTION** twice to exit menus.

Helpful Hint:

Some menu selections are available only under certain conditions. For example, the AI SOUND in the AUDIO menu is available only if the SPATIALIZER is set OFF. When the SPATIALIZER is set ON, the AI SOUND is not displayed.

Color, Tint, Brightness, Picture, and Sharpness Adjustments

- Press **ACTION**.
- Press **CH** or **CH** and **VOL** or **VOL** to highlight the Picture Icon.
- Press **ACTION** to display the Picture Adjustment Menu.

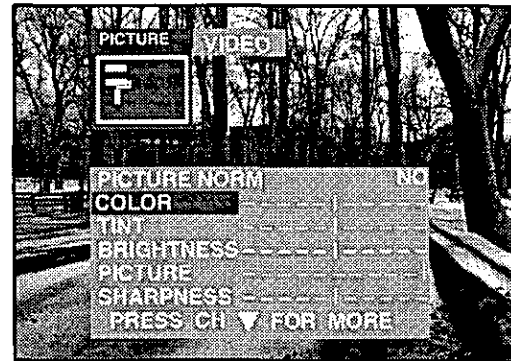

- Press **CH** or **CH** to select the desired Picture Adjustment (Color, Tint, Brightness, Picture, or Sharpness).

Menu Language Selection

The MENU LANGUAGE is factory set to ENGLISH. Follow the instructions to change it to SPANISH, FRENCH, and back to ENGLISH.

- Press **ACTION**.
- Press **CH** or **CH** and **VOL** or **VOL** to highlight the Language ENGLISH/ESPAÑOL/FRANÇAIS Icon.
- Press **ACTION** to display the Language select Menu.

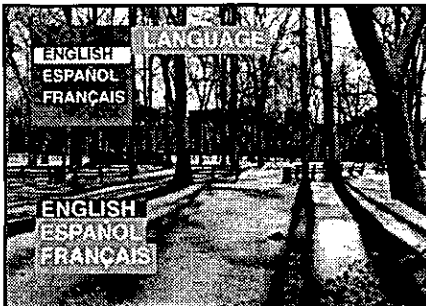

Picture Adjustments

Color, Tint, Brightness, etc. (Cont.)

5. Press or to adjust your selection. (The Selected Picture Adjustment will be displayed.)
6. Repeat steps 4 and 5 for the remaining Picture Adjustments.
7. Press twice to exit menus.

Color Temp – To select one of three (3) options for picture temperature.

1. Press .
2. Press or and or to highlight the Picture Icon.
3. Press to display the Picture Adjustment Menu.



4. Press or to highlight COLOR TEMP.
5. Press or to select NORMAL, WARM, or COOL.
 - NORMAL (no tint)
 - WARM (reddish tint)
 - COOL (bluish tint)
6. Press twice to exit menus.

Auto Color – To automatically optimize color adjustment to compensate for signal variations.

1. Press .
2. Press or and or to highlight the Picture Icon.
3. Press to display the Picture Adjustment Menu.



4. Press or to highlight AUTO COLOR.
5. Press or to select ON or OFF.
6. Press twice to exit menus.

Video NR (Noise Reduction) – To reduce video noise (snow in picture) due to weak signal.

1. Press .
2. Press or and or to highlight the Picture Icon.
3. Press to display the Picture Adjustment Menu.



4. Press or to highlight VIDEO NR (Noise Reduction).
5. Press or to select ON or OFF.
6. Press twice to exit menus.

Helpful Hints:

COLOR – Adjust for desired color intensity.

TINT – Adjust for natural flesh tones.

BRIGHTNESS – Adjust so dark areas of picture slightly become black for a crisp detail.

PICTURE – Adjust the white areas of the picture as desired.

SHARPNESS – Adjust for best clarity of outline detail.

Audio Adjustments

Audio Norm – This feature is used to reset BASS, TREBLE and BALANCE back to a factory preset level.

1. Press **(ACTION)** to display the Main Menu.
2. Press **(CH)** or **(CH)** and **(VOL)** or **(VOL)** to highlight the Audio Icon.
3. Press **(ACTION)** to display the Audio Adjustment Menu.



4. Press **(CH)** or **(CH)** to highlight AUDIO NORM.
5. Press **(VOL)** or **(VOL)** to select "YES" to Normalize Bass, Treble and Balance.
6. Press **(ACTION)** twice to exit Menus.

Bass, Treble & Balance – Before setting Bass or Treble select the desired mode of AI Sound (ON or OFF). Bass and Treble Adjustments may require readjustment when changing between AI Sound ON or OFF.

1. Press **(ACTION)** to display the Main Menu.
2. Press **(CH)** or **(CH)** and **(VOL)** or **(VOL)** to highlight the Audio Icon.
3. Press **(ACTION)** to display the Audio Adjustment Menu.



4. Press **(CH)** or **(CH)** to highlight BASS, TREBLE or BALANCE.
5. Press **(VOL)** or **(VOL)** to adjust for desired audio response.
6. Repeat steps 4 and 5 for remaining audio functions.
7. Press the **(ACTION)** twice to exit menus.

Helpful Hints:

BASS – To increase or decrease the Bass response.
TREBLE – To increase or decrease the Treble response.
BALANCE – To emphasize the Right and Left Speaker's volume.

Mode – Stereo/SAP/Mono – When Audio is broadcast in Stereo or SAP an ON Screen display will appear on initial "Turn On" and "Channel Change". The available choices will be indicated in red.

1. Press **(ACTION)** to display the Main Menu.
2. Press **(CH)** or **(CH)** and **(VOL)** or **(VOL)** to highlight the Audio Icon.
3. Press the **(ACTION)** to display the Audio Adjustment Menu.



4. Press **(CH)** or **(CH)** to highlight MODE.
5. Press **(VOL)** or **(VOL)** to select STEREO, SAP (Second Audio Programming) or MONO. The selected mode will be highlighted.
6. Press **(ACTION)** twice to exit menus.

Helpful Hints:

STEREO – Two channel audio reception.
SAP – Second Audio Programming (such as bilingual audio, weather reports, etc.).
MONO – Use when stereo signal is weak.

Audio Adjustments

Speaker [TV] – This feature is used to turn the internal speakers “ON” or “OFF”. It is used when the television is connected to an External Audio Amplifier. (Refer to “To Audio Amp” Connection section for further information.)

1. Press **(ACTION)** to display the Main Menu.
2. Press **CH** or **CH** and **VOL** or **VOL** to select the Audio Icon.
3. Press **(ACTION)** to display the Audio Adjustment Menu.



4. Press **CH** or **CH** to highlight **SPEAKER**.
5. Press **CH** or **CH** and **VOL** or **VOL** to select **ON**, **OFF&VAO** or **OFF&FAO**.
 - **ON** – TV SPEAKERS operate normally.
 - **OFF&VAO** (Variable Audio Output) – TV SPEAKERS off, the sound output varies according to the TV volume, use the TV remote to control the volume, muting, bass, treble and balance of the External Stereo System.
 - **OFF&FAO** (Fixed Audio Output) – TV SPEAKERS off, sound output is fixed.
6. Press **(ACTION)** twice to exit menus.

Spatializer – Spatializer is a system that makes normal stereo sound a lot more real. When an individual listens to stereo, the sensation is that there is a wall of sound from two speakers. Sound experts call this sensation or illusion, “Psycho–Acoustic.” Our brain and ears work together to combine the sounds from the two speakers to create the illusion of a wall of sound. This television uses the Spatializer feature to apply the Psycho–Acoustic illusion to create a 3–dimensional sound from the two speakers. When Spatializer is working, the sound feels as if it is coming from multiple speakers, surrounding the listener. The result is that the stereo system now sounds as though the listener is actually in the studio or concert hall with the performers.

1. Press **(ACTION)** to display the Main Menu.
2. Press **CH** or **CH** and **VOL** or **VOL** to highlight the Audio Icon.
3. Press the **(ACTION)** to display the Audio Adjustment Menu.



4. Press **CH** or **CH** to highlight **SPATIALIZER**.
5. Press **VOL** or **VOL** to select **SPATIALIZER ON** or **OFF**.
6. Press **(ACTION)** twice to exit menus.

AI Sound – This feature is used to maintain constant sound level when switching between programs with different sound levels. For example, when the broadcast program switches to a commercial, the commercial sound level will be maintained close to the level of the broadcast program. The AI SOUND selection appears only when the SPATIALIZER is OFF.

1. Press **(ACTION)** to display the Main Menu.
2. Press **CH** or **CH** and **VOL** or **VOL** to highlight the Audio Icon.
3. Press **(ACTION)** to display the the Audio Adjustment Menu.



4. Press **CH** or **CH** to highlight **AI SOUND**.
5. Press **VOL** or **VOL** to select **AI SOUND ON** or **OFF**.
6. Press **(ACTION)** twice to exit menus.

Input Select

Main (Picture) Input Selection – This feature is used to select TV Mode Operation or one of three Video Inputs for the Main Picture (used with optional accessory Video equipment).

1. Press **(ACTION)** to display the Main Menu.
2. Press **CH** or **CH** and **VOL** or **VOL** to highlight the Input Select Icon.
3. Press **(ACTION)** to display the Input Select Menu.



4. Press **VOL** or **VOL** to select TV, Video 1, Video 2 or Video 3 for Main Picture Input.
5. Press **(ACTION)** twice to exit menus.

PIP Input Selection – This feature is used to select TV Mode Operation or one of three Video Inputs for the PIP (Picture in Picture) frame when the PIP frame is displayed (used with optional accessory Video equipment).

1. Press **(ACTION)** to display the Main Menu.
2. Press **CH** or **CH** and **VOL** or **VOL** to highlight the Input Select Icon.
3. Press **(ACTION)** to display the Input Select Menu.



4. Press **CH** or **CH** (when the PIP frame is displayed) to highlight "PIP".
5. Press **VOL** or **VOL** to select TV, Video 1, Video 2 or Video 3 for the PIP frame Input.
6. Press **(ACTION)** twice to exit menus.

Timer Feature

Sleep Timer – This feature is used for automatic turn OFF in 30, 60 or 90 minutes as desired.

NOTE: Display will flash 3, 2 and 1 to indicate the last three remaining minutes prior to turn OFF. To deactivate, press **VOL** or **VOL** until "NO" is displayed.

1. Press **(ACTION)** to display the Main Menu.
2. Press **CH** or **CH** and **VOL** or **VOL** to highlight the Timer Icon.
3. Press **(ACTION)** button to display the Timer Control Menu.

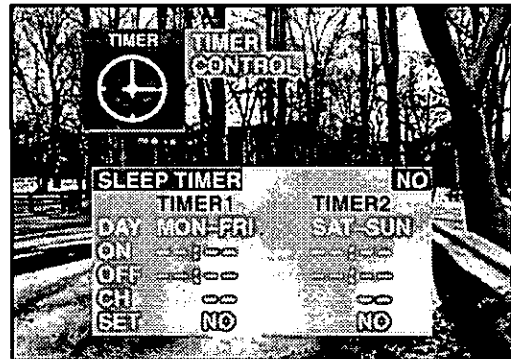

4. Press **VOL** or **VOL** to select 30, 60 or 90 (minutes) for Sleep Timer to be activated.
5. Press **(ACTION)** twice to exit menus.

NOTE: To deactivate Sleep Timer repeat steps 1 through 4. In step 4, select "NO" instead of minutes. Timer Control is not available when Auto Power On is set.

Special Feature:

Automatic turn "OFF" after 90 minutes.

The TV has a special feature that will shut itself OFF after 90 minutes when turned ON by the program timer unless a function key is pressed during the 90 minutes.

This feature is used to insure that the TV will not remain ON unattended for an extended period of time.

Programming the OFF timer will also cancel the automatic OFF feature.

(Program) Timer – The (Dual Program) Timer feature is capable of turning the TV ON to a desired channel and then turning the television OFF at a predetermined time.

NOTE: The clock and day must be set for this feature to operate. (Refer to Set Up Menu to Set Time & Day.)

1. Press **(ACTION)** to display the Main Menu.
2. Press **CH** or **CH** and **VOL** or **VOL** to highlight the Timer Icon.

Timer Feature

(Program) Timer (Cont.)

3. Press **ACTION** to display the Timer Control Menu.



4. Press **CH** or **CH** to highlight the TIMER 1 or TIMER 2 setting.

- Day or days to activate the Timer
- ON (time) – hours and minutes
- OFF (time) – hours and minutes
- CH – the channel the TV is tuned to when the ON Timer activates.
- SET – NO (Timer feature will not activate)
– YES (Timer feature will activate)

5. Highlight the Timer 1 Day/Days option.

6. Press **VOL** or **VOL** to set the day or days for the TV to turn ON.

The options for setting day are: (MON~FRI), (SAT~SUN), (DAILY), (SUN), (MON), (TUE), (WED), (THR), (FRI), (SAT), (EVR SUN), (EVR MON), (EVR TUE), (EVR WED), (EVR THR), (EVR FRI), (EVR SAT).

7. Press **CH** to highlight the ON (Hours/Minutes).
8. Press **VOL** or **VOL** to set the time for the TV to turn ON.
9. Press **CH** to highlight the OFF (Hours/Minutes).
10. Press **VOL** or **VOL** to set the time for the TV to turn OFF.
11. Press **CH** to highlight CH.
12. Press **VOL** or **VOL** to select a channel (from Program Channel Memory) for the TV to be tuned to when it turns ON.
13. Press **CH** to highlight SET.

14. Press **VOL** to activate or **VOL** to deactivate Timer 1.

- YES=Feature is activated
- NO=Feature is not activated

15. Press **CH** to set Timer 2 (if desired). Follow Steps 6 through 14.

16. Press **ACTION** twice to exit menus.

NOTE: Pressing **ACTION** again will return you back to the Timer Icon.

Helpful Hints:

- The Program Timer overrides the Sleep Timer.
- Program Timer can only access channels in Program Channel Memory.
- "Set Time First" will appear on screen when trying to set Timer Day Option without the clock being set.
- If the Program Timer "ON" functions while the set is operating the set will automatically tune to the channel designated in the Program Timer.

Lockout Features

Lockout Mode – This feature allows locking out the following from viewing:

- Game – Lockout Channel 3 & 4 plus Video Inputs.
- Channel – Lockout up to 4 Channels.
- All – Lockout All Channels plus Video Inputs.



NOTE: This feature will Lockout your selection for up to 48 hours. Be sure to understand this feature before using. **Use a code that you will easily remember.**

1. Press **ACTION** to display the Main Menu.
2. Press **CH** or **CH** and **VOL** or **VOL** to highlight the Lock Icon.
3. Press **ACTION** to display the Lock Menu.

Lockout Features

Lockout Mode (Cont.)

NOTE: When the Lockout Menu is displayed, the Game Lock option will be highlighted.

4. Press  or  to select GAME, CH (CHANNEL) or ALL.

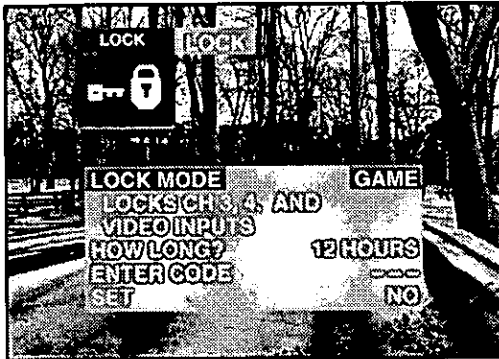

Game Lockout Menu
(Channels 3 & 4 plus Video Inputs)

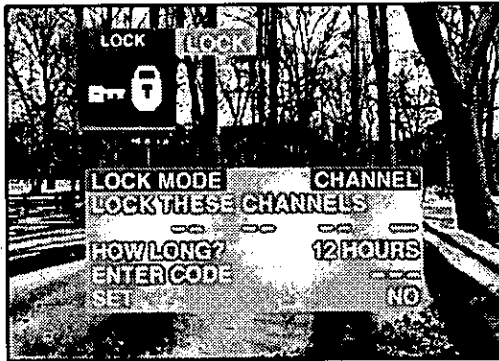

Channels Lockout Menu
(up to 4 Channels)



All Lockout Menu
(All Channels plus Video Inputs)

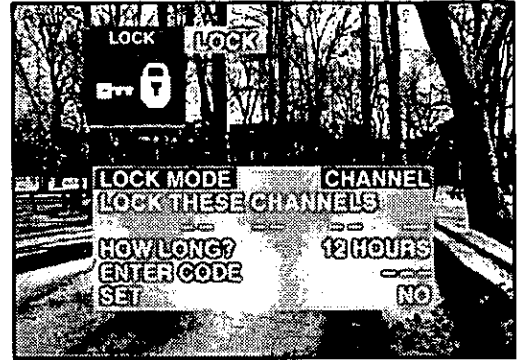

Step A

Press  to highlight "LOCK THESE CHANNELS".

Step B





Then use the Remote Control Keyboard to select a channel you desire to lockout.

Step C

Press  to select next channel position.

Step D

Then repeat Step B & C until desired Channels are locked out (up to 4 channels).

5. Press  to highlight "HOW MANY HOURS".
6. Press  or  to select 12, 24 or 48 (hours lockout time).
7. Press  to highlight "ENTER CODE" then enter a 3 digit code by using the Remote Control Keyboard. **IMPORTANT NOTE: Use a code you can easily remember.**
8. Press  to select "YES" for Lock feature to be activated "CHANNELS LOCKED" will display On Screen.

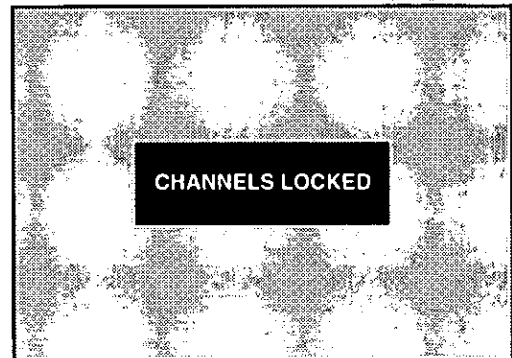

Lock Feature Activated

Helpful Hints:

NOTE: If a red "PG" appears in the upper right hand corner, the selected channel or Video mode is locked out.

NOTE: When the LOCK MODE CHANNEL is selected, perform procedure Steps A through D.

Lockout Features

Unlock – Follow Steps 1 through 3 from previous section and enter same 3 digit code as in Step 7. Channel Unlocked display will appear.

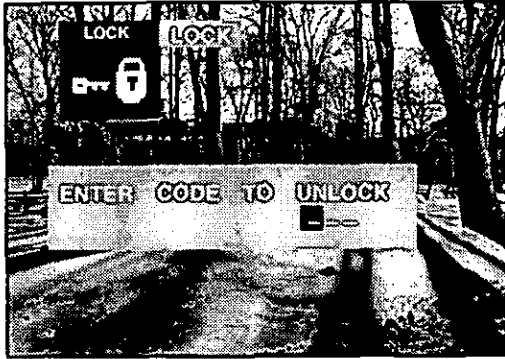

ENTER SAME 3 DIGIT CODE

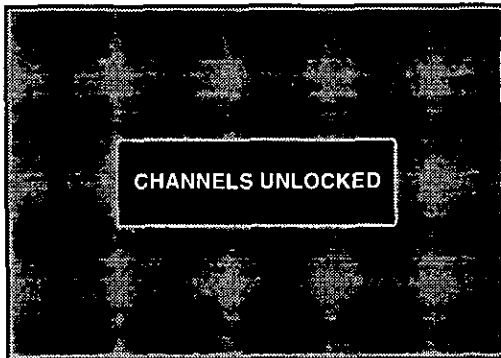

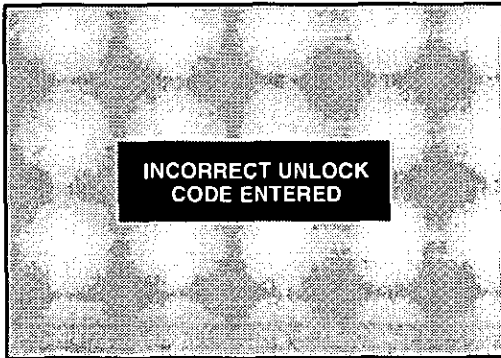

IF 3 DIGIT CODE IS THE SAME









IF 3 DIGIT CODE IS NOT THE SAME









Favorite Channel Features

Channel Scan – This feature is use to select which Channels will be accessed when using  or , ALL or FAV (Favorite) Channels.

NOTE: Channels must be programmed into Favorite Channel Select Memory first.

1. Press  to display the Main Menu.
2. Press  or  and  or  to highlight the Favorite Channel Icon.
3. Press  to display the Favorite Channel Menu.



4. Press  or  to highlight CHAN SCAN.
5. Press  or  to select ALL or FAV (Favorite).
 - ALL – The  or  will access all channels in Channel Memory.
 - FAV – The  or  will only access channels in Favorite Channel Select Memory.
6. Press  twice to exit Menu.

NOTE: Pressing  again will return you back to the Favorite Channel Icon.

Helpful Hints:

NOTE: After Auto Channel Program the first 15 channels selected will automatically be put into Favorite Channel memory, if space is available.

Favorite Channel Features

Favorite Channel Select — The Favorite Channel Programming allows you to program up to 15 of your favorite channels. You can use the CH buttons on the Remote Control to scan channels without going through channels you do not normally view.

1. Press **(ACTION)** to display the Main Menu.
2. Press **CH** or **CH** and **VOL** or **VOL** to highlight the Favorite Channel Icon.
3. Press **(ACTION)** to display the Favorite Channel Menu.



4. Press **CH** or **CH** to highlight CHAN SCAN. Then, press **VOL** or **VOL** to select FAV option for Favorite Channels setting.
5. Press **CH** or **CH** to highlight "FAV CH SELECT".
6. Press **VOL** or **VOL** to display the Favorite Channel Select.

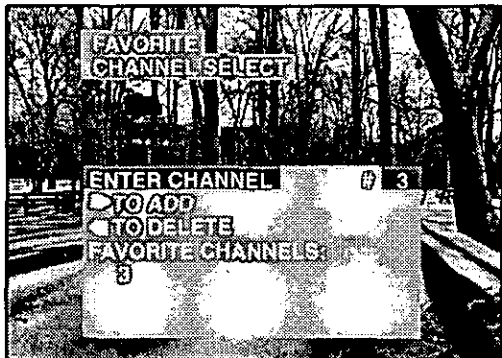

7. Enter the channel number you wish to add or delete from Favorite Channel Memory (using the Remote Keyboard or **CH** or **CH**).
8. Press **VOL** to add or press **VOL** to delete channel from Favorite Channel Memory.
9. Repeat Steps 6 and 7 to add or delete channels (up to 15 channels may be stored in Favorite Channel Memory).
10. When you are done with adding and deleting channel, press **(ACTION)** twice to return to normal viewing.
11. Press **CH** or **CH** to scan through the Favorite Channels you programmed.

Channel Caption Features

Preset Caption — This feature allows you to select from 56 preset captions, and assign corresponding channel numbers utilized in your area. Captions are easily assigned to the channel numbers you select by following the steps outlined below.

1. Press **(ACTION)** to display the Main Menu.
2. Press **CH** or **CH** and **VOL** or **VOL** to highlight the Channel Caption Icon.
3. Press **(ACTION)** to display the Channel Caption Menu.



4. Press **CH** or **CH** to highlight PRESET CAPTION.
5. Press **VOL** or **VOL** to display the Preset Caption Menu.

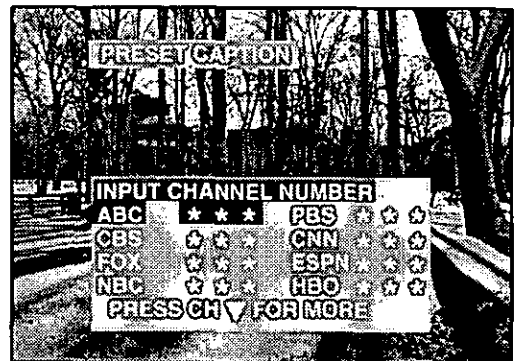

6. Use the Remote Control keyboard, to assign the channel number to the Channel Caption in your area (Refer to your local TV guide).

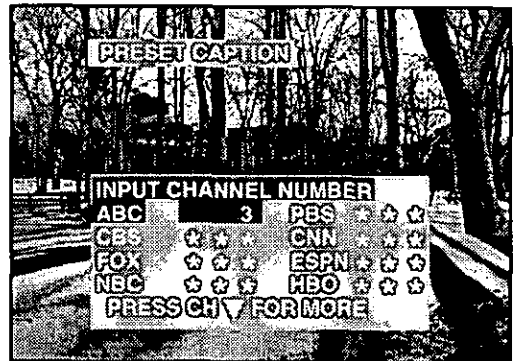

7. Press **CH** to select a different Preset Caption, then repeat step 6 until all desired Preset Captions have assigned channel numbers.

Channel Caption Features

Manual Caption – The Channel Caption (Station Identifier) allows you to input the call names of up to 30 stations into memory (using up to 4 characters). The call name will then display, along with the channel number when changing channels or pressing **RECALL**.

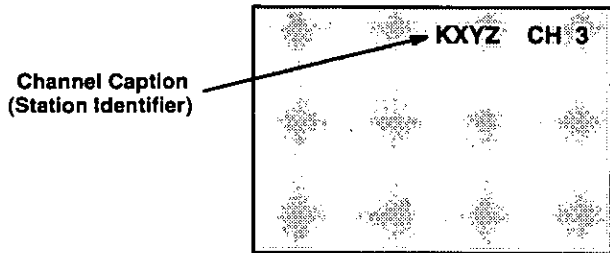

1. Press **ACTION** to display the Main Menu.
2. Press **CH** or **CV** and **VOL** or **YOL** to highlight the Channel Caption Icon.
3. Press **ACTION** to display the Channel Caption Menu.



4. Press **CV** to highlight MANUAL CAPTION.
5. Press **VOL** or **YOL** to display the MANUAL CAPTION menu.



6. Use the Remote Control Keyboard or **VOL** or **YOL** to enter channel number your wish to assign a channel caption (STATION IDENTIFIER).
7. Press **CV** to highlight ENTER CAPTION.



8. Press **VOL** or **YOL** to select first character in channel caption (STATION IDENTIFIER).
9. Press **CV** to move to second character position, and repeat steps 8 and 9 until the complete caption is entered (up to 4 characters).
10. Press **CH** or **CV** repeatedly to highlight ENTER CHANNEL NUMBER. Then repeat steps 6 through 10 to continue adding channel caption (STATION IDENTIFIERS).
11. Press **ACTION** three times to exit menus.

Note: Press **ACTION** again to return to Channel Caption Icon.

Set Up Features

Clock (Auto) – This feature automatically adjusts the TV clock to the correct time whenever the TV is tuned to a PBS (Public Broadcasting Service) station for 10 minutes or until the correct time and day are displayed (Refer to your local TV guide for PBS channel number).

NOTE: A plus or minus one-hour offset can be programmed to adjust the clock when there is a time zone difference between the PBS TV station and the viewer.

1. Press **ACTION** to display the Main Menu.
2. Press **CH** or **CV** and **VOL** or **YOL** to highlight the Set Up Icon.
3. Press **ACTION** to display the Set Up Menu.



Set Up Features

Clock (Auto) (cont.)

4. Press and or to highlight CLOCK.
5. Press or to select AUTO (if necessary).
6. Press to highlight AUTO TIME SET.



7. Press or to display the AUTO TIME SET Menu.
8. Press to highlight PBS CHANNEL.



9. Tune TV or Cable Box to PBS channel, using the Remote Control Keyboard to enter PBS channel number.
10. Press to highlight TIME ZONE ADJUST.



11. Press for minus one-hour offset or for plus one-hour offset (if necessary).
12. Press to highlight ACTIVATE.



13. Press or to display the AUTO TIME SET ACTIVATE Menu.

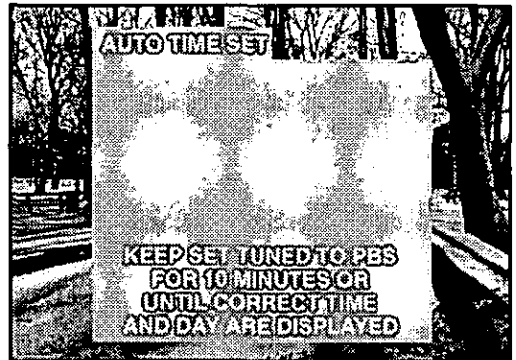

WAITING FOR CORRECT TIME AND DAY

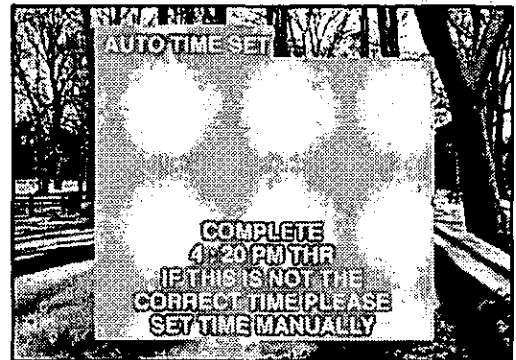

COMPLETED READ MENU

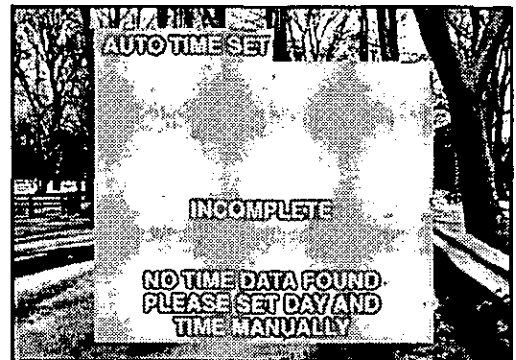

INCOMPLETE READ MENU

14. Press four times to exit menus.

Set Up Features

Clock (Manual) – Clock (when set) will display On Screen at initial turn on, after a channel change and when pressing **RECALL**. It must be set in order to operate the dual Timer feature.

1. Press **ACTION** to display the Main Menu.
2. Press **CH** or **CH** and **VOL** or **VOL** to highlight the Set Up Icon.
3. Press **ACTION** to display the Set Up Menu.

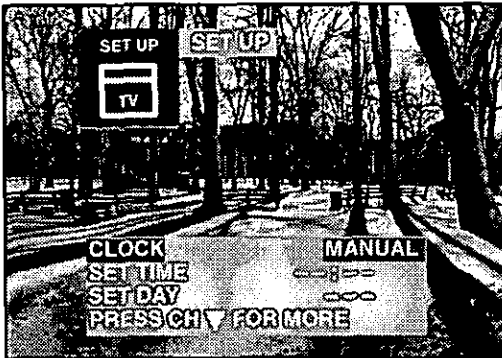

4. Press **CH** or **CH** to highlight CLOCK .
5. Press **VOL** or **VOL** to select MANUAL.
6. Press **CH** or **CH** to highlight SET TIME.



7. Press **VOL** or **VOL** to Set Hours (set AM/PM accordingly).
8. Press **CH** to highlight minutes position.
9. Press **VOL** or **VOL** to set minutes.
10. Press **ACTION** twice to exit Menus.

NOTE: Pressing **ACTION** again will return you back to the Set Up Icon.

Set Day – The day of the week must be set in order to operate the Dual Timer feature.

1. Press **ACTION** to display the Main Menu.
2. Press **CH** or **CH** and **VOL** or **VOL** to highlight the Set Up Icon.

3. Press **ACTION** to display the Set Up Menu.

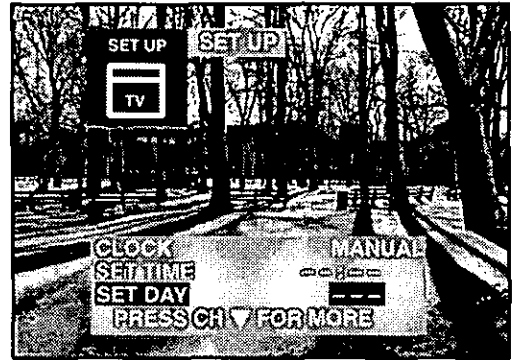

4. Press **CH** or **CH** to highlight SET DAY.
5. Press **VOL** or **VOL** to select proper day of the week.
6. Press **ACTION** twice to exit Menus.

Mode (TV or Cable)

IMPORTANT NOTE: The proper input mode must be selected for the type of signal at the antenna input.

- TV is used when the television is not connected to a Cable TV System, for example, when using a VHF/UHF antenna (Channels 02–69).
- CABLE is used when the television is connected to a Cable TV System and when not using a Cable Box (Channels 01–125).

NOTE: Some Cable TV Systems encode (scramble) program material on specific channels. A cable company supplied decoder is required to reproduce an acceptable picture. Certain Cable TV Systems offset some channels to reduce interference. It will be necessary to use the cable company supplied converter to receive these specific channels.

1. Press **ACTION** to display the Main Menu.
2. Press **CH** or **CH** and **VOL** or **VOL** to highlight the Set Up Icon.
3. Press **ACTION** to display the Set Up Menu.



4. Press **CH** or **CH** to highlight Mode.
5. Press **VOL** or **VOL** to select TV or CABLE.
6. Press **ACTION** twice to exit menus.

Set Up Features

Auto Programming – The Auto Programming feature allows you to place all channels with a video signal into Channel Scan Memory. When you press or , only those channels with a video signal will be accessed.

NOTE: TV or Cable Tuning mode must be set properly for your system.

1. Press to display the Main Menu.
2. Press or and or to highlight the Set Up Icon.
3. Press to display the Set Up Menu.



4. Press or to highlight AUTO PROGRAM.
5. Press or to start Auto Programming Scan. Channels will automatically advance until all channels have been scanned.
 - Channel numbers with video signal present will turn blue which indicates stored in Channel Scan Memory.
6. Press twice to exit menus.

NOTE: Some channels with very weak signals may be locked into memory. These must be deleted manually using the Manual Program feature.

Manual Programming – This feature allows you to select which channels are placed into Channel Scan Memory so when you press or only those channels you desire will be accessed.

1. Press the to display the Main Menu.
2. Press or and or to highlight the Set Up Icon.
3. Press to display the Set Up Menu.



4. Press or to highlight MANUAL PROGRAM.
5. Press or to display Manual Programming Menu.



6. Use the Remote Control Keyboard numbers "0 through 9" or or to select channels.
7. Press to add channel(s) to memory (blue). Press the to delete channel(s) from memory (yellow).
8. Repeat Steps 6 and 7 to continue adding or deleting channels.
9. Press twice to exit menus.

Helpful Hints:

After Auto Programming:

Blue channel number indicates channel is in Channel Scan Memory.

All channels are available by direct access using the Keyboard numbers "0 through 9".

After Auto Programming Scan has completed, up to 15 channels will be programmed into the FAVORITE Channel Scan if space is available. Any original channels that were programmed into FAV CHANNEL will remain. (Refer to Favorite Channel Scan for deleting unwanted channels.)

Set Up Features

Auto Power On – Automatically turns the television on when a VCR, Cable Box, etc., are powered. The Television needs to be plugged into the switched outlet of the device. Setting the Auto Power On feature will cancel the time and timer control settings. The Main Menu Icon for the TIMER CONTROL will be replaced with an EXIT Icon.

1. Press **(ACTION)** to display the Main Menu.
2. Press **CH** or **CH** and **VOL** or **VOL** to highlight the Set Up Icon.
3. Press **(ACTION)** to display the Set Up Menu.

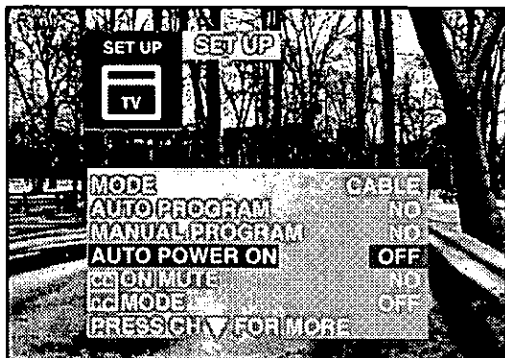

4. Press **CH** or **CH** to highlight AUTO POWER ON.
5. Press **VOL** or **VOL** to select SET.
6. Press **(ACTION)** twice to exit menus.

CC On Mute – Activates the On Screen Closed Caption feature when the **(MUTE)** on the Remote Control is pressed. To deactivate press **(MUTE)** again.

NOTE: This feature only functions when the Close Caption Mode is in the "OFF" position. The program being viewed must be broadcast with Closed Caption. (Refer to your local TV guide.)

1. Press **(ACTION)** to display the Main Menu.
2. Press **CH** or **CH** and **VOL** or **VOL** to highlight the Set Up Icon.
3. Press **(ACTION)** to display the Set Up Menu.



4. Press **CH** or **CH** to highlight CC ON MUTE.

5. Press **VOL** or **VOL** to select NO (OFF), C1, C2, C3 or C4. Recommended Set Up for Closed Caption when using

- **(MUTE)**
- CC ON MUTE: C1
- CC MODE: OFF

6. Press **(ACTION)** twice to exit menus.
7. Press **(MUTE)** when the program being viewed is broadcast with Closed Caption to activate.

NOTE: Press **(MUTE)** again to deactivate.

CC Mode – This television contains a built in decoder that is capable of providing a visual depiction of the audio portion. The program viewed must include Closed Captioning (CC) for the television to display it. CC is displayed in the form of text across the screen (white or colored letters on a black background). It allows the viewer to read the dialogue of a television program or other information.

1. Press **(ACTION)** to display the Main Menu.
2. Press **CH** or **CH** and **VOL** or **VOL** to highlight the Set Up Icon.
3. Press **(ACTION)** to display the Set Up Menu.

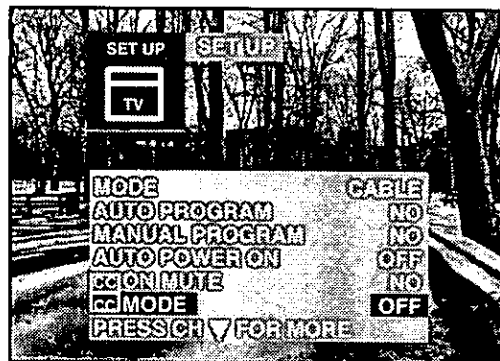

4. Press **CH** or **CH** to highlight CC MODE.
5. Press **VOL** or **VOL** to select OFF, C1, C2, T1, T2, C3, C4, T3 or T4.
 - **CAPTION OFF** – Use when Closed Caption is not desired.
 - **CAPTION C1** – For video related information that can be displayed (up to 4 lines of script on the screen, where it does not obstruct relevant parts of the picture). Script can be in any language.
 - **CAPTION C2** – Another mode used for video related information.
 - **CAPTION C3 and C4** – Other modes used for video related information.
 - **TEXT T1** – Blanks out a large portion of the picture on the television screen, and displays program guide or any other information currently being transmitted.
 - **TEXT T2, T3 & T4** – Other modes that display information and blank out a large portion of the picture on the television screen.
6. Press **(ACTION)** twice to exit menus.

Programming the Home Theater Remote

The remote control can be set to control other manufacturers components, by utilizing the **MODE SELECTION BUTTONS** for **CABLE, DSS, VCR, RCVR** (a Receiver or Amplifier), **CD, LD**, and **AUX** (for **Cassette Players, Second VCR or a DVD**.)

Code Known

Use the following procedure for setting up the remote control using the numerical buttons when the component's remote code is known.

- 1 Determine the brand of the component.
- 2 Identify the code(s) associated with the brand from the infrared code index (see following pages). Record all possible codes.
- 3 Confirm that the component is plugged in and operating properly, then turn it OFF.
- 4 Press and hold the **ACTN** button, then the **POWER** button so that both are pressed at the same time for at least 5 seconds. All Mode buttons will flash. Then let go of the buttons.
- 5 Press the appropriate Mode button for the component. The pressed button will illuminate steadily. All other buttons will go out.
- 6 Enter the 3-digit code, by using the Remote Control Keypad "0" through "9" buttons. If a proper code was entered, the Mode button will blink twice then go out.

Now the remote is set for the entered code.

- 7 Press the **POWER** button to test the remote. If the correct code is setup for the component (in step 6), the component will turn on.

NOTE: Some brands have multiple codes. Repeat the procedure using another listed code until the component responds correctly.

Code Unknown

Use the following procedure for setting up the remote control when the component's remote access code is not known. This procedure uses the "sequence method".

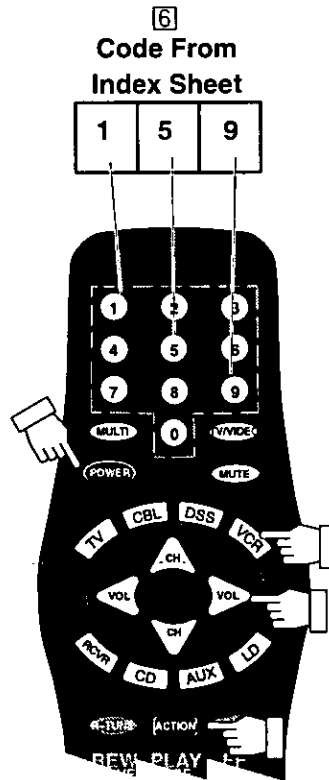

EUR511060

- 1 Confirm that the component is plugged in and operating properly, then turn it OFF.
- 2 Press and hold the **ACTN** button, then the **POWER** button so that both are pressed at the same time for at least 5 seconds. All Mode buttons will flash. Then let go of the buttons.
- 3 Press the appropriate Mode button for the device. The pressed button will illuminate steadily. All other buttons will go out.
- 4 Press the **VOL** button to step over to the next code.
- 5 Press the **POWER** button to test the remote. If the correct code is sent, the component will turn on.
- 6 Once the correct code is found, press the **ACTN** button to store the code.
- 7 Repeat from step 3 above until the proper component code is found. It may take several attempts before the correct code is found.

NOTE: If an incorrect code is entered, or when the operation is not completed within 30 seconds, the settings will not change.

Infrared Remote Codes for Specific Components

Helpful Hint: Write down the code numbers for your components in the space provided below. This will serve as a handy reference whenever you need to reprogram your remote control.

CABLE Cable TV Converter Box <div style="border: 1px solid black; width: 40px; height: 20px; display: inline-block; margin-top: 5px;"></div>	VCR Video Cassette Recorder <div style="border: 1px solid black; width: 40px; height: 20px; display: inline-block; margin-top: 5px;"></div>	CD Compact Disc Player <div style="border: 1px solid black; width: 40px; height: 20px; display: inline-block; margin-top: 5px;"></div>
DSS Digital Satellite System <div style="border: 1px solid black; width: 40px; height: 20px; display: inline-block; margin-top: 5px;"></div>	RCVR Receiver or Amplifier <div style="border: 1px solid black; width: 40px; height: 20px; display: inline-block; margin-top: 5px;"></div>	LD Laser Disc Player <div style="border: 1px solid black; width: 40px; height: 20px; display: inline-block; margin-top: 5px;"></div>
Other Component <div style="border: 1px solid black; width: 40px; height: 20px; display: inline-block; margin-top: 5px;"></div>	Other Component <div style="border: 1px solid black; width: 40px; height: 20px; display: inline-block; margin-top: 5px;"></div>	Other Component <div style="border: 1px solid black; width: 40px; height: 20px; display: inline-block; margin-top: 5px;"></div>
Other Component <div style="border: 1px solid black; width: 40px; height: 20px; display: inline-block; margin-top: 5px;"></div>	Other Component <div style="border: 1px solid black; width: 40px; height: 20px; display: inline-block; margin-top: 5px;"></div>	Other Component <div style="border: 1px solid black; width: 40px; height: 20px; display: inline-block; margin-top: 5px;"></div>

VCR Infrared Codes Index

The Universal Infrared Remote Control is capable of operating many brands of VCRs. Refer to the Programming the Remote Control section for procedures.

Note: The Universal Remote Control memory is limited; therefore, some models of VCRs may not operate. The Universal Remote Control is not designed to control all features that are available in all models.

Note: After entering the proper infrared code, press the Remote **VCR (★)** Selection Mode button. **A second VCR can be activated** using the same codes, from **AUX (★★)** Selection Mode button. Then refer to the Remote Control Key Functions section, for Remote VCR and VCR 2 function key listing.

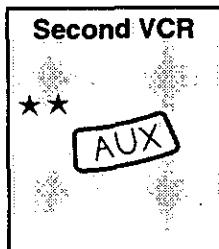
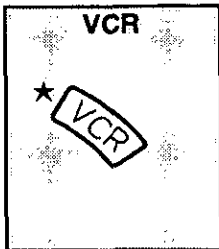

Code Index for VCRs			
VCR Brand	Code(s)	VCR Brand	Code(s)
Admiral	200	Pentax	000, 011, 300
Aiwa	137, 160	Philco	081, 125, 130, 136, 137, 150
Akai	014, 015, 016, 142	Philips	125, 130, 150
Audio Dynamic	011, 240	Pioneer	125
Bell & Howell	005, 013	Proscan	000, 001, 002, 125, 130, 150, 300, 310
Broksonic	081, 136	Quasar	100, 101, 125, 130
Canon	125, 135	Radio Shack	005, 009, 130, 137, 170, 210, 241
Citizen	006	RCA	000, 001, 002, 125, 130, 150, 170, 300, 310
Craig	005, 006, 141	Realistic	005, 009, 130, 137, 210, 241
Curtis Mathes	130, 137, 300	Samsung	002, 004, 220
Daewoo	001, 130, 250	Sansui	081, 136, 240
DBX	010, 011, 240	Sanyo	005, 009
Dimensia	300	Scott	001, 002, 004, 009, 081, 136, 230, 241, 330, 340
Emerson	003, 051, 080, 081, 135, 136, 243, 250	Sears	000, 005, 006, 007, 008,
Fisher	005, 007, 008, 009	Shaintom	050
Funai	081, 136, 137	Sharp	200, 210
GE	130, 170, 300	Signature 2000	137, 200
Goldstar	006	Singer	050
Go Video	220	Sony	140, 141, 142
Hitachi	000, 125, 300,	SV2000	137
Instant Replay	125, 130,	Sylvania	125, 130, 137, 150
Jensen	240	Symphonic	137
JVC	010, 011, 190, 240	Tashiro	006
Kenwood	006, 010, 011, 240	Tatung	010, 011, 240
LXI	000, 005, 006, 007, 008, 009, 137	Teac	010, 011, 137, 240
Magnavox	025, 130, 150	Technics	100, 101, 125, 130
Marantz	010, 011, 240	Teknika	130, 137
Marta	006	Toshiba	001, 310
Memorex	009, 130	Vector Research	011
MGA	230, 241, 242, 243, 330, 340	Wards	006, 009, 200, 210, 290
Minolta	000, 300	Yamaha	005, 010, 011, 240
Mitsubishi	230, 241, 242, 243, 330, 340	Zenith	290
Multitech	004, 137, 330		
NEC	010, 011, 190, 240		
Olympic	125, 130		
Optimus	006, 200, 100, 140		
Orion	081, 136		
Panasonic	100, 101, 125, 130		
Penney	000, 005, 010, 011, 130, 240, 300		

Cable Converter Box and CD Players Infrared Codes Index

The Universal Infrared Remote Control is capable of operating many brands of Cable Converter Boxes and CD Players. Refer to the Programming the Remote Control section for procedures.

Note: The Universal Remote Control memory is limited; therefore, some models of Cable Converter Boxes and CD Players may not operate. The Universal Remote Control is not designed to control all features that are available in all models.

Note: After entering the proper infrared code, press the Remote **CBL** Selection Mode button (☆). Then refer to the Remote Control Key Functions section, for Remote CBL function key listing.

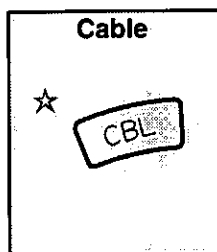

Codes for Cable Converter Box			
Brand of Cable-TV Box	Code(s)	Brand of Cable-TV Box	Code(s)
ABC	530	Philips	006, 007, 540, 541, 542
Archer	531, 544	Pioneer	001, 260
Cableview	005, 544	Pulsar	005, 544
Citizen	005, 522	Puser	544
Curtis	130, 131	RCA	170, 220
Diamond	530, 531, 544	Realistic	544
Eagle	541	Regal	130, 350, 720, 730, 731, 900
Eastern	560	Regency	560
Gcbrand	005, 544	Rembrandt	005, 544, 702
Gemini	522	Samsung	005
General Instrument	122, 360, 520, 521, 522, 530, 531, 532, 533	Scientific Atlanta	122, 130, 131
Hamlin	130, 350, 720, 730, 731, 900	Simark	001, 005
Hitachi	003, 530	Sprucer	005, 121
Jerrold	122, 360, 520, 521, 522, 530, 531, 532, 533	Stargate	005, 544
Macom	003, 004, 005	Television	001, 005
Memorex	542	Texscan	810
Movietime	005, 544	Tocom	700, 701
Oak	002, 702, 710	Toshiba	004
Panasonic	120, 121, 132	Unika	531, 544
Paragon	281	Universal	522, 544
		Videoway	006
		Viewstar	541, 542
		Zenith	000, 280, 281
		Zenith/Drake Satellite	000

Note: After entering the proper infrared code, press the Remote **CD** Selection Mode button (☆☆). Then refer to the Remote Control Key Functions section, for Remote CD Players function key listing.

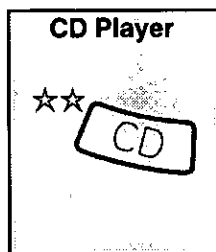

Codes for CD Players			
Brand of CD Players	Code(s)	Brand of CD Players	Code(s)
Admiral	110	Optimus	030, 057, 059, 061
Aiwa	162, 164	Panasonic	100, 101, 130
Carver	150, 151	Philips	150, 151
Denon	200	Pioneer	030
Emerson	172	Quasar	100, 101, 130
Fisher	005	RCA	160, 170, 171, 500
Garrard	057	Sansui	032, 050, 320
Harman/Kardon	059, 060	Sanyo	005
Hitachi	007	Scott	032, 050, 320
Jensen	163	Sharp	200, 201
JVC	190, 191, 270	Sherwood	059
Kardon	058	Sony	140
Kenwood	000, 001, 050, 270	Soundesign	220
LXI	165	Teac	051, 055, 057
Magnavox	150, 161	Technics	100, 101, 130
Marantz	151	Victor	190, 191, 270
McIntosh	060	Yamaha	002, 003, 004
Nakamichi	032		
Onkyo	053, 054		

Cassette Deck, Receivers, and Amplifiers Infrared Codes Index

The Universal Infrared Remote Control is capable of operating many brands of Cassette Deck, Receivers, or Amplifiers. Refer to the Programming the Remote Control section for procedures.

Note: The Universal Remote Control memory is limited; therefore, some models of Cassette Deck, Receivers, and Amplifiers may not operate. The Universal Remote Control is not designed to control all features that are available in all models.

Note: After entering the proper infrared code, press the Remote **AUX** Selection Mode button (*). Then refer to the Remote Control Key Functions section, for Remote Cassette Players function key listing.

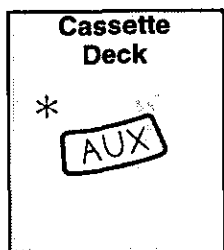

Code Index for Cassette Deck			
Brand of Cassette Deck	Code(s)	Brand of Cassette Deck	Code(s)
Aiwa	760, 761, 762	Philips	751
Denon	800	Pioneer	630
Fisher	603	RCA	763, 770, 771
Jensen	657	Sansui	631, 653
JVC	780, 781	Sharp	800
Kenwood	600, 650	Sony	740
Marantz	751	Teac	653, 654
Nakamichi	631	Technics	700, 701, 730
Onkyo	651, 652, 656	Yamaha	601, 602
Panasonic	700, 701, 730		

Note: After entering the proper infrared code, press the Remote **RCVR** Selection Mode button (**). Then refer to the Remote Control Key Functions section, for Remote Receivers/Amplifiers function key listing.

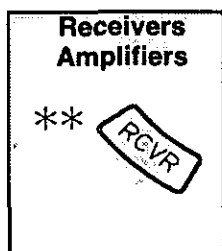

Code Index for Receivers and Amplifiers			
Brand of Receiver / Amplifier	Code(s)	Brand of Receiver / Amplifier	Code(s)
Admiral	110	Panasonic	100, 101, 130
Aiwa	160, 161	Philips	150
Denon	200, 201, 202	Pioneer	030, 032
Fisher	004	Quasar	100, 101, 130
Garrard	055	RCA	003, 130, 162, 170, 171
Harman	150, 057	Sansui	003, 053, 320
Jensen	164	Sharp	200, 203
JVC	190, 191	Sony	140
Kenwood	000, 050	Soundesign	220
Magnavox	162	Teac	053, 054, 055
Marantz	151	Technics	100, 101, 130
McIntosh	058	Victor	190, 191
Nakamichi	031	Yamaha	001, 002
Onkyo	151, 156		
Optimus	003, 162, 170, 171		

Laser Disc, DSS (Digital Satellite System), and DVD (Digital Videodisc) Infrared Codes Index

The Universal Infrared Remote Control is capable of operating selected brands of Laser Disc, DSS Digital Satellite System, and DVD (Digital Videodisc). Refer to the Programming the Remote Control section for procedures.

Note: The Universal Remote Control memory is limited; therefore, some models of Laser Disc, DSS Digital Satellite System, and DVD (Digital Videodisc) may not operate. The Universal Remote Control is not designed to control all features that are available in all models.

Note: After entering the proper infrared code, press the Remote **LD** Selection Mode button (◊). Then refer to the Remote Control Key Functions section, for Remote Laser Disc function key listing.

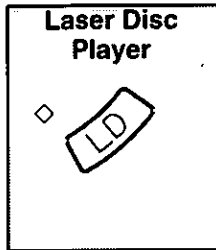

Codes for Laser Disc			
Brand of Laser Disc	Code(s)	Brand of Laser Disc	Code(s)
Denon	370	Quasar	100, 101, 135, 380
Hitachi	000	RCA	370
Kenwood	002, 003	Samsung	160
Marantz	370	Sanyo	370
Mitsubishi	370	Sharp	200
NEC	370	Sony	140, 141, 142, 143
Panasonic	100, 101, 135, 380	Teac	370
Philips	150	Toshiba	370
Pioneer	370	Yamaha	001
Proscan	370		

Note: After entering the proper infrared code, press the Remote **DSS** Selection Mode button (◊◊). Then refer to the Remote Control Key Functions section, for Remote DSS function key listing.

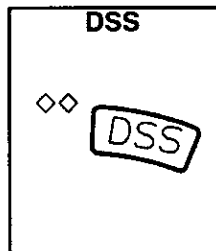

Codes for DSS (Digital Satellite System)		
Brand of Satellite	Code(s)	
GE	170	
Panasonic	100	
RCA	170	
Sony	390	



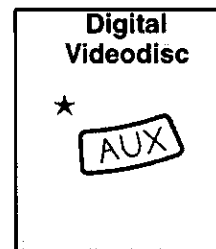















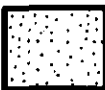

Note: After entering the proper infrared code, press the Remote **AUX** Selection Mode button (★). Then refer to the Remote Control Key Functions section, for Remote DVD function key listing.

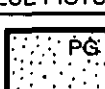

Codes for DVD (Digital Videodisc)		
Brand of DVD	Code(s)	
Panasonic	102	

Troubleshooting Chart

Before you call for service, determine the symptoms and make a few simple checks shown below.

Symptoms		Check
Picture	Sound	
 SNOWY PICTURE	 NOISY SOUND	- ANTENNA LOCATION AND/OR CONNECTION
 MULTIPLE IMAGE	 NORMAL SOUND	- ANTENNA DIRECTION AND/OR LOCATION - ANTENNA LEAD-IN WIRE
 INTERFERENCE	 NOISY SOUND	- ELECTRICAL APPLIANCES, LIGHTS, CARS AND TRUCKS - DIATHERMY AND OTHER MEDICAL EQUIPMENT
 NORMAL PICTURE	 NO SOUND	- VOLUME CONTROL SETTING - MUTE CONTROL (IF APPLICABLE) - TV SPEAKER SWITCH (IF APPLICABLE) IN OFF OR EXT POSITION - TRY ANOTHER CHANNEL
 NO VIDEO	 NOISY SOUND	- TV/ANT-CABLE TUNING SYSTEM SET TO PROPER SETTING - ANTENNA INPUT MODE INCORRECT
 NO PICTURE	 NO SOUND	- CHECK THAT AC POWER LINE IS PLUGGED INTO AC OUTLET AND POWER BUTTON IS ON - BRIGHTNESS & AUDIO CONTROLS SET PROPERLY - TRY ANOTHER CHANNEL
 NO COLOR	 NORMAL SOUND	- COLOR CONTROL SETTINGS - TRY ANOTHER CHANNEL
 BLUE PICTURE	 NO SOUND	- RECEIVER IN VIDEO MODE WITH NO SIGNAL
 NO VIDEO	 NOISY SOUND	- CHANNEL LOCKOUT FEATURE ACTIVATED
 BLACK BOX IN PICTURE	 SOUND	- CC (CLOSED CAPTION) IN TEXT MODE - PUT IN CAPTION OFF MODE TO ELIMINATE BLACK BOX

Panasonic Consumer Electronics Company, Division of Matsushita Electric Corporation of America
One Panasonic Way
Secaucus, New Jersey 07094

Panasonic Canada Inc.
5770 Ambler Drive
Mississauga, Ontario L4W 2T3
Canada

Panasonic Sales Company, Division of Matsushita Electric of Puerto Rico Inc. ("PSC")
Ave. 65 de Infanteria, Km 9.5
San Gabriel Industrial Park
Carolina, Puerto Rico 00985
Tel. (787) 750-4300
FAX. (787) 768-2910

Free Manuals Download Website

<http://myh66.com>

<http://usermanuals.us>

<http://www.somanuals.com>

<http://www.4manuals.cc>

<http://www.manual-lib.com>

<http://www.404manual.com>

<http://www.luxmanual.com>

<http://aubethermostatmanual.com>

Golf course search by state

<http://golfingnear.com>

Email search by domain

<http://emailbydomain.com>

Auto manuals search

<http://auto.somanuals.com>

TV manuals search

<http://tv.somanuals.com>