

# Operating Instructions

3 CCD Color Camera Head  
GP-US522H  
GP-US532H  
3 CCD Color Camera CCU  
GP-US522CU

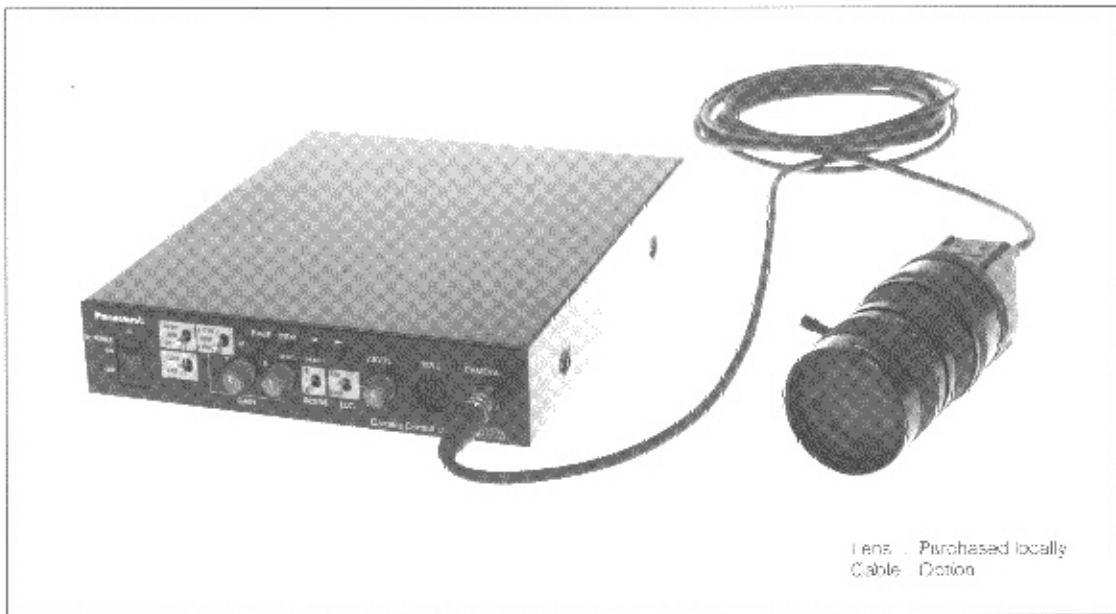

## Panasonic®

Before attempting to connect or operate this product, please read these instructions completely.

# CONTENTS

PREFACE .....	1
FEATURES .....	1
PRECAUTIONS .....	2
MAJOR OPERATING CONTROLS AND THEIR FUNCTIONS .....	3
Camera Head .....	3
Camera Control Unit .....	3
CONNECTIONS .....	7
SETUP .....	9
1. CAMERA SETUP MENU .....	9
2. SETUP OPERATION .....	9
SETTING PROCEDURES .....	11
PREVENTION OF BLOOMING AND SMEAR .....	19
SPECIFICATIONS .....	20
OPTIONAL ACCESSORIES .....	21

**CAUTION:**

Before attempting to connect or operate this product, please read the label on the bottom.



**CAUTION**

RISK OF ELECTRIC SHOCK  
DO NOT OPEN



**CAUTION:**  
TO REDUCE THE RISK OF ELECTRIC SHOCK, DO NOT REMOVE COVER (OR BACK). NO USER SERVICEABLE PARTS INSIDE.  
REFER SERVICING TO QUALIFIED SERVICE PERSONNEL.

For U.S.A

**Warning:**  
This equipment generates and uses radio frequency energy and if not installed and used properly, i.e., in strict accordance with the instruction manual, may cause harmful interference to radio communications. It has been tested and found to comply with the limits for a Class A computing device pursuant to Subpart J of Part 15 of FCC Rules, which are designed to provide reasonable protection against such interference when operated in a commercial environment.



The lightning flash with arrowhead symbol, within an equilateral triangle, is intended to alert the user to the presence of uninsulated "dangerous voltage" within the product's enclosure that may be of sufficient magnitude to constitute a risk of electric shock to persons.

SA 1965



The exclamation point within an equilateral triangle is intended to alert the user to the presence of important operating and maintenance (servicing) instructions in the literature accompanying the appliance.

SA 1966

The serial number of this product may be found on the bottom of the unit.  
You should note the serial number of this unit in the space provided and retain this book as a permanent record of your purchase to aid identification in the event of theft.

Model No. \_\_\_\_\_

Serial No. \_\_\_\_\_

**WARNING:**  
TO PREVENT FIRE OR ELECTRIC SHOCK HAZARD, DO NOT EXPOSE THIS APPLIANCE TO RAIN OR MOISTURE.

# PREFACE

Panasonic's GP-US522/532 Industrial Digital Signal Processing Color 3-CCD Camera overcomes space limitations that have complicated many video applications.

The GP-US522/532 incorporates Three 380 000-pixels (768 (H) x 494 (V)) Interline Transfer CCDs to give you

a remarkable 800 lines (750 lines for GP-US532) of horizontal resolution and a S/N ratio is 62 dB. This means you get a color picture with high visual information content, for excellent image detail.

Because it features digital signal processing, the GP-US522/532 provides an exceptionally stable picture.

# FEATURES

1. High-performance micro prism optical system with three 1/2" IT CCDs
2. 800 lines of horizontal resolution for GP-US522 and 750 lines for GP-US532
3. 62 dB of signal to noise ratio
4. Minimum scene illumination with + 18 dB gain of 5 lux at F2.8 for GP-US522 and 9 lux at F2.2 for GP-US532
5. Auto Tracing White Balance (ATW), Auto White Balance Control (AWC) or Manual White Balance Control are selectable
6. Automatic Setting of Black Balance (ABC) or Manual Setting
7. Gen-Lock capability
8. SMPTE color bar generator
9. Automatic Gain Control (AGC) and Electronic Light Control(ELC) are available
10. Automatic (AUTO), Step (STEP) and Manual (MANU) setting of Electronic shutter modes are selectable
11. 12V DC operation
12. RGB and S-Video Outputs
13. Character Generator Input
14. 2 SCENE files are selectable

# PRECAUTIONS

**1. Do not attempt to disassemble the camera or camera control unit.**

To prevent electric shock, do not remove screws or covers.

There are no user-serviceable parts inside.

Ask a qualified service person for servicing.

**2. Handle the camera and the camera control unit with care.**

Do not abuse the camera and the camera control unit. Avoid striking, shaking, etc. The camera could be damaged by improper handling or storage.

**3. Do not expose the camera or camera control unit to rain or moisture, or try to operate it in wet areas.**

Turn the power off immediately and ask a qualified service person for servicing. Moisture can damage the camera and the camera control unit, and also create the danger of electric shock.

**4. Do not drop anything inside the camera or camera control unit.**

Dropping a metal part for example inside the camera and camera control unit could permanently damage the unit.

**5. Do not crush or pinch the camera cable.**

Do not bend the camera cable into a curve whose radius is small.

**6. Never face the camera toward the sun.**

Do not aim the camera at bright objects. Whether the camera is in use or not, never aim it at the sun or other extremely bright objects. Otherwise, blooming or smear may be caused.

**7. Do not use strong or abrasive detergents when cleaning the camera or the camera control unit body.**

Use a dry cloth to clean the camera or the camera control unit when dirty.

In case the dirt is hard to remove, use a mild detergent and wipe gently.

**8. Clean the faceplate with care.**

Do not clean the faceplate with strong or abrasive detergents. Use lens tissue or a cotton tipped applicator and ethanol.

**9. Put the lens cap on the camera after using the camera.**

After using the camera, turn the power of the camera control unit off, and put the lens cap on the camera head.

**10. Connect together only the camera head and the GP-US522CU camera control unit.**

Otherwise it may cause a improper operation.

**11. Do not operate the camera and the camera control unit beyond the specified temperature, humidity, or power source ratings.**

Use the camera and the camera control unit under conditions where temperature is between 0°C - +45°C (32°F - 113°F), and humidity is below 90%. The input power resource is 12 V DC.

**12. Ask a qualified service person for installation.**

All necessary procedures, with regards to installation of this product, should be made by qualified service person for servicing or system installer.

**Cautions:**

1. Connecting or disconnecting camera cable to/from the camera control unit or camera head must be done after turning off the power of the camera control unit.
2. Use GP-CA522/4 (4 m/13 ft) camera cable only to connect it between the camera head and camera control unit. Do not extend the cable.

# MAJOR OPERATING CONTROLS AND THEIR FUNCTIONS

## Camera Head

### 1. Lens Mount

This is used to attach the special C-mount lens for GP-US522 and the C-mount lens for GP-US532.

### 2. Camera Cable Connector

This 24-pin connector is used to connect the optional camera cable GP-CA522/4 to the camera control unit.

### 3. Camera Mounting Screw Hole

This hole (1/4" - 20) is used to mount the camera onto a mounting bracket.

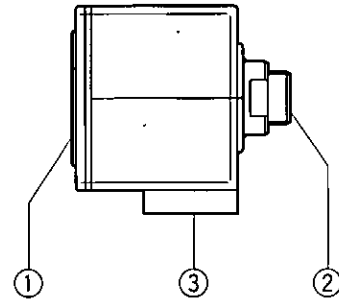

## Camera Control Unit

### [Front Panel]

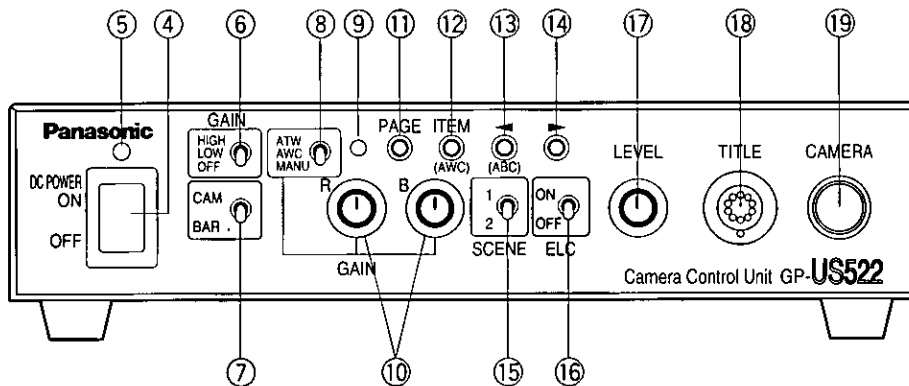

### 4. Power ON/OFF Switch (DC POWER ON/OFF)

This switch turns the power of this unit and power supply for the camera head on or off.

### 5. Power Indicator (POWER)

This indicator lights up red when the power switch is turned on.

### 6. Automatic/Manual Gain Selector Switch (GAIN HIGH/LOW/OFF)

This selector is used to select the gain of video amplifier as follows.

The mode can be selected in the SET UP menu.

Refer to page 14.

MODE	POSITION OF SW	GAIN
AUTO	HIGH	Maximum +18 dB
	LOW	Maximum +9 dB
	OFF	0 dB
MANU	HIGH	+18 dB (Fixed)
	LOW	+9 dB (Fixed)
	OFF	0 dB

### 7. Camera/Color Bar Selector (CAM/BAR)

This selector is used to select either the video signal or the SMPTE color bar signal which is output from the video output connector (VIDEO), YC (S-VIDEO) output connector or RGB (D-SUB, 9-pin) output connector.

**CAM** : The video signal from the camera is output.

**BAR** : The SMPTE color bar signal is output.

Set this switch to BAR when making video monitor adjustments and recording the color bar signal.

### 8. White Balance Selector (ATW/AWC/MANU)

This selector is used to select the white balance mode from followings.

**ATW** : In this mode, the color temperature is monitored continuously and thereby white balance is set automatically.

**AWC** : In this mode, accurate white balance is obtained.

The white balance settings are as follows:

1. Aim the camera at white chart.
2. Press the ITEM (AWC) button on the front panel to set the white balance.
3. When the auto white balance is completed, the auto warning indicator goes off after blinking.

If the auto warning indicator is kept being lit, follow the setting procedures above for auto white balance setting again.

**MANU** : The white balance can be adjusted manually by the red gain (R GAIN) and blue gain controls (B GAIN).

### 9. Auto Warning Indicator

This indicator blinks while the white balance or black balance is being automatically set. This indicator lights continuously when the white balance or black balance is set improperly. In this case, follow the auto white balance or black balance setting procedure.

### 10. Red and Blue Gain Controls (R GAIN/B GAIN)

These controls are used to manually adjust the white balance.

These controls only work when the white balance selection switch (ATW/AWC/MANU) is set to MANU.

Turn the controls clockwise to increase the red and blue signal levels, and counterclockwise to decrease.

### 11. Page Button (PAGE)

This button is used to display the SETUP MENU by pressing for 2 seconds or more, and to change the parameters in the SET UP MENU.

### 12. Item Button (ITEM/AWC)

While the SET UP menu is displayed, this button is used to move the cursor to the downward.

Normally, when the white balance selection switch (ATW/AWC/MANU) is set to AWC, this button is used to set the automatic white balance control (AWC).

### 13. Left Button (◀/ABC)

While the SET UP menu is displayed, this button is used to move the cursor to the left.

Normally, this button is used to set the automatic black balance control (ABC).

### 14. Right Button (▶)

This button is used to move the cursor to the right in the SET UP menu.

### 15. Scene File Selector (SCENE)

This selector is used to select the scene files.

### 16. Electronic Light Control ON/OFF Selector (ELC ON/OFF)

This selector is used to select the electronic light control from followings.

**ON** : In this position, the electronic light control (ELC) mode is selected and the Electronic Shutter Speed (SHUTTER) mode is interrupted.

**OFF** : In this position the shutter speed mode (SHUTTER) is selected and electronic light control (ELC) mode is interrupted.

**Note :**

- Confirm the setting of the ELC and SHUTTER parameters on the SET UP menu.

### 17. Electronic Shutter Speed Control (LEVEL)

This control is used to set the target value of Electronic Shutter Speed between 1/60 and 1/10 000 second together with ELC ON/OFF switch.

### 18. Title Input Connector (TITLE)

This connector is used to connect the optional Character Generators WJ-KB30 or WJ-KB50.

**Note :**

The Black & White characters of the generator are mixed with the video signal and are obtained at VIDEO OUT, S-VIDEO (Y/C) OUT and RGB/SYNC OUT connectors.

No colorization of the character is available.

### 19. Camera Cable Connector (CAMERA)

This 20-pin connector is used for connection with the camera head via the optional camera cable GP-CA522/4.

Fasten the camera cable to this connector firmly. If not, noise may be appeared.

**Caution:**

Connecting or disconnecting camera cable to/from the camera control unit or camera head must be done after turning off the Power of the camera control unit.

For Camera

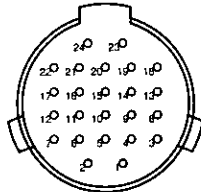

For CCU

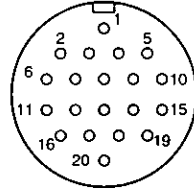

Camera Head Side

1	+15V Input
2	Ground (GND)
3	Chip Select Input
4	+25 Input
5	-9V Input
6	B Signal Output
7	RGB Ground (GND)
8	Serial Data Input
9	Serial Clock Input
10	CCD Select Output
11	G Signal Output
12	R Signal Output
13	VD Input
14	CPOB Output
15	HD Input
16	+9V Input
17	+5V Input
18	PBLK Output
19	Not used
20	Not used
21	Not used
22	Not used
23	28MHz Input
24	Not used

Camera Control Unit Side

1	Ground (GND)
2	Not used
3	PBLK Input
4	+9V Output
5	-9V Output
6	28MHz Output
7	CPOB Input
8	RGB Ground (GND)
9	+5V Output
10	B Signal Input
11	Serial Clock Output
12	VD Output
13	Chip Select Output
14	+25 Output
15	R Signal Input
16	Serial Data Output
17	HD Output
18	G Signal Input
19	+15V Output
20	CCD Select Input

**[Rear Panel]**

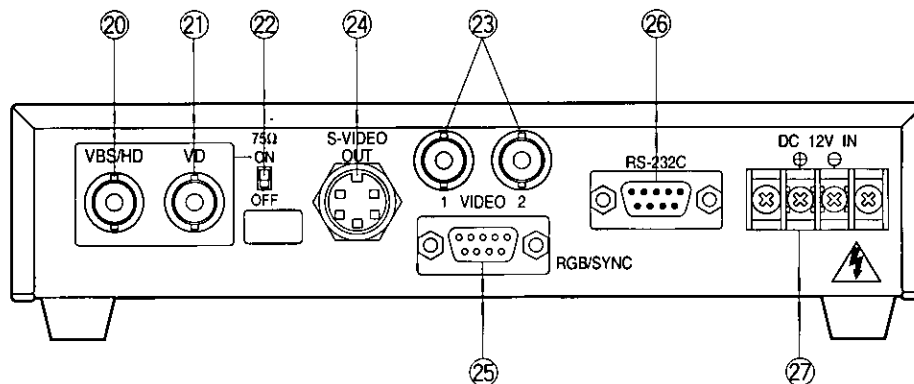

### 20. Gen-lock Signal Input Connector (VBS/HD)

The color video signal of the camera is automatically synchronized to the gen-lock signal (Composite Signal, Black Burst Signal or Video Sync) when either signal is supplied to this connector. The gen-lock signal is used for system reference.

**Caution :**

If the gen-lock signal is jittery (as in the case of a VCR playback picture), the camera can not be synchronized properly.

**(External HD and VD Mode)**

The horizontal and vertical pulse of the color video signal is synchronized to the external HD fed to this connector and external VD fed to the VD input connector.

### 21. Gen-Lock Signal Input Connector (VD)

Supply the external vertical drive (VD) pulse to this connector.

### 22. Gen-Lock Video 75 Ω Termination ON/OFF Switch (75 Ω ON/OFF)

When looping through the gen-lock video signal with BNC "T" adapter, set this switch to OFF. When not looping through, set this switch to ON.

### 23. Video Output Connector (VIDEO 1,2)

A 1.0V[p-p]/75 Ω composite video signal is provided at this connector.

#### 24. S-Video Output Connector (S-VIDEO OUT)

The luminance (Y) and chrominance (C) signals for VCR or monitor are provided at this connector.

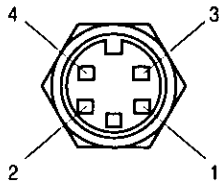

S-VIDEO OUT (Mini-DIN,4-pin)

Pin No.	Description
1	Y Ground
2	C Ground
3	Y Signal Output (0.714V[p-p](Y level)/75 Ω)
4	C Signal Output (0.286V[p-p](Burst Level)/75 Ω)

#### 25. RGB/SYNC Output Connector (RGB/SYNC)

The red, green, blue, sync and composite video signals are provided at this connector.

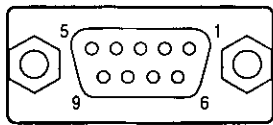

RGB/SYNC (D-SUB,9-pin)

Pin No.	Description
1	Ground( GND)
2	Ground (GND)
3	Red (R) Output (0.7V[p-p]/75 Ω)
4	Green (G) Output (0.7V[p-p]/75 Ω)
5	Blue (B) Output (0.7V[p-p]/75 Ω)
6	Composite Video Output (1.0V[p-p]/75 Ω)
7	Sync (SYNC) Output (4.0V[p-p] or 0.3V[p-p]/75 Ω)
8	Ground (GND)
9	Ground (GND)

#### 26. RS-232C Connector (RS-232C)

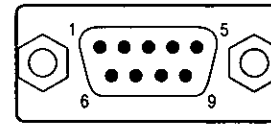

Pin No	Signal
	RS-232C
1	Ground
2	TXD
3	RXD
4	DSR
5	Ground
6	DTR
7	CTS
8	RTS
9	Ground

**Note:** Refer to the qualified system pasonnel or system Installers for this connection.

#### 27. 12V DC Input Terminals (12V DC IN)

These terminals accept an external DC power source supplying nominal power of 12V DC, 0.7A.



#### Cautions :

1. Connect to 12V DC (11.5 V - 16 V) class 2 power supply only.
2. To prevent fire or electric shock hazard, use a UL listed wire VW-1, Style 1007 cable for 12 V DC input terminals.



# CONNECTIONS

## Cautions :

1. Keep the DC POWER ON/OFF switch in the OFF position until all connections have been properly made.
2. Connect the camera head and camera control unit.

## Internal Sync Operation

1. Connect the camera cable between the camera head and the camera control unit.
2. Connect the coaxial cable with BNC connectors between the video output connector of the camera control unit and the video monitor or VCR.

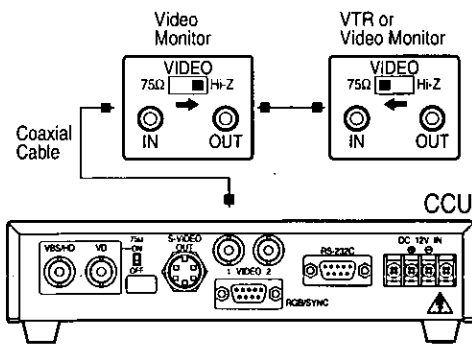

3. Connect the power cable between the DC 12 V input terminals and the 12 V DC power supply unit (obtained locally).

- Calculation method of maximum cable length between camera control unit and power supply unit is as follows.

$$11.5 \text{ V DC} < V_A - (R \times 0.42 \times L) < 16 \text{ V DC}$$

L : Cable length (meter)

R : Resistance of copper wire ( $\Omega$ /meter)

$V_A$  : DC output voltage of power supply unit

$$L \text{ standard} = V_A - 12 / 0.42 \times R \text{ (meter)}$$

$$L \text{ minimum} = V_A - 16 / 0.42 \times R \text{ (meter)}$$

$$L \text{ maximum} = V_A - 11.5 / 0.42 \times R \text{ (meter)}$$

## Cautions :

1. Connect to 12 V DC (11.5 V - 16 V) class 2 power supply only.
2. To prevent fire or electric shock hazard, use a UL listed wire VW-1, Style 1007 cable for 12 V DC input terminals.

## Gen-lock Operation

1. Connect the camera cable between the camera head and the camera control unit.
2. Connect the coaxial cable with BNC connectors between the video output connector of the camera control unit and the video input connector of Special Effects Generator (SEG), and between the VBS/HD input connector of the camera control unit.

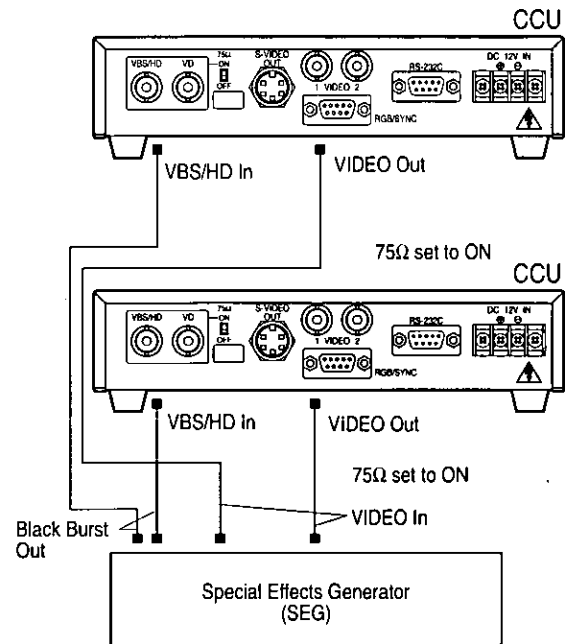

3. Connect the power cable between the DC 12 V input terminals and the 12V DC power supply unit (obtained locally).

## Cautions :

1. Connect to 12 V DC (11.5 V - 16 V) class 2 power supply only.
2. To prevent fire or electric shock hazard, use a UL listed wire VW-1, Style 1007 cable for 12 V DC input terminals.

## Mounting the Lens

### Caution :

Keep the POWER ON/OFF switch of camera control unit in the OFF position throughout the installation.

### Lens Mount

1. Remove the front cap of the camera head and confirm that the surface of the optical filter of the camera head is clean.  
If the surface of the optical filter is dirty clean it up with a blower brush which is for film camera lenses (available at your local camera store).
2. Mount the C-mount lens by turning it clockwise onto the lens mount of the camera head.

### Caution :

- Do not use any lens which has more than 1/8" (3.5mm) of protrusion for lens mounting. (GP-US522)
- Do not open the lens iris wider than the F2.8 stops. (GP-US522)
- Do not open the lens iris wider than the F2.2 stops. (GP-US532)

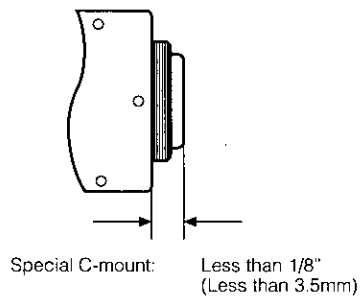

# SET UP

## 1. CAMERA SETUP MENU

This camera utilizes a user setup menu that is displayed on-screen.

The setup menu contains various items that form a tree-type structures as shown below.

It is described in the following section: "2. SETUP OPERATION".

**Note:**

- The SET UP menu is output from the VIDEO 1, 2 connectors, the S-VIDEO OUT connector, and the RGB/SYNC connector.

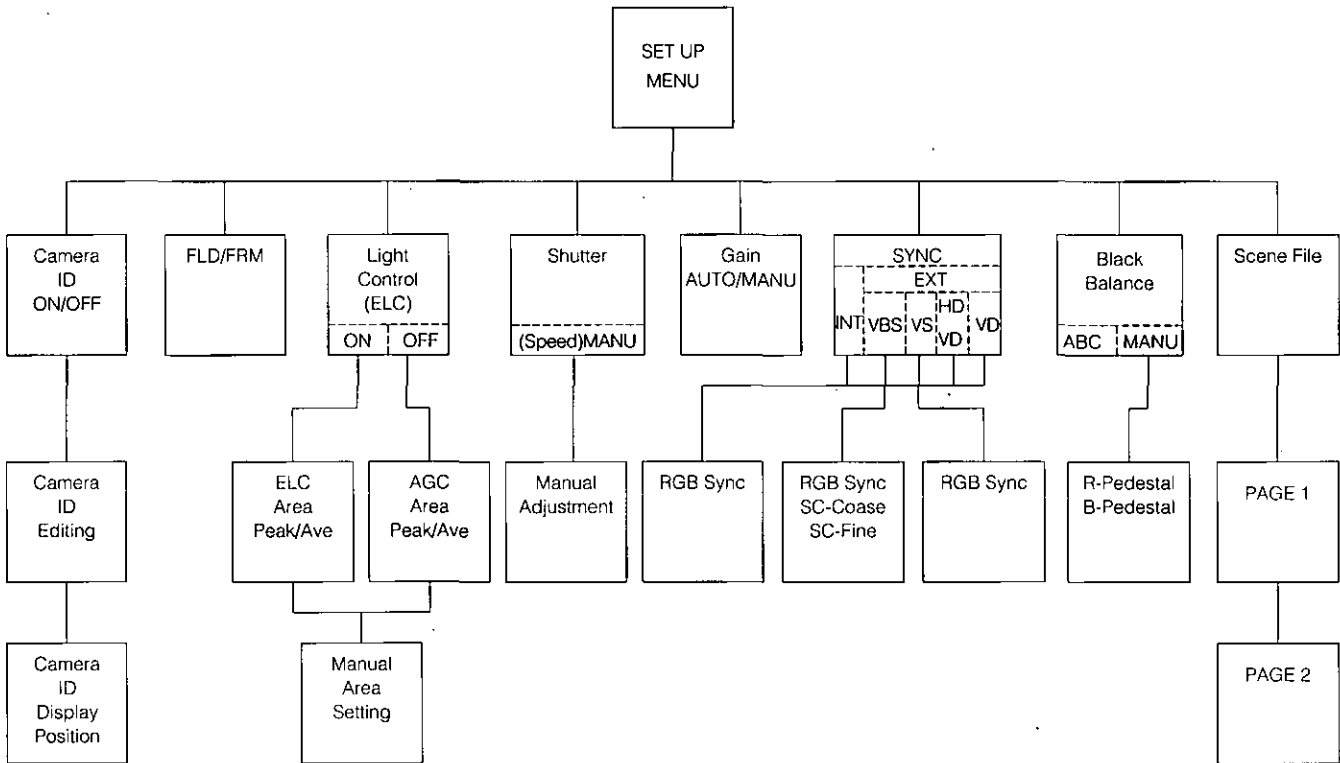

## 2. SETUP OPERATION

This camera utilizes a user setup menu (SET UP) that is displayed on the monitor.

To set items on the SET UP menu, use the following buttons on the front panel of the camera control unit.

**Page Button (PAGE) :**

This button used to display the SET UP menu. Use this button to select an item.

**Item Button (ITEM) :**

This button is used to move the cursor downwards.

**Left Button (◀) :**

This button is used to move the cursor to the left. Use this button to select or adjust the parameters of the selected item. The parameter changes each time this button is pressed.

**Right Button (▶) :**

This button is used to move the cursor to the right. Use this button to select or adjust the parameters of the selected item. The parameter changes each time this button is pressed.

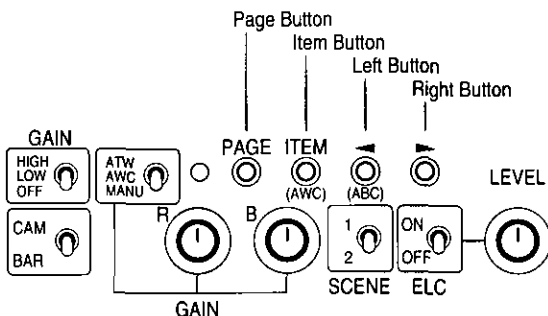

- **Opening the SET UP menu**

Press the PAGE button for a few seconds.

```
  ** SET UP **  
  
CAMERA ID      *OFF  
FLD/FRM       FLD  
ELC           *OFF  
SHUTTER       OFF  
GAIN          AUTO  
SYNC          INT  
BLACK BAL     ABC  
SCENE FILE    *SCENE1  
  
END
```

- **Editing the SET UP menu**

To edit the SET UP menu (change settings), press the ITEM button to move the cursor to an item, and press ◀ and ▶ to change its parameter. After completing all the settings, move the cursor to END at the bottom line, and press the PAGE button. The new values are stored in the EEPROM (Electric Erasable and Programmable Read Only memory). These values remain valid until new values are stored, even if the power of the camera control unit is off.

```
  ** SET UP **  
  
CAMERA ID      *OFF  
FLD/FRM       FLD  
ELC           *OFF  
SHUTTER       OFF  
GAIN          AUTO  
SYNC          INT  
BLACK BAL     ABC  
SCENE FILE    *SCENE1  
  
END
```

- **All Reset Operation**

All Reset allows you to reset all setup menu items to the factory settings if you are unsure about the correct settings. Proceed as follows:

1. Repeat the above procedures to display the SET UP menu.
2. Move the cursor to END at the bottom line.
3. Press both ◀ and ▶ for a few seconds. The SET UP menu disappears on the monitor screen and the auto warning indicator lights red.

At this time, all adjustments and parameters are reset to the factory default settings. The auto warning indicator goes off if AWC or ABC is performed.



1. Move the cursor to the FLM/FRM parameter.
2. Select FLM (field) or FRM (frame).  
**Note:**  
When FRM is selected, ELC is set to OFF automatically.

### 3. Electronic Light Control Setting (ELC)

The electronic light control function eliminates interference by strong background lighting which makes the camera picture dark, such as a spotlight. In the ELC mode, more photometric weight is given to the desired point of the screen (to where the important object is located).

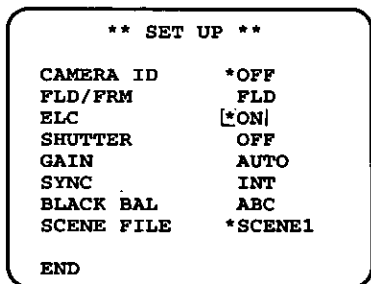

#### 3-1. ELC detection control area setting (ELC CONT)

1. Select ON for the ELC ON/OFF selector on the front panel of the camera control unit. Then confirm the ELC parameter is ON.

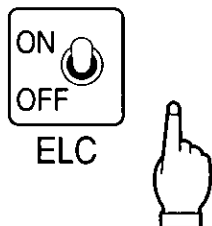

2. Move the cursor to the ELC parameter and press the PAGE button.  
The ELC CONT menu appears.

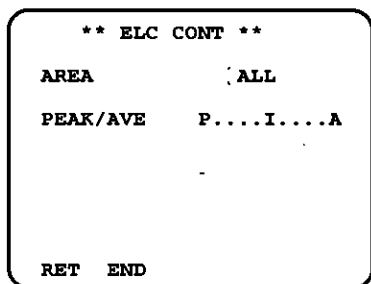

3. Move the cursor to the AREA parameter and select the desired detection area. You can select the desired detection area from followings.  
**ALL:** All areas on the monitor screen are detected.  
**MANU:** Detection areas are selectable manually.  
See below for details.  
**CENTER:** The photometric weight is given to the center of the monitor screen.  
**S CIRCLE (Small Circle):** The photometric weight is given to the areas in the small circle of the monitor screen.  
**M CIRCLE (Medium Circle):** The photometric weight is given to the areas in the medium circle of the monitor screen.  
**L CIRCLE (Large Circle):** The photometric weight is given to the areas in the large circle of the monitor screen.

Each time you press ◀ or ▶, the parameter changes as follows.

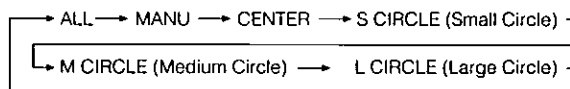

ALL

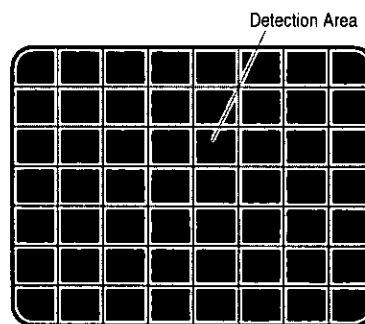

CENTER

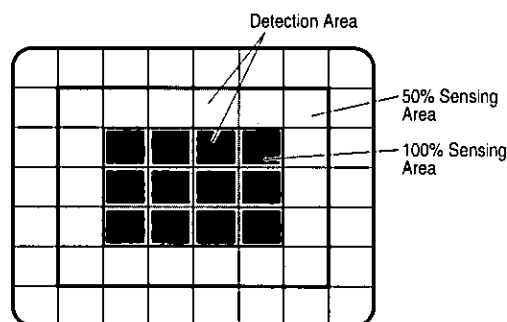

S CIRCLE (Small Circle)

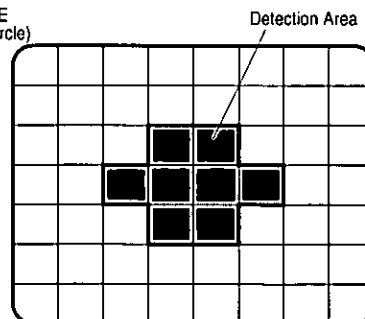

M CIRCLE  
(Medium Circle)

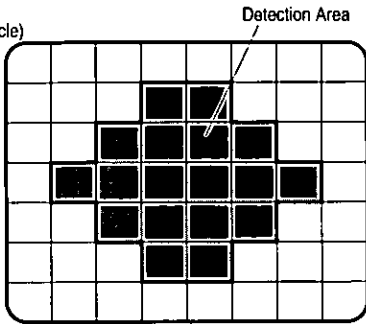

L CIRCLE  
(Large Circle)

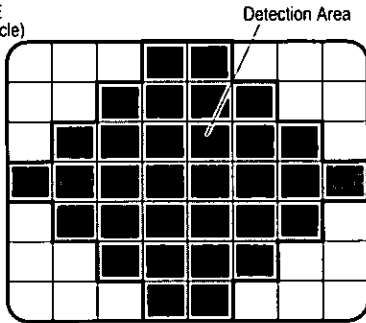

**Note:** Detection areas are not displayed on the monitor.

### 3-1-1. Manual setting of the ELC detection control area (MANU)

You can mask areas on the monitor screen to block the strong brightness manually. Follow the steps below:

**Notes:**

The manual mask setting field is only displayed on VIDEO1, 2 and S-VIDEO OUT.

It is not displayed on RGB/SYNC output.

1. Move the cursor to the AREA parameter on the ELC CONT menu.
2. Select MANU and press the PAGE button. The manual mask setting field appears.

Cursor  
(WHITE)

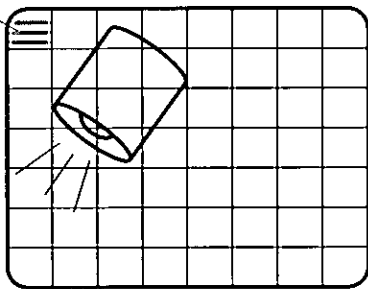

3. Select the area where backlight is bright by ◀, ▶ or the ITEM button.

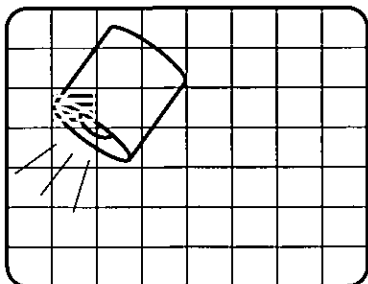

4. Press the PAGE button to mask that area. The mask turns white. (When the cursor is moved on an area that has already been masked, the mask and cursor start blinking.)

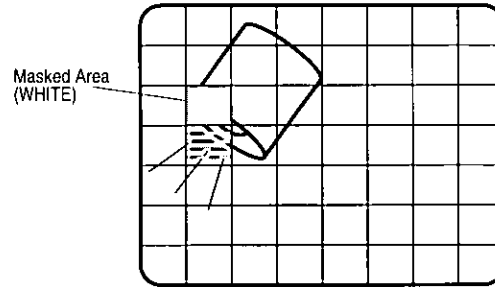

**Note:** The area masked white will not be used in the ELC detection.

5. Repeat the steps 3 and 4 to complete masking. To cancel masking, move the cursor to that area and press the PAGE button.

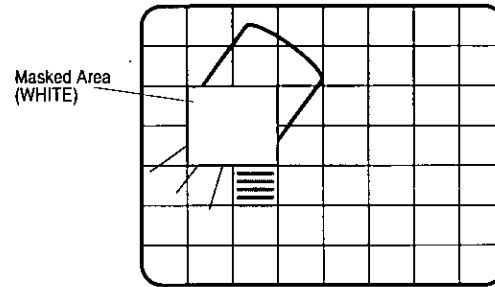

6. After masking is completed, press the PAGE button for a second or more. The ELC CONT menu appears.

### 3-1-2. Peak and Average Weight Control (PEAK/AVE)

1. Move the cursor to the PEAK/AVE parameter. The "I" cursor starts blinking.

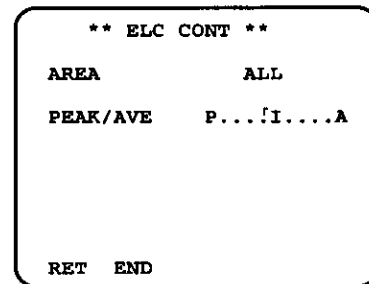

2. Move the "I" cursor to set the detection value. When the "I" cursor is moved to the P (peak) side, the peak value is detected. When the "I" cursor is moved to the A (average) side, the average value is detected.

### 3-2. AGC detection control area setting (AGC CONT)

1. Select OFF for the ELC ON/OFF selector on the front panel of the camera control unit. Then confirm the ELC parameter is OFF.

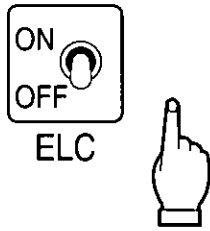

2. Move the cursor to the ELC parameter and press the PAGE button. The AGC CONT menu appears.

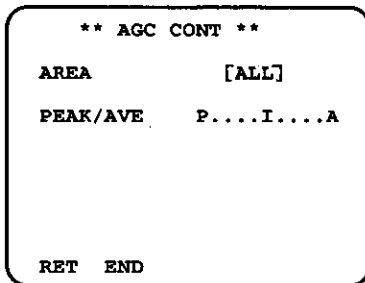

3. Follow the same step 3 of "3-1. ELC detection control area setting (ELC CONT)" to select the desired detection area (AREA).
4. Follow the same steps 1 and 2 of "3-1-2. Peak and Average Weight Control (PEAK/AVE)" to set the detection value.

## 4. Electronic Shutter Speed Setting (SHUTTER)

**Note:** When ON is selected for ELC on the SET UP menu, this item is not available. To select the electronic shutter speed, select OFF for ELC on the SET UP menu.

You can select the electronic shutter speed of 1/100, 1/250, 1/500, 1/1 000, 1/2 000, 1/4 000 or 1/10 000 seconds. Also manual setting is available.

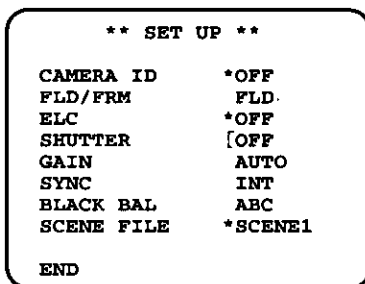

1. Move the cursor to the SHUTTER parameter.
2. Select the shutter speed or MANU for manual setting from the following.

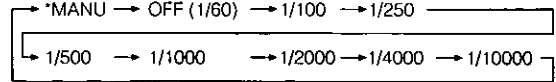

3. When you select MANU, press the PAGE button. The SHUTTER menu appears and the MANU SET parameter starts blinking.

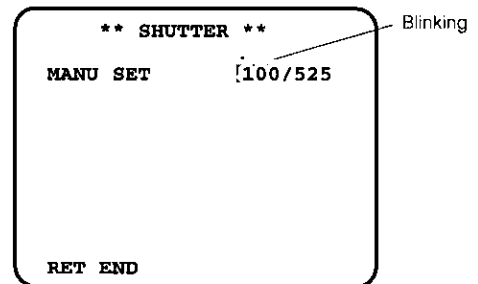
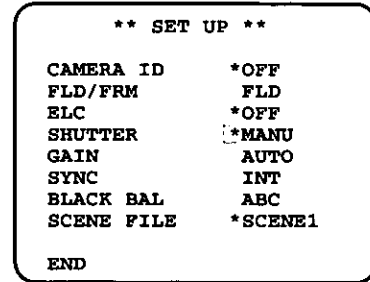

4. Select the desired electronic shutter speed by ◀ or ▶. The adjustable range is 1/525-261/525 lines.

## 5. Gain Control Setting (GAIN)

You can set the gain (brightness level portion of an image) to automatic level adjustment (AUTO) or manual level adjustment (MANU).

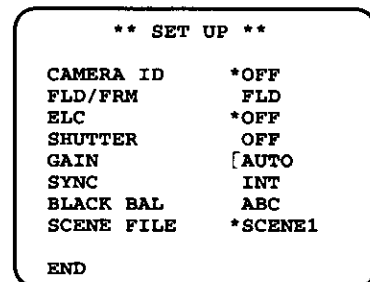

1. Move the cursor to the GAIN parameter.
2. Select AUTO or MANU. The gain of the video amplifier is changed according to the position of the automatic/manual gain selector (HIGH/LOW/OFF) on the front panel of the camera control unit.



When you select AUTO, the gain of the amplifier changes as follows.

Position	Gain
HIGH	Maximum +18 dB
LOW	Maximum +9 dB
OFF	0 dB

When you select MANU, the gain of the amplifier changes as follows.

Position	Gain
HIGH	+18 dB (Fixed)
LOW	+9 dB (Fixed)
OFF	0 dB

## 6. Synchronization Setting (SYNC)

This model accepts the VBS signal (color composite video or blackburst signal) and VS signal (B/W composite video or composite sync signal) for the gen-lock operation.

This camera also accepts the vertical drive pulse (VD) with horizontal drive pulse (HD), and the vertical drive pulse (VD) only.

```

** SET UP **

CAMERA ID      *OFF
FLD/FRM        FLD
ELC             *OFF
SHUTTER        OFF
GAIN           AUTO
SYNC           [INT]
BLACK BAL      ABC
SCENE FILE     *SCENE1

END
    
```

### Important Notices:

- The priority for the sync mode is as follows:
  - Color composite video signal (VBS)
  - B/W composite video signal (VS)
  - HD/VD signal
  - VD signal
  - Internal sync (INT)
- When the internal sync (INT) mode is to be used, no gen-lock input signal should be supplied to the gen-lock input connector on the rear panel of the camera control unit.
- When the VBS or VS gen-lock mode is to be used, supply the gen-lock input signal to the gen-lock input connector on the rear panel of the camera control unit.
- The VBS gen-lock mode has its own menu for horizontal and subcarrier phase adjustments. When the cable length of the video output or the gen-lock input is changed, horizontal and subcarrier phase must be re-adjustable.

- The VS gen-lock mode has its own menu for horizontal and subcarrier phase adjustments. When the cable length of the video output or the gen-lock input is changed, the horizontal phase must be re-adjusted.
- When the HD/VD or VD pulse is to be used, supply them to the VBS/HD connector and the VD connector on the rear panel of the camera control unit.

### 6-1. Internal Sync Mode (INT)

RGB Sync Output Level Adjustment (RGB SYNC)

- Move the cursor to the SYNC parameter.
- Press the PAGE button. The SYNC menu appears on the monitor screen.

```

** SYNC **

RGB SYNC      [0.3V]

RET  END
    
```

- Move the cursor to the RGB SYNC parameter.
- Select 4.0V or 0.3V according to the RGB monitor input level.

### 6-2. VBS Gen-lock Mode (EXT(VBS))

- Move the cursor to the SYNC parameter.
- Connect the coaxial cable for the blackburst or composite color video signal to the gen-lock input connector.
- Confirm that the INT parameter changed to EXT(VBS) on the menu.

**Caution:** The gen-lock input signal should meet the EIA RS-170A specifications and should not contain jitter, such as a VCR playback signal, as it could disturb synchronization.

```

** SET UP **

CAMERA ID      *OFF
FLD/FRM        FLD
ELC             *OFF
SHUTTER        OFF
GAIN           AUTO
SYNC           [*EXT(VBS)]
BLACK BAL      ABC
SCENE FILE     *SCENE1

END
    
```

- After confirming that the cursor is on EXT(VBS), press the PAGE button. The SYNC menu appears on the monitor screen.

```

** SYNC **
RGB SYNC      0.3V
H PHASE       -....I....+
SC COARSE     1(1--4)
SC FINE       -I.....+
RET  END

```

- Move the cursor to the RGB SYNC parameter.
- Select 4.0V or 0.3V according to the RGB monitor input level.

### Horizontal Phase Adjustment (H PHASE)

- Move the cursor to H PHASE. The cursor starts blinking.
- Supply the video output signal of the camera to be adjusted and the reference gen-lock input signal to a dual-trace oscilloscope.
- Set the oscilloscope to the horizontal sync portion on the oscilloscope.
- Adjust the horizontal phase by pressing ◀ or ▶. The adjustable range is 0-1.5 μs.

**Note:** To reset H PHASE to the values preset at the factory, press ◀ and ▶ simultaneously. The H PHASE is reset at the factory setting.

### Subcarrier Coarse Phase Adjustment (SC COARSE)

- Move the cursor to SC COARSE parameter on the SYNC menu. The cursor starts blinking.
- Press ◀ or ▶ to match the color (hue) of the camera's video signal, when observed at the output of the Special Effect Generator (SEG) or Switcher, as closely as possible the color of the original scene. (The SC COARSE adjustment can be incremented in steps of 90 degrees (4 steps) by pressing ◀ or ▶.)

**Note:**

After the fourth step, the adjustment returns to the first step.

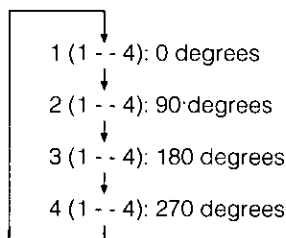

### Subcarrier Fine Phase Adjustment (SC FINE)

- Move the cursor to SC FINE on the SYNC menu. The cursor starts blinking.
- Press ◀ or ▶ to match the color (hue) of the camera's video signal, when observed at the output of the Special Effect Generator (SEG) or Switcher, as closely as possible the color of the original scene. The SC FINE adjustment has a range of 90 degrees of color shift.

**Notes:**

- When the "I" cursor reaches the "+" end, it jumps back to "-". At the same time, SC COARSE is incremented by one step to enable a continuous adjustment. The reverse takes place when the "I" cursor reaches the "-" end.

For more accurate adjustment, supply both the original camera video output signal and the effect output video signal (program output video signal) of the special effects generator (SEG) to a vectorscope and compare the chroma phase of both signals.

- To reset SC FINE to the values preset at the factory, press ◀ and ▶ simultaneously. The SC FINE is reset at the factory setting.

### 6-3. VS Gen-lock Mode (EXT(VS))

- Move the cursor to the SYNC parameter.
- Connect the coaxial cable for the composite sync or composite B/W video signal to the gen-lock input connector.
- Confirm that the INT parameter changed to EXT(VS) on the menu.

**Caution:** The gen-lock input signal should meet the EIA RS-170 specifications and should not contain jitter, such as a VCR playback signal, as it could disturb synchronization.

```

** SET UP **
CAMERA ID      *OFF
FLD/FRM        FLD
ELC            *OFF
SHUTTER        OFF
GAIN           AUTO
SYNC           [*EXT(VS)
BLACK BAL      ABC
SCENE FILE     *SCENE1
END

```

- After confirming the cursor is on EXT (VS), press the PAGE button. The phase adjustment menu appears on the monitor screen.

```

** SYNC **
RGB SYNC      0.3V
H PHASE       -....I....+
RET  END

```

- Move the cursor to the RGB SYNC parameter.
- Select 4.0V or 0.3V according to the RGB monitor input level.
- Move the cursor to H PHASE. The cursor starts blinking.

- Supply the video output signal of the camera to be adjusted and the reference gen-lock input signal to a dual-trace oscilloscope.
- Set the oscilloscope to the horizontal rate and expand the horizontal sync portion on the oscilloscope.
- Adjust the horizontal phase by pressing ◀ or ▶. The adjustable range is 0-1.5 μs.

#### 6-4. External HD/VD Mode (HD/VD)

- Move the cursor to the SYNC parameter.
- Connect the coaxial cable for the external HD and VD signal to the gen-lock input connector and the VD input connector respectively.
- Confirm that the INT parameter changed to EXT (H/V) on the menu.
- Move the cursor to the RGB SYNC parameter.
- Select 4.0V or 0.3V according to the RGB monitor input level.

```

** SET UP **

CAMERA ID      *OFF
FLD/FRM        FLD
ELC            *OFF
SHUTTER        OFF
GAIN           AUTO
SYNC           [*EXT(H/V)]
BLACK BAL      ABC
SCENE FILE     *SCENE1

END

```

#### 6-5. External VD Mode (VD)

- Move the cursor to the SYNC parameter and select INT.
- Connect the coaxial cable for the external VD signal to the VD input connector.
- Confirm that the INT parameter changed to EXT (VD) on the menu.
- Move the cursor to the RGB SYNC parameter.
- Select 4.0V or 0.3V according to the RGB monitor input level.

```

** SET UP **

CAMERA ID      *OFF
FLD/FRM        FLD
ELC            *OFF
SHUTTER        OFF
GAIN           AUTO
SYNC           [*EXT(VD)]
BLACK BAL      ABC
SCENE FILE     *SCENE1

END

```

## 7. Black Balance Setting (BLACK BAL)

In low light condition, correct setting of the black balance is required for producing correct colors. Once the black balance setting has set correctly, the setting maintained in a memory.

This setting will not be lost even if the camera control unit is turned off. However, for best results, it is recommended that the black balance adjustment be carried out the camera has not been used for a long period of time.

The black balance control mode can be selected between auto black balance control (ABC) on the front panel and manual control (MANU) on this menu.

#### 7-1. Auto Black Balance Setting (BLACK BAL)

- Move the cursor to the BLACK BAL parameter and select ABC.

```

** SET UP **

CAMERA ID      *OFF
FLD/FRM        FLD
ELC            *OFF
SHUTTER        OFF
GAIN           AUTO
SYNC           INT
BLACK BAL      [ABC]
SCENE FILE     *SCENE1

END

```

- Attach the lens cap on the camera lens.
- Move the cursor to END and press the PAGE button to close the SET UP menu.
- Press the ◀ (ABC) button on the front panel of the camera control unit. The auto black balance setting is performed.
- When the auto black balance is completed, the auto warning indicator goes off after blinking. If the indicator is kept being lit, follow the setting procedures above for auto black balance setting (ABC) again.

#### 7-2. Manual Black Balance Control Setting(MANU)

- Move the cursor to the BLACK BAL parameter and select MANU.

```

** SET UP **

CAMERA ID      *OFF
FLD/FRM        FLD
ELC            *OFF
SHUTTER        OFF
GAIN           AUTO
SYNC           INT
BLACK BAL      [*MANU]
SCENE FILE     *SCENE1

END

```

2. Press the PAGE button. The BLACK BAL menu (manual black balance setting menu) appears.

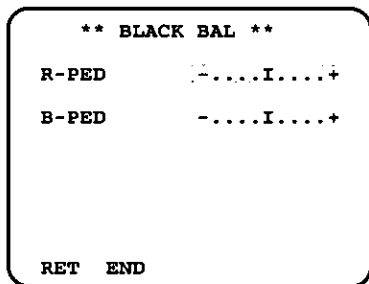

3. Move the cursor to R-PED. The cursor starts blinking.
4. Attach the lens cap on the camera lens.
5. While observing the vector scope or waveform monitor, adjust the red pedestal level (R-PED) by ◀ or ▶ for minimum carrier.
6. Move the cursor to B-PED. The cursor starts blinking.
7. While observing the vector scope or waveform monitor, adjust the blue pedestal level (B-PED) by ◀ or ▶ for minimum carrier.

**Note:** To reset the pedestal level to the factory setting, move the cursor to R-PED or B-PED and press the ◀ and ▶ button simultaneously for a second or more. The R-PED or B-PED level value reset to the factory setting.

## 8. Scene File Setting (SCENE FILE)

This menu allows for you to adjust and set 17 items for the video signal of camera to meet your requirement.

There are two scene files so that two settings are memorizable.

Switch the SCENE FILE 1 and the SCENE FILE 2 by the scene file selector on the front panel of the camera control unit.

1. Move the cursor to the SCENE FILE parameter and select SCENE 1.

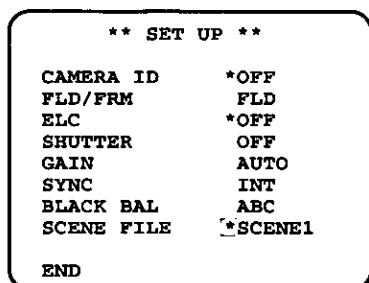

2. Press the PAGE button. The SCENE FILE menu appears.

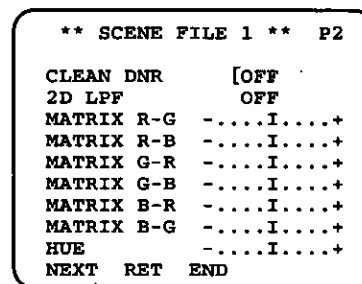
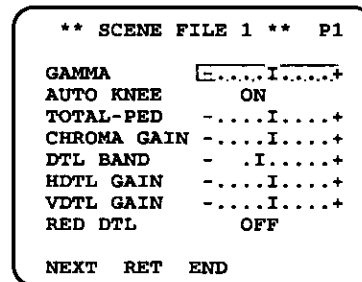

There are 2 pages for SCENE FILE (P1 and P2).

On page 1 (P1), you can set the following items:

- Gamma Correction (GAMMA)
- Auto Knee ON/OFF (AUTO KNEE)
- Total Pedestal Level Control (TOTAL-PED)
- Chrominance Level Control (CHROMA GAIN)
- Detail Band Control (DTL BAND)
- Horizontal Detail Gain Control (HDTL GAIN)
- Vertical Detail Gain Control (VDTL GAIN)

On page 2 (P2), you can set the following items:

- Red Detail ON/OFF (RED DTL)
- Clear Digital Noise Reduction Control (CLEAN DNR)
- 2 Dimension Low Pass Filter (2D LPF)
- 6 Chroma Matrix Controls (MATRIX R-G) (MATRIX R-B) (MATRIX G-R) (MATRIX G-B) (MATRIX B-R) (MATRIX B-G)
- Chroma Phase Control (HUE)

### To turn the page

Move the cursor to NEXT and press the PAGE button.

### To return to the SET UP menu

Move the cursor to RET and press the PAGE button.

### 8-1. Gamma Correction (GAMMA)

1. Move the cursor to GAMMA parameter. The "I" cursor starts blinking.
2. While observing the waveform monitor or the color video monitor, adjust the gamma level.  
If the "I" cursor is on the end of the "+" side, the gamma correction is set to OFF.  
If the "I" cursor is on the end of the "-" side, the black stretch (BLACK STRET) is set.

### 8-2. Auto Knee ON/OFF (AUTO KNEE)

1. Move the cursor to the AUTO KNEE parameter.
2. Select ON or OFF for the auto knee mode.

### 8-3. Total Pedestal Level Control (TOTAL-PED)

1. Move the cursor to the TOTAL-PED parameter. The "I" cursor starts blinking.
2. While observing the waveform monitor or the color video monitor, adjust the total pedestal level (black level).  
Move the "I" cursor to the "+" side to obtain the brightness.  
Move the "I" cursor to the "-" side to obtain the darkness.

### 8-4. Chrominance Level Control (CHROMA GAIN)

1. Move the cursor to CHROMA GAIN parameter. The "I" cursor starts blinking.
2. While observing the waveform monitor or the color video monitor, adjust the chroma level.

### 8-5. Detail Band Control (DTL BAND)

1. Move the cursor to the DTL BAND parameter. The "I" cursor starts blinking.
2. While observing the color video monitor, adjust the aperture level.  
Move the "I" cursor to the "+" side to obtain the higher frequency.  
Move the "I" cursor to the "-" side to obtain the lower frequency.

### 8-6. Horizontal Detail Gain Control (HDTL GAIN)

1. Move the cursor to the HDTL GAIN parameter. The "I" cursor starts blinking.
2. While observing the color video monitor, adjust the aperture level.  
Move the "I" cursor to the "+" side to obtain the sharpness.  
Move the "I" cursor to the "-" side to obtain the softness.  
If the "I" cursor is on the end of the "-" side, the horizontal detail level is set to OFF.

### 8-7. Vertical Detail Gain Control (VDTL GAIN)

1. Move the cursor to the VDTL GAIN parameter. The "I" cursor starts blinking.
2. While observing the color video monitor, adjust the aperture level.  
Move the "I" cursor to the "+" side to obtain the sharpness.  
Move the "I" cursor to the "-" side to obtain the softness.  
If the "I" cursor is on the end of the "-" side, the vertical detail level is set to OFF.

### 8-8. Red Detail ON/OFF (RED DTL)

1. Move the cursor to the RED DTL parameter.
2. Select ON or OFF for the RED DTL mode.  
When ON is selected, the red detail is enhanced.

### 8-9. Clear Digital Noise Reduction Control (CLEAN DNR)

1. Move the cursor to the CLEAN DNR parameter.
2. Select OFF, LOW or HI for the CLEAN DNR mode.

### 8-10. 2 Dimension Low Pass Filter (2D LPF)

1. Move the cursor to the 2D LPF parameter.
2. Select ON or OFF for the 2D LPF mode.

### 8-11. 6 Chroma Matrix Controls

(MATRIX R-G)  
(MATRIX R-B)  
(MATRIX G-R)  
(MATRIX G-B)  
(MATRIX B-R)  
(MATRIX B-G)

1. Move the cursor to the desired matrix item. The "I" cursor starts blinking.
2. While observing the vectorscope or the color video monitor, adjust the matrix level.

### 8-12. Chroma Phase Control (HUE)

1. Move the cursor to the HUE parameter. The "I" cursor starts blinking.
2. While observing the vectorscope or the color video monitor, adjust the chroma phase (hue).

### To reset to the factory setting

Any of the above settings except AUTO KNEE, RED DTL, CLEAN DNR and 2D LPF, can be reset to the factory settings.

Move the cursor to the desired item and press ◀ and ▶ simultaneously for a second and more.

# PREVENTION OF BLOOMING AND SMEAR

When the camera is aimed towards spotlights or other bright lights or light reflecting objects, smear or blooming may appear.

Therefore the camera should be operated carefully in the vicinity of extremely bright objects to avoid smear or blooming.

If the camera is aimed at the sun or very bright light, such as laser beam, for a long period of time, the CCD image sensor may be burned in and blemishes (white or black dots) appear on the monitor screen.

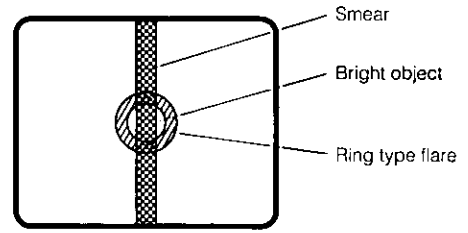

# SPECIFICATIONS

Pick-up System:	Micro prism system
Image Sensor:	Three 1/2" interline transfer (IT) super high sensitivity CCDs (GP-US522) Three 1/3" interline transfer (IT) super high sensitivity CCDs (GP-US532)
Pixels:	768 (Horizontal) x 494 (Vertical)
Scanning Standard:	525 lines, 60 fields, 30 frames
Synchronizing System:	Internal or External (Gen-Lock), automatically switchable Internal: EIA standard External (Gen-Lock) Input: VBS/VS/HD/VD is selectable SC Phase for Gen-Lock (VBS): Free adjustable over 360° H Phase for Gen-Lock (VS): Adjustable
Video Outputs:	Video Output: BNC Connector x 2 1.0V[p-p] NTSC composite/75 Ω Y/C (S-VIDEO) Output: S-VIDEO Connector x 1 0.714V[p-p] Luminance level (Y)/75 Ω (S-VIDEO connector) 0.286V[p-p] Burst Level (C)/75 Ω (S-VIDEO connector) RGB/SYNC Output: D-SUB 9-pin Connector x 1 R/G/B: 0.7V[p-p] each/75 Ω SYNC: 4V[p-p]/75 Ω or 0.3V[p-p]/75 Ω selectable VIDEO: NTSC composite/75 Ω
Required Illumination:	2000 lx at F11.0, 3200 K (GP-US522) 2000 lx at F8.0, 3200 K (GP-US532)
Minimum Illumination:	5 lx (0.5 foot candle) at F2.8 with +18 dB gain, 30 IRE level (GP-US522) 9 lx (0.9 foot candle) at F2.2 with +18 dB gain, 30 IRE level (GP-US532)
Signal-to-Noise Ratio:	62 dB (Typical, Luminance) without aperture and gamma
Horizontal Resolution:	800 lines at center (Y signal) (GP-US522) 750 lines at center (Y signal) (GP-US532)
White Balance:	ATW (Automatic Tracing White Balance Control), AWC (Automatic White Balance Control) and Manual
Black Balance:	ABC (Automatic Black Balance) and Manual
Color Bar:	SMPTE color bar with 7.5% set-up
Electronic Shutter:	AUTO: Adjustable between 1/60 - 1/10 000s STEP: Selectable 1/60(OFF), 1/100, 1/250, 1/500, 1/1 000, 1/2 000, 1/4 000 and 1/10 000s SYNCHRO SCAN: Selectable from 1/525 to 254/525 line
Gain Selection:	AGC and Gain Up (Selectable)
Switches:	Power On/Off (POWER), Camera/Color Bar Selection (CAM/BAR), Gain Up Selection (OFF/LOW/HIGH (0/+9/+18 dB)), White Balance Selection (ATW/AWC/MANU), ELC (Electronic Light Control) On/Off, PAGE, ITEM (AWC), ◀ (ABC) and ▶
Controls:	R Gain, B Gain and ELC LEVEL
Computer Interface:	RS-232C : D-SUB 9-pin Connector x 1
Lens Mount:	Special C Mount (GP-US522) C Mount (GP-US532)
Power Source:	12 V DC
Power Consumption:	8.4 W
Ambient Operating Temperature:	32°F - 113°F (0°C - +45°C)
Ambient Operating Humidity:	30 % - 90 %
Dimensions	
Camera Head:	34 (W) x 44 (H) x 52 (D) mm
(Excluding Mounting Adaptor)	[1-5/16" (W) x 1-11/16" (H) x 2" (D)]
CCU:	(206.5 (W) x 44 (H) x 250 (D) mm)
(Excluding Rubber Foot and Connector)	[8-1/8" (W) x 1-11/16" (H) x 9-1/2" (D)]
Weights	
Camera Head:	110 g (0.24 lbs)
CCU:	1.7 kg (3.74 lbs)

Dimensions and Weights indicated are approximate  
Specifications are subject to change without notice

# OPTIONAL ACCESSORIES

Camera Cable ..... GP-CA522/4  
Character Generators ..... WJ-KB15, WJ-KB50

## **Panasonic**

**Medical & Industrial Video Company**

**A Division of Panasonic Broadcast & Television Systems Company  
A Unit of Matsushita Electric Corporation of America**

**Executive Office:** One Panasonic Way 3E-7, Secaucus, New Jersey 07094

**Regional Offices:**

Northeast: 43 Hartz Way, Secaucus, NJ 07094 (201) 348-7303  
Southeast: 1225 Northbrook Parkway, Suite 1-160, Suwanee, GA 30174 (770) 338-6835  
Midwest: 1707 North Randall Road, Elgin, IL 60123 (847) 468-5200  
Southwest: 8105 Beltline Road, Suite 100, Irving TX 75063 (214) 915-1333  
Western: 6550 Katella Ave., Cypress, CA 90630 (714) 373-7265

**PANASONIC CANADA INC.**

5770 Ambler Drive, Mississauga, Ontario, L4W 2T3 Canada (905)624-5010

**PANASONIC SALES COMPANY**

**DIVISION OF MATSUSHITA ELECTRIC OF PUERTO RICO, INC.**

San Gabriel Industrial Park, 65th Infantry Ave. KM. 9.5 Carolina, P.R. 00630 (809)750-4300



## Free Manuals Download Website

<http://myh66.com>

<http://usermanuals.us>

<http://www.somanuals.com>

<http://www.4manuals.cc>

<http://www.manual-lib.com>

<http://www.404manual.com>

<http://www.luxmanual.com>

<http://aubethermostatmanual.com>

Golf course search by state

<http://golfingnear.com>

Email search by domain

<http://emailbydomain.com>

Auto manuals search

<http://auto.somanuals.com>

TV manuals search

<http://tv.somanuals.com>