



Panasonic

Professional / Industrial Video

Combination VCR Operating Instructions

VHS

Models No. **AG-513E / AG-520E**



- Initial Setup and Connection Procedures are on pages 8 to 13.

**PRO
LINE**



As an **ENERGY STAR**® Partner, Matsushita Electric Corporation of America has determined that this product or product model meets the **ENERGY STAR**® guidelines for energy efficiency.

Please read these instructions carefully before attempting to connect, operate, or adjust this product. Please save this manual.

Download from www.Somanuals.com. All Manuals Search And Download. LSQT0480A

Initial Setup

Basic Operation

TV Operation

Timer Operation

Advanced Operation

For Your Information

Important Safeguards and Precautions

READ AND RETAIN ALL SAFETY AND OPERATING INSTRUCTIONS. HEED ALL WARNINGS IN THE MANUAL AND ON UNIT

INSTALLATION

1 POWER SOURCE CAUTION

Operate only from power source indicated on unit or in this manual. If uncertain, have your Electric Utility Service Company or Video Products Dealer verify your home power source.

2 POWER CORD PLUG

For safety, this unit has a polarized type plug (one wide blade), or a three-wire grounding type plug. Always hold the plug firmly and make sure your hands are dry when plugging in or unplugging the AC power cord. Regularly remove dust, dirt, etc. on the plug.

POLARIZED PLUG CAUTION:

The plug fits into the outlet only one way. If it cannot be fully inserted, try reversing it. If it still will not fit, have an electrician install the proper wall outlet. Do not tamper with the plug.

GROUNDING PLUG CAUTION:

The plug requires a three-hole grounding outlet. If necessary, have an electrician install the proper outlet. Do not tamper with the plug.

3 POWER CORD

- To avoid unit malfunction, and to protect against electrical shock, fire, or personal injury:
- Keep power cord away from heating appliances and walking traffic. Do not rest heavy objects on, or roll such objects over the power cord.
 - Do not tamper with the cord in any way.
 - An extension cord should have the same type plug (polarized or grounding) and must be securely connected.
 - Overloaded wall outlets or extension cords are fire hazards.
 - Frayed cords, damaged plugs, and damaged or cracked wire insulation are hazardous and should be replaced by a qualified electrician.

4 DO NOT BLOCK VENTILATION HOLES

Ventilation openings in the cabinet release heat generated during operation. If blocked, heat build-up may result in a fire hazard or heat damage to cassettes.

For your protection:

- Never cover ventilation slots while unit is ON, or operate unit while placed on a bed, sofa, rug, or other soft surface.
- Avoid built-in installation, such as a book case or rack, unless properly ventilated.

5 AVOID EXTREMELY HOT LOCATIONS OR SUDDEN TEMPERATURE CHANGES

Do not place unit over or near a heater or radiator, in direct sunlight, etc. If unit is suddenly moved from a cold place to a warm place, moisture may condense in unit and on the tape causing damage.

6 TO AVOID PERSONAL INJURY

- Never place unit on support or stand that is not firm, level, and adequately strong. The unit could fall causing serious injury to a child or adult and damage to the unit.
- Move any appliance and cart combination with care. Quick stops, excessive force, and uneven surfaces may cause objects to overturn.
- Carefully follow all operating instructions.



OUTDOOR ANTENNA INSTALLATION

1 SAFE ANTENNA AND CABLE CONNECTION

An outside antenna or cable system must be properly grounded to provide some protection against built up static charges and voltage. Section 810

of the National Electrical Code, ANSI/NFPA 70 (in Canada, part 1 of the Canadian Electrical Code) provides information

regarding proper grounding of the mast and supporting structure, grounding of the lead-in wire to an antenna discharge unit, size of grounding conductors, location of antenna discharge unit, connection to grounding electrodes, and requirements for the grounding electrode.

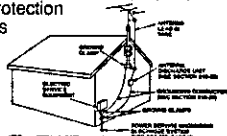

2 KEEP ANTENNA CLEAR OF HIGH VOLTAGE POWER LINES OR CIRCUITS

Locate an outside antenna system well away from power lines and electric light or power circuits so it will never touch these power sources should it ever fall. When installing antenna, absolutely never touch power lines, circuits or other power sources as this could be fatal.

USING THE UNIT

Before unit is brought out of storage or moved to a new location, refer again to the INSTALLATION section of these safeguards.

1 KEEP UNIT WELL AWAY FROM WATER OR MOISTURE, such as vases, sinks, tubs, etc.

2 IF EXPOSED TO RAIN, MOISTURE, OR STRONG IMPACT, unplug unit and have it inspected by a qualified service technician before use.

3 ELECTRICAL STORMS
During a lightning storm, or before leaving unit unused for extended periods of time, disconnect all equipment from the power source as well as the antenna and cable system.

4 WHEN UNIT IS PLUGGED IN

- DO NOT OPERATE IF:
 - liquid has spilled into unit.
 - unit was dropped or otherwise damaged.
 - unit emits smoke, odours, or noises.
- Immediately unplug unit, and have it inspected by a service technician to avoid potential fire and shock hazards.
- Never drop or push any object through openings in unit. Touching internal parts may cause electric shock or fire hazard.
- Keep magnetic objects, such as speakers, away from unit to avoid electrical interference.

5 USING ACCESSORIES

Use only accessories recommended by the manufacturer to avoid risk of fire, shock, or other hazards.

6 CLEANING UNIT

Unplug unit. Use a clean, dry, chemically untreated cloth to gently remove dust or debris. DO NOT USE cleaning fluids, aerosols, or forced air that could over-spray, or seep into unit and cause electrical shock. Any substances, such as wax, adhesive tape, etc. may mar the cabinet surface. Exposure to greasy, humid, or dusty areas may adversely affect internal parts.

SERVICE

1 DO NOT SERVICE PRODUCT YOURSELF

If, after carefully following detailed operating instructions, the unit does not operate properly, do not attempt to open or remove covers, or make any adjustments not described in the manual. Unplug unit and contact a qualified service technician.

2 REPLACEMENT OF PARTS

Make sure the service technician uses only parts specified by the manufacturer, or have equal safety characteristics as original parts. The use of unauthorized substitutes may result in fire, electric shock, or other hazards.

3 SAFETY CHECK AFTER SERVICING

After unit is serviced or repaired, request that a thorough safety check be done as described in the manufacturer's service literature to ensure video unit is in safe operating condition.

Safety Precautions/Mesures de sécurité

Warning : To prevent fire or shock hazard, do not expose this equipment to rain or moisture.

Caution : To prevent electric shock, match wide blade of plug to wide slot and insert fully.

Avertissement : Afin de prévenir tout risque d'incendie ou de chocs électriques, ne pas exposer cet appareil à la pluie ou à une humidité excessive.

Attention : Pour éviter les chocs électriques, introduire la lame la plus large de la fiche dans la borne correspondante de la prise et pousser jusqu'au fond.

This video recorder, equipped with the HQ (High Quality) System, is compatible with existing VHS equipment.

Only use those tapes with the **VHS** mark. It is recommended that only cassette tapes that have been tested and inspected for use in 2, 4, 6, and 8 hour VCR machines be used.

This television receiver provides display of television closed captioning in accordance with §15.119 of the FCC rules.

FCC WARNING : Any unauthorized changes or modifications to this equipment would void the user's authority to operate.

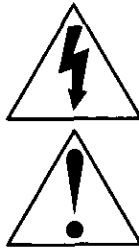
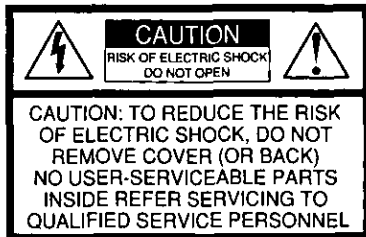

This symbol warns the user that uninsulated voltage within the unit may have sufficient magnitude to cause electric shock.

Therefore, it is dangerous to make any kind of contact with any inside part of this unit.

This symbol alerts the user that important literature concerning the operation and maintenance of this unit has been included. Therefore, it should be read carefully in order to avoid any problems.

Before Using

Congratulations

on your purchase of one of the most sophisticated and reliable products on the market today. Used properly, it will bring you and your family years of enjoyment. Please fill in the information below. The serial number is on the tag located on the back of your unit.

Date of Purchase _____
Dealer Purchased From _____
Dealer Address _____
Dealer Phone No _____
Model No _____
Serial No _____

Accessories

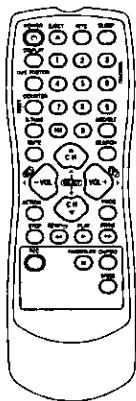

Remote Control
LSSQ0280

Batteries 2 "AA"

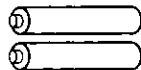

Loading the Batteries

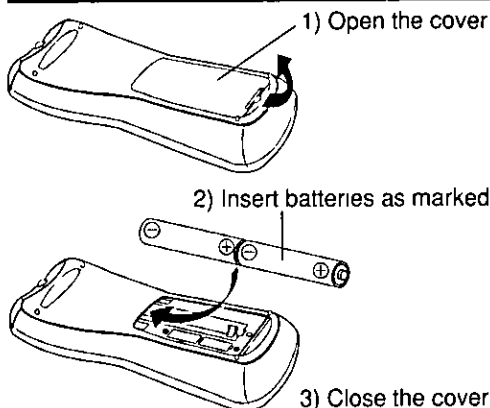

Battery replacement caution

- Do not mix old and new batteries
- Do not mix alkaline with manganese batteries

Head Cleaning

Playing older or damaged tapes may eventually cause video heads to become clogged.

Video Head Clog Sensor

During playback this screen appears if clogging is detected. To remove screen, press PLAY on the remote or unit.

VIDEO HEADS MAY
NEED CLEANING
PLEASE INSERT HEAD
CLEANING CASSETTE
OR REFER TO MANUAL

END PLAY

- Use "dry" type head cleaning cassette only (Part No. NV-TCL30PT is recommended.)
- Follow cleaning tape directions carefully. Excessive use of head cleaning tape can shorten the video head life.
- If head clog symptoms persist, contact your nearest Factory Service Center.

Prevent Accidental Tape Erasure

Break off the tab to protect

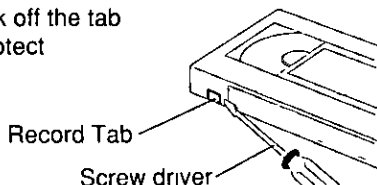

To record again

Cover the hole with cellophane tape

Record/Playback Time

Only use tapes with the **VHS** mark in this unit.

Tape Speed Setting	Type of Video Cassette		
	T60	T120	T160
SP (Standard Play)	1 Hour	2 Hours	2 Hours 40 Minutes
LP (Long Play)	2 Hours	4 Hours	5 Hours 20 Minutes
SLP (Super Long Play)	3 Hours	6 Hours	8 Hours

Table of Contents

Important Safeguards and Precautions / Safety Precautions	2, 3
Before Using	4
Table of Contents	5
Location of Controls	6, 7
Connections	8
Initial Setup	9 - 11
<hr/>	
Reset Language, Channels, Clock, Time Zone Adjust	12, 13
Playback a Tape	14
Record On a Tape	14
Copy Your Tapes (Dubbing)	15
<hr/>	
TV Operation	16
Picture Adjustment	17
TV Timer Features	18, 19
Closed Caption System	20, 21
<hr/>	
Timer Recording	22, 23
<hr/>	
Tape Operation	24 - 27
Special VCR Features	28 - 31
V-Chip Control Feature	32 - 35
<hr/>	
On-Screen Displays (OSD)	36
Unit Information	37
Before Requesting Service	38
Index	39

Initial Setup

Basic Operation

TV Operation

Timer Operation

Advanced Operation

For Your Information

Location of Controls

Remote Control Buttons

EJECT button:

When EJECT is pressed, the tape is ejected from Cassette Compartment.
If EJECT is pressed during recording, the unit will not respond to the command.

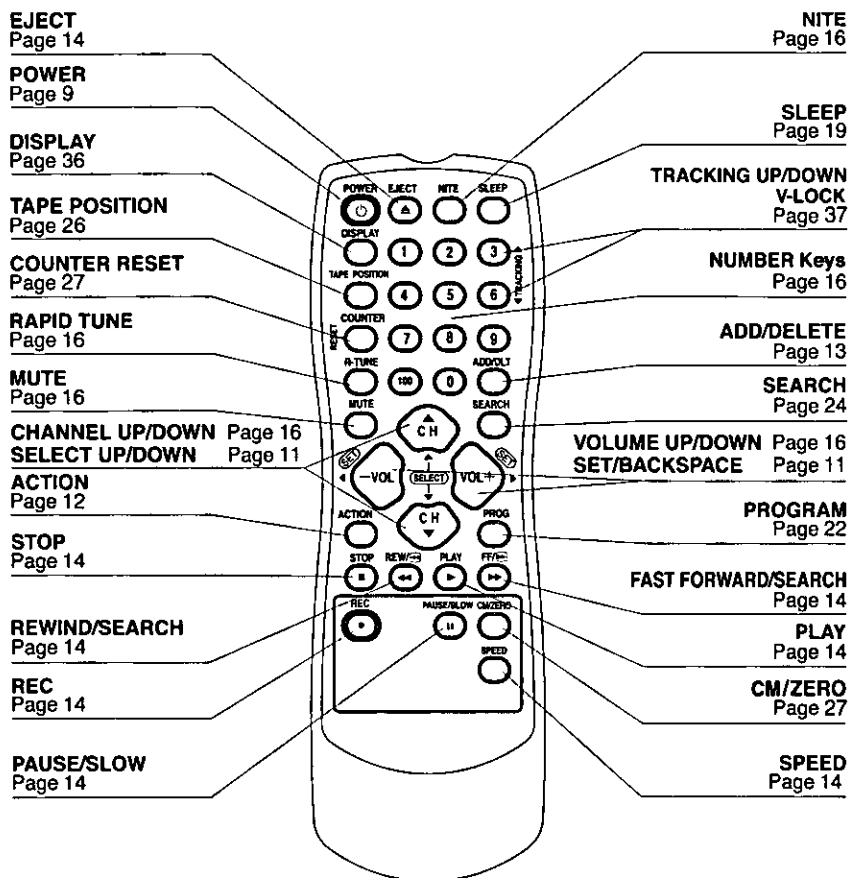

Front View of the unit and Indicators on the Front Panel

<Model AG-520E unit shown>

REWIND/SEARCH ACTION Page 14
Page 12

STOP/EJECT ACTION Page 14
Page 11

CHANNEL UP/DOWN Page 16
TRACKING UP/DOWN Page 37
SELECT UP/DOWN Page 11

VOLUME UP/DOWN Page 16
SET/BACK SPACE Page 11

POWER Page 9

Audio/Video In Jack Page 15

Cassette Compartment Page 14

PLAY/REPEAT Page 14

FAST FORWARD/SEARCH Page 14

REC Page 14

INPUT Page 15

Built-In Speaker

Phones Jack Page 16

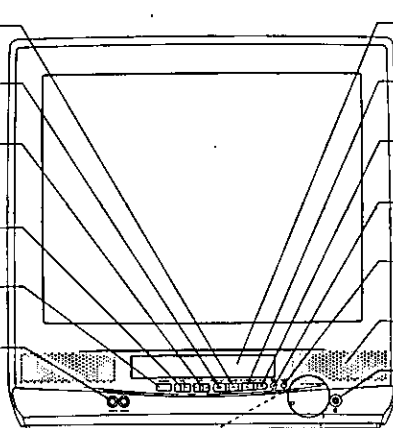

REC Indicator

Lights up during recording.
In Rec Pause or OTR Pause mode,
the indicator flashes.
Page 14

Remote Sensor

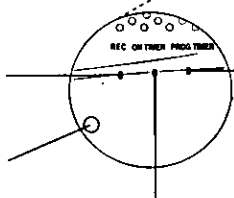

PROG TIMER Indicator

Lights up when the unit is set for
Timer Recording. It flashes when a
Timer Recording has been set with
no tape inserted, the clock is not set,
or the tape is in motion.
Page 22

ON TIMER Indicator

Lights up when the On Timer is set.
Page 18

Rear View of the unit

<Model AG-513E unit shown>

Easy-Grip-Handle

<Model AG-513E only>
Use when transporting
the unit.

AC Power Plug

When plugged into
an AC outlet, the unit
consumes 4.0 W of
electric power in OFF
mode.

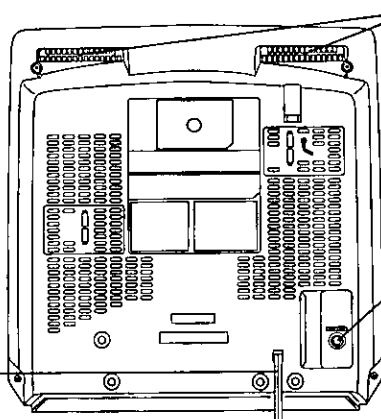

VHF/UHF Antenna Input Terminal

In from your
Antenna or Cable.
Pages 8, 10.

Connections

Outdoor Antenna Connections

Unhook the antenna from your previous TV or VCR and connect it to the back of the unit as shown in the diagram. If your antenna system has separate UHF and VHF lead-ins, you need a UHF/VHF Band Mixer (not supplied).

WARNING

When using "Nut type" RF coaxial cables, tighten with fingers only. Overtightening may damage terminals.

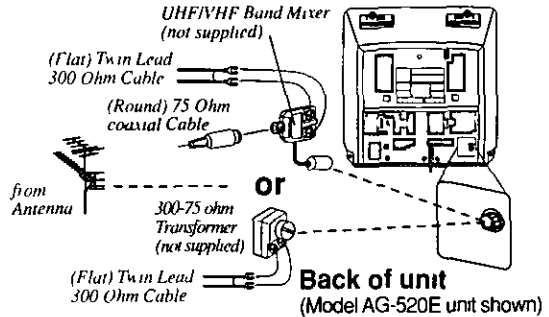

DSS/Cable Box Connections

Without a Cable Box

- You can,
- record or view unscrambled channels
- You cannot,
- record or view scrambled channels
 - view a channel other than the one selected for any type of recording

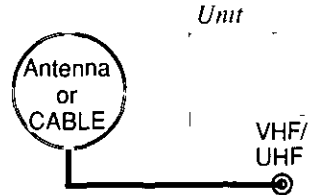

With a Cable Box

- You can,
- record or view any channel including scrambled channels
- NOTE Channel selection must be made at the cable box
- You cannot,
- view a channel other than the one selected for any type of recording
 - do a Timer recording of a channel unless you select it at the cable box

Note to CABLE System Installer

This reminder is provided to call the CABLE (Cable TV) System Installers attention to Article 820-40 of the NEC that provides guidelines for proper grounding and, in particular, specifies that the cable ground shall be connected to the grounding system of the building, as close to the point of cable entry as practical.

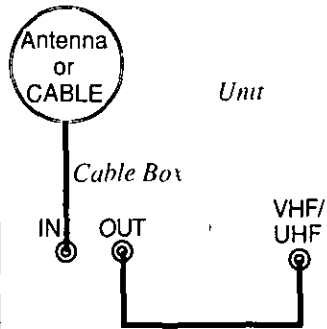

With a DSS Receiver

- You can,
- record or view any channel including scrambled channels
- NOTE Channel selection must be made at the DSS Receiver
- You cannot,
- view a channel other than the one selected for any type of recording
 - do a Timer recording of a channel unless you select it at the DSS box
- NOTE The DSS receiver must be turned off to view programs from a cable box or antenna. See the DSS manual for details.

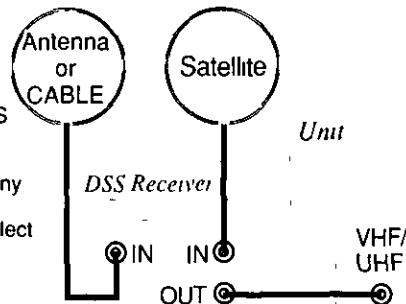

Initial Setup

Set the Clock (Initial Power On)

1 Press **POWER** on the remote or unit.

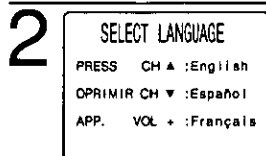

Press **CH ▲** to select English.

OR

Press **CH ▼** to select Spanish (Español).

OR

Press **VOL+** to select French (Français).

• If wrong language is set, complete "Reset all unit Memory Functions" steps on page 37.

• If you use a cable box, it must be left on.

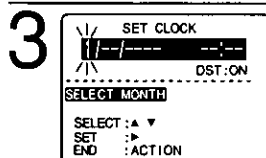

1) Press **▲▼** to select the month.

2) Press **▶** to set.

• Likewise, set date, year, time, and DST (Daylight Saving Time).

To Make Corrections, repeatedly press **◀▶** to move to error, then correct.

4 Press **ACTION** to end setup. (Clock starts.)

Your unit can be set to Tuner ON or Tuner OFF. When the unit is first turned on, the tuner is set to off and a prompt to set the clock is displayed.

By selecting "TUNER:ON" (see below left), you can place channels in memory and use the Auto Clock Set feature (see pages 10 and 11).

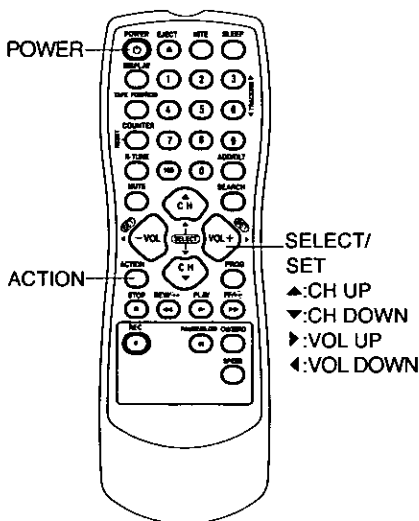

Tuner ON/OFF

When Tuner OFF is selected, your unit is automatically in LINE mode. When Tuner ON is selected, Channel selection, Input selection, Channel Add/Delete, etc. is available.

1 Press **ACTION** to display MAIN MENU.

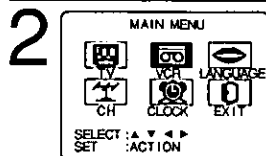

1) Press **▲▼◀▶** to select "VCR."

2) Press **ACTION** to display SET UP VCR screen.

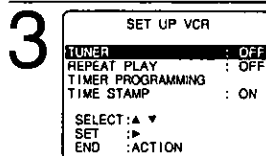

1) Press **▲▼** to select TUNER.

2) Press **▶** to set "ON" or "OFF."

• If you selected ON, go to "Setup Channel and Auto Clock Set" selection on pages 10 and 11.

4 Press **ACTION** twice to return to the normal screen.

Initial Setup (continued)

Setup Channel and Auto Clock Set (TUNER:ON only)

- 1 Press **CH ▲** or **CH ▼** to display CHANNEL/CLOCK AUTO SET screen.
 - If you use a cable box, turn it on and select PBS channel in your time zone.

2

CHANNEL/CLOCK AUTO SET

CONNECT ANTENNA CABLE
AND IF YOU USE A CABLE
BOX, TUNE IT TO YOUR
LOCAL PBS CH THEN...

PLEASE PRESS CH UP KEY

Press **CH ▲** to start Channel Auto Set.

These on-screen displays will appear in sequence.

- CH AUTO SET PROCEEDING
- CH AUTO SET COMPLETED

Auto Clock Set

Auto Clock Set is performed only when Channel Auto Set is completed in above steps.

1

Press **ACTION** to display MAIN MENU.

2

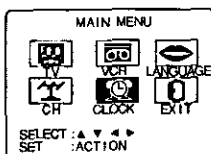

1) Press **▲▼◀▶** to select "CLOCK."

2) Press **ACTION** to display SET CLOCK screen.

3

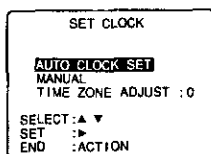

1) Press **▲▼** to select "AUTO CLOCK SET," then press **▶**.

2) Press **CH▲** to start.

- If Channel Auto Set is not performed, "CH AUTO SET PROCEEDING" appears.

- "AUTO CLOCK SET PROCEEDING" appears.

Setup completed

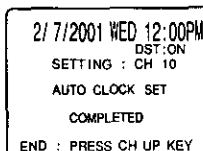

Press **CH ▲** to exit.

- If your area observes daylight saving time, but you would like to turn the DST feature off, set DST : OFF (see "Clock" on pages 12 and 13).

- If time is not correct... even though your area observes daylight saving time and DST is set to ON, do "Time Zone Adjust" steps on page 13.

Setup incomplete



See next page.

IMPORTANT NOTE FOR AUTO CLOCK SET

- Auto clock set is performed the first time the unit is turned off each day. If used, a cable box must be left on and tuned to the PBS channel at the time the unit power is turned off if you want auto clock set to be done.
- If using a DSS receiver, it must be turned off for auto clock set.
- If a Cable Box or DSS receiver is connected to the unit via Audio/Video Jacks, an RF coaxial cable must also be connected for auto clock set and channel auto set features.
- If for any reason the time is changed manually, automatic time correction will not occur.

Setup Incomplete

Set the clock manually.

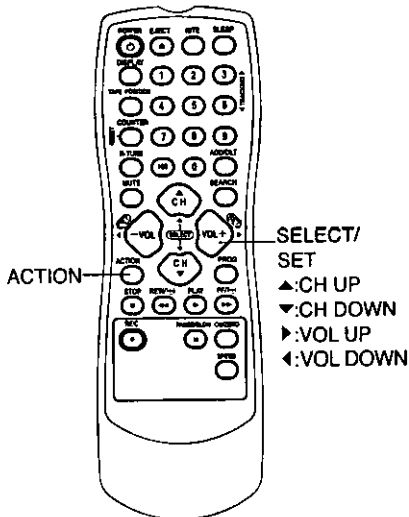

a

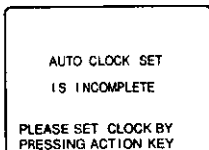

Press **ACTION**
to display **SET
CLOCK** screen.

b

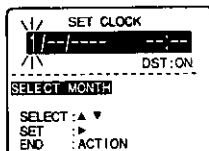

- 1) Press **▲▼** to select the month.
- 2) Press **▶** to set.
 - Likewise, set date, year, time, and DST (Daylight Saving Time).

To Make Corrections,
repeatedly press **◀▶** to move to error, then correct.

c

Press **ACTION** twice to end setup.
(Clock starts.)

Notes

- Channel auto set selects normal TV or Cable channels depending on your unit hookup.
- The Language, Channel, and Clock settings can be changed at a later time (see pages 12 and 13). To reset all of these settings, do the "Reset all unit Memory Functions" steps on page 37.
- This unit's calendar is accurately maintained up to Dec. 31, 2089, 11:59 PM.

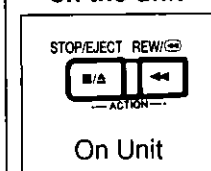
ACTION key on the unit

You can operate the menu screen using unit buttons.
To display the menu, press **STOP/EJECT** and **REW** together with no tape inserted. To exit the menu, repeat above with or without tape inserted until normal screen appears.

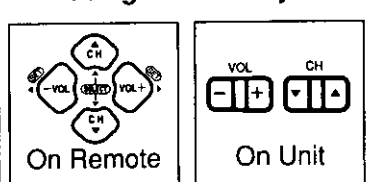
Using ▲▼◀▶ keys

- ▲ : CH UP
- ▼ : CH DOWN
- ▶ : VOLUME UP
- ◀ : VOLUME DOWN

Whenever the menu or program screen is displayed, CHANNEL UP/DOWN function as **▲▼** and VOLUME UP/DOWN function as **◀▶** only.

Reset Language, Channels, Clock,

- 1 Press **ACTION** to display MAIN MENU.

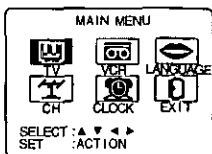

<TUNER:ON MAIN MENU is shown>

2 Language

- 1) Press **▲▼◀▶** to select language icon.

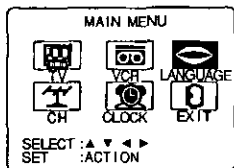

- 2) Press **ACTION** repeatedly.

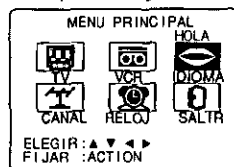

For Spanish

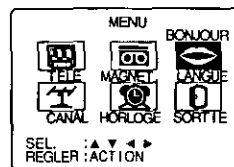

For French

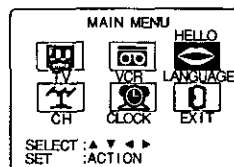

For English

- 3) Press **▲▼◀▶** to select "EXIT," then press **ACTION** to exit.

Channels (TUNER:ON only)

- 1) Press **▲▼◀▶** to select "CH."

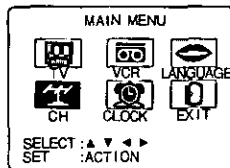

- 2) Press **ACTION**.

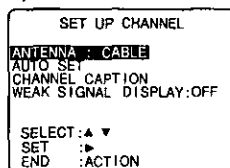

- 3) Press **▲▼** to select "ANTENNA," then press **▶** to set your antenna system ("TV" or "CABLE").

- 4) Press **▲▼** to select "AUTO SET," then press **▶**.

Clock

- 1) Press **▲▼◀▶** to select "CLOCK."

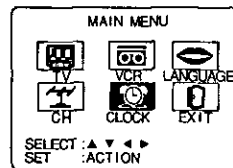

- 2) Press **ACTION**.
If TUNER:OFF, go to step 4).

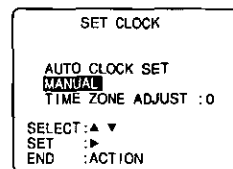

("TIME ZONE ADJUST" appears only when auto clock is set.)

- 3) Press **▲▼** to select "MANUAL," then press **▶**.

(For Auto Clock Set, select "AUTO CLOCK SET," and press **▶**. Then, press **CH ▲**.)

Continued on the next page.

Time Zone Adjust

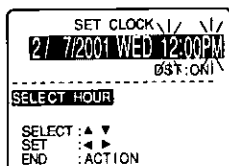

<Example MANUAL CLOCK SET screen>

- 4) Press ▲▼ and press ▶ to select and set the month, date, year, time, and DST (Daylight Saving Time).

To Make Corrections, repeatedly press ◀▶ to move to error, then correct.

- 5) Press ACTION twice to start the clock and exit this mode.

Time Zone Adjust (TUNER:ON only)

(Only when Auto Clock is set.)

- 1) Press ▲▼◀▶ to select "CLOCK."

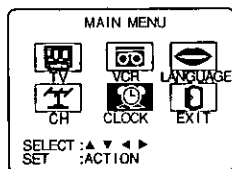

- 2) Press ACTION.

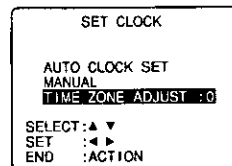

- 3) Press ▲▼ to select "TIME_ZONE_ADJUST" and press ◀ or ▶ to subtract or add hour(s) as necessary.

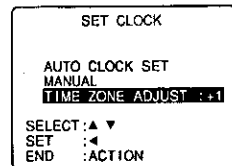

- 4) Press ACTION twice to exit.

- TIME_ZONE_ADJUST returns to "0" if clock is set manually.

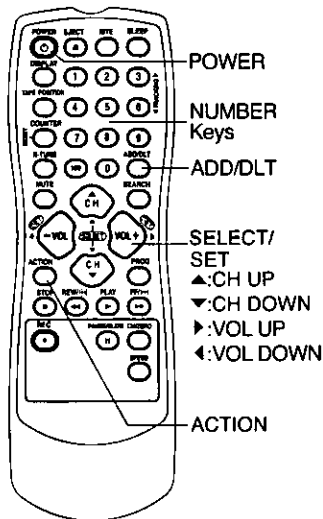

Basic Operation

Add or Delete a Channel (TUNER:ON only)

To add channel:
Select channel with **number keys** and press **ADD/DLT**.



To delete channel:
Select channel with **CH▲▼** or **number keys** and press **ADD/DLT**.

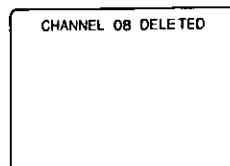

Playback a Tape

✓ Ready Checklist

- All connections are made.
- Your unit is plugged in.



1 Insert a tape.

- The unit power comes on automatically.

To prevent tape jam, remove loose or peeling labels from tapes.

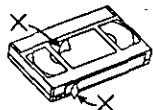

2 Press PLAY to play a tape.

- If tape has no record tab (see page 4), auto play begins.
- **Forward/Reverse scene search**
→ Press FF or REW.
→ Press again or PLAY to release.
- **Still (Freeze) picture**
→ Press PAUSE/SLOW.
→ Press PLAY to release.
- **Slow Motion picture**
→ Hold down PAUSE/SLOW in Still mode.
→ Press PLAY to release.
- **Frame by Frame picture**
→ Press PAUSE/SLOW in Still mode.
→ Press PLAY to release.

Notes

- These features work best in SP or SLP mode.
- After the unit is in Still or Slow mode for 3 minutes, it will switch to Stop mode automatically to protect the tape and the video head.

■ Stop → Press STOP.

■ Rewind tape → Press REW in Stop mode.

■ Fast forward tape → Press FF in Stop mode.

■ Eject tape → Press EJECT on the remote or STOP/EJECT on the unit.

Operation using unit button

<Model AG-520E unit shown>

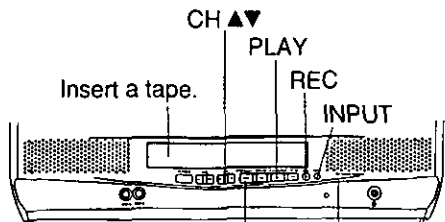

- Press to stop and/or eject tape. REC Indicator

Record On a Tape

1 Insert a tape with record tab.

- The unit power comes on automatically.

2 Press CH ▲▼ or number keys to select Channel.

- For "LINE" input, see bottom of next page.

3 Press SPEED to select recording speed (see page 4).

- SP = Standard Play
- LP = Long Play
- SLP = Super Long Play

- Selected speed is displayed.

4 Press REC to start recording.

- To edit out unwanted portions, press PAUSE/SLOW to pause and resume recording.
- You cannot view another channel during recording.

■ Stop → Press STOP.

■ One Touch Recording (OTR)

Press REC repeatedly to set the recording length (30 min - 4 hours.)

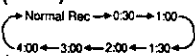

- The unit stops recording at a preset time.
- PROG TIMER Indicator lights up on the unit.

Notes

- After the unit has been in Rec Pause mode for 5 minutes, it will stop automatically to protect the tape and the video head.
- The remaining recording time of an OTR can be displayed by pressing DISPLAY.

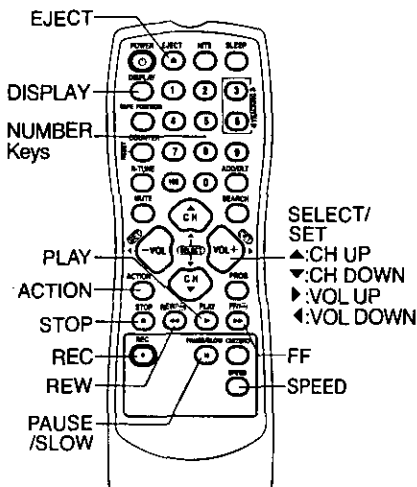

Copy Your Tapes (Dubbing)

Connections you'll need to make.

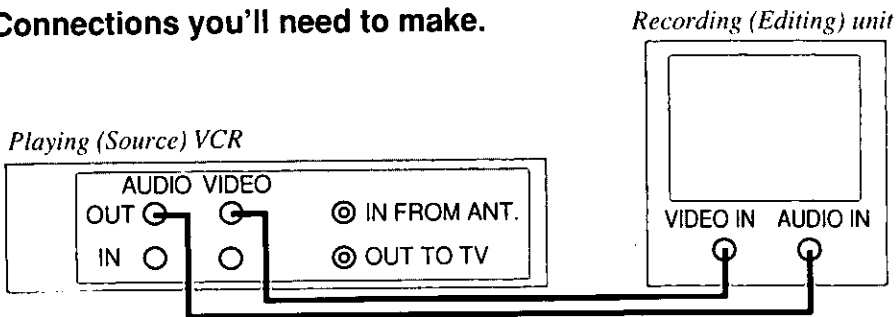

Playback (Source)

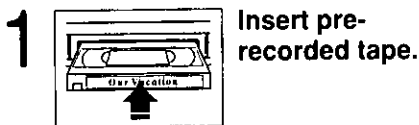

2 _____

3 Press **PLAY** then **PAUSE** at starting point to put in Standby mode.

_____ (Perform operation of steps 4 and 5 on both units simultaneously.) _____

4 Press **PLAY** to start dubbing.

5 Press **STOP** to stop dubbing.

Recording (Editing) unit

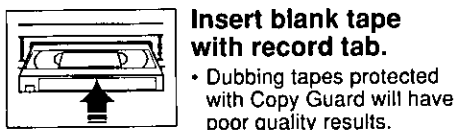

Select "**LINE**" mode.
See "Selecting Input Mode" below.

Press **REC**, then **PAUSE/SLOW** immediately to put in Standby mode.

Press **PAUSE/SLOW** to start dubbing.

Press **STOP** to stop dubbing.

Selecting Input Mode (TUNER:ON only)

Method 1:

Press **INPUT** on the unit.
Channel Number ←→ **LINE**

Method 2:

Press **CH ▲▼**.
The display will change as follows.

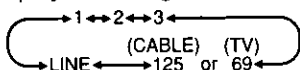

Method 3:

- Press **ACTION** for MAIN MENU.
- Press **▲▼◀▶** to select "TV," then press **ACTION** for SET UP TV screen.
- Press **▲▼** to select "INPUT SELECT," and then press **▶** to select "TUNER" or "LINE."
- Press **ACTION** twice to exit this mode.

Caution

- Unauthorized exchanging and/or copying of copyrighted recordings may be copyright infringement.

TV Operation

✓ Ready Checklist

- All connections are made.
- Your unit is plugged in.

<Model AG-520E unit shown>

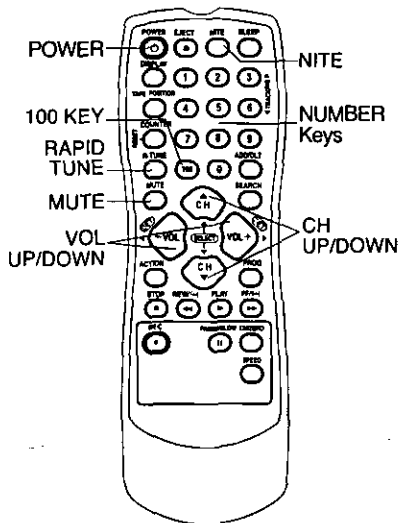
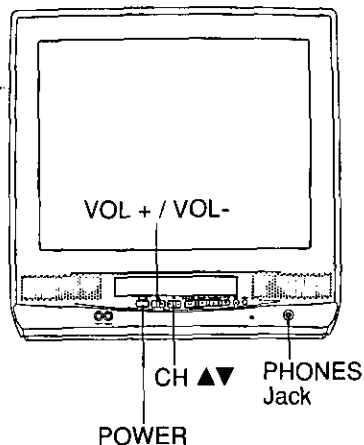

1 Press **POWER** on the remote or unit.

2  Use **CH ▲▼** or **number keys** to select a channel.

3  Press **VOL +** or **VOL -** to adjust volume.

NIGHT (NITE) Mode

Color and picture intensity levels are adjusted so the screen is easier on your eyes during night time use.

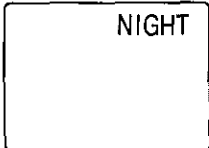
 Press **NITE** to set **NIGHT mode**.

- NIGHT mode may be selected when watching TV or playing a tape.

Press **NITE** to cancel.

- Previous settings are restored.
- NIGHT mode is canceled when power is turned off or power failure occurs.

■ Using the 100 key

When selecting **CABLE** channels 100 to 125 with the number keys, first press the **100** key, and then enter the remaining two digits.

■ Rapid Tune

Press **R-TUNE** to display the last channel you were watching.

■ Audio Mute

Press **MUTE** to instantly mute the sound. Press again to restore the previous sound level.

■ Phones

Connect an earphone (not supplied) or headphones (not supplied) to the Phones Jack.

Picture Adjustment

- 1 Press **ACTION** to display MAIN MENU.

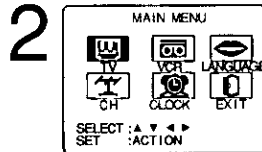
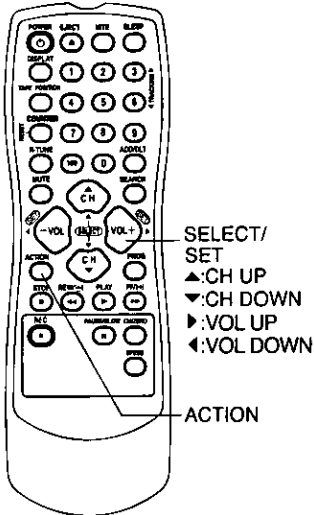

<TUNER:ON MAIN MENU is shown>

- 1) Press **▲▼◀▶** to select "TV."
- 2) Press **ACTION** to display SET UP TV screen.

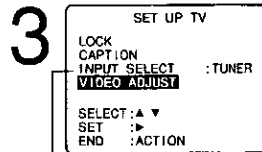

<Only when TUNER:ON>

- 1) Press **▲▼** to select VIDEO ADJUST.
- 2) Press **▶** to display screen.



- 1) Press **▲▼** to select an adjustment item. (See below left.)
- 2) Press **◀▶** to adjust.

Picture Adjustment

- **COLOR Control**
Adjust color intensity.
- **TINT Control**
Adjust for natural flesh tones.
- **BRIGHTNESS Control**
Adjust picture brightness.
- **PICTURE Control**
Adjust picture intensity by adjusting both contrast and color level in the proper balance.
- **SHARPNESS Control**
Adjust picture sharpness.



To Reset Picture Controls.
Press **▲▼** and **▶** to select and set "NORMAL."
All controls return to their factory settings.

- 5 Press **ACTION** three times to exit.

TV Operation

TV Timer Features

ON-TIMER with Alarm

This unit can be set to automatically power on in one of 2 modes (TV or Playback). Even if you set the On Timer, it will not be performed during Play Lock mode. You can also combine the On-Timer with a one minute alarm that gradually increases in volume.

✓ Ready Checklist

- The clock is set to correct time.

1 Press **PROG** to display SET PROGRAM screen.

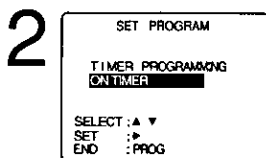

- 1) Press **▲▼** to select "ON TIMER."
- 2) Press **▶** to display ON TIMER screen.

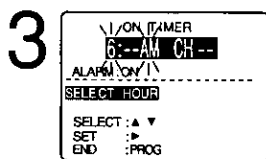

- 1) Press **▲▼** to select desired settings.
- 2) Press **▶** to set the ON-TIMER TIME or ON-TIMER mode.

- You can choose TV or PLAY for the On Timer mode. (If TUNER:OFF, you can only select PLAY.)
- Make sure a tape is inserted if Playback mode is selected.



- Press **▲▼** to select ALARM "ON" or "OFF."

When "ON" is selected, an alarm will gradually increase in volume for one minute or until canceled by **pressing any button** (including VOL + -).

To Make Corrections, use **▲▼** and **◀▶** to move back and correct.

5 Press **PROG** to set ON TIMER.

- "ON TIMER SET" is displayed.
- ON TIMER Indicator lights up on the unit.

To Cancel ON-TIMER set, repeat steps 1 and 2. Then, **press ADD/ DLT** to clear the time in step 3. Now, **press PROG** to end. "ON TIMER END" briefly appears on-screen.

<Model AG-520E unit shown>

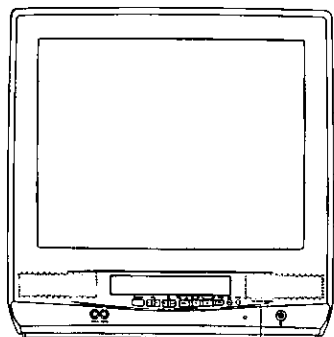

ON TIMER Indicator

Note

- If no button on the remote or unit (including a button used to turn off the alarm) is pressed within 60 minutes after unit turns itself on, it will turn itself back off.

Closed Caption System

Closed Caption is ...

This multi-use system not only allows the hearing impaired to enjoy selected programs, but also makes useful information from TV stations available to everyone

Closed Caption Mode Feature

- 1** Press **ACTION** to display **MAIN MENU**

2

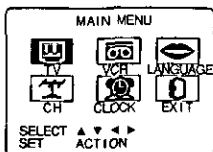

<TUNER ON MAIN MENU is shown>

- 1) Press **▲▼◀▶** to select "TV"
2) Press **ACTION** to display SET UP TV screen

3

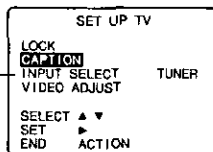

>Only when TUNER ON<

- 1) Press **▲▼** to select "CAPTION"
2) Press **▶** to display CAPTION screen

4

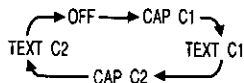
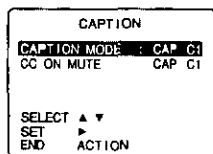

- 1) Press **▲▼** to select CAPTION MODE
2) Press **▶** repeatedly to select mode (See left)

- 5** Press **ACTION** three times to return to the normal screen

Closed Caption Mode Selections

Caption Mode CAP C1 or C2
A narration of selected TV programs is displayed
Check TV program listings for CC (Closed Caption) broadcasts

Caption Mode TEXT C1 or C2
The all of the screen will be blocked out
When the TV station broadcasts information, such as program listings, it will appear in this space

Caption Mode OFF
Closed Caption/Text narration will not be displayed

NOTE

The closed caption or text signal may be broadcast over C1, C2, or both. Also, text contents can vary so you may wish to try different settings

Recording and Playing Back a Closed Caption/Text Program

- Record** Record normally
Closed Caption/Text signal, if present, is recorded automatically
- Playback** . Start playback Do above steps to select desired caption mode

Caption On Mute Feature

Closed Caption narration, if available, is displayed when MUTE button is pressed for silence.

1 Press ACTION
to display MAIN MENU.

2

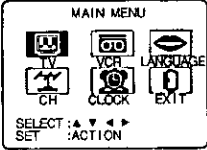

1) Press **▲▼◀▶** to select "TV."
2) Press **ACTION** to display SET UP TV screen.

<TUNER:ON MAIN MENU is shown>

3

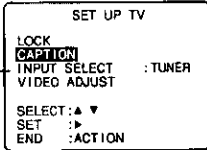

1) Press **▲▼** to select "CAPTION."
2) Press **▶** to display CAPTION screen.

↳ Only when TUNER:ON

4

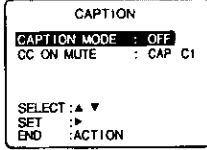

1) Press **▲▼** to select CAPTION MODE.
2) Press **▶** repeatedly to select "OFF."

5

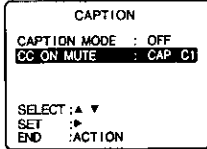

1) Press **▲▼** to select CC ON MUTE.
2) Press **▶** repeatedly to select desired mode.

• Each press of **▶** will change the display as shown left.
• The caption may be broadcast over CAP C1 or C2.

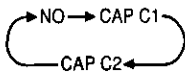

6 Press ACTION three times
to return to the normal screen.

7 Press MUTE to mute the sound and display closed captioning.
• To cancel, press **MUTE** again.

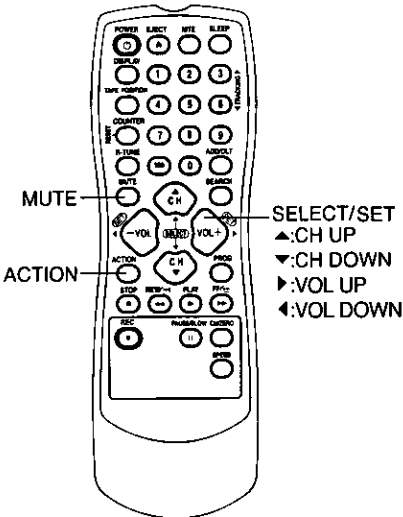

Timer Recording

You can set up to 8 programs to be recorded while you are away.

1 Press PROG to display SET PROGRAM screen.

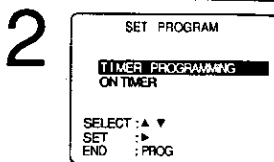

1) Press ▲▼ to select TIMER PROGRAMMING.
2) Press ► to display screen.

• If a program is already in memory, press ▲▼, and ► to select an unused program number.

3 Press ▲▼ to select and ► or ◀ to set the recording DATE.

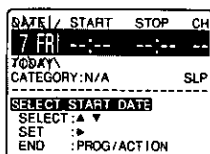

• 1~31 = One time
• DAILY = MON~FRI
• WEEKLY SUN~SAT = Same time once a week

Example

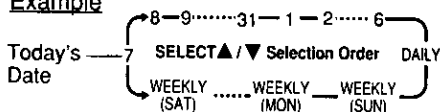

Repeat step 3 to set:

- start time, stop time
- Channel (or LINE for outside source)
- Category [N/A (not applicable), SPORTS, MOVIE, COMEDY, MUSIC, DRAMA]
- Speed (SP, LP, SLP)

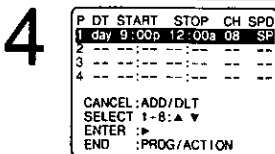

Press PROG (or ACTION) to end the program.

To Enter More Programs, press ▲▼ to select and ► to set a blank program number, and then repeat step 3.

5 Press PROG twice (or ACTION) to exit this mode.

- If you're using a cable box, make sure that it is tuned to the desired channel and the power is left on for timer recording.
- Make sure TUNER:ON is selected for Channel Timer Recording.
- PROG TIMER Indicator lights up on the unit.

✓ Ready Checklist

- All connections are made.
- Your unit is plugged in.
- The clock is set to the correct time.
- The tape is long enough.
- The record tab is in place.

<Model AG-520E unit shown>

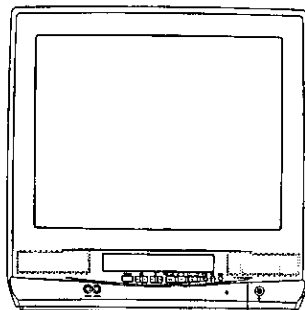

PROG TIMER Indicator

Timer Recording Using unit Buttons

You can set a Timer Recording using ACTION key on the unit. (See page 11.)

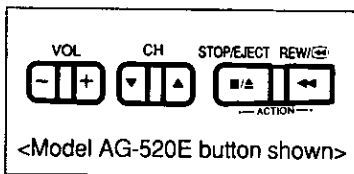

- 1 Press STOP/EJECT and REW together without a tape inserted to display MAIN MENU.
- 2 Press ▲▼ + - to select "VCR," and then STOP/EJECT and REW together to display SET UP VCR screen.
- 3 Press ▲▼ to select "TIMER PROGRAMMING" and + to display the TIMER PROGRAM screen.
- 4 Repeat main steps 3 ~ 5.

Cancel a Timer Recording: (Recording is in progress)

Hold down STOP for a few seconds to cancel the Timer Recording.

- Any future daily or weekly recordings will be performed as programmed.

Review, Replace or Clear Program Contents : (Recording is not in progress)

1 Repeat steps 1 and 2 on page 22.

2

P	DT	START	STOP	CH	SPD
1	day	9:00p	12:00a	08	SP
2	B	10:00p	12:00a	125	SP
3	10	8:00p	9:00p	10	SP
4	SU	9:00p	10:00p	L	LP

CANCEL: ADD/HLT
SELECT 1-8: ▲ ▼
ENTER : ▶
END : PROG/ACTION

Press ▲▼ to select the desired program.

3

To Replace program...

DATE	START	STOP	CH
8 SAT	9:00P	12:00A	08
70DAY			ABC
CATEGORY: MOVIE			SF

SELECT START DATE
SELECT: ▲ ▼
SET : ◀ ▶
END : PROG/ACTION

- Press ▶ to display.
- Press ▲▼ to select and press ◀ or ▶ to set new program contents.
- Press PROG (or ACTION).

To Clear program...

P	DT	START	STOP	CH	SPD
2	B	10:00p	12:00a	125	SP
3	10	8:00p	9:00p	10	SP
4	SU	9:00p	10:00p	L	LP

SELECT 1-8: ▲ ▼
ENTER : ▶
END : PROG/ACTION

Press ADD/HLT.

4 Press PROG twice (or ACTION) to exit this mode.

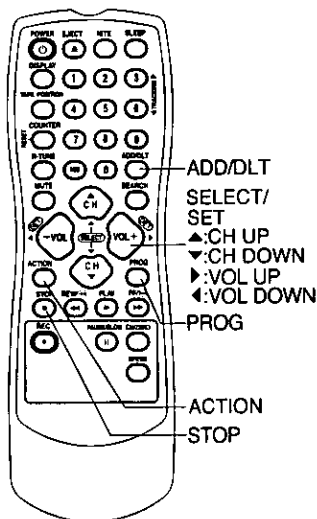

Notes

- 2 minutes before Timer recording is performed, "PLEASE PREPARE FOR TIMER REC" appears and/or the PROG TIMER Indicator flashes. Be sure a cassette with record tab is loaded and the unit is in Stop mode.
- If the start times of two programs overlap, the lower numbered program will have priority.
- If the start time for a Timer Recording comes up during a normal recording or One Touch Recording (page 14), the Timer Recording will not be performed.
- If there is a power interruption of more than one minute, the recording may not be performed or continued.
- If "INCOMPLETE" appears after all items have been set, check all entries and make necessary corrections.

Tape Operation

Search System is ...

Each time a recording is made, an invisible index mark is placed on the tape. When timer recordings are made, program index and information is also included. These index marks can be used to access or scan recordings.

Index Search

Go directly to the desired recording.

1 Press SEARCH in Playback or Stop mode to display INDEX SEARCH screen.

2

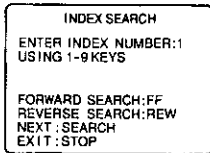

- 1) Press number keys** to select the recording number.
 - To calculate number, see below.
- 2) Press FF or REW** to start search.

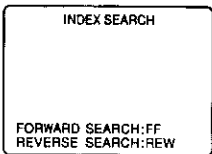
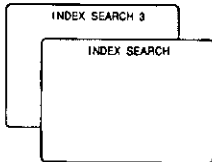

- Play begins at search end. To search forward or back 1 index, **press FF or REW** while screen left is displayed (10 seconds).

To cancel, press **PLAY** or **STOP**.

To calculate the Index Number

Example 1:

To go to rec. 2 from rec. 4, enter 3 and press REW.

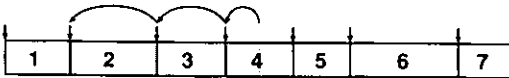

Example 2:

To go to rec. 6 from rec. 2, enter 4 and press FF.

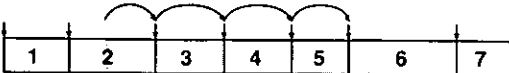

NOTE: † indicates start points of each recording.

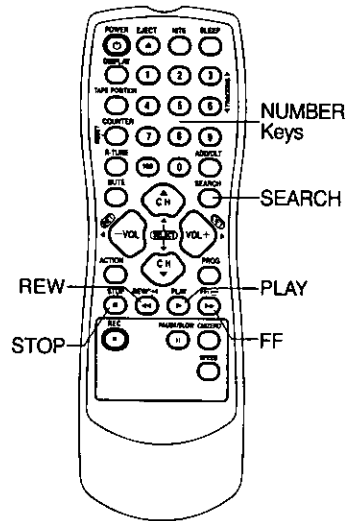

Notes

- Make each entry within 5 minutes, or the Index Search mode will be canceled.
- If Index Search is started very close to an index mark, that index mark may not be counted in the search.

Program End Search

Locates end point of recording for continuity.

1 Press **SEARCH** twice in Playback or Stop mode to display PROGRAM END SEARCH screen .

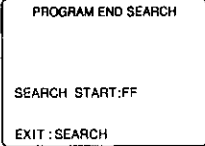
2  Press **FF** to start search.
To cancel, press **PLAY** or **STOP**.

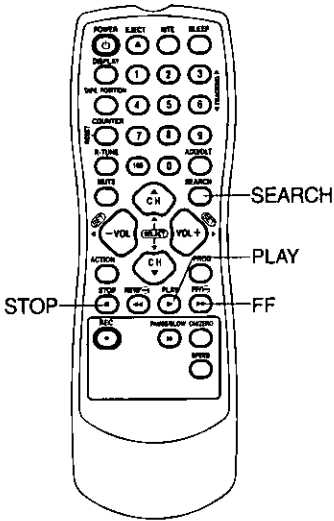

Example of Program End Search operation.

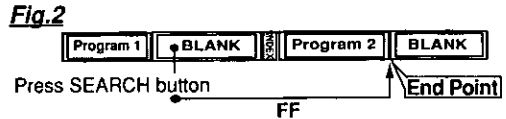
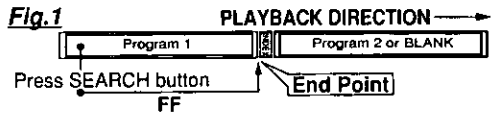
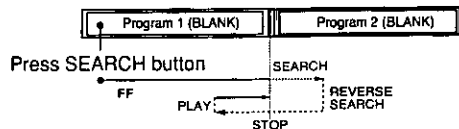

Fig.3 If search exceeds a few seconds in BLANK area. Press **SEARCH** button



Upon locating end point...

The unit searches slightly past end point, reverse searches, and plays the last few seconds of the program, then stops.



Note

- If Program End Search is started very close to an index mark, that mark may be skipped over.

Tape Operation (continued)

Auto Operation Functions

- **Auto Shut Off**
No broadcast signal in TV mode, blank tape is played for 5 minutes
→ Power turns off
• This feature is canceled if any button is pressed during above conditions.
- **Auto Playback**
Insert a tape in Power off mode
→ Power turns on
• Playback begins if tape has no record tab.
- **Auto Rewind**
Tape reaches its end
→ Rewind, → Stop
- **Playback Auto Eject (Repeat Play is "OFF")**
Tape with no record tab reaches its end
→ Rewind, → Stop, → Eject

Tape Position Display

To find out present tape position and amount of tape remaining.

Tape position cannot be detected for C-Cassettes, tapes under 30 minutes, and some other tapes.

- 1 Press **TAPE POSITION** to detect current tape position.

DETECTING TAPE POSITION

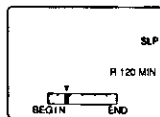
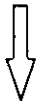

• "DETECTING TAPE POSITION" is displayed only when a cassette is first inserted and it takes several seconds for correct tape position to appear.

- The present tape position indication and amount of tape remaining (according to tape speed) is displayed.
- Tape remaining time display may not be precise.

- 2 Press **TAPE POSITION** (or wait 5 seconds) to return to normal screen.

Note

- This function cannot display exact amount of tape remaining for tapes 30 minutes or less, or for tapes over 120 minutes in length.

Repeat Play

Set to see a recording over and over.

- 1 Press **ACTION** to display MAIN MENU.

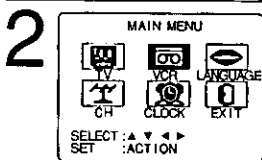

- 1) Press **▲▼◀▶** to select "VCR."
- 2) Press **ACTION** to display SET UP VCR screen.

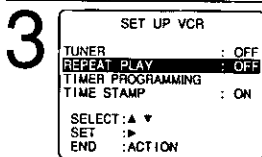

- 1) Press **▲▼** to select "REPEAT PLAY."
- 2) Press **▶** to set REPEAT PLAY "ON" or "OFF."

- 4 Press **ACTION** twice to end setup.

Notes

- Playback repeats when tape end is reached or unrecorded portion over 30 seconds is detected.
- During playback, you may also press PLAY/REPEAT repeatedly on the unit to select REPEAT "ON" or "OFF."

Play Lock mode

The unit may be locked in Repeat Play mode so that all other function keys are inoperative.

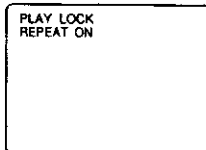

To turn "ON," hold down **PLAY** on the remote or unit for 7 seconds.

To turn "OFF," Repeat above operation in Play Lock mode.

- When the Play Lock mode is selected,**
- Auto Repeat function is activated automatically.
 - On Timer and Sleep Timer become nonfunctional.

Commercial Skip

<Model AG-520E unit shown>

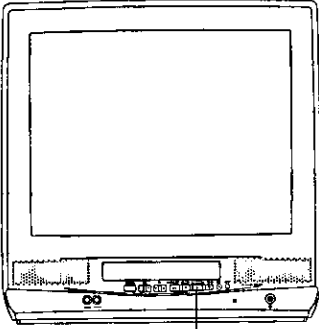

PLAY/REPEAT

By pressing the CM/ZERO button in Playback mode you can skip over 1 to 3 minutes of recorded tape in just a few seconds.

- 1 Press **CM/ZERO** repeatedly to select skip time in Playback mode.

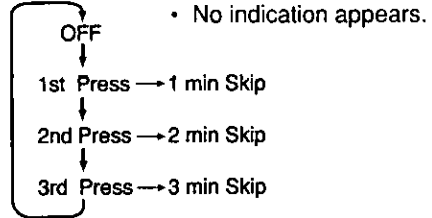

Zero Search

To quickly return to a specific tape counter location.

- 1 Press **DISPLAY** during playback to display the Counter.

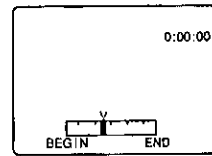

Press **COUNTER RESET** at the desired position to reset to "0:00:00."

2

- 3 Continue playback, rewind, or fast forward.

- 4 Press **STOP**.

5

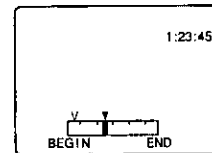

Press **CM/ZERO** in stop mode to start **ZERO SEARCH**.

- ▼ : Present position mark
- V : Zero position mark
- Unit goes into FF or REW mode and stops at the last point the Counter was set to 0:00:00.

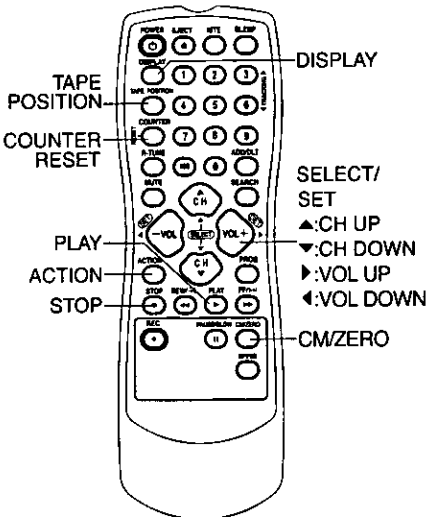

Note

- If a blank portion exists on the tape, and depending on the position of the V mark, the V mark display may be out of position.

Special VCR Features

Channel Caption is .

Station names, e.g. ABC, CNN, etc are set so they will appear when a channel is selected. Choose 24 preset names (Preset Caption), or make up to 10 names of your own (Manual Caption)

✓ Ready Checklist

- You need a list of stations and the channel numbers you receive them on

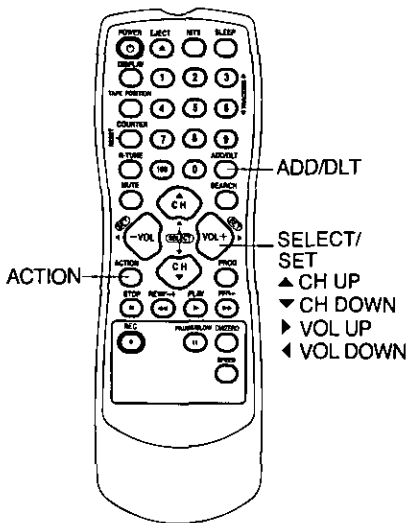

Preset Caption (TUNER:ON only)

- 1 Press **ACTION** to display MAIN MENU

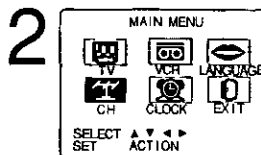

- 1) Press **▲▼◀▶** to select "CH"
- 2) Press **ACTION** to display SET UP CHANNEL screen

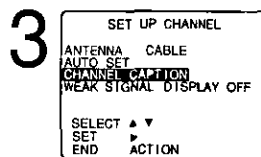

- 3) Press **▲▼** to select CHANNEL CAPTION
- 2) Press **▶** to display screen

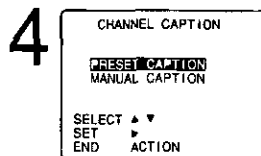

- 4) Press **▲▼** to select PRESET CAPTION
 - 2) Press **▶** to display screen
- To create your own captions, go to "Manual Caption" on page 29

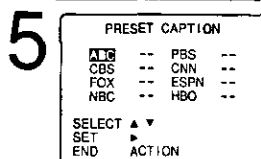

- 5) Press **▲▼** to select a station
 - 2) Press **▶** to move cursor to the right
 - 3) Press **▲▼** to select channel number
 - 4) Press **◀** to set preset captions
- Repeat step 5 until the Caption List is complete

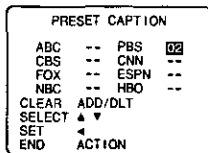

To Make Corrections

Press **▲▼**, then **▶** to select channel number
Press **▲▼** to change, or **ADD/HLT** to delete

- 6 Press **ACTION** four times to end setup

Manual Caption (TUNER:ON only)

1 Do "Preset Caption" steps 1~3 (page 28).

2

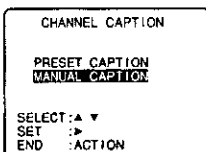

- 1) Press ▲▼ to select **MANUAL CAPTION**.
- 2) Press ► to display screen.

3

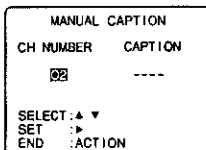

- 1) Press ▲▼ to select **CH NUMBER**.
- 2) Press ► to move cursor to the right.

- Channels already set in Preset Caption and channels deleted from Channel Memory are not displayed.
- You can set a total of ten channel captions with up to four characters each.

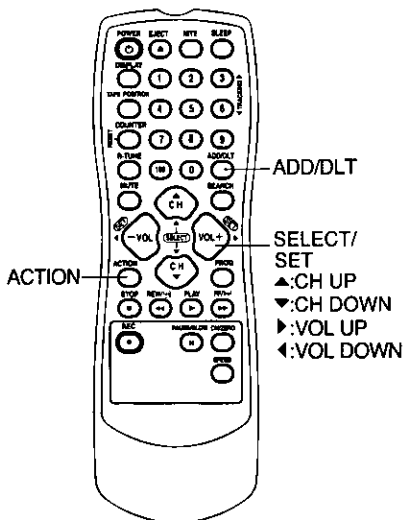

4

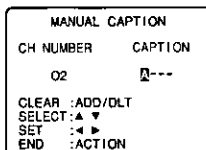

- 1) Press ▲▼ to select and ► to enter your caption.

- Characters change in the following order.

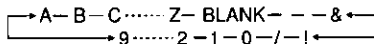

- Press ◄ repeatedly to move the cursor to "CH NUMBER." Repeat steps 3 and 4 as desired.

To Make Corrections

Press ▲▼, then ► to select channel number.
Press ▲▼ to change, or **ADD/DLT** to delete.

5 Press **ACTION** four times to end setup.

Special VCR Features (continued)

Weak Signal Display Feature (TUNER:ON only)

When "ON" is selected, the picture is displayed even when a broadcast signal is weak or non-existent.

1 Press **ACTION**
to display **MAIN MENU**.

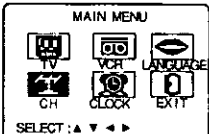
2  **1) Press ▲▼◀▶**
to select "CH."
2) Press ACTION
to display **SET UP CHANNEL** screen.

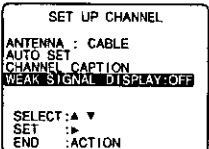
3  **1) Press ▲▼** to
select **WEAK SIGNAL DISPLAY**.
2) Press ▶ to set
"ON" or "OFF."

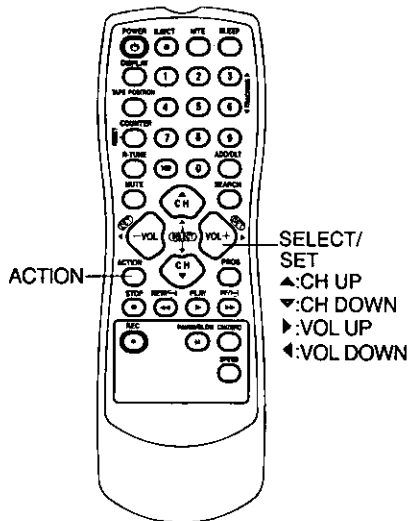

Notes

- "ON" = Picture is displayed regardless of signal condition, and may not always be clearly visible.
- "OFF" = Screen turns solid blue when signal is absent or weak.
- If unit is connected to equipment which has blue back feature, selecting "ON" will have no effect on the other equipment.

4 Press **ACTION** twice
to return to the normal screen.

<Model AG-520E unit shown>

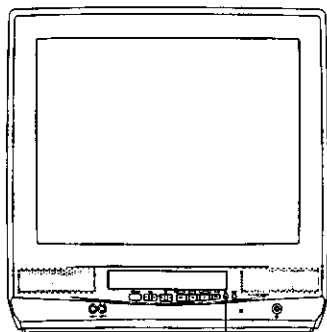

VCR Lock

All operations are prohibited except Timer recording and tape eject. Useful for families with small children.

VCR LOCK ACTIVATED

VCR LOCK OFF

In Stop mode, **hold down REC** on the unit without a cassette inserted for 7 seconds to turn "ON."
(Please ignore NO CASSETTE warning.)

Repeat above with or without cassette to turn "OFF."

- VCR Lock is canceled automatically after about 24 hours if clock is set.

✓ Ready Checklist

- The clock is set to correct time.
- The record tab is in place.

Time Stamp Feature

This unit writes program data (see example below) for about the first 10 seconds of every recording. The information is then displayed about 10 seconds after playback begins.

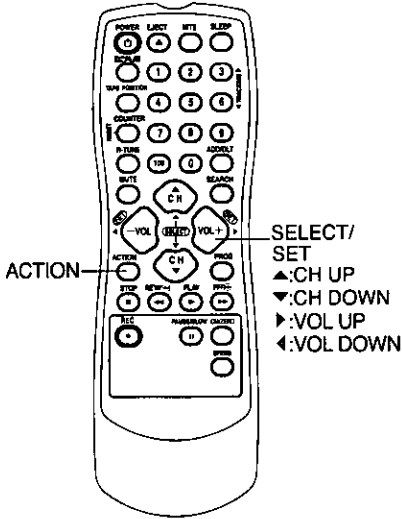

1 Press **ACTION** to display MAIN MENU.

2

MAIN MENU

CH	CLOCK	EXIT

SELECT: ▲ ▼ ◀ ▶
SET : ACTION

1) Press ▲▼◀▶ to select "VCR."

2) Press **ACTION** to display SET UP VCR screen.

3

SET UP VCR

TUNER	: OFF
REPEAT PLAY	: OFF
TIMER PROGRAMMING	: ON
TIME STAMP	: ON

SELECT: ▲ ▼ ◀ ▶
SET : ACTION

1) Press ▲▼ to select TIME STAMP.

2) Press ▶ to set "ON" or "OFF."

- When "OFF" is selected, the program data is written on the tape, but will not be displayed.

4 Press **ACTION** twice to return to normal screen.

<Time Stamp Example >

Normal/
One Touch Recording

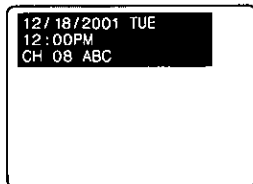

Timer Recording

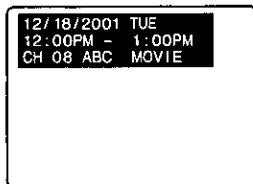

When Clock is not set...

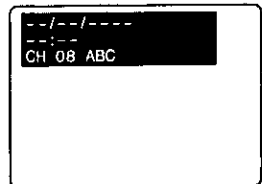

V-Chip Control Feature

Process of V-Chip Control Feature

Enter Code → Setup → Blocking

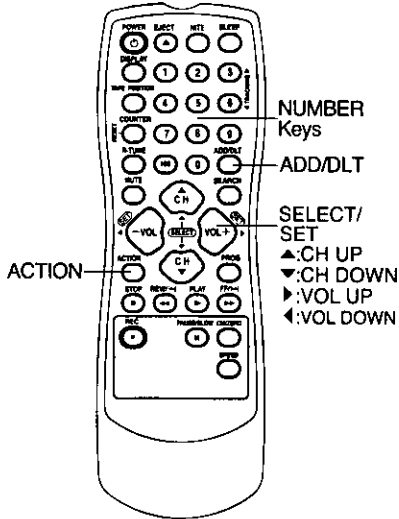

Changing your secret code

- You will need your current code. Do steps 1 ~ 4. In step 5, press **ADD/DLT** to clear current code. Repeat steps 4 and 5 to enter new code.

Notes

- DO NOT forget your secret code.
- Once ratings are set, restricted tapes or programs cannot be accessed unless the secret code is entered.
- Some rental movies do not include V-Chip data.

V-Chip Control Feature is...

This unit has a built-in V-Chip Control which allows you to block unwanted TV usage based on US MOVIES and US TV PROGRAMS Ratings.

Secret Code

A 4-digit code must be entered to view a blocked program or change rating settings.

1 Press ACTION to display MAIN MENU.

2

1) Press ▲▼◀▶ to select "TV."
2) Press **ACTION** to display SET UP TV screen.

3

1) Press ▲▼ to select **LOCK**.
2) Press ▶ to display screen.

<Only when TUNER:ON>

4

1) Press **number keys** to enter your secret code.
2) Enter **same code** again for confirmation.

To Make Corrections, Press ◀ repeatedly to move the cursor. Press **number keys** to make the correction.

- Step 2) not necessary when changing rating or secret code.
- Take care that you are not observed entering the secret code.

5

Press ▶ to display US Ratings menu (see pages 33 and 34).
Or Press **ACTION** three times to exit.

If **LOCK** menu is not displayed, "Secret Code" steps on page 32.

US MOVIES Ratings

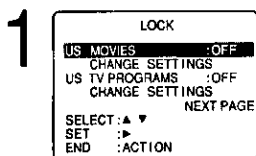

- 1) Press ▲▼ to select **US MOVIES**.
- 2) Press ▶ to set "ON" or "OFF."

- "ON" → V-Chip Control is activated.
- "OFF" → V-Chip Control is deactivated.

Note

- "NEXT PAGE" displays **CANADIAN** V-Chip setting menu. Not necessary except when viewing Canadian tapes or broadcasts.

Process of V-Chip Control Feature

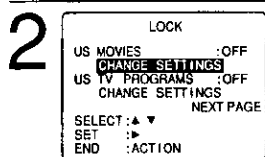

- 1) Press ▲▼ to select **CHANGE SETTINGS**.
- 2) Press ▶ to display screen.

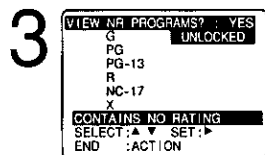

- 1) Press ▲▼ to select **VIEW NR PROGRAMS?**.
- 2) Press ▶ to set "YES" or "NO."

NR (Not Rated) PROGRAMS

Some movies, such as old movies or foreign movies usually have no ratings.

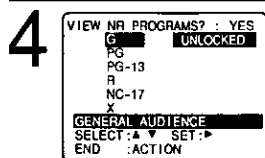

- Press ▲▼ to select and ▶ to set ratings to be blocked. (See ratings chart right.)

- 5 Press **ACTION** to redisplay **LOCK** menu and continue with **US TV PROGRAMS** Ratings Setup (next page). Or, press **ACTION** four times to exit.

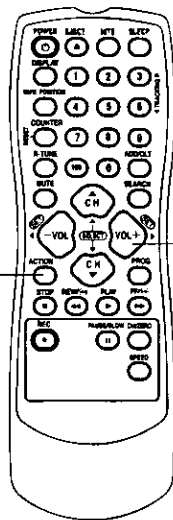

- ACTION
- SELECT/SET
- ▲: CH UP
- ▼: CH DOWN
- ▶: VOL UP
- ◀: VOL DOWN

G	GENERAL AUDIENCE: All ages admitted.
PG	PARENTAL GUIDANCE: Some material may not be suitable for children.
PG-13	PARENTS CAUTIONED: Some material may be inappropriate for children under 13.
R	RESTRICTED: Children under 17 must be accompanied by a parent or adult.
NC-17	OVER AGE 17 ONLY: No one 17 and under admitted.
X	ADULTS ONLY:

V-Chip Control Feature (continued)

If LOCK menu is not displayed, "Secret Code" steps on page 32.

US TV PROGRAMS Ratings

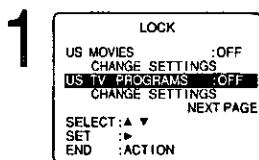

- 1) Press ▲▼ to select US TV PROGRAMS.
- 2) Press ► to set "ON" or "OFF."

- "ON" → V-Chip Control is activated.
- "OFF" → V-Chip Control is deactivated.

Note

- "NEXT PAGE" displays CANADIAN V-Chip setting menu. Not necessary except when viewing Canadian tapes or broadcasts.

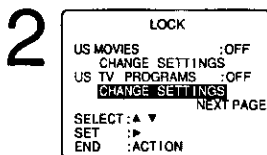

- 1) Press ▲▼ to select CHANGE SETTINGS.
- 2) Press ► to display screen.

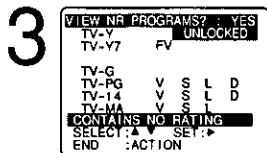

- 1) Press ▲▼ to select VIEW NR PROGRAMS?.
- 2) Press ► to set "YES" or "NO."

NR (Not Rated) PROGRAMS

Some TV shows, such as news, sports, weather, bulletins, and emergency information usually have no ratings.

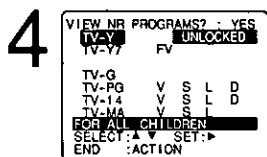

- 1) Press ▲▼ to select and ► to set ratings to be blocked. (See ratings charts right.)

- Ratings highlighted in Green will be blocked. Ratings in white letters will not be blocked.

5 Press ACTION four times to exit this mode.

US TV PROGRAMS RATINGS: Chart 1

TV-Y	FOR ALL CHILDREN: Content specifically geared to young viewers ages 2-6.
TV-Y7	FOR AGE 7 AND OLDER: May contain mild physical or comedic violence which may frighten children under 7.
TV-G	GENERAL AUDIENCE: Contains little or no violence, strong language, sexual dialogue or situations.
TV-PG	PARENTAL GUIDANCE: May contain infrequent coarse language, limited violence, some suggestive sexual dialogue and situations.
TV-14	PARENTS CAUTIONED: May contain sophisticated themes, sexual situations, strong language, and more intense violence.
TV-MA	MATURE AUDIENCE: May contain mature themes, profane language, graphic violence, and sexual situations.

US TV PROGRAMS RATINGS: Chart 2

FV	Fantasy Violence
V	Violence
S	Sexual Situations
L	Adult Language
D	Sexually Suggestive Dialogue

Process of V-Chip Control Feature

Enter Code → Setup → Blocking

Blocking Message

<When V-Chip Control is activated>

- If a program or movie exceeds the ratings you have set, a message will appear on a black background and sound is muted.

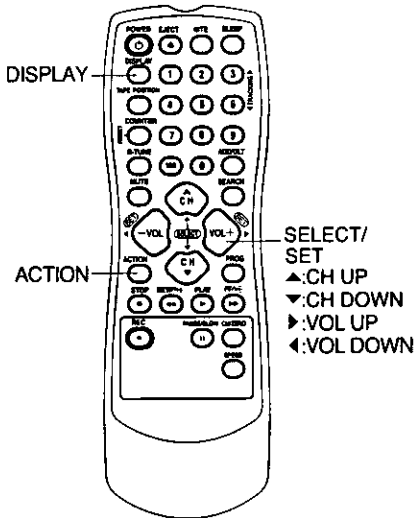
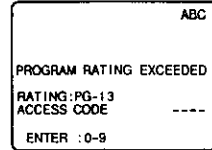

To View a Blocked Program / Movie

[Temporarily Deactivate V-Chip Control]
Enter your secret code (ACCESS CODE) in the Blocking Message screen.

- V-Chip Control is reactivated when power is turned off or power failure occurs.

[Deactivate V-Chip Control]

Enter your secret code (steps 1-4 on page 32). Then, set US MOVIES and/or US TV PROGRAMS to "OFF" using ▲▼ and ▶. (Ratings set on pages 33 and 34 are retained and will be in effect when V-Chip Control is activated again.)

- If **DISPLAY** is pressed, even when V-Chip control is deactivated, rating is displayed on-screen.

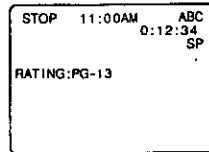

- If **DISPLAY** is pressed, even when no V-Chip data, "NO V-CHIP DATA" is displayed on-screen.

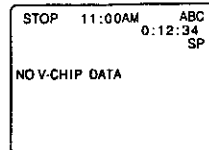

On-Screen Displays (OSD)

VCR Status & Clock Display

Press **DISPLAY** to display or remove the overlay.

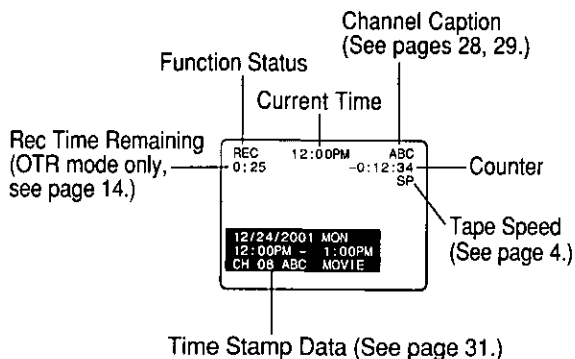

Blue Screen Display

Whenever a blank section of a tape comes up in Play mode, or when the selected channel has no broadcast signal with the Weak Signal Display Feature set to "OFF" (see page 30), the screen will turn solid blue.

Channel & Function Display

When a function button is pressed (PLAY, FF, etc.) or you change channels, the unit mode or channel number will be displayed. (Some station names may also appear if Channel Caption is set. See pages 28 and 29.)

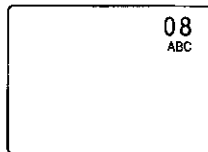

Warning and Instruction Displays

These displays will alert you to a missed operation or provide further instructions.

OSD	Caution	Page
NO CH FOUND PLEASE CHECK ANTENNA CABLE CONNECTION THEN PUSH CH UP KEY AGAIN	• If no active channels are found for CHANNEL MEMORY...	8, 10, 12
PLEASE SET CLOCK BEFORE PROGRAMMING	• If you attempt to set or review a Timer Recording, or set the On-Timer and the Clock is not set...	12, 13
CHECK CASSETTE RECORD TAB	• If you press REC, and a cassette is inserted with no record tab...	4, 14
TO CANCEL TIMER REC HOLD DOWN STOP KEY FOR APPROX 3 SEC	• If you press STOP during a Timer Recording...	23
NO CASSETTE PLEASE INSERT A CASSETTE	• If you press PLAY, FF, REW, or REC without a cassette inserted...	14
PLEASE PREPARE FOR TIMER REC	• If the unit is not in Stop mode or a cassette with record tab is not inserted two minutes before a Timer Recording is about to begin...	22, 23
VIDEO HEADS MAY NEED CLEANING PLEASE INSERT HEAD CLEANING CASSETTE OR REFER TO MANUAL END: PLAY KEY	• If head cleaning becomes necessary while playing back a tape...	4
VCR LOCK ACTIVATED	• If you press a function button other than STOP/EJECT or POWER while the unit is in VCR Lock mode...	30

Unit Information

Reset all unit Memory Functions

When moving unit to a new location, or if a mistake was made in the Initial Setup section.

- Make sure a tape is not inserted in the unit.

<Model AG-520E unit shown>

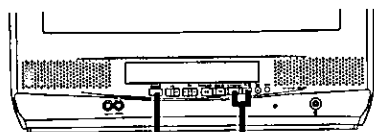

- 1 Turn the unit Power on.
- 2 Press and hold both **PLAY** and **FF** on the unit for more than 5 seconds.
 - The power will shut off.
 - Please ignore "NO CASSETTE" warning.
- 3 Do "Initial Setup" on pages 9 - 11.

Features for a Quality Picture

Digital Auto Tracking

Continuously analyzes the signal and adjusts for optimum picture quality.

Manual Tracking Control (to reduce picture noise)

Use during Playback and Slow Motion mode to reduce picture noise. **Press the 3 or 6 number key** on the remote control or **CH ▲▼** on the unit until the picture clears up. To return to Auto Tracking, **press POWER** off, then on again a few seconds later.

V-Lock Control

In Still mode, the **3 or 6 number key** on the remote control or **CH ▲▼** on the unit operate as a V-Lock control to reduce jitter.

PanaBlack Picture Tube

<For Model AG-520E only>

This unit uses a PanaBlack picture tube for better color reproduction and picture contrast.

Specifications

Display
Picture Tube: 13 inch (AG-513E)
20 inch (AG-520E)
measured diagonal 90°
deflection Picture Tube

VCR

Video Recording System: 4 rotary heads helical scanning system
1 track

Audio Track:

Tuner

Broadcast Channels: VHF 2 ~ 13, UHF 14 ~ 69
Midband A through I (14 ~ 22)
CABLE Channels: Superband J through W (23 ~ 36)
Hyperband AA ~ EEE (37 ~ 64)
Lowband A-5 ~ A-1 (95 ~ 99)
Special CABLE channel 5A (01)
Ultraband 65 ~ 94, 100 ~ 125

General

Power Source: 120 V AC, 60 Hz
Power Consumption: Power On
Approx. 69 watts (AG-513E)
Approx. 110 watts (AG-520E)
Power Off
Approx. 4.0 watts

Television System: EIA Standard NTSC color

Speaker: 1 piece

Operating Temperature: 5°C ~ 40°C (41°F ~ 104°F)

Operating Humidity: 10% ~ 75%

Weight: 12 Kg (26.4 lbs.) (AG-513E)

23 Kg (50.7 lbs.) (AG-520E)

Dimensions: 386 (W) X 385 (H) X

374 (D) mm

15-3/16" (W) X 15-3/16" (H)

X 14-3/4" (D) (AG-513E)

515 (W) X 505 (H) X

474 (D) mm

20-5/16" (W) X 19-7/8" (H)

X 18-11/16" (D) (AG-520E)

Note: Designs and specifications are subject to change without notice.

DST (Daylight Saving Time)

Unit auto adjusts clock for DST (Daylight Saving Time.)

■ Spring (First Sunday in April)

DST : ON → Sets clock ahead one hour.

■ Autumn (Last Sunday in October)

DST : ON → Turns clock back one hour.

- If your area does not observe Daylight Saving Time, select DST:OFF (see "Clock" on pages 12 and 13.)
- Keep these time changes in mind when programming the unit for timer recordings.

Before Requesting Service

Check the following points if you are having trouble with your unit.

Power	Correction
No power...	<ul style="list-style-type: none">• Completely insert Power Plug into an AC outlet.• Set POWER button to ON.
Monitor	Correction
No picture or sound...	<ul style="list-style-type: none">• Make sure your antenna system (TV or CABLE), is correctly set. (P. 8, 12)• Completely insert Power Plug into an AC outlet.• Set POWER button to ON.
Poor picture with normal sound...	<ul style="list-style-type: none">• Adjust BRIGHTNESS, SHARPNESS, and PICTURE controls in the SET UP TV menu. (P. 17)
Poor sound with normal picture...	<ul style="list-style-type: none">• Adjust VOLUME control. (P. 16)
Poor TV reception...	<ul style="list-style-type: none">• Adjust SHARPNESS and PICTURE controls in the SET UP TV menu. (P. 17)
No color or poor color...	<ul style="list-style-type: none">• Adjust TINT and COLOR controls in the SET UP TV menu. (P. 17)
Ghost (multiple) images...	<ul style="list-style-type: none">• Install a directional antenna.
TV programs cannot be watched...	<ul style="list-style-type: none">• Make sure the selected channel is in unit's memory. (P. 10, 12)
Channel cannot be selected...	<ul style="list-style-type: none">• Only the channel being recorded can be viewed on this unit.
VCR	Correction
TV program cannot be recorded...	<ul style="list-style-type: none">• Make sure your antenna system (TV or CABLE), is correctly set. (P. 8, 12)• Make sure cassette record tab is intact. (P. 4)
Timer recording cannot be performed...	<ul style="list-style-type: none">• Check that clock is set to current time and date.• Make sure DSS/CABLE box (if used) is left on and tuned to channel to be recorded.• Set recording Start/Stop times correctly. (P. 22, 23)• Timer recording may not be performed or continued if a power interruption of more than 1 minute occurs before or during a Timer recording even after power is restored.
No playback picture, or the playback picture is noisy or contains streaks... VCR cannot be controlled...	<ul style="list-style-type: none">• Adjust TRACKING control in either direction. (P. 37)• Try Head Cleaning. (P. 4)• Make sure PLAY/VCR LOCK is set to off. (P. 26, 30)• Make sure unit is not in a Timer Record operation.
Remote Control	Correction
Unit cannot be controlled...	<ul style="list-style-type: none">• Aim remote at remote sensor on unit (P. 7) so that signal is unobstructed.• Inspect the remote batteries. (P. 4)• Make sure PLAY/VCR LOCK is set to off. (P. 26, 30)• Exposing unit remote sensor to direct fluorescent or outdoor light may cause signal interference.
ACTION and PROG buttons cannot be selected...	<ul style="list-style-type: none">• Check remote batteries.
Miscellaneous	Correction
Video cassette cannot be inserted...	<ul style="list-style-type: none">• Insert the cassette window side up; record tab facing you.
Video cassette cannot be removed...	<ul style="list-style-type: none">• Completely insert Power Plug into an AC outlet.
Tape cannot be ejected or inserted...	<ul style="list-style-type: none">• Try ejecting or inserting the tape again after turning POWER off, then back on.
Video cassette ejects when a recording is started, or the power is turned off for timer recording...	<ul style="list-style-type: none">• Make sure cassette record tab is intact. (P. 4)
In Stop mode, the VCR motor (CYLINDER) continues to rotate...	<ul style="list-style-type: none">• To enable Quick Play mechanism, the VCR cylinder will rotate for about 3 minutes. This reduces response time from Stop to Play mode and from Play to Rewind Search mode.
VCR cannot be controlled...	<ul style="list-style-type: none">• Make sure PLAY/VCR LOCK is set to off. (P. 26, 30)

Index

A	Accessories	4	Q	Quality Picture	37
	ACTION button	12	R	Rapid Tune	16
	AC power plug	7		REC button	14
	ADD/DLT button	13		REC Indicator	7, 14
	Audio Mute	16		Rec(ord)	14
	Auto Operation Functions	26		Record/Playback Speed Settings	4
B	Batteries	4		Remote Control Buttons	6
	Before Requesting Service	38		Remote Sensor	7
	Before Using	4		Repeat Play	26
	Blocking Message	35		Reset Language, Channels, Clock	12, 13
	Blue Screen Display	36		Reset unit	37
C	Caption On Mute	21		Reverse Search	14
	Cassette Compartment	7		REW button	14
	Channel	10, 12, 36		Rewind	14
	Channel and Auto Set	10, 12		R-TUNE button	16
	Channel Caption	28, 29	S	Safety Precautions	3
	CHANNEL UP/DOWN button	16		SEARCH button	24, 25
	Clock (Auto/Manual Set)	9 - 13		Secret Code	32
	Closed Caption	20, 21		SELECT/SET button	11
	CM SKIP/ZERO SEARCH button	27		Sleep Timer	19
	Commercial Skip	27		Slow Motion	14
	Connections	8		Special VCR Features	28 - 31
	Copy Your Tapes (Dubbing)	15		Specifications	37
	COUNTER RESET button	27		SPEED button	14
D	DISPLAY button	36		Still Picture	14
	DSS/Cable Box Connections	8		Stop	14
	DST (Daylight Saving Time)	37		STOP button	14, 15, 23 - 25, 27
E	EJECT button	6, 7, 14	T	Table of Contents	5
	Eject tape	14		Tape Erasure Prevention	4
F	Fast Forward	14		Tape Operation	24 - 27
	FF button	14		Tape Position Display	26
	Forward Search	14		Timer Program Review, Replace, Clear ..	23
	Frame by Frame Advance	14		Timer Recording	22, 23
	Front Panel Indicators	7		Timer Recording Cancellation	23
	Function Display	36		Time Stamp	31
H	Head Cleaning	4		Time Zone Adjust	13
I	Important Safeguards and Precautions ..	2		TUNER ON/OFF	9
	Index Search	24		TV Operation	16
	Initial Setup	9 - 11		TV Timer Features	18, 19
	Input Mode	15	U	Unit, Front/Rear View	7
L	Language	9, 12		Unit Information	37
	Location of Controls	6, 7		US Movies Ratings	33
M	Manual Caption	29		US TV Programs Ratings	34
N	NIGHT Mode	16	V	VCR Lock	30
	NUMBER Keys	16		VCR Status & Clock Display	36
O	100 Key	16		VHF/UHF Antenna Input Terminal	7
	One Touch Recording	14		VOLUME UP/DOWN button	16
	ON TIMER Indicator	7, 18		V-Chip Control Feature	32 - 35
	ON-TIMER with Alarm	18	W	Warning and Instruction Displays	36
	On-Screen Displays (OSD)	36		Weak Signal Display Feature	30
	Outdoor Antenna Connections	8	Z	Zero Search	27
P	Phones	16			
	Playback	14			
	PLAY button	14			
	Play Lock mode	26			
	Picture Adjustment	17			
	POWER button	6, 9			
	Preset Caption	28			
	PROG button	6, 18, 22, 23			
	PROG TIMER Indicator	7, 14, 22			
	Program End Search	25			

Panasonic

Broadcast & Digital Systems Company

Panasonic Broadcast & Television Systems Company

Division of Matsushita Electric Corporation of America

Executive Office:

3330 Cahuenga Blvd W., Los Angeles, CA 90068 (323) 436-3500

Eastern Zone:

One Panasonic Way 4E-7, Secaucus, NJ 07094 (201) 348-7621

Central Region:

1707 N Randall Road E1-C-1, Elgin, IL 60123 (847) 468-5200

Western Zone:

3330 Cahuenga Blvd W, Los Angeles, CA 90068 (323) 436-3500

Government Marketing Department:

52 West Gude Drive, Rockville, MD 20850 (301) 738-3840

Matsushita Electric Corporation of America

Corporate Sales Group, Hawaii Region

99-859 Iwaiwa ST., Aiea, HI 96701-3267 (808) 488-7779

Panasonic Canada Inc.

5770 Ambler Drive, Mississauga, Ontario L4W 2T3 (905) 624-5010

Panasonic Sales Company

Division of Matsushita Electric of Puerto Rico, Inc.

Ave. 65 de infantería. Km. 9.5 San Gabriel Industrial Park, Carolina, PR 00985
(787) 750-4300

Printed in U.S.A.

LSQT0480A

S0601-0

Free Manuals Download Website

<http://myh66.com>

<http://usermanuals.us>

<http://www.somanuals.com>

<http://www.4manuals.cc>

<http://www.manual-lib.com>

<http://www.404manual.com>

<http://www.luxmanual.com>

<http://aubethermostatmanual.com>

Golf course search by state

<http://golfingnear.com>

Email search by domain

<http://emailbydomain.com>

Auto manuals search

<http://auto.somanuals.com>

TV manuals search

<http://tv.somanuals.com>