

# Panasonic

## SVGA Monitor/Receiver Operating Instructions

CT-36DV60

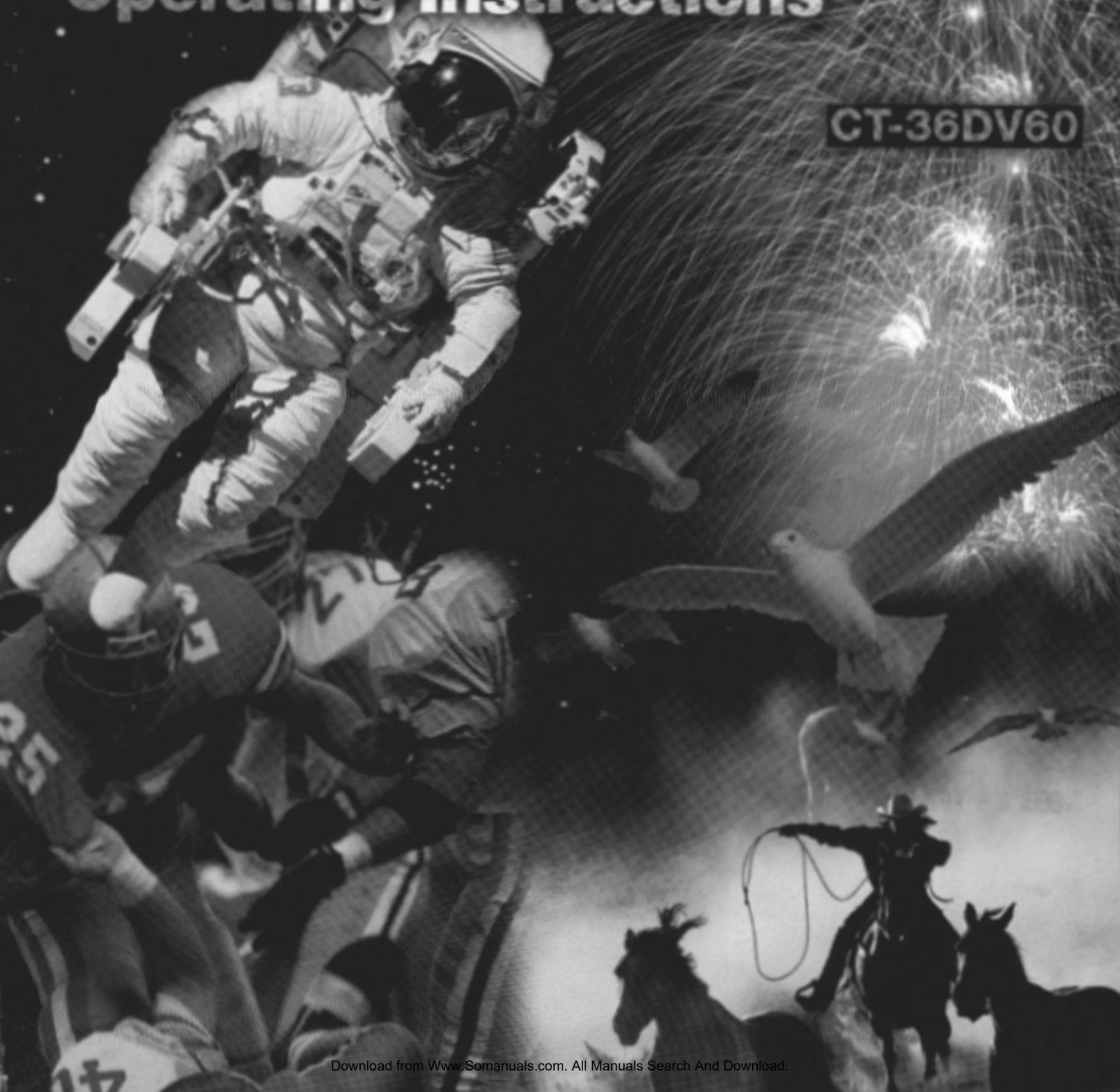

# Color Video Monitor/Receiver

## Operating Instructions



**CT-36DV60**

For additional information about Panasonic products, visit our Internet site on the World Wide Web at: <http://www.panasonic.com>

# Table of Contents

<b>Specifications</b> .....	3	Geomagnetic Corr (Correction) .....	23
<b>Safety Instructions</b> .....	4	Mode .....	23
<b>Introduction</b> .....	6	Auto Program .....	24
<b>Average Power Consumption</b> .....	6	Manual Program .....	24
<b>Important Information</b> .....	7	Closed Caption On Mute .....	25
FCC Statement .....	7	Closed Caption Mode .....	25
FCC Caution .....	7	<b>Timer Features</b> .....	26
<b>Installation</b> .....	8	Sleep Timer .....	26
Television Location .....	8	Program Timer .....	26
Optional External Equipment Connections .....	8	<b>Input Select</b> .....	27
AC Power Supply Cord .....	8	<b>Favorite channel</b> .....	27
Remote Control Battery Installation .....	8	Channel Scan .....	27
TV Antenna/Cable Connections .....	9	Favorite Channel Select .....	28
Other Video Equipment .....	9	<b>Channel Caption</b> .....	28
Care and Cleaning .....	9	Preset Caption .....	28
<b>Location of Controls (TV/Monitor)</b> .....	10	Manual Caption .....	29
Quick Reference Control Operation .....	10	<b>Lockout Features</b> .....	30
<b>Location of Control For The Home Theater</b>		Lockout Mode .....	30
<b>Remote Unit</b> .....	11	Unlock .....	31
Basic Remote Control Functions .....	11	<b>Control Panel Lock Feature</b> .....	31
<b>Remote Control Quick Reference Functional</b>		<b>Programming the Home Theater Remote</b> ...	32
<b>Key Chart</b> .....	12	Infrared Remote Codes For components ...	32
<b>Special Functions</b> .....	14	<b>VCR Infrared Codes Index</b> .....	33
Multi Button .....	14	<b>Cable Box and CD Players</b>	
Recall Button .....	14	<b>Infrared Codes Index</b> .....	34
R-Tune (Rapid Tune) Button .....	14	<b>Cassette Players, Receivers, and Amplifiers</b>	
<b>Optional Equipment Connection and Operation</b> ..	15	<b>Infrared Codes Index</b> .....	35
Stereo Connection (To Audio AMP) .....	15	<b>Laser Disc, DSS, and DVD</b>	
Video/Audio Connection .....	15	<b>Infrared Codes Index</b> .....	36
<b>TV MODE</b>		<b>PC MODE</b>	
<b>Trilingual Animated Icons</b> .....	16	PC Input Connection (Rear) .....	37
TV Mode Icons .....	16	PC Input Connection (Front) .....	38
<b>Menu Language Selection</b> .....	16	<b>TV/PC/DTV</b> .....	39
<b>Picture Adjustment</b> .....	16	<b>Trilingual Animated Icons</b> .....	39
Picture Norm .....	16	PC Mode Icons .....	39
Color, Tint, Brightness, Picture and		<b>Picture Adjustments</b> .....	39
Sharpness Adjustments .....	16	Picture Norm .....	39
Color Temp .....	17	Color, Tint, Brightness, Picture and	
Auto Color .....	17	Sharpness Adjustments .....	39
Video NR .....	17	Color Temp .....	40
<b>Audio Adjustment</b> .....	18	<b>Audio Adjustments</b> .....	40
Audio Norm .....	18	Audio Norm .....	40
Bass, Treble and Balance .....	18	Bass, Treble and Balance .....	40
Mode - Stereo/SAP/Mono .....	18	Speaker .....	41
Speaker .....	19	Surround .....	41
Surround .....	19	AI Sound .....	41
AI Sound .....	19	<b>Set Up Features</b> .....	42
<b>TV/PC/DTV</b> .....	20	Auto Power On .....	42
<b>Set Up Features</b> .....	20	Geomagnetic Corr (Correction) .....	42
Clock Auto .....	20	<b>Input Select</b> .....	42
Clock Manual .....	22	<b>Display Adj.</b> .....	43
Set Day .....	22	Display Adjust Chart .....	42
Auto Power On .....	22		

# Table of Contents (cont'd.)

<b>DTV MODE</b>		Surround . . . . .	47
Components Video Connections . . . . .	44	AI Sound . . . . .	47
<b>TV/PC/DTV</b> . . . . .	<b>45</b>	<b>Set Up Features</b> . . . . .	<b>48</b>
Trilingual Animated Icons . . . . .	45	Auto Power On . . . . .	48
DTV Mode Icons . . . . .	45	Aspect Ratio . . . . .	48
<b>Picture Adjustments</b> . . . . .	<b>45</b>	Color matrix . . . . .	48
Picture Norm . . . . .	45	Geomagnetic corr (Correction) . . . . .	48
Color, Tint, Brightness, Picture and		<b>TRUBLESHOOTING SECTION</b>	
Sharpness Adjustments . . . . .	45	<b>Troubleshooting Chart</b> . . . . .	<b>49</b>
Color Temp . . . . .	46	Computer Resolution Set Up	
<b>Audio Adjustments</b> . . . . .	<b>46</b>	For Windows 95 . . . . .	50
Audio Norm . . . . .	46	Computer Resolution Set Up	
Bass, Treble and Balance . . . . .	46	For Windows 3.X . . . . .	51
Speaker . . . . .	47		

## Specifications

<b>Power Source:</b>	120 V ac, 60 Hz
<b>Channel Capability:</b>	181 channels (See chart) VHF 2~13, UHF 14~69, Cable 125 channels
<b>Video Input Jacks (2):</b>	1 V p-p, 75 ohm, phono jack type
<b>Audio Input Jacks (2):</b>	500mV rms, 4.7K ohm
<b>To Audio Amp Jacks:</b>	0~2.0V rms, 4.7K ohm
<b>S-Video Input Jack (2):</b>	S-Video (Y-C) Connector
<b>DTV Input Jacks:</b>	Component Video (Y, P <sub>B</sub> , P <sub>R</sub> )
<b>Stereo Sound:</b>	NTSC with DBX Noise Reduction
<b>Surround Sound:</b>	Matrix

## Channel Capability Chart

BAND	CHANNELS
VHF	12
UHF	56
CABLE (Mid-Band)	15
CABLE (Super Band)	14
CABLE (Hyper Band)	28
CABLE (Ultra Band)	56
<b>TOTAL CHANNELS</b>	<b>181</b>

## Computer Monitor Specifications

PC and Mac Compatible	Yes
Viewable Image Size	36.0 inches
Dot Pitch	Date Grade
Multi-scan Rate	Yes
Horizontal Frequency Range	15 kHz to 38 kHz
Vertical Frequency Range	50 Hz to 120 Hz
Max. Data Resolution	800 x 600 @ 60 Hz
Linearity Correction	Automatic
S-Curve Correction	Yes
Dynamic Astigmatism and	
Focus Correction	Yes
Audio Input-computer	Mini-jack on front panel
Computer Input	2-Front and rear 15-pin connector

## Signal Capability Chart

Signal	Format	Horiz. Freq.	Vert. Freq.
NTSC		15.75 kHz	60 Hz Interlaced
VGA	640 x 480	31.5 kHz	70 Hz
VGA text		31.5 kHz	70 Hz
VGA	640 x 480	31.5 kHz	60 Hz
SVGA	800 x 600	37.9 kHz	60 Hz
MAC2	640 x 480	35 kHz	66.6 Hz

Specifications are subject to change without notice or obligation.

TV MODE

PC MODE

DTV MODE

TRUBLESHOOTING

# Safety Instructions

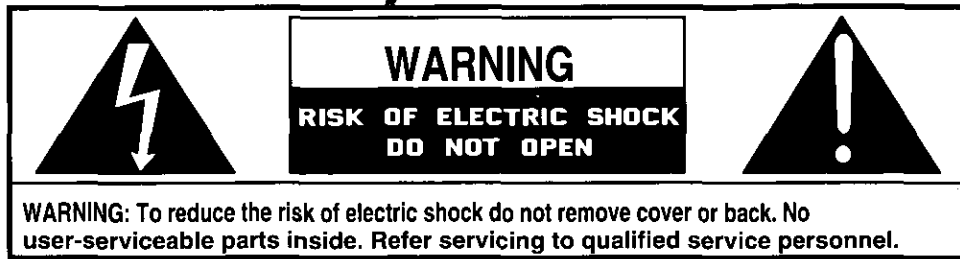

The lightning flash with arrow-head within a triangle is intended to tell the user that parts inside the product are a risk of electric shock to persons.



The exclamation point within a triangle is intended to tell the user that important operating and servicing instructions are in the papers with the appliance.

**Note To CATV System Installer:** This reminder is provided to direct the CATV system installer's attention to Article 820-40 of the NEC that provides guidelines for proper grounding and, in particular, specifies that the cable ground shall be connected to the grounding system of the building, as close to the point of cable entry as practical.

## Safety Instructions For Television Receivers

1. Read and apply the operating instructions provided with your television receiver.
  2. Read all of the instructions given here and retain them for later use.
  3. Unplug this television receiver from the wall outlet before cleaning. Do not use liquid or aerosol cleaners. Use a damp cloth for cleaning.
  4. Do not use attachments not recommended by the television receiver manufacturer as they may cause hazards.
  5. Do not use this television receiver near water. For example: Avoid placing it near a bathtub, washbowl, kitchen sink, or laundry tub, in a wet basement, or near a swimming pool, etc.
  6. Do not place this television receiver on an unstable cart, stand or table. The television receiver may fall, causing serious injury to a child or adult, and serious damage to the appliance. Use only with a cart or stand recommended by the manufacturer, or sold with the television receiver. Wall or shelf mounting should follow the manufacturer's instructions, and should use a mounting kit approved by the manufacturer.
- 6A. An appliance and cart combination should be moved with care. Quick stops, excessive force, and uneven surfaces may cause the appliance and cart combination to overturn.
- 
7. Slots and openings in the cabinet and the back or bottom are provided for ventilation, and to insure reliable operation of the television receiver and to protect it from overheating. These openings must not be blocked or covered. The openings should never be blocked by placing the television receiver on a bed, sofa, rug or other similar surface. This television receiver should never be placed near or over a radiator or heat register. This television receiver should not be placed in a built-in installation such as a bookcase unless proper ventilation is provided.
  8. Operate only from the type of power source indicated on the marking label. If you are not sure of the type of power supplied to your home, consult your television dealer or local power company. For television receivers designed to operate from battery power, refer to the operating instructions.
  9. This television receiver is equipped with a polarized alternating-current line plug (a plug having one blade wider than the other). This plug will fit into the power outlet only one way. This is a safety feature. If you are unable to insert the plug fully into the outlet, try reversing the plug. If the plug should still fail to fit, contact your electrician to replace your obsolete outlet. Do not defeat the safety purpose of the polarized plug.
  10. Do not allow anything to rest on the power cord. Do not locate this television receiver where the cord will be damaged by people walking on it.
  11. Follow all warnings and instructions marked on the television receiver.
  12. Do not overload wall outlets and extension cords as this can result in fire or electric shock.
  13. Never push objects of any kind into this television receiver through cabinet slots as they may touch dangerous voltage points or short out parts that could result in a fire or electric shock. Never spill liquid of any kind on the television receiver.

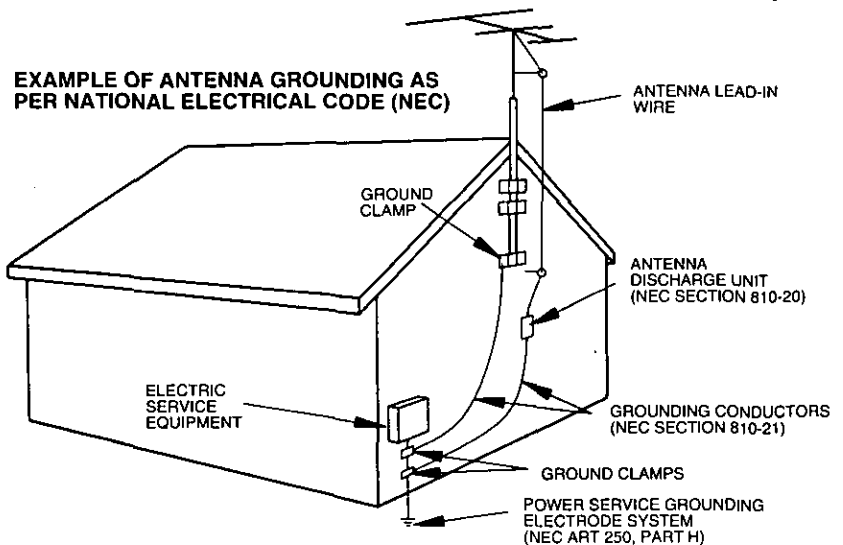

14. If an outside antenna is connected to the television equipment, be sure the antenna system is grounded so as to provide some protection against voltage surges and built up static charges. In the U.S. Section 810 of the National Electrical Code and in Canada Part 1 of the Canadian Electrical Code provides information with respect to proper grounding of the mast and supporting structure, grounding of the lead-in wire to an antenna discharge unit, size of grounding conductors, location of antenna-discharge unit, connection to grounding electrodes, and requirements for the grounding electrode. See Figure.

15. For added protection for this television receiver during a lightning storm, or when it is left unattended and unused for long periods of time, unplug it from the wall outlet and disconnect the antenna. This will prevent damage to the receiver due to lightning and power-line surges.

16. An outside antenna system should not be located in the vicinity of overhead power lines or other electric light or power circuits, or where it can fall into such power lines or circuits. When installing an outside antenna system extreme care should be taken to keep from touching such power lines or circuits as contact with them might be fatal.

17. Unplug this television receiver from the wall outlet, and refer servicing to qualified service personnel under the following conditions:

- a. When the power cord or plug is damaged or frayed.
- b. If liquid has been spilled into the television receiver.
- c. If the television receiver has been exposed to rain or water.
- d. If the television receiver does not operate normally by following the operating instructions. Adjust only those controls that are covered by the operating instructions as improper adjustment of other controls may result in damage and will often require extensive work by a qualified technician to restore the television receiver to normal operation.
- e. If the television receiver has been dropped or the cabinet has been damaged.
- f. When the television receiver exhibits a distinct change in performance - this indicates a need for service.

18. Do not attempt to service this television receiver yourself as opening or removing covers may expose you to dangerous voltage or other hazards. Refer all servicing to qualified service personnel.

19. When replacement parts are required, be sure the service technician has used replacement parts specified by the manufacturer that have the same characteristics as the original part. Unauthorized substitutions may result in fire, electric shock, or other hazards.

20. Upon completion of any service or repairs to this television receiver, ask the service technician to perform routine safety checks to determine that the television is in safe operating condition.

21. **WARNING:** To prevent fire or shock hazard, do not expose this appliance to rain or moisture.

22. **CAUTION:** TO PREVENT ELECTRIC SHOCK DO NOT USE THIS (POLARIZED) PLUG WITH A RECEPTACLE OR OTHER OUTLET UNLESS THE BLADES CAN BE FULLY INSERTED TO PREVENT BLADE EXPOSURE.

**NOTE:** This equipment is designed to operate in the U.S.A., Canada and other countries where the broadcasting system and AC house current is exactly the same as in the U.S.A. and Canada.

**Important Information Regarding Use of Video Games, Computers, Teletext or Other Fixed Image Displays.**

The extended use of fixed image program material can cause a permanent "shadow image" on the picture tube. This background image is viewable on normal programs in the form of a stationary fixed image. This type of irreversible picture tube deterioration can be limited by observing the following steps:

- A. Reduce the brightness/contrast setting to a minimum viewing level.
- B. Do not display the fixed image for extended periods of time.
- C. Turn the power off when not in actual use.

**NOTE:** The marking or retained image on the picture tube resulting from fixed image use is not an operating defect and as such is not covered by Warranty. This product is not designed to display fixed image patterns for extended periods of time.

# Introduction

## Congratulations on Your New Purchase

Your new TV/Monitor features an all solid state chassis which is designed to give you many years of enjoyment. It was thoroughly tested and adjusted at the factory for best performance. In order for you to take full advantage of your new TV/Monitor, please read and follow the installation and operating instructions contained herein.

### Customer's Record

The model and serial number of this product may be found on its back cover. You should note the model and serial number in the space provided and retain this book as a permanent record of your purchase to aid in identification in the event of theft or loss

Model Number: \_\_\_\_\_ Serial Number: \_\_\_\_\_

You may register your new television set on the Internet at:  
<http://www.prodreg.com/panasonic>

**For Customer Assistance:** Call the Panasonic Customer Call Center, 2F-3 One Panasonic Way, Secaucus, NJ 07094 (Headquarters) 800-211-PANA-(7262), Monday-Friday (9 a.m.-9 p.m. EST), Saturday-Sunday (9 a.m.-7 p.m. EST),

<b>Average Power Consumption</b>			
<b>TV Mode</b>	<b>VGA Mode</b>	<b>SVGA Mode</b>	<b>Standby Mode</b>
<b>180W</b>	<b>170W</b>	<b>175W</b>	<b>1.7W</b>

# IMPORTANT INFORMATION

## FCC STATEMENT:

This equipment was tested and found to comply within the limits for a Class B digital device, pursuant to Part 15 of the FCC rules. These limits are designed to provide reasonable protection against harmful interference in a residential installation.

This equipment generates, uses and can radiate radio frequency energy and, if not installed and used in accordance with the instructions, may cause harmful interference with radio communications. However, there is no guarantee that interference will not occur in a particular installation. If this equipment does cause harmful interference to radio or television reception, which can be determined by tuning the equipment on and off, the user is encouraged to try to correct the interference by one or more of the following measures:

- Reposition or relocate the receiving antenna.
- Increase the separation between the equipment and radio/TV receiver.
- Connect the equipment into an outlet on a circuit different from that to which the radio/TV is connected.
- Consult the dealer or an experienced radio/TV technician for assistance.

**Important:** Changes or modifications not expressly approved by the party responsible for compliance could void the user's authority to operate the equipment.

## FCC Declaration of Conformity

Responsible party:  
Matsushita Electric Corporation of America  
One Panasonic Way  
Secaucus, NJ 07094  
U.S.A.

Telephone Number: 1-800-211-7262  
(9 a.m.-9 p.m., Mon-Fri, EST)  
(9 a.m.-7 p.m., Sat-Sun, EST)

This device complies with part 15 of the FCC rules. Operation is subject to the following two conditions:  
(1) this device may not cause harmful interference, and (2) this device must accept any interference received, including interference that may cause undesired operation.

## FCC CAUTION:

Pursuant to 47CFR, Part 15.21 of the FCC rules, any changes or modifications to this monitor not expressly approved by Matsushita Electric Corporation of America could cause harmful interference and would void the user's authority to operate this device.

To assure continued compliance, the shielded video cable with bonded ferrite cores provided must be used when connecting this TV to a computer device. (Part #TSX4515-3). The TDK EMI filter, also provided, Part #ANF-106U, must be used to plug this TV into a grounding type outlet.

## CANADIAN NOTICE:

This class B digital apparatus meets all requirements of the Canadian Interference-Causing Equipment Regulations.

## AVIS CANADIEN:

Cet appareil numérique de la classe B respecte toutes les exigences du règlement sur le matériel brouilleur du Canada.

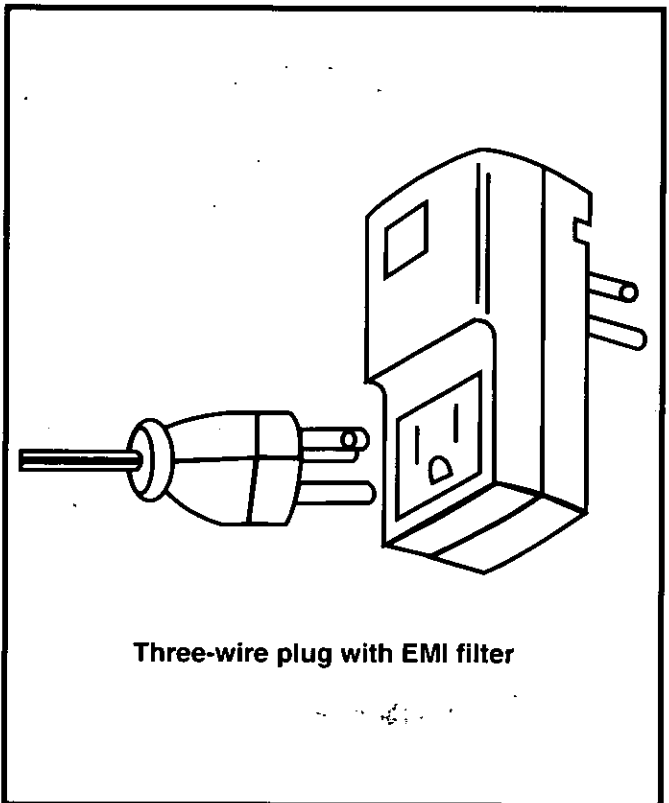



# Installation

## Video Monitor/Receiver Location

This video monitor/receiver is intended to be used with an optional stand. Consult your dealer for available options. Locate for comfortable viewing. Avoid placing where sunlight or other bright light (including reflections) will fall on the screen. Use of some types of fluorescent lighting may reduce remote control transmitter range.

Adequate ventilation is essential to prevent internal component failure. Keep away from areas of excessive heat or moisture. To insure optimum color purity do not position equipment containing magnets (motors, fans, external speakers, etc.) nearby.

## Optional External Equipment Connections

The Video/Audio connections between components can be made with shielded video and audio cables. For best performance, video cables should be of 75 ohm type coaxial shielded cables. Cables are available from dealer or electronic supply house.

Before you purchase any cables, check out the type of output and input connectors your various components require. Also determine the length of cable you will need.

## Power Supply Cord

MAKE SURE PLUG IS INSERTED FULLY INTO THE EMI FILTER. SEE PAGE 7 ILLUSTRATION.

This product is equipped with a three-wire grounding type plug—a plug with two blades and a third pin which is round. This plug will only fit into a grounding type outlet.

This is a safety feature. If you are unable to insert the plug into the outlet, contact your electrician to replace your obsolete outlet. **DO NOT DEFEAT THE SAFETY PURPOSE OF THE GROUNDING TYPE PLUG.**

## Remote Control Battery Installation

Batteries: Use two "AA" batteries.

1. Remove the battery compartment cover on back of the remote.
2. Install the batteries in the battery compartment. (Polarity (+) or (-) must be correct.)
3. Reattach the battery cover.

### Helpful Hints:

For frequent Remote Control users, replace old batteries with Alkaline batteries for longer life.

## Precaution on Battery Use

Incorrect installation can cause battery leakage and corrosion that will damage the Remote Control.

**Observe the following Precautions:**

1. Batteries must be replaced as a pair.
2. Do not combine a used battery with a new one.
3. Do not mix battery types (Example: "Zinc Carbon" with "Alkaline").
4. Do not attempt to charge, short-circuit, disassemble, heat or burn used batteries.
5. Battery replacement is necessary when Remote Control reacts sporadically or stops operating the television.

### NOTE:

Whenever you remove the batteries to replace them, **you may need to reset the Remote Control Infrared Codes.** We recommend that you initially record the codes in the Infrared Remote Codes for Specific Components section, prior to setting up the remote.

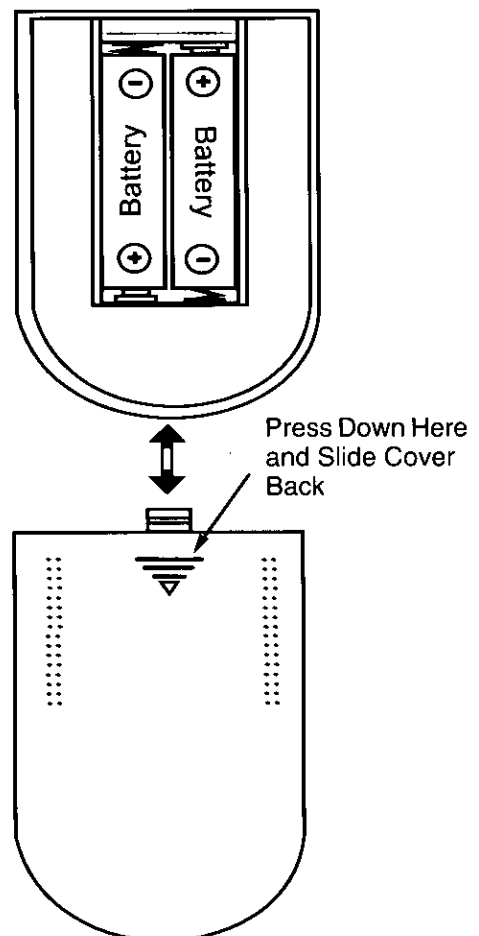

# Installation (cont'd.)

## TV Antenna/Cable Connections

**Antenna Connection** – For proper reception of VHF/UHF channels, an external antenna is required. For best reception, an outdoor antenna is recommended. In the **SETUP** menu, set the **MODE** to **TV**. (Refer to Antenna Mode section.)

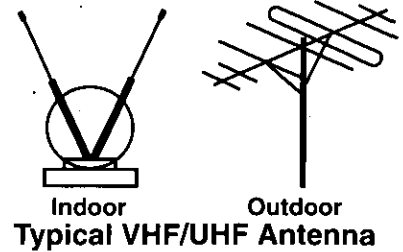

### Incoming Cable from Home Antenna

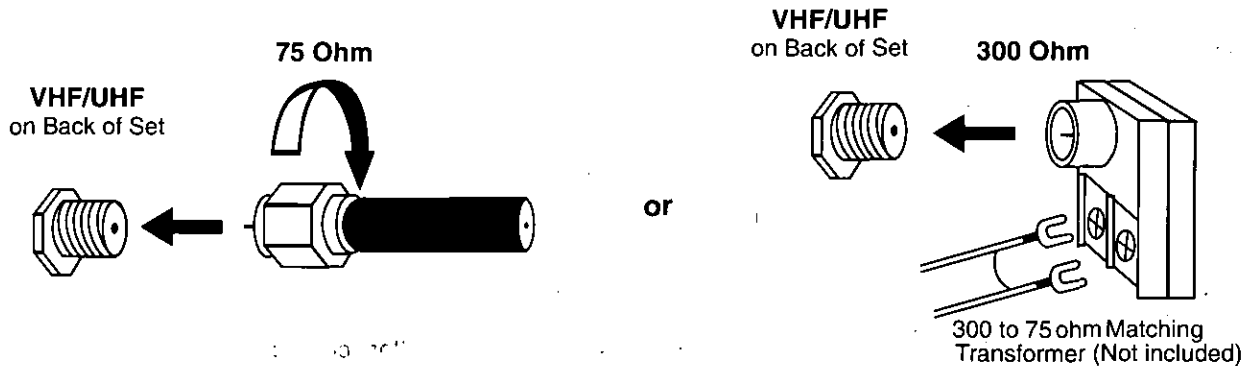

**Cable Connection** – For reception of cable channels, connect the cable supplied by your local cable company. In the **SETUP** menu, set the **MODE** to **CABLE**. (Refer to Antenna Mode section.)

### Incoming Cable from Cable Company

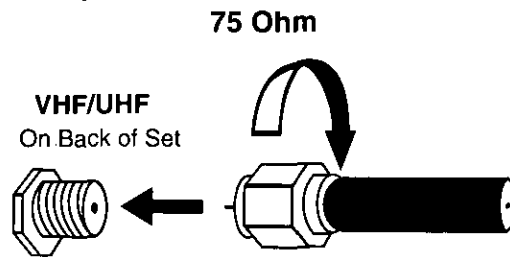

**Note:** Certain cable systems offset some channels to reduce interference, or have premium (scrambled) channels. A cable converter box is required for proper reception. Check with your local Cable company for compatibility requirements.

## Other Video Equipment

VCRs, Video Disc Players, Computers, TV games, and DSS equipment can also be connected to the antenna input connection.

# Care and Cleaning

## Picture Tube (Turn television off)

Use a mild soap solution or window cleaner and a clean cloth. **DO NOT USE ABRASIVE CLEANERS.** Avoid excessive moisture and wipe dry.

## Plastic Cabinet

Wipe the cabinet with a soft cloth dampened with water or a mild detergent solution and wipe dry with a soft clean cloth. Avoid excessive moisture. Do not use benzene, thinners or other petroleum-based cleaners.

## Remote Control Transmitter

Use a soft cloth slightly moistened with a mild detergent and then wipe dry with a soft clean cloth. Avoid excessive moisture. Do not use benzene, thinners or other petroleum-based cleaners.

# Location of Controls (TV/Monitor)

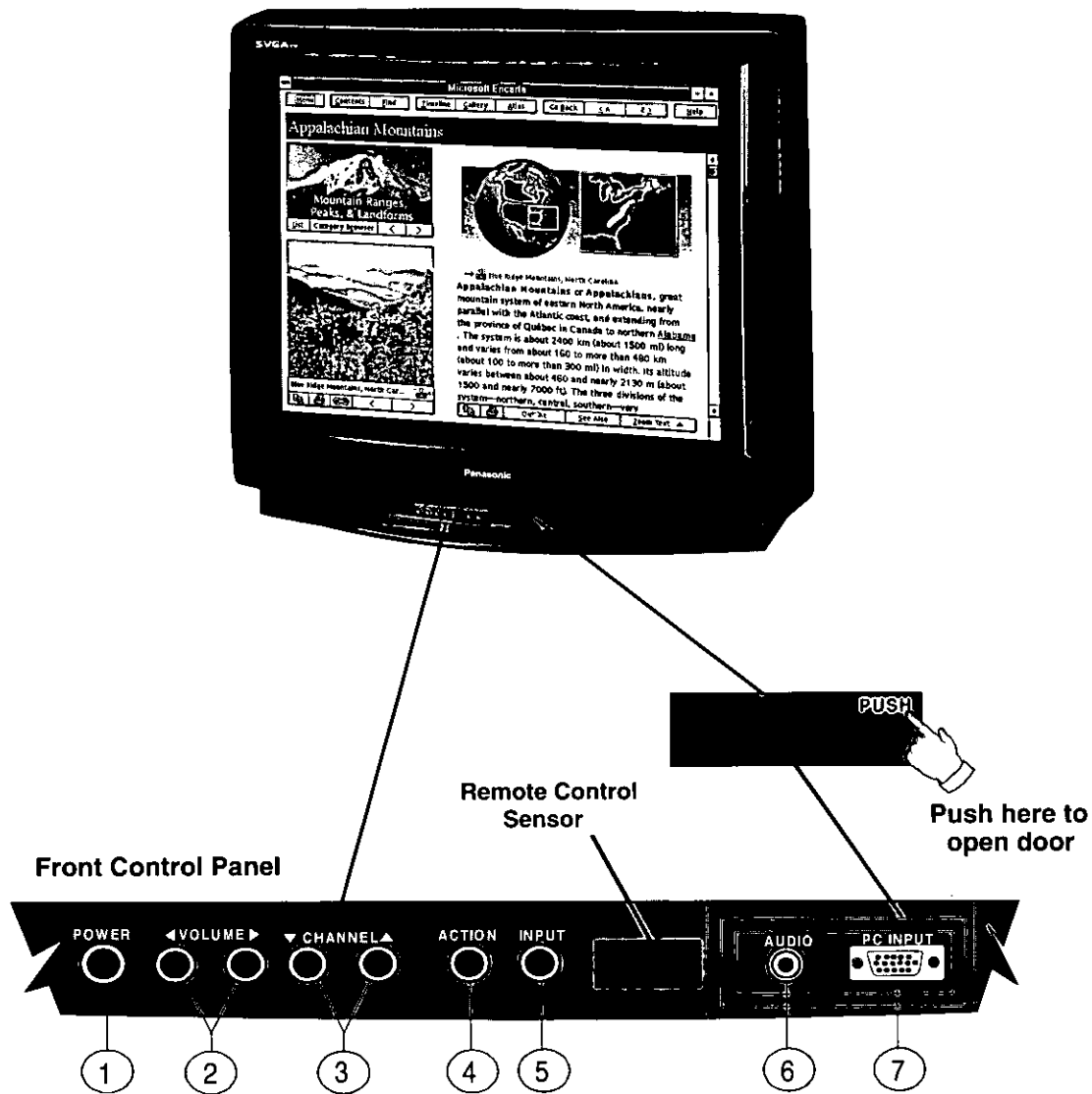

## Quick Reference Control Operation

- ① **Power Button** – Press to turn television ON or OFF.
- ② **Volume Buttons** – Press to adjust Sound Level, Audio and Video Menus and to select operating features when menus are displayed.
- ③ **Channel Buttons** – Press to select programmed channels or to highlight desired features when menus are displayed.
- ④ **Action Button** – Press to display Main Menu and access or exit On Screen feature and Adjustment Menus.
- ⑤ **Input Button** – TV Mode press to select TV or one of two Video Inputs. PC Mode press to select Front or Rear PC Input.
- ⑥ **Audio Input** – Use Front PC Audio input jack when connected to a PC sound source Audio output.
- ⑦ **PC Input** – Connect to a computer having a 15-pin output terminal.

# Location of Controls for the Home Theater Remote Unit

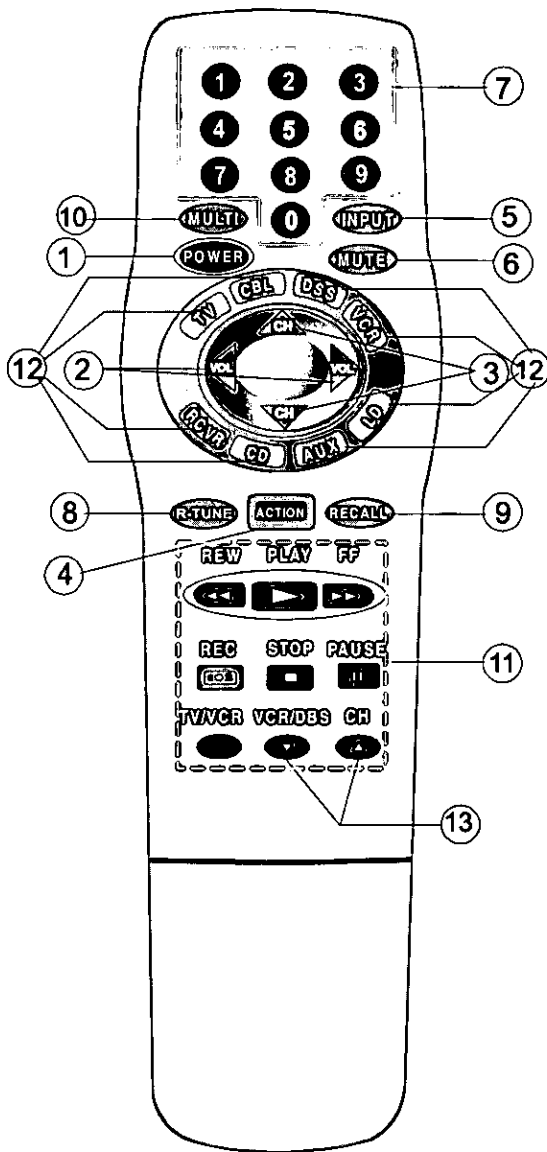

Home Theater  
Remote Control  
TNQ2AE012

## Basic Remote Control Functions

The following is a basic overview of the remote control unit for TV/Monitor operation. Ensure the TV mode button is selected by initially pressing .











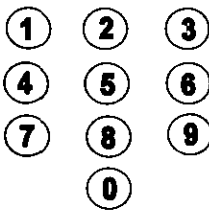



- ① **Power Button** - Press to turn the TV ON or OFF.
- ② **Volume Buttons** - Press to adjust TV sound level. Use with Channel buttons to navigate in menus.
- ③ **Channel Buttons** - Press to select channels. Use with Volume buttons to navigate in menus.
- ④ **Action Button** - Press to display Main Menu and access or exit On-Screen feature and Adjustment Menus.
- ⑤ **Input Button** - Press to select TV or one of two (2) Video Inputs. Also used to select Front or Rear PC Input.
- ⑥ **Mute Button** - Press to mute sound. A second press returns sound.
- ⑦ **Numeric Keypad (0 through 9 Buttons)** - Press desired channel to access any channel.
- ⑧ **R-Tune (Rapid Tune) Button** - Switches between two (2) channels.
- ⑨ **Recall Button** - Press to display Time, Status or Sleep Timer, Channel, Video Mode, Channel Caption (Station Identifier), and Audio Mode.
- ⑩ **Multi Button** - Programmable to operate up to six (6) Remote Function buttons simultaneously.
- ⑪ **VCR Functions Buttons** - Programmable to operate many brands of VCR's.
- ⑫ **Mode Selection Buttons** - Selects the operations mode for the remote control.
- ⑬ **VCR/DSS Channel Buttons** - These buttons are used to select VCR or DSS channels (Up/Down).

## Helpful Hints:

If the selected component does not respond to the remote control, ensure that the proper mode is selected. **First**, press the **Mode Selection Button** that corresponds to that component. For example, after first pressing the TV mode button, the remote will remain in the TV mode for any following commands. If a different mode button is pressed while operating the television, the TV mode button must be pressed again to reset the TV mode condition.



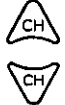







# Remote Control

## Quick Reference Functional Key Chart

KEY	MODE	FUNCTION
	TV VCR, VCR 2 CABLE, DSS	Selects Channel Selects Channel Selects Channel
	RECEIVER/AMPLIFIER	④ Selects Tuner ⑤ Selects CD Player ⑥ Selects Tape Cassette Player ⑦ VCR 1 ⑧ VCR 2
	CD PLAYER	Selects Track Number
	LD PLAYER	Selects Track Number
	ALL COMPONENTS	Programmable Button That Can Operate Up To Six (6) Remote Functions At Once
	TV	Select the TV Input Mode Also Selects Front or Rear PC Input
	ALL COMPONENTS	Turns On and Off Selected Components
	TV, DSS, VCR, VCR 2 LDP CABLE RECEIVER/AMPLIFIER	Mutes TV Audio Mutes Audio Mutes Audio
	TV	TV Mode Selection for Remote Control
	CABLE	Cable Mode Selection for Remote Control
	DSS (DIGITAL SATELLITE SYSTEM)	DSS Mode Selection for Remote Control
	VCR	VCR Mode Selection for Remote Control
	RECEIVER/AMPLIFIER	Receiver/Amplifier Mode Selection for Remote Control
	COMPACT DISC	CD Mode Selection for Remote Control
	CASSETTE DECK, VCR 2, DVD	AUX Mode Selection for Remote Control Enables User to Operate a Cassette Deck, Digital Video Disc or Second VCR
	LASER DISC PLAYER	LD Mode Selection for Remote Control
	TV CABLE DSS LDP CD RECEIVER/AMPLIFIER DVD	Channel Up/Down, Menu Navigation Channel Up/Down DSS Guides and Menu Navigation Skip FF, REW Preset or Tuning Frequency Skip FWD/Skip REW
	TV CABLE DSS RECEIVER/AMPLIFIER VCR, VCR 2 LDP	Volume Up/Down, Menu Navigation Volume Up/Down DSS Guides and Menu Navigation Volume Up/Down TV Volume Up/Down TV Volume Up/Down

# Remote Control

## Quick Reference Functional Key Chart (cont'd.)

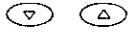
KEY	MODE	FUNCTION
	LDP TV CABLE VCR, VCR 2 DSS RECEIVER/AMPLIFIER CD AUTO TAPE RECORDER	A/B Repeat Switches Between Two (2) Channels Switches Between Two (2) Channels Switches Between Two (2) Channels Switches Between Two (2) Channels Switches Between AM and FM Selects Next Disc Selects Audio Tape Recorder A or B
	TV DSS	Activates TV Menus Acts as Menu Button for DSS
	TV DSS VCR, VCR 2 LDP	Displays Channel, Sleep Time, Channel Caption, Time and Audio Mode Displays Current DSS Settings Displays Current VCR Settings Displays Current LDP Settings
REW 	DSS VCR, VCR 2 LDP TAPE CD DVD	DSS Guide Rewind Rewind Rewind Selects Previous Track Rewind
PLAY 	DSS VCR, VCR 2 LDP TAPE CD DVD	Enter/Select Play Play Play (in Normal Direction) Play Play
FF 	DSS VCR, VCR 2 LDP TAPE CD DVD	Exit/Clear Fast Forward Fast Forward Fast Forward Selects Next Track Fast Forward
REC 	DSS VCR, VCR 2 TAPE CABLE	One Touch Record in DSS Mode Record Record VCR Record
STOP 	DVD VCR, VCR 2 LDP TAPE CD CABLE	Stop Stop Stop Stop Stop VCR Stop
PAUSE 	DVD VCR, VCR 2 LDP TAPE CD CABLE	Pause Pause Pause Pause Pause VCR Pause
TV/VCR 	VCR, VCR 2 DSS CABLE	Selects TV/VCR Mode Selects TV/DSS Mode Selects TV/VCR Mode
VCR/DSS CH 	VCR, VCR 2 DSS	Channel Up/Down Channel Up/Down

# Special Functions

## MULTI Button

The MULTI Button can be programmed to issue several commands at the same time.

**Example:** TV Power/On, VCR Power/ON, and Cable Box Power/On.

### Procedure:

1. Enter proper infrared codes for all devices before programming. See code section.
2. Point your Remote Control Transmitter away from all equipment remote sensors, then:

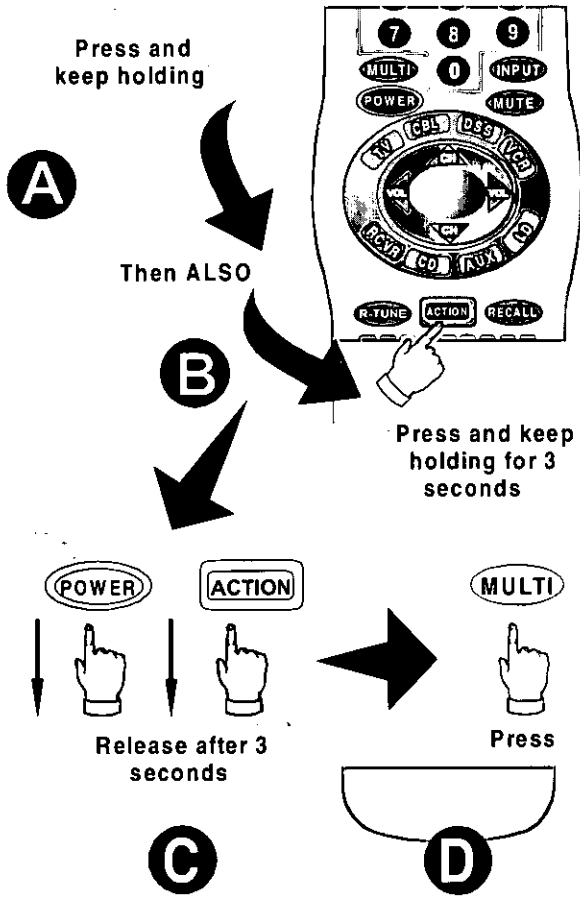

**NOTE:** Waiting more than 30 seconds without pressing another button will exit the programming mode.

3. Press a maximum of 6 function buttons on the Remote Control. Each button you press is equal to one function. If 6 Remote button functions are entered, all will register in the MULTI button memory when the sequence is entered. When finished, press the MULTI to exit the programming mode.

**NOTE:** Buttons which continuously perform a function as long as pressed (Volume Up/Down, Channel Up/Down, etc.) cannot be programmed; only those buttons which perform a function when initially pressed (Power On/Off, Mute, Direct Channel Entry, etc.) can be programmed.

The following is a flow chart example of remote functions that can be programmed into the MULTI button:

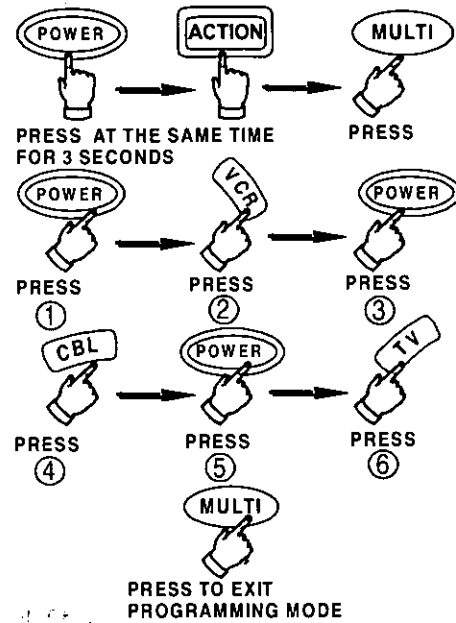

Pressing the MULTI button will now activate the VCR Power/On, Cable Box Power/On, and the Receiver Power/On at the same time.

## RECALL Button

Press the RECALL Button to review:

- ① Audio Mode status
- ② CH number or Video Input selected
- ③ Channel Caption (Station Identifier)
- ④ Clock time
- ⑤ Sleep Timer status

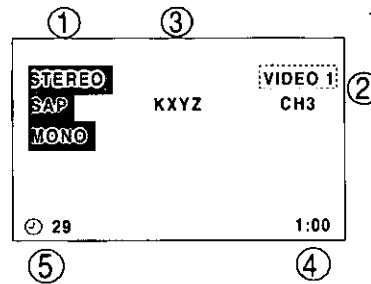

## R-TUNE Button

Pressing the R-TUNE (RAPID TUNE) button toggles to the previously tuned program.

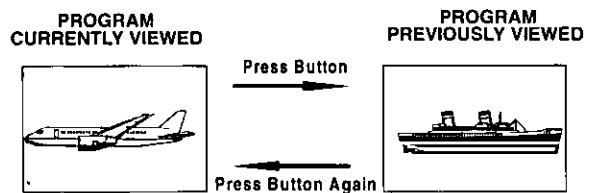

# Optional Equipment Connection and Operation

## To Audio AMP Connection (Stereo)

Connect to an external audio amp auxiliary input for monitoring sound through a stereo system.

TERMINALS ON BACK OF MONITOR

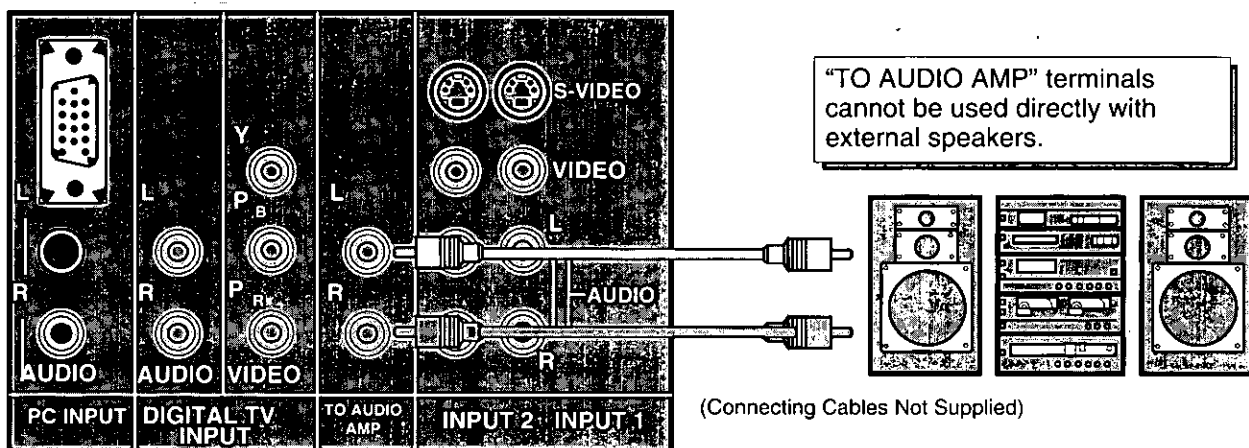

**Adjustment** – When an audio amp is connected to “TO AUDIO AMP” terminals:

1. Select TV SPEAKERS “ON” Mode. (Refer to the Menu TV Speakers section.)
2. Set volume of audio amp to near minimum.
3. Adjust volume of TV to desired listening level.
4. Adjust volume of audio amp to match the level of TV.
5. Select TV SPEAKERS “OFF&VAO” Mode. (Refer to the Audio Menu TV Speakers section.)
6. Audio bass, treble, balance, volume and mute can now be controlled by the TV Remote Control.

**NOTE:** When Selecting TV SPEAKERS “OFF&FAO” Mode, the TV sound output is always at a constant level and cannot be changed (Refer to the Audio Menu TV Speakers section).

## Audio/Video Input Connection

TERMINALS ON BACK OF MONITOR

S-Video connection is optional and overrides the standard Video connection when connected.

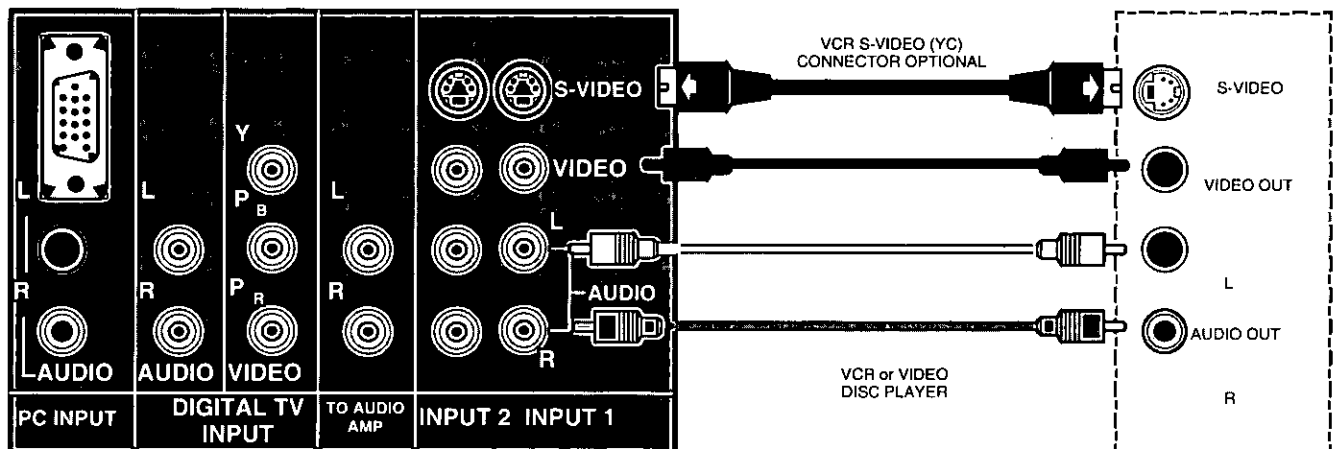

## Operation

1. Connect optional equipment as shown to INPUT 1 or 2 terminals. If S-Video is to be used, connect S-Video (YC) connector to S-Video terminal 1 or 2 and connect audio cables to L & R Audio INPUT 1 or 2 terminals.
2. Select the desired Video mode by pressing Input or TV/VIDEO button.
3. Operate optional equipment (VCR, DVD or VDP) as instructed in Optional Equipment manual.

## NOTE:

- You must select the proper VIDEO Input Mode where the equipment is connected.
- Connection of optional S-VIDEO jack automatically disconnects Video Input 1 or 2 jacks.



# TV Mode

## Trilingual Animated Icons

The Icons allows the users to configure the TV according to their preference. It will also set up the monitor to operate with external components connected to the terminal jacks

### TV Mode Icons

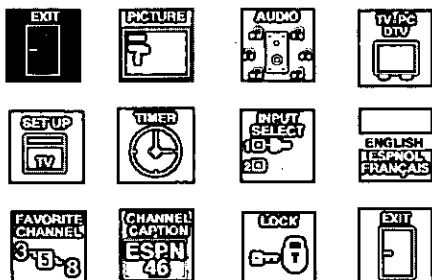

**NOTE:** Only the selected icon (red) will be animated.

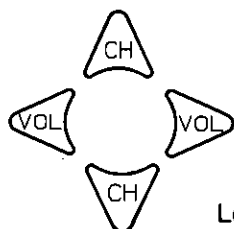
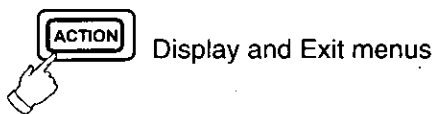

**CH BUTTONS**  
Highlight Desired Feature on Menus

**VOL BUTTONS**  
Selects or Adjusts Features on Menus

Located on Remote Control

## Menu Language Selection

The MENU LANGUAGE is factory set to ENGLISH. Follow the instructions to change it to SPANISH, FRENCH, and back to ENGLISH (TV, PC, and DTV mode).

1. Press **ACTION**.
2. Press **CH** or **CH** and **VOL** or **VOL** to highlight the Language ENGLISH /ESPAÑOL/FRANÇAIS Icon.
3. Press **ACTION** to display the Language select menu.

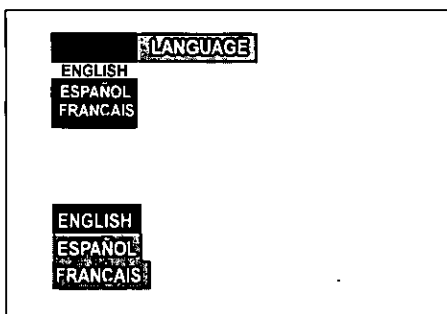

- Press **CH** or **CH** to select ENGLISH, ESPAÑOL or FRANÇAIS for the Language Menu.
- Press **ACTION** twice to exit menus.

## Picture Adjustments

### Picture Norm

Use to reset Color, Tint, Brightness, Picture, and Sharpness adjustments to the factory preset level for TV Mode only.

1. Press **ACTION**.
2. Press **CH** or **CH** and **VOL** or **VOL** to highlight the Picture Icon.
3. Press **ACTION** to display the Picture Adjustment Menu.

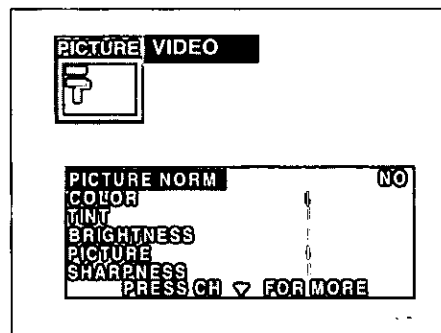

4. Press **CH** or **CH** to highlight PICTURE NORM.
5. Press **VOL** or **VOL** to select "SET" to normalize Color, Tint, Brightness, Picture, and Sharpness.
6. Press **ACTION** twice to exit menus.

### Color, Tint, Brightness, Picture, and Sharpness Adjustments

#### Helpful Hints:

**COLOR** - Adjust for desired color intensity.  
**TINT** - Adjust for natural flesh tones.  
**BRIGHTNESS** - Adjust so dark areas of picture slightly became black for a crisp detail.  
**PICTURE** - Adjust the white areas of the picture as desired.  
**SHARPNESS** - Adjust for best clarity of outline detail.

1. Press **ACTION**.
2. Press **CH** or **CH** and **VOL** or **VOL** to highlight the Picture Icon.
3. Press **ACTION** to display the Picture Adjustment menu.

# Picture Adjustments (cont'd.)

## Color, Tint, Brightness, etc. (cont'd.)

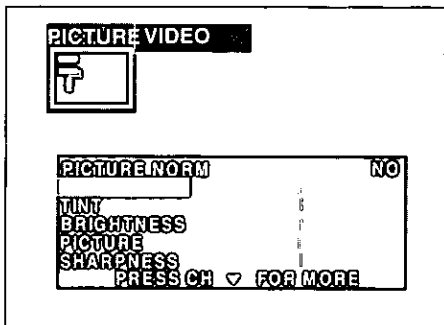

4. Press or to select the desired Picture Adjustment (Color, Tint, Brightness, Picture, or Sharpness).
5. Press or to adjust your selection. (The Selected Picture Adjustment will be displayed.)
6. Repeat steps 4 and 5 for the remaining Picture Adjustments.
7. Press twice to exit menus.

### Color Temp

To select one of three (3) options for picture temperature.

#### Helpful Hints:

**NORMAL** - No tint  
**WARM** - Reddish tint  
**COOL** - Bluish tint

1. Press .
2. Press or and or to highlight the Picture Icon.
3. Press to display the Picture Adjustment menu.

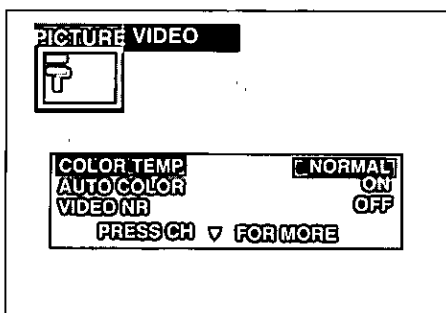

4. Press or to highlight COLOR TEMP.
5. Press or to select NORMAL, WARM, or COOL.
6. Press twice to exit menus.

## Auto Color

To automatically optimize color adjustment to compensate for signal variations.

1. Press .
2. Press or and or to highlight the Picture Icon.
3. Press to display the Picture Adjustment Menu.

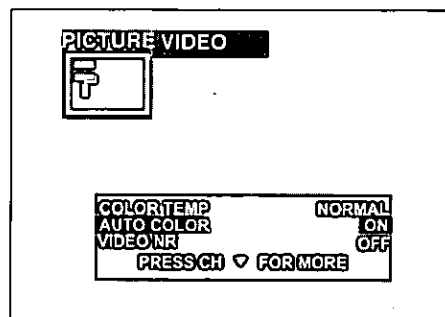

4. Press or to highlight AUTO COLOR.
5. Press or to select ON or OFF.
6. Press twice to exit menus.

### Video NR

This feature increases the horizontal resolution in the picture.

1. Press .
2. Press or and or to highlight the Picture Icon.
3. Press to display the Picture Adjustment menu.

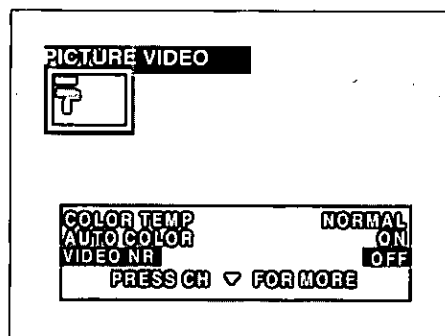

4. Press or to highlight VIDEO NR (Noise Reduction).
5. Press or to select ON or OFF.
6. Press twice to exit menus.

# Audio Adjustments

## Helpful Hints:

Setting TV mode Audio Adjustments will also change PC Mode and DTV mode Audio Adjustment.

## Audio Norm

This feature is used to reset Bass, Treble and Balance back to a factory preset level.

1. Press **ACTION**.
2. Press **CH** or **CH** and **VOL** or **VOL** to highlight the Audio Icon.
3. Press **ACTION** to display the Audio Adjustment Menu.

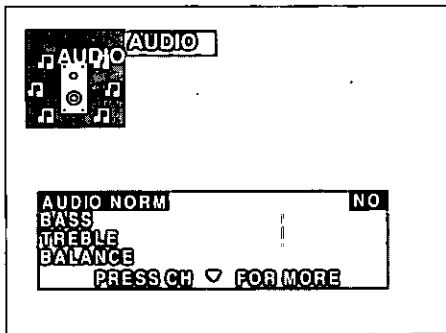

4. Press **CH** or **CH** to highlight AUDIO NORM.
5. Press **VOL** or **VOL** to select "YES" to Normalize Bass, Treble and Balance.
6. Press **ACTION** twice to exit Menus.

## Bass, Treble & Balance

### Helpful Hints:

**BASS** - To increase or decrease the Bass response.  
**TREBLE** - To increase or decrease the Treble response.  
**BALANCE** - To emphasize the Right and Left Speaker's volume.

1. Press **ACTION**.
2. Press **CH** or **CH** and **VOL** or **VOL** to highlight the Audio Icon.
3. Press **ACTION** to display the Audio Adjustment Menu.

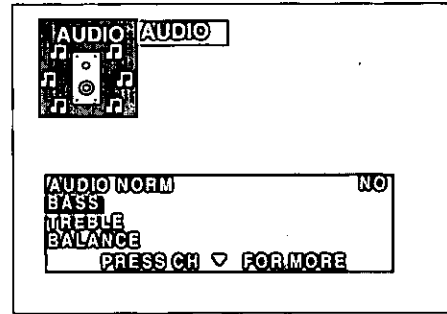

4. Press **CH** or **CH** to highlight BASS, TREBLE or BALANCE.
5. Press **VOL** or **VOL** to adjust for desired audio response.
6. Repeat steps 4 and 5 for remaining audio functions.
7. Press the **ACTION** twice to exit menus.

## Mode – Stereo/SAP/Mono

When Audio is broadcast in Stereo or SAP an ON Screen display will appear on initial "Turn On" and "Channel Change". The available choices will be indicated in red.

### Helpful Hints:

**STEREO** - Two channel audio reception.  
**SAP** - Second Audio Programming (such as bilingual audio, weather reports, etc.).  
**MONO** - Use when stereo signal is weak.

1. Press **ACTION**.
2. Press **CH** or **CH** and **VOL** or **VOL** to highlight the Audio Icon.
3. Press the **ACTION** to display the Audio Adjustment Menu.

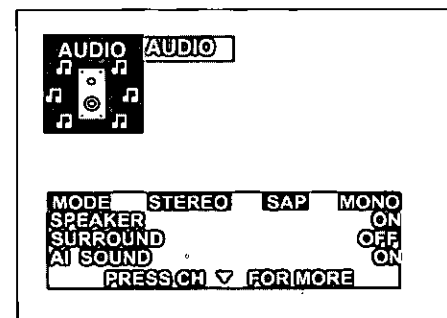

4. Press **CH** or **CH** to highlight MODE.
5. Press **VOL** or **VOL** to select STEREO, SAP (Second Audio Programming) or MONO. The selected mode will be highlighted.
6. Press **ACTION** twice to exit menus.

# Audio Adjustments (cont'd.)

## Speaker

This feature is used to turn the internal speakers "ON" or "OFF". It is used when the TV is connected to an external audio amplifier. (Refer to "To Audio Amp" connection section for further information.)

1. Press **(ACTION)**.
2. Press **CH** or **CH** and **VOL** or **VOL** to select the Audio Icon.
3. Press **(ACTION)** to display the audio Adjustment Menu.

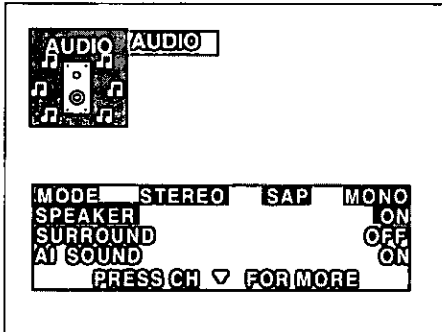

4. Press **CH** or **CH** to highlight SPEAKER.
5. Press **VOL** or **VOL** to select ON, OFF&VAO or OFF&FAO.
  - ON-TV speakers operate normally.
  - OFF&VAO (Variable Audio Output) – TV speakers off, the sound output varies according to the TV volume, use the TV remote to control the volume, muting, bass, treble, and balance of the external stereo system.
  - OFF&FAO (Fixed Audio Output) – TV speakers off, sound output is fixed.
6. Press **(ACTION)** twice to exit menus.

## Surround

Use the Surround Feature to enhance audio response when listening to Stereo broadcasts.

1. Press **(ACTION)**.
2. Press **CH** or **CH** and **VOL** or **VOL** to highlight the Audio Icon.
3. Press **(ACTION)** to display the Audio Adjustment Menu.

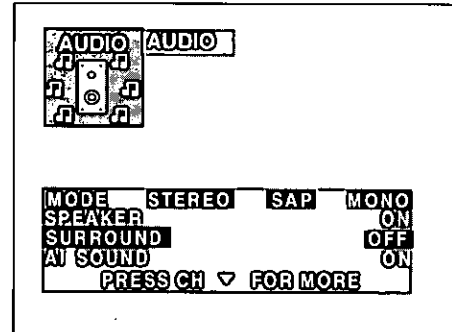

4. Press **CH** or **CH** to highlight SURROUND.
5. Press **VOL** or **VOL** to select SURROUND ON or OFF.
6. Press **(ACTION)** twice to exit menus.

## AI Sound

This feature is used to maintain constant sound level when switching between programs with different sound levels. For example, when the broadcast program switches to a commercial, the commercial sound level will be maintained close to the level of the broadcast program.

1. Press **(ACTION)**.
2. Press **CH** or **CH** and **VOL** or **VOL** to highlight the Audio Icon.
3. Press **(ACTION)** to display the Audio Adjustment Menu.

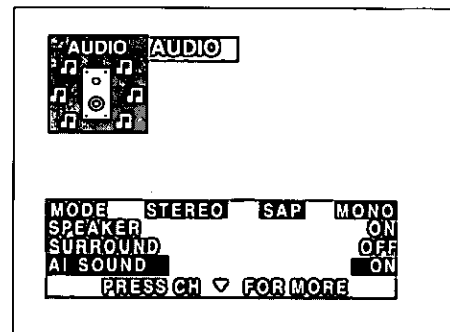

4. Press **CH** or **CH** to highlight AI SOUND.
5. Press **VOL** or **VOL** to select AI SOUND ON or OFF.
6. Press **(ACTION)** twice to exit menus.

# TV/PC/DTV

## Helpful Hints:

**TV** - Television mode  
**PC** - Computer mode  
**DTV** - Digital television mode

1. Press **[ACTION]**.
2. Press **[CH]** or **[CH]** and **[VOL]** or **[VOL]** to select the TV/PC/DTV Icon.
3. Press **[ACTION]** to display the TV/PC/DTV mode menu.

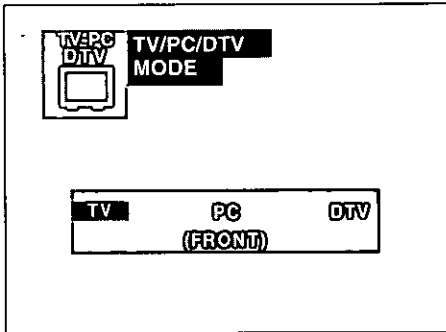

4. Press **[VOL]** or **[VOL]** to highlight TV, PC (Front or Rear), or DTV.

**NOTE:** Press Input button while in PC mode to select PC Front or Rear.

5. Press **[ACTION]** twice to exit menus.

# Set Up Features

## Clock Auto (TV Mode)

This feature automatically adjusts the TV clock to the correct time whenever the TV is tuned to a PBS (Public Broadcasting Service) station for 10 minutes or until the correct time and day are displayed (Refer to your local TV guide for PBS channel number).

**NOTE:** A plus or minus one-hour offset can be programmed to adjust the clock when there is a time zone difference between the PBS TV station and the viewer.

1. Press **[ACTION]**.
2. Press **[CH]** or **[CH]** and **[VOL]** or **[VOL]** to highlight the Set Up Icon.
3. Press **[ACTION]** to display the Set Up menu.

**NOTE:** This menu is not available when **AUTO POWER ON** is set.

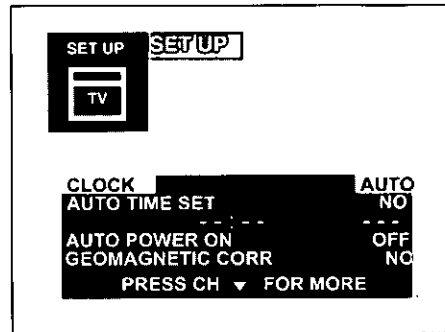

4. Press **[CH]** or **[CH]** to highlight CLOCK.
5. Press **[VOL]** or **[VOL]** to select AUTO (if necessary).
6. Press **[ACTION]** to highlight AUTO TIME SET.

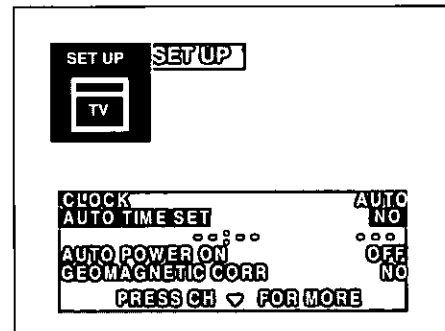

7. Press **[VOL]** or **[VOL]** to display the AUTO TIME SET Menu.
8. Press **[CH]** to highlight PBS CHANNEL.

# Set up Features (cont'd.)

## Clock Auto (cont'd)

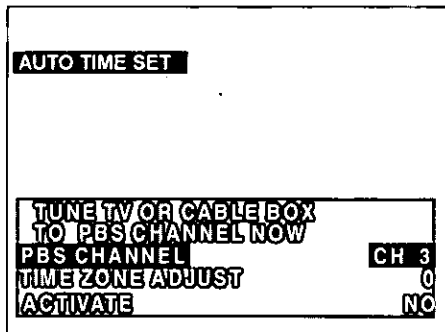

9. Tune TV or Cable Box to PBS channel, using the Remote Control Keypad to enter PBS channel number.
10. Press to highlight TIME ZONE ADJUST.

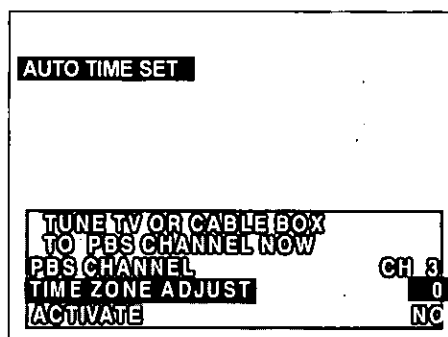

11. Press for minus one-hour offset or for plus one-hour offset (if necessary).
12. Press to highlight ACTIVATE.

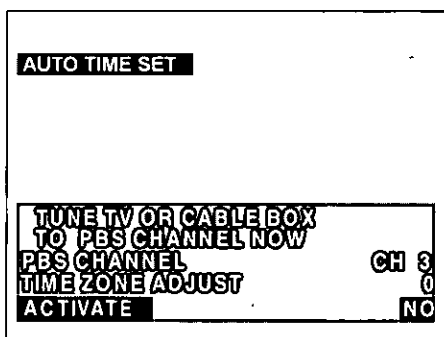

13. Press or to display the AUTO TIME SET ACTIVATE Menu.

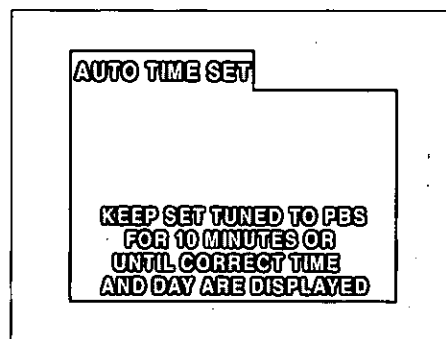

WAITING FOR CORRECT TIME AND DAY

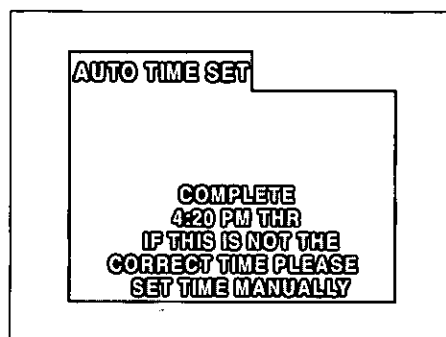

COMPLETED READ MENU

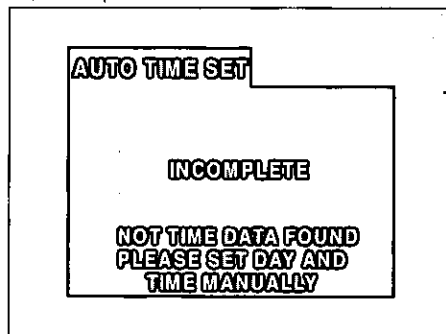

INCOMPLETED READ MENU

14. Press four times to exit menus.

# Set Up Features (Cont'd.)

## Clock Manual

Clock (when set) will display On Screen at initial turn on, after a channel change and when pressing **RECALL**. It must be set in order to operate the dual Timer feature.

1. Press **ACTION**.
2. Press **CH** or **CH** and **VOL** or **VOL** to highlight the Set Up Icon.
3. Press **ACTION** to display the Set Up menu.

**NOTE:** This menu is not available when **AUTO POWER ON** is set.

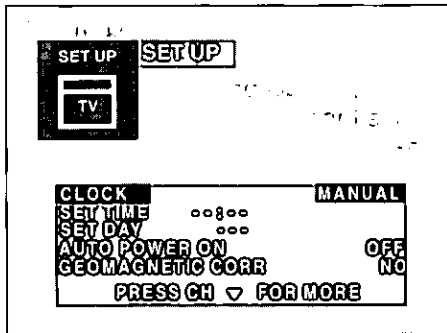

4. Press **CH** or **CH** to highlight **CLOCK**.
5. Press **VOL** or **VOL** to select **MANUAL**.
6. Press **CH** or **CH** to highlight **SET TIME**.

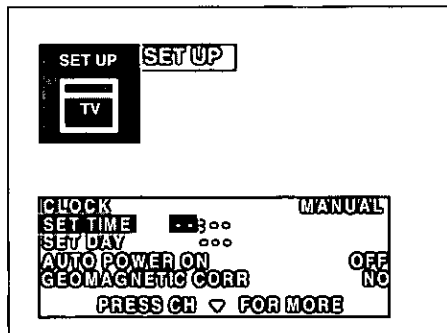

7. Press **VOL** or **VOL** to Set Hours (set AM/PM accordingly).
8. Press **CH** to highlight minutes position.
9. Press **VOL** or **VOL** to set minutes.
10. Press **ACTION** twice to exit menus.

## Set Day

The day of the week must be set in order to operate the Dual Timer feature.

1. Press **ACTION**.
2. Press **CH** or **CH** and **VOL** or **VOL** to highlight the Set Up Icon.
3. Press **ACTION** to display the Set Up menu.

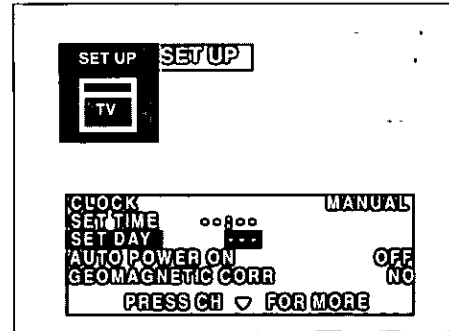

4. Press **CH** or **CH** to highlight **SET DAY**.
5. Press **VOL** or **VOL** to select proper day of the week.
6. Press **ACTION** twice to exit Menus.

## Auto Power On

Automatically turns the television on when a VCR, Cable Box, etc., are powered. The monitor needs to be plugged into the switched outlet of the device. Setting the Auto Power On feature will cancel the time and timer control settings. The Main Menu Icon for the **TIMER CONTROL** will be replaced with an **EXIT** Icon.

1. Press **ACTION**.
2. Press **CH** or **CH** and **VOL** or **VOL** to highlight the Set Up Icon.
3. Press **ACTION** to display the Set Up menu.

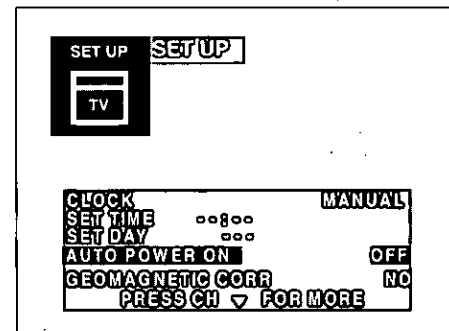

4. Press **CH** or **CH** to highlight **AUTO POWER ON**.
5. Press **VOL** or **VOL** to select **SET**.
6. Press **ACTION** twice to exit menus.

# Set Up Features (cont'd.)

## Geomagnetic Corr (Correction)

This monitor incorporates a special adjustment feature for the convenience of the customer. This adjustment is present at the factory. However, adjustment may be required when the monitor is moved (due to the influence of earth's magnetic field) which may cause the picture to tilt slightly. If necessary, follow these procedures to adjust the tilt.

1. Press **(ACTION)**.
2. Press **CH** or **CH** and **VOL** or **VOL** to highlight the Set Up Icon.
3. Press **(ACTION)** to display the Set Up menu.

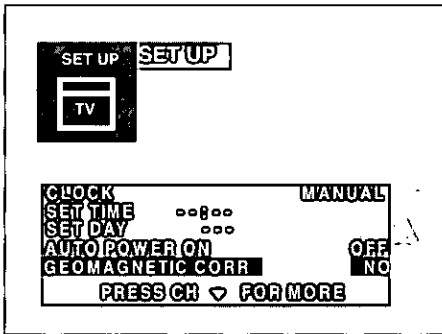

4. Press **CH** or **CH** to highlight GEOMAGNETIC CORR.
5. Press **VOL** or **VOL** to display the Geomagnetic Correction adjustment menu.
6. Press **CH** or **CH** to adjust the picture tilt until left and right side of tilt adjustment bar is parallel to the bottom of picture frame (if necessary).

**NOTE: Discoloration may be visible in picture corners if tilt bar is not parallel to the bottom of picture frame.**

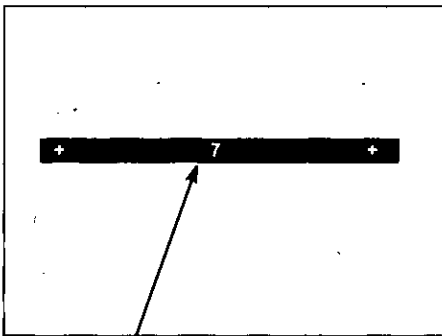

tilt adjustment bar

7. Press **(ACTION)** twice to exit menus.

## Mode

**IMPORTANT NOTE: The proper input mode must be selected for the type of signal at the antenna input.**

- TV is used when the television is not connected to a Cable TV System, for example, when using a VHF/UHF antenna (Channels 02-69).
- CABLE is used when the television is connected to a Cable TV System and when not using a Cable Box (Channels 01-125).

**NOTE: Some Cable TV Systems encode (scramble) program material on specific channels. A cable company supplied decoder is required to reproduce an acceptable picture. Certain Cable TV Systems offset some channels to reduce interference. It will be necessary to use the cable company supplied converter to receive these specific channels:**

1. Press **(ACTION)**.
2. Press **CH** or **CH** and **VOL** or **VOL** to highlight the Set Up Icon.
3. Press **(ACTION)** to display the Set Up menu.

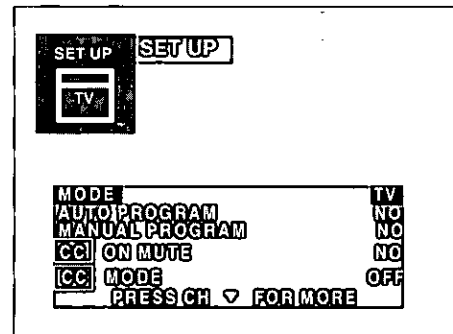

4. Press **CH** or **CH** to highlight MODE.
5. Press **VOL** or **VOL** to select TV or CABLE.
6. Press **(ACTION)** twice to exit menus.



# Set Up Features (cont'd.)

## Auto Program

The Auto Programming feature allows you to place channels with a video signal into Channel Scan Memory. When you press or , only those channels with a video signal will be accessed. TV or Cable Tuning mode must be set properly for your system.

### Helpful Hints:

#### After Auto Programming:

Blue channel number indicates channel is in Channel Scan Memory.

All channels are available by direct access using the Keypad numbers "0 through 9".

After Auto Programming Scan has completed, up to 15 channels will be programmed into the FAVORITE Channel Scan if space is available. Any original channels that were programmed into FAVORITE CHANNEL will remain. (Refer to Favorite Channel Scan for deleting unwanted channels.)

1. Press .
2. Press or and or to highlight the Set Up Icon.
3. Press to display the Set Up menu.

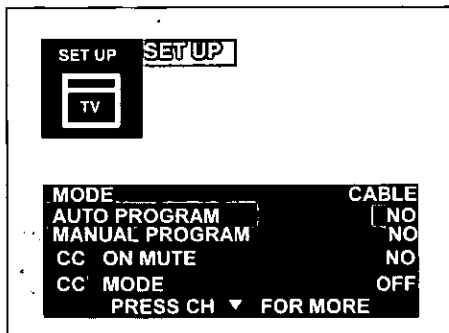

4. Press or to highlight AUTO PROGRAM.
5. Press or to start Auto Programming Scan. Channels will automatically advance until all channels have been scanned.
6. Channel numbers with video signal present will turn blue which indicates stored in Channel Scan Memory.
7. Press twice to exit menus.

**NOTE:** Some channels with very weak signals may be locked into memory. These must be deleted manually using the Manual Program feature.

## Manual Program

This feature allows you to select which channels are placed into Channel Scan Memory so when you press or only those channels you desire will be accessed.

1. Press the .
2. Press or and or to highlight the Set Up Icon.
3. Press to display the Set Up menu.

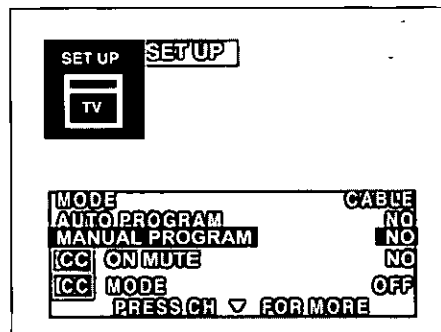

4. Press or to highlight MANUAL PROGRAM.
5. Press or to display Manual Programming Menu.

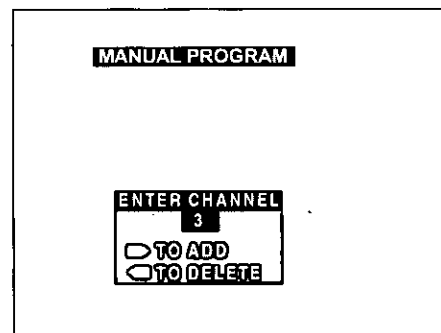

6. Use the Remote Control Keypad numbers "0 through 9" or or to select channels.
7. Press to add channel(s) to memory (blue). Press the to delete channel(s) from memory (yellow).
8. Repeat Steps 6 and 7 to continue adding or deleting channels.
9. Press twice to exit menus.

# Set Up Features (cont'd.)

## CC On Mute

Activates the On Screen Closed Caption feature when the **MUTE** on the Remote Control is pressed. To deactivate press **MUTE** again.

**NOTE:** This feature only functions when the Close Caption Mode is in the "OFF" position. The program being viewed must be broadcast with Closed Caption. (Refer to your local TV guide).

1. Press **ACTION**.
2. Press **CH** or **CH** and **VOL** or **VOL** to highlight the Set UP Icon.
3. Press **ACTION** to display the Set Up menu.

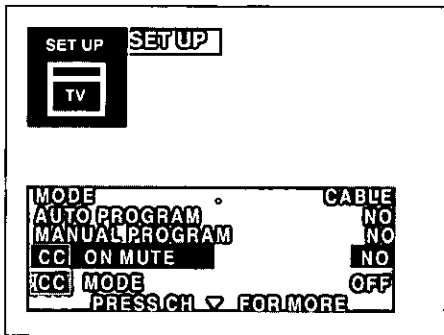

4. Press **CH** or **CH** to highlight CC ON MUTE.
5. Press **VOL** or **VOL** to select NO, C1, C2, C3 or C4. Recommended Set Up for Closed Caption when using **MUTE**.
  - CC ON MUTE: C1
  - CC MODE: OFF
6. Press **ACTION** twice to exit menus.
7. Press **MUTE** when program being viewed is broadcast with Closed Caption to activate.

**NOTE:** Press **MUTE** again to deactivate.

## CC Mode

This television contains a built in decoder that is capable of providing a visual depiction of the audio portion. The program viewed must include Closed Captioning (CC) for the television to display it. CC is displayed in the form of text across the screen (white or colored letters on a black background). It allows the viewer to read the dialogue of a television program or other information.

1. Press **ACTION**.
2. Press **CH** or **CH** and **VOL** or **VOL** to highlight the Set Up Icon.
3. Press **ACTION** to display the Set Up menu.

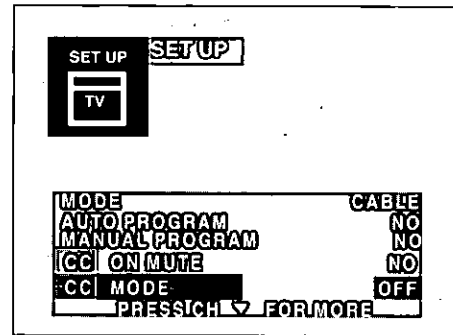

4. Press **CH** or **CH** to highlight CC MODE.
5. Press **VOL** or **VOL** to select OFF, C1, C2, T1, T2, C3, C4, T3 or T4.
  - CAPTION OFF – Use when Closed Caption is not desired.
  - CAPTION C1 – For video related information that can be displayed (up to 4 lines of script on the screen, where it does not obstruct relevant parts of the picture). Script can be in any language.
  - CAPTION C2 – Another mode used for video related information.
  - CAPTION C3 and C4 – Other modes used for video related information.
  - TEXT T1 – Blanks out large portion of the picture on the television screen, and displays program guide or any other information currently being transmitted.
  - TEXT T2, T3 & T4 – Other modes that display information and blank out a large portion of the picture on the television screen.
6. Press **ACTION** twice to exit menus.

# Timer Features

## Sleep Timer

This feature is used for automatic turn OFF in 30, 60 or 90 minutes as desired.

**NOTE:** Display will be flash 3, 2 and 1 to indicate the last three remaining minutes prior to turn OFF.

To deactivate, press or until "NO" is displayed.

1. Press
2. Press or and or to highlight the Timer Icon.
3. Press button to display the Timer Control menu.

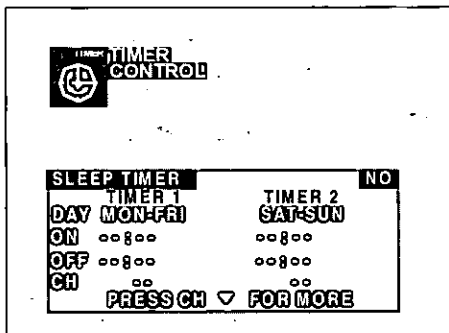

4. Press or to select 30, 60 or 90 (minutes) for Sleep Timer to be activated.
5. Press twice to exit menus.

**NOTE:** To deactivate Sleep Timer, repeat steps 1 through 4. In step 4, select "NO" instead of minutes. Timer Control is not available when Audio Power On is set.

### Special Feature:

**Automatic turn "OFF" after 90 minutes.**

The TV has a special feature that will shut itself **OFF** after 90 minutes when turned **ON** by the program timer unless a function key is pressed during the 90 minutes.

This feature is used to insure that the TV will not remain **ON** unattended for an extended period of time.

Programming the **OFF** timer will also cancel the automatic **OFF** feature.

## Program Timer

The (Dual Program) Timer feature is capable of turning the TV ON to a desired channel and then turning the television OFF at a predetermined time.

**NOTE:** The clock and day must be set for this feature to operate. (Refer to Set Up Menu to Set Time and Day.)

### Helpful Hints:

- The Program Timer overrides the Sleep Timer.
- Program Timer can only access channels in Program Channel Memory.
- "Set Time First" will appear on screen when trying to set Timer Day Option without the clock being set.
- If the Program Timer "ON" functions while the set is operating the set will automatically tune to the channel designated in the Program Timer.

1. Press
2. Press or and or to highlight the Timer Icon.
3. Press to display the Timer Control menu.

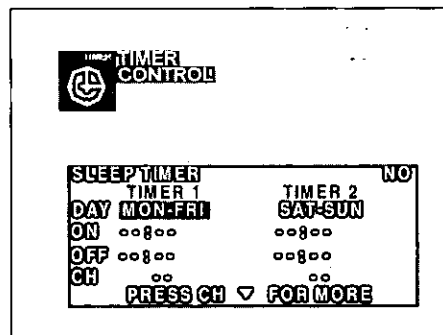

4. Press or to highlight TIMER 1 or TIMER 2 setting.
  - Day or days to activate the Timer.
  - ON (time) - hours and minutes
  - OFF (time) - hours and minutes
  - CH - the channel the TV is tuned to when the ON Timer activates.
  - SET - NO (Timer feature will not activate)
  - - YES (Timer feature will activate)

## Timer Features (cont'd.)

### Program Timer (cont'd.)

- Highlight the Timer 1 Day/Days option.
- Press or to set the day or days for the TV to turn ON.

The options for setting day are: (MON-FRI), (SAT-SUN), (DAILY), (SUN), (MON), (TUE), (WED), (THR), (FRI), (SAT), (EVR SUN), (EVR MON), (EVR TUE), (EVR WED), (EVR THR), (EVR FRI), (EVR SAT).

- Press to highlight the ON (Hours/Minutes).
- Press or to set the time for the TV to turn ON.
- Press to highlight the OFF (Hours/Minutes).
- Press or to set the time for the TV to turn OFF.
- Press to highlight CH.
- Press or to select a channel (from Program Channel Memory) for the TV to be tuned to when it turns ON.
- Press to highlight SET.

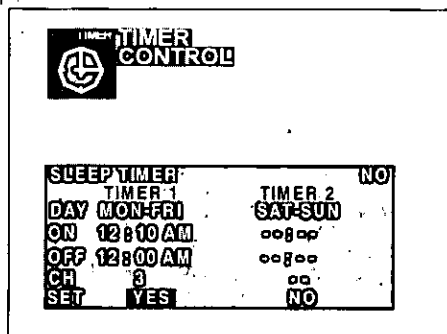

- Press to activate or to deactivate Timer 1.
  - YES=Feature is activated
  - NO=Feature is not activated
- Press to set Timer 2 (if desired). Follow Steps 6 through 14.
- Press twice to exit menus.
- Pressing again will return you to the Timer icon.

## Input Select

- Press .
- Press or and or to highlight the Input Select Icon.
- Press to display the Input Select menu.

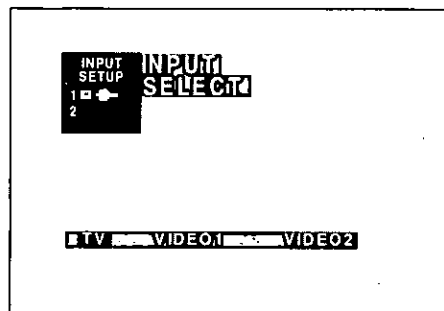

- Press or to select TV, Video 1 or Video 2.
- Press twice to exit menus.

## Favorite Channel

### Channel Scan

This feature is used to select which Channels will be accessed when using or , ALL or FAV (Favorite) Channels.

**NOTE:** Channels must be programmed into Favorite Channel Select Memory first.

- Press .
- Press or and or to highlight the Favorite Channel Icon.
- Press to display the Favorite Channel menu.

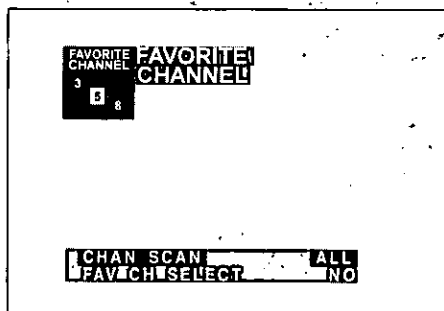

- Press or to highlight CHAN SCAN.
- Press or to select ALL or FAV (Favorite).
  - ALL - The or will access all channels in Channel Memory.
  - FAV - The or will only access channels in Favorite Channel Select Memory.
- Press twice to exit menus.

## Favorite Channel (cont'd.)

### Favorite Channel Select

The favorite Channel Programming allows you to program up to 15 of your favorite channels. You can use the CH buttons on the Remote Control to scan channels without going through channels you do not normally view.

1. Press **(ACTION)**.
2. Press **CH** or **CH** and **VOL** or **VOL** to highlight the Favorite Channel Icon.
3. Press **(ACTION)** to display the Favorite Channel menu.

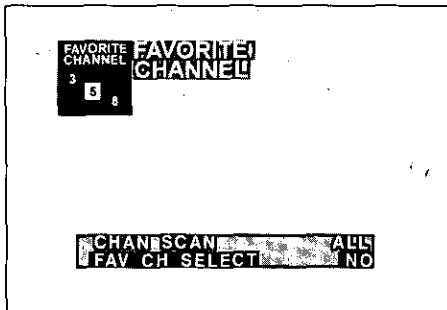

4. Press **CH** or **CH** to highlight CHAN SCAN. Then, press **VOL** or **VOL** to select FAV option for Favorite Channels setting.
5. Press **CH** or **CH** to highlight "FAV CH SELECT".
6. Press **VOL** or **VOL** to display the Favorite Channel Select.

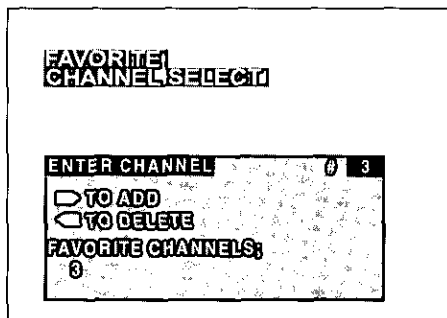

7. Enter the channel number you wish to add or delete from Favorite Channel Memory (using the Remote Keypad or **CH** or **CH**).
8. Press **VOL** to add or press **VOL** to delete channel from Favorite Channel Memory.
9. Repeat steps 7 and 8 to add or delete channels (up to 15 channels may be stored in Favorite Channel Memory).
10. When you are done with adding and deleting channel, press **(ACTION)** twice to return to normal viewing.
11. Press **CH** or **CH** to scan through the Favorite Channels you programmed.

## Channel Caption

### Preset Caption

This feature allows you to select from 56 preset captions, and assign corresponding channel numbers utilized in your area. Captions are easily assigned to the channel numbers you select by following the steps outlined below.

1. Press **(ACTION)**.
2. Press **CH** or **CH** and **VOL** or **VOL** to highlight the Channel Caption Icon.
3. Press **(ACTION)** to display the Channel Caption menu.

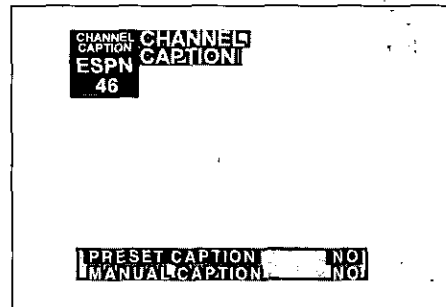

4. Press **CH** or **CH** to highlight PRESET CAPTION.
5. Press **VOL** or **VOL** to display the Preset Caption menu.

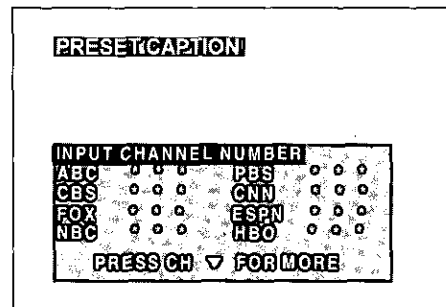

6. Use the Remote Control keypad, to assign the channel number to the Channel Caption in your area (Refer to your local TV guide).

**NOTE:** To delete press **VOL** while channel number is highlighted.

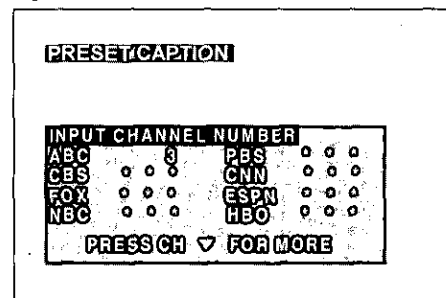

7. Press **CH** to select a different Preset Caption, then repeat step 6 until all desired Preset Captions have assigned channel numbers.
8. Press **(ACTION)** three times to exit menus.

# Channel Caption (cont'd.)

## Manual Caption

The Channel Caption (Station Identifier) allows you to input the call names of up to 30 stations into memory (using up to 4 characters). The call name will then display, along with the channel number when changing channels or pressing (RECALL).

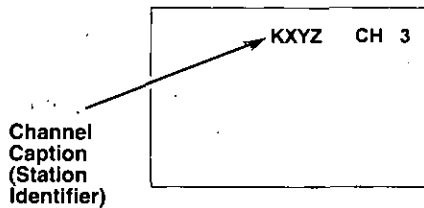

1. Press **(ACTION)**.
2. Press **CH** or **CH** and **VOL** or **VOL** to highlight the Channel Caption Icon.
3. Press **(ACTION)** to display the Channel Caption menu.

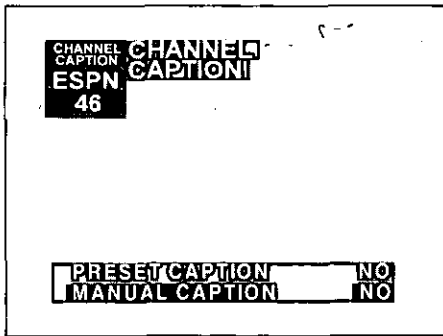

4. Press **CH** to highlight MANUAL CAPTION.
5. Press **VOL** or **VOL** to display the Manual Caption menu.

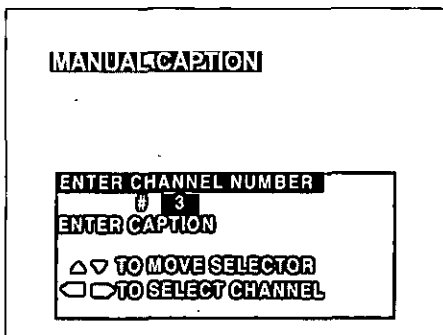

6. Use the Remote Control Keypad or **VOL** or **VOL** to enter channel number you wish to assign a channel caption (STATION IDENTIFIER).
7. Press **CH** to highlight ENTER CAPTION.

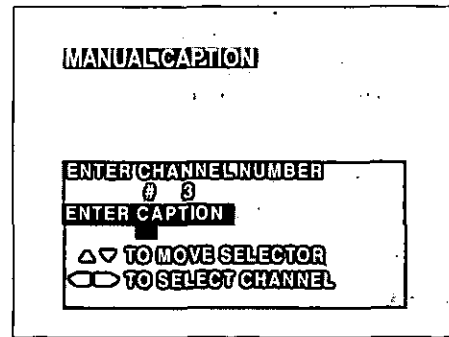

8. Press **VOL** or **VOL** to select first character in channel caption (STATION IDENTIFIER).

**NOTE:** To delete characters, press **VOL** or **VOL** until an empty space is displayed and the character position.

9. Press **CH** to move to second character position, and repeat steps 8 and 9 until the complete caption is entered (up to 4 characters).
10. Press **CH** or **CH** repeatedly to highlight ENTER CHANNEL NUMBER. Then repeat steps 6 through 10 to continue adding Channel Captions (STATION IDENTIFIERS).
11. Press **(ACTION)** three times to exit menus.

# Lockout Features

## Lockout Mode

This feature allows locking out the following from viewing:

- Game - Lockout Channel 3 & 4, VGA & Video Inputs.
- Channel - Lockout up to 4 Channels.
- All - Lockout All Channels plus Video Inputs.

**NOTE:** This feature will Lockout your selection for up to 48 hours. Be sure to understand this feature before using. Use a code that you will easily remember.

1. Press **(ACTION)**.
2. Press **(CH)** or **(VOLUME DOWN)** and **(VOLUME UP)** to highlight the Lock Icon.
3. Press **(ACTION)** to display the Lock menu.

**NOTE:** When the Lockout Menu is displayed, the Game Lock option will be highlighted.

4. Press **(VOLUME DOWN)** or **(VOLUME UP)** to select GAME, CH (CHANNEL) or ALL.

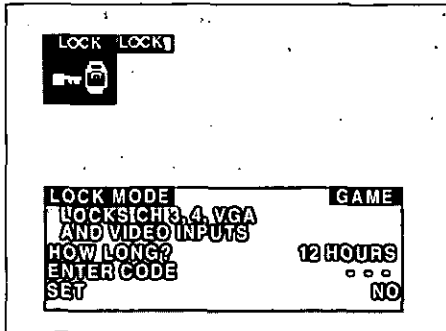

Game Lockout Menu

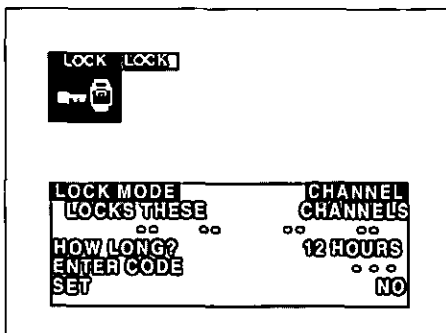

Channels Lockout Menu

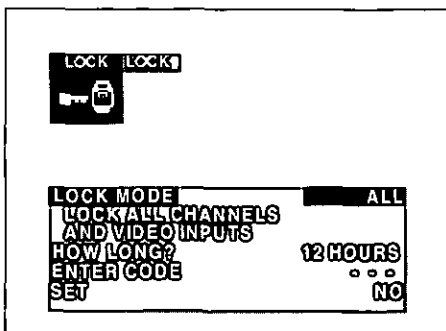

All Lockout Menu

**NOTE:** When the LOCK MODE CHANNEL is selected, perform procedure Steps A through D.

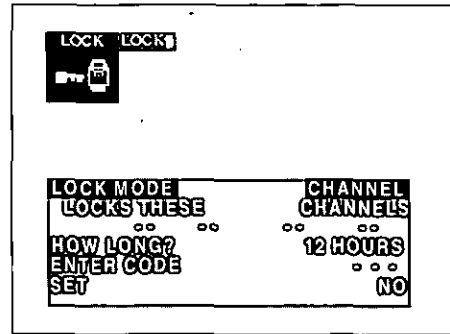

### Step A

Press **(CH)** to highlight "LOCK THESE CHANNELS".

### Step B

Then use the Remote Control Keypad or **(VOLUME DOWN)** or **(VOLUME UP)** to select a channel you desire to lockout.

### Step C

Press **(CH)** to select next channel position.

### Step D

Then repeat Step B & C until desired Channels are locked out (up to 4 channels).

5. Press **(CH)** to highlight "HOW LONG?".
6. Press **(VOLUME DOWN)** or **(VOLUME UP)** to select 12, 24 or 48 (hours lockout time).
7. Press **(CH)** to highlight "ENTER CODE" then enter a 3 digit code by using the Remote Control Keypad. **IMPORTANT NOTE: Use a code you can easily remember.**
8. Press **(VOLUME UP)** to activated "CHANNELS LOCKED" will display on screen.



Lock Feature Activated

# Lockout Features (cont'd.)

## Unlock

Follow Steps 1 through 3 from previous section and enter same 3 digit code as in Step 7. Channel Unlocked display will appear.

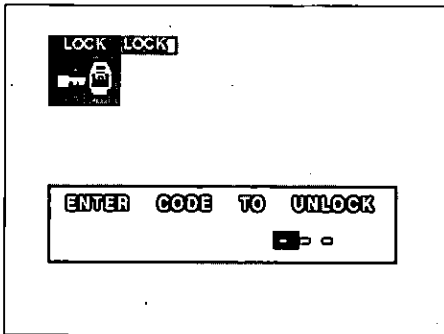

**ENTER SAME 3 DIGIT CODE**

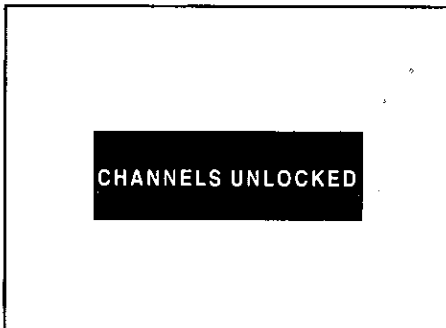

**IF 3 DIGIT CODE IS THE SAME**

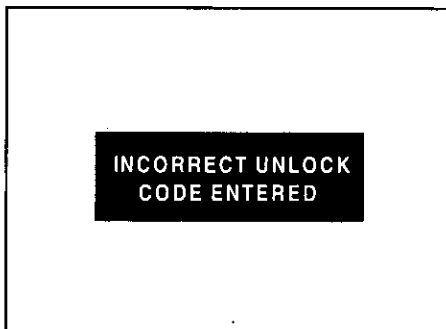

**IF 3 DIGIT CODE IS NOT THE SAME**

## CONTROL PANEL LOCK FEATURE

### Procedure

With the Monitor turned ON, press the  and VOLUME RIGHT (▶) buttons on the control panel

simultaneously, then quickly press the  and CHANNEL UP (▲) buttons on the control panel simultaneously. This will activate the Control Panel Lock feature, to deactivate repeat procedure.

### Helpful Hints:

- There will be no On Screen display.
- To confirm if the Control Panel Lock feature is activated, press any button other than the POWER button (the Power button is never disabled).
- Buttons should be pressed quickly and released. Do not hold down.

TV MODE



# Programming the Home Theater Remote

The remote control can be set to control other manufacturers components, by utilizing the **MODE SELECTION BUTTONS** for **CABLE**, **DSS**, **VCR**, **RCVR** (a Receiver or Amplifier), **CD**, **LD**, and **AUX** (for **Cassette Players**, **Second VCR** or a **DVD**).

TV MODE

## Code Known

Use the following procedure for setting up the remote control using the numerical buttons when the component's remote code is known.

- 1 Determine the brand of the component.
- 2 Identify the code(s) associated with the brand from the infrared code index (see following pages). Record all possible codes.
- 3 Confirm that the component is plugged in and operating properly, then turn it OFF.
- 4 Press and hold the **(ACTION)** button, then the **(POWER)** button so that both are pressed at the same time for at least 5 seconds. Then let go of the buttons.
- 5 Press the appropriate **MODE** button for the component.
- 6 Enter the 3-digit-code, by using the Remote Control Keypad "0" through "9" buttons.

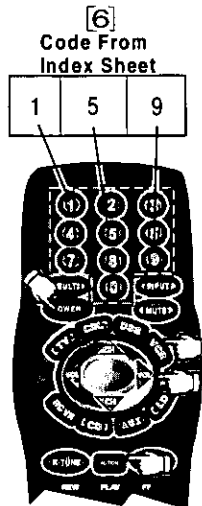

TNQ2AE012

Now the remote is set for the entered code.

- 7 Press the **(POWER)** button to test the remote. If the correct code is setup for the component (in step [6]), the component will turn on.

**Note:** Some brands have multiple codes. Repeat the procedure using another listed code until the component responds correctly.

## Code Unknown

Use the following procedure for setting up the remote control when the component's remote access code is not known. This procedure uses the "sequence method".

- 1 Confirm that the components is plugged in and operating properly, then turn it OFF.
- 2 Press and hold the **(ACTION)** button, then the **(POWER)** button so that both are pressed at the same time for at least 5 seconds. Then let go of the buttons.
- 3 Press the appropriate **Mode** button for the device.
- 4 Press the **(VOLUME UP)** button to step over to the next code.
- 5 Press the **(POWER)** button to test the remote. If the correct code is sent, the component will turn on.
- 6 Once the correct code is found, press the **(ACTION)** button to store the code.
- 7 Repeat from step 3 above until the proper components code is found. It may take several attempts before the correct code is found.

**Note:** If an incorrect code is entered, or when the operation is not completed within 30 seconds, the settings will not change.

## Infrared Remote Codes for Specific Components

**Helpful Hint:** Write down the code numbers for your components in the space provided below. This will serve as a handy reference whenever you need to reprogram your remote control.

<b>CABLE</b> Cable TV Converter Box	<input type="text"/>	<b>VCR</b> Video Cassette Recorder	<input type="text"/>	<b>CD</b> Compact Disc Player	<input type="text"/>
<b>DSS</b> Digital Satellite System	<input type="text"/>	<b>RCVR</b> Receiver or Amplifier	<input type="text"/>	<b>LD</b> Laser Disc Player	<input type="text"/>
Other Component	<input type="text"/>	Other Component	<input type="text"/>	Other Component	<input type="text"/>
Other Component	<input type="text"/>	Other Component	<input type="text"/>	Other Component	<input type="text"/>

# VCR Infrared Codes Index

The Universal Infrared Remote Control is capable of operating many brands of VCRs. Refer to the Programming the Remote Control section for procedures.

**NOTE:** The Universal Remote Control memory is limited; therefore, some models of VCRs may not operate. The Universal Remote Control not designed to control all features that are available in all models.

**NOTE:** After entering the proper infrared code, press the Remote **VCR(\*)** Selection Mode button. **A second VCR can be activated** using the same codes, from **AUX (\*\*)** Selection Mode button. Refer to the Remote Control Key Functions section for Remote VCR and VCR 2 function key listing.

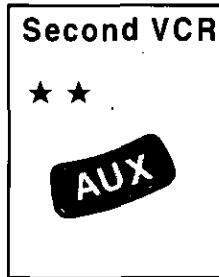
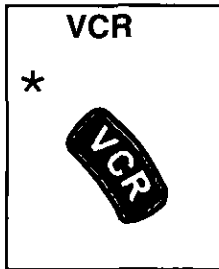

Code Index for VCRs			
VCR Brand	Code(s)	VCR Brand	Code(s)
Adventura	000	MTC	000,240
Aiko	278	Multitech	000,072
Aiwa	000	NEC	038,041,067
Akai	041,061	Nikko	037
American High	035	Noblex	240
Asha	240	Olympus	035
Audiovox	037	Optimus	037,048,104
Beaumarck	240	Panasonic	035,162,225,454
Bell & Howell	104	Penney	035,037,038,042
Broksonic	121,184		240
Calix	037	Pentax	042
Canon	035	Philco	035
Carver	081	Philips	035,081
CCE	072,278	Pilot	037
Citizen	037,278	Pioneer	067
Colt	072	Protec	072
Craig	037,047,072,240	Pulsar	039
Curtis Mathes	035,041,060	Quarter	046
Cybernex	240	Quartz	046
Daewoo	045,278	Quasar	035
Dynatech	000	Radio Shack	000,037
Electrohome	037	Radix	037
Electroponic	037	Randex	037
Emerex	032	RCA	042,060
Emerson	000,002,037,043, 061,121,184,278	Realistic	000,035,037,046 047,048,104,240
Fisher	047,104	Ricoh	034
Fuji	033,035	Runco	039
Funai	000	Samsung	045,240
Garrard	000	Sanky	039,048
GE	035,060	Sansui	041,067
Goldstar	037,038	Sanyo	046,047,104,240
Gradiente	000	Scott	043,045,121,184
Harley-Davidson	000	Sears	035,037,042,046, 047,104
Harman-Kardon	038		
Harwood	072	Sharp	048
Headquarter	046	Shintom	072
HI-Q	047	Shogun	240
Hitachi	041,042	Singer	072
Jensen	041	Sony	032,033,034,035
JVC	041,067	STS	042
Kenwood	038,041,067	Sylvania	000,035,043,081
KLH	072	Symphonic	000
Kodak	035,037	Tatung	041
Lloyd	000	Teac	000,041
Logik	072	Technics	035,162
LXI	037	Teknika	000,035,037
Magnavox	035,039,081	TMK	240
Magnin	240	Toshiba	043,045
Marantz	035,081	Totevision	037,240
Marta	037	Unitech	240
Matsushita	035	Vector	045
MEI	035	Vector Reseach	038
Memorex	000,035,037,039 046,047,048,104 240	Video Concepts	045,061
MGA	043,061	Videosonic	240
MGN	240	Wards	000,035,042,047 048,072,240
Minolta	042	XR-1000	000,035,072
Mitsubishi	043,061,067	Yamaha	038
Motorola	035,048	Zenith	033,034,039

# Cable Converter Box and CD Players

## Infrared Codes Index

The Universal Infrared Remote Control is capable of operating many brands of Cable Converter Boxes and CD Players. Refer to the Programming the Remote Control section for procedures.

**NOTE:** The Universal Remote Control memory is limited; therefore, some models of Cable Converter Boxes and CD Players may not operate. The Universal Remote Control is not designed to control all features that are available in all models.

**NOTE:** After entering the proper infrared code, press the Remote CBL Selection Mode button (☆). Refer to the Remote Control Key Functions section for Remote CBL function key listing.

TV MODE

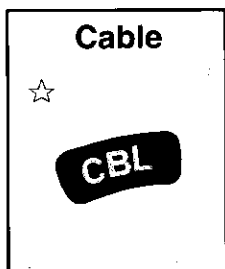

Codes for Cable Converter Box			
Brand of Cable-TVBox	Code(s)	Brand of Cable-TV Box	Code(s)
ABC	003,007,008,011 013,014,017	Pioneer	144,533
Archer	153	Pulsar	000
Century	153	RCA	021
Citizen	153	Regal	020,259
Contec	019	Rembrandt	011
Dae Ryung	008	Runco	000
Gerrard	153	Samsung	144
Gemini	015	Scientific Atlanta	008,017,477
General Instrument	011,476	Signal	015
Goldstar	144	Signature	011
Hamlin	009,020,259	Sprucer	021
Hitachi	011	Starcom	003,015
Hytex	007	Stargate	015
Jasco	153	Starquest	015
Jerold	003,011,012,014 015,476	Tocom	012,013
Memorex	000	Toshiba	000
Oak	007,019	Tusa	015
Panasonic	000,021,107	Unika	153
Paragon	000	United Artist	007
Philips	153	United Cable	003
		Universal	153
		Zenith	000,525

**NOTE:** After entering the proper infrared code, press the Remote CD Selection Mode button (☆☆). Refer to the Remote Control Key Functions section, for Remote CD Players function key listing.



Codes for CD Players			
Brand of CD Players	Code(s)	Brand of CD Players	Code(s)
Aiwa	124	Onkyo	101
CA Audio Lab	29	Optimus	000,032,037, 305,426,468
Carver 7	157	Panasonic	029,367
Denon	003	Philips	157
DKK	000	Pioneer	032,468
Emerson	305	Proton	157
Fisher	048	QED	157
Genexxa	032,305	Quasar	029
Harman-Kardon	426	RCA	305
Hitachi	032	Rotel	157
JVC	072	SAE	157
Kenwood	028,037,048,190	Sansui	157,305
Krell	157	Scott	305
LXI	305	Sears	305
Magnavox	157	Sharp	037
Marantz	029,157	Sherwood	426
MCS	029	Sony	000
Mission	157	Technics	029,303
Nakamichi	147	Victor	072
NSM	157		

# Cassette Players, Receivers, and Amplifiers Infrared Codes Index

The Universal Infrared Remote Control is capable of operating many brands of Cassette Players, Receivers, or Amplifiers. Refer to the programming the Remote Control section for procedures.

**NOTE:** The Universal Remote Control memory is limited; therefore, some models of Cassette Players, Receivers, and Amplifiers may not operate. The Universal Remote Control is not designed to control all features that are available in all models.

**NOTE:** After entering the proper infrared code, press the Remote **AUX** Selection Mode button (★). Refer to the Remote Control Key Functions section for Remote Cassette Players function key listing.

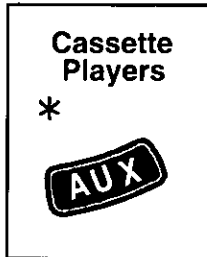

Code Index for Cassette Players			
Brand of Cassette Players	Code(s)	Brand of Cassette Players	Code(s)
Aiwa	029	Panasonic	272
Carver	029	Philips	029
Denon	076	Pioneer	027,220
Kenwood	070	Snsui	029
Magnavox	029	Sherwood	337,338
Marantz	029	Sony	170,243
Nakamichi	147	Technics	229
Optimus	027,220,337,338	Wards	027
		Yamaha	094,097

**NOTE:** After entering the proper infrared code, press the Remote **RCVR** Selection Mode button (★★). Refer to the Remote Control Key functions section for Remote Receivers/Amplifiers function key listing.



Code Index for Receivers and Amplifiers			
Brand of Receiver/ Amplifier	Code(s)	Brand of Receiver/ Amplifier	Code(s)
ADC	531	Panasonic	039
Aiwa	121,158,189	Pennay	195
Carver	008,042,189,269	Philips	189,269
Casio	195	Pioneer	013,014,080,300,531
Clarinette	195	Quasar	039
Denon	004	RCA	531
Fisher	042,219	Realistic	195
JVC	074	Sansui	189,321
Kenwood	027,186	Sanyo	219
Lloyd's	195	Sharp	186
Magnavox	189,195,269,531	Sherwood	502
Marantz	039,189,269,321	Sony	158
MCS	039	Technics	039,208,308,309,518
Modulaire	195	Victor	074
NAD	320	Wards	013,014,042,080,158,189
Nakamichi	321,347	Yamaha	176,186,354
Onkyo	135	Yorx	195
Optimus	013,080,186,219,300,531		

TV MODE

# Laser Disc, DSS (Digital Satellite System), and DVD (Digital Videodisc) Infrared Codes Index

The Universal Infrared Remote Control is capable of operating selected brands of Laser Disc, DSS Digital Satellite System, and DVD (Digital Videodisc). Refer to the Programming the Remote Control section for procedures.

**NOTE:** The Universal Remote Control memory is limited; therefore, some models of Laser Disc, DSS Digital Satellite System, and DVD (Digital Videodisc) may not operate. The Universal Remote Control is not designed to control all features that are available in all models.

**NOTE:** After entering the proper infrared code, press the Remote **LD** Selection Mode button (◊). Refer to the Remote Control Key Functions section for Remote Laser Disc function key listing.

TV MODE

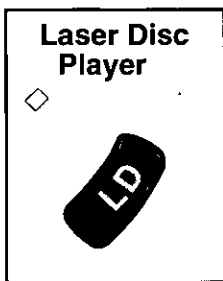

Codes for Laser Disc	
Brand of Laser Disc	Code(s)
Mitsubishi	059
NAD	059
Panasonic	204
Pioneer	059
Quasar	204
Sony	201

**NOTE:** After entering the proper infrared code, press the Remote **DSS** Selection Mode button (◊◊). Refer to the Remote Control Key Functions section for Remote DSS function key listing.

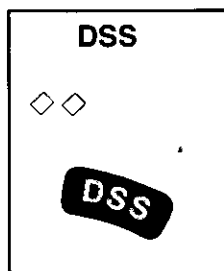

Codes for DSS (Digital Satellite System)	
Brand of Sattelite	Code(s)
Panasonic	701
RCA	566
Sony	639

**NOTE:** After entering the proper infrared code, press the Remote **AUX** Selection Mode button (★). Refer to the Remote Control Key Functions section for Remote DVD function key listing.

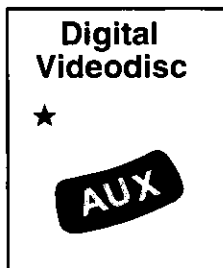

Codes for DVD (digital Videodisc)	
Brand of DVD	Code(s)
Panasonic	490

# PC Mode

## PC Input Connection (Rear)

### Operation

1. Select PC (Rear) mode from the TV/PC/DTV menu (located in the TV/PC/DTV Icon).

**NOTE:** To select PC (front) press the INPUT button, while PC (rear) is highlighted in the TV/PC/DTV menu.

2. Connect the 15-pin connector cable (the supplied cable meets FCC standards) from the computer 15-pin output terminal to the monitor PC INPUT 15-pin terminal, as shown.
3. Connect an audio/video to Mini-jack cable from the computer Audio output sound source jack to the monitor PC INPUT AUDIO L & R jacks, as shown.

**NOTE:** To operate your Monitor and computer properly, refer to the instructions furnished with the computer.

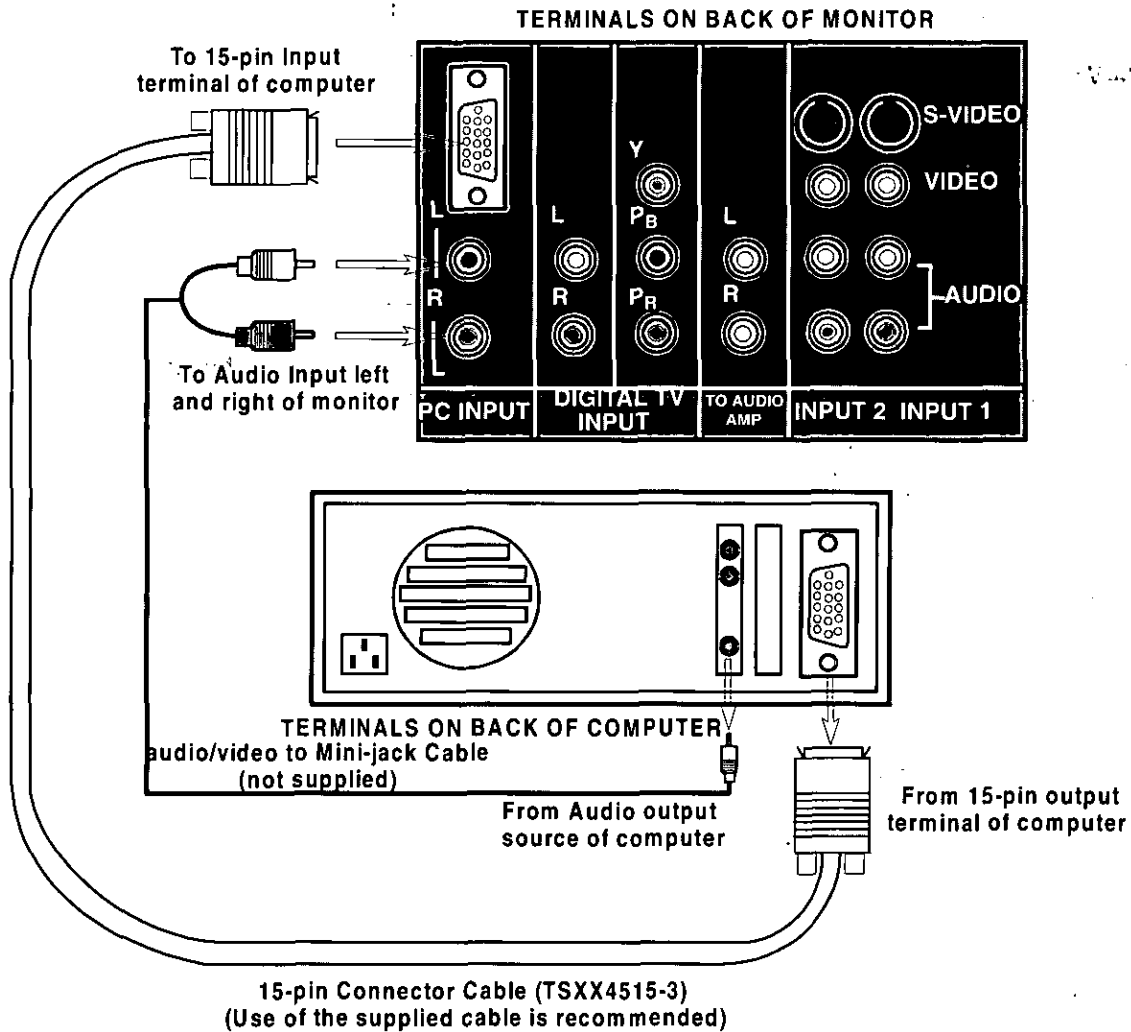

PC MODE

### Helpful Hints:

If the monitor image is scrambled after connecting to a computer, refer to the troubleshooting section for changing the computer resolution.

scrambled image



# PC Mode (cont'd.)

## PC Input Connections (Front)

### Operation

1. Select PC (Front) from the TV/PC/DTV menu (located in the TV/PC/DTV Icon).

**NOTE:** To select PC (Rear) press the INPUT button, while PC (Front) is highlighted in the TV/PC/DTV menu.

2. Connect a 15-pin Connector cable (**the supplied cable meets FCC standards**) from the computer 15-pin output terminal to the monitor PC INPUT 15-pin terminal, as shown.

3. Connect an Mini-jack cable from the computer Audio output sound source jack to the monitor AUDIO INPUT jack, as shown.

**NOTE:** To operate your Monitor and computer properly, refer to the instructions furnished with the computer.

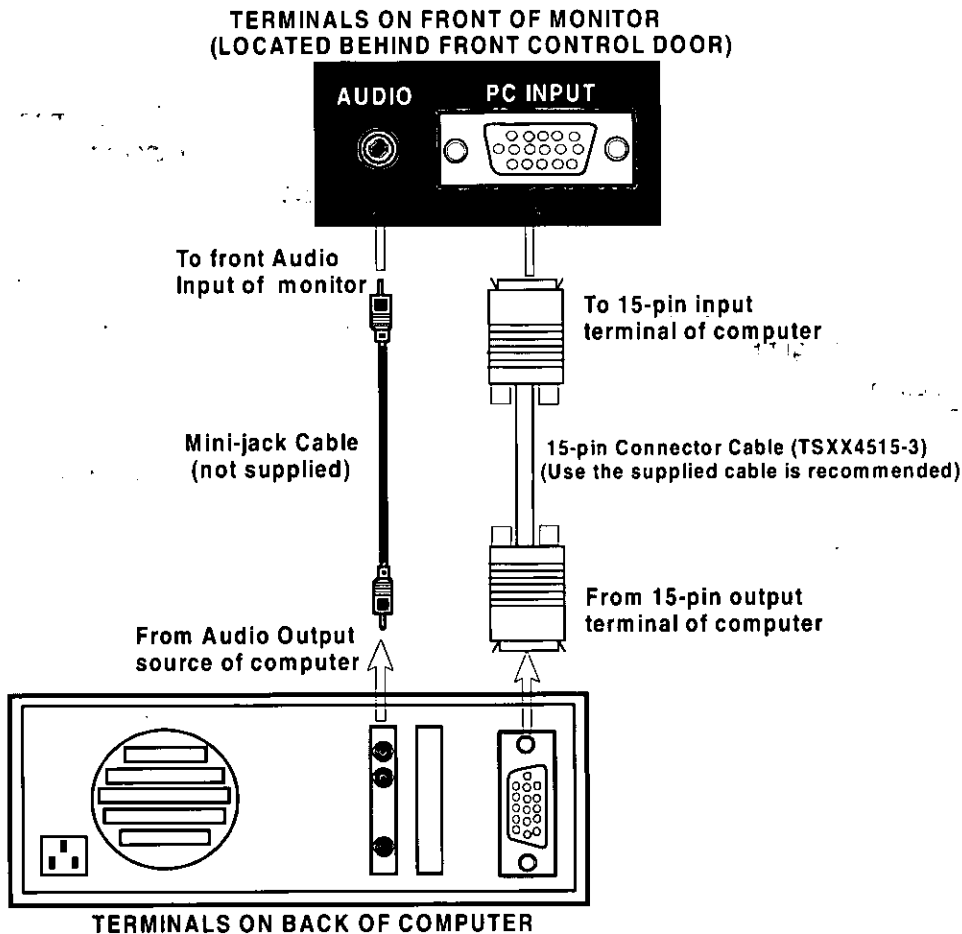

### Helpful Hints:

An Input signal must be connected to the input terminals of the monitor, in order to access PC and DTV mode Icon menus.

### Helpful Hints:

If the monitor image is scrambled after connecting to a computer, refer to the troubleshooting section for changing the computer resolution.

scrambled image



## TV/PC/DTV

This feature is used to select the PC mode for monitor display.

**NOTE:** Connect a computer having a 15-pin output terminal. If necessary, you can adjust the picture size and position using the Display Adjust menu.

1. Press **(ACTION)**.
2. Press **▲** or **▼** and **◀** or **▶** to highlight the TV/PC/DTV Icon.
3. Press **(ACTION)** to display the TV/PC/DTV MODE menu.

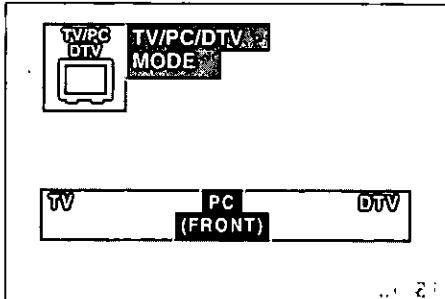

4. Press **◀** or **▶** to highlight PC (FRONT).
5. Press **(ACTION)** twice to exit menus.

### Helpful Hints:

When there is no signal applied, the Icon menus in the PC and DTV mode will appear small and distorted.

**This is a normal condition.**

## Trilingual Animated Icons

### PC Mode Icons

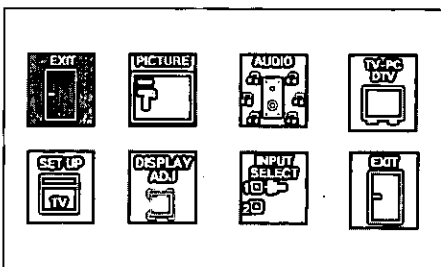

**NOTE:** Only the selected icon (red) will be animated.

## Picture Adjustments

### Picture Norm

Use to reset Color, Tint, Brightness, Picture, and Sharpness to the factory preset level for PC Mode only.

1. Press **(ACTION)**.
2. Press **▲** or **▼** and **◀** or **▶** to highlight the Picture Icon.
3. Press **(ACTION)** to display the VIDEO Adjustment menu.

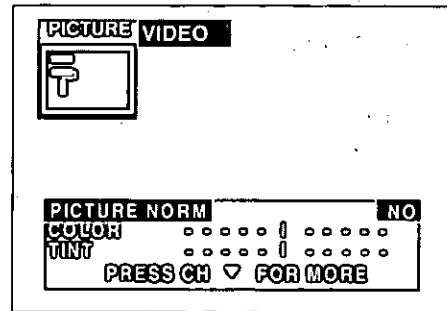

4. Press **▲** or **▼** to highlight PICTURE NORM.
5. Press **◀** or **▶** to select "SET" to normalize Color, Tint, Brightness, Picture, and Sharpness for the PC mode.
6. Press the **(ACTION)** twice to exit menus.

### Color, Tint, Brightness, Picture, and Sharpness

#### Helpful Hints:

**COLOR** - Adjust for desired color intensity.

**TINT** - Adjust for natural flesh tones.

**BRIGHTNESS** - Adjust so dark areas of picture slightly became black for a crisp detail.

**PICTURE** - Adjust the white areas of the picture as desired.

**SHARPNESS** - Adjust for best clarity of outline detail.

1. Press **(ACTION)**.
2. Press **▲** or **▼** and **◀** or **▶** to highlight the Picture Icon.
3. Press the **(ACTION)** to display the VIDEO Adjustment menu.

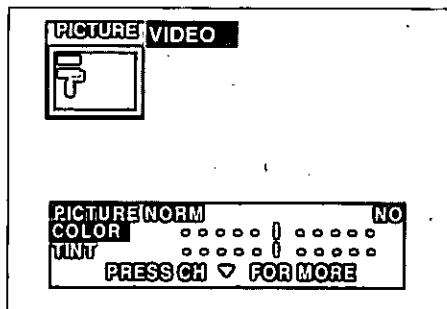

4. Press **▲** or **▼** to select the desired Video Adjustment (Color, Tint, Brightness, Picture or Sharpness).
5. Press **◀** or **▶** to adjust your selection. (The selected Video Adjustment will be displayed).
6. Repeat steps 4 and 5 for remaining Video Adjustments.
7. Press **(ACTION)** twice to exit menus.



# Picture Adjustments (cont'd.)

## Color Temp

To select one of three (3) options for picture temperature.

### Helpful Hints:

- NORMAL** - No tint
- WARM** - Reddish tint
- COOL** - Bluish tint

1. Press **(ACTION)**.
2. Press **CH** or **CH** and **VOL** or **VOL** to highlight the Picture Icon.
3. Press **(ACTION)** to display the Video Adjustment menu.

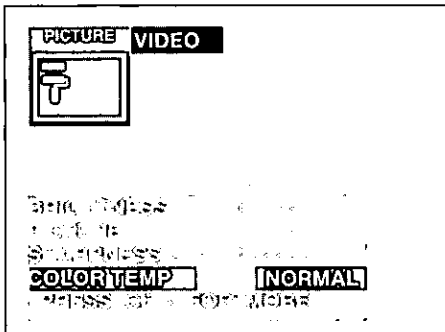

4. Press **CH** or **CH** to highlight COLOR TEMP.
5. Press **VOL** or **VOL** to select NORMAL, WARM, or COOL.  
**NOTE:** The selected Mode will also change Color Temp in TV Mode and DTV Mode.
6. Press **(ACTION)** twice to exit menus.

## Audio Adjustment

### Helpful Hints:

Set PC Mode Audio Adjustments will also change TV Mode and DTV Mode Audio Adjustments.

### Audio Norm

This feature is used to reset Bass, Treble, and Balance back to a factory preset level.

1. Press **(ACTION)**.
2. Press **CH** or **CH** and **VOL** or **VOL** to highlight the Audio Icon.
3. Press **(ACTION)** to display the Audio Adjustment menu.

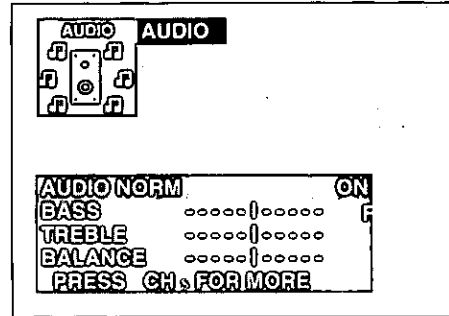

4. Press **CH** or **CH** to highlight AUDIO NORM.
5. Press **VOL** or **VOL** to select "SET" to normalize Bass, Treble, and Balance.
6. Press **(ACTION)** twice to exit menus.

### Bass, Treble, and Balance

Use with front or rear PC audio input jacks when connected to a PC sound source audio output.

### Helpful Hints:

- BASS** - To increase or decrease the Bass response
- TREBLE** - To increase or decrease the Treble response
- BALANCE** - To emphasize the Right and Left speakers' volume

1. Press **(ACTION)**.
2. Press **CH** or **CH** and **VOL** or **VOL** to highlight the Audio Icon.
3. Press **(ACTION)** to display the Audio Adjustment menu.

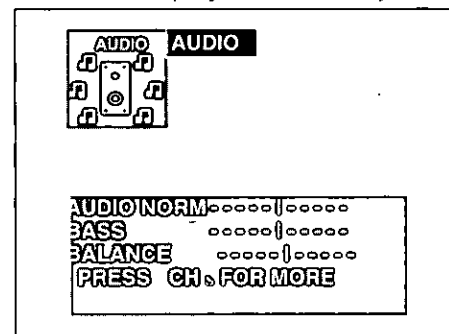

4. Press **CH** or **CH** to highlight BASS, TREBLE, or BALANCE.
5. Press **VOL** or **VOL** to adjust for desired audio response. (The select Audio Adjustment will be displayed.)
6. Repeat steps 4 and 5 for remaining audio functions.
7. Press **(ACTION)** twice to exit menus.

# Audio Adjustments (cont'd.)

## Speaker

This feature is used to turn the internal speakers "ON" or "OFF". It is used when the monitor is connected to an external audio amplifier. (Refer "To Audio Amp" Connection section for further information).

1. Press **(ACTION)**.
2. Press **CH** or **CH** and **VOL** or **VOL** to select the Audio Icon.
3. Press **(ACTION)** to display the Audio Adjustment menu.

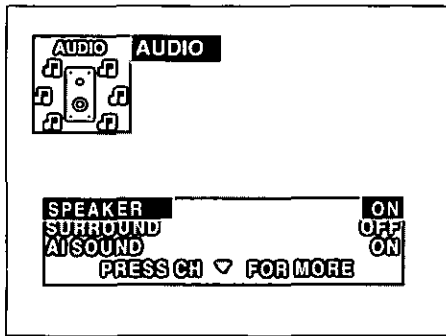

4. Press **CH** or **CH** to highlight SPEAKER.
5. Press **VOL** or **VOL** to select ON, OFF&VAO or OFF&FAO.
  - ON – TV speakers operate normally.
  - OFF&VAO (Variable Audio Output) – TV speakers off, the sound output varies according to the TV volume, use the TV remote to control the volume, muting, bass, treble and balance of the External Stereo System.
  - OFF&FAO (Fixed Audio Output) – TV speakers off, sound output is fixed.
6. Press **(ACTION)** twice to exit menus.

## Surround

Use the Surround Feature to enhance audio response when listening to Stereo sound.

1. Press **(ACTION)**.
2. Press **CH** or **CH** and **VOL** or **VOL** to highlight the Audio Icon.
3. Press **(ACTION)** to display the Audio Adjustment menu.

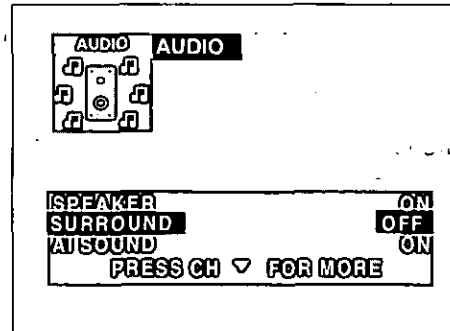

4. Press **CH** or **CH** to highlight SURROUND.
5. Press **VOL** or **VOL** to select SURROUND ON or OFF.
6. Press **(ACTION)** twice to exit menus.

## AI Sound

This feature is used to maintain constant sound level when switching between programs signals with different sound levels.

1. Press **(ACTION)**.
2. Press **CH** or **CH** and **VOL** or **VOL** to highlight the Audio Icon.
3. Press **(ACTION)** to display the Audio Adjustment menu.

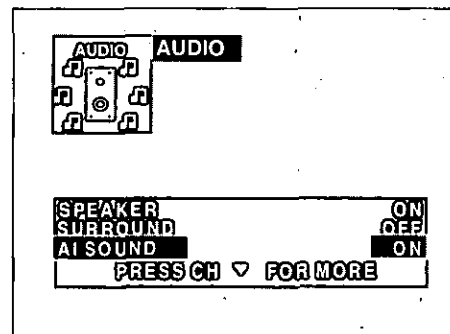

4. Press **CH** or **CH** to highlight AI SOUND.
5. Press **VOL** or **VOL** to select AI SOUND ON or OFF.
6. Press **(ACTION)** twice to exit menus.

PC MODE

# Set Up Features

## Helpful Hints:

Setting PC Mode Set Up Features will also change TV Mode and DTV Mode Set Up Features.

**Auto Power On** - This feature automatically turns the monitor ON when AC power is applied.

1. Press **(ACTION)**.
2. Press **CH** or **CH** and **VOL** or **VOL** to select the Set Up Icon.
3. Press **(ACTION)** to display the Set Up menu.

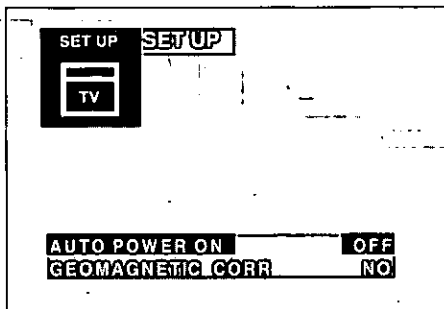

**NOTE:** Setting the Auto Power On feature will cancel the time and timer control setting. Also, the TV Mode Main Menu Icon for the Control will be replaced with an Exit icon.

4. Press **CH** or **CH** to highlight AUTO POWER ON.
5. Press **VOL** or **VOL** to select SET.
6. Press **(ACTION)** twice to exit menus.

## Geomagnetic Corr (Correction)

This monitor incorporates a special adjustment feature for the convenience of the customer. This adjustment is preset at the factory. However, adjustment may be required when the monitor is moved (due to the influence of earth's magnetic field) which may cause the picture to tilt slightly. If necessary, follow these procedures to adjust the tilt.

1. Press **(ACTION)**.
2. Press **CH** or **CH** and **VOL** or **VOL** to highlight the Set Up Icon.
3. Press **(ACTION)** to display the Set Up Menu.

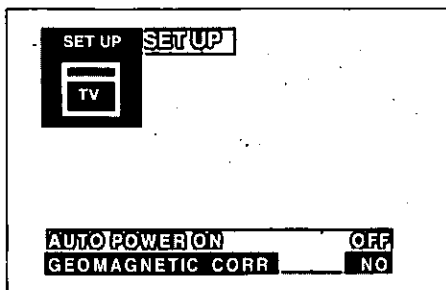

4. Press **CH** or **CH** to highlight GEOMAGNETIC CORR.
5. Press **VOL** or **VOL** to display the Geomagnetic Correction adjustment menu.

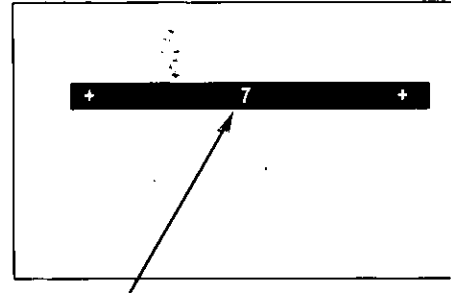

tilt adjustment bar

6. Press **VOL** or **VOL** to adjust the picture tilt until left and right side of tilt adjustment bar is parallel to the bottom of picture frame (if necessary).

**NOTE:** Discoloration may be visible in picture corners if tilt bar is not parallel to the bottom of picture frame.

7. Press **(ACTION)** twice to exit menus.

## Input Select

This feature is used to select PC Input Front or PC Input Rear for the monitor Input signals.

1. Press **(ACTION)**.
2. Press **CH** or **CH** and **VOL** or **VOL** to highlight the Input Select Icon.
3. Press **(ACTION)** to display the Input Select Menu.

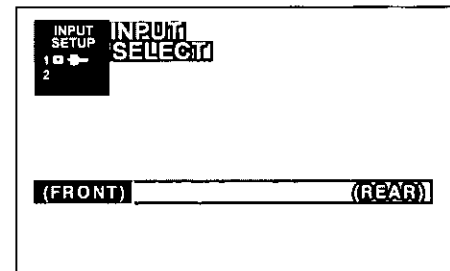

4. Press **VOL** or **VOL** to select FRONT or REAR.

**NOTE:** PC Front or PC Rear can also be selected by pressing the Input button while input Select menu is displayed.

5. Press **(ACTION)** twice to exit menus.

# Display Adj

This feature is used to adjust the image on the monitor.

1. Press **(ACTION)**.
2. Press **(CH)** or **(CH)** and **(VOL)** or **(VOL)** to highlight the Display Adj Icon.
3. Press **(ACTION)** to display the Display Adj menu.

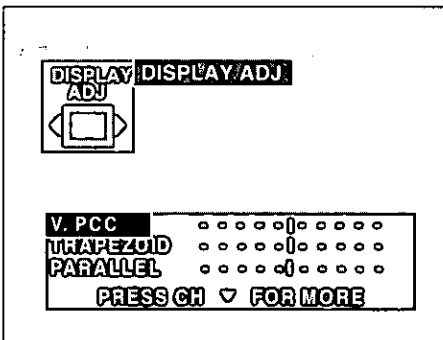
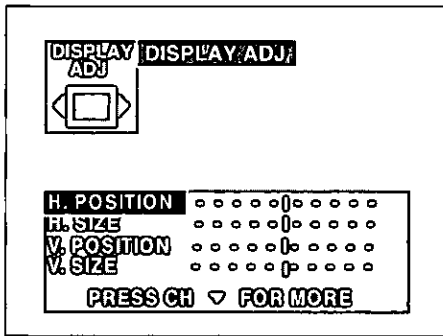

4. Press **(CH)** or **(CH)** to highlight H. POSITION, H. SIZE, V. POSITION, V. SIZE, V. PCC, TRAPEZOID, or PARALLEL (PARALLELOGRAM).
5. Press **(VOL)** or **(VOL)** to adjust your selection. (The selected Display Adj will be displayed).
6. Repeat steps 4 and 5 for the remaining Display Adjustments.
7. Press **(ACTION)** twice to exit menus.

## Display Adjust Chart

Selection	Press
H. POSITION	moves the picture to left                      moves the picture to right
H. SIZE	decreases the horizontal size                      increases the horizontal size
V. POSITION	moves the picture upward                      moves the picture downward
V. SIZE	decreases the vertical size                      increases the vertical size
V. PCC	decreases the distortion                      increases the distortion
TRAPEZOID	to make bottom edge narrower                      to make top edge narrower
PARALLEL	to collapse to the right                      to collapse to the left

PC MODE

# DTV Mode

## Component Video Connection

### Helpful Hints:

An input signal must be connected to the input terminals of the monitor, in order to access PC and DTV mode Icon menus.

### Operation

1. Select DTV mode from the TV/PC/DTV menu (located in the TV/PC/DTV Icon).
2. Connect audio/video cables from the Component Video output terminals to the monitor DIGITAL TV INPUT terminals, as shown.

**NOTE:** To operate your Monitor with component video devices properly, refer to the instructions furnished with the component video device.

### Helpful Hints:

When there is no signal applied, the Icon menus in the PC and DTV mode will appear small and distorted.

**This is a normal condition.**

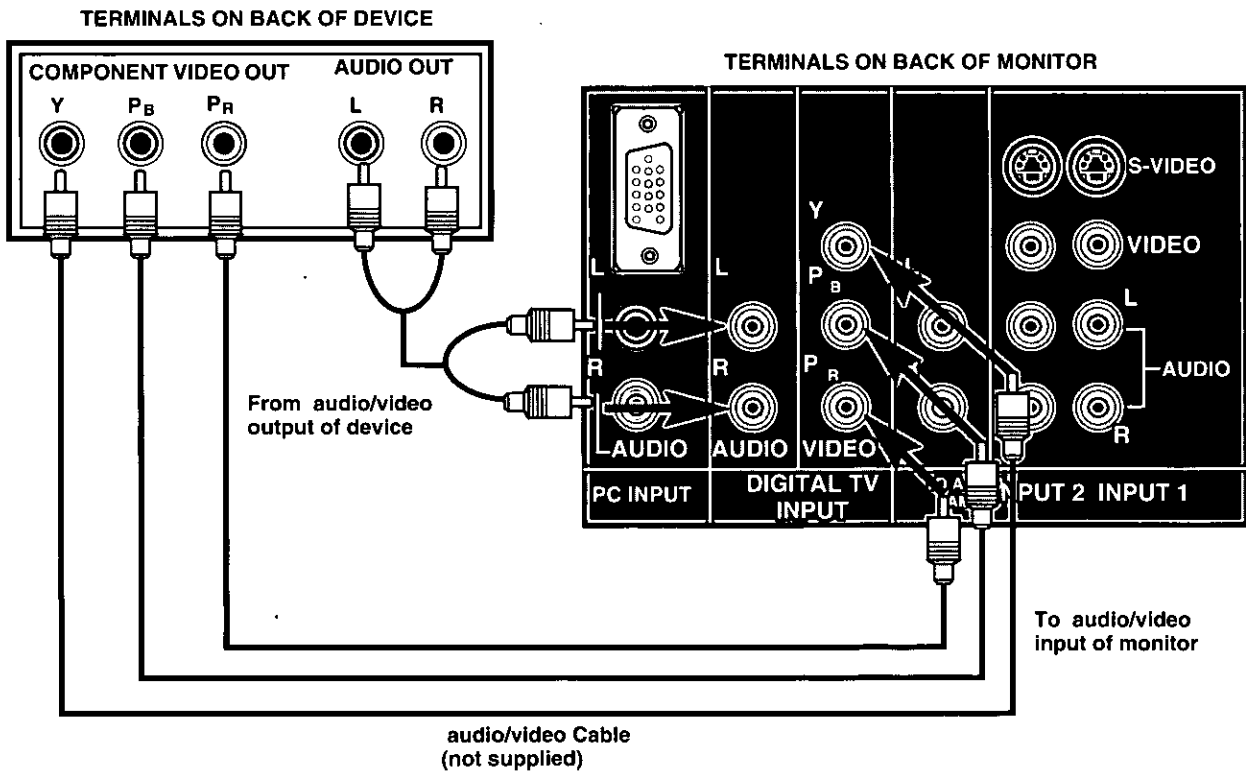

# DTV Mode

## TV/PC/DTV

This feature is used to select the DTV mode for monitor display.

1. Press **(ACTION)**.
2. Press **CH** or **CH** and **VOL** or **VOL** to highlight the TV/PC/DTV icon.
3. Press **(ACTION)** to display the TV/PC/DTV MODE menu.

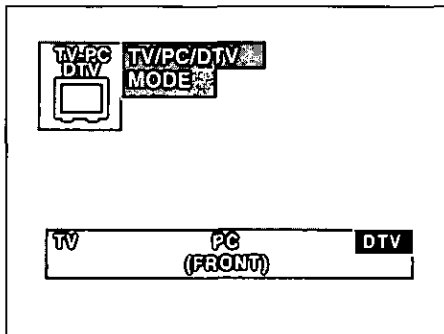

4. Press **VOL** or **VOL** to highlight DTV.
5. Press **(ACTION)** twice to exit menus.

## Trilingual Animated Icons

### DTV Mode Icons

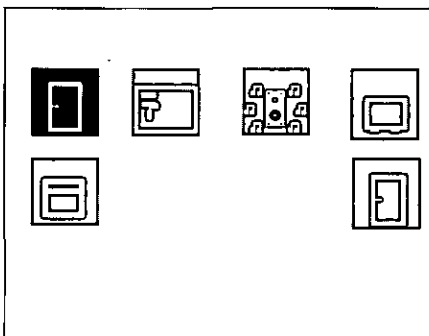

**NOTE:** Only the selected icon (red) will be animated.

## Picture Adjustments

### Picture Norm

Use to reset Color, Tint, Brightness, Picture, and Sharpness to the factory preset level (DTV Mode).

1. Press **(ACTION)**.
2. Press **CH** or **CH** and **VOL** or **VOL** to highlight the Picture Icon.
3. Press **(ACTION)** to display the VIDEO Adjustment menu.

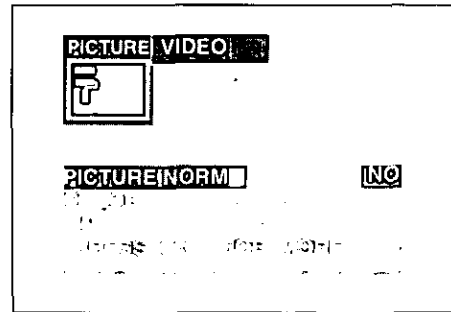

4. Press **CH** or **CH** to highlight PICTURE NORM.
5. Press **VOL** or **VOL** to select "SET" to normalize Color, Tint, Brightness, Picture, and Sharpness (DTV mode).
6. Press the **(ACTION)** twice to exit menus.

## Color, Tint, Brightness, Picture, and Sharpness

### Helpful Hints:

**COLOR** - Adjust for desired color intensity.

**TINT** - Adjust for natural flesh tones.

**BRIGHTNESS** - Adjust so dark areas of picture slightly became black for a crisp detail.

**PICTURE** - Adjust the white areas of the picture as desired.

**SHARPNESS** - Adjust for best clarity of outline detail.

1. Press **(ACTION)**.
2. Press **CH** or **CH** and **VOL** or **VOL** to highlight the Picture Icon.
3. Press the **(ACTION)** to display the VIDEO Adjustment menu.

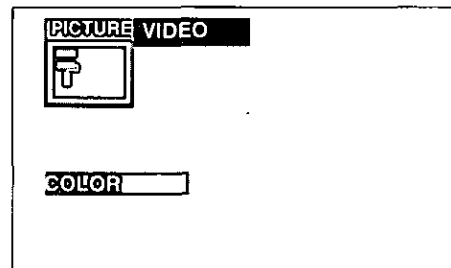

4. Press **CH** or **CH** to select the desired Video Adjustment (Color, Tint, Brightness, Picture or Sharpness).
5. Press **VOL** or **VOL** to adjust your selection. (The selected Video Adjustment will be displayed).
6. Repeat steps 4 and 5 for remaining Video Adjustment.
7. Press **(ACTION)** twice to exit menus.

# Picture Adjustment (cont'd.)

## Color Temp

Use to select one of three (3) options for picture temperature.

### Helpful Hints:

**NORMAL** - No tint  
**WARM** - Reddish tint  
**COOL** - Bluish tint

1. Press **(ACTION)**.
2. Press **▲** or **▼** and **◀** or **▶** to highlight the Picture Icon.
3. Press **(ACTION)** to display the Video Adjustment menu.

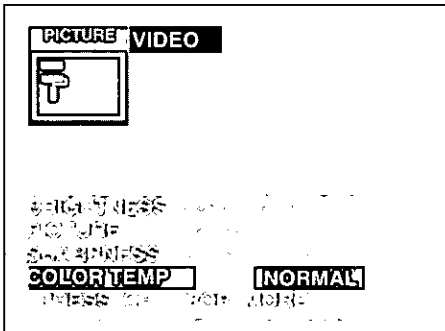

4. Press **▲** or **▼** to highlight COLOR TEMP.
5. Press **◀** or **▶** to select Normal, Warm or Cool mode.
6. Press **(ACTION)** twice to exit menus.

## Audio Adjustment

### Helpful Hints:

Setting DTV mode Audio Adjustments will also change TV Mode and PC mode Audio Adjustment.

### Audio Norm

This feature is used to reset Bass, Treble, and Balance back to a factory preset level.

1. Press **(ACTION)**.
2. Press **▲** or **▼** and **◀** or **▶** to highlight the Audio Icon.
3. Press **(ACTION)** to display the Audio Adjustment menu.

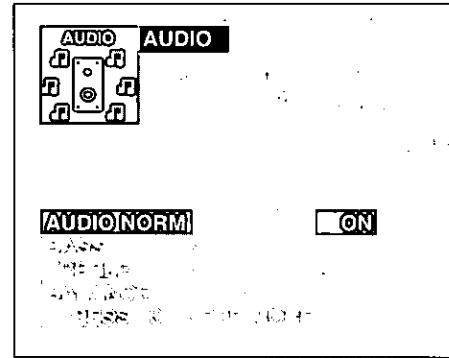

4. Press **▲** or **▼** to highlight AUDIO NORM.
5. Press **◀** or **▶** to select "SET" to normalize Bass, Treble, and Balance.
6. Press **(ACTION)** twice to exit menus.

## Bass, Treble, and Balance

### Helpful Hints:

**BASS** - To increase or decrease the Bass response  
**TREBLE** - To increase or decrease the Treble response  
**BALANCE** - To emphasize the Right and Left speakers' volume

1. Press **(ACTION)**.
2. Press **▲** or **▼** and **◀** or **▶** to highlight the Audio Icon.
3. Press **(ACTION)** to display the Audio Adjustment Menu.

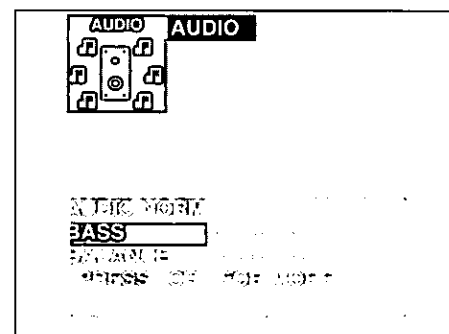

4. Press **▲** or **▼** to highlight BASS, TREBLE, or BALANCE.
5. Press **◀** or **▶** to adjust for desired audio response. (The selected Audio Adjustment will be displayed.)
6. Repeat steps 4 and 5 for remaining audio functions.
7. Press **(ACTION)** twice to exit menu.

# Audio Adjustments (cont'd.)

## Speaker

This feature is used to turn the internal speakers "ON" or "OFF". It is used when the monitor is connected to an External Audio Amplifier. (Refer to "To Audio Amp" Connection section for further information).

1. Press **(ACTION)**.
2. Press **CH** or **CH** and **VOL** or **VOL** to select the Audio Icon.
3. Press **(ACTION)** to display the Audio Adjustment menu.

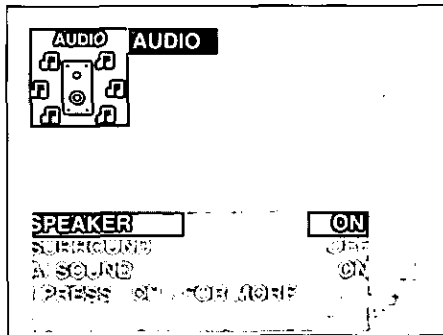

4. Press **CH** or **CH** to highlight SPEAKER.
5. Press **VOL** or **VOL** to select ON, OFF&VAO or OFF&FAO.
  - ON – TV speakers operate normally.
  - OFF&VAO (Variable Audio Output) – TV speakers off, the sound output varies according to the TV volume, use the TV remote to control the volume, muting, bass, treble and balance of the External Stereo System.
  - OFF&FAO (Fixed Audio Output) – TV speakers off, sound output is fixed.
6. Press **(ACTION)** twice to exit menus.

## Surround

Use the Surround Feature to enhance audio response when listening to Stereo sound.

1. Press **(ACTION)**.
2. Press **CH** or **CH** and **VOL** or **VOL** to highlight the Audio Icon.
3. Press **(ACTION)** to display the Audio Adjustment menu.

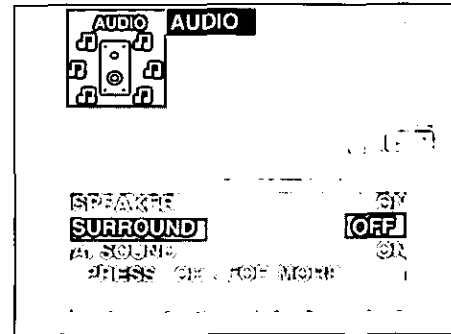

4. Press **CH** or **CH** to highlight SURROUND.
5. Press **VOL** or **VOL** to select SURROUND ON or OFF.
6. Press **(ACTION)** twice to exit menus.

## AI Sound

This feature is used to maintain constant sound level when switching between programs with different sound levels.

1. Press **(ACTION)**.
2. Press **CH** or **CH** and **VOL** or **VOL** to highlight the Audio Icon.
3. Press **(ACTION)** to display the Audio Adjustment menu.

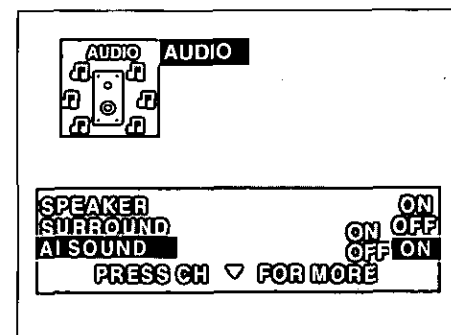

4. Press **CH** or **CH** to highlight AI SOUND.
5. Press **VOL** or **VOL** to select AI SOUND ON or OFF.
6. Press **(ACTION)** twice to exit menus.



# Set Up Features

## Helpful Hints:

Setting DTV mode Set Up Features will also change TV Mode and PC mode Set Up Features.

## Auto Power On

This feature automatically turns the monitor ON when AC power is applied.

1. Press **(ACTION)**.
2. Press **CH** or **CH** and **VOL** or **VOL** to select the Set Up Icon.
3. Press **(ACTION)** to display the Set Up menu.

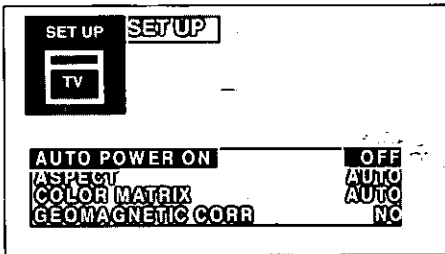

4. Press **CH** or **CH** to highlight AUTO POWER ON.
5. Press **VOL** or **VOL** to select SET.
6. Press **(ACTION)** twice to exit menus.

## Aspect Ratio

This feature is used to change the aspect ratio of the screen when connected to a DTV unit.

1. Press **(ACTION)**.
2. Press **CH** or **CH** and **VOL** or **VOL** to highlight the Set Up Icon.
3. Press **(ACTION)** to display the Set Up menu.

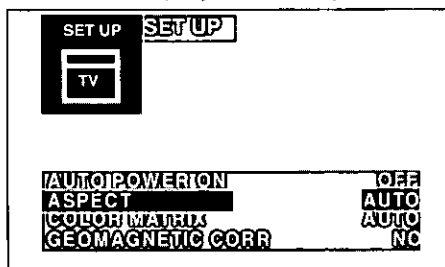

4. Press **VOL** or **VOL** to select AUTO, 16:9 (wide picture), or 4:3 (normal picture).
5. Press **(ACTION)** twice to exit menus.

## Color Matrix

This feature is used to change the picture Color Matrix to Standard or High.

1. Press **(ACTION)**.
2. Press **CH** or **CH** and **VOL** or **VOL** to highlight the Set Up Icon.
3. Press **(ACTION)** to display the Set Up menu.

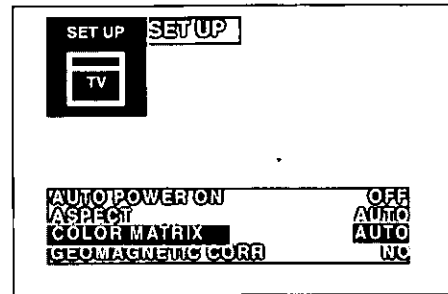

4. Press **VOL** or **VOL** to select AUTO, HD (High Definition), or SD (Standard Definition).
5. Press **(ACTION)** twice to exit menus.

## Geomagnetic Corr (Correction)

This monitor incorporates a special adjustment feature for the convenience of the customer. This adjustment is preset at the factory. However, adjustment may be required when the monitor is moved (due to the influence of earth's magnetic field) which may cause the picture to tilt slightly. If necessary, follow these procedures to adjust the tilt.

1. Press **(ACTION)**.
2. Press **CH** or **CH** and **VOL** or **VOL** to highlight the Set Up Icon.
3. Press **(ACTION)** to display the Set Up menu.

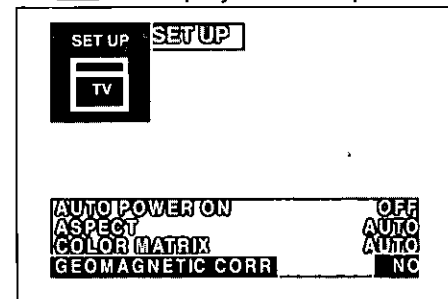

4. Press **CH** or **CH** to highlight GEOMAGNETIC CORR.
5. Press **VOL** or **VOL** to display the Geomagnetic Correction adjustment menu.

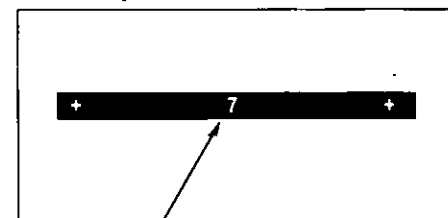



















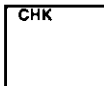

tilt adjustment bar

6. Press **VOL** or **VOL** to adjust the picture tilt until left and right side of tilt adjustment bar is parallel to the bottom of picture frame (if necessary).
- NOTE: Discoloration may be visible in picture corners if tilt bar is not parallel to the bottom of picture frame.**
7. Press **(ACTION)** twice to exit menus.

# Troubleshooting Chart

Before you call for service, determine the symptoms and make a few simple checks shown below

Symptoms		Check
Picture	Sound	
 SNOWY PICTURE	 NOISY SOUND	- INPUT CONNECTORS SEATED PROPERLY - EQUIPMENT CONNECTED TO INPUT CONNECTIONS - ANTENNA LOCATION AND/OR CONNECTION
 INTERFERENCE	 NOISY SOUND	- ELECTRICAL APPLIANCES, LIGHTS, CARS, AND TRUCKS - DIATHERMY AND OTHER MEDICAL EQUIPMENT - VIDEO INPUT CONNECTORS SEATED PROPERLY
 NORMAL PICTURE	 NO SOUND	- VOLUME CONTROL SETTING - TV SPEAKERS (IF APPLICABLE) IN THE OFF MODE - AUDIO INPUT CONNECTOR SEATED PROPERLY - TRY ANOTHER CHANNEL
 NO PICTURE	 NO SOUND	- THAT AC POWER LINE IS PLUGGED INTO AC OUTLET - BRIGHTNESS AND AUDIO CONTROLS SET PROPERLY - VIDEO AND AUDIO INPUT CONNECTORS SEATED PROPERLY
 NO COLOR	 NORMAL SOUND	- COLOR CONTROL SETTINGS - TRY ANOTHER CHANNEL
 NORMAL PICTURE	 NO SOUND	- MONITOR/RECEIVER IN VIDEO MODE WITH NO SIGNAL
 CHK MODE PC MODE	 NORMAL SOUND	- PRESS AND HOLD ACTION AND POWER BUTTONS AT THE SAME TIME FOR 5 SECONDS. SCREEN WILL SHUT OFF, THEN TURN BACK ON. TV WILL BE SET TO CHANNEL 3 AND CYCLE THROUGH A SPECIAL TEST
 SCRAMBLED IMAGE	 NORMAL SOUND	- COMPUTER CABLE SEATED PROPERLY - COMPUTER RESOLUTION NOT SET PROPERLY (REFER TO FOLLOWING PAGES FOR SET UP PROCEDURES)
 DISCOLORATION	 NORMAL SOUND	- ADJUST GEOMAGNETIC CORRECTION LOCATED IN THE SET-UP MENU (IF APPLICABLE)
 DISCOLORED PICTURE	 NORMAL SOUND	- MOVE UNSHIELDED SPEAKERS AWAY FROM PICTURE TUBE - TURN OFF SET, ALLOW TO COOL, TURN SET BACK ON

# Troubleshooting (cont'd.)

## Computer Resolution Set Up For Windows 95 Version

The resolution on your computer may have to be set to 800 x 600 pixels or less. To change, follow these procedures.

1. Shut down and restart the computer.
2. While the "Starting Windows 95" message is displayed on screen, quickly press "F8" key, then press ENTER key.

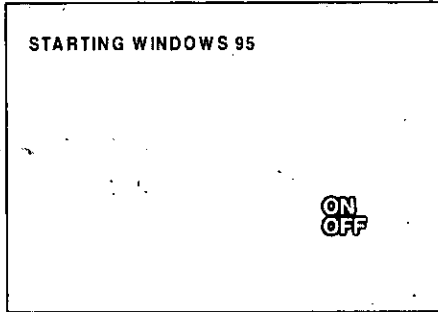

Print . . . . .

3. Windows 95 start up menu will be displayed. Then select "Safe mode" by using down arrow key or type in the number.

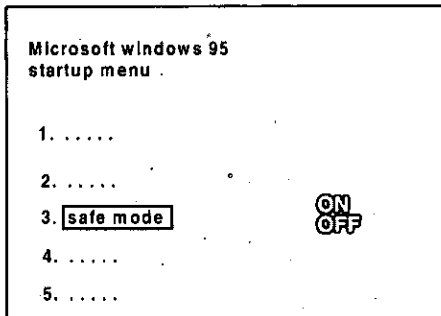

4. Press "ENTER" key.

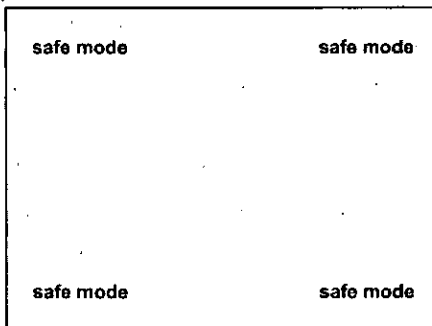

5. Click on the "Start" button, and then point to Settings.

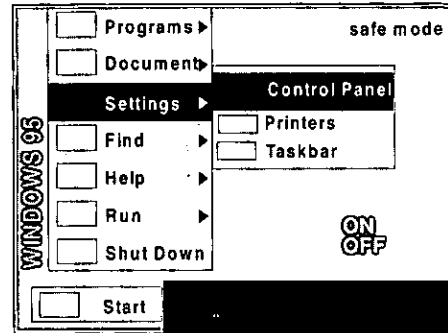

6. Click on "Control Panel".
7. Double-click "Display" icon. The Display Properties box will appear. . .

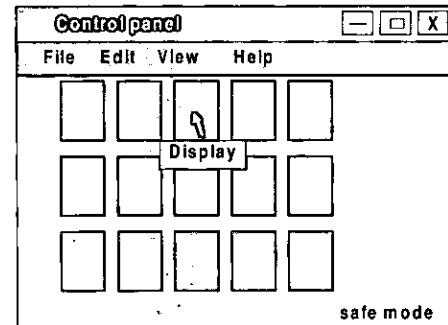

8. Click on the tab labeled "Settings" at the top of the Display Properties box.

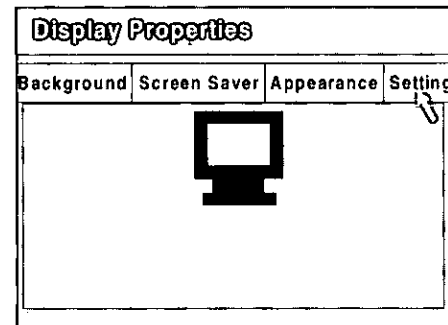

9. Select resolution from the "Desktop Area" menu box, 800 x 600 pixels or less, then click OK.

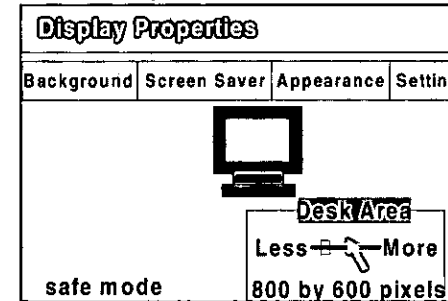

10. Restart the computer before the new setting will take effect.
11. Restart Windows 95 in normal mode.

TROUBLESHOOTING

# Troubleshooting (cont'd.)

## Computer Resolution Set Up For Windows Version 3.X

The resolution on your computer may have to be set to VGA. To change, follow these procedures.

1. Restart the computer from DOS.

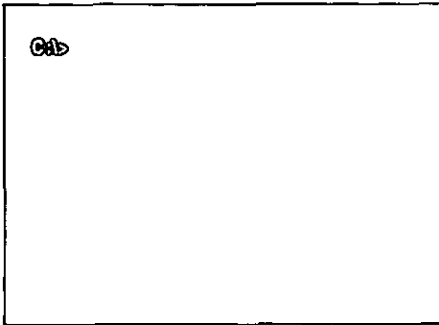

2. Type "cd\windows", then press ENTER key on Computer keyboard.

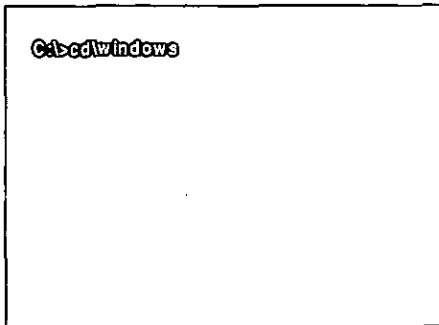

3. Type "setup", then press ENTER key on Computer keyboard.

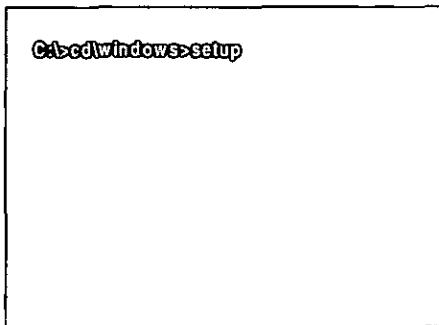

4. Windows Setup screen will be displayed. Press the Up or Down arrow key on the computer keyboard to highlight "Display".

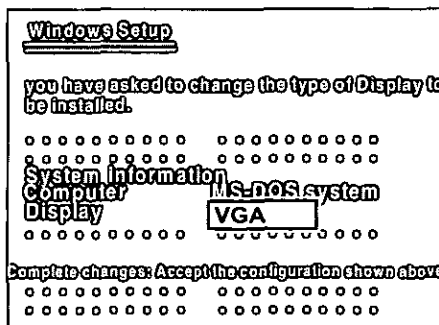

5. Press ENTER key.

6. Press ENTER key, then press the Down arrow key on the computer keyboard to highlight "VGA".

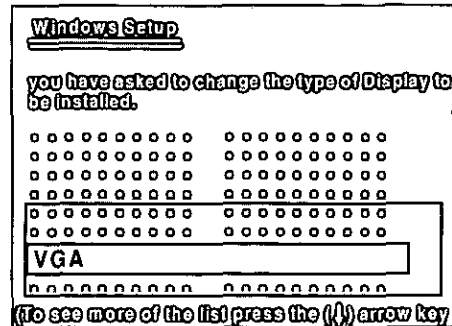

7. Press ENTER key while VGA is highlighted. The screen will return to previous Windows Setup screen, then check that Display setting was changed to VGA.

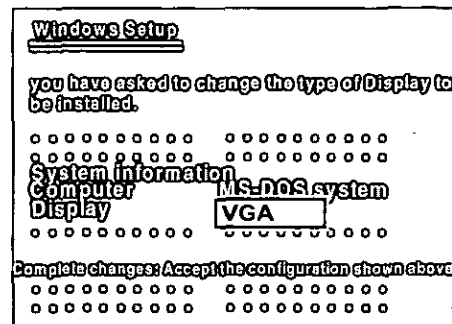

8. Press ENTER key while "Accept the configuration shown above" is highlighted.

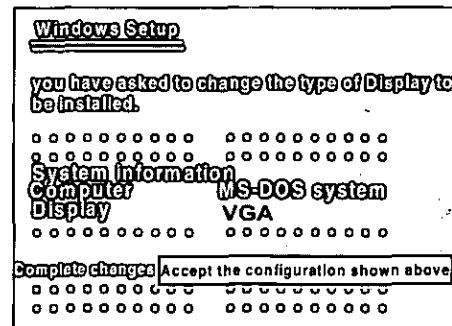

9. Press ENTER key to accept driver. This will return you back to DOS prompt. Then enter Window 3.X from DOS.

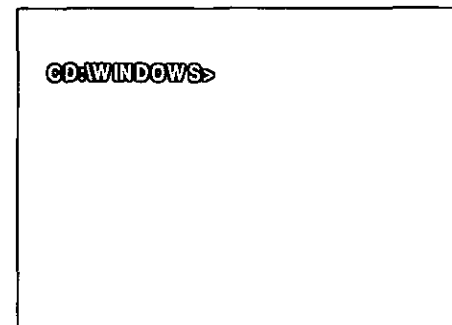

TRUBLESHOOTING

**Panasonic Consumer Electronics  
Company, Division of Matsushita  
Electric Corporation of America**  
One Panasonic Way  
Secaucus, New Jersey 07094

**Panasonic Sales Company,  
Division of Matsushita Electric  
of Puerto Rico Inc. ("PCS")**  
Ave.65 de Infanteria, km. 9.5  
San Gabriel Industrial Park  
Carolina, Puerto Rico 00985

**Panasonic Canada Inc.**  
5770 Ambler Drive  
Mississauga, Ontario L4W 2T3  
Canada

## Free Manuals Download Website

<http://myh66.com>

<http://usermanuals.us>

<http://www.somanuals.com>

<http://www.4manuals.cc>

<http://www.manual-lib.com>

<http://www.404manual.com>

<http://www.luxmanual.com>

<http://aubethermostatmanual.com>

Golf course search by state

<http://golfingnear.com>

Email search by domain

<http://emailbydomain.com>

Auto manuals search

<http://auto.somanuals.com>

TV manuals search

<http://tv.somanuals.com>