

Panasonic®

Operating Instructions

Premium Design Phone

Model No. **KX-PRS110FX**



SMS

***Before initial use, see “Getting Started”
on page 9.***

Thank you for purchasing a Panasonic product.

Please read these operating instructions before using the unit and save them for future reference.

To use this unit in your country, first change the unit's region setting to match your country (page 30). Change the unit's display language as needed (page 12).

(For Czech and Slovakia)

This cordless telephone is possible to use according to General licence No.: VO-R/8/08.2005-23 (for Czech), VPR-7/2001 (for Slovakia).

Table of Contents

Introduction

Accessory information	3
General information	4

Important Information

For your safety	5
Important safety instructions	6
For best performance	6
Other information	7
Specifications	7

Getting Started

Setting up	9
Controls	10
Display icons	11
Turning the power on/off	12
Language setting	12
Date and time	12
Other settings	12

Making/Answering Calls

Making calls	14
Answering calls	14
Useful features during a call	14
Intercom	16
Key lock	16

Phonebook

Phonebook	17
Speed dial	18

Programming

Menu list	20
Alarm	26
Night mode	26
Incoming call barring	27
Baby monitor	28
Other programming	29
Registering a unit	31

Caller ID Service

Using Caller ID service	33
Caller list	33

SMS (Short Message Service)

Setting up SMS	35
Sending a message	35
Receiving a message	36
Other settings	37

Useful Information

Voice mail service	38
Character entry	38
Error messages	40
Troubleshooting	41

Index

Index.....	45
------------	----

Accessory information

Supplied accessories

No.	Accessory item/Part number	Quantity
①	AC adaptor/PNLV226CE	1
②	Telephone line cord	1
③	Rechargeable batteries*1	2
④	Handset cover*2	1

*1 See page 3 for replacement battery information.

*2 The handset cover comes attached to the handset.



Additional/replacement accessories

Please contact your nearest Panasonic dealer for sales information.

Accessory item	Model number
Rechargeable batteries	HHR-4MVE or HHR-4MY*1
	Battery type: – Nickel metal hydride (Ni-MH) – 2 x AAA (R03) size for each handset
DECT repeater	KX-A405
Key finder	KX-TGA20FX*2

*1 Replacement batteries may have a different capacity from that of the supplied batteries.

*2 By registering the key finder (4 max.) to a Panasonic Digital Cordless Phone and attaching it to an easy-to-lose item in advance, you can locate and find the mislaid item to which the key finder is attached. Please visit our Web site:

<http://panasonic.net/pcc/products/telephone/p/tga20/>

Please contact Panasonic or authorised sales department on the back cover for availability of key finder in your area.

Other information

- Design and specifications are subject to change without notice.
- The illustrations in these instructions may vary slightly from the actual product.

Introduction

Expanding your phone system

Handset (optional): KX-PRSA10FX

You can expand your phone system by registering optional handsets (6 max.) to a single base unit.

- Optional handsets may be a different colour from that of the supplied handsets.



General information

- This equipment is designed for use on the Czech, Slovakia, Estonia, Latvia, Lithuania, Croatia, Slovenia, Romania and Bulgaria analogue telephone network.
- In the event of problems, you should contact your equipment supplier in the first instance.
- For use in other countries, please contact your equipment supplier.

Declaration of Conformity:

- Panasonic System Networks Co., Ltd. declares that this equipment is in compliance with the essential requirements and other relevant provisions of Radio & Telecommunications Terminal Equipment (R&TTE) Directive 1999/5/EC.

Declarations of Conformity for the relevant Panasonic products described in this manual are available for download by visiting:

<http://www.ptc.panasonic.eu>

Contact to Authorised Representative:

Panasonic Testing Centre
Panasonic Marketing Europe GmbH
Winsbergring 15, 22525 Hamburg, Germany

For your future reference

We recommend keeping a record of the following information to assist with any repair under warranty.

Serial No.	Date of purchase
(found on the bottom of the base unit)	
Name and address of dealer	

Attach your purchase receipt here.

Important Information

For your safety

To prevent severe injury and loss of life/property, read this section carefully before using the product to ensure proper and safe operation of your product.

WARNING

Power connection

- Use only the power source marked on the product.
- Do not overload power outlets and extension cords. This can result in the risk of fire or electric shock.
- Completely insert the AC adaptor/power plug into the power outlet. Failure to do so may cause electric shock and/or excessive heat resulting in a fire.
- Regularly remove any dust, etc. from the AC adaptor/power plug by pulling it from the power outlet, then wiping with a dry cloth. Accumulated dust may cause an insulation defect from moisture, etc. resulting in a fire.
- Unplug the product from power outlets if it emits smoke, an abnormal smell, or makes an unusual noise. These conditions can cause fire or electric shock. Confirm that smoke has stopped emitting and contact an authorised service centre.
- Unplug from power outlets and never touch the inside of the product if its casing has been broken open.
- Never touch the plug with wet hands. Danger of electric shock exists.

Installation

- To prevent the risk of fire or electrical shock, do not expose the product to rain or any type of moisture.
- Do not place or use this product near automatically controlled devices such as automatic doors and fire alarms. Radio waves emitted from this product may cause such devices to malfunction resulting in an accident.

- Do not allow the AC adaptor or telephone line cord to be excessively pulled, bent or placed under heavy objects.

Operating safeguards

- Unplug the product from power outlets before cleaning. Do not use liquid or aerosol cleaners.
- Do not disassemble the product.
- Do not spill liquids (detergents, cleansers, etc.) onto the telephone line cord plug, or allow it to become wet at all. This may cause a fire. If the telephone line cord plug becomes wet, immediately pull it from the telephone wall jack, and do not use.

Medical

- Consult the manufacturer of any personal medical devices, such as pacemakers or hearing aids, to determine if they are adequately shielded from external RF (radio frequency) energy. (The product operates in the frequency range of 1.88 GHz to 1.90 GHz, and the RF transmission power is 250 mW (max.).)
- Do not use the product in health care facilities if any regulations posted in the area instruct you not to do so. Hospitals or health care facilities may be using equipment that could be sensitive to external RF energy.

CAUTION

Installation and location

- Never install telephone wiring during an electrical storm.
- Never install telephone line jacks in wet locations unless the jack is specifically designed for wet locations.
- Never touch uninsulated telephone wires or terminals unless the telephone line has been disconnected at the network interface.
- Use caution when installing or modifying telephone lines.
- The AC adaptor is used as the main disconnect device. Ensure that the AC outlet is installed near the product and is easily accessible.
- This product is unable to make calls when:

Important Information

- the handset batteries need recharging or have failed.
- there is a power failure.
- the key lock feature is turned on.

Battery

- We recommend using the batteries noted on page 3. **USE ONLY rechargeable Ni-MH batteries AAA (R03) size.**
- Do not mix old and new batteries.
- Do not open or mutilate the batteries. Released electrolyte from the batteries is corrosive and may cause burns or injury to the eyes or skin. The electrolyte is toxic and may be harmful if swallowed.
- Exercise care when handling the batteries. Do not allow conductive materials such as rings, bracelets, or keys to touch the batteries, otherwise a short circuit may cause the batteries and/or the conductive material to overheat and cause burns.
- Charge the batteries provided with or identified for use with this product only, in accordance with the instructions and limitations specified in this manual.
- Only use a compatible base unit (or charger) to charge the batteries. Do not tamper with the base unit (or charger). Failure to follow these instructions may cause the batteries to swell or explode.

Important safety instructions

When using your product, basic safety precautions should always be followed to reduce the risk of fire, electric shock, and injury to persons, including the following:

1. Do not use this product near water for example, near a bathtub, washbowl, kitchen sink, or laundry tub, in a wet basement or near a swimming pool.
2. Avoid using a telephone (other than a cordless type) during an electrical storm. There may be a remote risk of electric shock from lightning.
3. Do not use the telephone to report a gas leak in the vicinity of the leak.

4. Use only the power cord and batteries indicated in this manual. Do not dispose of batteries in a fire. They may explode. Check with local codes for possible special disposal instructions.

SAVE THESE INSTRUCTIONS

For best performance

Base unit location/avoiding noise

The base unit and other compatible Panasonic units use radio waves to communicate with each other.

- For maximum coverage and noise-free communications, place your base unit:
 - at a convenient, high, and central location with no obstructions between the handset and base unit in an indoor environment.
 - away from electronic appliances such as TVs, radios, personal computers, wireless devices, or other phones.
 - facing away from radio frequency transmitters, such as external antennas of mobile phone cell stations. (Avoid putting the base unit on a bay window or near a window.)
- Coverage and voice quality depends on the local environmental conditions.
- If the reception for a base unit location is not satisfactory, move the base unit to another location for better reception.

Environment

- Keep the product away from electrical noise generating devices, such as fluorescent lamps and motors.
- The product should be kept free from excessive smoke, dust, high temperature, and vibration.
- The product should not be exposed to direct sunlight.
- Do not place heavy objects on top of the product.
- When you leave the product unused for a long period of time, unplug the product from the power outlet.
- The product should be kept away from heat sources such as radiators, cookers, etc. It

Important Information

should not be placed in rooms where the temperature is less than 0 °C or greater than 40 °C. Damp basements should also be avoided.

- The maximum calling distance may be shortened when the product is used in the following places: Near obstacles such as hills, tunnels, underground, near metal objects such as wire fences, etc.
- Operating the product near electrical appliances may cause interference. Move away from the electrical appliances.

Routine care

- **Wipe the outer surface of the product with a soft moist cloth.**
- Do not use benzine, thinner, or any abrasive powder.

Other information

CAUTION: Risk of explosion if battery is replaced by an incorrect type. Dispose of used batteries according to the instructions.

Notice for product disposal, transfer, or return

- This product can store your private/confidential information. To protect your privacy/confidentiality, we recommend that you erase information such as phonebook or caller list entries from the memory before you dispose of, transfer, or return the product.

Information for Users on Collection and Disposal of Old Equipment and used Batteries

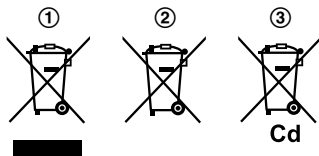

These symbols (①, ②, ③) on the products, packaging, and/or accompanying documents mean that used electrical and electronic products and batteries should not be mixed with general household waste.

For proper treatment, recovery and recycling of old products and used batteries, please take them to applicable collection points, in accordance with your national legislation and the Directives 2002/96/EC and 2006/66/EC. By disposing of these products and batteries correctly, you will help to save valuable resources and prevent any potential negative effects on human health and the environment which could otherwise arise from inappropriate waste handling.

For more information about collection and recycling of old products and batteries, please contact your local municipality, your waste disposal service or the point of sale where you purchased the items.

Penalties may be applicable for incorrect disposal of this waste, in accordance with national legislation.

For business users in the European Union

If you wish to discard electrical and electronic equipment, please contact your dealer or supplier for further information.

Information on Disposal in other Countries outside the European Union

These symbols (①, ②, ③) are only valid in the European Union. If you wish to discard these items, please contact your local authorities or dealer and ask for the correct method of disposal.

Note for the battery symbol

This symbol (②) might be used in combination with a chemical symbol (③). In this case it complies with the requirement set by the Directive for the chemical involved.

Specifications

- **Standard:**

Important Information

DECT (Digital Enhanced Cordless
Telecommunications),
GAP (Generic Access Profile)

- **Frequency range:**
1.88 GHz to 1.90 GHz
- **RF transmission power:**
Approx. 10 mW (average power per
channel)
- **Power source:**
220–240 V AC, 50/60 Hz
- **Power consumption:**
Base unit:
Standby: Approx. 0.6 W
Maximum: Approx. 2.8 W
- **Operating conditions:**
0 °C–40 °C, 20 %–80 % relative air
humidity (dry)

Setting up

Connections

■ Base unit

- ① Connect the AC adaptor plug to the unit until you hear a click.
- ② Fasten the cord by hooking it.
- ③ Connect the AC adaptor to the power outlet.
- ④ Connect the telephone line cord to the unit until you hear a click.
- ⑤ Fasten the cord by hooking it.
- ⑥ Connect the telephone line cord to the telephone line jack until you hear a click.
- ⑦ A DSL/ADSL filter (not supplied) is required if you have a DSL/ADSL service.

Note:

- Use only the supplied Panasonic AC adaptor PNLV226CE.
- Use only the supplied telephone line cord.

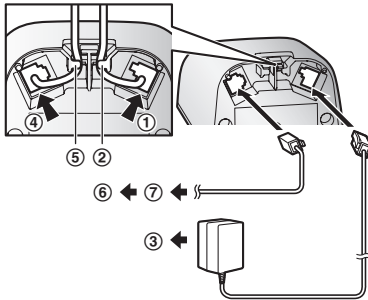

Battery installation

- USE ONLY rechargeable Ni-MH batteries AAA (R03) size (①).
- Do NOT use Alkaline/Manganese/Ni-Cd batteries.

- Confirm correct polarities (⊕, ⊖).

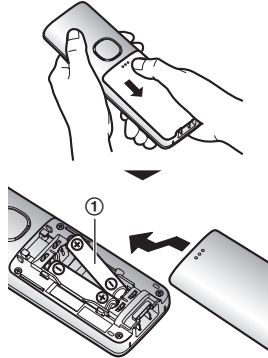

- Follow the directions on the display to set up the unit.

Battery charging

Charge for about 7 hours.

- Confirm "Charging" is displayed (①).
- When the batteries are fully charged, "Fully charged" is displayed.

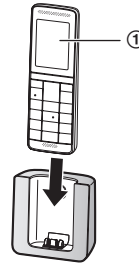

Note when setting up

Note for connections

- The AC adaptor must remain connected at all times. (It is normal for the adaptor to feel warm during use.)
- The AC adaptor should be connected to a vertically oriented or floor-mounted AC

Getting Started

outlet. Do not connect the AC adaptor to a ceiling-mounted AC outlet, as the weight of the adaptor may cause it to become disconnected.

During a power failure

The unit will not work during a power failure. We recommend connecting a corded-type telephone (without AC adaptor) to the same telephone line or to the same telephone line jack, if you have such a telephone jack in your house.

Note for battery installation

- Use the supplied rechargeable batteries. For replacement, we recommend using the Panasonic rechargeable batteries noted on page 3, 6.

Note for battery charging

- It is normal for the handset to feel warm during charging.
- Clean the charge contacts of the handset, base unit, and charger with a soft and dry cloth once a month. Before cleaning the unit, disconnect from power outlets and any telephone line cords. Clean more often if the unit is exposed to grease, dust, or high humidity.

Battery level

Icon	Battery level
	High
	Medium
	Low
	Needs charging.

Panasonic Ni-MH battery performance (supplied batteries)

Operation	Operating time
In continuous use	12 hours max.
Not in use (standby)	150 hours max.

Note:

- Actual battery performance depends on usage and ambient environment.

Controls

Handset

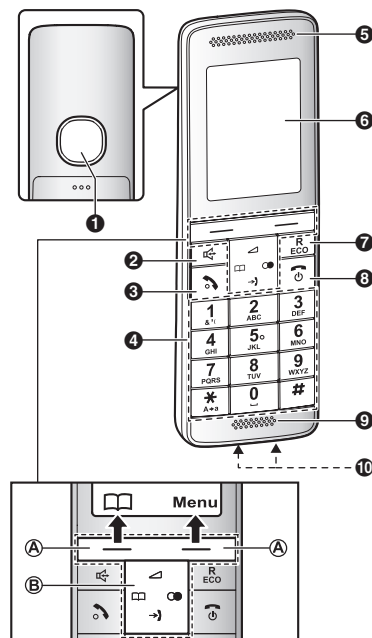

- Speaker
- (Speakerphone)
- (Talk)
- Dial keypad
- Receiver
- Display
- R/ECO**
R: Recall/Flash
ECO: Eco mode shortcut key
- (Off/Power)

- 9 Microphone
- 10 Charge contacts

■ Control type

Ⓐ Soft keys

By pressing a soft key, you can select the feature shown directly above it on the display.

Ⓑ Navigator key

Navigator keys functions as follows.

Symbol	Meaning
[↶]	[▲] Up
[↷]	[▼] Down
[☐]	[◀] Left
[●]	[▶] Right

- [▲], [▼], [◀], or [▶]: Scroll through various lists and items.
- [▲] or [▼] (↶): Adjust the receiver or speaker volume while talking.
- [↷] (Caller list): View the caller list.
- [☐] (Phonebook): View the phonebook entry.
- [●] (Redial): View the redial list.

Base unit

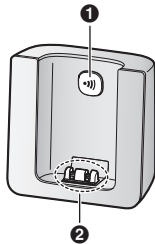

- 1 [📶] (Locator)
 - You can locate a misplaced handset by pressing [📶].
- 2 Charge contacts

Display icons

Handset display items





Item	Meaning
[📶]	Range status: The more bars visible, the closer the handset is to the base unit.
[📶]	Out of base unit range
[📶]	Paging, intercom mode
[📶]	Speakerphone is on. (page 14)
[📶]	The line is in use. <ul style="list-style-type: none"> • When flashing slowly: The call is put on hold. • When flashing rapidly: An incoming call is now being received.
[📶]	Missed call*1 (page 33)
[ECO]	The base unit transmission power is set to "Low". (page 12)
[NR]	Noise reduction is set. (page 15)
[📶]	The key backlight is off. (page 23)
[📶]	Battery level
[📶]	Alarm is on. (page 26)
[📶]	Equalizer is set. (page 15)
[📶]	Privacy mode is on. (page 24)
[📶]	Ringer volume is off. (page 22)
[📶]	Night mode is on. (page 26)
[📶]	Blocked call*1 (page 27)
[📶]	New SMS message received.*2 (page 36)
[📶]	New voice mail message received.*3 (page 38)

Getting Started

Item	Meaning
	Baby monitor is activated. The name/number displayed next to the icon indicates the monitoring unit. (page 28)
Line in use	Someone is using the line.

- *1 Caller ID subscribers only
- *2 SMS users only
- *3 Voice mail subscribers only

Handset soft key icons

Icon	Action
	Temporarily turns off the ringer for incoming calls. (page 14)
	Opens the phonebook.
	Selects entries or handsets. (page 26)
	Erases a number/character.
	Puts the call on mute.

Turning the power on/off

Press  for about 2 seconds.

Language setting

Display language

- 1 **[Menu]** (right soft key) **#1110**
- 2 **[↓]**: Select your desired language. → **[OK]**
- 3 ****

Date and time



- 1 **[Menu]** (right soft key) **#1101**

- 2 Enter the current date, month, and year.
→ **[OK]**
Example: 15 July, 2013
1 **5** **0** **7** **1** **3**
 - You can select the date format by pressing **[#]**:
 - dd/mm/yy (date/month/year)
 - yy/mm/dd
- 3 Enter the current hour and minute.
Example: 9:30
0 **9** **3** **0**
 - You can select 24-hour or 12-hour clock format (“**AM**” or “**PM**”) by pressing **[#]**.
- 4 **[OK]** → ****

Other settings

Screen saver mode

The backlight goes dark when on a call or turns off completely after 1 minute of inactivity if the handset is not on the base unit or charger.

- Activate the handset display again by:
- pressing **** when on a call.
 - pressing **** at all other times.

One touch eco mode

When the handset is on the base unit, the base unit transmission power is reduced up to 99.9 % if only one handset is registered. Even when the handset is not on the base unit or several handsets are registered, the base unit transmission power in standby mode can be reduced up to 90 % by activating one touch eco mode.

You can turn on/off one touch eco mode by just pressing **[R/ECO]**. The default setting is “**Normal**”.

- When the one touch eco mode is on: “**Low**” is temporarily displayed and **ECO** is shown on the handset display instead of **Y**.
- When the one touch eco mode is off: “**Normal**” is temporarily displayed and **ECO** goes off from the handset display.

Note:

- When there is another cordless phone nearby and it is in use, the base unit transmission power may not be reduced.
- Activating one touch eco mode reduces the range of the base unit in standby mode.
- If you set the DECT repeater mode to “On” (page 32):
 - One touch eco mode is cancelled.
 - “Eco Setup” is not shown in the display menu (page 23).

Dialling mode

If you cannot make calls, change this setting according to your telephone line service. The default setting is “Tone”.

“Tone”: For tone dial service.

“Pulse”: For rotary/pulse dial service.

- 1 **[Menu]** (right soft key) **[#120]**
- 2 **[↓]**: Select the desired setting.
- 3 **[OK]** → **[⏻]**

Making/Answering Calls

Making calls

- 1 Lift the handset and dial the phone number.
 - To correct a digit, press [C].
- 2 Press [↶].
- 3 When you finish talking, press [↶] or place the handset on the base unit or charger.

Using the speakerphone

- 1 Dial the phone number and press [📞].
- 2 When you finish talking, press [↶].

Note:

- To switch back to the receiver, press [📞]/[↶].

Adjusting the receiver or speaker volume

Press [▲] or [▼] repeatedly while talking.

Making a call using the redial list

The last 10 phone numbers dialled are stored in the redial list (each 24 digits max.).

- 1 [📞]
- 2 [↕]: Select the desired phone number.
- 3 [↶]/[📞]
 - If [📞] is pressed and the other party's line is engaged, the unit automatically redials multiple times.

Erasing a number in the redial list

- 1 [📞]
- 2 [↕]: Select the desired phone number.
→ [Erase]
- 3 [↕]: "Yes" → [OK] → [↶]

Pause (for PBX/long distance service users)

A pause is sometimes required when making calls using a PBX or long distance service. When storing a calling card access number

and/or PIN in the phonebook, a pause is also needed (page 18).

Example: If you need to dial the line access number "0" when making outside calls with a PBX:

- 1 [0] → [▲] (Pause)
- 2 Dial the phone number. → [↶]

Note:

- A 3 second pause is inserted each time [▲] (Pause) is pressed.

Answering calls

- 1 Lift the handset and press [↶] or [📞] when the unit rings.
- 2 When you finish talking, press [↶] or place the handset on the base unit or charger.

Any key answer: You can answer the call by pressing any dial key.

Auto talk: You can answer calls simply by lifting the handset (page 23).

Temporary ringer off: You can turn the ringer off temporarily by pressing [📞].

Adjusting the handset ringer volume

Press [▲] or [▼] repeatedly to select the desired volume while ringing.

Useful features during a call

Hold

- 1 Press [Menu] during an outside call.
- 2 [↕]: "Hold" → [OK]
- 3 To release hold, press [↶].

Note:

- After holding for 10 minutes, the call is disconnected.

Mute

- 1 Press **[M]** during a call.
- 2 To return to the call, press **[M]**.

Recall/flash

[R/ECO] allows you to use the special features of your host PBX such as transferring an extension call, or accessing optional telephone services.

Note:

- To change the recall/flash time, see page 24.

For call waiting or Call Waiting Caller ID service users

To use call waiting or Call Waiting Caller ID, you must first subscribe with your service provider/telephone company. This feature allows you to receive calls while you are already talking on the phone. If you receive a call while on the phone, you will hear a call waiting tone.

If you subscribe to both **Caller ID** and **Call Waiting with Caller ID services**, the 2nd caller's information is displayed after you hear the call waiting tone on the handset.

- 1 Press **[R/ECO]** to answer the 2nd call.
- 2 To switch between calls, press **[R/ECO]**.

Note:

- Please contact your service provider/telephone company for details and availability of this service in your area.

Temporary tone dialling (for rotary/pulse service users)

Press **[*]** before entering access numbers which require tone dialling.

Handset noise reduction

This feature allows you to hear the voice of the person you are talking to clearly, by

reducing the surrounding noise coming from the other party's telephone.

- 1 Press **[Menu]** while talking.
- 2 **[↕]**: "Noise Reduction On" or "Noise Reduction Off" → **[OK]**

Note:

- Depending on the environment where this handset is being used, this feature may not be effective.
- This feature is not available using the speakerphone.

Handset equalizer

This feature clarifies the voice of the person you are talking to, producing a more natural-sounding voice that is easier to hear and understand.

- 1 Press **[Menu]** while talking.
- 2 **[↕]**: "Equalizer" → **[OK]**
- 3 **[↕]**: Select the desired setting.
- 4 Press **[OK]** to exit.

Note:

- Depending on the condition and quality of your telephone line, this feature may emphasise existing line noise. If it becomes difficult to hear, turn this feature off.
- This feature is not available while using the speakerphone.

Call share

You can join an existing outside call. To join the conversation, press **[Join]** when the other handset is on an outside call.

Note:

- To prevent other users from joining your conversations with outside callers, turn the privacy mode on (page 24).

Transferring calls, conference calls

Outside calls can be transferred between 2 handsets in the same radio cell.

Making/Answering Calls

2 handsets in the same radio cell can have a conference call with an outside party.

- 1 During an outside call, press **[Menu]** to put the call on hold.
- 2 **[↕]**: "Intercom" → **[OK]**
- 3 **[↕]**: Select the desired unit. → **[OK]**
- 4 Wait for the paged party to answer.
 - If the paged party does not answer, press **[Back]** to return to the outside call.
- 5 **To complete the transfer:**
Press **[↵]**.
To establish a conference call:
[Menu] → **[↕]**: "Conference" → **[OK]**
 - To leave the conference, press **[↵]**. The other 2 parties can continue the conversation.
 - To put the outside call on hold:
[Menu] → **[↕]**: "Hold" → **[OK]**
To resume the conference: **[Menu]** → **[↕]**: "Conference" → **[OK]**
 - To cancel the conference: **[Menu]** → **[↕]**: "Stop Conference" → **[OK]**
You can continue the conversation with the outside caller.

Intercom

Intercom calls can be made between handsets in the same radio cell.

Note:

- When paging the handset, the paged handset beeps for 1 minute.
- If you receive an outside call while talking on the intercom, you hear 2 tones. To answer the call, press **[↵]**, then press **[↶]**.

Making an intercom call

- 1 **[Menu]** (right soft key) → **[Intercom]**
- 2 **[↕]**: Select the desired unit. → **[OK]**
- 3 When you finish talking, press **[↵]**.

Answering an intercom call

- 1 Press **[↶]** to answer the page.
- 2 When you finish talking, press **[↵]**.

Turning auto intercom on/off

This feature allows the handset to answer intercom calls automatically when it is called. You do not need to press **[↶]**. When this feature is set to "On", the monitoring handset for the baby monitor feature (page 29) will also answer baby monitor calls automatically. The default setting is "off".

- 1 **[Menu]** (right soft key) **[#]** **[2]** **[7]** **[3]**
- 2 **[↕]**: Select the desired setting. → **[OK]** → **[↵]**

Key lock

The handset can be locked so that no calls or settings can be made. Incoming calls can be answered, but all other functions are disabled while key lock is on.

To turn key lock on, press **[Menu]** (right soft key) for about 3 seconds.

- To turn key lock off, press **[Key lock]** (right soft key) for about 3 seconds.

Note:

- Calls to emergency numbers cannot be made until key lock is turned off.

Phonebook

You can add 300 names (16 characters max.) and phone numbers (24 digits max.) to the phonebook, and assign each phonebook entry to the desired category.

The total number of entries that can be stored varies depending on how many phone numbers you have stored for each entry. Total number of entries is shown below*1:
 1 name + 1 phone number: 300 entries
 1 name + 2 phone numbers: 150 entries
 1 name + 3 phone numbers: 100 entries

*1 Up to 3 phone numbers for each entry can be stored.

Important:

- All entries can be shared by any registered handset.

Adding phonebook entries

- 1 [OK] → [Menu]
- 2 [↕]: "New Entry" → [OK]
- 3 [↕]: "(Name)" → [Select]
- 4 Enter the party's name. → [OK]
 - You can change the character entry mode by pressing [R/ECO] (page 38).
- 5 [↕]: "(Phone No. 1)" → [Select]
 - You can store up to 3 phone numbers for each entry.
- 6 Enter the party's phone number. → [OK]
- 7 [↕]: "Category 1" → [Select]
- 8 [↕]: Select the desired category. → [OK]
- 9 [Save] → [⏻]

Storing a redial list number to the phonebook

- 1 [●]
- 2 [↕]: Select the desired phone number. → [Detail] → [Save]
- 3 To store the name, continue from step 3, "Editing entries", page 18.

Storing caller information to the phonebook

- 1 [→]
- 2 [↕]: Select the desired entry. → [Detail] → [Menu]
- 3 [↕]: "Save CID" → [OK]
- 4 [↕]: "Phonebook" → [OK]
- 5 To store the name, continue from step 3, "Editing entries", page 18.

Categories

Categories can help you find entries in the phonebook quickly and easily. You can change the names of categories ("Friends", "Family", etc.). By assigning different ringer tones for different categories of callers, you can identify who is calling (category ringer tone), if you have subscribed to Caller ID service.

Changing category names/setting category ringer tone

- 1 [OK] → [Menu]
- 2 [↕]: "Category" → [OK]
- 3 [↕]: Select the desired category. → [OK]
- 4 **To change category names**
 [↕]: "Category Name" → [OK] → Edit the name (10 characters max.; page 38). → [OK]
To set category ringer tone
 [↕]: Select the current setting of the category ringer tone. → [OK] → [↕]: Select the desired ringer tone. → [OK]
- 5 [⏻]

Finding and calling from a phonebook entry

- 1 [OK]
- 2 **To scroll through all entries**
 [↕]: Select the desired entry. → [↶]
To search by first character

Phonebook

- ① Press the dial key (**[0]** to **[9]**, or **[#]**) which contains the character you are searching for (page 38).
- ② **[↕]**: Scroll through the phonebook if necessary. → **[↶]**

To search by query

- ① **[☒]** → To search for the name, enter the first characters (up to 4) in uppercase (page 38). → **[OK]**
- ② **[↕]**: Scroll through the phonebook if necessary. → **[↶]**

To search by category

- ① **[Search]** → **[↕]**: "Category" → **[OK]**
 - ② **[↕]**: Select the desired category. → **[OK]**
 - ③ **[↕]**: Scroll through the phonebook if necessary. → **[↶]**
- 3 **[↕]**: Select the desired phone number. → **[↶]**

Editing entries

- 1 Find the desired entry (page 17). → **[Menu]**
- 2 **[↕]**: "Edit" → **[OK]**
- 3 **[↕]**: Select the desired item you want to change. → **[Select]**
- 4 **To change the name and phone number:**
Edit the name or phone number. → **[OK]**
To change the category:
[↕]: Select the desired category. → **[OK]**
- 5 **[Save]** → **[↶]**

Erasing entries

Erasing an entry

- 1 Find the desired entry (page 17). → **[Menu]**
- 2 **[↕]**: "Erase" → **[OK]**
- 3 **[↕]**: "Yes" → **[OK]** → **[↶]**

Erasing all entries

- 1 **[☐]** → **[Menu]**

- 2 **[↕]**: "Erase All" → **[OK]**
- 3 **[↕]**: "Yes" → **[OK]**
- 4 **[↕]**: "Yes" → **[OK]** → **[↶]**

Chain dial

This feature allows you to dial phone numbers in the phonebook while you are on a call. This feature can be used, for example, to dial a calling card access number or bank account PIN that you have stored in the phonebook, without having to dial manually.

- 1 During an outside call, press **[Menu]**.
- 2 **[↕]**: "Phonebook" → **[OK]**
- 3 **[↕]**: Select the desired entry. → **[Call]**
- 4 **[↕]**: Select the desired phone number.
- 5 Press **[Call]** to dial the number.

Note:

- When storing a calling card access number and your PIN in the phonebook as one phonebook entry, press **[▲]** (Pause) to add pauses after the number and PIN as necessary (page 14).
- If you have rotary/pulse service, you need to press **[☒]** before pressing **[Menu]** in step 1 to change the dialling mode temporarily to tone. When adding entries to the phonebook, we recommend adding **[☒]** to the beginning of phone numbers you wish to chain dial (page 17).

Speed dial

You can assign 1 phone number to each of the dial keys (**[1]** to **[9]**) on the handset.

Adding phone numbers to speed dial keys

■ By entering phone numbers:

- 1 Press and hold the desired speed dial key (**[1]** to **[9]**). → **[Add]**
- 2 **[↕]**: "Manual" → **[OK]**

- 3 Enter the party's name (16 characters max.; page 38). → **[OK]**
- 4 Enter the party's phone number (24 digits max.). → **[OK]** 2 times → **[⏏]**

■ From the phonebook:

- 1 Press and hold the desired speed dial key (**[1]** to **[9]**). → **[Add]**
- 2 **[↕]**: "Phonebook" → **[OK]**
- 3 **[↕]**: Select the desired entry. → **[OK]**
- 4 **[↕]**: Select the desired phone number.
- 5 **[OK]** → **[⏏]**

Note:

- If you edit a phonebook entry which is assigned to a speed dial key, the edited entry does not transfer to the speed dial key.

Editing an entry

- 1 Press and hold the desired speed dial key (**[1]** to **[9]**). → **[Menu]**
- 2 **[↕]**: "Edit" → **[OK]**
- 3 Edit the name if necessary. → **[OK]**
- 4 Edit the phone number if necessary. → **[OK]** 2 times → **[⏏]**

Erasing an entry

- 1 Press and hold the desired speed dial key (**[1]** to **[9]**). → **[Menu]**
- 2 **[↕]**: "Erase" → **[OK]**
- 3 **[↕]**: "Yes" → **[OK]** → **[⏏]**

Viewing an entry/Making a call

- 1 Press and hold the desired speed dial key (**[1]** to **[9]**).
- 2 To make a call, press **[⏏]**.

Programming

Menu list

To access the features, there are 2 methods.

■ Scrolling through the display menus

- 1 **[Menu]** (right soft key)
- 2 Press **[▼]**, **[▲]**, **[▶]**, or **[◀]** to select the desired main menu. → **[OK]**
- 3 Press **[▼]** or **[▲]** to select the desired item from the next sub-menus. → **[OK]**
- 4 Press **[▼]** or **[▲]** to select the desired setting. → **[OK]**

■ Using the direct command code

- 1 **[Menu]** (right soft key) → Enter the desired code.
Example: Press **[Menu]** (right soft key) **#1101**.
- 2 Select the desired setting. → **[OK]**

Note:

- To exit the operation, press **[⏻]**.
- In the following table, < > indicates the default settings.
- In the following table,  indicates the reference page number.
- Display menu order and sub-menu may vary depending on your model.

Display the menu tree and direct command code table

Main menu:  "Caller List"

Operation	Code	
Viewing the caller list.	#213	33

Main menu:  "Ringer Setup"

Sub-menu 1	Sub-menu 2	Settings	Code	
Ringer Volume	–	0-6: Off-6 <6>	#160	–
Ringtone*1	–	<Ringtone 1>	#161	–
Night Mode	On/Off	1: On 0: <Off>	#238	26
	Start/End	<23:00/06:00>	#237	27
	Ring Delay	1: 30 sec. 2: <60 sec.> 3: 90 sec. 4: 120 sec. 0: No Ringing	#239	27
	Select Category	1-9: Category 1-9	#241	27
First Ring*2, *3	–	1: <On> 0: Off	#173	–

Programming

Main menu:  "SMS"

Sub-menu 1	Sub-menu 2	Settings	Code	
Receive List	-	-	#350	36
Send List	-	-		36
Create	-	-		35
Settings	Message Centre1 ^{*2, *4}	-	#351	35
	Message Centre2 ^{*2, *4}	-	#352	35
	PBX Access # ^{*2}	<Off>	#356	37
	SMS On/Off ^{*2, *5}	<Off>	#357	35

Main menu:  "Intercom"

Operation	Code	
Paging the desired unit.	#274	16

Main menu:  "Time Settings"

Sub-menu 1	Sub-menu 2	Settings	Code	
Set Date/Time ^{*2}	-	-	#101	12
Memo Alarm	1-5: Alarm1-5	1: Once 2: Daily 3: Weekly 0: <Off>	#720	26
Time Adjustment ^{*2, *6}	-	1: Caller ID 0: <Manual>	#226	-

Programming

Main menu:  "Initial Setup"

Sub-menu 1	Sub-menu 2	Settings	Code	
Ringer Setup	Ringer Volume	0-6: Off-6 <6>	#160	-
	Ringtone ^{*1}	<Ringtone 1>	#161	-
	Night Mode - On/Off	1: On 0: <Off>	#238	26
	Night Mode - Start/End	<23:00/06:00>	#237	27
	Night Mode - Ring Delay	1: 30 sec. 2: <60 sec.> 3: 90 sec. 4: 120 sec. 0: No Ringing	#239	27
	Night Mode - Select Category	1-9: Category 1-9	#241	27
	First Ring ^{*2, *3}	1: <On> 0: Off	#173	-
Time Settings	Set Date/Time ^{*2}	-	#101	12
	Memo Alarm - 1-5: Alarm1-5	1: Once 2: Daily 3: Weekly 0: <Off>	#720	26
	Time Adjustment ^{*2, *6}	1: Caller ID 0: <Manual>	#226	-
Handset Name	-	-	#104	29
Key Finder Setup ^{*7} - 1: Add new device (for Finder1) ^{*8} - 2: Add new device (for Finder2) - 3: Add new device (for Finder3) - 4: Add new device (for Finder4)	Change Name ^{*2}	Finder1	#6561	-
		Finder2 ^{*9}	#6562 ^{*10}	
		Finder3 ^{*9}	#6563 ^{*10}	
		Finder4 ^{*9}	#6564 ^{*10}	
	Register	-	#6571	-
		-	#6572 ^{*10}	
		-	#6573 ^{*10}	
		-	#6574 ^{*10}	
	Cancel Register	-	#6581	-
		-	#6582 ^{*10}	
-		#6583 ^{*10}		
-		#6584 ^{*10}		
Caller Barred ^{*2}	-	-	#217	27

Programming

Sub-menu 1	Sub-menu 2	Settings	Code	
Speed Dial	–	–	#261	18
Eco Setup	Transmission Power ^{*2}	1: <Normal> 2: Low	#725	12
Display Setup	Wallpaper	<Wallpaper1>	#181	–
	Clock ^{*11}	1: Analogue (Small) 2: Analogue (Large) 3: <Digital (Large)> 4: Digital (Small) 0: Off	#198	–
	Display Colour	1: <Colour1> 2: Colour2	#182	–
	Display Mode ^{*12}	1: <Multi Items> 0: Single Item	#192	–
	Key Backlight	1: <On> 0: Off	#276	–
	LCD in charging ^{*13} (LCD backlight)	1: <On> 0: Off	#191	–
	Contrast (Display contrast)	1-6: Contrast 1-6 <Contrast 3>	#145	–
Auto Intercom	–	1: On 0: <Off>	#273	16
Keytones	–	1: <On> 0: Off	#165	–
Call Restrict ^{*2}	–	–	#256	30
Auto Talk ^{*14}	–	1: On 0: <Off>	#200	14

Programming

Sub-menu 1	Sub-menu 2	Settings	Code	
Line Setup	Dial Mode ^{*2}	1: Pulse 2: <Tone>	#120	13
	Recall/Flash ^{*2, *15, *16}	0: 900 msec. 1: 700 msec. 2: <600 msec.> 3: 400 msec. 4: 300 msec. 5: 250 msec. *: 200 msec. #: 160 msec. 6: 110 msec. 7: 100 msec. 8: 90 msec. 9: 80 msec.	#121	15
Privacy Mode ^{*2, *17}	–	1: On 0: <Off>	#194	–
Base Unit PIN ^{*2}	–	<0000>	#132	30
DECT Repeater ^{*2}	–	1: On 0: <Off>	#138	32
Register	Register H.set	–	#130	31
	Cancel Register ^{*18}	–	#131	32
Country ^{*2}	–	1: <Other> 2: Česká rep. 3: Slovensko	#136	30
Select Base	–	<Auto>	#137	32
Cancel Base ^{*18}	–	–	#139	32
Language	Display	<English>	#110	12

Main menu:  "Baby Monitor"

Sub-menu 1	Sub-menu 2	Settings	Code	
On/Off	–	1: On 0: <Off>	#268	28
Sensitivity Level	–	1: Low 2: <Middle> 3: High	#269	29

Main menu:  "Calendar"

Operation	Code	
Viewing the calendar and setting the schedule alarm.	#727	30

Programming

Main menu:  "Key Finder"^{*7}

Sub-menu 1	Sub-menu 2	Settings	Code	
Search	—	—	#655	—
Battery Check	—	—		

Main menu:  "Caller Barred"^{*2, *19}

Operation	Code	
Storing/Viewing bar call numbers.	#217	27

- *1 The preset melodies in this product ("Ringtone 3" - "Ringtone 40") are used with permission of © 2012 Copyrights Vision Inc.
- *2 If you program these settings using one of the handsets, you do not need to program the same item using another handset.
- *3 If you do not want the unit to ring before the caller information is received, set to "OFF". (Caller ID subscribers only)
You can only remove the first ring if the unit rings 2 times or more by default, which depends on your service provider/telephone company.
- *4 If you select the unit's region setting (page 30) to "Česká rep." or "Slovensko", the default setting will be changed for the selected country.
- *5 If you select the unit's region setting (page 30) to "Česká rep." or "Slovensko", the default setting is "On".
- *6 This feature allows the unit to automatically adjust the date and time each time caller information including date and time is received.
To turn this feature on, select "Caller ID". To turn this feature off, select "Manual". (Caller ID subscribers only)
To use this feature, set the date and time first (page 12).
- *7 This setting is available when you have the key finder (KX-TGA20FX). Read the installation manual for more information on the key finder.
- *8 For models with supplied key finders, the display shows "1:Finder1".
- *9 If you register 2 or more key finders.
- *10 If you have 2 or more key finders.
- *11 Wallpaper is displayed in the standby mode only when you select "Digital (Small)" or "OFF" for this setting.
- *12 You can select to display either a single item or multiple items on one screen at a time for the handset main menu icons in function menu, phonebook list, caller list, and redial list.
- *13 You can set the handset display backlight while on charge.
 - "On": Backlight is on (dimmed).
 - "OFF": Backlight turns off after 10 seconds of charging.
- *14 If you subscribe to a Caller ID service and want to view the caller's information after lifting up the handset to answer a call, turn off this feature.
- *15 The recall/flash time depends on your telephone exchange or host PBX. Contact your PBX supplier if necessary.
- *16 The default setting will be as follows if you select the following regional codes when changing the unit's region setting (page 30):
"Česká rep." = "100 msec."
"Slovensko" = "100 msec."
- *17 To prevent other users from joining your conversations with outside callers, turn this feature on.

Programming

- *18 This menu is not displayed when scrolling through the display menus. It is only available in direct command code.
- *19 This menu icon is displayed when the key finder is not registered.

Alarm

An alarm sounds at the set time for 1 minute and is repeated 5 times at 5 minute intervals (snooze function). A text memo can also be displayed for the alarm. A total of 5 separate alarm times can be programmed for each handset. You can set one of 3 different alarm options (once, daily, or weekly) for each alarm time.

Important:

- Make sure the unit's date and time setting is correct (page 12).

- 1 **[Menu]** (right soft key) **[#][7][2][0]**
- 2 Select an alarm by pressing **[1]** to **[5]**. → **[OK]**
- 3 **[↕]**: Select the desired alarm option. → **[OK]**

"Off"	Turns alarm off. Go to step 9.
"Once"	An alarm sounds once at the set time.
"Daily"	An alarm sounds daily at the set time. Go to step 5.
"Weekly"	Alarm sounds weekly at the set time(s).

- 4 Proceed with the operation according to your selection in step 3.
 - **Once:**
Enter the desired date and month. → **[OK]**
 - **Weekly:**
[↕]: Select the desired day of the week and press **[✓]**. → **[OK]**
- 5 Set the desired time. → **[OK]**
- 6 Enter a text memo (30 characters max.). → **[OK]**

- 7 **[↕]**: Select the desired alarm tone. → **[OK]**

- We recommend selecting a different ringer tone from the one used for outside calls.

- 8 **[↕]**: Select the desired snooze setting. → **[OK]**

- 9 **[OK]** → **[⏏]**

Note:

- Press **[Stop]** to stop the alarm completely.
- When the handset is in use, the alarm will not sound until the handset is in standby mode.
- Press any dial key or **[Snooze]** to stop the sound but keep the snooze function activated.
- If you want to make an outside call when the snooze function is activated, please stop the snooze function before making the call.

Night mode

Night mode allows you to select a period of time during which the handset will not ring for outside calls. This feature is useful for time periods when you do not want to be disturbed, for example, while sleeping. Night mode can be set for each handset.

Important:

- Make sure the unit's date and time setting is correct (page 12).
- If you have set the alarm, the alarm sounds even if the night mode is turned on.

Turning night mode on/off

- 1 **[Menu]** (right soft key) **[#][2][3][8]**
- 2 **[↕]**: Select the desired setting. → **[OK]**
 - If you select "off", press **[⏏]** to exit.

- 3 Enter the desired hour and minute you wish to start this feature. → [OK]
- 4 Enter the desired hour and minute you wish to end this feature. → [OK] → [⏻]

Changing the start and end time

- 1 [Menu] (right soft key) [#][2][3][7]
- 2 Continue from step 3, "Turning night mode on/off", page 26.

Setting the ring delay

This setting allows the handset to ring during night mode if the caller waits long enough. After the selected amount of time passes, the handset rings. If you select "No Ringing", the handset never rings during night mode.

- 1 [Menu] (right soft key) [#][2][3][9]
- 2 [↕]: Select the desired setting. → [OK] → [⏻]

Selecting categories to bypass night mode

- 1 [Menu] (right soft key) [#][2][4][1]
- 2 Select your desired categories by pressing [1] to [9].
 - "✓" is displayed next to the selected category numbers.
 - To cancel a selected category, press the same dial key again. "✓" disappears.
- 3 [OK] → [⏻]

Incoming call barring

This feature allows the unit to reject calls from specified phone numbers that you do not want to answer such as junk calls.

When a call is received, the unit does not ring while the caller is being identified. If the phone number matches an entry in the call barred list, the unit emits no sound to the caller, and disconnects the call. (Caller ID subscribers only)

Important:

- When the unit receives a call from a number that is stored in the call barred list, the call is logged in the caller list (page 33) with ✖ after the call is disconnected.

Storing unwanted callers

You can store up to 100 phone numbers in the call barred list.

Important:

- You must store the phone number with an area code in the call barred list.

■ From the caller list:

- 1 [→]
- 2 [↕]: Select the entry to be barred. → [Detail] → [Menu]
- 3 [↕]: "Save CID" → [OK]
- 4 [↕]: "Caller Barred" → [OK]
- 5 [↕]: "Yes" → [OK] → [⏻]

■ By entering phone numbers:

- 1 [Menu] (right soft key) [#][2][1][7] → [Add]
- 2 Enter the phone number (24 digits max.). → [OK]
- 3 [⏻]

Viewing/editing/erasing bar call numbers

- 1 [Menu] (right soft key) [#][2][1][7]
- 2 [↕]: Select the desired entry.
 - To exit, press [⏻].
- 3 To edit a number: [Edit] → Edit the phone number. → [OK] → [⏻]
 To erase a number: [Erase] → [↕]: "Yes" → [OK] → [⏻]

Programming

Baby monitor

This feature allows you to listen in on a room where another handset is located, allowing you to easily monitor from different areas of the house or place. The monitored handset (placed in a baby's room, for example) will automatically call the monitoring handset or the phone number stored when it detects sound.

Important:

- You should perform a test run of the baby monitor procedure to ensure that the baby monitor feature is set correctly. For example, test its sensitivity. Check the connection if you are diverting the baby monitor to an outside line.

Note:

- Both the monitored and monitoring handsets must select the same base unit in order to use the baby monitor feature (page 32).
- If the unit is connected to a PBX system, you cannot set the baby monitor.
- During the monitoring mode, battery consumption is faster than usual. We recommend leaving the monitored handset on the base unit or charger.
- The monitored handset never rings during the monitoring mode.

Setting the baby monitor

Perform the setting operation with the handset to be monitored (for example, the handset placed in a baby's room).

To monitor with a handset

The internal baby monitor feature is only available between handsets in the same radio cell.

- 1 **[Menu]** (right soft key) **# [2] [6] [8]**
- 2 **[↕]**: "On" → **[OK]**
- 3 **[↕]**: Select the desired handset number to monitor with. → **[OK]**
 - "Baby Monitor" will be displayed.

- The registered handset name/number is displayed.

Note:

- When this feature is on, another handset can hear the monitored handset by making an intercom call.

To monitor from an outside line

■ From the phonebook:

- 1 **[Menu]** (right soft key) **# [2] [6] [8]**
- 2 **[↕]**: "On" → **[OK]**
- 3 **[↕]**: Select "External" to monitor from an outside line. → **[Edit]** → **[Add]**
- 4 **[↕]**: "Phonebook" → **[OK]**
- 5 **[↕]**: Select the phonebook entry. → **[OK]**
- 6 **[↕]**: Select the desired phone number. → **[OK]**
 - "Baby Monitor" will be displayed.

Note:

- If you edit a phonebook entry which is assigned for monitoring, the edited entry does not transfer to the monitor.

■ By entering phone numbers:

- 1 **[Menu]** (right soft key) **# [2] [6] [8]**
- 2 **[↕]**: "On" → **[OK]**
- 3 **[↕]**: Select "External" to monitor from an outside line. → **[Edit]** → **[Add]**
- 4 **[↕]**: "Manual" → **[OK]**
- 5 Enter the desired name. → **[OK]**
- 6 Enter the desired number. → **[OK]** 2 times
 - "Baby Monitor" will be displayed.

Note:

- The registered name/number is displayed.

Turning off the baby monitor

The monitored handset cannot be used while baby monitor is set to "On".

- 1 Press **[Menu]** on the handset being monitored.

Programming

- 2 [↕]: "On/Off" → [OK]
- 3 [↕]: "Off" → [OK] → [↵]

Editing an outside monitoring number

- 1 Press [Menu] on the handset being monitored.
- 2 [↕]: "On/Off" → [OK]
- 3 [↕]: "On" → [OK]
- 4 [↕]: Select the outside line. → [Edit]
- 5 [Menu] → [↕]: "Edit" → [OK]
- 6 Edit the name if necessary. → [OK]
- 7 Edit the phone number if necessary. → [OK] 2 times

Erasing an outside monitoring number

- 1 Press [Menu] on the handset being monitored.
- 2 [↕]: "On/Off" → [OK]
- 3 [↕]: "On" → [OK]
- 4 [↕]: Select the outside line. → [Edit]
- 5 [Menu] → [↕]: "Erase" → [OK]
- 6 [↕]: "Yes" → [OK] → [↵]

Baby monitor sensitivity

You can adjust the sensitivity of the baby monitor. Increase or decrease the sensitivity to adjust the sound level needed to trigger the baby monitor feature.

- This feature cannot be set during a monitoring call.
- 1 Press [Menu] on the handset being monitored.
 - 2 [↕]: "Sensitivity Level" → [OK]
 - 3 [↕]: Select the desired setting. → [OK] → [↵]

Answering the baby monitor

- **When monitoring with a handset:**
Press [↵] to answer calls.

If you want to respond from the monitoring handset, press [↵].

- The monitoring handset will answer calls automatically when the auto intercom feature is set to "On" (page 16).

Note:

- If you receive an outside call when communicating with the monitored handset, you hear 2 tones. To answer the call, press [↵], then press [↵].

- **When monitoring from an outside line:**

To answer a call, follow the operation for your phone.

If you want to respond from the monitoring handset, press [*1] using tone dialling.

You can turn off the baby monitor feature by pressing [*0].

Note:

- 2 minutes after the monitored handset starts a call, communication between the monitored handset and monitoring phone line is turned off automatically.

Other programming

Changing the handset name

Each handset can be given a customised name ("Bob", "Kitchen", etc.). This is useful when you make intercom calls between handsets. You can also select whether or not the handset name is displayed in standby mode. The default setting is "No". If you select "Yes" without entering any handset name, "Handset 1" to "Handset 6" is displayed.

- 1 [Menu] (right soft key) [*1][0][4]
- 2 Enter the desired name (max. 10 characters).
- 3 [OK]
- 4 [↕]: Select the desired setting. → [OK] 2 times → [↵]

Programming

Call restriction

You can restrict selected handsets from dialling certain numbers. You can assign up to 6 phone numbers to be restricted, and select which handsets are to be restricted. Storing area codes here prevents the restricted handsets from dialling any phone number in that area code.

- 1 **[Menu]** (right soft key) **#136**
- 2 Enter the base unit PIN (default: "0000").
 - If you forget your PIN, contact an authorised service centre.
- 3 Select the handsets to be restricted by pressing **1** to **6**.
 - All handsets registered to the base unit are displayed.
 - "✓" is displayed next to the selected handset numbers.
 - To cancel a selected handset, press the same dial key again. "✓" disappears.
- 4 **[OK]**
- 5 Select a memory location by pressing **1** to **6**. → **[OK]**
- 6 Enter the phone number or area code to be restricted (8 digits max.). → **[OK]** → **[↶]**

Changing the base unit PIN

Important:

- If you change the PIN (Personal Identification Number), please make note of your new PIN. The unit will not reveal the PIN to you. If you forget your PIN, contact an authorised service centre.

- 1 **[Menu]** (right soft key) **#132**
- 2 Enter the current 4-digit base unit PIN (default: "0000").
- 3 Enter the new 4-digit base unit PIN. → **[OK]**
- 4 **[↵]**: "Yes" → **[OK]** → **[↶]**

Changing the unit's region setting/Resetting the base unit

- 1 **[Menu]** (right soft key) **#136**
- 2 **[↵]**: Select the desired country. → **[OK]**
"Other" = countries except Czech and Slovakia
"Česká rep." = Czech
"Slovensko" = Slovakia
- 3 **[↵]**: "Yes" → **[OK]** → **[↶]**

Note:

- Changing the unit's region setting may cause the settings for your country or your customised settings to return to their default settings.

Calendar/Schedule

You can program 20 schedule alarms for each handset using the calendar. A schedule alarm sounds at the set time for 1 minute. A text memo can also be displayed for the schedule alarm.

Important:

- Make sure the unit's date and time setting is correct (page 12).

Adding a new entry

- 1 **[Menu]** (right soft key) → **☰** → **[OK]**
- 2 **[↵]**: Select the desired date. → **[OK]**
- 3 **[Menu]** → **[↵]**: "New Entry" → **[OK]**
- 4 Edit the date if necessary. → **[OK]**
- 5 Set the desired time. → **[OK]**
- 6 Enter a text memo (30 characters max.; page 38). → **[OK]**
- 7 **[↵]**: Select the desired alarm tone. → **[OK]** 2 times
 - You can select "off" if you prefer not to hear an alarm tone.
 - We recommend selecting a different ringer tone from the one used for outside calls.
- 8 **[↶]**

Note:

- To stop the alarm, press **[Stop]** or place the handset on the base unit or charger.
- When the handset is in use, the alarm will not sound until the handset is in standby mode.

Viewing entries

- 1 **[Menu]** (right soft key) → **☰** → **[OK]**
- 2 To see the entries on the selected date, press **[OK]**.
To see the schedule list, press **[List]**.
 - You can see detailed information about the schedule by pressing **[Menu]**. → **[↕]**: “Detail” → **[OK]**

Editing an entry

- 1 **[Menu]** (right soft key) → **☰** → **[OK]**
- 2 **[List]** → **[↕]**: Select the desired entry.
- 3 **[Menu]** → **[↕]**: “Edit” → **[OK]**
- 4 Edit the date if necessary. → **[OK]**
- 5 Edit the time if necessary. → **[OK]**
- 6 Edit the text memo if necessary (30 characters max.). → **[OK]**
- 7 **[↕]**: Select the desired alarm tone. → **[OK]** 2 times → **[⏻]**

Erasing an entry

Schedule alarm entries are not erased automatically after the schedule alarm sounds. Erase unwanted entries.

- 1 **[Menu]** (right soft key) → **☰** → **[OK]**
- 2 **[List]** → **[↕]**: Select the desired entry.
- 3 **[Menu]** → **[↕]**: “Erase” → **[OK]**
- 4 **[↕]**: “Yes” → **[OK]** → **[⏻]**

Erasing all entries

- 1 **[Menu]** (right soft key) → **☰** → **[OK]**
- 2 **[List]** → **[Menu]**
- 3 **[↕]**: “Erase All” → **[OK]**
- 4 **[↕]**: “Yes” → **[OK]**

- 5 **[↕]**: “Yes” → **[OK]** → **[⏻]**

Registering a unit

Operating additional units

Additional handsets

Up to 6 handsets can be registered to a single base unit.

Important:

- The additional handset model recommended for use with this unit is noted on page 4. If another handset model is used, certain operations may not be available.

Additional base units

Handsets can be registered to up to 4 base units, allowing you to add additional base units and extend the area in which your handset(s) can be used. If a handset moves out of range of its base unit when “Auto” is selected on base unit (page 32), it looks for another base unit to make or receive calls. A base unit and the handsets it communicates with is called a “radio cell”.

Note:

- Calls are disconnected when the handset moves from one radio cell to another.

Registering a handset to a base unit

The supplied handset and base unit are pre-registered. If for some reason the handset is not registered to the base unit (for example, **☹** is displayed even when the handset is near the base unit), re-register the handset.

- 1 **Handset:**
[Menu] (right soft key) **#130**
- 2 **[↕]**: Select a base unit number. → **[OK]**
 - This number is used by the handset as a reference only.
- 3 **Base unit:**
Press and hold **[Ⓜ]** for about 5 seconds.

Programming

- If all registered handsets start ringing, press **[••]** again to stop, then repeat this step.
- 4 Handset:**
[OK] → Wait until “**Base PIN**” is displayed. → Enter the base unit PIN (default: “0000”). → **[OK]**
- If you forget your PIN, contact an authorised service centre.

Selecting a base unit

When “**Auto**” is selected, the handset automatically uses any available base unit it is registered to. When a specific base unit is selected, the handset makes and receives calls using that base unit only. If the handset is out of range of that base unit, no calls can be made.

- 1 [Menu]** (right soft key) **#137**
- 2 [↕]**: Select the desired base unit number, or “**Auto**”. → **[OK]**

Deregistering a handset

A handset can cancel its own registration to the base unit, or other handsets registered to the same base unit. This allows the handset to end its wireless connection with the system.

- 1 [Menu]** (right soft key) **#131**
 - All handsets registered to the base unit are displayed.
- 2 [↕]**: Select the handset you want to cancel. → **[OK]**
- 3 [↕]**: “**Yes**” → **[OK]**
- 4 [↵]**

Cancelling a base unit

A handset can cancel a base unit that it is registered to. This allows the base unit to end its wireless connection with the system.

- 1 [Menu]** (right soft key) **#139**
- 2 [↕]**: Select the base unit you want to cancel. → **[OK]**
- 3 [↕]**: “**Yes**” → **[OK]** → **[↵]**

Increasing the range of the base unit

You can increase the signal range of the base unit by using a DECT repeater. Please use only the Panasonic DECT repeater noted on page 3. Contact your Panasonic dealer for details.

Important:

- Before registering the DECT repeater to this base unit, you must turn the DECT repeater mode on.
- Do not use more than one DECT repeater at a time.

Setting the DECT repeater mode

- 1 [Menu]** (right soft key) **#138**
- 2 [↕]**: Select the desired setting. → **[OK]** → **[↵]**

Registering the DECT repeater (KX-A405) to the base unit

Note:

- Please use a DECT repeater that has not yet been registered to another unit. If the DECT repeater is registered to another unit, deregister it first, referring to the Installation Guide for the DECT repeater.

- 1 Base unit:**
Press and hold **[••]** for about 5 seconds.
- 2 DECT repeater:**
Connect the AC adaptor, then wait until the **i** indicator and **Y** indicator light green.
- 3 Base unit:**
To exit the registration mode, press **[••]**.

Using Caller ID service

Important:

- This unit is Caller ID compatible. To use Caller ID features, you must subscribe to Caller ID service. Contact your service provider/telephone company for details.

Caller ID features

When an outside call is being received, the caller information is displayed.

Caller information for the last 50 callers is logged in the caller list from the most recent call to the oldest.

- If the unit cannot receive caller information, the following is displayed:
 - “**Out of Area**”: The caller dials from an area which does not provide a Caller ID service.
 - “**Private Caller**”: The caller requests not to send caller information.
- If the unit is connected to a PBX system, caller information may not be properly received. Contact your PBX supplier.

Missed calls

If a call is not answered, the unit treats it as a missed call and **[↔]** is displayed. This lets you know if you should view the caller list to see who called while you were away.

Even if only one missed call in the caller list is viewed (page 33), **[↔]** disappears from the display. When you receive another new call, **[↔]** is displayed again.

Note:

- Even when there are unviewed missed calls, **[↔]** disappears from the standby display if the following operation is performed by one of the registered handsets:
 - Being replaced on the base unit or charger.
 - Pressing **[⏻]**.

Phonebook name display

When caller information is received and it matches a phone number stored in the

phonebook, the stored name in the phonebook is displayed and logged in the caller list.

Caller list

Important:

- Make sure the unit's date and time setting is correct (page 12).

Viewing the caller list and calling back

- 1 **[↔]**
- 2 Press **[▼]** to search from the most recent call, or press **[▲]** to search from the oldest call.
 - You can see the detailed information about the caller by pressing **[Detail]** when in multiple display mode.
- 3 To call back, press **[↶]**.
To exit, press **[⏻]**.

Note:

- If the entry has already been viewed or answered, “✓” is displayed.

Editing a caller's phone number

- 1 **[↔]**
- 2 **[↕]**: Select the desired entry. → **[Detail]**
- 3 **[Menu]** → **[↕]**: “**edit**” → **[OK]**
- 4 Edit the number.
- 5 **[↶]**

Erasing selected caller information

- 1 **[↔]**
- 2 **[↕]**: Select the desired entry.
- 3 **[Erase]** → **[↕]**: “**yes**” → **[OK]** → **[⏻]**

Caller ID Service

Erasing all caller information

- 1 [→]
- 2 [Erase] → [↕]: “Yes” → [OK] →
[↶]

SMS (Short Message Service)

Setting up SMS

SMS allows you to send and receive text messages.

Important:

- To use SMS features, you must:
 - subscribe to a Caller ID and/or an appropriate service such as SMS.
 - confirm that SMS is turned on.
 - confirm that the correct message centre numbers are stored.

Contact your service provider/telephone company for details and availability.

Note:

- A total of 22 messages (at 160 characters/message) can be saved. Total number may be more than 22 if length of messages is less than 160 characters/message.
- If the unit is connected to a PBX system, you may not be able to use SMS features.

Turning SMS on/off

- 1 **[Menu]** (right soft key) **#357**
- 2 **[↕]**: Select the desired setting. → **[OK]**
→ **[⏻]**

Storing SMS message centre numbers

SMS message centre numbers must be stored in order to send and receive SMS messages.

For Czech:

The message centre numbers (used for SMS services provided by Telefonica O2) are preprogrammed in this unit. You can change them if necessary.

For Slovakia:

The message centre numbers (used for SMS service provided by Slovak Telecom - T-Com) are preprogrammed in this unit. You can change them if necessary.

- Contact your service provider/telephone company for more information.
- If you change the unit's region setting/reset the base unit, the stored message centre numbers will be deleted or changed

(page 21). In this case, store the numbers again if necessary.

- 1 **To store "Message Centre1":**
[Menu] (right soft key) **#351**
To store "Message Centre2":
[Menu] (right soft key) **#352**
- 2 Edit the number as necessary. → **[OK]**
→ **[⏻]**

Note:

- For PBX users:
 - You need to add the PBX line access number and a dialling pause to the beginning of the Message Centre 1 number.
 - If you only use the Message Centre 1 number for SMS, store the Message Centre 1 number as is (without adding a line access number or dialling pause) to Message Centre 2.

Sending a message

Writing and sending a new message

- 1 **[Menu]** (right soft key) → **[✉]** → **[OK]**
- 2 **[↕]**: "Create" → **[OK]**
- 3 Enter a message. → **[OK]**
 - You can change the character entry mode by pressing **[R/ECO]** (page 38).
- 4 Enter the destination phone number (20 digits max.). → **[OK]** 2 times
 - You can also set the phone number:
 - from the redial list by pressing **[☎]**.
 - from the caller list by pressing **[→]**.
 - from the phonebook by pressing **[□□]**.
- 5 To save the message, select "Yes". → **[OK]**
- 6 To send the message, press **[OK]**.

Note:

- This unit supports SMS messages of up to 612 characters, however, the maximum number of characters you can send or

SMS (Short Message Service)



receive may be limited by your SMS service provider/telephone company. Contact your SMS service provider/telephone company for details.

- If your message contains over 160 characters, the message is a long message and *****Long Text***** is displayed. Your service provider/telephone company may treat long messages differently from other messages. Contact your service provider/telephone company for details.
- If your phone is connected to a PBX, store the PBX line access number (page 37).

Editing/sending a saved message

- 1 **[Menu]** (right soft key) →  → **[OK]**
- 2 **[↕]**: "Send List" → **[OK]**
- 3 **[↕]**: Select the message. → **[OK]**
- 4 **To edit the message:**
[Menu] → **[↕]**: "Edit Message" → **[OK]** → Continue from step 3, "Writing and sending a new message", page 35.
To send the message:
[Menu] → **[↕]**: "Send" → **[OK]** → Press and hold **[C]** to erase all numbers. → Continue from step 4, "Writing and sending a new message", page 35.

Erasing saved messages

- 1 **[Menu]** (right soft key) →  → **[OK]**
- 2 **[↕]**: "Send List" → **[OK]**
- 3 **[↕]**: Select a message. → **[OK]**
- 4 **[Menu]** → **[↕]**: Select "Erase" or "Erase All". → **[OK]**
- 5 **[↕]**: "Yes" → **[OK]** → 

Receiving a message

- When an SMS message is received:
- "Receiving SMS Message" is displayed.
 - a tone is heard (if the handset ringer is turned on).
 -  is displayed with the total number of new (unread) SMS messages.

Reading a received message

- 1 **[Menu]** (right soft key) →  → **[OK]**
- 2 **[↕]**: "Receive List" → **[OK]**
- 3 **[↕]**: Select a message.
 - Messages which have already been read are indicated by a "✓".
 - To erase a message, press **[Menu]**. → **[↕]**: "Erase" → **[OK]** → **[↕]**: "Yes" → **[OK]**
- 4 **[OK]**

Note:

- To call the message sender, press .

Replying to a message

- 1 While reading a received message, press **[Menu]**.
- 2 **[↕]**: "Reply" → **[OK]**
- 3 Enter a message (page 38). → **[OK]**
- 4 Edit the destination phone number if necessary. → **[OK]** 2 times
- 5 Continue from step 5, "Writing and sending a new message", page 35.

SMS options while reading a received message

You can perform the following operations while you are reading a received message.

- **Editing/forwarding a message:**
[Menu] → **[↕]**: "Edit Message"
- **Erasing received messages:**
[Menu] → **[↕]**: Select "Erase" or "Erase All".
- **Storing the sender's number in the phonebook:**
[Menu] → **[↕]**: "Add Phonebook"
- **Editing the sender's number and calling back:**
[Menu] → **[↕]**: "Edit & Call"

SMS (Short Message Service)

Note:

- After performing the above operation, proceed to the next step by following the display messages or pressing soft keys.

Other settings

Storing the PBX line access number (for PBX users only)

Store your PBX line access number (4 digits max.) so that SMS messages are sent properly. When sending SMS messages to entries in the phonebook or redial list, the PBX line access number is deleted. The default setting is "OFF".

- 1 **[Menu]** (right soft key) **[#]** **[3]** **[5]** **[6]**
- 2 **[↓]**: "On" → **[OK]**
- 3 Enter your PBX line access code and a dialling pause, if necessary. → **[OK]** → **[↶]**

Useful Information

Voice mail service

Voice mail is an automatic answering service offered by your service provider/telephone company. After you subscribe to this service, your service provider/telephone company's voice mail system answers calls for you when you are unavailable to answer the phone or when your line is busy. Messages are recorded by your service provider/telephone company, not your telephone.

When you have new messages,  is displayed on the handset if message indication service is available. Please contact your service provider/telephone company for details of this service.

Important:

- If  still remains on the display even after you have listened to new messages, turn it off by pressing and holding **#** for 2 seconds.

Character entry

The dial keys are used to enter characters and numbers. Each dial key has multiple characters assigned to it. The characters that can be entered depend on the character entry mode (page 38).

- Press **[←]** or **[▶]** to move the cursor left or right.
- Press dial keys to enter characters and numbers.
- Press **[C]** to erase the character or number highlighted by the cursor. Press and hold **[C]** to erase all characters or numbers.
- Press **[x]** (A→a) to switch between uppercase and lowercase.
- To enter another character located on the same dial key, press **[▶]** to move the cursor to the next space, then press the appropriate dial key.
- If you do not press any dial key within 5 seconds after entering a character, the character is fixed and the cursor moves to the next space.

Character entry modes

The available character entry modes are Alphabet (ABC), Numeric (0-9), Greek (ABΓ), Extended 1 (AÄÅ), Extended 2 (ŠŠŠ), and Cyrillic (АБВ). For SMS messages, Alphabet (ABC), Numeric (0-9), Greek (ABΓ), and Extended 1 (AÄÅ) modes are available. When in these entry modes except Numeric, you can select which character is entered by pressing a dial key repeatedly.

When the unit displays the character entry screen:

[R/ECO] → **[↑]**: Select a character entry mode. → **[OK]**

Note:

- **␣** in the following tables represents a single space.
- The dial keys with *1, *2, and *3 in the following tables have different character assignment for SMS. See the footnotes with *1, *2, and *3.

Useful Information

Alphabet character table (ABC)

0	1 ^{*1}	2	3	4	5	6	7	8	9	#
_ 0	& ' () * , - . / 1	A B C	D E F	G H I	J K L	M N O	P Q R	T U V	W X Y	#
		2	3	4	5	6	S 7	8	Z 9	
		a b c	d e f	g h i	j k l	m n o	p q r s	t u v	w x y	
		2	3	4	5	6	7	8	z 9	

Numeric entry table (0-9)

0	1	2	3	4	5	6	7	8	9	#
0	1	2	3	4	5	6	7	8	9	#

Greek character table (ABΓ)

0	1 ^{*1}	2	3	4	5	6	7	8	9	#
_ 0	& ' () * , - . / 1	A B Γ	Δ E Z	H Θ I	K Λ M	N Ξ O	Π P Σ	T Υ Φ	Χ Ψ Ω	#
		2	3	4	5	6	7	8	9	

Extended 1 character table (AÄÅ)

0	1 ^{*1}	2	3	4 ^{*2}	5	6	7	8	9 ^{*3}	#
_ 0	& ' () * , - . / 1	A Ä Å	D E È	G Ğ H	J K L	M N Ñ	P Q R	T U Û	W Ŵ X	#
		Ä Å Ä	É Ê Ë	Ì Í Î	5	O Ò Ó	S Ş ß	Ú Û Ü	Ý Þ Z	
		Á Æ B	Ë F 3	Ï Î Ï		Ô Ö Ø	7	Û V 8	9	
		C Ç 2		4		ø 6				
		a à á	d e è	g ğ h	j k l 5	m n ñ	p q r s	t u ù	w Ŵ x	
		â ã ä	é ê ë	ì í î		o ò ó	ş ß 7	ú û ü	ý þ z	
		á æ b	ë f 3	ï î ï		ô ö ø		û v 8	9	
		c ç 2		4		ø 6				

- The following are used for both uppercase and lowercase: ø Ŵ ŷ

Extended 2 character table (ŠŠŠ) (Not available for SMS)

0	1	2	3	4	5	6	7	8	9	#
_ 0	& ' () * , - . / 1	A Á Ä	D Ď È	G Ğ H	J K L	M N Ñ	P Q R	T Ť U	W X Y	#
		Ä B C	É Ě Ě	Í 4	Ł Ł Ł	Ń Ō Ó	Ř Ŕ S	Ú Ů Ů	Ý Ź Z	
		Č Č 2	F 3		5	Ö Ö 6	Š Š 7	ú v 8	Ž Ž Ž	
		a á ä	d ď e	g ğ h	j k l 5	m n ñ	p q r	t ť u	w x y	
		Ä b c	é ě ě	4	ł ł ł	ń ó ó	ř ŕ s	ú ů ů	ý ź z	
		č č 2	f 3			ö ö 6	š š 7	ú v 8	ž ž ž	

Useful Information

- The following are used for both uppercase and lowercase:

À Ç Ę Ł Ł Ł Ń Ŕ Ś Š ů ý Ž Ž Ž

Cyrillic character table (АБВ) (Not available for SMS)

0	1	2	3	4	5	6	7	8	9	#
_ 0 Г	& ' ()	А Б В	Д Е Ж	И Й К	М Н О	Р С Т	Ф Х Ц	Ш Щ	Ъ Э Ю	#
€ I I	* , - .	Г	З	Л	П	У	Ч	Ы Ь	Я	
Ÿ	/ 1	2	3	4	5	6	7	8	9	

*1

1
. @ / : ; * # + - 1 " ' , !
i ? ÷ _ € £ \$ ¥ () [] { } &
% \ ^ ~ < > = □ §

*2

4
G Ğ H I İ İ İ İ İ İ 4
g ğ h i i i i i i 4

*3

9
W X Y Z 9
w x y z 9

Error messages

Display message	Cause/solution
Base no power or No link to base. Reconnect main base AC adaptor.	<ul style="list-style-type: none"> The handset has lost communication with the base unit. Move closer to the base unit and try again. Unplug the base unit's AC adaptor to reset the unit. Reconnect the adaptor and try again. The handset's registration may have been cancelled. Re-register the handset (page 31).
Check Phone Line	<ul style="list-style-type: none"> The supplied telephone line cord has not been connected yet or not connected properly. Check the connections (page 9).
Invalid Number	<ul style="list-style-type: none"> You tried to send an SMS message to a phone number saved in the phonebook, caller list, or redial list that is over 20 digits long.
Memory Full	<ul style="list-style-type: none"> The phonebook memory is full. Erase unwanted entries (page 18). The call barred list memory is full. Erase unwanted entries (page 27). The schedule alarm memory is full. Erase unwanted entries (page 31). The maximum number of base units (4) is already registered to the handset. Cancel unused base unit registrations from the handset (page 32).
Use rechargeable battery.	<ul style="list-style-type: none"> A wrong type of battery such as Alkaline or Manganese was inserted. Use only the rechargeable Ni-MH batteries noted on page 3, 6.



Useful Information

Display message	Cause/solution
You must first subscribe to Caller ID.	<ul style="list-style-type: none">You must subscribe to a Caller ID service. Once you receive caller information after subscribing to a Caller ID service, this message will not be displayed.

Troubleshooting

If you still have difficulties after following the instructions in this section, disconnect the base unit's AC adaptor and turn off the handset, then reconnect the base unit's AC adaptor and turn on the handset.

General use



Problem	Cause/solution
The handset does not turn on even after installing charged batteries.	<ul style="list-style-type: none">Place the handset on the base unit or charger to turn on the handset.
The unit does not work.	<ul style="list-style-type: none">Make sure the batteries are installed correctly (page 9).Fully charge the batteries (page 9).Check the connections (page 9).Unplug the base unit's AC adaptor to reset the unit and turn off the handset. Reconnect the adaptor, turn on the handset and try again.The handset has not been registered to the base unit. Register the handset (page 31).
The handset display is blank or dark.	<ul style="list-style-type: none">The handset is in screen saver mode (page 12). Activate the handset display again by:<ul style="list-style-type: none">pressing [] when on a call.pressing [] at all other times."LCD in charging" is set to "Off" while on charge. Change the setting (page 23).The handset is not turned on. Turn the power on (page 12).
I cannot hear a dial tone.	<ul style="list-style-type: none">Make sure that you are using the supplied telephone line cord. Your old telephone line cord may have a different wiring configuration.The base unit's AC adaptor or telephone line cord is not connected. Check the connections.Disconnect the base unit from the telephone line and connect the line to a known working telephone. If the working telephone operates properly, contact our service personnel to have the unit repaired. If the working telephone does not operate properly, contact your service provider/telephone company.
The handset display begins operating automatically.	<ul style="list-style-type: none">Demonstration mode is activated. Please connect the telephone line cord to the telephone line jack (page 9).

Useful Information

Menu list

Problem	Cause/solution
The display is in a language I cannot read.	<ul style="list-style-type: none">● Change the display language (page 12).
I cannot activate the eco mode.	<ul style="list-style-type: none">● You cannot set eco mode when you set the DECT repeater mode "On". If required, set the DECT repeater mode to "off" (page 32).
I cannot display the wallpaper.	<ul style="list-style-type: none">● Wallpaper is displayed in the standby mode only when you select "Digital (Small)" or "Off" for the clock setting. Change the clock setting (page 23).
I cannot register a handset to a base unit.	<ul style="list-style-type: none">● The maximum number of base units (4) is already registered to the handset. Cancel unused base unit registrations from the handset (page 32).● The maximum number of handsets (6) is already registered to the base unit. Cancel unused handset registrations from the base unit (page 32).● You entered the wrong PIN. If you forget your PIN, contact an authorised service centre.

Battery recharge

Problem	Cause/solution
The handset beeps and/or  flashes.	<ul style="list-style-type: none">● Battery charge is low. Fully charge the batteries (page 9).
I fully charged the batteries, but <ul style="list-style-type: none">–  still flashes or– the operating time seems to be shorter.	<ul style="list-style-type: none">● Clean the battery ends (\oplus, \ominus) and the charge contacts with a dry cloth and charge again.● It is time to replace the batteries (page 9).

Making/answering calls, intercom

Problem	Cause/solution
 is displayed.	<ul style="list-style-type: none">● The handset is too far from the base unit. Move closer.● The base unit's AC adaptor is not properly connected. Reconnect AC adaptor to the base unit.● The handset is not registered to the base unit. Register it (page 31).● Activating one touch eco mode reduces the range of the base unit in standby mode. If required, turn eco mode off (page 12).

Useful Information

Problem	Cause/solution
Noise is heard, sound cuts in and out.	<ul style="list-style-type: none">• You are using the handset or base unit in an area with high electrical interference. Re-position the base unit and use the handset away from sources of interference.• Move closer to the base unit.• If you use a DSL/ADSL service, we recommend connecting a DSL/ADSL filter between the base unit and the telephone line jack. Contact your DSL/ADSL provider for details.
Sound quality seems to be getting worse.	<ul style="list-style-type: none">• You have registered a handset that is not recommended (page 4). The clearest sound quality is only possible by registering the recommended handset.
The handset does not ring.	<ul style="list-style-type: none">• The ringer volume is turned off. Adjust ringer volume (page 14, 22).• Night mode is turned on. Turn it off (page 26).
I cannot make a call.	<ul style="list-style-type: none">• The dialling mode may be set incorrectly. Change the setting (page 13).• You dialled a call restricted number (page 30).• The key lock feature is turned on. Turn it off (page 16).

Caller ID

Problem	Cause/solution
Caller information is not displayed.	<ul style="list-style-type: none">• You must subscribe to a Caller ID service. Contact your service provider/telephone company for details.• If your unit is connected to any additional telephone equipment, remove and plug the unit directly into the wall jack.• If you use a DSL/ADSL service, we recommend connecting a DSL/ADSL filter between the base unit and the telephone line jack. Contact your DSL/ADSL provider for details.• Other telephone equipment may be interfering with this unit. Disconnect the other equipment and try again.
Caller information is slow to display.	<ul style="list-style-type: none">• Depending on your service provider/telephone company, the unit may display the caller's information at the 2nd ring or later. Set the first ring to "off" (page 22).• Move closer to the base unit.
Time on the unit has shifted.	<ul style="list-style-type: none">• Incorrect time information from incoming Caller ID changes the time. Set the time adjustment to "Manual" (off) (page 22).

SMS (Short Message Service)

Problem	Cause/solution
The SMS message centre number is logged in the caller list and the message is not received.	<ul style="list-style-type: none">• Someone tried to send you a message while SMS is turned off. Turn it on (page 35).

Useful Information

Problem	Cause/solution
I cannot send or receive SMS messages.	<ul style="list-style-type: none">• You have not subscribed to the appropriate service. Contact your service provider/telephone company.• The SMS message centre number(s) are not stored or are incorrect. Store the correct numbers (page 35).• Message transmission was interrupted. Wait until the message has been sent before using other telephone functions.• If you use a DSL/ADSL service, we recommend connecting a DSL/ADSL filter between the base unit and the telephone line jack. Contact your DSL/ADSL provider for details.
"FD" is displayed.	<ul style="list-style-type: none">• The unit could not connect to the SMS message centre. Confirm that the correct SMS message centre numbers are stored. Confirm that SMS is turned on (page 35).
"FE" is displayed.	<ul style="list-style-type: none">• An error occurred while sending the message. Try again.
"EO" is displayed.	<ul style="list-style-type: none">• Your phone number is permanently withheld or you have not subscribed to the appropriate service. Contact your service provider/telephone company.

Liquid damage

Problem	Cause/solution
Liquid or other form of moisture has entered the handset/base unit.	<ul style="list-style-type: none">• Disconnect the AC adaptor and telephone line cord from the base unit. Remove the batteries from the handset and leave to dry for at least 3 days. After the handset/base unit are completely dry, reconnect the AC adaptor and telephone line cord. Insert the batteries and charge fully before use. If the unit does not work properly, contact an authorised service centre.

Caution:

- To avoid permanent damage, do not use a microwave oven to speed up the drying process.

Index

- A** Additional base units: 31
- Additional handsets: 31
- Alarm: 26
- Answering calls: 14
- Auto intercom: 16
- Auto talk: 14, 23
- B** Baby monitor: 28
- Base unit
 - Cancelling: 32
 - Resetting: 30
 - Selecting: 32
- Battery: 9, 10
- C** Calendar: 30
- Call restriction: 30
- Call share: 15
- Call waiting: 15
- Call Waiting Caller ID: 15
- Caller ID service: 33
- Caller list: 33
- Caller list edit: 33
- Category: 17
- Chain dial: 18
- Character entry: 38
- Conference calls: 15
- Control type: 11
- D** Date and time: 12
- DECT repeater: 32
- Dialling mode: 13
- Direct command code: 20
- Display
 - Clock: 23
 - Colour: 23
 - Contrast: 23
 - Display mode: 23
 - Language: 12
 - LCD backlight: 23
 - Wallpaper: 23
- E** Eco mode: 12
- Equalizer: 15
- Error messages: 40
- F** First ring: 22
- H** Handset
 - Deregistration: 32
 - Name: 29
 - Registration: 31
 - Hold: 14
- I** Incoming call barring: 27
- Intercom: 16
- K** Key finder: 22, 25
- Key lock: 16
- Keytones: 23
- M** Making calls: 14
- Missed calls: 33
- Mute: 15
- N** Night mode: 26
- Noise reduction: 15
- P** Pause: 14
- Phonebook: 17
- PIN: 30
- Power failure: 10
- Power on/off: 12
- Privacy mode: 24
- R** Recall/flash: 15
- Redialling: 14
- Region setting: 30
- Ringer tone: 22
- S** Schedule: 30
- SMS feature: 35
- Speakerphone: 14
- Speed dial: 18
- T** Temporary tone dialling: 15
- Time adjustment: 22
- Transferring calls: 15
- Troubleshooting: 41
- V** Voice mail: 38
- Volume
 - Receiver: 14
 - Ringer (Handset): 14, 22
 - Speaker: 14



Notes

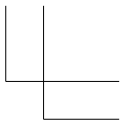
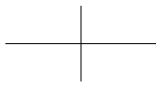
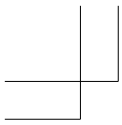

Notes

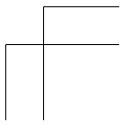
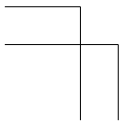
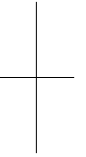
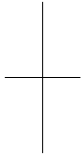

CE0470

Sales Department:

■ Czech

Panasonic Marketing Europe
GmbH, organizační složka
Česká republika

Thámova 289/13 (Palác Karlín)
186 00 Praha 8

telefon: +420-236 032 511
centrální fax: +420-236 032 411
zákaznická linka: +420-236 032 911
e-mail: panasonic.praha@eu.panasonic.com
aktuální info na www.panasonic.cz

■ Slovakia

Panasonic Marketing Europe
GmbH, organizačná zložka
Slovenská republika

Štúrova 11, 811 01 Bratislava,
Slovenská republika

Telefón: +421-2-2062-2211
Fax: +421-2-2062-2311
zákaznická linka: +421-2-2062-2911
e-mail: panasonic.bratislava@eu.panasonic.com
aktuálne info na www.panasonic.sk

■ Romania

Panasonic Marketing Europe
GmbH, Wiesbaden, Germania,
Sucursala București, Romania

B-dul Preciziei, Nr. 24, West Gate Park,
Clădirea H3, Etaj 2, Sector 6,
București, 062204, Romania

Telefon: +40.21.316.31.61
Fax: +40.21.316.04.46
e-mail: suport.clienti@eu.panasonic.com
web: www.panasonic.ro

Panasonic System Networks Co., Ltd.

1-62, 4-chome, Minoshima, Hakata-ku, Fukuoka 812-8531, Japan

© Panasonic System Networks Co., Ltd. 2013



PNQX6046ZA

PNQX6046ZA TT0813MU0 (E)

Free Manuals Download Website

<http://myh66.com>

<http://usermanuals.us>

<http://www.somanuals.com>

<http://www.4manuals.cc>

<http://www.manual-lib.com>

<http://www.404manual.com>

<http://www.luxmanual.com>

<http://aubethermostatmanual.com>

Golf course search by state

<http://golfingnear.com>

Email search by domain

<http://emailbydomain.com>

Auto manuals search

<http://auto.somanuals.com>

TV manuals search

<http://tv.somanuals.com>