

Panasonic®

Operating Instructions

Home Communication System
Cellular Connection Package

Model No. **KX-TH102-C**

2LINE

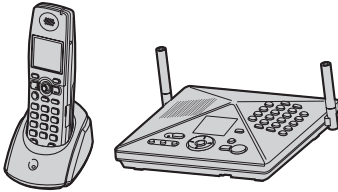

This unit is compatible with Caller ID. To use this feature, you must subscribe to the appropriate service offered by your service provider.

Charge the handset battery for 4 hours before initial use.

Please read these Operating Instructions before using the unit and save for future reference.

For assistance, visit our website:

<http://www.panasonic.com/phonehelp> for customers in the U.S.A. or Puerto Rico.

Table of Contents

Introduction

Feature highlights	3
Accessory information	5
Expanding your phone system	7
Important safety instructions	10
For best performance	12

Preparation

Setting up the base unit	13
Setting up the handset	16
Battery charge	16
Battery replacement	17
Controls	18
Displays	21
Symbols used in these operating instructions	23
Setting the unit before use	24

Making/Answering Calls

Making calls	26
Answering calls	28
Useful features during a call	28
Using the other line during a call	30

Phonebook

Handset phonebook	31
Base unit phonebook	34

Caller ID Service

Using Caller ID service	36
Caller list	37

Intercom

Intercom feature	40
Transferring a call	41
Conference calls	42
Call share	44

Monitoring

Monitoring feature	45
Audio monitor	45

Programmable Settings

Ringer settings	46
Other settings	49
Registering a unit	54

Answering System

Answering system feature	55
Setting up the answering system	55
Listening to messages using the base unit	56
Listening to messages using the handset	57
Voice memo	59
Remote operation	59
Answering system settings	61

Using a Cellular Phone with this Unit

Configuring a cellular phone	64
Making/answering calls using a cellular line	65
Useful features during a cellular call	67
Cellular settings	68
Transferring a cellular call	70
Conference calls	71

Useful Information

Connecting to your network	73
Wall mounting	75
Belt clip	76
Headset (Optional)	77
Error messages	78
Troubleshooting	80
FCC and other information	86
Specifications	89
Customer services	90
Warranty	91
Direct command chart/programming index	93

Index

Index	96
-----------------	----

Feature highlights

Thank you for purchasing a Panasonic Home Communication System Cellular Connection Package.

KX-TH102-C

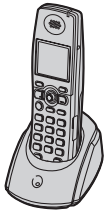

Cordless handset

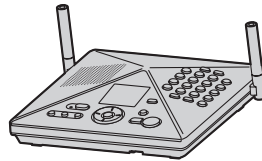

Base unit

Important:

- KX-TH102-C includes a cordless handset (KX-THA11) and a base unit.
- In these operating instructions, the included “cordless handset” is referred to as the “handset”.

Telephone and monitoring features

■ 2 line telephone

While one line is in use, you can make or answer a call using the other line.

■ Audio monitor (between handset and base unit)

You can listen to the audio in the room where the handset or base unit is located (page 45).

■ Customize ring

You can connect an audio device to the handset using the included audio cable and record songs to be used as the handset ringer tone (page 47).

■ Changing the device name

You can customize the name for the handset and base unit (page 49).

■ Cellular connection

This feature allows you to make or answer cellular calls using the handset or base unit, if your cellular phone is Bluetooth® wireless technology compatible to the home communication system (page 64). For more information for this feature, please visit our website (page 7).

Introduction

MULTI TALK V software

The included CD-ROM contains the MULTI TALK V Utility suite. The suite consists of the following utilities.

■ MULTI TALK V USB Utility

Allows you to use your computer to:

- Add, edit, erase, and copy phonebook entries
- Send melodies stored in your computer to your phone
- Change phone settings
- Play, erase, and save answering system messages
- Connect to the Internet or to another computer using a MULTI TALK V phone
- Send images stored in your computer to a compatible Panasonic unit (KX-THA12/KX-THA16/KX-THA17, sold separately)

■ MULTI TALK V Camera Utility

Allows you to use your computer to register a cordless camera (KX-THA13, sold separately) in order to view cordless camera images with a web browser.

■ MULTI TALK V Printing Utility

Allows you to use your computer to register a cordless video camera station (KX-THA16, sold separately) in order to print images from the KX-THA16 to your computer's printer.

To install the MULTI TALK V software in your computer, refer to the "Installation Guide for MULTI TALK V Software" for installation details.

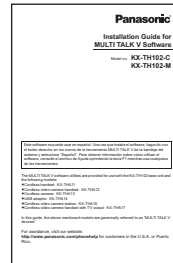





When using the MULTI TALK V features with your computer, refer to the help section of the MULTI TALK V USB Utility. For the operations of the Camera Utility and Printing Utility, refer to their individual help sections indicated by the following "Help" icon.





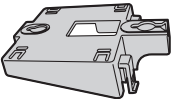

"Help" icon

Accessory information

Base unit

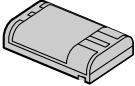
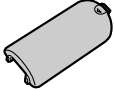
<p><input type="checkbox"/> AC adaptor for base unit PQLV205 (Order No. PQWETH102M)</p> 	<p><input type="checkbox"/> 4-wire telephone line cord with green plugs (Order No. PQJA10088Z)</p> 	<p><input type="checkbox"/> 2-wire telephone line cord with transparent plugs (Order No. PQJA10075Z)</p> 
<p><input type="checkbox"/> LAN cable (Order No. PQJA10169Z)</p> 	<p><input type="checkbox"/> Wall mounting adaptor for base unit (Order No. PQKL10070Z1)</p> 	

Handset

<p><input type="checkbox"/> Battery (Order No. HHR-P104)</p> 	<p><input type="checkbox"/> Handset cover (Order No. PQYNTHA11R)</p> 	<p><input type="checkbox"/> Charger (Order No. PQLV30038ZS)</p> 
<p><input type="checkbox"/> AC adaptor for charger (Order No. PQLV203Z)</p> 	<p><input type="checkbox"/> Audio cable (Order No. PQJA10172Z)</p> 	<p><input type="checkbox"/> Belt clip (Order No. PQKE10404Z1)</p> 

Introduction

MULTI TALK V utility

USB cable
(Order No. PQJA10166Z)

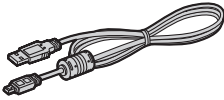

CD-ROM*1
(Order No. PQJKTH102Z)

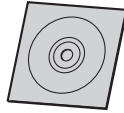

*1 Allows you to install the MULTI TALK V software on a compatible computer. Refer to the included "Installation Guide for MULTI TALK V Software" for details.

Other additional/replacement accessories

Accessory item	Order number
Rechargeable nickel metal hydride (Ni-MH) battery	HHR-P104
Corded headset	KX-TCA86, KX-TCA88HA, KX-TCA91, KX-TCA92, KX-TCA98
T-adaptor	KX-J66
2-line splitter	KX-J42

Note:







- You can expand your phone system by registering additional compatible Panasonic units (page 7).
-

Sales and support information

- To order these accessories, call 1-800-332-5368.
- TTY users (hearing or speech impaired users) can call 1-866-605-1277.

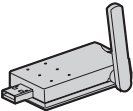
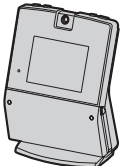
Expanding your phone system

You can expand the phone system by registering the following units to a single base unit:
max. 18

Handsets: max. 8		Other devices: max. 10	
Cordless handset KX-THA11 (Monochrome display type)		Cordless camera KX-THA13: max. 2 (For monitoring)	
Cordless video camera handset KX-THA12 (Color display type)		USB adaptor KX-THA14 (For data link)	
Cordless video camera station KX-THA16 (Large color display type)		Other Bluetooth compatible devices (Optional)	Headset 
Cordless video camera handset with A/V output KX-THA17 (Color display type with audio/video output jack)			Cellular phone: max. 5 

Note:

- Headset and cellular phone must have Bluetooth capability and must be compatible to the home communication system. For more details and the list of compatible cellular phones, please visit: www.panasonic.com/MultiTalkV

Introduction

Various features using the optional units

Video phone

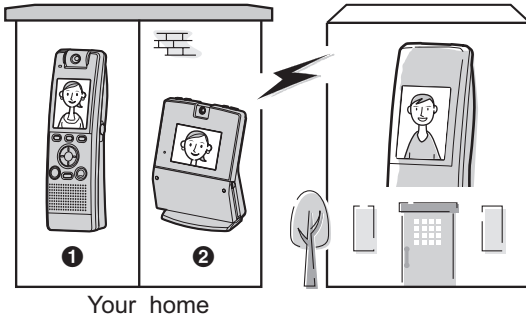

This feature allows you and the person you are talking to to see each other in real time for an outside call using the handsets. If you have additional units (❶, ❷), you can also make a video call during an intercom call.

- ❶ KX-THA12/KX-THA17
- ❷ KX-THA16

Video monitor

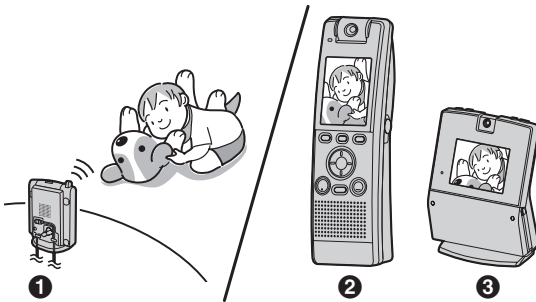

This feature allows you to monitor the room where the cordless camera (❶) is located from the units (❷, ❸). You can also monitor the room between the units (❷, ❸).

- ❶ KX-THA13
- ❷ KX-THA12/KX-THA17
- ❸ KX-THA16

Cellular connection (Bluetooth compatible)

Your cellular phone



This feature allows you to make or answer cellular calls using your unit (❶, ❷, ❸, and the base unit), if you have Bluetooth compatible cellular phones.

- ❶ KX-THA11
- ❷ KX-THA12/KX-THA17
- ❸ KX-THA16

Data link feature

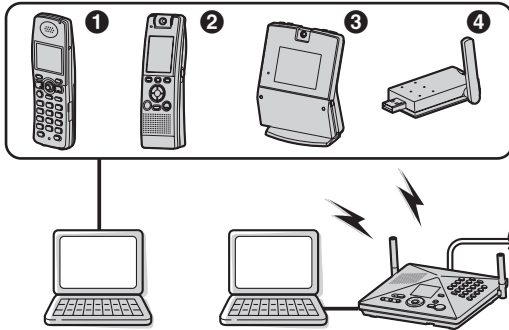

This feature allows you to access the Internet or another computer by connecting the units (1, 2, 3, and the base unit) with the USB cable or a USB adaptor (4) to your computer.

- 1 KX-THA11
- 2 KX-THA12/KX-THA17
- 3 KX-THA16
- 4 KX-THA14

Video phone using TV

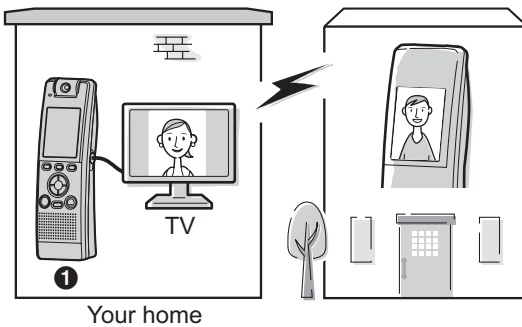

This feature allows you to use your TV to see the other person during a video call.

- 1 KX-THA17

Important safety instructions

When using the product, basic safety precautions should always be followed to reduce the risk of fire, electric shock, or personal injury.

1. Read and understand all instructions.
2. Follow all warnings and instructions marked on the product.
3. Unplug the product from power outlets before cleaning. Do not use liquid or aerosol cleaners. Use a moist cloth for cleaning.
4. Do not use the product near water, for example near a bathtub, wash bowl, kitchen sink, etc.
5. Place the product securely on a stable surface. Serious damage and/or injury may result if the product falls.
6. Do not cover slots and openings on the product. They are provided for ventilation and protection against overheating. Never place the product near radiators, or in a place where proper ventilation is not provided.
7. Use only the power source marked on the product. If you are not sure of the type of power supplied to your home, consult your dealer or local power company.
8. Do not place objects on the power cord. Install the product where no one can step or trip on the cord.
9. Do not overload power outlets and extension cords. This can result in the risk of fire or electric shock.
10. Never push any objects through slots in the product. This may result in the risk of fire or electric shock. Never spill any liquid on the product.
11. To reduce the risk of electric shock, do not disassemble the product. Take the product to an authorized service center when service is required. Opening or removing covers may expose you to dangerous voltages or other risks.

Incorrect reassembly can cause electric shock when the product is subsequently used.

12. Unplug the product from power outlets and refer servicing to an authorized service center when the following conditions occur:
 - A. When the power cord is damaged or frayed.
 - B. If liquid has been spilled into the product.
 - C. If the product has been exposed to rain or water.
 - D. If the product does not work normally by following the operating instructions. Adjust only controls covered by the operating instructions. Improper adjustment may require extensive work by an authorized service center.
 - E. If the product has been dropped or physically damaged.
 - F. If the product exhibits a distinct change in performance.
13. During thunderstorms, avoid using telephones except cordless types. There may be a remote risk of an electric shock from lightning.
14. Do not use the product to report a gas leak, when in the vicinity of the leak.

SAVE THESE INSTRUCTIONS

CAUTION:

Installation

- Never install telephone wiring during a lightning storm.
- Never install telephone jacks in wet locations unless the jack is specifically designed for wet locations.
- Never touch uninsulated telephone wires or terminals unless the telephone line has been disconnected at the network interface.
- Use caution when installing or modifying telephone lines.

- Do not touch the plug with wet hands.
- The AC adaptor is used as the main disconnect device. Ensure that the AC outlet is installed near the product and is easily accessible.

Battery

To reduce the risk of fire or injury to persons, read and follow these instructions.

- Use only the battery(ies) specified.
- Do not dispose of the battery(ies) in a fire. They may explode. Check with local waste management codes for special disposal instructions.
- Do not open or mutilate the battery(ies). Released electrolyte is corrosive and may cause burns or injury to the eyes or skin. The electrolyte may be toxic if swallowed.
- Exercise care when handling the battery(ies). Do not allow conductive materials such as rings, bracelets or keys to touch the battery(ies), otherwise a short circuit may cause the battery(ies) and/or the conductive material to overheat and cause burns.
- Charge the battery(ies) provided, or identified for use with the product only, in accordance with the instructions and limitations specified in this manual.

WARNING:

- To prevent the risk of fire or electrical shock, do not expose the product to rain or any type of moisture.
- Unplug the product from power outlets if it emits smoke, an abnormal smell, or makes an unusual noise. These conditions can cause fire or electric shock. Confirm that smoke has stopped and contact the Panasonic Call Center at 1-800-211-PANA (1-800-211-7262).

Medical

- Consult the manufacturer of any personal medical devices, such as pacemakers or hearing aids, to determine if they are adequately shielded from external RF (radio frequency) energy. (The product operates in the frequency range of 2.402 GHz to 2.48 GHz, and the power output is 125 mW (max.)) Do not use the product in health care facilities if any regulations posted in the area instruct you not to do so. Hospitals or health care facilities may be using equipment that could be sensitive to external RF (radio frequency) energy.

For best performance

Base unit location/noise

The base unit and other compatible Panasonic units use radio waves to communicate with each other.

For maximum distance and noise-free operation, we recommend the following:

- Placing the base unit in a HIGH and CENTRAL location with no obstructions such as walls.
- Raising the antennas vertically.
- Placing the product away from electrical appliances.
- If you use the handset near other electrical appliances (microwave, wireless LAN appliance, etc.), noise may be heard. Move away from those appliances and closer to the base unit.
- If you use the handset near another cordless phone's base unit, noise may be heard. Move away from the other cordless phone's base unit and closer to your base unit.

Environment

- Keep the product away from electrical noise generating devices, such as fluorescent lamps and motors.
- The product should be kept free from excessive smoke, dust, high temperature, and vibration.
- The product should not be exposed to direct sunlight.
- Do not place heavy objects on top of the product.
- When you leave the product unused for a long period of time, unplug the product from the power outlet.
- The product should be kept away from heat sources such as heaters, kitchen stoves, etc. It should not be placed in rooms where the temperature is less than 5 °C (41 °F) or greater than 40 °C

(104 °F). Damp basements should also be avoided.

- The maximum calling distance may be shortened when the product is used in the following places: Near obstacles such as hills, tunnels, underground, near metal objects such as wire fences, etc.
- Operating near 2.4 GHz electrical appliances may cause interference. Move away from the electrical appliances.

Routine care

- Wipe the outer surface of the product with a soft moist cloth. Do not use benzene, thinner, or any abrasive powder.

Setting up the base unit

Overview

- 1 Connect the AC adaptor.
- 2 Connect the telephone line cord.
Refer to one of the following methods depending on your situation.
 - To connect to a 2-line telephone jack: page 14
 - To connect to 2 single-line telephone jacks: page 14
 - To connect to a single-line telephone jack: page 14
 For DSL service subscribers:
 - To connect to a 2-line telephone jack: page 15
 - To connect to 2 single-line telephone jacks: page 15
- 3 To connect to your LAN, see page 73.

Connecting the AC adaptor

Connect the AC adaptor, then raise the antennas.

- Use only the included Panasonic AC adaptor PQLV205.

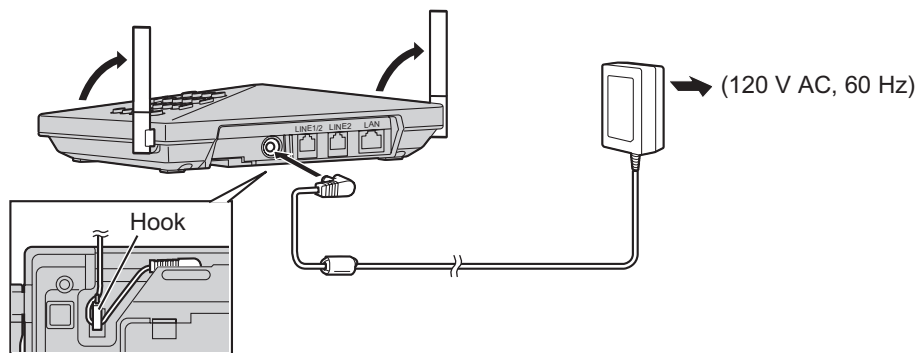

Note:

- The AC adaptor must remain connected at all times. (It is normal for the adaptor to feel warm during use.)
- The AC adaptor should be connected to a vertically oriented or floor-mounted AC outlet. Do not connect the AC adaptor to a ceiling-mounted AC outlet, as the weight of the adaptor may cause it to become disconnected.
- The unit will not work during a power failure. We recommend connecting a standard telephone to the same telephone line or to the same telephone jack using a Panasonic T-adaptor (page 6).

Preparation

Connecting the telephone line cord

Connect the telephone line cord until it clicks into the telephone jack.

To connect to a 2-line telephone jack

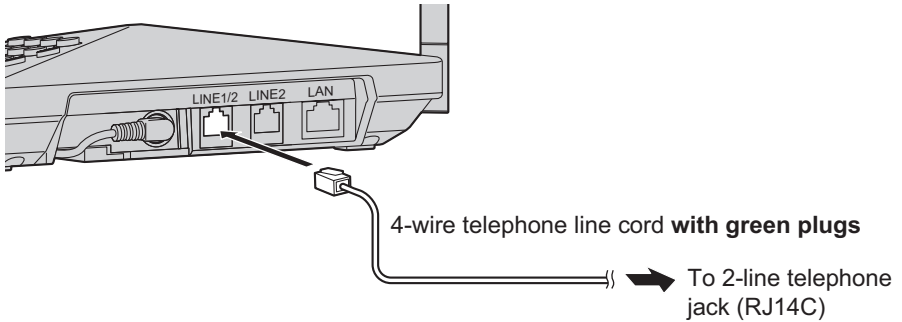

To connect to 2 single-line telephone jacks

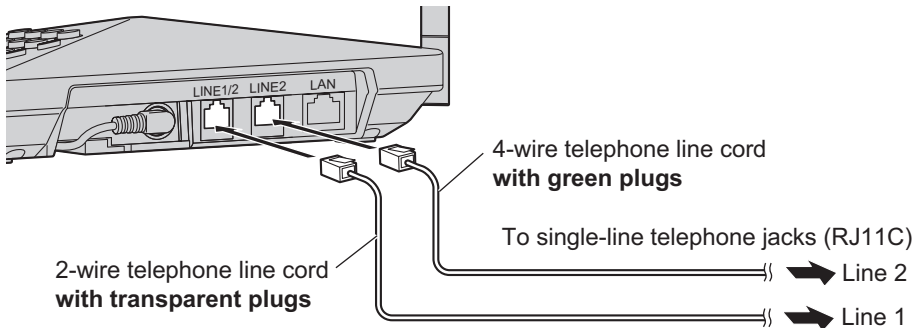

To connect to a single-line telephone jack

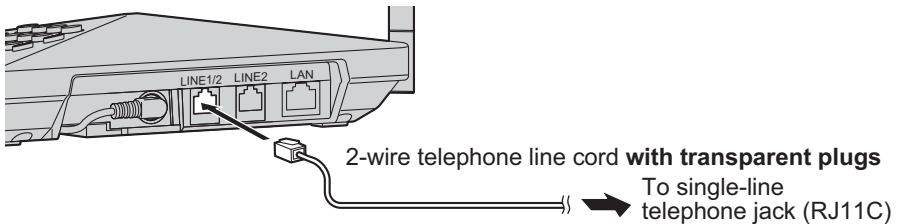

Note:

- Make sure you connect the telephone line cord into LINE1/2 telephone jack.

If you subscribe to a DSL service

Please attach a noise filter (contact your DSL provider) to the telephone line between the base unit and the telephone line jack in the event of the following:

- Noise is heard during conversations.
- Caller ID features (page 36) do not function properly.

To connect to a 2-line telephone jack

For this connection, please purchase a Panasonic 2-line splitter (page 6).

Example: DSL line is line 2

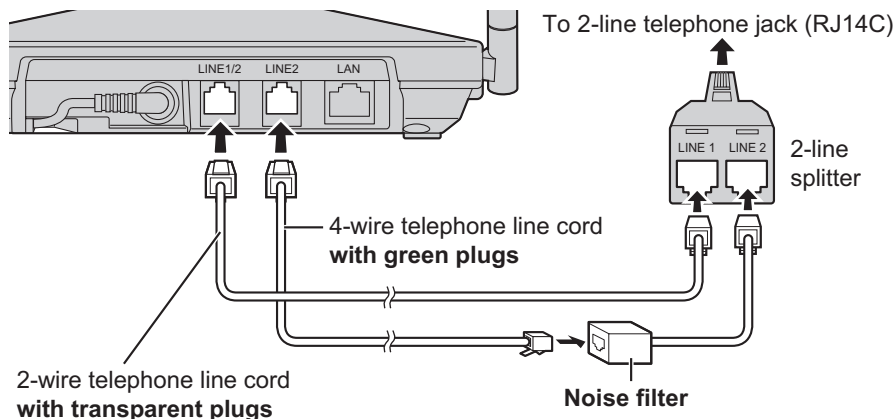

To connect to 2 single-line telephone jacks

Example: DSL line is line 2

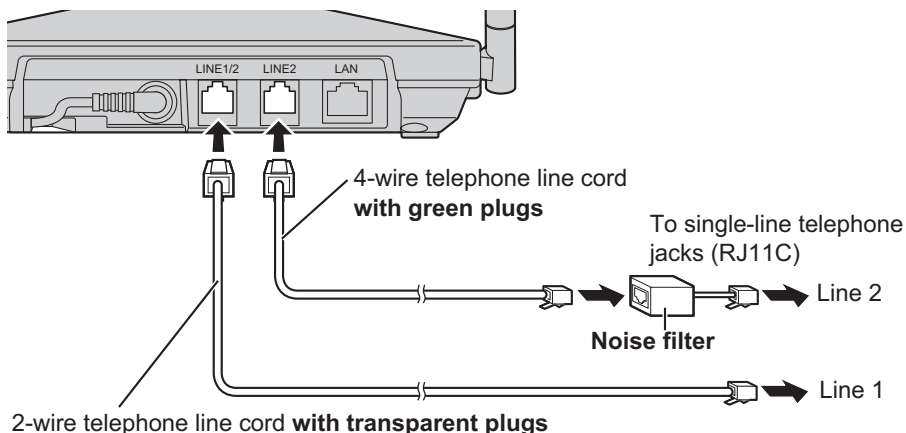

Setting up the handset

Connecting the AC adaptor

- Use only the included Panasonic AC adaptor PQLV203.

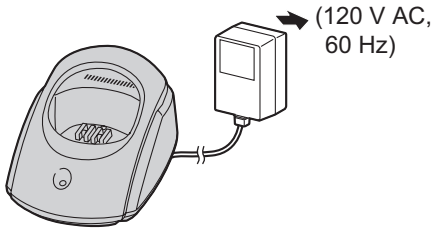

Battery installation

Insert the battery (1), and press it down until it snaps into the compartment (2). Then close the handset cover.

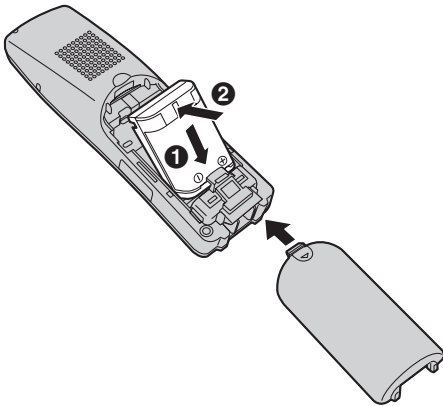

Battery charge

Place the handset on the charger for **4 hours** before initial use.

While charging, the CHARGE indicator on the charger lights. When the battery is fully charged, "Charge completed" is displayed.

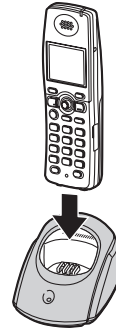

Note:

- If you want to use the handset immediately, charge the battery for at least 15 minutes.
- To ensure that the battery charges properly, clean the charge contacts of the handset and charger with a soft, dry cloth once a month. Clean more often if the unit is subject to grease, dust, or high humidity.

Battery strength

Battery icon	Battery strength
	Fully charged or high
	Medium
	Low Flashing: needs to be recharged.
	Discharged

Note:

- When the battery needs to be charged, the handset beeps intermittently while it is in use.

Panasonic battery performance

Operation	Operating time
While in use (talking)	Up to 4.5 hours
While not in use (standby)	Up to 7 days
While using the clarity booster feature (page 29)	Up to 3.5 hours

Note:

- Battery operating time may be shortened over time depending on usage conditions and ambient temperature.
- Battery power is consumed whenever the handset is off the charger, even when the handset is not in use. The longer you leave the handset off the charger, the shorter you can actually talk using the handset.
- Once the battery is fully charged, you do not have to charge it again until “**Recharge battery**” is displayed or  flashes. This will maximize the battery life.

Battery replacement

Important:

- Use only the rechargeable Panasonic battery noted on page 6.

- 1 Press the notch of the handset cover firmly, and slide it in the direction of the arrow.

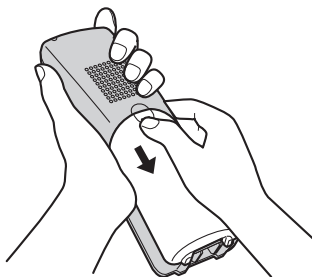

- 2 Replace the old battery with a new one, and close the cover (page 16).

Attention:

A nickel metal hydride battery that is recyclable powers the product you have purchased.

Please call 1-800-8-BATTERY (1-800-822-8837) for information on how to recycle this battery.

Controls

Base unit

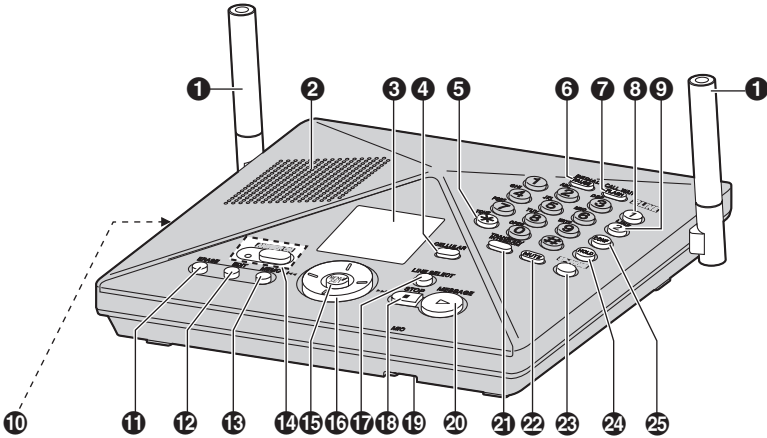

- | | |
|------------------------------|--|
| 1 Antenna | 14 [ANSWER ON]
ANSWER ON indicator |
| 2 Speaker | 15 [MENU] [SET] |
| 3 Display | 16 Navigator key |
| 4 [CELLULAR] | 17 [LINE SELECT] |
| 5 [*] (TONE) | 18 [STOP] |
| 6 [PAUSE] [REDIAL] | 19 MIC (Microphone) |
| 7 [FLASH] [CALL WAIT] | 20 [MESSAGE] |
| 8 [LINE1] | 21 [TRANSFER] [INTERCOM] |
| 9 [LINE2] | 22 [MUTE] |
| 10 USB port | 23 [SP-PHONE] (Spkerphone) |
| 11 [ERASE] | 24 [HOLD] |
| 12 [EDIT] | 25 [CONF] (Conference) |
| 13 [MEMO] | |

Handset

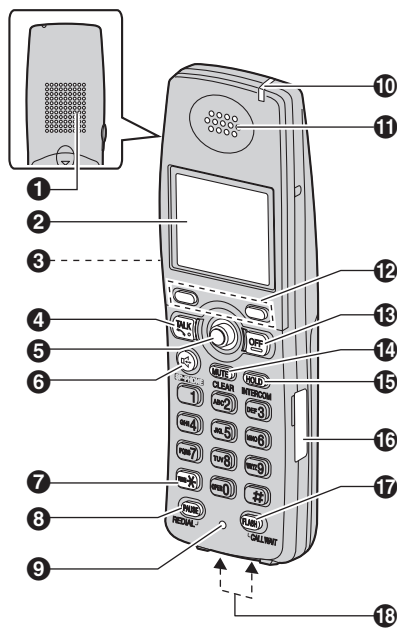

- | | |
|----------------------------------|--|
| 1 Speaker | 10 Ringer indicator/Message indicator |
| 2 Display | 11 Receiver |
| 3 Headset jack/Audio jack | 12 Soft keys |
| 4 [TALK] | 13 [OFF] |
| 5 Joystick | 14 [MUTE] [CLEAR] |
| 6 [SP-PHONE] | 15 [HOLD] [INTERCOM] |
| 7 [TONE] | 16 USB port |
| 8 [PAUSE] [REDIAL] | 17 [FLASH] [CALL WAIT] |
| 9 Microphone | 18 Charge contacts |

Using the joystick

The handset joystick can be used to navigate through menus and to select items shown on the display, by pushing it up, down, left, or right.

It can also be used to select the center soft key icon (page 22), by pressing down on the center of the joystick.

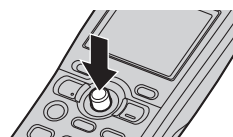
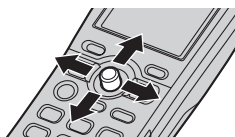

Preparation

Charger

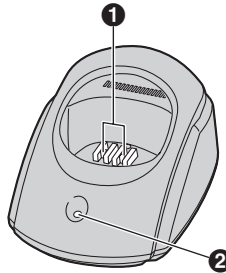

- ① Charge contacts
- ② CHARGE indicator

Understanding the indicators

Base unit line buttons

The line buttons ([LINE1], [LINE2]) show the status of each line as follows.

Status	Meaning
Light off	The line is free.
Light on	The line is in use.
Flashing rapidly	A call is being received.
Flashing	A call is put on hold on another unit or the answering system is answering a call.







Base unit [CELLULAR] button

The [CELLULAR] button shows the status as follows.

Status	Meaning
Light off	The cellular line is free.
Light on	The cellular line is in use.
Flashing rapidly	A cellular call is being received.
Flashing	A cellular call is put on hold or the answering system is answering a call.

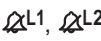





Displays

Base unit display items



Displayed item	Meaning
	Flashes when the date and time need to be set.
	Ringer for both line 1 and line 2 on the base unit is off.
	Line 1 or line 2 ringer on the base unit is off.
PRIVACY	Call privacy mode is on.
	The line icon is displayed when the displayed line is selected for the answering system. Flashing: – the answering system is answering a call on that line. – you have new messages on that line.
	Flashes when message memory is full.
	You are using a cellular line. The number of bars indicates the signal strength of the cellular line. Depending on a connected cellular phone's capability, these bars may not be displayed.
	This icon is displayed in the lower right representing a connected cellular phone's battery strength. It may not be displayed depending on the cellular phone's capability.

Displayed item	Meaning
LAN	The base unit is connected to your network using the LAN cable.
	Computer is connected.

Handset display items

Displayed item	Meaning
	– Battery strength indicator for the handset (located in the upper right of the display) – This icon is also displayed in the lower right representing a connected cellular phone's battery strength. It may not be displayed depending on the cellular phone's capability.
 	The line is in use. Flashing: – the call is put on hold on that line. – the answering system is answering a call on that line. Flashing rapidly: a call is being received on that line.
Example: [1]	Handset extension number
	Voice enhancer is on.
	Speaker is on.
PRIVACY	Call privacy mode is on.
	Ringer for both line 1 and line 2 on the handset is off.

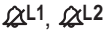
Preparation

Displayed item	Meaning
	Line 1 or line 2 ringer on the handset is off.
CELL (displayed in the top center)	The cellular line is in use. Flashing: a cellular call is put on hold. Flashing rapidly: a cellular call is being received.
	You are using a cellular line. The number of bars indicates the signal strength of the cellular line. Depending on a connected cellular phone's capability, these bars may not be displayed.
PC	Computer is connected.

Handset soft keys

The handset features 2 soft keys and a joystick. By pressing a soft key, or by pressing the center of the joystick, you can select the feature or operation indicated by the soft key icon shown directly above it.

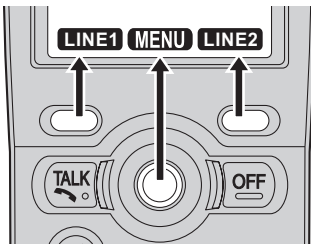







Menu icons

When in standby mode, pressing **[MENU]** (center of joystick) on the handset or **[MENU]** on the base unit reveals the main menu. From here you can access various features and settings.







Note:

- The menu icons shown in these operating instructions vary slightly from the actual icons shown on the display.

Base unit



Menu icon	Menu/feature
	Phonebook
	Caller list
	Set answering
	Ringer settings
	Audio monitor
	Other items

Handset





Menu icon	Menu/feature
	Phonebook
	Caller list
	Message playback
	Ringer settings
	Audio monitor
	Other items

Symbols used in these operating instructions

Symbols used at the end of titles

Symbol	Meaning
	Operate with the base unit.
	Operate with the handset.

Symbols used for operations

Symbol	Meaning
	The symbols to the left represent the base unit menu icons. Example:  Press the navigator key of the base unit up, down, left, or right to select that menu icon shown on the display.
	The symbols to the left represent the handset menu icons. Example:  Push the joystick of the handset up, down, left, or right to select that menu icon shown on the display.
Example: "Ringer volume"	Push the joystick of the handset or press the navigator key of the base unit up or down to select the words in quotations shown on the display.
→	Proceed to the next operation.

Symbol	Meaning
Example: [MENU]	The words in the brackets show button names on the handset and base unit.
[▲], [▼]	Push the joystick of the handset or press the navigator key of the base unit up or down to scroll through the displayed items.
[◀], [▶]	Push the joystick of the handset or press the navigator key of the base unit left or right to select the desired items.

Setting the unit before use

Display language

Handset

- 1 **[MENU]** (center of joystick) →  → **[SELECT]**
- 2 “Change language” → **[SELECT]**
- 3 Select the desired setting. (Default: “English”)
- 4 Press the center of joystick to save. → **[OFF]**

Note:

- If you select a language you cannot read, press the center of joystick, **[#][1][1][0][1]**, and **[SAVE]** to change the display language to English.

Base unit

- 1 **[MENU]** →  → **[SET]**
- 2 “Change language” → **[SET]**
- 3 Select the desired setting. (Default: “English”) → **[SET]** → **[STOP]**

Note:

- If you select a language you cannot read, press **[MENU]**, **[#][1][1][0][1]**, and **[SET]** to change the display language to English.

Dialing mode

If you cannot make calls, change this setting depending on your telephone line service.

“**Tone**”: For tone dial service.

“**Pulse**”: For rotary pulse dial service.

- You only need to program this setting once, using either the handset or base unit.

Handset

- 1 **[MENU]** (center of joystick) →  → **[SELECT]**
- 2 “Set tel line” → **[SELECT]**
- 3 “Set dial mode” → **[SELECT]**
- 4 Select the desired setting. (Default: “Tone”) → **[SAVE]** → **[OFF]**

Base unit

- 1 **[MENU]** →  → **[SET]**
- 2 “Set tel line” → **[SET]**
- 3 “Set dial mode” → **[SET]**
- 4 Select the desired setting. (Default: “Tone”) → **[SET]** → **[STOP]**

Date and time

- You only need to program this setting once, using either the handset or base unit.

Handset

1 [MENU] (center of joystick) →  → [SELECT]

2 "Date and time" → [SELECT]

3 Enter the current month, day, and year by selecting 2 digits for each.

Example: May 15, 2006

[0][5] [1][5] [0][6]

4 Enter the current hour and minute (12-hour clock format) by selecting 2 digits for each.

Example: 9:30

[0][9] [3][0]

5 Press [✱] to select "AM" or "PM".

6 [SAVE] → [OFF]

Base unit

1 [MENU] →  → [SET]

2 "Date and time" → [SET]

3 Enter the current month, day, and year by selecting 2 digits for each.

Example: May 15, 2006

[0][5] [1][5] [0][6]

4 Enter the current hour and minute (12-hour clock format) by selecting 2 digits for each.

Example: 9:30

[0][9] [3][0]

5 Press [✱] to select "AM" or "PM".

6 [SET] → [STOP]

Note for handset and base unit:

- If you make a mistake when entering the date and time, press [▲], [▼], [←], or

[▶] to move the cursor, then make the correction.

Making calls



Using the handset

- 1 Lift the handset and dial the phone number.
 - To correct a digit, press **[CLEAR]**.

- 2 
 - An available line is automatically selected and the line number is displayed.

- 3 When you finish talking, press **[OFF]**.

Note:

- You can also select a line by pressing **[LINE1]** or **[LINE2]** in step 2.
- To change the line selection, see page 51.

Using the speakerphone

Important:

- You can place the handset on the charger while using the speakerphone. The call is not disconnected.

- 1 During a conversation, press  to turn on the speakerphone.
 - Speak alternately with the other party.

- 2 When you finish talking, press **[OFF]**.

Note:

- Use the speakerphone in a quiet environment.

- To switch back to the receiver, press .



Adjusting the receiver/speaker volume

Push  or  while talking.

Making a call using the redial list

The last 10 phone numbers dialed are stored in the redial list.

- 1 **[REDIAL]**

- 2 Push  or  to select the desired number.
 - To erase the displayed number, press **[CLEAR]**.

- 3 

PAUSE button (for PBX/long distance service users)

A pause is sometimes required when making calls using a PBX or long distance service.

For example, if you need to dial the line access number "9" when making outside calls with a PBX:

- 1 **[9]** → **[PAUSE]** → Dial the phone number.

- 2 

Note:

- A 3.5 second pause is inserted each time **[PAUSE]** is pressed. Press repeatedly to insert longer pauses.

Using the base unit

- 1** Dial the phone number.
 - To correct a digit, press **[ERASE]**.
- 2 [SP-PHONE]**
 - An available line is automatically selected and **[LINE1]** or **[LINE2]** lights.
- 3** When the other party answers, speak into the MIC.
 - Speak alternately with the other party.
- 4** When you finish talking, press **[SP-PHONE]**.

Note:

- You can also select a line by pressing **[LINE1]** or **[LINE2]** in step 2.
- To change the line selection, see page 51.
- Use the speakerphone in a quiet environment.
- While on a call, you can switch from the base unit to the handset by pressing **[LINE1]** or **[LINE2]** on the handset, then pressing **[SP-PHONE]** on the base unit.

Adjusting the speaker volume

Press **[▲]** or **[▼]** while talking.

Making a call using the redial list

The last 10 phone numbers dialed are stored in the redial list.

- 1 [REDIAL]**
- 2** Press **[▲]** or **[▼]** to select the desired number.
 - To erase the displayed number, press **[ERASE]**.
- 3 [SP-PHONE]**

PAUSE button (for PBX/long distance service users)

A pause is sometimes required when making calls using a PBX or long distance service.

For example, if you need to dial the line access number "9" when making outside calls with a PBX:

- 1 [9] → [PAUSE] →** Dial the phone number.



- 2 [SP-PHONE]**

Note:

- A 3.5 second pause is inserted each time **[PAUSE]** is pressed. Press repeatedly to insert longer pauses.

Answering calls

Using the handset

- 1 Lift the handset and press [] or [].
 - The called line is automatically selected.
 - You can also answer the call by pressing any button except the joystick or **[OFF]**. (**Any key talk feature**)
- 2 When you finish talking, press **[OFF]**.

Note:

- You can also answer the call by pressing **[LINE1]** or **[LINE2]** in step 1.
- To change the line selection, see page 51.

Auto talk

This feature allows you to answer a call by simply lifting the handset off the charger. You do not need to press []. To activate this feature, see page 50.

Temporary ringer off

While the handset is ringing for an outside call, you can turn the ringer off temporarily by pressing **[OFF]**.

Using the base unit

- 1 **[SP-PHONE]**
 - The called line is automatically selected.
- 2 Speak into the MIC.
- 3 When you finish talking, press **[SP-PHONE]**.

Note:

- You can also answer the call by pressing **[LINE1]** or **[LINE2]** in step 1.
- To change the line selection, see page 51.

Useful features during a call

HOLD button

This feature allows you to put an outside call on hold.

Handset

Press **[HOLD]** 2 times during an outside call.

- To release the hold, press **[LINE1]** or **[LINE2]** that is flashing on the handset.

Base unit

Press **[HOLD]** during an outside call.

- To release the hold, press **[LINE1]** or **[LINE2]** that is flashing on the base unit.

Note for handset and base unit:

- If a call is kept on hold for more than 6 minutes, an alarm tone starts to sound. After 4 additional minutes on hold, the call is disconnected.

MUTE button

While mute is turned on, you can hear the other party, but the other party cannot hear you.

Handset

To mute your voice, press **[MUTE]**.

- To return to the conversation, press **[MUTE]** or [].

Base unit

To mute your voice, press **[MUTE]**.

- To return to the conversation, press **[MUTE]** or **[SP-PHONE]**.

FLASH button

Pressing **[FLASH]** allows you to use special features of your host PBX such as transferring an extension call, or accessing optional telephone services such as Call Waiting.

Note:

- To change the flash time, see page 51.

For Call Waiting service users



To use Call Waiting, you must subscribe to your telephone company's Call Waiting service.

This feature allows you to receive calls while you are already talking on the phone. If you receive a call while on the phone, you will hear a Call Waiting tone. Please contact your telephone company for details and availability of this service in your area.

Press **[CALL WAIT]** to answer the 2nd call.

- To switch between calls, press **[CALL WAIT]**.

Temporary tone dialing (for rotary/pulse service users)



You can temporarily switch the dialing mode to tone when you need to access touch tone services (for example, answering services, telephone banking services, etc.).

Press **[*]** (TONE) before entering access numbers which require tone dialing.

Handset clarity booster

This feature can improve sound clarity when the handset is used in an area where there may be interference. During an outside call, this feature is turned on automatically when necessary. You can also turn this feature on or off manually.

- 1 Press **[MENU]** (center of joystick) during an outside call.
- 2 To turn this feature on, select "Booster on".
To turn this feature off, select "Booster off".

3 [SELECT]

Note:

- While this feature is turned on;
 - the battery operating time is shortened (page 17).
 - the maximum number of extensions that can be used at a time may decrease.

Handset voice enhancer

This feature clarifies the voice of the person you are talking to, reproducing a more natural-sounding voice that is easier to hear and understand (page 49).

- 1 Press **[MENU]** (center of joystick) during an outside call.
- 2 To turn this feature on, select "Voice enhancer".
To turn this feature off, select "V.E. off".

3 [SELECT]

Note:

- Depending on the condition and quality of your telephone line, this feature may emphasize existing line noise. If it becomes difficult to hear, turn this feature off.

Using the other line during a call

When a call is being received on the other line during a conversation, the interrupt tones sound (page 48). **L1** or **L2** on the handset, or **[LINE1]** or **[LINE2]** on the base unit flashes rapidly. You can answer the 2nd call while holding the 1st call.

You can also make a call without ending the 1st call.

Handset

Example: If you are using line 1

- 1 Press **[HOLD]** 2 times to put the 1st call (line 1) on hold.
- 2 Press **[LINE2]** to make or answer a 2nd call.
 - To hold the 2nd call, press **[HOLD]** 2 times.
- 3 To return to the 1st call (line 1), press **[LINE1]**.

Base unit

Example: If you are using line 1

- 1 Press **[HOLD]** to put the 1st call (line 1) on hold.
- 2 Press **[LINE2]** to make or answer a 2nd call.
 - To hold the 2nd call, press **[HOLD]**.
- 3 To return to the 1st call (line 1), press **[LINE1]**.

Note for handset and base unit:

- If you subscribe to Caller ID, the 2nd caller's information is displayed when a call is being received on the other line (page 36).

Handset phonebook



You can add 50 items to the handset phonebook and search for phonebook items by name. Each item can be assigned a name, phone number, ringer ID, and light-up ID. Ringer ID and light-up ID features (page 37) are available for Caller ID subscribers.

Important:

- You can also create and edit phonebook items using your computer and send them to the handset. Refer to the help section of the MULTI TALK V USB Utility application for more information (page 4).

Adding items to the handset phonebook

- 1 [MENU]** (center of joystick) → 
→ **[SELECT]**
- 2 [ADD]**
- 3** Enter the name (max. 16 characters).
→ **[NEXT]**
- 4** Enter the phone number (max. 32 digits). → **[NEXT]**
- 5** Select the desired ringer ID (page 37).
→ **[NEXT]**
- 6** Select the desired light-up ID (page 37).
→ **[NEXT]** → **[SAVE]**
 - To add other items, repeat from step 2.
- 7 [OFF]**

Note:

- To assign a song as ringer ID, you can record it from an audio device (page 47) or copy it from your computer (refer to the help section of the MULTI TALK V USB Utility application).
- If you select “**No Ringer ID**” (default), the handset uses the ringer tone you selected on page 46 when a call is received from that caller.
- If you select “**No Light-up ID**” (default), the handset uses the ringer indicator color you selected on page 48 when a call is received from that caller.

Character table for entering names

Key	Character
[1]	& ' () , - . / 1
[2]	a b c A B C 2
[3]	d e f D E F 3
[4]	g h i G H I 4
[5]	j k l J K L 5
[6]	m n o M N O 6
[7]	p q r s P Q R S 7
[8]	t u v T U V 8
[9]	w x y z W X Y Z 9
[0]	0 Space
[*]	*
[#]	#

Note:

- To enter another character that is located on the same dial key, first push **[▶]** to move the cursor to the next space.

Editing/correcting a mistake

Use the joystick to move the cursor to the character or number you want to erase, then press **[CLEAR]**. Enter the appropriate character or number.

Note:

- Press and hold **[CLEAR]** to erase all characters or numbers.

Finding and calling a handset phonebook item

Phonebook items can be searched for alphabetically by scrolling through the phonebook items or by initial.

Once you have found the desired item, press **[↵]** to dial the phone number.

- You can also make a call by pressing **[LINE1]** or **[LINE2]**.
- If you have registered a cellular phone to the base unit (page 64), you can make a call by pressing **[CALL]**, then pressing **[LINE1]** or **[LINE2]**.

Searching for a name alphabetically by scrolling through all items

1 [MENU] (center of joystick) →  → **[SELECT]**

2 Push **[▲]** or **[▼]** to select the desired item.

- To display further information for the selected item, push **[▶]**. To return to the list, push **[◀]**.

Searching for a name by initial

1 [MENU] (center of joystick) →  → **[SELECT]**

2 Press the dialing button (**[0]** to **[9]**, **[#]**, or **[*]**) that corresponds to the first letter you are searching for.

Example: "LISA"

Press **[5]** repeatedly to display the first phonebook entry starting with the initial "L" and go to step 3.

- If there is no item corresponding to the letter you selected, the next item is displayed.

3 Push **[▼]** to select the desired item.

Editing items in the handset phonebook

- 1** Find the desired item (page 32). → **[EDIT]**
- 2** Edit the name if necessary (page 31). → **[NEXT]**
- 3** Edit the phone number if necessary. → **[NEXT]**
- 4** Select the desired ringer ID. → **[NEXT]**
- 5** Select the desired light-up ID. → **[NEXT]** → **[SAVE]** → **[OFF]**

Erasing items in the handset phonebook

- 1** Find the desired item (page 32).
- 2 [CLEAR]** → **[YES]** → **[OFF]**

Chain dial

This feature allows you to dial phone numbers in the handset phonebook while you are on a call. This feature can be used, for example, to dial a calling card access number or bank account PIN that you have stored in the handset phonebook, without having to dial manually.

- 1** During an outside call, press **[MENU]** (center of joystick).
- 2** "Phonebook" → **[SELECT]**
- 3** Find the desired item (page 32). → **[CALL]**

Note:

- When storing a calling card access number and your PIN in the phonebook as one phonebook item, press **[PAUSE]** to add pauses after the number and PIN as necessary (page 26).

- If you have rotary or pulse service, you need to press **[✖]** before pressing **[MENU]** in step 1 to change the dialing mode temporarily to tone.

Copying handset phonebook items

You can copy one or all of the phonebook items from the handset to the phonebook of the base unit or a compatible Panasonic unit (KX-THA11/KX-THA12/KX-THA16/KX-THA17).

Important:

- In order to correctly copy a ringer ID as a phonebook item, the same melodies must be stored in identical order in the memories of both units involved. If the melody order in memory is different in the copy destination unit from the sending unit, the ringer ID will not be copied properly. (This is not necessary if the ringer ID is set to use a preset melody.)
- Light-up ID settings for phonebook items are not copied to the base unit and other compatible Panasonic handsets (KX-THA12/KX-THA16/KX-THA17).
- The melodies and songs for ringer ID are not copied to the base unit.

Copying an item

- 1 [MENU]** (center of joystick) → 
→ **[SELECT]**
- 2 [COPY]**
- 3 “Copy 1 item”** → **[SELECT]**
- Select the destination unit. → **[SELECT]**
- Find the desired item (page 32). → **[SEND]**
- Press **[OFF]** after “Complete” is displayed.

Copying all items

- 1 [MENU]** (center of joystick) → 
→ **[SELECT]**
- 2 [COPY]**
- 3 “Copy all items”** → **[SELECT]**
- Select the destination unit. → **[SEND]**
- Press **[OFF]** after “Complete” is displayed.

Base unit phonebook

You can add 50 items to the base unit phonebook and search for phonebook items by name. Each item can be assigned a name, phone number, and ringer ID. The ringer ID feature (page 37) is available for Caller ID subscribers.

Important:

- You can also create and edit phonebook items using your computer and send them to the base unit. Refer to the help section of the MULTI TALK V USB Utility application for more information (page 4).

Adding items to the base unit phonebook

- 1 **[MENU]** →  → **[SET]** 2 times
- 2 “Add phonebook” → **[SET]**
- 3 Enter the name (max. 16 characters; page 31). → **[SET]**
- 4 Enter the phone number (max. 32 digits). → **[SET]**
- 5 Select the desired ringer ID (page 37). → **[SET]** 2 times
 - To add other items, repeat from step 2.
- 6 **[STOP]**

Note:

- If you select “No Ringer ID” (default), the base unit uses the ringer tone you selected on page 46 when a call is received from that caller.

Editing/correcting a mistake

Press **[◀]** or **[▶]** to move the cursor to the character or number you want to erase, then press **[ERASE]**. Enter the appropriate character or number.

Note:

- Press and hold **[ERASE]** to erase all characters or numbers.

Finding and calling a base unit phonebook item

Phonebook items can be searched for alphabetically by scrolling through the phonebook items or by initial. Once you have found the desired item, press **[SP-PHONE]** to dial the phone number.

- You can also make a call by pressing **[LINE1]** or **[LINE2]**.

Searching for a name alphabetically by scrolling through all items

- 1 **[MENU]** →  → **[SET]**
- 2 Press **[▲]** or **[▼]** to select the desired item.

Searching for a name by initial

- 1 **[MENU]** →  → **[SET]**
- 2 Press the dialing button (**[0]** to **[9]**, **[#]**, or **[*]**) that corresponds to the first letter you are searching for.

Example: “LISA”

Press **[5]** repeatedly to display the first phonebook entry starting with the initial “L” and go to step 3.

- If there is no item corresponding to the letter you selected, the next item is displayed.

- 3 Press **[▼]** to select the desired item.

Editing items in the base unit phonebook

- 1 Find the desired item (page 34). → **[EDIT]**
- 2 Edit the name, if necessary. → **[SET]**
- 3 Edit the phone number, if necessary. → **[SET]**
- 4 Change the ringer ID, if necessary. → **[SET]** 2 times → **[STOP]**

Erasing items in the base unit phonebook

- 1 Find the desired item (page 34).
- 2 **[ERASE]** → **[▶]** → **[STOP]**

Chain dial

This feature allows you to dial phone numbers in the base unit phonebook while you are on a call. This feature can be used, for example, to dial a calling card access number or bank account PIN that you have stored in the base unit phonebook, without having to dial manually.

- 1 During an outside call, press **[MENU]**.
- 2 **"Phonebook"** → **[SET]**
- 3 Find the desired item (page 34). → **[SET]**

Note:

- When storing a calling card access number and your PIN in the phonebook as one phonebook item, press **[PAUSE]** to add pauses after the number and PIN as necessary (page 27).
- If you have rotary or pulse service, you need to press **[✳]** before pressing **[MENU]** in step 1 to change the dialing mode temporarily to tone.

Copying base unit phonebook items

You can copy one or all of the phonebook items from the base unit to the phonebook of a compatible Panasonic unit (KX-THA11/KX-THA12/KX-THA16/KX-THA17).

Copying an item

- 1 **[MENU]** →  → **[SET]** 2 times
- 2 **"Copy phonebook"** → **[SET]**
- 3 **"Copy 1 item"** → **[SET]**
- 4 Select the destination unit. → **[SET]**
- 5 Find the desired item (page 34). → **[SET]**
- 6 Press **[STOP]** after **"Complete"** is displayed.

Copying all items

- 1 **[MENU]** →  → **[SET]** 2 times
- 2 **"Copy phonebook"** → **[SET]**
- 3 **"Copy all items"** → **[SET]**
- 4 Select the destination unit. → **[SET]**
- 5 Press **[STOP]** after **"Complete"** is displayed.

Using Caller ID service



This unit is Caller ID compatible. To use Caller ID features, you must subscribe to your telephone company's Caller ID service.

Caller ID features

When an outside call is being received, the calling party's name and telephone number are displayed.

Caller information for the last 50 different callers is logged in the caller list, allowing you to return missed calls. Caller information is stored by the most recent call to the oldest.

- Generally caller information is displayed from the 2nd ring.
- If the unit cannot receive caller information, the following is displayed:
 - “**Out of area**”: The caller dialed from an area which does not provide Caller ID service.
 - “**Private caller**”: The caller requested not to send caller information.
 - “**Long distance**”: The caller called you long distance.
- If the unit is connected to a PBX system, caller information may not be received properly. Consult your PBX supplier.

Private name display

When caller information is received and it matches a phone number stored in the phonebook, the stored name is displayed and logged in the caller list.

Call Waiting Caller ID display

If you subscribe to both Caller ID and Call Waiting with Caller ID services, the 2nd caller's information is displayed after you hear a Call Waiting tone (page 29).

Note:

- Please contact your telephone company for details and availability of this service in your area.

Talking Caller ID

This feature lets you know who is calling without looking at the display. When a call comes in, the handset announces the caller's name displayed on the handset following every ring.

To use this feature, you must subscribe to your telephone company's Caller ID service.

- Name pronunciation may vary. This feature may not pronounce all names correctly.
- Caller ID supports names of up to 15 letters. If the caller's name has more than 15 letters, the name is not displayed or announced correctly.
- Usually the handset announces the caller's name after the 2nd ring. If you turn on the answering system and set the ring count to “**2 rings**” (page 61), the handset does not announce the caller's name. If “**Toll saver**” is selected and there is a new message, the handset does not announce the caller's name.
- When you receive a call while on the phone, the 2nd caller's name is not announced even if you subscribe to both Caller ID and Call Waiting with Caller ID services.
- This feature can be turned on or off (page 50).

Ringer ID

This feature can help you identify who is calling by using different ringers for different callers stored in the phonebook (page 31, 34). You can assign a different ringer to each phonebook item. When a call is received from a caller stored in the phonebook, the ringer is used after Caller ID information is displayed.

Light-up ID

This feature can help you identify who is calling by using different ringer indicator colors for different callers stored in the handset phonebook (page 31). You can assign a different indicator color to each handset phonebook item. When a call is received from a caller stored in the handset phonebook, the indicator color is used after Caller ID information is displayed.

Caller list

Caller information for the last 50 different callers is logged in the caller list. You can use this list to return missed calls.

Missed calls

If a call is not answered, the unit treats the call as a missed call. The number of missed calls is shown on the display. This lets you know if you should view the caller list to see who called while you were out.

Viewing the caller list and calling back

Handset

1 **[MENU]** (center of joystick) →  → **[SELECT]**

2 Push **[▼]** to search from the most recent call, or **[▲]** to search from the oldest call.

3 

Note:

- If the indicated line is already being used or you want to select the other line, select the desired line by pressing **[LINE1]** or **[LINE2]**.
- If you have registered a cellular phone to the base unit (page 64), you can make a call by pressing **[CALL]**, then pressing **[LINE1]** or **[LINE2]**.

Base unit

1 **[MENU]** →  → **[SET]**

2 Press **[▼]** to search from the most recent call, or **[▲]** to search from the oldest call.

3 **[SP-PHONE]**

Note:

- If the indicated line is already being used or you want to select the other line, select the desired line by pressing **[LINE1]** or **[LINE2]**.

Displayed symbols

- **1** and **2** indicate which line the caller information was received from.
- If the same caller calls more than once, it is displayed with the number of times the caller called (“x2” to “x9”). Only the date and time of the most recent call is stored.
- A **✓** is displayed next to items which have already been viewed or answered.

Editing a caller’s phone number before calling back

You can edit a phone number in the caller list by removing its area code and/or the long distance code “1”.

Handset

1 [MENU] (center of joystick) → **CTD** → **[SELECT]**

2 Select the desired item.

3 Press **[EDIT]** repeatedly until the phone number is shown in the desired format.

① Local phone number

Example:

② Area code – Local phone number

Example:

③ 1 – Area code – Local phone number

Example:

4 [↶]

Base unit

1 [MENU] → **CTD** → **[SET]**

2 Select the desired item.

3 Press **[EDIT]** repeatedly until the phone number is shown in the desired format.

① Local phone number

Example:

② Area code – Local phone number

Example:

③ 1 – Area code – Local phone number

Example:

4 [SP-PHONE]

Caller ID number auto edit feature

Once you call back an edited number, the unit can automatically edit other incoming phone numbers each time you receive a call.

For example, you can use this feature to set the unit to ignore the area code of callers in your area code, so that you can call these local numbers using caller information without dialing the area code. To activate this feature, you must edit an item in the caller list, then call that number. After that, phone numbers from that caller’s area code are edited automatically. This feature can be turned on or off (page 50). The default setting is “on”.

Note:

- Phone numbers from the 4 most recently edited area codes are automatically edited.
- If you move to another area, you can turn this feature off to erase previously edited area codes. To use this feature again, turn it on and reprogram the area codes you want to edit once again.

Storing caller information into the phonebook

Handset

- 1 **[MENU]** (center of joystick) →  → **[SELECT]**
- 2 Select the desired item.
 - To edit the number, press **[EDIT]** repeatedly until the phone number is shown in the desired format.
- 3 **[▶]** to save.
 - Enter the name if necessary (page 31). → **[NEXT]**
- 4 Select the desired ringer ID. → **[NEXT]**
- 5 Select the desired light-up ID. → **[NEXT]** → **[SAVE]** → **[OFF]**

Base unit

- 1 **[MENU]** →  → **[SET]**
- 2 Select the desired item.
 - To edit the number, press **[EDIT]** repeatedly until the phone number is shown in the desired format.
- 3 **[▶]** to save.
 - Enter the name if necessary (page 31). → **[SET]**
- 4 Change the ringer ID, if necessary. → **[SET]** 2 times → **[STOP]**

Erasing caller information

Erasing a selected item

Handset

- 1 **[MENU]** (center of joystick) →  → **[SELECT]**
- 2 Select the desired item.
- 3 **[CLEAR]** → **[OFF]**

Base unit

- 1 **[MENU]** →  → **[SET]**
- 2 Select the desired item.
- 3 **[ERASE]** → **[STOP]**

Erasing all items

Handset

- 1 **[MENU]** (center of joystick) →  → **[SELECT]**
- 2 **[ERASE]** → **[YES]**
- 3 Press **[OFF]** after "All erased" is displayed.

Base unit

- 1 **[MENU]** →  → **[SET]**
- 2 **[ERASE]** → **[▶]**
- 3 Press **[STOP]** after "All erased" is displayed.

Intercom feature

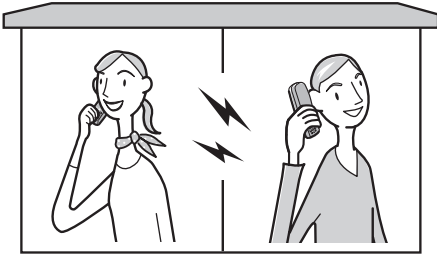

Intercom calls can be made between the handset and the base unit, and between the handset and a compatible Panasonic unit (KX-THA11/KX-THA12/KX-THA16/KX-THA17).

Making intercom calls

Handset

- 1 [INTERCOM]**
- 2** To page the base unit, press **[0]**.
To page another handset, enter its extension number (**[1]** to **[8]**).
 - The destination unit beeps for 1 minute.
 - To stop paging, press **[OFF]**.
- 3** To end the intercom call, press **[OFF]**.

Base unit

- 1 [INTERCOM]**
- 2** To page a handset, enter its extension number (**[1]** to **[8]**).
To page all handsets, press **[0]**.
 - The handset(s) beeps for 1 minute.
 - To stop paging, press **[INTERCOM]**.
 - Even if you call all handsets, only the handset user who answers first can take the intercom call.
- 3** To end the intercom call, press **[INTERCOM]**.

Note:

- You can also locate a misplaced handset by paging it (handset locator).

Answering intercom calls

When the unit is being paged, it rings and displays the extension number of the paging party.

Handset

- 1** Press **[] to answer the page.**
- 2** To end the intercom call, press **[OFF]**.

Base unit

- 1** To answer the page, press **[INTERCOM]**.
- 2** To end the intercom call, press **[INTERCOM]**.

Note for handset and base unit:

- The ringer volume for intercom calls follows the higher volume level of the 2 lines (page 46).
- When the ringer volume is set to off for both lines, the handset and base unit will ring at the low level for intercom calls.

Transferring a call

Outside calls can be transferred between the handset and the base unit, and between the handset and a compatible Panasonic unit (KX-THA11/KX-THA12/ KX-THA16/KX-THA17).

Transferring calls

Handset

- 1 During an outside call, press **[INTERCOM]** to put the call on hold.
- 2 To page the base unit, press **[0]**.
To page another handset, enter its extension number (**[1]** to **[8]**).
 - If you do not wish to announce the transfer, skip to step 4.
- 3 Wait for the paged party to answer.
 - If the paged party does not answer, press **[LINE1]** or **[LINE2]** that is flashing to return to the outside call.
- 4 To complete the transfer, press **[OFF]**.

Base unit

- 1 During an outside call, press **[TRANSFER]** to put the call on hold.
- 2 To page a handset, enter its extension number (**[1]** to **[8]**).
To page all handsets, press **[0]**.
 - If you do not wish to announce the transfer, skip to step 4.
 - Even if you call all handsets, only the handset user who answers first can take the transferred call.
- 3 Wait for the paged party to answer.
 - If the paged party does not answer, press **[LINE1]** or **[LINE2]** that is flashing to return to the outside call.
- 4 To complete the transfer, press **[SP-PHONE]**.

Note for handset and base unit:

- If the paged party does not answer within 1 minute after you hang up, your phone rings and the call is returned to your phone. You can speak to the caller again by pressing **[LINE1]** or **[LINE2]** on the handset or **[LINE1]** or **[LINE2]** on the base unit.

Answering transferred calls



Handset

Press **[hook]** to answer the page.

- After the paging party hangs up the call, you can talk to the outside caller.

Base unit

Press **[INTERCOM]** to answer the page.

- After the paging party hangs up the call, you can talk to the outside caller.

Note for handset and base unit:

- If the paging party hangs up before you answer the page, "Incoming call" is displayed. Press **[LINE1]** or **[LINE2]** on the handset or **[LINE1]** or **[LINE2]** on the base unit to take the transferred call.

Transferring a call to the answering system

When you answer a call and the caller wants to talk to someone who is not available, you can transfer the caller to the answering system, where the caller can leave a message.

Tell the outside caller you will transfer him or her to the answering system.

Handset

- 1 During an outside call, press **[INTERCOM]** to put the call on hold.
- 2 Press **[9]** to hang up the call.

Base unit

- 1 During an outside call, press **[TRANSFER]** to put the call on hold.
- 2 Press **[9]** to hang up the call.

Note for handset and base unit:

- After you press **[9]**, the caller hears the greeting message (page 55) and can leave a message after the beep.

Conference calls

Conference call with 2 outside calls

While you are talking with an outside caller, you can make or answer a 2nd call on the other line, and then combine the calls to establish a conference call.

Handset

- 1 During an outside call, press **[HOLD]** 2 times.
- 2 To answer a 2nd call, press **[LINE1]** or **[LINE2]**.
To make a 2nd call, press **[LINE1]** or **[LINE2]**, then dial the phone number.
- 3 When the 2nd call is connected, press **[CONF]** to make a conference call.
 - To hang up only one line, press **[LINE1]** or **[LINE2]** for the party with which you want to continue talking.
 - To put both lines on hold, press **[HOLD]**. To talk with only one caller, press **[LINE1]** or **[LINE2]** for the party with which you want to continue talking. To resume both lines, press **[CONF]**.

Base unit

- 1 During an outside call, press **[HOLD]**.
- 2 To answer a 2nd call, press **[LINE1]** or **[LINE2]**.
To make a 2nd call, press **[LINE1]** or **[LINE2]**, then dial the phone number.
- 3 When the 2nd call is connected, press **[CONF]** to make a conference call.
 - To hang up only one line, press **[LINE1]** or **[LINE2]** for the party with which you want to continue talking.
 - To put both lines on hold, press **[HOLD]**. To talk with only one caller,

press **[LINE1]** or **[LINE2]**. To resume both lines, press **[CONF]**.

Note for handset and base unit:

- Multiple parties can join a conference call. The possible number of participating parties depends on the resources available for wireless communication. When another participating party cannot join a conversation, "**System is busy. Please try again later.**" is displayed.

Conference call with an outside call

While you are talking with an outside caller, one more extension can join the conversation and establish a conference call.

Handset

- 1 During an outside call, press **[INTERCOM]**.
- 2 To page the base unit, press **[0]**. To page another handset, enter its extension number (**[1]** to **[8]**).
- 3 When the paged party answers, press **[CONF]** to make a conference call.
 - To leave the conference, press **[OFF]**. The other 2 parties can continue the conversation.

Base unit

- 1 During an outside call, press **[INTERCOM]**.
- 2 To page a handset, enter its extension number (**[1]** to **[8]**). To page all handsets, press **[0]**.
- 3 When the paged party answers, press **[CONF]** on the base unit to make a conference call.

- To leave the conference, press **[SP-PHONE]**. The other 2 parties can continue the conversation.

Note for handset and base unit:

- The outside call can be put on hold by pressing **[HOLD]**. Only the person who placed the call on hold can resume the full conference by pressing **[CONF]** on the handset or **[CONF]** on the base unit.
- Multiple parties can join a conference call. The possible number of participating parties depends on the resources available for wireless communication. When another participating party cannot join a conversation, "**System is busy. Please try again later.**" is displayed.

Call share

This feature allows the handset or base unit to join an existing outside call.

Joining a conversation

Handset

Join the conversation by pressing **[LINE1]** or **[LINE2]** to select the line that is being used by another extension for an outside call.

- “**Conference**” is displayed.

Base unit

Join the conversation by pressing **[LINE1]** or **[LINE2]** to select the line that is being used by another extension for an outside call.

- “**Conference**” is displayed.

Note for handset and base unit:

- Multiple parties can join a conference call. The possible number of participating parties depends on the resources available for wireless communication. When another participating party cannot join a conversation, “**System is busy. Please try again later.**” is displayed.

Call privacy

Call privacy allows you to prevent other users from joining your conversations with outside callers. To allow other users to join your conversations, leave this feature off.

Handset

- 1** Press **[MENU]** (center of joystick) during an outside call.
- 2** To turn this feature on, select “**Privacy on**”.
To turn this feature off, select “**Privacy off**”.
- 3 [SELECT]**

Base unit

- 1** Press **[MENU]** during an outside call.
- 2** To turn this feature on, select “**Privacy on**”.
To turn this feature off, select “**Privacy off**”.
- 3 [SET]**

Note for handset and base unit:

- This feature will turn off after you hang up the call.

Monitoring feature

This feature allows you to monitor the room where a unit is located. The monitored unit does not ring, allowing you to easily monitor a baby's room, for example, from different areas of the house.

Note:

- You can place the handset on the charger while monitoring using the speakerphone.

Enabling monitoring access



To use the monitoring feature, you need to set the destination unit to be monitored beforehand.

- “**Permit**”: allows the unit to be monitored.
- “**Deny**”: denies access from other units.

Handset

- 1 **[MENU]** (center of joystick) → → **[SELECT]**
- 2 “**Monitor access**” → **[SELECT]**
- 3 Select the desired setting. (Default: “**Deny**”) → **[SAVE]** → **[OFF]**

Base unit

- 1 **[MENU]** → → **[SET]**
- 2 “**Monitor access**” → **[SET]**
- 3 Select the desired setting. (Default: “**Deny**”) → **[SET]** → **[STOP]**

Audio monitor



This feature allows you to listen to the audio in the room where the handset or base unit is located.

Before using this feature, allow access to the destination unit by selecting “**Permit**” in the monitor access setting (page 45).

Monitoring audio in the room



Handset

- 1 **[MENU]** (center of joystick) → → **[SELECT]**
- 2 Select the desired unit. → **[SELECT]**
 - You can listen to the audio.
- 3 Press **[OFF]** to stop monitoring.

Base unit

- 1 **[MENU]** → → **[SET]**
- 2 Select the desired unit. → **[SET]**
 - You can listen to the audio.
- 3 Press **[INTERCOM]** to stop monitoring.

Note for handset and base unit:

- To start monitoring quickly, press **[INTERCOM]**, then press **[*]** instead of step 1.

Ringer settings



Important:

- Many of the following features can be programmed using the MULTI TALK V USB Utility. Refer to the help section of the MULTI TALK V USB Utility application for more information (page 4).

Ringer volume

Handset

- 1 **[MENU]** (center of joystick) →  → **[SELECT]**
- 2 “Ringer volume” → **[SELECT]**
- 3 Select the desired line.
- 4 Select the desired volume. (Default: High)
 - To turn the ringer off, push **[▼]** repeatedly until “off ?” is displayed.

- 5 **[SAVE]** → **[OFF]**

Base unit

- 1 **[MENU]** →  → **[SET]**
- 2 “Ringer volume” → **[SET]**
- 3 Select the desired line.
- 4 Select the desired volume. (Default: High)
 - To turn the ringer off, press **[▼]** repeatedly until “off ?” is displayed.

- 5 **[SET]** → **[STOP]**

Note for handset and base unit:

- When the ringer volume is set to off for a line, “Ringer off” is displayed and the handset or base unit does not ring for outside calls received on that line.

Ringer tone

You can change the ringer tone heard when an outside call is received.

Important:

- You can record songs for the handset ringer tone from an audio device (page 47).
- You can copy songs (in WAV file format using a computer) to be used for the handset ringer tone. Refer to the help section of the MULTI TALK V USB Utility application for more information (page 4).

Handset

- 1 **[MENU]** (center of joystick) →  → **[SELECT]**
- 2 “Ringer tone” → **[SELECT]**
- 3 Select the desired line.
- 4 Select the desired item. (Default: Line 1: “Tone 1”, Line 2: “Tone 2”) → **[SAVE]** → **[OFF]**

Note:

- If you subscribe to a distinctive ring service (such as IDENT-A-RING), select a tone (tone 1 to 3) for the handset ringer tone. If you select a melody or a song, you cannot distinguish lines by their ringers.
- If you select a melody or a song for the handset ringer tone, the ringer continues to sound for several seconds if:
 - the caller hangs up before you answer the call.
 - another person answers the call using another phone connected on the same line.

- The preset song “**Melody 1**” in this product is used with the permission of © 2005 Speed Crazy.
- The preset songs “**Tone 4**”, “**Tone 5**”, and “**Melody 2**” in this product are used with the permission of © 2005 M-ZoNE Co., Ltd.

Base unit

- 1** [MENU] → (⏏) → [SET]
- 2** “Ringer tone” → [SET]
- 3** Select the desired line.
- 4** Select the desired item. (Default: Line 1: “Tone 1”, Line 2: “Tone 2”) → [SET] → [STOP]

Recording songs from an audio device for ringer tones using the handset (“Customize ring”)

You can record songs (max. 30 seconds each) from an audio device by connecting the included audio cable. These songs can be assigned as the handset ringer tone (page 46) and the ringer ID (page 37) for phone numbers stored in the handset phonebook.

Important:

- If a call is received while a song is being recorded or played back, recording or playback stops automatically. Disconnect the audio cable from the handset to answer the call.

- 1** Connect the audio device (such as a CD player or computer) to the handset using the included audio cable.

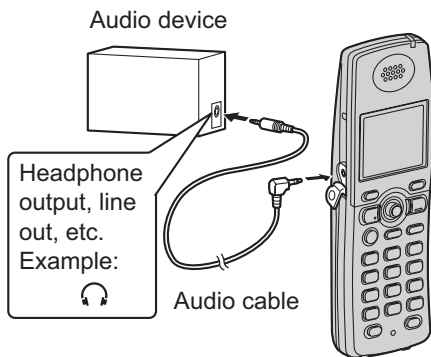

- 2** [MENU] (center of joystick) → (⏏) → [SELECT]
- 3** “Customize ring” → [SELECT]
- 4** “Record” → [SELECT]
- 5** Start playing the audio device.
- 6** Press [REC.] to start recording.
- 7** To stop recording, press [STOP].
 - To listen to the recording, select “Playback”, then press [SELECT].
 - To re-record, select “Retry”, press [SELECT], then start from step 5.
- 8** “Save” → [SELECT]
- 9** Enter the desired name (max. 15 characters; page 31).
- 10** [SAVE] → [OFF]
- 11** Disconnect the audio cable from the handset.

Note:

- The total recording time is about 120 seconds.

Programmable Settings

Playing back a song

- 1 **[MENU]** (center of joystick) →  → **[SELECT]**
- 2 “Customize ring” → **[SELECT]**
- 3 “Playback” → **[SELECT]**
- 4 Select the desired song. → **[PLAY]**
- 5 **[STOP]** → **[OFF]**

Erasing a song

While the song is selected or playing, press **[ERASE]**, then press **[YES]**.

Note:

- If the erased song was used for the handset ringer tone (page 46), “**Tone 1**” or “**Tone 2**” (default) is used instead of that song.
- If the erased song was assigned to certain callers as ringer ID (page 37), the ringer ID assignment is canceled, and the handset ringer tone (page 46) is used instead of that song.

Changing the name of a song

- 1 **[MENU]** (center of joystick) →  → **[SELECT]**
- 2 “Customize ring” → **[SELECT]**
- 3 “Edit title” → **[SELECT]**
- 4 Select the desired song. → **[EDIT]**
- 5 Edit the name (max. 15 characters; page 31).
- 6 **[SAVE]** → **[OFF]**

Ring color

You can change the ringer indicator color used when an outside call is received.

- 1 **[MENU]** (center of joystick) →  → **[SELECT]**
- 2 “Ring color” → **[SELECT]**
- 3 Select the desired color. (Default: “Color 1”) → **[SAVE]** → **[OFF]**

Interrupt tone

This tone lets you know when you receive a call while you are on the other line, on an intercom call, or monitoring a room.

- “**2**”: The tone sounds 2 times.
- “**on**”: The tone sounds for as long as the line rings.
- “**off**”: Turns this feature off.

Handset

- 1 **[MENU]** (center of joystick) →  → **[SELECT]**
- 2 “Interrupt tone” → **[SELECT]**
- 3 Select the desired setting. (Default: “2”) → **[SAVE]** → **[OFF]**

Base unit

- 1 **[MENU]** →  → **[SET]**
- 2 “Interrupt tone” → **[SET]**
- 3 Select the desired setting. (Default: “2”) → **[SET]** → **[STOP]**

Other settings

Time adjustment (Caller ID subscribers only)

This feature allows the unit to automatically adjust the date and time setting when caller information is received. To turn this feature on, select “**Caller ID [auto]**”. To turn this feature off, select “**Manual**”.

- You only need to program this setting once, using either the handset or base unit.

Important:

- To use this feature, set the date and time manually first (page 25).

Handset

- 1 **[MENU]** (center of joystick) →  → **[SELECT]**
- 2 “**Time adjustment**” → **[SELECT]**
- 3 Select the desired setting. (Default: “**Caller ID [auto]**”) → **[SAVE]** → **[OFF]**

Base unit

- 1 **[MENU]** →  → **[SET]**
- 2 “**Time adjustment**” → **[SET]**
- 3 Select the desired setting. (Default: “**Caller ID [auto]**”) → **[SET]** → **[STOP]**

Changing the handset/base unit name

Each handset and the base unit can be given a customized name (“Bob”, “Kitchen”, etc.), this is useful when you have multiple units.

Handset

- 1 **[MENU]** (center of joystick) →  → **[SELECT]**
- 2 “**Device name**” → **[SELECT]**
- 3 Enter the desired the name (max. 10 characters; page 31). (Default: “**Handset**”)
- 4 **[SAVE]** → **[OFF]**

Base unit

- 1 **[MENU]** →  → **[SET]**
- 2 “**Device name**” → **[SET]**
- 3 Enter the desired name (max. 10 characters; page 31). (Default: “**Base TH102**”)
- 4 **[SET]** → **[STOP]**

Handset voice enhancer

You can turn the voice enhancer feature on or off for the handset.

- 1 **[MENU]** (center of joystick) →  → **[SELECT]**
- 2 “**Voice enhancer**” → **[SELECT]**
- 3 Select the desired setting. (Default: “**off**”) → **[SAVE]** → **[OFF]**

Handset Talking Caller ID

You can turn the Talking Caller ID feature on or off for the handset.

- 1 **[MENU]** (center of joystick) →  → **[SELECT]**
- 2 "Talking CallerID" → **[SELECT]**
- 3 Select the desired setting. (Default: "On") → **[SAVE]** → **[OFF]**

Display contrast

Handset

- 1 **[MENU]** (center of joystick) →  → **[SELECT]**
- 2 "LCD contrast" → **[SELECT]**
- 3 Select the desired setting. (Default: Level 3) → **[SAVE]** → **[OFF]**

Base unit

- 1 **[MENU]** →  → **[SET]**
- 2 "LCD contrast" → **[SET]**
- 3 Select the desired setting. (Default: Level 3) → **[SET]** → **[STOP]**

Handset key tone

You can select whether or not key tones are heard when keys are pressed. Key tones include confirmation tones and error tones.

- 1 **[MENU]** (center of joystick) →  → **[SELECT]**
- 2 "Key tone" → **[SELECT]**
- 3 Select the desired setting. (Default: "On") → **[SAVE]** → **[OFF]**

Handset auto talk

When this feature is turned on, you can answer a call by lifting the handset off the charger without pressing .

- 1 **[MENU]** (center of joystick) →  → **[SELECT]**
- 2 "Auto talk" → **[SELECT]**
- 3 Select the desired setting. (Default: "off") → **[SAVE]** → **[OFF]**

Note:

- If you subscribe to Caller ID service and want to view the caller's information on the handset display after lifting up the handset to answer a call, turn off this feature.
- If you set the line selection mode from "Auto" to "Line1" or "Line2" (page 51), the auto talk feature will function for that line only. If the other line receives a call, the auto talk feature will not function.

Caller ID number auto edit



You can turn the Caller ID number auto edit feature on or off.

Handset

- 1 **[MENU]** (center of joystick) →  → **[SELECT]**
- 2 "Caller ID edit" → **[SELECT]**
- 3 Select the desired setting. (Default: "On") → **[SAVE]** → **[OFF]**

Base unit

- 1 **[MENU]** →  → **[SET]**
- 2 "Caller ID edit" → **[SET]**
- 3 Select the desired setting. (Default: "On") → **[SET]** → **[STOP]**

Setting telephone line

Line selection

The line selection mode determines which line is selected when you press [**↶**] on the handset or [**SP-PHONE**] on the base unit.

- “**Auto**”: When making a call, line 1 is selected. If that line is unavailable, line 2 is selected. When answering a call, the ringing line is selected.
- “**Line1**”: Line 1 is selected.
- “**Line2**”: Line 2 is selected.

Handset

- 1** [**MENU**] (center of joystick) →  → [**SELECT**]
- 2** “Set tel line” → [**SELECT**]
- 3** “Line select” → [**SELECT**]
- 4** Select the desired setting. (Default: “Auto”) → [**SAVE**] → [**OFF**]

Note:

- You can select a line manually regardless of the line selection mode by pressing [**LINE1**] or [**LINE2**].

Base unit

- 1** [**MENU**] →  → [**SET**]
- 2** “Set tel line” → [**SET**]
- 3** “Line select” → [**SET**]
- 4** Select the desired setting. (Default: “Auto”) → [**SET**] → [**STOP**]

Note:

- You can select a line manually regardless of the line selection mode by pressing [**LINE1**] or [**LINE2**].

Flash time

The flash time depends on your telephone exchange or host PBX.

- You only need to program this setting once, using either the handset or base unit.

Important:

- The setting should stay at 700 ms unless pressing [**FLASH**] fails to pick up the Call Waiting call.

Handset

- 1** [**MENU**] (center of joystick) →  → [**SELECT**]
- 2** “Set tel line” → [**SELECT**]
- 3** “Set flash time” → [**SELECT**]
- 4** Select the desired line.
- 5** Select the desired setting. (Default: “700ms”) → [**SAVE**] → [**OFF**]

Base unit

- 1** [**MENU**] →  → [**SET**]
- 2** “Set tel line” → [**SET**]
- 3** “Set flash time” → [**SET**]
- 4** Select the desired line.
- 5** Select the desired setting. (Default: “700ms”) → [**SET**] → [**STOP**]

Note for handset and base unit:

- If the unit is connected via a PBX, certain PBX functions (call transferring, etc.) may not work correctly. Consult your PBX supplier for the correct setting.

Line mode

Generally, the line mode setting should not be adjusted.

When another phone connected to the same line is in use, and

- if **L1** or **L2** is not displayed on the handset, or
- if **[LINE1]** or **[LINE2]** button light is off on the base unit,

you need to change the line mode to “A”.

- You only need to program this setting once, using either the handset or base unit.

Handset

- 1 **[MENU]** (center of joystick) →  → **[SELECT]**
- 2 “Set tel line” → **[SELECT]**
- 3 “Set line mode” → **[SELECT]**
- 4 Select the desired line.
- 5 Select the desired setting. (Default: “B”) → **[SAVE]** → **[OFF]**

Base unit

- 1 **[MENU]** →  → **[SET]**
- 2 “Set tel line” → **[SET]**
- 3 “Set line mode” → **[SET]**
- 4 Select the desired line.
- 5 Select the desired setting. (Default: “B”) → **[SET]** → **[STOP]**

Changing the PIN (personal identification number)

For security, the PIN must be entered when changing certain settings such as registering units. The default setting is “7262”.

Important:

- If you change the PIN, please make note of your new PIN. The unit does not reveal the PIN to you.

- 1 **[MENU]** →  → **[SET]**
- 2 “Set PIN” → **[SET]**
- 3 To change the PIN for the first time, skip to step 4.
To change the PIN, enter the current 4-digit PIN. → **[SET]**
- 4 Enter the new 4-digit PIN. → **[SET]**
- 5 Enter the new 4-digit PIN again. → **[SET]** → **[STOP]**

If you forget the PIN (resetting the base unit to its default settings)

If you set the PIN and you cannot remember it, you can reset the base unit using the following procedures.

Base unit:

[MENU] → **[MUTE]** → **[#][9][0][0][0]**

Note:

- The following items are reset to their default settings:
 - Settings checked in the base reset column on page 93
 - Answering system: On
 - Line selection for answering system: Line 1 and line 2
- If you have registered a cellular phone, the following cellular phone settings are also reset to their default settings.
 - “Assign Base/HS” (Allows you to select which unit to ring for cellular calls, page 69): “All”

- "TAD (cell)" (Answering system for cellular phone, page 69): "off"
- "TAD ring count" (Ring count of answering system for cellular phone, page 69): "4"

Call reservation

The resources available for wireless communication (making or answering calls with a handset, monitoring camera images from a computer, etc.) are limited. When this feature is turned on, the system will limit data communications and reserve enough resources so that 1 handset can always make or answer outside calls. When this feature is turned off, data communications will not be limited, but it is possible that calls cannot be made or answered with a handset when data traffic is heavy.

- 1 [MENU] →  → [SET]
- 2 "Call reservation" → [SET]
- 3 Select the desired item. (Default: "on")
→ [SET] → [STOP]

Customer support

The handset and base unit can display the Internet address where you can download the operating instructions or get further information for this product using your computer.

Handset

- 1 [MENU] (center of joystick) →  → [SELECT]
- 2 "Customer support" → [SELECT]
 - The Internet address is displayed.
- 3 [OFF]

Base unit

- 1 [MENU] →  → [SET]
- 2 "Customer support" → [SET]
 - The Internet address is displayed.
- 3 [STOP]

Registering a unit

Registering the handset

The included handset and base unit are preregistered. If for some reason the handset is not registered to the base unit, register the handset.

Important:

- Before registering a compatible Panasonic unit to the base unit, we recommend you change the PIN (page 52) so that other Bluetooth devices in the area are not accidentally registered at the same time.
- If you have already canceled the handset registration at the previous base unit, perform steps 2 and 3 only.

1 Handset:

[MENU] (center of joystick) →  → **[SELECT]** → “Registration” → **[SELECT]** → “Registration” → **[SELECT]**

2 Base unit:

Press and hold **[INTERCOM]** until it starts flashing and a beep sounds.

- After **[INTERCOM]** starts flashing, the rest of the procedure must be completed within 2 minutes.

3 Handset:

Press **[OK]**, then wait until the handset beeps.

- If you have changed the PIN, enter it and press **[OK]**, then wait until the handset beeps.

Deregistering a unit

Deregistering a handset

Handset

A handset can cancel its own registration.

1 [MENU] (center of joystick) →  → **[SELECT]**

2 “Registration” → **[SELECT]**

3 “Deregistration” → **[SELECT]**

4 [3][3][5] → **[OK]**

Deregistering another device

Base unit

The base unit can cancel a registered unit (cordless camera, USB adaptor, Bluetooth cellular phone, Bluetooth headset).

1 [MENU] →  → **[SET]**

2 “Deregistration” → **[SET]**

3 Select the desired device. → **[SET]**

4 [3][3][5] → **[SET]** → **[STOP]**

Answering system feature



Important:

- Only 1 person can access the answering system (listen to messages, record a greeting message, etc.) at a time.
- When callers leave messages, the unit records the day and time of each message. Make sure the date and time have been set (page 25).
- You can use your computer with the included MULTI TALK V USB Utility to play, erase, and save answering system messages. Refer to the help section of the MULTI TALK V USB Utility application for more information (page 4).

Memory capacity

The total recording capacity (including your greeting message, caller messages, and voice memos) is about 60 minutes. A maximum of 99 messages (including a greeting message) can be recorded.

- If the message memory becomes full, the ANSWER ON indicator flashes rapidly (if the answering system is turned on).
To record additional messages, erase unnecessary messages (page 57).
- If less than 10 minutes of recording time is available, the unit announces the remaining recording time when operating the answering system.
- Messages are retained even if a power failure occurs.

Setting up the answering system

Turning the answering system on

Press **[LINE SELECT]** repeatedly to select the desired line(s). → **[ANSWER ON]**

- The ANSWER ON indicator lights.

Turning the answering system off Press **[ANSWER ON]**.

- The ANSWER ON indicator turns off.

Screening your calls

While a caller is leaving a message, you can listen to the call through the base unit's speaker. To adjust the speaker volume, press **[▲]** or **[▼]**.

Note:

- To answer the call, press **[LINE1]** or **[LINE2]** being called on the base unit or **[LINE1]** or **[LINE2]** being called on the handset.
- To turn this feature off, see page 62.

Recording your greeting message

You can record your own greeting message (max. 2 minutes) that is played when the answering system answers a call.

The greeting messages can be recorded:

- for each line.
 - for both lines using a common greeting.
- If you do not record a greeting message, a pre-recorded greeting message is used.

1 **[MENU]** →  → **[SET]**

2 "Greeting record" → **[SET]**

3 Select the desired line(s). → **[SET]**

4 After the base unit beeps, speak clearly about 20 cm (8 inches) away from the MIC.

5 To stop recording, press **[STOP]**.

Playing back the greeting message

1 **[MENU]** →  → **[SET]**

2 “Greeting check” → **[SET]**

3 Select the desired line.

Erasing your greeting message

1 **[MENU]** →  → **[SET]**

2 “Greeting check” → **[SET]**

3 Select the desired line.

4 Press **[ERASE]** while your greeting message is playing.

Pre-recorded greeting message

If you erase or do not record your own greeting message, the unit can play a prerecorded greeting message for callers and ask them to leave messages. If the message recording time (page 62) is set to “Greeting only”, caller messages are not recorded and the unit plays a different prerecorded greeting message asking callers to call again.

Listening to messages using the base unit

When new messages have been recorded, the MESSAGE indicator on the base unit flashes.

Press **[MESSAGE]**.

- The base unit plays new messages including memo messages.
- When you have no new messages, the base unit plays back all messages.

Playing back messages for the desired line(s)

Press **[LINE SELECT]** repeatedly to select the desired line(s), then press **[MESSAGE]**.

Note:

- After selecting the line(s), memo messages do not play.

Adjusting the speaker volume

Press **[▲]** or **[▼]** while listening to a message.

Useful features during playback



Repeating a message

Press **[◀]**.

- If pressed within the first 5 seconds of a message, the previous message will be played.

Skipping a message

Press **[▶]**.

Pausing a message

Press **[STOP]**.

- To resume playback, press **[MESSAGE]**.
- To stop playback completely, press **[STOP]** again.

Calling back (Caller ID subscribers only)

If Caller ID information was received for the call, you can call the caller back while listening to the message.

Press **[SP-PHONE]** during playback.

Note:

- To edit the number before calling back, press **[EDIT]** to select the desired format (page 38).

Erasing messages 

Erasing a message

Press **[ERASE]** during playback.

Erasing all messages

Press **[ERASE]** 2 times while the base unit is not being used.

- To erase the messages for the desired line, press **[LINE SELECT]** repeatedly to select the desired line(s), then press **[ERASE]** 2 times.

Listening to messages using the handset

When new messages have been recorded:

- “**New message**” is displayed.
- The message indicator on the handset flashes slowly if the message alert feature is turned on (page 63).

1 [MENU] (center of joystick)

2  → **[SELECT]**

- The handset plays new messages including memo messages.
- When you have no new messages, the handset plays back all messages.

3 Press **[OFF]** when finished.

Note:

- To switch to the receiver, press **[↶]**.

Adjusting the receiver/speaker volume

Push **[▲]** or **[▼]** while listening to a message.

Voice guidance

If you do not press any buttons after the last message is played back, the unit's voice guidance starts. Operate the answering system by following the guidance as necessary.

Useful features during playback



Calling back (Caller ID subscribers only)

If Caller ID information was received for the call, you can call the caller back while listening to the message.

Press **[LINE1]** or **[LINE2]** during playback.

Note:

- To edit the number before calling back, press **[EDIT]** to select the desired format (page 38).

Answering system commands

You can also select the desired line(s) and press dial keys to access certain answering system functions using the handset during playback.

1 [MENU] (center of joystick) → → **[SELECT]**

- 2** Select the desired line(s) if necessary.
 For line 1: **[#][1]**
 For line 2: **[#][2]**
 For line 1 and line 2: **[#][0]**

3 Press the desired dial keys.

Key	Command
[1] or [←]	Repeat message (during playback). ^{*1}
[2] or [→]	Skip message (during playback).
[4]	Play new messages.
[5]	Play all messages.
[9]	Stop playback. ^{*2}
[0]	Turn answering system off.
[*][4] or [CLEAR]	Erase this message (during playback).
[*][5]	Erase all messages.

Key	Command
[#][1][8]	Turn answering system on for line 1 only.
[#][2][8]	Turn answering system on for line 2 only.
[#][0][8]	Turn answering system on for both line 1 and line 2.

*1 If pressed within the first 5 seconds of a message, the previous message is played.

*2 To resume operation, press a command key within 15 seconds, or the voice guidance will start.

Note:

- After selecting the line(s), memo messages do not play.

Voice memo

Recording a voice memo

You can use the base unit to leave a voice memo (voice message) for yourself or someone else (max. 3 minutes). This memo can be played back later, either directly with the base unit or remotely.

1 [MEMO]

2 After the base unit beeps, speak clearly about 20 cm (8 inches) away from the MIC.

3 To stop recording, press [STOP].

Remote operation

Using a touch tone phone, you can call your phone number from outside and access the unit to listen to messages. The unit's voice guidance prompts you to press certain dial keys to perform different operations.

Important:

- In order to operate the answering system remotely, you must first set a remote code (page 61). This code must be entered each time you operate the answering system remotely.

Using the answering system remotely

- 1 Dial your phone number from a touch tone phone.
- 2 After the greeting message starts, enter your remote code.
 - The unit plays back new messages, including memo messages.
- 3 After 3 seconds, the voice guidance starts. Follow the voice guidance as necessary.
- 4 When finished, hang up.

Note:

- You can ignore the voice guidance and control the unit using remote commands (page 60).

Voice guidance

During remote operation, the unit's voice guidance prompts you to press **[1]** to perform a specific operation, or press **[2]** to listen to more available operations.

Operations are presented by voice guidance in the following order:

- Play back all messages
- Play back new messages

- Record a message
- Erase all messages
- Record your greeting message

Note:

- If you do not press any dial keys within 10 seconds after a voice guidance prompt, the unit disconnects your call.
- If less than 10 minutes of recording time is available, the unit announces the remaining recording time after the last message is played back.

Remote commands

You can select the desired line(s) and press dial keys to access certain answering system functions without waiting for the voice guidance to prompt you.

- 1 Select the desired line(s) while you are accessing the answering system if necessary.

For line 1: **#[1]**

For line 2: **#[2]**

For line 1 and line 2: **#[0]**

- 2 Press the desired dial keys.

Key	Remote command
[1]	Repeat message (during playback). ^{*1}
[2]	Skip message (during playback).
[4]	Play new messages.
[5]	Play all messages.
[9]	Stop recording/ playback. ^{*2}
[0]	Turn answering system off.
[*][4]	Erase this message (during playback).
[*][5]	Erase all messages.
#[1][7]	Record a greeting message for line 1 only.
#[2][7]	Record a greeting message for line 2 only.
#[0][7]	Record a common greeting message for both line 1 and line 2.
#[1][8]	Turn answering system on for line 1 only.
#[2][8]	Turn answering system on for line 2 only.
#[0][8]	Turn answering system on for both line 1 and line 2.

- *1 If pressed within the first 5 seconds of a message, the previous message is played.
- *2 To resume operation, enter a remote command within 15 seconds, or the voice guidance will start.

Note:

- After selecting the line(s), memo messages do not play.

Turning on the answering system remotely

If the answering system is off, you can turn it on remotely by calling the line selected in "Turning the answering system on 

 on page 55.

- 1 Dial your phone number.
- 2 Let the phone ring 15 times.
 - The unit answers your call with the greeting message.
 - You can hang up, or if you call from a touch tone phone, you can enter your remote code and begin remote operation (page 59).

Skipping the greeting message to leave a message

You can leave a message just as any outside caller can. Call your phone number, then press **[*]** to skip the greeting message and record your message after the beep.

Answering system settings

Remote code 

A remote code must be entered when operating the answering system remotely. This code prevents unauthorized parties from listening to your messages remotely.

- 1 **[MENU]** →  → **[SET]**
- 2 "Remote code" → **[SET]**
- 3 Enter the desired 2-digit remote code. (Default: "11")
- 4 **[SET]** → **[STOP]**

Ring count 

You can change the number of times the phone rings before the unit answers calls. "To11 saver": The unit answers on the 2nd ring when new messages have been recorded, and on the 4th ring when there are no new messages. If you call your phone from outside to listen to new messages (page 59), you will know that there are no new messages when the phone rings for the 3rd time. You can then hang up without being charged for the call.

- 1 **[MENU]** →  → **[SET]**
- 2 "Ring count" → **[SET]**
- 3 Select the desired line.
- 4 Select the desired setting. (Default: "4 rings") → **[SET]** → **[STOP]**

For Voice Mail service subscribers

If you subscribe to a flat-rate bundle service that includes Caller ID, Call Waiting, Voice Mail, and unlimited local/regional/long distance calls, please note the following:

- To use the Voice Mail service provided by your telephone company rather than the unit's answering system, turn off the answering system (page 55).
This unit does not have an indicator to indicate if there are new messages in your mailbox service.
- To use this unit's answering system rather than the Voice Mail service provided by your telephone company, please contact your telephone company to deactivate your Voice Mail service. If your telephone company cannot do this:
 - Set this unit's "Ring count" setting so that this unit's answering system answers calls before your telephone company's Voice Mail service tries to answer your calls. It is necessary to check the ring count required to activate the Voice Mail service provided by your telephone company before changing this setting.
 - Change the ring count of the Voice Mail service so that the answering system can answer the call first. To do so, consult your telephone company.

Caller's recording time 

You can change the maximum message recording time allotted to each caller.

"Greeting only": The unit plays the greeting message but does not record caller messages.

1 [MENU] →  → [SET]

2 "Recording time" → [SET]

3 Select the desired line.

4 Select the desired setting. (Default: "3min") → [SET] → [STOP]

Note:

- If the message memory becomes full, the unit automatically switches to the "Greeting only" mode. New messages will not be recorded.

Recording mode 

You can select a recording mode.

Enhanced recording provides improved sound quality, but the total recording capacity is reduced.

1 [MENU] →  → [SET]

2 "Recording mode" → [SET]

3 Select the desired item. (Default: "Standard recording 60min") → [SET] → [STOP]

Call screening 

This feature allows you to monitor a message from the speaker when the answering system is recording the message.

1 [MENU] →  → [SET]

2 "Call screening" → [SET]

3 Select the desired item. (Default: "on") → [SET] → [STOP]

Message alert

You can select whether or not the message indicator on the handset flashes in amber when new messages are recorded (page 57).

1 **[MENU]** (center of joystick) →  → **[SELECT]**

2 "Message alert" → **[SELECT]**

3 Select the desired setting. (Default: "off") → **[SAVE]** → **[OFF]**

Note:

- While message alert is on, battery operating time will be shortened (page 17).

Configuring a cellular phone



If your cellular phone is Bluetooth wireless technology compatible to the home communication system, you can use the handset or base unit to make or answer calls using a cellular line.

This feature is useful for maximizing the benefits of cellular services (such as free unlimited nights and weekends, or cellular to cellular calling plans) by utilizing unused peak minutes with your home phone.

To use this feature you must first:

- register your cellular phone to the base unit (page 64).
- turn on discoverable mode (page 64).
- connect the cellular phone to the base unit (page 65).

Important:

- The following procedures must be performed using the base unit.
- Up to 5 cellular phones can be registered (when other Bluetooth devices are not registered). There can be only one active Bluetooth connection at a time.
- To keep the cellular line stable between the base unit and cellular phone, we recommend you use a cellular phone within the range of the base unit.
- While you are on a cellular call, the battery of your cellular phone is being consumed. We recommend you place your cellular phone on its charger during the call.

Registering a cellular phone

Important:

- For more details and the list of compatible cellular phones, please visit: www.panasonic.com/MultiTalkV
- Before registering a Bluetooth device to the base unit, we recommend you change the PIN (page 52).

1 Base unit: [CELLULAR]

2 “Registration” → [SET]

- After pressing [SET], the rest of the procedure must be completed within 2 minutes.

3 Your cellular phone:

Follow the instructions of your cellular phone to enter the registration mode.

- Depending on your cellular phone, it may ask you to enter the base unit PIN (Default: “7262”).

Note:

- To cancel a cellular phone from the base unit, see “Deregistering another device” on page 54.

Turning on the discoverable mode

When discoverable mode is turned on, this unit may be seen by other Bluetooth devices.

1 [MENU] → → [SET]

2 “Bluetooth” → [SET]

3 “Discoverable” → [SET]

4 Select the desired setting. (Default: “On”) → [SET] → [STOP]

Connecting the cellular phone



You need to connect to a registered cellular phone to the base unit before you can use this feature.

1 [CELLULAR]

2 "Connection" → [SET]

3 Select the desired cellular phone. → [SET]

- The selected cellular phones are indicated by "✓".

4 [STOP]

Note:

- In step 3, the base unit requires your cellular phone to accept the connection. Depending on your cellular phone, it may ask you if you accept the connection requirement from the base unit. Refer to the operating instructions of your cellular phone for further operations.

Making/answering calls using a cellular line

- Before making or answering calls, confirm that you have connected your cellular phone to the base unit (page 65).

Making calls

Handset

Important:

- You can place the handset on the charger while using the speakerphone. The call is not disconnected.

1 Dial the phone number. → [CELL]

- If you registered only one cellular phone, skip to step 4.

2 Select the desired cellular phone.

3 [SELECT]

4 When you finish talking, press [OFF].

Base unit

1 Dial the phone number. → [CELLULAR]

- If you registered only one cellular phone, skip to step 4.

2 Select the desired cellular phone.

3 [SET]

4 When you finish talking, press [SP-PHONE].

Answering calls

Handset

1 Press [] or [CELL].

2 When you finish talking, press [OFF].

Base unit

- 1 Press **[SP-PHONE]** or **[CELLULAR]**.
- 2 When you finish talking, press **[SP-PHONE]**.

Making calls using the phonebook

Handset

- 1 **[MENU]** (center of joystick) →  → **[SELECT]**
- 2 Push **[▲]** or **[▼]** to select the desired item.
- 3 **[CALL]** → **[CELL]**
 - If you registered only one cellular phone, skip to step 5.
- 4 Select the desired cellular phone. → **[SELECT]**
- 5 When you finish talking, press **[OFF]**.



Base unit

- 1 **[MENU]** →  → **[SET]**
- 2 Press **[▲]** or **[▼]** to select the desired item.
- 3 **[CELLULAR]**
 - If you registered only one cellular phone, skip to step 5.
- 4 Select the desired cellular phone. → **[SET]**
- 5 When you finish talking, press **[SP-PHONE]**.

Viewing the caller list and calling back

If you receive a call via cellular line, caller information is logged in the caller list with .



Handset

- 1 **[MENU]** (center of joystick) →  → **[SELECT]**
- 2 Push **[▲]** or **[▼]** to select the desired caller information indicated by .
- 3 **[CALL]** → **[CELL]**
 - If you registered only one cellular phone, skip to step 5.
- 4 Select the desired cellular phone. → **[SELECT]**
- 5 When you finish talking, press **[OFF]**.

Note:

- If the cellular line is already being used or you want to select the land line, select the desired line by pressing **[LINE1]** or **[LINE2]** instead of **[CELL]**.

Base unit

- 1 **[MENU]** →  → **[SET]**
- 2 Press **[▲]** or **[▼]** to select the desired caller information indicated by .
- 3 **[CELLULAR]**
 - If you registered only one cellular phone, skip to step 5.
- 4 Select the desired cellular phone. → **[SET]**
- 5 When you finish talking, press **[SP-PHONE]**.

Note:

- If the cellular line is already being used or you want to select the land line, select the desired line by pressing **[LINE1]** or **[LINE2]** instead of **[CELLULAR]**.

Useful features during a cellular call

Putting a cellular call on hold



Handset

Press **[HOLD]** 2 times during a cellular call.

- To return to the call, press **[↶]**.

Base unit

Press **[HOLD]** during a cellular call.

- To return to the call, press **[CELLULAR]**.

Note for handset and base unit:

- If a call is kept on hold for more than 6 minutes, an alarm tone starts to sound. After 4 additional minutes on hold, the call is disconnected.

Using the land line during a cellular call

Holding a cellular call to make or answer a land line call

Example: If you are on a cellular line call

Handset

- 1** To put the cellular call on hold, press **[HOLD]** 2 times.
- 2** To make a land line call, dial the phone number, then press **[LINE1]** or **[LINE2]**.
To answer a land line call, press **[LINE1]** or **[LINE2]**.
- 3** When you finish talking, press **[OFF]** to end the land line call.
- 4** To return to the cellular call, press **[↶]**.

Base unit

- 1** To put the cellular call on hold, press **[HOLD]**.
- 2** To make a land line call, dial the phone number, then press **[LINE1]** or **[LINE2]**.
To answer a land line call, press **[LINE1]** or **[LINE2]**.
- 3** When you finish talking, press **[SP-PHONE]** to end the land line call.
- 4** To return to the cellular call, press **[CELLULAR]**.

Holding a land line call and make or answer a cellular call

Example: If you are on a land line call

Handset

- 1** To put the land line call on hold, press **[HOLD]** 2 times.
 - 2 To make a cellular call**
 - If you have registered only one cellular phone, dial the phone number, then press **[CELL]**.
 - If you have registered more than one cellular phone, dial the phone number, then press **[CELL]**. Select the desired cellular phone, then press **[SELECT]**.
- To answer a cellular call**
Press **[CELL]**.
- 3** To return to the land line call, press the line button that is flashing on the handset.
 - The cellular call ends.

Base unit

- 1 To put the land line call on hold, press **[HOLD]**.
- 2 **To make a cellular call**
 - If you have registered only one cellular phone, dial the phone number, then press **[CELLULAR]**.
 - If you have registered more than one cellular phone, dial the phone number, then press **[CELLULAR]**. Select the desired cellular phone, then press **[SET]**.**To answer a cellular call**

Press **[CELLULAR]**.
- 3 To return to the land line call, press the line button that is flashing on the base unit.
 - The cellular call ends.

Cellular settings

Important:

- You must register your cellular phone to the base unit before programming.

Ringer settings for cellular calls



Ringer volume

You can change the ringer volume heard when a cellular call is received. You can change it for the handset and base unit individually.

Handset

- 1 **[MENU]** (center of joystick) → **Ⓜ** → **[SELECT]**
- 2 “Ringer for cell” → **[SELECT]**
- 3 “Ringer volume” → **[SELECT]**
- 4 Select the desired volume. (Default: High) → **[SAVE]** → **[OFF]**

Base unit

- 1 **[CELLULAR]**
- 2 “Cellular setting” → **[SET]**
- 3 “Ringer volume” → **[SET]**
- 4 Select the desired volume. (Default: High) → **[SET]** → **[STOP]**

Note for handset and base unit:

- When the ringer volume is set to off for a cellular line, “Ringer off” is not displayed in standby mode and the handset or base unit does not ring for cellular calls.

Ringer tone

You can change the ringer tone heard when a cellular call is received. You can change it for the handset and base unit individually.

Handset

- 1 **[MENU]** (center of joystick) → → **[SELECT]**
- 2 "Ringer for cell" → **[SELECT]**
- 3 "Ringer tone" → **[SELECT]**
- 4 Select the desired item. (Default: "Tone 3") → **[SAVE]** → **[OFF]**

Note:

- If you erase a customized ring for cellular call, "Tone 3" (default) is used instead of that ringer tone.

Base unit

- 1 **[CELLULAR]**
- 2 "Cellular setting" → **[SET]**
- 3 "Ringer tone" → **[SET]**
- 4 Select the desired item. (Default: "Tone 3") → **[SET]** → **[STOP]**

Selecting which unit to ring

You can select which handset or base unit rings when you receive a call from one of the registered cellular phones.

- 1 **[CELLULAR]**
- 2 "Cellular setting" → **[SET]**
- 3 "Assign Base/HS" → **[SET]**
- 4 Select the desired cellular phone. → **[SET]**
- 5 Select the desired unit, then press **[▶]**. (Default: "All")
 - The selected units are indicated by "✓".

- To cancel a selected unit, press **[▶]** again.

6 **[SET]** → **[OFF]**

Answering system settings for cellular calls

Setting the answering system for a cellular call

This feature allows the base unit to answer cellular calls when you are not available to answer cellular calls.

Important:

- To use this feature, you need to turn on the answering system for line 1 and/or line 2 (page 55).
- If this feature is turned on, the base unit plays the greeting message for line 1 and message is recorded on line 1.

1 **[CELLULAR]**

2 "Cellular setting" → **[SET]**

3 "TAD (cell)" → **[SET]**

4 Select the desired setting. (Default: "off") → **[SET]** → **[STOP]**

Note:

- "TAD" stands for Telephone Answering Device.

Ring count

You can change the number of times the cellular phone rings before the base unit answers cellular calls.

1 **[CELLULAR]**

2 "Cellular setting" → **[SET]**

3 "TAD ring count" → **[SET]**

4 Select the desired number. (Default: "4") → **[SET]** → **[STOP]**

Transferring a cellular call

Cellular calls can be transferred between the handset and the base unit, and between the handset and another compatible Panasonic unit (KX-THA11/KX-THA12/KX-THA16/KX-THA17). You can also switch a cellular call between a cellular phone and base unit.

Transferring a cellular call



Handset

- 1 During a cellular call, press **[INTERCOM]** to put the call on hold.
- 2 To page the base unit, press **[0]**.
To page another handset, enter its extension number (**[1]** to **[8]**).
 - If you do not wish to announce the transfer, skip to step 4.
- 3 Wait for the paged party to answer.
 - If the paged party does not answer, press **[↶]** to return to the cellular call.
- 4 To complete the transfer, press **[OFF]**.

Base unit

- 1 During a cellular call, press **[TRANSFER]** to put the call on hold.
- 2 To page a handset, enter its extension number (**[1]** to **[8]**).
To page all handsets, press **[0]**.
 - If you do not wish to announce the transfer, skip to step 4.
- 3 Wait for the paged party to answer.
 - If the paged party does not answer, press **[CELLULAR]** to return to the cellular call.

- 4 To complete the transfer, press **[SP-PHONE]**.

Note for handset and base unit:

- If the paged party does not answer within 1 minute after you hang up, your extension rings and the call is returned to your phone. You can speak to the caller again by pressing **[↶]** on the handset or **[CELLULAR]** on the base unit.
- To transfer a cellular call to the answering system, see page 42.

Answering a transferred cellular call



Handset

Press **[↶]** to answer the page.

- After the paging party hangs up the call, you can take the transferred call.

Base unit

Press **[INTERCOM]** to answer the page.

- After the paging party hangs up the call, you can take the transferred call.

Note for handset and base unit:

- If the paging party hangs up before you answer the page, "Incoming call" is displayed. Press **[↶]** on the handset or **[CELLULAR]** on the base unit to take the transferred call.

Switching a cellular call between a cellular phone and the base unit

From a cellular phone to the base unit

If you answer a cellular call using a cellular phone, you can transfer it to the base unit.

- 1 During a cellular call using your cellular phone, press **[CELLULAR]**.
- 2 “Transfer to base” → **[SET]**
- 3 Select the desired cellular phone. → **[SET]**
 - If you registered only one cellular phone, skip to step 4.
- 4 Follow the instructions of your cellular phone, if required.
 - You may need to enter the PIN (page 52).

From the base unit to a cellular phone

If you answer a cellular call using the base unit, you can transfer it to the cellular phone that the call came in.

- 1 During a cellular call using the base unit, press **[CELLULAR]**.
- 2 “Transfer to Cell” → **[SET]**

Conference calls

Conference call with a cellular call and land line call

While you are talking on a cellular call, you can make or answer a 2nd call on the land line, and then combine the calls to establish a conference call.

Handset

- 1 During a cellular call, press **[HOLD]** 2 times.
- 2 To answer a land line call, press **[LINE1]** or **[LINE2]**.
To make a land line call, press **[LINE1]** or **[LINE2]**, then dial the phone number.
- 3 When the land line call is connected, press **[CONF]** to make a conference call.
 - To hang up only one line, press the desired line button or **[CELL]** for the party with which you want to continue talking.
 - To put both lines on hold, press **[HOLD]**. To talk only with the land line caller, press the desired line button. To talk only with the cellular caller, press **[↶]**. To resume both lines, press **[CONF]**.

Base unit

- 1 During a cellular call, press **[HOLD]**.
- 2 To answer a land line call, press **[LINE1]** or **[LINE2]**.
To make a land line call, press **[LINE1]** or **[LINE2]**, then dial the phone number.
- 3 When the land line call is connected, press **[CONF]** to make a conference call.

- To hang up only one line, press the desired line button or **[CELLULAR]** for the party with which you want to continue talking.
- To put both lines on hold, press **[HOLD]**. To talk with only land line caller, press the desired line button. To talk only with the cellular caller, press **[CELLULAR]**. To resume both lines, press **[CONF]**.

placed the call on hold can resume the full conference by pressing **[CONF]** on the handset or **[CONF]** on the base unit.

Conference call with a cellular call and an intercom call

While you are talking on a cellular call, one more extension can join the conversation and establish a conference call.

Handset

- 1 During a cellular call, press **[INTERCOM]**.
- 2 To page the base unit, press **[0]**. To page another handset, enter its extension number (**[1]** to **[8]**).
- 3 When the paged party answers, press **[CONF]** to make a conference call.
 - To leave the conference, press **[OFF]**. The other 2 parties can continue the conversation.

Base unit

- 1 During a cellular call, press **[INTERCOM]**.
- 2 To page a handset, enter its extension number (**[1]** to **[8]**). To page all handsets, press **[0]**.
- 3 When the paged party answers, press **[CONF]** to make a conference call.
 - To leave the conference, press **[SP-PHONE]**. The other 2 parties can continue the conversation.

Note for handset and base unit:

- The cellular call can be put on hold by pressing **[HOLD]**. Only the person who

Connecting to your network

By connecting the base unit to your LAN, you can use this unit to:

- connect to the Internet (requires a high-speed Internet service subscription).
- connect to a computer on the same network.

Connecting to your LAN

Connect the base unit using LAN cable.

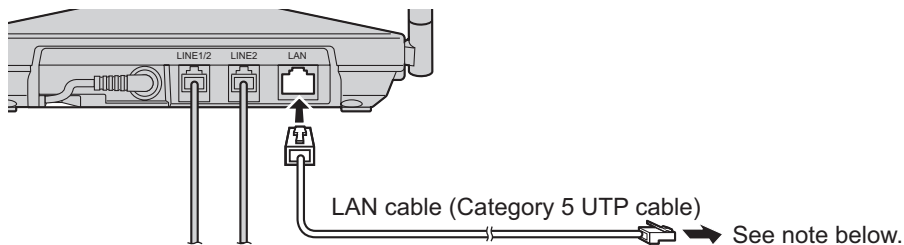

Note:

- Refer to the included “Installation Guide for MULTI TALK V Software” for connections.
- When connecting the MULTI TALK V devices to a local area network, you need to know the following limitations.
 - While you are using a dial up network (DUN) to access the Internet, no other data communication can take place using the same computer (for example, file sharing, browsing the cordless camera, printing with KX-THA16, etc.).
 - If you have high-speed Internet service (DSL or Cable), it is better to connect the base unit behind a router to utilize the networking features properly (for example, sharing Internet connection, browsing the cordless camera with a computer, printing with the KX-THA16, etc.).

Connecting the USB cable to the unit

By connecting the USB cable to the USB port, you can use this unit to:

- use MULTI TALK V USB Utility with your computer.
- access to the Internet with your computer.

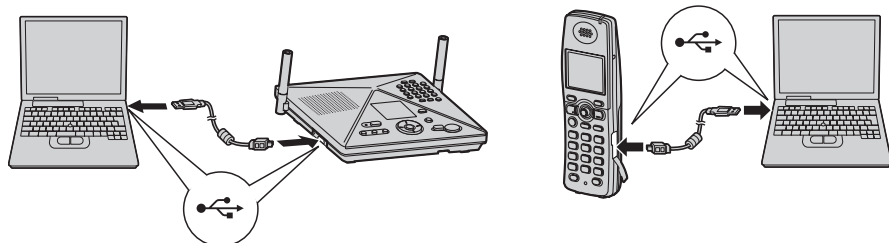

System requirements for your computer

The following system requirements must be met in order to use the MULTI TALK V software.

Item	Description
Operating System	Microsoft® Windows® 98SE, Microsoft Windows Me, Microsoft Windows 2000, or Microsoft Windows XP
CPU	For Windows 98SE and Windows Me: Pentium® 166 MHz or faster For Windows 2000: Pentium 200 MHz or faster For Windows XP: Pentium 300 MHz or faster
RAM	For Windows 98SE and Windows Me: 64 MB (128 MB or more recommended) For Windows 2000 and Windows XP: 128 MB
HDD	50 MB available disk space
Resolution	800 x 600 or higher resolution display
Others	USB interface: 1.1 Video adaptor with high color (16 bit) or higher CD-ROM drive 10/100 Mbps network card installed (necessary for LAN interface users) Browser: Internet Explorer 5.0 or later (necessary when monitoring the cordless camera)

Trademarks

- Microsoft and Windows are either registered trademarks or trademarks of Microsoft Corporation in the United States and/or other countries.
- Pentium is a trademark or registered trademark of Intel Corporation or its subsidiaries in the United States and/or other countries.
- Screen shots are reprinted with permission from Microsoft Corporation.
- All other trademarks identified herein are the property of their respective owners.

Wall mounting

Base unit

The base unit can be mounted on a wall phone plate.

- 1 Tuck the telephone line cord inside the wall mounting adaptor.
- 2 Insert the upper hooks (1), then the lower hooks (2) on the wall mounting adaptor into the holes on the base unit until it clicks into the place.

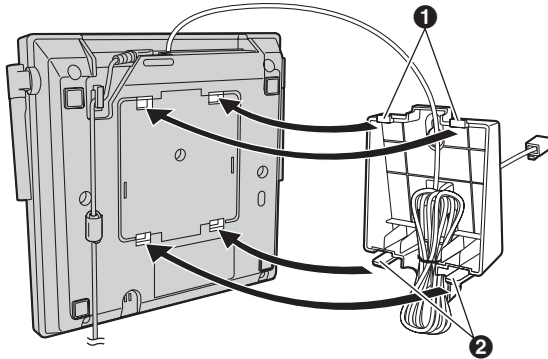

- 3 Connect the telephone line cord. Mount the base unit by inserting the mounting pins into the round openings on the adaptor (for pin B, use round cut out at the bottom of the adaptor if you're using the 4 inches phone plate), then sliding the base unit down to secure it.

Connect the AC adaptor to power outlet (page 13).

- There are two common types of wall phone plates. The distance between A and B may vary depending on the size of the wall phone plate installed.
- Raise the antennas.

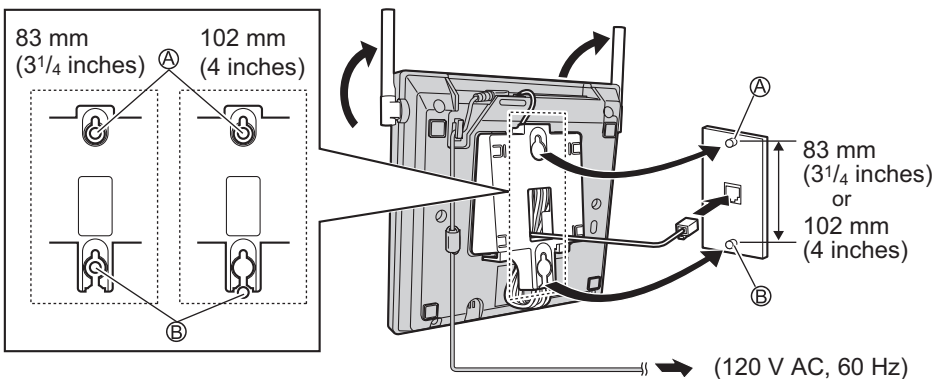

Charger

The charger can be mounted on the wall. Drive the screws (not included) into the wall using the wall template as a guide, then mount the charger securely on the screws.

Connect the AC adaptor to power outlet (page 16).

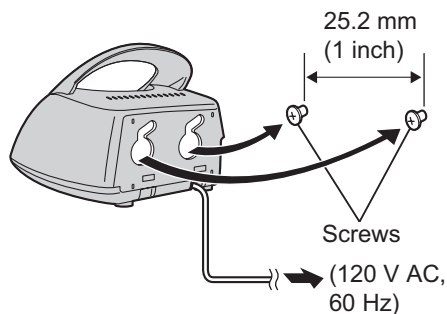

Note:

- Make sure the screws are securely fastened to the wall.

Wall mount template for the charger

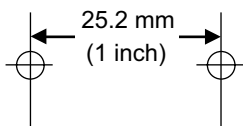

Belt clip

You can hang the handset on your belt or pocket using the included belt clip.

To attach the belt clip

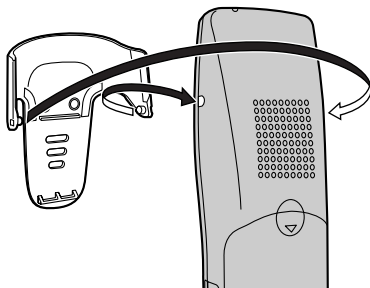

To remove the belt clip

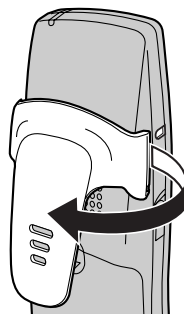

Headset (Optional)

Setting up a Bluetooth wireless headset

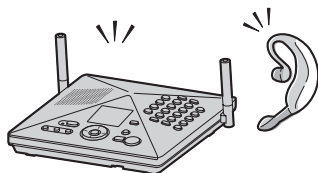

If your headset is Bluetooth wireless technology compatible to the home communication system, you can have a hands-free phone conversation by registering your headset to the base unit.

Important:

- The following procedures must be performed using the base unit.
- There can only be one active Bluetooth headset connection at a time.

Registering a headset

Important:

- For more details, please visit: www.panasonic.com/MultiTalkV

1 Your headset:

Enter the registration mode of your headset (each headset's instructions vary).

2 Base unit:

[MENU] →  → **[SET]**

3 "Bluetooth" → **[SET]**

4 "Headset" → **[SET]**

5 "Registration" → **[SET]**

6 Enter the PIN of your headset. (Refer to the operating instructions provided with your headset.) → **[SET]**

Note:

- To cancel a headset from the base unit, see "Deregistering another device" on page 54.

Selecting a headset

This setting determines which headset is active. Only 1 headset can be active at a time. When "No headset" is selected, the headset feature is turned off.

1 **[MENU]** → → **[SET]**

2 "Bluetooth" → **[SET]**

3 "Headset" → **[SET]**

4 "Headset select" → **[SET]**

5 Select the desired headset. → **[SET]** → **[STOP]**

Switching a call between headset and base unit speakerphone

To switch to the base unit speakerphone, press **[SP-PHONE]**.
To return to the headset, press **[STOP]**.

Connecting the corded headset





Connecting a headset to the handset allows hands-free phone conversations. Please use only a Panasonic headset (page 6).



- Headset shown is KX-TCA86.

Switching a call between headset and handset speakerphone

To switch to the handset speakerphone, press .
To return to the headset, press .

Error messages

If the unit detects a problem, one of the following messages is shown on the display.

Display message	Cause & solution
Busy	<ul style="list-style-type: none"> ● The called handset or base unit is in use. ● Other users are using the line(s). Wait until the line button light or the line status icon goes out. ● Privacy mode is on for the call you tried to join (page 44). ● The handset or base unit you tried to copy phonebook items to is in use. ● The handset you are calling is too far from the base unit.
Denied Turn access on at device.	<ul style="list-style-type: none"> ● The monitor feature is turned off on the destination handset or base unit and the room cannot be monitored (page 45).
Error!!	<ul style="list-style-type: none"> ● The handset's registration or deregistration has failed. Move the handset and the base unit away from the electrical appliances and try again. ● Another handset or base unit user tried to send phonebook items to you but there was an error. Have the other user re-send the items to you (page 33, 35).
Error!! 8 handsets have already been registered.	<ul style="list-style-type: none"> ● 8 handsets have already been registered to the base unit. The deregistered handset number is still retained in the base unit. To register an additional handset, erase the unnecessary handset number using the base unit (page 54).
---Incomplete---	<ul style="list-style-type: none"> ● The destination unit's phonebook memory is full. Erase unnecessary items from the destination unit's phonebook (page 32, 35). ● The destination unit is out of area. ● The destination unit's user may have pressed [↶] or [↷] on the handset or [SP-PHONE] on the base unit.
Invalid	<ul style="list-style-type: none"> ● There is no handset registered to the base unit matching the extension number you entered. ● You selected your own extension number.
Invalid. Please register to the base unit	<ul style="list-style-type: none"> ● The handset is not registered to the base unit. Register the handset (page 54).
Memory full	<ul style="list-style-type: none"> ● There is no space in memory to record new songs. Erase unnecessary songs (page 48).
No items stored	<ul style="list-style-type: none"> ● Your phonebook or redial list is empty. ● "Customize ring" is empty.

Display message	Cause & solution
<p>No link to base. Move closer to base and try again.</p>	<ul style="list-style-type: none"> ● The handset has lost communication with the base unit. Move closer to the base unit, and try again. ● Confirm that the base unit's AC adaptor is plugged in. ● Raise the base unit antennas. ● The handset's registration may have been canceled. Re-register the handset (page 54). ● After registering a cellular phone to the base unit, the communication between the base unit and other units may be disconnected. You need to wait for a few minutes and try again.
<p>Phonebook full</p>	<ul style="list-style-type: none"> ● There is no space to store new items in the phonebook. Erase unnecessary items (page 32, 35).
<p>System is busy. Please try again later.</p>	<ul style="list-style-type: none"> ● The resources available for wireless communication (making or answering calls with a handset, monitoring audio in the room, etc.) are limited. Therefore, depending on the combination of wireless features being conducted at the same time, your desired operation may not be possible. Wait for other users to finish and try again. ● Another user is listening to messages. Try again later.
<p>Title error</p>	<ul style="list-style-type: none"> ● The title for the customized ring is not entered or the title you entered is already used for another customized ring. Enter the title for that customized ring only.

Troubleshooting

General use

Problem	Cause & solution
The unit does not work.	<ul style="list-style-type: none">● Make sure that the battery is installed correctly and fully charged (page 16).● Check the connections (page 13 – 15).● Unplug the base unit's AC adaptor to reset the unit. Reconnect the adaptor and try again.● The handset has not been registered to the base unit. Register the handset (page 54).
I cannot hear a dial tone.	<ul style="list-style-type: none">● Confirm that the telephone line cord is connected (page 14).● Disconnect the base unit from the telephone line and connect a known working telephone. If the working telephone operates properly, contact our service personnel to have the unit repaired. If the working telephone does not operate properly, contact your telephone company.
<p>"Recharge battery" is displayed and I cannot perform the following operations:</p> <ul style="list-style-type: none">– recording or erasing a customized ringer– editing a title for a customized ringer– copying MULTI TALK V USB Utility settings (songs, phonebook items, programmable settings, etc.) from your computer	<ul style="list-style-type: none">● The battery power is low. Fully charge the battery (page 16) and try again.

Programmable settings

Problem	Cause & solution
I cannot program items.	<ul style="list-style-type: none">● While another user is listening to messages or the answering system is answering a call, you cannot program. Try again later.
While programming, the handset starts to ring.	<ul style="list-style-type: none">● A call is being received. Answer the call and start again after hanging up.

Making/answering calls, intercom

Problem	Cause & solution
Static is heard, sound cuts in and out. Interference from other electrical units.	<ul style="list-style-type: none"> ● Move the handset and the base unit away from other electrical appliances (microwave, wireless LAN appliance, etc.). ● Move closer to the base unit. ● Raise the base unit antennas. ● Turn on the clarity booster feature (page 29). ● If your base unit is connected to a telephone line with DSL service, we recommend connecting a noise filter between the base unit and the telephone line jack. Contact your DSL provider for details.
The handset and base unit do not ring.	<ul style="list-style-type: none"> ● The ringer volume is turned off. Adjust it (page 46, 68).
I cannot make a call.	<ul style="list-style-type: none"> ● The dialing mode may be set incorrectly. Change the setting (page 24). ● The base unit (including answering system) or another handset is in use. Try again later.
I cannot redial by pressing [REDIAL] .	<ul style="list-style-type: none"> ● If the last number dialed was more than 48 digits long, the number will not be redialed correctly. Dial the number manually.
I cannot have a conversation using the headset.	<ul style="list-style-type: none"> ● Make sure that a Panasonic optional headset is connected properly (page 77). ● Your optional Bluetooth headset is not registered. Register it (page 77). ● If “SP-phone” is displayed on the handset, press [ to switch to the headset.
I cannot make long distance calls.	<ul style="list-style-type: none"> ● Make sure that you have long distance service.
I cannot page the handset or base unit.	<ul style="list-style-type: none"> ● The called handset is too far from the base unit. ● The called unit is in use. Try again later.
I cannot turn the clarity booster feature on.	<ul style="list-style-type: none"> ● The resources available for wireless communication (making or answering calls with another handset, monitoring camera images from a computer, etc.) are limited. Wait for the other user to end the operation and try again.
The interrupt tones sound while I am on an outside call or on an intercom call or monitoring a room.	<ul style="list-style-type: none"> ● A call is being received. Press [OFF] to end the call or stop monitoring, then answer the call.

Useful Information

Phonebook

Problem	Cause & solution
Copying stopped with an item displayed.	<ul style="list-style-type: none">● The destination handset may have lost communication with the base unit, or the destination unit user may have pressed [↶] or [↷] on the handset or [SP-PHONE] on the base unit. The displayed phonebook item was not copied to the unit. Press [OFF] on the handset or [STOP] on the base unit. Confirm that the destination unit is not in use and try again.

Caller ID

Problem	Cause & solution
The handset or base unit does not display the caller's name and/or phone number.	<ul style="list-style-type: none">● You have not subscribed to Caller ID service. Contact your telephone company to subscribe.● If your base unit is connected to any additional telephone equipment such as a Caller ID box or cordless telephone jack, disconnect the base unit from the equipment and plug the base unit directly into the wall jack.● If your base unit is connected to a telephone line with DSL service, we recommend connecting a noise filter between the base unit and the telephone line jack. Contact your DSL provider for details.● The name display service may not be available in some areas. Contact your telephone company for details.● Other telephone equipment may be interfering with this unit. Disconnect the other equipment and try again.● The caller requested not to send caller information (page 36).● If a call is being transferred to you, the caller information is not displayed.
The handset does not announce the displayed caller names.	<ul style="list-style-type: none">● The handset's ringer volume is turned off. Adjust it (page 46).● The Talking Caller ID feature is turned off. Turn it on (page 50).● The ring count for the answering system is set to "2" or "Toll saver". Select a different setting (page 61).
The caller list/incoming phone numbers are not edited automatically.	<ul style="list-style-type: none">● The Caller ID number auto edit feature is turned off. Turn it on and try again (page 50).● You need to call back the edited number to activate Caller ID number auto edit.

Problem	Cause & solution
I cannot dial the phone number edited in the caller list.	<ul style="list-style-type: none"> ● The phone number you dialed might have an incorrect edited pattern (for example, the long distance “1” or the area code is missing). Edit the phone number with another pattern (page 38).
The 2nd caller’s information is not displayed during an outside call.	<ul style="list-style-type: none"> ● In order to use Caller ID, Call Waiting, or Call Waiting Caller ID (CWID), you must first contact your telephone company and subscribe to the desired service. After subscribing, you may need to contact your telephone company again to activate this specific service, even if you already subscribed to both Caller ID and Call Waiting with Caller ID services (CWID).

Answering system

Problem	Cause & solution
I cannot listen to messages from a remote location.	<ul style="list-style-type: none"> ● A touch tone phone is required for remote operation. ● Enter the remote code correctly (page 59). ● The answering system is off. Turn it on (page 61).
The unit does not record new messages.	<ul style="list-style-type: none"> ● The answering system is not turned on for the line you wish to record messages from. Select the desired line or both lines by pressing [LINE SELECT] repeatedly, then turn the answering system on (page 55, 61). ● The recording time is set to “Greeting only”. Select a different setting (page 62). ● The message memory is full. Erase unnecessary messages (page 57). ● The answering system is activated for both lines, and the 1st caller is leaving a voice message. The 2nd caller cannot leave a message, but the caller information will be stored (page 37). ● If you subscribe to the Voice Mail service, messages are recorded by the telephone company not your telephone (page 62).
I cannot operate the answering system.	<ul style="list-style-type: none"> ● Someone is operating the answering system. ● If other users are talking on a conference call, you cannot operate the answering system. Try again later.
The message indicator on the handset flashes.	<ul style="list-style-type: none"> ● New messages have been recorded. Listen to the new messages (page 57).

Useful Information



Problem	Cause & solution
I cannot hear a message from the speaker when the answering system is recording a message.	<ul style="list-style-type: none">● The call screening feature is turned off. Turn it on (page 62).● The volume for the base unit is turned off. Turn the volume up by pressing [▲] on the base unit.● If you pressed [▲] or [▼] on the base unit to adjust the volume just before you listened to the message, you may not be able to hear the message. Adjust the volume while you are listening to the message.

Cellular connection/Bluetooth wireless headset

Problem	Cause & solution
I cannot register a cellular phone to the base unit.	<ul style="list-style-type: none">● Depending on the compatibility of the cellular phone, you may not be able to register it to the base unit.● Confirm that your cellular phone supports the hands-free profile (HFP) specification. If it does not, you cannot register it to the base unit.● You can register up to 5 cellular phones (when other Bluetooth devices are not registered). Confirm how many cellular phones have already been registered in “Connecting the cellular phone ” (page 65).● Confirm that the Bluetooth feature of your cellular phone is turned on. You may need to turn this feature on depending on your cellular phone.● The Bluetooth technology on your cellular phone may not be functioning normally. Turn off and on your cellular phone.
I cannot connect a cellular phone to the base unit.	<ul style="list-style-type: none">● Depending on the compatibility of the cellular phone, you may not be able to connect it to the base unit.● Confirm that you have registered your cellular phone to the base unit using the cellular phone (page 64). Refer to the operating instructions of your cellular phone for registration.● Confirm that your cellular phone is turned on.● Confirm that the Bluetooth feature of your cellular phone is turned on. You may need to turn this feature on depending on your cellular phone.● The Bluetooth technology on your cellular phone may not be functioning normally. Turn off and on your cellular phone.
The registered cellular phone received a call, but I cannot take that call with the handset or base unit.	<ul style="list-style-type: none">● If someone is talking on a cellular call or customizing the cellular settings, you cannot use cellular feature. There can be only one active Bluetooth connection at a time.● Confirm that your cellular phone is connected to the base unit (page 65).

Problem	Cause & solution
I cannot make or answer cellular calls with the handset or base unit.	<ul style="list-style-type: none"> ● Depending on the cellular phone's compatibility, you may not be able to make or answer cellular calls even if you could register and connect the cellular phone to the base unit. ● Confirm that you have registered your cellular phone to the base unit using the cellular phone (page 64). Refer to the operating instructions of your cellular phone for registration. ● Confirm that your cellular phone is turned on. ● Confirm that your cellular phone is connected to the base unit (page 65). ● Confirm that your cellular phone is placed within the range of the base unit. ● If someone is talking on a cellular call or customizing the cellular settings, you cannot use cellular feature. There can be only one active Bluetooth connection at a time.
I can make or answer cellular calls but cannot hear a sound.	<ul style="list-style-type: none"> ● The Bluetooth technology on your cellular phone may not be functioning normally. Turn off and on your cellular phone. ● Disconnect and connect the base unit AC adaptor and try again.
I cannot switch cellular calls between the base unit and cellular phone.	<ul style="list-style-type: none"> ● Your cellular phone may not support this feature. Refer to the operating instructions of your cellular phone.
I cannot register the Bluetooth wireless headset to the base unit.	<ul style="list-style-type: none"> ● Confirm that your Bluetooth wireless headset supports the headset profile (HSP) specification. If it does not, you cannot register it to the base unit.

Battery recharge

Problem	Cause & solution
I charged the battery fully, but  continues to flash, or  is displayed.	<ul style="list-style-type: none"> ● The battery may need to be replaced with a new one (page 17).
The handset display is blank.	<ul style="list-style-type: none"> ● Confirm that the battery is properly installed. ● Fully charge the battery (page 16).

FCC and other information

This equipment complies with Part 68 of the FCC rules and the requirements adopted by the ACTA. On the bottom of this equipment is a label that contains, among other information, a product identifier in the format US:ACJ-----.

If requested, this number must be provided to the telephone company.

- Registration No
.....(found on the bottom of the unit)
- Ringer Equivalence No.
(REN).....0.2B

A plug and jack used to connect this equipment to the premises wiring and telephone network must comply with the applicable FCC Part 68 rules and requirements adopted by the ACTA. A compliant telephone cord and modular plug is provided with the product. It is designed to be connected to a compatible modular jack that is also compliant.

The REN is used to determine the number of devices that may be connected to a telephone line. Excessive RENs on a telephone line may result in the devices not ringing in response to an incoming call. In most but not all areas, the sum of RENs should not exceed five (5.0). To be certain of the number of devices that may be connected to a line, as determined by the total RENs, contact the local telephone company. For products approved after July 23, 2001, the REN for the product is part of the product identifier that has the format US:AAAEQ##TXXXX. The digits represented by ## are the REN without a decimal point (e.g., 03 is a REN of 0.3).

If this equipment causes harm to the telephone network, the telephone company will notify you in advance that temporary discontinuance of service may be required. But if advance notice isn't practical, the telephone company will

notify the customer as soon as possible. Also, you will be advised of your right to file a complaint with the FCC if you believe it is necessary.

The telephone company may make changes in its facilities, equipment, operations or procedures that could affect the operation of the equipment. If this happens the telephone company will provide advance notice in order for you to make necessary modifications to maintain uninterrupted service.

If trouble is experienced with this equipment, for repair or warranty information, please contact a Factory Servicenter or other Authorized Servicer. If the equipment is causing harm to the telephone network, the telephone company may request that you disconnect the equipment until the problem is resolved.

Connection to party line service is subject to state tariffs. Contact the state public utility commission, public service commission or corporation commission for information.

If your home has specially wired alarm equipment connected to the telephone line, ensure the installation of this equipment does not disable your alarm equipment. If you have questions about what will disable alarm equipment, consult your telephone company or a qualified installer.

This equipment is hearing aid compatible as defined by the FCC in 47 CFR Section 68.316.

When you hold the phone to your ear, noise might be heard in your Hearing Aid. Some Hearing Aids are not adequately shielded from external RF (radio frequency) energy. If noise occurs, use an optional headset accessory or the speakerphone option (if applicable) when using this phone. Consult with your audiologist or Hearing Aid manufacturer about the availability of Hearing Aids which provide adequate shielding to RF energy commonly emitted by digital devices.

WHEN PROGRAMMING EMERGENCY NUMBERS AND(OR) MAKING TEST CALLS TO EMERGENCY NUMBERS:

- 1) Remain on the line and briefly explain to the dispatcher the reason for the call.
- 2) Perform such activities in the off-peak hours, such as early morning or late evenings.

This device complies with Part 15 of the FCC Rules. Operation is subject to the following two conditions:

(1) This device may not cause harmful interference, and (2) this device must accept any interference received, including interference that may cause undesired operation.

Privacy of communications may not be ensured when using this phone.

CAUTION:

Any changes or modifications not expressly approved by the party responsible for compliance could void the user's authority to operate this device.

NOTE:

This equipment has been tested and found to comply with the limits for a Class B digital device, pursuant to Part 15 of the FCC Rules. These limits are designed to provide reasonable protection against harmful interference in a residential installation. This equipment generates, uses, and can radiate radio frequency energy and, if not installed and used in accordance with the instructions, may cause harmful interference to radio communications. However, there is no guarantee that interference will not occur in a particular installation. If this equipment does cause harmful interference to radio or television reception, which can be determined by turning the equipment off and on, the user is encouraged to try to correct the interference by one or more of the following measures:

- Reorient or relocate the receiving antenna.
- Increase the separation between the equipment and receiver.
- Connect the equipment into an outlet on a circuit different from that to which the receiver is connected.
- Consult the dealer or an experienced radio/TV technician for help.

Some cordless telephones operate at frequencies that may cause interference to nearby TVs and VCRs. To minimize or prevent such interference, the base of the cordless telephone should not be placed near or on top of a TV or VCR. If interference is experienced, move the cordless telephone further away from the TV or VCR. This will often reduce, or eliminate, interference.

FCC RF Exposure Warning:

The product complies with FCC radiation exposure limits set forth for an uncontrolled environment. To comply with FCC RF exposure requirements, the base unit must be installed and operated with its antenna located 20 cm (8 inches) or more between antenna and all person's body (excluding extremities of hands, wrist and feet). The handset may be carried and operated with only the specific provided belt-clip. Other non-tested belt-clips or similar body-worn accessories may not comply and must be avoided. The product must not be collocated or operated in conjunction with any other antenna or transmitter.

Responsible party:

Panasonic Corporation of North America
One Panasonic Way,
Secaucus, New Jersey 07094
Phone number: 1-800-211-PANA (1-800-211-7262)

FCC Warning:

To ensure compliance with FCC emissions limits, use only the included USB cable with the ferrite core when connecting the unit to a computer.

Notice

- This product is designed for use in the United States of America. Sale or use of this product in other countries may violate local laws.
- Cet appareil est conçu pour être utilisé aux États-Unis d'Amérique. La vente ou l'emploi de cet appareil dans certains autres pays peut constituer une infraction à la législation locale.
- Este producto está diseñado para usarse en los Estados Unidos de América.
La venta o el empleo de este producto en ciertos países puede constituir violación de la legislación local.
- この製品は、日本国外での使用を目的として設計されており、日本国内での使用は法律違反となります。従って、当社では日本国内においては原則として修理などのサービスは致しかねます。

Specifications

General

Operating environment	5 °C – 40 °C (41 °F – 104 °F)
Frequency	2.402 GHz – 2.48 GHz
Bluetooth compliance	Bluetooth wireless technology 1.2

Base unit

Dimensions	Approx. height 48 mm x width 205 mm x depth 182 mm (1 ⁷ / ₈ inches x 8 ¹ / ₁₆ inches x 7 ⁵ / ₃₂ inches)
Mass (Weight)	Approx. 530 g (1.17 lb.)
Power consumption	Standby: Approx. 2.6 W Maximum: Approx. 5.5 W
Power output	125 mW (max.)
Power supply	AC adaptor (120 V AC, 60 Hz)
Interface	USB: 1.1 LAN: 10Base-T/100Base-TX Ethernet® RJ-45 connector x 1

Handset

Dimensions	Approx. height 159 mm x width 49 mm x depth 35 mm (6 ¹ / ₄ inches x 1 ¹⁵ / ₁₆ inches x 1 ³ / ₈ inches)
Mass (Weight)	Approx. 170 g (0.37 lb.)
Power output	125 mW (max.)
Power supply	Ni-MH battery (3.6 V, 830 mAh)
Interface	USB: 1.1

Charger

Dimensions	Approx. height 71 mm x width 88 mm x depth 99 mm (2 ¹³ / ₁₆ inches x 3 ¹⁵ / ₃₂ inches x 3 ²⁹ / ₃₂ inches)
Mass (Weight)	Approx. 110 g (0.24 lb.)
Power consumption	Standby: Approx. 1.5 W Maximum: Approx. 6.5 W
Power supply	AC adaptor (120 V AC, 60 Hz)

Note:

- Design and specifications are subject to change without notice.
- The illustrations in these instructions may vary slightly from the actual product.

Trademarks

- The Bluetooth word mark and logos are owned by the Bluetooth SIG, Inc. and any use of such marks by Panasonic is under license.
- Ethernet is either a registered trademark or a trademark of Xerox Corporation in the United States and/or other countries.

Customer services

Customer Services Directory

Obtain Product Information and Operating Assistance; locate your nearest Dealer or Servicenter; purchase Parts and Accessories; or make Customer Service and Literature requests by visiting our Web Site at:

<http://www.panasonic.com/consumersupport>

or, contact us via the web at:

<http://www.panasonic.com/contactinfo>

You may also contact us directly at:

1-800-211-PANA (1-800-211-7262),

Monday-Friday 9 am-9 pm; Saturday-Sunday 10 am-7 pm, EST.

TTY users (hearing or speech impaired users) can call 1-877-833-8855.

Accessory Purchases

Purchase Parts, Accessories and Instruction Books online for all Panasonic Products by visiting our Web Site at:

<http://www.pasc.panasonic.com>

or, send your request by E-mail to:

npcparts@us.panasonic.com

You may also contact us directly at:

1-800-332-5368 (Phone) 1-800-237-9080 (Fax Only)

(Monday - Friday 9 am to 8 pm, EST.)

Panasonic Services Company

20421 84th Avenue South, Kent, WA 98032

(We Accept Visa, MasterCard, Discover Card, American Express, and Personal Checks)

TTY users (hearing or speech impaired users) can call 1-866-605-1277.

Service in Puerto Rico

Panasonic Puerto Rico, Inc.

San Gabriel Industrial Park, Ave. 65 de Infantería, Km. 9.5,

Carolina, Puerto Rico 00985

Phone (787)750-4300, Fax (787)768-2910

Warranty

PANASONIC CONSUMER
ELECTRONICS COMPANY, DIVISION
OF PANASONIC CORPORATION OF
NORTH AMERICA
One Panasonic Way,
Secaucus, New Jersey 07094

PANASONIC PUERTO RICO, INC.
San Gabriel Industrial Park,
Ave. 65 de Infantería, Km. 9.5,
Carolina, Puerto Rico 00985

Panasonic Telephone Products Limited Warranty

Limited Warranty Coverage

If your product does not work properly because of a defect in materials or workmanship, Panasonic Consumer Electronics Company or Panasonic Puerto Rico, Inc. (collectively referred to as "the warrantor") will, for the length of the period indicated on the chart below, which starts with the date of original purchase ("Limited Warranty period"), at its option either (a) repair your product with new or refurbished parts, or (b) replace it with a new or a refurbished product. The decision to repair or replace will be made by the warrantor.

Parts	Labor
One (1) Year	One (1) Year

During the "Labor" Limited Warranty period there will be no charge for labor. During the "Parts" Limited Warranty period, there will be no charge for parts. You must mail-in your product prepaid during the Limited Warranty period. This Limited Warranty excludes both parts and labor for batteries, antennas, and cosmetic parts (cabinet). This Limited Warranty only applies to products purchased and serviced in the United States or Puerto Rico. This Limited Warranty is extended only to the original purchaser and only covers products purchased as new.

Mail-In Service

For assistance in the continental U.S.A. in obtaining repairs please ship the product prepaid to:

Panasonic Services Company Customer Servicer

4900 George McVay Drive Suite B Door #12 McAllen, TX 78503

For assistance in Puerto Rico call Panasonic Puerto Rico, Inc. (787)-750-4300 or fax (787)-768-2910.

For Limited Warranty service for headsets if a headset is included with this product please call Panasonic Call Center at 1-800-211-PANA (1-800-211-7262).

When shipping the unit carefully pack, include all accessories, and send it prepaid, adequately insured and preferably in the original carton. Include a letter detailing the complaint and provide a day time phone number where you can be reached.

IF REPAIR IS NEEDED DURING THE LIMITED WARRANTY PERIOD THE PURCHASER WILL BE REQUIRED TO FURNISH A SALES RECEIPT/PROOF OF PURCHASE INDICATING DATE OF PURCHASE, AMOUNT PAID AND PLACE OF PURCHASE. CUSTOMER WILL BE CHARGED FOR THE REPAIR OF ANY UNIT RECEIVED WITHOUT SUCH PROOF OF PURCHASE.

Limited Warranty Limits And Exclusions

This Limited Warranty ONLY COVERS failures due to defects in materials or workmanship, and DOES NOT COVER normal wear and tear or cosmetic damage. The Limited Warranty ALSO DOES NOT COVER damages which occurred in shipment, or failures which are caused by products not supplied by the warrantor, or failures which result from accidents, misuse, abuse, neglect, bug infestation, mishandling, misapplication, alteration, faulty installation, set-up adjustments, misadjustment of consumer controls, improper maintenance, power line surge, lightning damage, modification, introduction of sand, humidity or liquids, commercial use such as hotel, office, restaurant, or other business or rental use of the product, or service by anyone other than a Factory Servicenter or other Authorized Servicer, or damage that is attributable to acts of God.

THERE ARE NO EXPRESS WARRANTIES EXCEPT AS LISTED UNDER "LIMITED WARRANTY COVERAGE". THE WARRANTOR IS NOT LIABLE FOR INCIDENTAL OR CONSEQUENTIAL DAMAGES RESULTING FROM THE USE OF THIS PRODUCT, OR ARISING OUT OF ANY BREACH OF THIS LIMITED WARRANTY. (As examples, this excludes damages for lost time, lost calls or messages, cost of having someone remove or re-install an installed unit if applicable, travel to and from the servicer. The items listed are not exclusive, but are for illustration only.) **ALL EXPRESS AND IMPLIED WARRANTIES, INCLUDING THE WARRANTY OF MERCHANTABILITY, ARE LIMITED TO THE PERIOD OF THE LIMITED WARRANTY.**

Some states do not allow the exclusion or limitation of incidental or consequential damages, or limitations on how long an implied warranty lasts, so the exclusions may not apply to you.

This Limited Warranty gives you specific legal rights and you may also have other rights which vary from state to state. If a problem with this product develops during or after the Limited Warranty period, you may contact your dealer or Servicenter. If the problem is not handled to your satisfaction, then write to the warrantor's Consumer Affairs Department at the addresses listed for the warrantor.

PARTS AND SERVICE, WHICH ARE NOT COVERED BY THIS LIMITED WARRANTY, ARE YOUR RESPONSIBILITY.

Direct command chart/programming index

Important:



















- You can program each feature directly by using feature codes.

Press **[MENU]**, **[F1]**, then press the desired feature code.























Note:

- When you find “*1”, “*2”, and “*3” in the following table, refer to the corresponding note below.
- *1 If you program the following features using one of the units, you do not need to program the same item using another unit.
- *2 If you reset the base unit (page 52), the marked features are reset to their default settings.
- *3 If you purchase the cordless camera (KX-THA13), you can monitor a room where the cordless camera is located using your computer.







Telephone

Feature	Feature code	Operating unit	Default setting	Base reset ^{*2}	Page
Auto edit (Caller ID number auto edit)	[2][1][4]	 	On	●	50
Auto talk	[2][0][0]		Off	–	50
Caller list	[2][1][3]	 	–	–	37
Customer support	[6][8][0]	 	–	–	53
Customize ring	[1][6][6]		–	–	47
Date and time ^{*1}	[1][0][1]	 	12.31.2006	–	25
Deregistration (Deregistering a handset)	[1][3][1]		–	–	54
Deregistration (Deregistering another device)	[1][3][4]		–	–	54
Display (Display language)	[1][1][0]	 	English	●	24
Registration (Handset registration)	[1][3][0]		–	–	54
Interrupt tone	[2][0][1]	 	2	●	48
Key tone	[1][6][5]		On	–	50









Useful Information

Feature	Feature code	Operating unit	Default setting	Base reset ^{*2}	Page
LCD contrast (Display contrast)	[1][4][5]	 	Level 3	●	50
Line select	[2][5][0]	 	Auto	●	51
Message alert	[3][4][0]		Off	–	63
Phonebook	[2][8][0]	 	–	–	31, 34
Ring color	[2][3][5]		Color 1	–	48
Ringer tone	[1][6][1]	 	Line 1: Tone 1 Line 2: Tone 2	●	46
Ringer volume	[1][6][0]	 	High	●	46
Set dial mode ^{*1}	[1][2][0]	 	Tone	●	24
Set flash time ^{*1}	[1][2][1]	 	700ms	●	51
Set line mode ^{*1}	[1][2][2]	 	B	●	52
Set PIN	[1][3][2]		7262	●	52
Talking CallerID	[1][6][2]		On	–	50
Time adjustment ^{*1}	[2][2][6]	 	Caller ID [auto]	●	49
Voice enhancer	[2][7][0]		Off	–	49





Intercom and monitor features

Feature	Feature code	Operating unit	Default setting	Base reset ^{*2}	Page
Audio monitor	[7][2][2]	 	–	–	45
Device name (Changing the handset/base unit name)	[1][0][4]	 	Handset: Handset Base unit: Base TH102	–	49
Monitor access	[2][0][2]	 	Deny	●	45
PC camera access ^{*3} (Enabling monitoring from a computer)	[6][5][0]		Off	●	–



Answering system features

Feature	Feature code	Operating unit	Default setting	Base reset ^{*2}	Page
Call screening	[3][1][0]		On	●	62
Greeting check	[3][0][3]		–	–	56
Greeting record	[3][0][2]		–	–	55
Message playback	[3][0][0]		–	–	57
Recording mode	[3][0][9]		Standard recording 60min	●	62
Recording time	[3][0][5]		3min	●	62
Remote code	[3][0][6]		11	●	61
Ring count	[2][1][1]		4 rings	●	61

Cellular connection

Feature	Feature code	Operating unit	Default setting	Base reset ^{*2}	Page
Discoverable (Turning on the discoverable mode)	[6][2][0]		On	●	64
Ringer tone (For cellular phones)	[6][2][9]	 	Tone 3	●	69
Ringer volume (For cellular phones)	[6][2][8]	 	High	●	68

Bluetooth compatible headset

Feature	Feature code	Operating unit	Default setting	Base reset ^{*2}	Page
Headset list (Selecting a headset)	[6][2][2]		–	–	77
Registration (Registering a headset)	[6][2][1]		–	–	77

Index

- A** Answering calls: 28
 - Answering system
 - Erasing messages: 57, 58, 60
 - Listening to messages: 56, 57, 59
 - Turning on/off: 55, 58, 60
 - Audio cable: 47
 - Auto talk: 28, 50
- B** Base unit
 - Monitor: 45
 - Ringer tone: 46
 - Ringer volume: 46Battery
 - Charge: 16
 - Installation: 16
 - Performance: 17
 - Replacement: 17
 - Strength: 16Belt clip: 76Bluetooth wireless technology: 64, 77Booster (clarity booster): 29
- C** Call reservation: 53
 - Call share: 44
 - Call Waiting: 29
 - Call Waiting Caller ID: 36
 - Caller ID number auto edit: 38, 50
 - Caller ID service: 36Caller list
 - Calling back: 37
 - Editing: 38
 - Erasing: 39
 - Storing: 39
 - Viewing: 37Cellular phone
 - Conference: 71
 - Connection: 65
 - Discoverable: 64
 - Making/answering calls: 65
 - Registration: 64
 - Ringer tone: 69
 - Ringer volume: 68
 - Transferring a call: 70Conference calls: 42
- Connections
 - AC adaptor: 13, 16
 - LAN cable: 73
 - Noise filter: 15
 - Telephone line cord: 13, 14, 15Customer support: 53Customize ring: 47
- D** Date and time: 25Deregistration: 54Device name: 49Dialing mode: 24Direct commands: 93Display
 - Contrast: 50
 - Language: 24
- E** Error messages: 78
- F** Flash: 29
 - Flash time: 51
- G** Greeting message: 55
- H** Handset
 - Monitor: 45
 - Ringer tone: 46
 - Ringer volume: 46Headset: 77Hold: 28
- I** Intercom: 40Interrupt tone: 48
- K** Key tone: 50
- L** Light-up ID: 37
 - Line mode: 52
 - Line selection: 51
- M** Making calls: 26
 - Memo (voice memo): 59
 - Memory capacity (message recording): 55
 - Message alert: 63
 - Microphone: 27, 59
 - Missed calls: 37Monitor
 - Audio monitor: 45
 - Monitor access: 45MULTI TALK V: 4Mute: 28
- P** Pause: 26, 27
 - Phonebook
 - Base unit: 34
 - Handset: 31

- PIN: 52
- Privacy feature: 44
- Pulse service: 29
- R** Recording mode: 62
- Recording time: 62
- Redial list: 26, 27
- Registration
 - Cellular phone: 64
 - Handset: 54
 - Headset: 77
- Remote code: 61
- Remote operation: 59
- Ring color: 48
- Ring count: 61
- Ringer ID: 37
- Ringer off: 28, 46
- Ringer tone: 46
- Ringer volume: 46
- Rotary service: 29
- S** Soft keys: 22
- Specifications: 89
- SP-phone: 26
- T** TAD: 69
- Talking Caller ID: 36, 50
- Time adjustment: 49
- Toll saver: 61
- Tone: 29
- Trademarks: 74, 89
- Transferring a call: 41
- Troubleshooting: 80
- TTY: 6, 90
- U** USB cable: 6, 73
- V** VE (voice enhancer): 29, 49
- Voice guidance: 57, 59
- Voice Mail service: 62
- Volume
 - Receiver: 26
 - Ringer: 46
 - Speaker: 26, 27
- W** Wall mounting
 - Base unit: 75
 - Charger: 76
- Warranty: 91

Notes

Notes

Free Manuals Download Website

<http://myh66.com>

<http://usermanuals.us>

<http://www.somanuals.com>

<http://www.4manuals.cc>

<http://www.manual-lib.com>

<http://www.404manual.com>

<http://www.luxmanual.com>

<http://aubethermostatmanual.com>

Golf course search by state

<http://golfingnear.com>

Email search by domain

<http://emailbydomain.com>

Auto manuals search

<http://auto.somanuals.com>

TV manuals search

<http://tv.somanuals.com>