

# Panasonic

Portable DVD-ROM & CD-R/RW Drive

## Operating Instructions

Model No. KXL-CB30AU

DVD-ROM  
&  
CD-R/RW

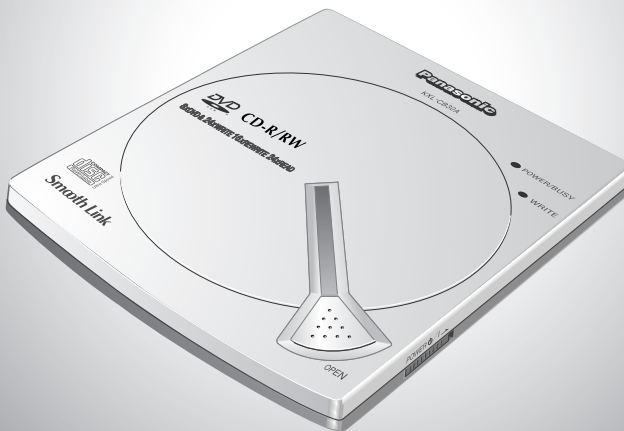

**Thank you for purchasing the Panasonic Portable DVD-ROM & CD-R/RW Drive KXL-CB30AU.**

Before attempting to connect, operate or adjust the controls, please read these instructions completely.

Please keep this manual for future use.

# Overview

For correct operation of this drive with a computer, it is necessary to follow the steps below.

## Setup

### Operating Instructions (this manual)

Please read carefully to use this drive correctly.

- Check the Windows OS installed in your computer.
- Install USB Driver.
- Install UDF Reader.
- Connect this drive to your computer.
- Check the setup.

(Now you can use this drive as a CD-ROM/DVD-ROM drive.)



## Application Install

### DVD-Video Playback Software

- Install WinDVD 4.

(Now you can watch DVD-Videos with this drive.)



### Writing Software

- Install B's Recorder GOLD5 BASIC / B's CLiP5.

(Now you can write to CD-Rs/-RWs.)

Refer to software manuals included on the CD-ROM.

Microsoft and Windows are registered trademarks of Microsoft Corporation (U.S.) in the U.S. and other countries.

B's Recorder GOLD and B's CLiP are trademarks of B.H.A Corporation.

WinDVD is a trademark of InterVideo Incorporated.

SmoothLink is a registered trademark of Matsushita Electric Industrial Co., Ltd.

Photo CD is a registered trademark of Eastman Kodak Company.

All other brands and product names are trademarks or registered trademarks of their respective companies.

The screen pictures in this manual are used in accordance with the Microsoft Corporation guidelines.

# Features

- **Maximum 24X CD-R writing and 16X CD-RW writing<sup>\*1</sup> performance**
- **Compatible with USB2.0 interface<sup>\*2</sup>**
- **Buffer Under Run protection ( *Smooth Link* ) incorporated**
- **Supports DVD-RAM/-R/-RW playback<sup>\*3</sup>**
- **Includes B.H.A Writing Software**
- **Includes InterVideo DVD-Video Playback Software<sup>\*4</sup>**

<sup>\*1</sup> 16X writing may not be supported except recommended Discs.

<sup>\*2</sup> The performance of this drive connected via a USB hub is not guaranteed.  
For USB1.1 interface, writing and reading speeds are about 8X at maximum.

<sup>\*3</sup> Only UDF formatted DVD-RAMs that are removable from cartridges or non-cartridge type can be used with this drive.

<sup>\*4</sup> When using USB1.1, images and sounds may be interrupted during DVD-Video playback.

---

The full title of "Windows 98SE" is Microsoft® Windows® 98 Second Edition operating system.

The full title of "Windows 2000" is Microsoft® Windows® 2000 Professional operating system.

The full title of "Windows Me" is Microsoft® Windows® Millennium Edition operating system.

The full title of "Windows XP" is Microsoft® Windows® XP Professional operating system or Microsoft® Windows® XP Home Edition operating system.

# Accessories

Make sure that the following accessories are included with the drive. If anything is missing, contact your dealer immediately.

AC adaptor  
(Made in China)  
(KX-WZ712)



USB cable  
(Made in Philippines)



AC cord



Operating Instructions

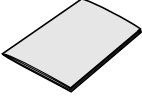

CD-ROM

- B's Recorder GOLD5 BASIC
- B's CLiP 5
- WinDVD 4
- Driver Software

Serial No. on case

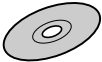

\* With a disc case.

Setup Guide

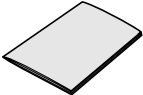

The illustrations above may differ in detail from the accessories included with this product.

(The contents of the accessories may also be changed without notice.)

Please read End-user License Agreement (p.64-65) before opening the accessories.

- Discs for recording are not supplied. Please purchase them separately.

# Table of Contents

<b>Introduction</b>	Overview .....	2
	Features .....	3
	Accessories .....	4
	Important Safety Notice.....	6
	LASER Product .....	7
	Important Safety Instructions.....	8
	Operating Precautions.....	10
	Compatible Discs .....	12
	Parts and Functions .....	16
<hr/>		
<b>Preparation</b>	System Requirements .....	18
	Setup Your Computer.....	19
	• Supplied Software .....	19
	• Operating Procedures .....	20
	• Confirmation of Windows Version .....	21
	• Confirmation of USB Type.....	22
	• Installing USB Driver .....	24
	• Using DVD-RAMs in UDF 2.0 Format .....	26
	• Installing UDF Reader .....	27
	• Checking Setup .....	29
	Connecting to Computer .....	30
	• Connecting USB Cable.....	30
• Disconnecting USB Cable .....	31	
<hr/>		
<b>Operation</b>	Inserting / Removing a Disc .....	33
	• Inserting a Disc.....	33
	• Removing a Disc .....	34
	• When You Cannot Remove the Disc.....	35
	Using DVD-RAMs.....	36
	Using Other Discs .....	37
	Before Installing Applications .....	38
	Installing Video Playback Software .....	39
	Installing Writing Software.....	42
<hr/>		
<b>For Your Reference</b>	How to Make the CB30A Driver Installation Floppy Disk .....	45
	Maintenance.....	46
	Troubleshooting.....	47
	FAQ .....	53
	Recommendations .....	61
	Specifications .....	62
	End-user License Agreement.....	64
	Glossary .....	66
	Index.....	69
	Limited Warranty .....	71
Product Information .....	74	

# Important Safety Notice

## For U.S.A.

### Federal Communications Commission Radio Frequency Interference Statement

**Note:**

This equipment has been tested and found to comply with the limits for a Class B digital device, pursuant to Part 15 of the FCC Rules. These limits are designed to provide reasonable protection against harmful interference in a residential installation. This equipment generates, uses and can radiate radio frequency energy and, if not installed and used in accordance with the instructions, may cause harmful interference to radio communications.

However, there is no guarantee that interference will not occur in a particular installation. If this equipment does cause harmful interference to radio or television reception, which can be determined by turning the equipment off and on, the user is encouraged to try to correct the interference by one or more of the following measures:

- Reorient or relocate the receiving antenna.
- Increase the separation between the equipment and receiver.
- Connect the equipment into an outlet on a circuit different from that to which the receiver is connected.
- Consult the Panasonic Service Center or an experienced radio / TV technician for help.

**Warning:**

To assure continued compliance, use only shielded interface cables when connecting to a computer or peripheral. Also, any changes or modifications not expressly approved by the party responsible for compliance could void the user's authority to operate this equipment.

This device complies with Part 15 of the FCC Rules, Operation is subject to the following two conditions:

- (1) This device may not cause harmful interference, and
- (2) This device must accept any interference received, including interference that may cause undesired operation.

Trade Name : Panasonic  
Model Name : KXL-CB30AU  
Responsible Party : Panasonic Digital Document Company  
Unit of Matsushita Electric Corporation of America  
Address : Two Panasonic Way  
Secaucus, New Jersey 07094  
Telephone No. : 1 - 800 PANASYS (726 - 2797)

## For Canada

**Notification:**

This Class B digital apparatus complies with Canadian ICES-003.

Cet appareil numérique de la classe B est conforme à la norme NMB-003 du Canada.

# LASER Product

## Class 1 LASER Product

This drive is classified as a Class 1 LASER product and there is no hazardous LASER radiation with the safety protection.

### CAUTION

Use of optical instruments with this product will increase eye hazard. Use of control, adjustment or performance of procedures other than those specified herein may result in hazardous radiation exposure.

As the laser beam in this drive is harmful to the eyes, do not open covers and do not repair yourself. Refer servicing to qualified personnel only.

### LASER Properties of the Drive

Laser Class	Class 1 (HHS and IEC 825-1)	
Wavelength	for CD	780 - 789 nm
	for DVD	655 - 668 nm

The CLASS 1 LASER PRODUCT label is located at the bottom of the drive.

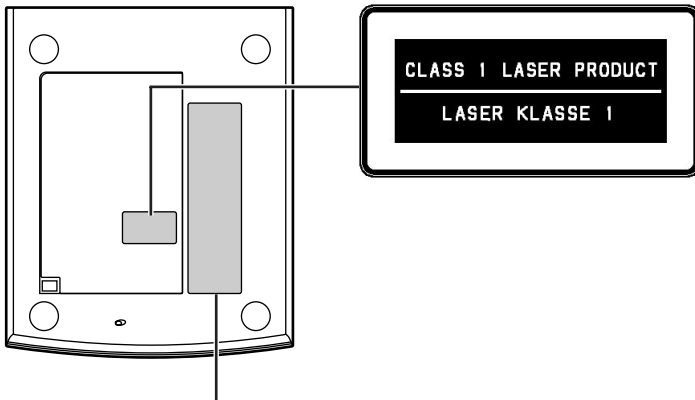

CAUTION	CLASS 3B VISIBLE AND INVISIBLE LASER RADIATION WHEN OPEN. AVOID EXPOSURE TO BEAM.	JD000201ZA
ATTENTION	CLASSE 3B RAYONNEMENT LASER VISIBLE ET INVISIBLE EN CAS D'OUVERTURE. EXPOSITION DANGEREUSE AU FAISCEAU.	
VORSICHT	KLASSE 3B SICHTBARE UND UNSICHTBARE LASERSTRAHLUNG, WENN ABDECKUNG GEÖFFNET. NICHT DEM STRAHL AUSSETZEN.	
ADVARSEL	KLASSE 3B SYNLIG OG USYNLIG LASERSTRÅLING VED ÅBNING. UNDGÅ UDS/ETTELSE FOR STRÅLING.	
ADVARSEL	KLASSE 3B SYNLIG OG USYNLIG LASERSTRÅLING NÅR DEKSEL ÅPNES. UNNGÅ EKSPONERING FOR STRÅLEN.	
VARNING	KLASS 3B SYNLIG OCH OSYNLIG LASERSTRÅLNING NÅR DENNA DEL ÄR ÖPPNAD. STRÅLEN ÄR FARLIG.	
VARO!	KURSSI 3B NÄKYVÄ JA NÄKYMÄTÖN AVATTAESSA OLET ALTTIINA LASERSÄTEILYLLE. ÄLÄ KATSO SÄTEESEN.	

# Important Safety Instructions

- **To avoid damaging Power cord, power plug and AC adaptor, do not do any of the following:** Scratching / Modifying / Putting them near heater / Bending / Twisting / Pulling / Placing heavy objects on them / Tying them in a bundle / Covering them with a cloth. Using damaged Power cord, power plug and AC adaptor may cause electric shock, short and fire. For cord and plug repairing, contact a service office.

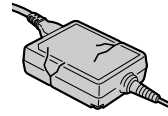

- **Use only AC 120V. Make sure AC outlet or cords for AC adaptor do not exceed the limit of their electrical ratings.** Fire caused by overheating may result from connecting too many cords to the same outlet.

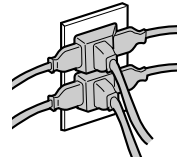

- **Periodically remove dust from prongs of AC cord.** Accumulated dust on the plug may cause defective installation and result in fire. Wipe power plug with a dry cloth. Remove power plug when drive is not in use for a prolonged period.



- **Fully insert prongs of AC cord into AC outlet.** If the prongs are not fully inserted, there is a danger of electric shock or overheating that may cause fire. Do not use damaged plug or worn outlet.

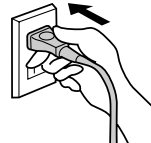

- **Do not plug or remove AC cord with wet hands.** It may cause electric shock.



- **Never attempt to disassemble or repair drive yourself.** This is a class 1 LASER product. Laser light may cause damage to your eyesight. All internal inspection and repair should be done by qualified service personnel.

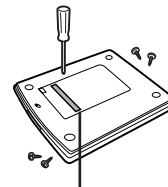

CLASS 1 LASER PRODUCT  
LASER KLASSE 1



# Important Safety Instructions

- **Unplug AC cord from outlet if any of the following happen:**

- It is damaged.
- Foreign objects get into it.
- It emits smoke or odor.
- It becomes excessively hot.

Because fire or electric shock may be caused by continued use. If any of the above occur, immediately turn off the Power Switch and unplug AC cord from outlet.

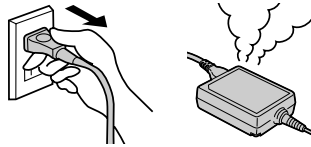

- **Do not touch metallic parts of drive, AC adaptor or AC cord when there is lightning.**

It may cause electric shock.

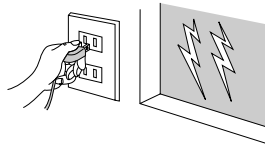

- **Do not move drive when AC cord is connected to AC outlet.**

AC cord may be damaged and it may cause fire or electric shock.

If AC cord is damaged, unplug AC cord from outlet immediately, then contact a service office.



- **Disconnect AC cord from AC outlet by pulling on the plug.**

Pulling AC cord may cause damage to the cord itself, and then it may cause fire or electric shock.

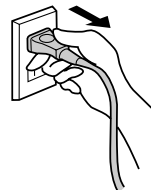

- **Avoid direct contact for a prolonged period.**

Direct contact with a high-temperature part of AC adaptor may cause low-temperature burns.

Low-temperature Burns:

Low-temperature burns may be caused by prolonged contact of the same part of the skin with an object that has an even slightly higher temperature than body temperature.

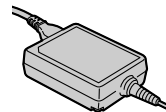

- **Do not move or lift drive while disc inside is rotating.**

If the disc becomes detached, it may be damaged.



- **Do not use cracked or repaired discs.**

Disc may break and cause injury.



# Operating Precautions

## Location

- Do not place drive where it will be exposed to direct sunlight or where the temperature will become excessively high. It may cause deformations, discoloration or breakdown.

## Usage

- Do not use other USB cables except for the supplied one. It may cause a drive or computer breakdown.
- Do not place drive where it is extremely dusty or filled with greasy fumes, or it is humid, e.g. near a humidifier or in the kitchen. It may cause a breakdown.
- Do not use drive when condensation has formed in or on it. (When drive is suddenly taken from a cold place to a warm place, condensation will form, causing drive to malfunction. In such cases, remove the disc and leave drive for about an hour before use.)
- Do not bring magnets or magnetic objects near drive. (Operation may become unstable due to the effects of the magnetism.)
- Do not insert metal objects into drive. It will cause a breakdown.
- Do not touch lens. It will cause an audio skip or failure of data reading and writing.
- If drive is used near a radio or TV set and it causes interference with reception, place drive at least 6'6" (2 meters) away from the radio or TV set, and if sharing AC outlet with them, use another AC outlet.

## Transport

- When you carry the drive, remove the disc, close the Disc Cover and remove the cable.
- Do not drop the drive or bump it into objects when moving or transporting it.

## AC Adaptor

- Use only AC adaptor KX-WZ712 and Power cord supplied with drive. Using other AC adaptors and Power cords may cause a breakdown.

## General Information

Matsushita Electric Industrial Co., Ltd. herewith declares that it will not be liable for any loss of data or any other damage, whether direct or indirect, caused by the operation or malfunctioning of this product. Back up important data to protect it from possible loss.

### For Copy Control CD (copy protected CD)

- When using CDs that do not conform to the CD-DA (Compact Disc Digital Audio) standards, such as “Copy Control CDs”, the performance and sound quality is not guaranteed.
- If the drive can play back or read CDs that conform to the CD standards without a problem, but cannot play back or read a special disc like the Copy Control CD above, check the disc, package, pamphlet etc. and contact the disc manufacturer.

### Observance of copyright















Enjoy your image and audio recordings and other data for personal use. Other unauthorized use is prohibited under copyright law.

### Discs Recorded with Panasonic DVD Video Recorder



- To play back DVD-RAMs recorded with DVD video recorders, UDF Reader compatible with UDF2.0 format is required.  
For Windows OSs other than Windows XP, install the supplied UDF Reader. (For Windows XP, UDF installation is not required.)
- To play back a DVD-R recorded with a DVD video recorder, it is necessary to finalize the DVD-R using the DVD video recorder used for recording.

# Compatible Discs

The discs bearing the logos shown below can be used with this drive.

For Reading		For Reading / Writing	
DVD-Video <sup>1</sup>		Video CD <sup>3</sup>	
DVD-RAM <sup>2</sup>		CD-EXTRA	
DVD-R		CD-DA	
DVD-RW		CD TEXT <sup>3</sup>	
DVD-ROM		CD-ROM	
Photo CD <sup>4</sup>		CD-ROM XA	
		CD-R	
		CD-RW	
			
			

\* Data may not be read properly depending on disc conditions such as recording quality, scratches, dirt, deformation or copy protection.

- <sup>1</sup> DVD-Videos with Region Code  or  can be played back. For DVD-Videos with other Region Codes, it is necessary to change the Region Code settings. Region Code can be reset up to 4 times. After the Region Code has been reset for the fourth time, the setting is fixed and cannot be changed.
- <sup>2</sup> Use only non-cartridge type discs, and TYPE 2 and TYPE 4 discs removed from cartridges.
- <sup>3</sup> It can be played back using the supplied applications.
- <sup>4</sup> Dedicated software for Photo CDs is required separately.

## Handling Discs

Data may not be written correctly or data that has already been written may be damaged if these discs are not handled correctly. Incorrect handling may also damage your drive. Read carefully these instructions and the instructions that came with the disc you are using.

### Handling

■ **Avoid direct sunlight, high temperature and humidity.**

Disc may be damaged or become deformed, and data cannot be written or read properly.

■ **Do not touch the recording surface.**



Fingerprints, dirt, dust and scratches on the recording surface of discs can affect the reading and writing of data.

■ **Do not scrub the recording surface with a dry cloth.**

Disc may be damaged or become deformed, and data cannot be written or read properly.

■ **Do not write or adhere labels on the disc except for on the label side.**



Fingerprints, dirt, dust and scratches on the recording surface of discs can affect reading and writing.

- Write on the label side only with a soft, oil-based felt pen. Do not use ballpoint pens or other hard writing implements.

■ **Do not use benzene, paint thinners or other solvents.**

Disc may be damaged or become deformed, and data cannot be written or read properly.

■ **Do not throw or bend disc.**

Disc may be damaged or become deformed, and data cannot be written or read properly.

### DVD-RAM variations

DVD-RAM is a removable disc developed as a “DVD to which data can be written”, aiming at reading and writing large computer data.

There are the following types of DVD-RAMs.

- TYPE1  
The disc inside cannot be removed.
- TYPE2  
A “single sided” disc. The disc inside can be removed.
- TYPE4  
A “double sided” disc. The disc inside can be removed.
- Non-cartridge type

This drive is only compatible with non-cartridge type DVD-RAMs. To use TYPE2 or TYPE4 DVD-RAMs, remove the discs from cartridges.

# Compatible Discs

## Using TYPE2 / TYPE4 DVD-RAMs

### Removing a Disc from a Cartridge

To remove a disc from a cartridge, follow the procedure shown below.

[The discs illustrated below are Panasonic 12 cm DVD-RAMs. When using other discs, refer to instructions supplied with discs.]

### To remove a disc from TYPE2 cartridge

- 1 Break and remove the locking pin using a pointed object such as a ballpoint pen.**
- 2 Open the cover of the cartridge pressing the hole located on the left side with a pointed object.**
- 3 Remove the disc horizontally, taking care not to soil or damage the disc.**

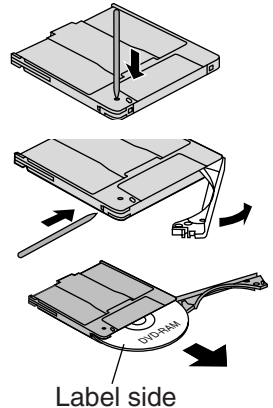

### When storing a disc

- Match the label side of the disc with the label side of the cartridge and insert fully.
- Check the setting of the write-protect switch after closing the cover.

### Cautions

- Do not try to open the cover by force.
- Do not insert discs other than DVD-RAM into empty cartridges.
- Take care that the disc's recording surface is not contaminated with fingerprints, dirt, dust, scratches, or liquids. Do not write on the recording surface.
- Write on the label side of the disc only with a soft, oil-based felt pen. Do not use ballpoint pens or other hard writing implements.
- Do not attach other labels or protective covers. Do not use coatings.
- Clean the disc with the special DVD-RAM/PD disc cleaner\*. Do not use benzene, thinners, anti-static fluids, or any other solvent.
- Return discs to their cartridges when you are not using them.
- Do not drop or bend discs.

\*Use LF-K200DCA1 for cleaning.

## To remove a disc from TYPE4 cartridge

- 1 Break and remove the two locking pins using a pointed object such as a ballpoint pen.**
- 2 Open the cover of the cartridge pressing the hole located on the left side with a pointed object.**
- 3 Remove the disc horizontally, taking care not to soil or damage the disc.**

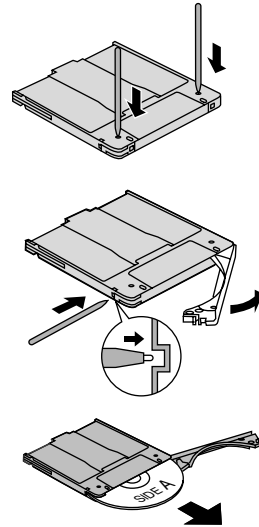

## When storing a disc

- Match the side A of the disc with the side A of the cartridge and insert fully.
- Check the setting of the write-protect switch after closing the cover.

## Cautions

- Do not try to open the cover by force.
- Do not insert discs other than DVD-RAM into empty cartridges.
- Take care that the disc's recording surface is not contaminated with fingerprints, dirt, dust, scratches, or liquids. Do not write on the recording surface.
- Do not attach other labels or protective covers. Do not use coatings.
- Clean the disc with the special DVD-RAM/PD disc cleaner\*. Do not use benzine, thinners, anti-static fluids, or any other solvent.
- Return discs to their cartridges when you are not using them.
- Do not drop or bend discs.

\*Use LF-K200DCA1 for cleaning.

# Parts and Functions

## Front/Top/Right View

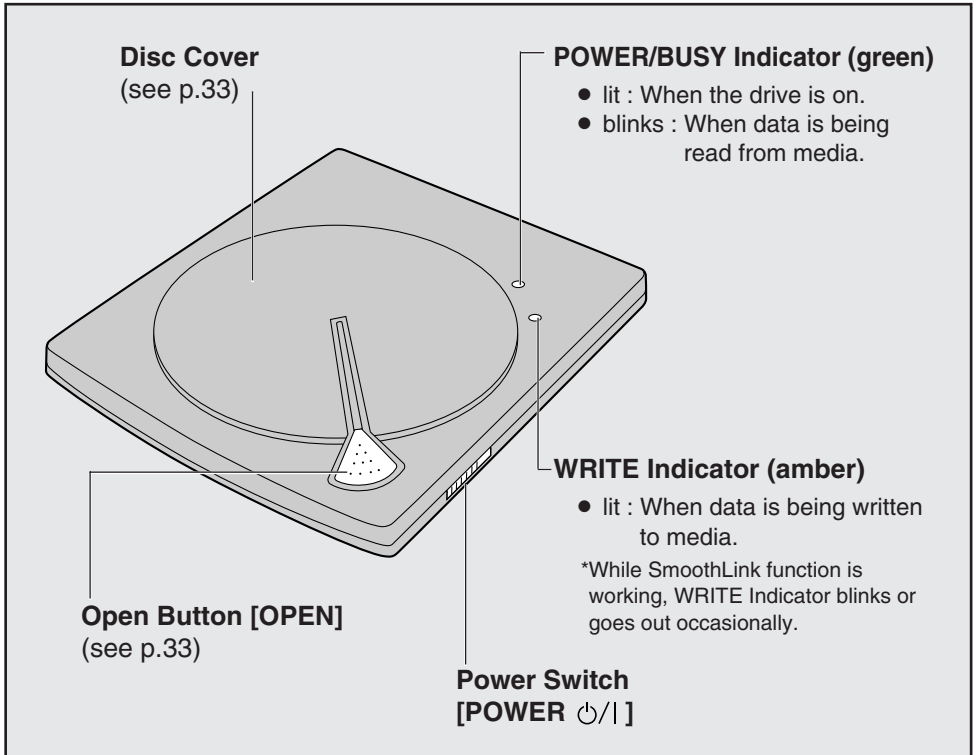

### Cautions:

- Be sure to remove the Lens Protection Sheet before use.
- To open the Disc Cover, see p.35.

### Lens Protection Sheet

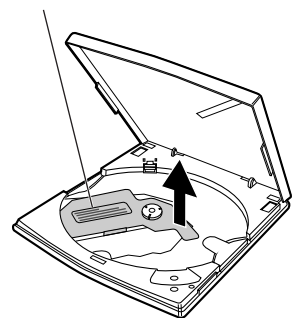



## Rear/Bottom View

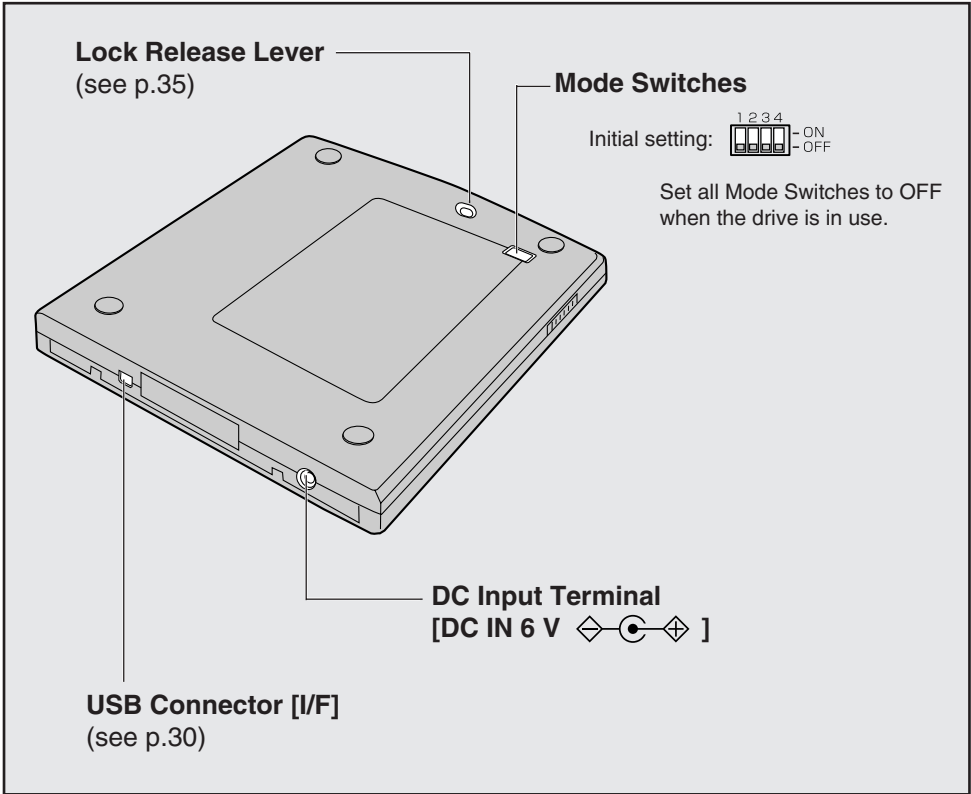

# System Requirements

<b>Computers<sup>1</sup></b>	<ul style="list-style-type: none"><li>● IBM PC / AT compatible computer</li></ul>
<b>Windows OSs</b>	<ul style="list-style-type: none"><li>● Windows® XP</li><li>● Windows Me</li><li>● Windows 2000</li><li>● Windows 98SE</li></ul>

## ■ When Visual Application (Video Playback Software) is used :

<b>CPU</b>	Pentium® II 400 MHz or higher (Pentium® III 700 MHz or higher recommended)
<b>Memory</b>	64 MB or more (128 MB or more recommended) (For Windows XP, 128 MB or more recommended)
<b>Hard disk space<sup>2</sup></b>	20 MB or more
<b>Display</b>	1024 x 768 pixels or higher 24-bit color Direct X compatible (Direct X 8.1 or later)

## ■ When Data Applications (Writing Software) are used :

<b>CPU</b>	Pentium® II 300 MHz or higher
<b>Memory</b>	64 MB or more (128 MB or more recommended)
<b>Hard disk space<sup>2</sup></b>	100 MB or more (800 MB or more recommended)
<b>Display</b>	800 x 600 pixels or higher 16-bit color or higher Direct X compatible (Direct X 8.1 or later)

\*1 Use USB2.0 for writing to CD-R at 8X or higher, re-writing to CD-RW and playing back DVD-Video.

The performance of this drive is not guaranteed unless the supplied USB cable is used.

The performance of this drive connected via a USB hub is not guaranteed.

\*2 Ensure you have the contiguous hard disk space for stable writing.

# Setup Your Computer

## Supplied Software

The following software programs are included on the CD-ROM supplied with this drive.

It is necessary to install the driver software to use this drive.

### Driver Software

Install the following driver software first.

#### 1. USB Driver

This is a device driver for Windows 98SE / Windows Me. If you use Windows 98SE / Windows Me, it is necessary to install this driver first.

- Install the USB Driver from the CD-ROM.

#### Notes:

- For Windows Me, this drive can be operated with the OS standard USB driver, but it is possible that malfunctions will occur. We recommend you install the USB Driver supplied with this drive.
- For Windows 98SE, use a working drive for installation other than this drive.

#### 2. UDF Reader

UDF Reader is driver software for reading DVD-RAMs in UDF 2.0 format. (DVD-RAMs recorded with a DVD video recorder are formatted in UDF 2.0.) UDF Reader installation is required for Windows OSs other than Windows XP.

- Install the UDF Reader from the CD-ROM.

#### Note:

- UDF Reader and USB Driver can be installed at the same time.

### Application Software

Install applications as you require (see p.38).

#### 1. DVD-Video Playback Software

– WinDVD 4

#### 2. Writing Software

CD-R/-RW Writing Software

– B's Recorder GOLD5 BASIC

CD-RW Packet Writing Software

– B's CLiP5

# Setup Your Computer

## Operating Procedures

Preparation

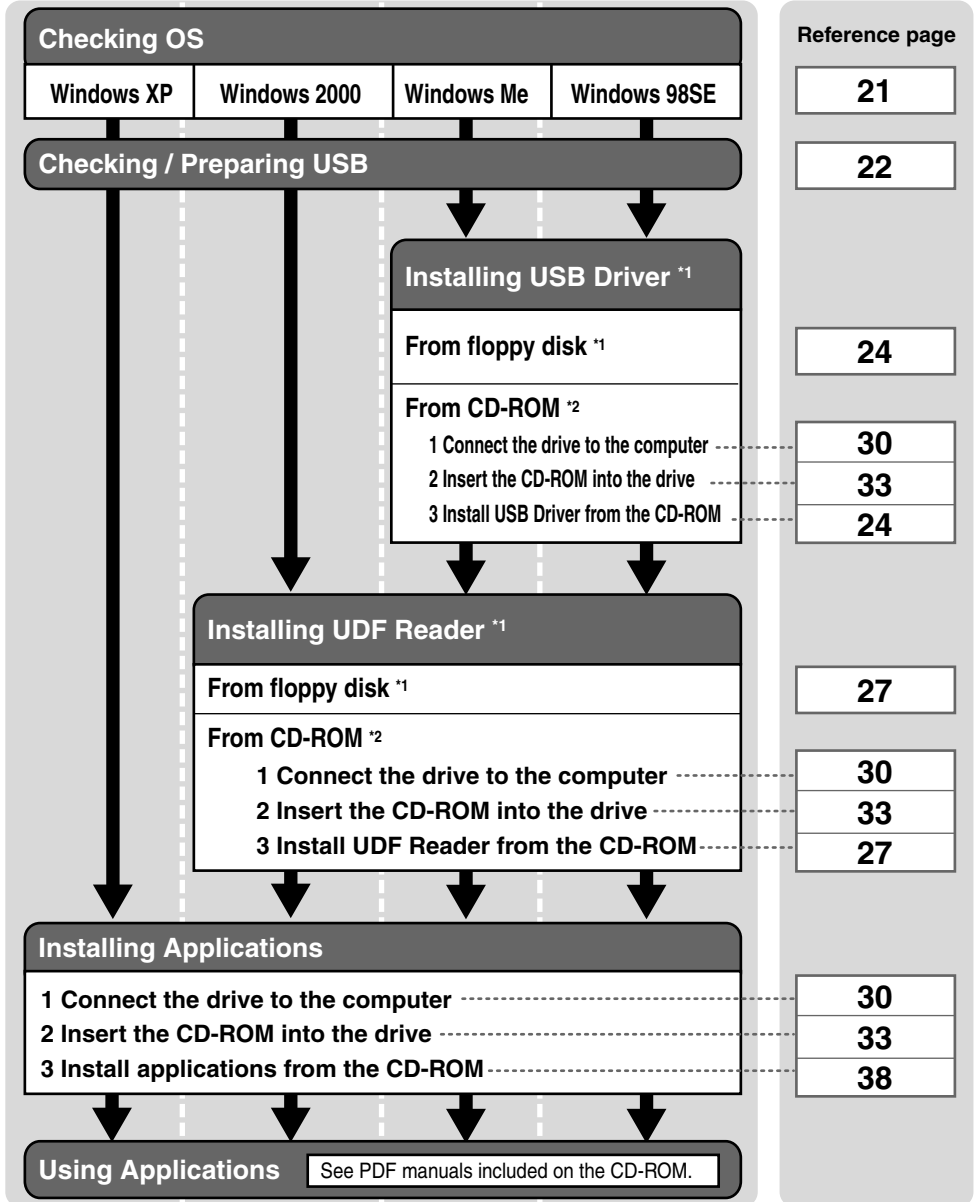

<sup>\*1</sup> USB Driver and UDF Reader can be installed at the same time.

<sup>\*2</sup> For Windows 98SE, use another drive other than this drive for installation.

# Setup Your Computer

Screen examples are from Windows XP unless otherwise indicated.  
For other Windows OSs, follow the equivalent prompts or instructions.

## Confirmation of Windows Version

Check the Windows OS version of your computer.

### Windows XP

From Task Bar, click [start] then right-click [My Computer] and click [Properties]. [System Properties] window appears on the screen.

### Windows 2000 / Windows Me / Windows 98SE

Right-click [My Computer] icon on the screen, then click [Properties]. [System Properties] window appears on the screen.

Confirm at the System Properties Window that "Microsoft Windows XP", "Microsoft Windows 2000", "Microsoft Windows Me" or "Microsoft Windows 98 Second Edition" is installed.



Indicates OS and version

#### Note:

This drive cannot be used with Windows 95, Windows 98 and Windows NT®.

# Setup Your Computer

## Confirmation of USB Type

If the computer is not compatible with USB2.0 and you use this drive connected to a USB port of the computer, this drive can only deliver USB1.1 performance. If you want USB 2.0 performance, it is necessary to purchase a USB2.0 interface card (see p.61).

Refer to the computer manual to check which USB standard applies.

### ■ Using USB1.1

If you use Windows 98SE / Windows Me, the USB Driver included on the CD-ROM must be installed. Go to “Installing USB Driver” on p.24.

\* If you use a Windows OS other than Windows 98SE / Windows Me, the USB Driver installation is not required.

#### Windows XP / Windows 2000

**USB Driver installation is not required.**

Drive runs with standard USB driver included in OS.



Go to “Installing UDF Reader” on p. 27.

#### Windows 98SE / Windows Me

For Windows Me, this drive can be operated with the OS standard USB driver, but it is possible that malfunctions will occur. We recommend you install the USB Driver supplied with this drive.

**Install the supplied USB Driver.**



Go to “Installing USB Driver” on p. 24.

#### Notes:

##### When the drive is connected with USB 1.1:

- Writing and reading speeds are about 8X at maximum.
- When playing a DVD-Video, frame-drops or block-noises may occur.

**We recommend you use USB2.0 for writing to CD-R at 8X or higher, re-writing to CD-RW and playing back DVD-Video.**

## ■ Using USB2.0

### When computer compatible with USB2.0 is used

- **Windows XP**

The USB Driver supplied with this drive is not required.  
(If Windows XP Service Pack 1 has not been installed, download using Windows Update.)

Go to “Connecting USB Cable” on p.30.

- **Windows 2000**

After downloading updates from Windows Update, go to “Installing UDF Reader” on p.27.

### When computer that is not compatible with USB2.0 is used

Connect a USB2.0 interface card to the computer, then install a USB driver appropriate to the OS on your computer. (Check the interface card manufacturer’s home page for the latest information.)

- **Windows XP**

USB driver is available from Microsoft Windows Update.  
Download Service Pack 1.



Go to “Connecting USB Cable” on p.30.

- **Windows 2000**

USB driver update is available from Microsoft Windows Update.  
Download Service Pack 4.  
USB driver may be supplied with the interface card. Check the card’s instruction manual or manufacturer’s home page for the latest information.



Go to “Installing UDF Reader” on p.27.

- **Windows 98SE / Windows Me**

Install USB driver supplied with interface card.  
The USB Driver supplied with this drive can also be used.



Go to “Installing USB Driver” on p.24.

# Setup Your Computer

## Installing USB Driver

The USB Driver supplied with this drive is for Windows 98SE and Windows Me. (USB Driver installation is not required for Windows OSs other than Windows 98SE / Windows Me.)

### Caution:

- Use the computer on AC power (not battery) to avoid power-down during setup.

### Note:

- For Windows Me, this drive can be operated with the OS standard USB driver, but it is possible that malfunctions will occur. We recommend you install the USB Driver supplied with this drive.

Preparation

## Installing USB Driver from Floppy Disk

- 1 Insert the floppy disk into floppy disk drive.**  
(Refer to “How to Make the CB30A Driver Installation Floppy Disk” on p.45.)
- 2 Double-click [My Computer] icon on the screen, then double-click [A:] (if the floppy disk drive is A).**
- 3 Double-click [Dsetup.exe].**  
Setup window appears.  
(Go on to 4 on next page.)

## Installing USB Driver from CD-ROM

- 1 Insert the supplied CD-ROM into the drive.**  
The program starts automatically, then Setup Menu appears.



### Notes:

- If the program does not start automatically, open My Computer and double-click CD-ROM icon, then double-click [Asmenu.exe - For Windows 98SE, use a working drive other than this drive for installation.



**2** Click [CB30A Driver] in Setup Menu.

**3** OS Check window appears. Click [Yes].  
USB Driver installation program starts.

**4** Setup window appears. Click [USB Driver] and select [Install], then click [OK].

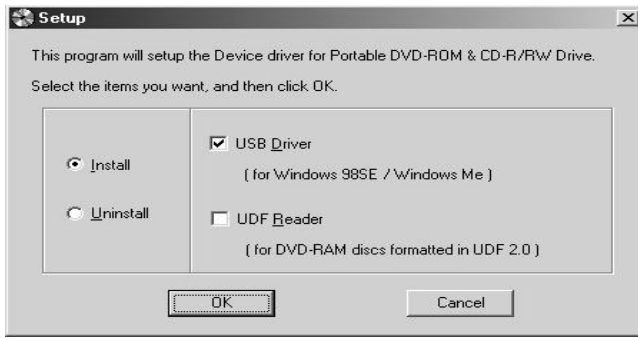

**5** When installation completion window appears, click [OK].

When USB Driver has been installed from the floppy disk, remove the floppy disk and close the floppy disk window.

When installed from CD-ROM, applications included on the CD-ROM can be installed successively. To end installation, click [END].

**Note:**

- USB Driver and UDF Reader can be installed at the same time. Select both USB Driver and UDF Reader.

When both have been installed at the same time, restart the computer after installation.

■ **To uninstall USB Driver**

Follow the steps on p.24 and 25, then at step 4, click [USB Driver] and select [Uninstall] on the Setup window, then click [OK].

# Setup Your Computer

## Using DVD-RAMs in UDF 2.0 Format

To read DVD-RAMs in UDF 2.0 format, a UDF reader compatible with UDF 2.0 format is required.

Install the UDF Reader included on the CD-ROM supplied with this drive.

Only UDF formatted DVD-RAMs that are removable from cartridges or non-cartridge type can be used with this drive.

Preparation

### ■ Using DVD-RAMs in UDF 2.0 format

When DVD-RAMs are not used, go to “Checking Setup” on p.29.

#### Windows XP

UDF Reader installation is not required.



Go to “Checking Setup” on p. 29.

#### Windows 2000 / Windows Me / Windows 98SE

Use UDF Reader supplied with this drive.



Go to “Installing UDF Reader” on p. 27.

## Installing UDF Reader

The UDF Reader supplied with this drive is for Windows 98SE / Windows Me / Windows 2000.

For Windows 2000, log in as a member of the users of Administrator group when installing.

### Caution:

- Use the computer on AC power (not battery) to avoid power-down during setup.

## Installing UDF Reader from Floppy Disk

- 1 Insert the floppy disk into floppy disk drive.**  
(Refer to “How to Make the CB30A Driver Installation Floppy Disk” on p.45.)
- 2 Double-click [My Computer] icon on the screen, then double-click [A:] (if the floppy disk drive is A).**
- 3 Double-click [Dsetup.exe].**  
Setup window appears.  
(Go on to 4 on next page)

## Installing UDF Reader from CD-ROM

- 1 Insert the supplied CD-ROM into the drive.**  
The program starts automatically, then Setup Menu appears.



### Notes:

- If the program does not start automatically, open My Computer and double-click CD-ROM icon, then double-click [Asmenu.exe - For Windows 98SE, use a working drive other than this drive for installation.

# Setup Your Computer

- 2 Click [CB30A Driver] in Setup Menu.
- 3 OS Check window appears. Click [Yes].  
UDF Reader installation program starts.
- 4 Setup window appears. Click [UDF Reader] and select [Install], then click [OK].

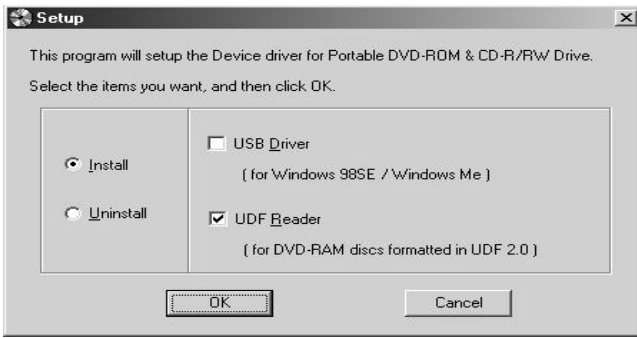

- 5 When Installation completion window appears, click [OK].  
When UDF Reader has been installed from the floppy disk, remove the floppy disk, then restart the computer following the on-screen instructions.  
When installed from CD-ROM, restart the computer following the on-screen instructions.

## Note:

- It is necessary to restart the computer in order to enable the UDF Reader after installation.
- **To uninstall UDF Reader**  
Follow the steps on p.27 and 28, then at step 4, click [UDF Reader] and select [Uninstall] on the Setup window, then click [OK].



## Checking Setup

### 1 Connect the drive to the computer.

See “Connecting USB Cable” on p.30.

### 2 Double-click [My Computer] icon without inserting disc.

#### Notes:

- This drive can be used when drive icons  (for Windows XP) or  (for other Windows OSs) is added.
- If one of the above icons does not appear correctly, select [Refresh] from pull-down menu in [View].
- If the drive icon is not added to My Computer, see “Troubleshooting” on p.47.

# Connecting to Computer

## Connecting USB Cable

Make sure that connection is established correctly.

(Example)

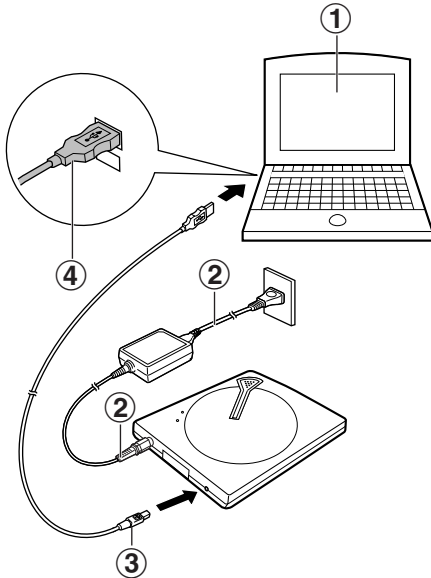

- ① Start up your computer.
- ② Connect the AC cord with AC adaptor, then connect to the drive.
- ③ Insert smaller plug of the supplied USB cable into drive USB Connector.
- ④ Insert bigger plug of the USB cable into a USB Connector on your computer.

The drive will be turned on automatically and POWER/BUSY Indicator (green) is lit.

### Notes:

- The drive is turned ON/OFF automatically when the computer is turned ON/OFF.
- The drive can be turned ON/OFF automatically by connecting / disconnecting the USB cable.

### Cautions:

- Use only the USB cable supplied.  
(Use of other cables may damage the drive and your computer.)
- Unplug the AC cord from AC outlet when the drive is not in use for a prolonged period in order to save electricity. [When only the AC adaptor is connected, the AC adaptor consumes only 1W (at AC 120 V) of power.]
- Connect the USB cable directly to your computer's USB port.  
We cannot guarantee connection through a USB hub.
- Do not turn off the drive when the computer is running and the drive is still connected to the computer.

## Disconnecting USB Cable

Before disconnecting USB cable, finish any writing, reading, or audio playback etc. performed by the application software, and then remove the disc from the drive.

### Cautions:

- While POWER/BUSY Indicator (green) is blinking or WRITE Indicator (amber) is lit:
  - Do not disconnect USB cable.
  - Do not disconnect AC adaptor.(It may cause data corruption or computer operation failure. If the operation becomes uncontrollable, restart or reset the computer.)
- When “B’s CLiP5” is in use, right-click the [B’s CLiP] indicator in Task Tray. Select [Eject], then remove the disc and disconnect the USB cable.

## Windows XP / Windows 2000

- 1 Double-click  icon in Notification Area (Task Tray).**

[Safe To Remove Hardware] window appears.  
(The expression may differ depending on the Windows OS version. Follow the equivalent prompts or instructions.)
- 2 Select “USB Mass Storage Device” and click [Stop] button.**

[Stop hardware device] window appears.
- 3 Check “GENERIC CDRCB03 USB Device” is connected, then click [OK].**

Follow the on-screen instructions thereafter.  
After disconnecting the interface cable, close the [Safe To Remove Hardware] window.

# Connecting to Computer

## ■ Windows XP



(The window disappears automatically after a while.)

## ■ Windows 2000



Preparation

## Windows Me / Windows 98SE

### ■ When using the supplied USB Driver

The USB connectors can be Hot Plugged. This means the interface cable can be connected to or disconnect from the computer while it is ON.

### ■ When using OS standard device driver under Windows Me

#### 1 Double-click icon in Task Tray.

Follow the on-screen instructions thereafter.





# Inserting / Removing a Disc

This drive has a power-open mechanism. The Disc Cover will not open when the power is turned off.

## Inserting a Disc

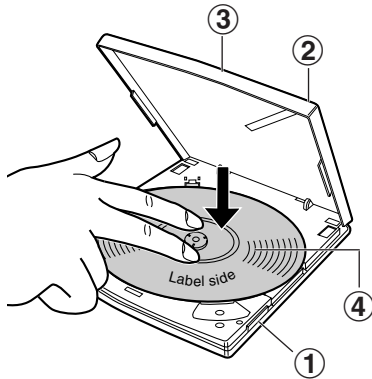

- ① Turn on the drive.**  
The drive is turned on/off automatically when the computer is turned on/off.
- ② Press the Open Button.**  
(The Disc Cover will open by selecting [Eject] in the active application.)
- ③ Open the Disc Cover.**
- ④ Place a disc onto the disc spindle.**  
Press on the center of a disc until it locks onto the disc spindle.
- ⑤ Close the Disc Cover.**

### Cautions:

- Make sure the disc is securely set. (If not, the disc may come off and be damaged.)
- When the power is off, release the Disc Cover lock using Lock Release Lever (see p.35).

### Note:

- This drive is only compatible with non-cartridge type DVD-RAMs. To use TYPE2 or TYPE4 DVD-RAMs, remove the discs from cartridges.

# Inserting / Removing a Disc

This drive has a power-open mechanism. The Disc Cover will not open when power is turned off.

## Removing a Disc

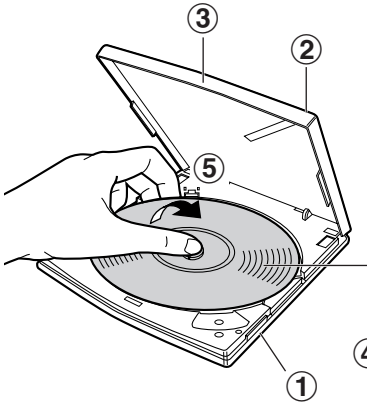

- ① Turn on the drive.**  
The drive is turned on/off automatically when the computer is turned on/off.
- ② Press the Open Button.**  
(The Disc Cover will open by selecting [Eject] in the active application.)
- ③ Open the Disc Cover.**
- ④ Make sure the disc has stopped rotating.**
- ⑤ Remove the disc.**  
Pressing the disc spindle, lift the disc by holding its edge.

### Caution:

- When using the drive connected to a computer, make sure POWER/BUSY Indicator (green) is not blinking, or WRITE Indicator (amber) is not lit after the application using this drive is closed.

### Notes:

- The Disc Cover is locked while the media formatted with B's CLiP is used. Release the lock by selecting [Eject] from the indicator in Task Tray.
- During data writing, the WRITE Indicator lights and the Disc Cover is locked, so it will not open.

## When You Cannot Remove the Disc

### ■ Disc Cover Lock Force Release

If the Disc Cover will not open due to the failures occurred while writing data to a disc or during power-down, or when the drive is not turned on, the Disc Cover lock can be released manually to open the Disc Cover.

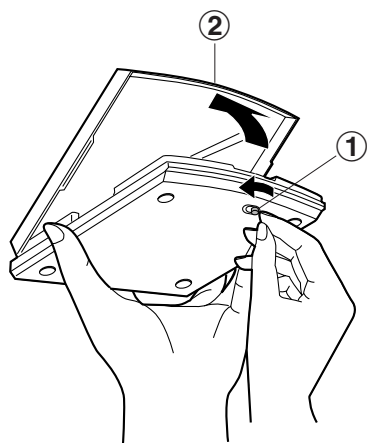

- ① Slide the Lock Release Lever located on the bottom.
- ② Open the Disc Cover.

#### Caution:

- If the disc will not stop rotating, unplug the AC cord of AC adaptor and wait until the rotating stops completely. If the Disc Cover is opened while the disc is still rotating, the disc may come off.

# Using DVD-RAMs

This drive is only compatible with non-cartridge type DVD-RAMs.  
To use TYPE2 or TYPE4 DVD-RAMs, remove the discs from cartridges.

## Caution:

- Take care not to contaminate the recording surface with fingerprints, dirt, dust and scratches. Do not drop or bend discs, or adhere labels on the recording surface.

## Notes:

- It may differ how to remove the discs from cartridges according to the disc manufacturer. Read the disc's handling instructions carefully.
- For DVD-RAMs, a disc occasionally may take some time to be recognized. When it happens, remove the disc once, then insert it into the drive again. Disc conditions (dirt or scratches on the recording surface, or bad writing quality) may affect reading and writing.

## DVD-RAMs Recorded with DVD Video Recorder

"DVD\_RTAV" folder is created on the DVD-RAM recorded with a DVD video recorder or a DVD camcorder conforming to the "Video Recording standards", or with recording software program such as DVD-MovieAlbumSE 3 conforming to the same standard.

Do not access this folder or files in this folder on the computer. Some files in this folder exceed 2 GB. Due to the limit of Windows 98SE specifications, the files that exceed 2 GB may not be copied or the capacity of the disc may not be displayed correctly.

Also if this folder or files are deleted or modified, the disc cannot be played back with a DVD video recorder or a recording software program on the computer.

# Using Other Discs

## ■ CD-Rs

Using B's Recorder GOLD5 BASIC (see p.42), data CDs and Audio CDs can be created.

(Writing to CD-R with B's CLiP5 is not supported on this drive.)

## ■ CD-RWs

After formatting a CD-RW with B's CLiP5 format function (p.42), data in files can be written to the disc just like floppy disk. Also data CDs and Audio CDs can be created using B's Recorder GOLD5 BASIC.

## ■ DVD-Videos

DVD-Videos and Video CDs can be played back using WinDVD 4 (see p.39).

## ■ DVD-ROMs / CD-ROMs

For usage of DVDs/CD-ROMs, refer to the manuals supplied with DVD/CD-ROM applications or Readme files.

## ■ Audio CDs

To play back Audio CDs using this drive, it is necessary to enable Digital Playback on the computer. When Digital Playback is enabled, you can listen to the music from the speakers connected to the computer. (For details, refer to the computer instruction manual.)

# Before Installing Applications

If an earlier version of the same software or another company's writing / DVD-Video playback software is installed, uninstall them before installing the software supplied with this drive.

If not installed, go to next page.

## ■ Uninstalling Software

The expression may differ depending on Windows OS versions. Follow the equivalent prompts or instructions.

### Windows XP

- 1 From the Start Menu, select [Control Panel] → [Add or Remove Programs].**  
[Add or Remove Programs] window appears.
- 2 Select the software you want to remove from [Currently installed programs:], then click [Change/Remove].**
- 3 After removing the software, close [Add or Remove Programs], then restart the computer.**

### Windows 2000 / Windows Me / Windows 98SE

- 1 From the Start Menu, select [Settings] → [Control Panel] → [Add/Remove Programs].**  
[Add/Remove Programs] window appears.  
(For Windows Me / 98SE, [Add/Remove Programs Properties])
- 2 Select the software you want to remove from [Currently installed programs:], then click [Change/Remove].**
- 3 After removing the software, close [Add/Remove Programs], then restart the computer.**  
(For Windows Me / 98SE, [Add/Remove Programs Properties])

# Installing Video Playback Software

## ■ WinDVD 4

InterVideo WinDVD 4 is included on the CD-ROM supplied with this drive. Install it from the CD-ROM. For installation and handling, refer to WinDVD 4 manual included on the CD-ROM supplied with this drive.

### Cautions:

- If an earlier version of the same software or another company's video playback software is already installed, uninstall them before installing WinDVD 4.
- Close all applications and resident monitoring programs such as antivirus programs before starting installation.

### Note:

- For Windows 2000 / XP, log in as a member of the users of Administrator group when installing.

## Installing WinDVD 4

### 1 Insert the supplied CD-ROM.

(The program starts automatically and the screen shown below appears.)



To install WinDVD 4

### Note:

- If the program does not start automatically, open My Computer, double-click CD-ROM icon, then double-click [Asmenu.exe ] to start Setup Menu.

### 2 Click [WinDVD 4].

(WinDVD 4 installer starts. Follow the on-screen instructions to proceed.)

### 3 After installation is complete, click [END].

# Installing Video Playback Software

## Using WinDVD 4







Playback starts automatically after inserting a DVD-Video into the drive (when Auto Playback is ON).

If not, from Task Bar, click [start], then select [All Programs] → [InterVideo WinDVD 4] → [InterVideo WinDVD 4]. WinDVD 4 operating panel can be used for operation just like that of a home video recorder.

### Notes:

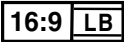
- Refer to WinDVD 4 manual included on the CD-ROM supplied with this drive for usage of WinDVD 4. To read the manual, click [WinDVD Manual], then select the manual you require.
- DVD-Video image quality changes depending on disc or computer performance, or usage conditions.

## Functional Indication

Symbol	Meaning
	Number of languages / sounds
	Number of captions
	Number of angles
	Types of recorded screen size
	Region Code
	Copy protect
	Closed caption
Single-sided, single layer disc	Disc type



# Installing Video Playback Software

## ■ Region Code

Many DVD-Videos (DVDs) are protected by a Region Code. Region Codes are administered separately for each region shown below.

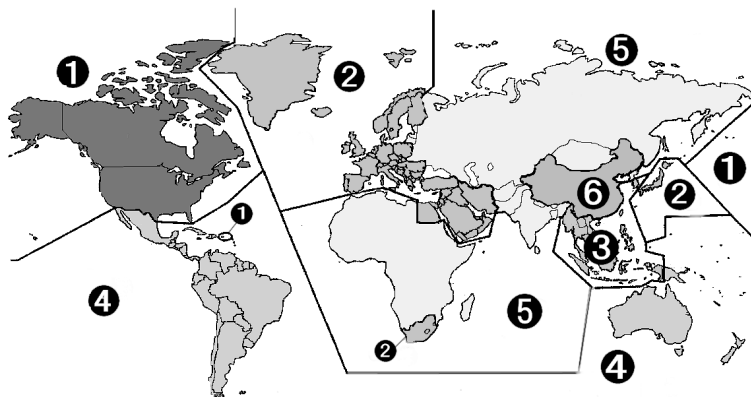

To watch a DVD-Video, the following Region Codes must be consistent with each other.

- Region Code of DVD
- Region Code of this drive
- Region Code of DVD-Video playback software (WinDVD 4)

When attempting to play back a DVD-Video with a different Region Code, a warning window appears. Click [OK]. Region Code setting window will appear. Check the setting and click [OK]. Playback software (WinDVD 4) and this drive will be set to a new Region Code. After checking the setting changes and closing the window, playback will start.

**The factory preset is Region Code 1.**

**Region Code can be set up to 5 times. However, the factory preset is counted as the first time, so Region Code can be reset 4 more times at most.**

### Note:

- **Be aware that when the Region Code has been reset for the fourth time, the setting is fixed and cannot be changed.**

Users take responsibility for any problems caused by resetting the Region Code improperly.

# Installing Writing Software

## ■ B's Recorder GOLD5 BASIC / B's CLiP5

BHA B's Recorder GOLD5 BASIC and B's CLiP5 are included on the CD-ROM supplied with this drive. Install them from the CD-ROM. For installation and handling, refer to B's Recorder GOLD5 BASIC and B's CLiP5 PDF manuals included on the CD-ROM supplied with this drive. Using this drive, data cannot be written to or erased from DVD media.

### ● Writing Software (B's Recorder GOLD5 BASIC)

This multi-function writing software allows you to create your own data CDs and DVDs, and Audio CDs.

### ● Packet Writing Software (B's CLiP5)

This writing software allows you to write the files to CD-RW just like writing to floppy disk.

#### Cautions:

- If an earlier version of the same application or another company's software program that is equivalent to the supplied one is already installed in the computer, uninstall them before installing the application supplied with this drive. Co-existence of B's CLiP5 with other companies' packet writing software or UDF reader in the same computer environment may cause problems.
- Install the writing software after USB Driver and UDF Reader installation are complete (p.24, 27).
- For Windows XP, disable Windows XP standard writing function when using B's CLiP5.

#### Note:

- For Windows 2000 / XP, log in as a member of the users of Administrator group when installing.

# Installing Writing Software

## Installing B's Recorder GOLD5 BASIC / B's CLiP5

### 1 Insert the supplied CD-ROM.

(The program starts automatically and the screen shown below appears.)

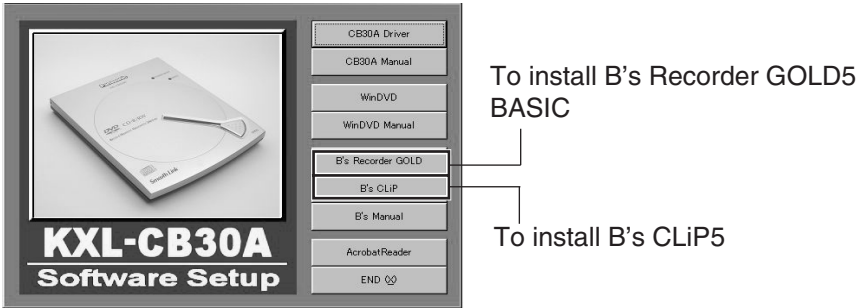

#### Note:

- If the program does not start automatically, open My Computer, double-click CD-ROM icon, then double-click [Asmenu.exe ] to start Setup Menu.

### 2 Click [B's Recorder GOLD] or [B's CLiP].

(The selected software Installer starts. Follow the on-screen instructions to proceed.)

#### Note:

- When B's Recorder GOLD5 BASIC and B's CLiP5 are installed successively, it is not necessary to restart the computer before installing the second program. Restart the computer after installation of both programs is complete.

### 3 After installation is complete, click [END] and then restart the computer.

(Now you can use writing software.)

# Installing Writing Software

## Using B's Recorder GOLD5 BASIC / B's CLiP5

### ■ B's Recorder GOLD5 BASIC

To start B's Recorder GOLD5 BASIC, from the Start Menu, select [All Programs] → [B.H.A] → [B's Recorder GOLD5] → [B's Recorder GOLD5].

### ■ B's CLiP5

B's CLiP5 stays resident automatically after Windows startup.

When an unused disc (media) or a disc formatted with B's CLiP5 is inserted into the drive, B's CLiP5 starts automatically.

#### Caution:

- For Windows XP, disable Windows XP standard writing function. (From Task Bar, click [start] → [My Computer], right-click DVD/CD-RW Drive, click [Properties] → [Recording], then uncheck [Enable CD recording on this drive].)

#### Note:

- Refer to B's Recorder GOLD5 BASIC / B's CLiP5 PDF manuals included on the CD-ROM supplied with this drive for usage of these writing software programs. To read the manuals, click [B's Manual], then select the manual you require. It is necessary to install Adobe Acrobat Reader (Version 4.0 or later) to read PDF manuals. If not installed on your computer, click [Acrobat Reader] to install the application from the supplied CD-ROM.

### ■ B's Recorder GOLD5 BASIC / B's CLiP5

For further information, access the URL on p.74.

# How to Make the CB30A Driver Installation Floppy Disk

## USB Driver (included on the supplied CD-ROM)

It is necessary to install USB device driver first when your computer is used Windows 98SE.

This USB Driver is designed for your drive to be installed on windows 98SE only. Install this USB Driver from supplied CD-ROM or a floppy disk which you may create yourself as follows.

### Note:

- It is not necessary to install the USB Driver unless you use Windows 98SE. When you make the installation floppy disk, a formatted floppy disk, floppy disk drive and another CD-ROM drive are required.

- 1** Insert the floppy disk into floppy disk drive.
- 2** Insert the supplied CD-ROM into CD-ROM drive.  
The program starts automatically and Setup Menu appears. If the program does not start automatically, go to 4.
- 3** Click [END] to close Setup Menu.
- 4** From the Start menu, select [Programs] → [Windows Explorer].
- 5** Click the Folder of Explorer [CB30\_SOFT] → [CB30Driver].

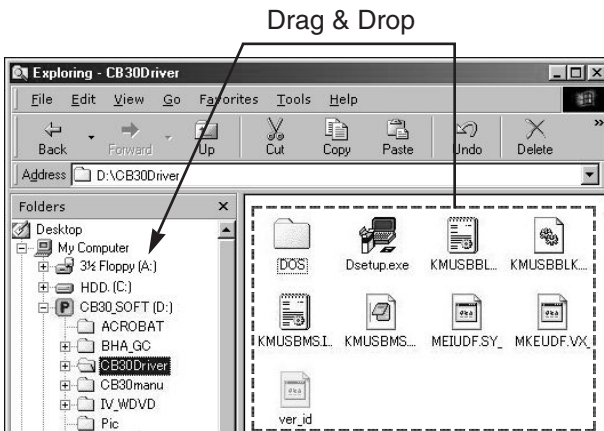

- 6** Select all the files in a CB30 Driver Folder, then drag and drop onto the 3.5" floppy disk.
- 7** After copy is complete, remove the floppy disk and supplied CD-ROM.

# Maintenance

- When the outside of the drive is dirty:  
Wipe with a soft cloth.



- When the turntable is dirty:  
Wipe turntable (black part) with a cotton swab in a circular motion.

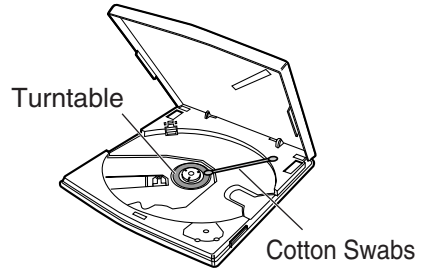

- Do not touch lens.

- When the disc is dirty:  
Wipe the disc using a soft lint-free cloth which has been dipped in water, and then wipe with a dry lint-free cloth.  
The disc must be wiped from the inside toward the outside.

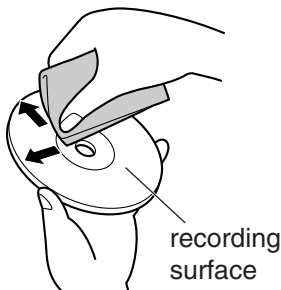

- When the lens is dirty:  
Clean the lens with a commercial lens blower.

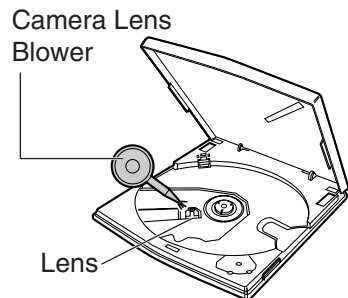

- Do not use cleaning disc. It may cause a failure.

## Notes:



- Do not use record cleaners, static protection sprays and chemicals such as benzene, thinner or alcohol. It may cause deformation or discoloration.
- Use LF-K200DCA1 for cleaning the DVD-RAM discs.

# Troubleshooting

If a problem occurs, check the following:

Trouble	Possible Cause & Solution	Pages
<b>1 Drive is not recognized by computer, or does not function properly.</b>	Check that the AC adaptor is connected correctly. <ul style="list-style-type: none"> <li>● AC adaptor auto protect function may be working. Disconnect AC adaptor and connect it again after few minutes.</li> </ul>	–
	Check that the computer is set up. <ul style="list-style-type: none"> <li>● Install USB Driver and UDF Reader.</li> <li>● If you use an interface card, use the latest driver.</li> </ul>	24, 27 23
	Check that the USB cable is connected correctly. <ul style="list-style-type: none"> <li>● Make sure USB cable is connected correctly.</li> </ul>	30
	Check that the USB cable was disconnected correctly. <ul style="list-style-type: none"> <li>● If you did not follow the procedure for connecting / disconnecting USB cable as explained in this manual, the drive icon may not be visible. Restart the computer.</li> </ul>	30–32
	Check whether or not interface cable pins are bent or broken. <ul style="list-style-type: none"> <li>● If they are bent or broken, contact a service center.</li> </ul>	back cover
	Check that the Power Switch is ON. <ul style="list-style-type: none"> <li>● If the Power Switch is OFF, turn it ON, then restart the computer.</li> </ul>	16

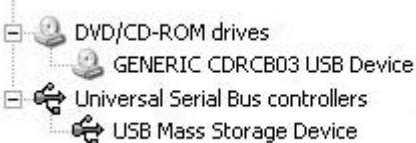
(Continued next page)

Trouble	Possible Cause & Solution	Pages
<p>1 Drive is not recognized by computer, or will not function properly.</p>	<p>Check that your Windows OS supports this drive.</p> <ul style="list-style-type: none"> <li>• The drive operates under Windows 98SE / Windows 2000 / Windows Me / Windows XP. (For Windows 98SE, the USB Driver is required.)</li> </ul>	21
	<p>Check that the driver is installed properly using Device Manager. (The expression may differ depending on Windows OS versions. Follow the equivalent prompts or instructions.)</p> <p><b>1 Click [start] → right-click [My Computer] → select [Properties].</b></p> <p><b>2 Select [Hardware] → [Device Manager] → [View] → [Device].</b></p> <p>After installation, connect the drive to the computer, then the window below appears.</p> <ul style="list-style-type: none"> <li>• Windows XP / Windows 2000 (OS standard driver)           <ul style="list-style-type: none"> <li>  </li> </ul> </li> <li>• Windows 98SE / Windows Me (Supplied driver)           <ul style="list-style-type: none"> <li>  </li> </ul> </li> <li>• Windows Me (OS standard driver)           <ul style="list-style-type: none"> <li>  </li> </ul> </li> </ul>	



Trouble	Possible Cause & Solution	Pages
<b>2 DVD-RAM is not recognized.</b>	Check that the disc is UDF formatted. <ul style="list-style-type: none"> <li>• Use discs formatted in UDF2.0 with a DVD video recorder, and formatted in UDF1.5 or UDF2.0 with a DVD-RAM drive.</li> </ul>	–
	Check whether or not a disc in UDF2.0 format is inserted. <ul style="list-style-type: none"> <li>• Set up the drive (Install “CB30A Driver”) to install UDF Reader.</li> </ul>	27
	Check whether or not the disc is dirty or scratched. <ul style="list-style-type: none"> <li>• Clean the disc.</li> </ul>	46
<b>3 Data cannot be read from DVD-R or DVD-RW.</b>	Check that the disc (media) and writing format are correct. <ul style="list-style-type: none"> <li>• DVD-R 4.7GB (For General and Authoring), DVD-R 3.95GB or DVD-RW 4.7GB Ver1.1 must be used with this drive.</li> <li>• For disc (media) writing formats compatible with this drive.</li> </ul>	12, 37, 62

# Troubleshooting

Trouble	Possible Cause & Solution	Pages
<p>4 <b>Disc cannot be removed. (Disc cover will not open.)</b></p>	<p>Check that the drive is not running.</p> <ul style="list-style-type: none"> <li>• The Disc Cover will not open by pressing the Open Button during a write operation. Wait until writing is complete.</li> <li>• When using B's CLiP5, right-click the indicator in Task Tray and select [Eject]. If the Disc Cover will not open by selecting [Eject], use Lock Release Lever.</li> </ul>	<p>35</p>
<p>5 <b>Drive or AC adaptor are hot.</b></p>	<p>This is normal. If they are excessively hot, disconnect the AC cord, then contact a service center.</p>	<p>back cover</p>
<p>6 <b>Cannot write properly.</b></p>	<p>Check that the disc (media) and writing formats are correct.</p> <ul style="list-style-type: none"> <li>• This drive does not support packet writing to CD-Rs (with B's CLiP 5). Use packet writing for CD-RWs.</li> <li>• For Windows XP, disable Windows XP standard writing function.</li> <li>• Refer to "FAQ" and manual for the writing software.</li> </ul>	<p>44 53</p>

Trouble	Possible Cause & Solution	Pages
<b>7 Audio skip occur. / Data cannot be read or written.</b>	Check that the disc is inserted with the label side facing upward. <ul style="list-style-type: none"> <li>● Insert the disc into the drive correctly.</li> </ul>	33
	Check that the disc and the drive lens are clean. <ul style="list-style-type: none"> <li>● Clean them referring to “Maintenance” .</li> </ul>	46
	Check whether or not there are scratches on the disc. <ul style="list-style-type: none"> <li>● Use another disc to check that the drive has no failures.</li> </ul>	-
	Check whether or not dirt is adhered on the turntable. <ul style="list-style-type: none"> <li>● Clean the turntable referring to “Maintenance” .</li> </ul>	46
	Check that the compatible disc is used. <ul style="list-style-type: none"> <li>● Check the disc is compatible with this drive.</li> <li>● Data on Copy Control CD (copy protected CD) cannot be written with this drive.</li> </ul>	12, 61

# Troubleshooting

Trouble	Possible Cause & Solution	Pages
<b>8</b> No sound from Audio CD or CD-ROM.	<p>When playing a CD with this drive using CD playback software incorporated in the computer, it is necessary to enable digital playback function. Check that the digital playback is enabled.</p> <ul style="list-style-type: none"><li>• If not, enable digital playback referring to the computer instruction manual.</li></ul>	—
	<p>Check whether or not the computer sound volume is muted or too low.</p> <ul style="list-style-type: none"><li>• Adjust computer sound volume.</li></ul>	—

For questions on this drive, read Troubleshooting on p.47-52 first.

## ■ Writing

**Q** Writing to disc appears to start normally, but fails. Why?

**A** SmoothLink may not be functioning. Check the SmoothLink function setting in writing software and the following:

- Disable suspend and resum functions.
- Close resident software and other programs.

If SmoothLink function is OFF, writing data to media may fail due to interruption during data transmission from the computer.

To avoid:

- Change writing speed (to a lower speed).  
Before actually writing to the media, execute "Simulate" using the writing software.  
Available working speed may change depending on the computer environment. Check the following:
- Perform hard disk maintenance. (Defragment hard disk after disk scanning.)
- Disable suspend and resume functions.
- Close resident software and other programs.
- Turn off screen saver.
- Turn off Active Desktop.
- Do not configure network connection.

**Q** Writing fails.  
Why?

**A** Check that media recommended for this drive is used, and the writing speed is appropriate to the media.

- Use discs (media) recommended for this drive (see p.61).
- Use High Speed CD-RW for 4-10X writing and Ultra Speed CD-RW for 8X writing or higher.

**Q** Why does data size change before and after writing?

**A** It is caused by a difference in sector size between the disc (media) and the hard disk. When data is written to disc (media), the data size becomes slightly bigger than that of the data stored on a hard disk.

Depending on the writing mode, the information area is also used.

**Q** How can I make my best selection Audio CD?

**A** Extract the data you want from each Audio CD and write it to the hard disk as wav files (\* .wav), using the supplied writing software. For details, refer to the PDF manual for the supplied writing software.

**Q** Is it possible to use several drives or writing software programs for additional writing?

**A** Use the same drive and the same software for additional writing. If you do not, previously written data may not be readable. A disc written on more than one drive may not be read or written correctly.

**Q** Can data be written while several writing software programs are installed?

**A** It is possible that data will not be written correctly in the following situations:

- Several writing software programs are running simultaneously. (Including resident writing software.)
- More than one version of the same writing software is installed.

**Q** Is it necessary to change the BIOS setting on computer?

**A** Some computers require switching between USB 1.1 and USB 2.0 by changing BIOS settings. Set to USB 2.0 referring to computer instruction manual.

**Q** Is it possible to write Audio data (CD-DA) On The Fly from computer's internal drive?

**A** Some internal CD-ROM drives may not perform high-speed reading.

- Use this drive to write the data to the computer hard disk. For details, refer to PDF manual included on the CD-ROM supplied with this drive.
- Perform hard disk maintenance. (Defragment hard disk after disk scanning.)
- Make sure the writing software's SmoothLink function is ON. (The default is ON.)

## ■ Reading

**Q** Drive cannot perform reading at maximum speed. Why ?

**A** Check that the computer is set to USB2.0. Also check that the driver is installed properly using Device Manager. (The expression may differ according to OS versions. Follow the equivalent instruction.)

- 1 Click [start] → right-click [My Computer] → select [Properties]
- 2 Select [Hardware] → [Device Manager] → [View] → [Device by connection]

After installation, connect the drive to the computer, then the window below appears.

### USB2.0 (Example : Windows XP)

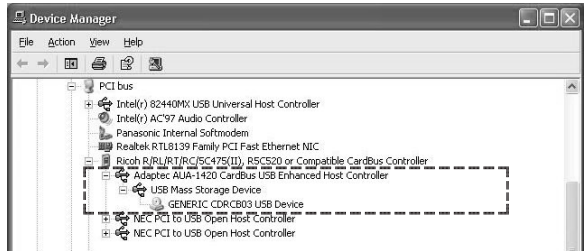

This drive is normally connected to the card manufacturer's controller when using interface card.

### USB1.1 (Example : Windows XP)

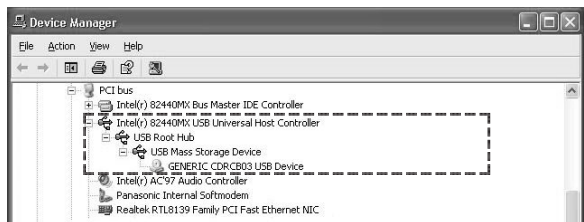

This drive is normally connected to the computer's controller.



**Q** Drive cannot perform reading at maximum speed. Why ?

**A** The drive may not perform reading at maximum speed depending on the discs.

- Discs that do not conform may not be read at maximum speed.

**Q** Can disc (media) written with this drive be read using other drives?

**A** • **CD-R/-RW**

Use a multi-read drive. Some CD-ROM drives may not read discs written with this drive.

**Q** Can a disc written with another drive be read using this drive?

**A** Normally the disc can be read.

However, a disc written with several different drives may not be read. Media written with certain drives may also not be read.

**Q** How can I write Audio data (CD-DA) to computer hard disk?

**A** Use the supplied writing software. Data cannot be written to the hard disk with Drag & Drop operation.

**A** Data on Copy Control CD (copy protected CD) cannot be written to the hard disk using this drive.

## ■ Others

**Q** This drive cannot be recognized by writing software except for the supplied writing software. Why?

**A** You cannot use the writing software that is not compatible with this drive.

**Q** Can this drive be placed in a vertical position ?

**A** Performance in a vertical position is not guaranteed and it may cause failures. Use this drive in a horizontal position.

## ■ Playback DVD-Video

**Q** DVD-Video cannot be played back.

**A** Refer to the DVD-Video playback software manual or on-line help, and check the following:

- When several drives are connected to the computer, this drive may not be selected.
- DVD-Video cannot be played back unless Region Codes of the DVD-Video, this drive and the DVD-Video playback software are consistent with each other. Check the Region Codes.

**A** DVD-Video may not be played back automatically depending on the DVD recording format.

Follow the instructions below:

- Start WinDVD 4, then insert the disc into the drive.
- Select the file from the WinDVD 4 playback menu to play back.

**Q DVD-Video sounds and images cannot be played back smoothly. Why?**

**A**

- Whether or not DVD-Video is played back smoothly depends on the computer system performance.  
Refer to the DVD-Video playback software manual and on-line help, and check the following:
- For USB 1.1 interface, images and sounds may be interrupted. Use USB2.0.
- Close other applications. When many applications are running, CPU performance may be inadequate.
- Change the settings for display area and color. CPU performance will be used more effectively by reducing area and color.
- Check the CPU speed setting.  
The power management may be set to power save mode.
- Check that the sound setting is not set to mute.

# Recommendations

The following recommendations are available through your local retailer.

## ■ Recommended Discs

Disc	Manufacturer
CD-R	Taiyo Yuden Co., Ltd. / RICOH Co., Ltd. / Mitsubishi Kagaku Media Co., Ltd. / Hitachi Maxell, Ltd.
CD-RW	RICOH Co., Ltd. / Mitsubishi Kagaku Media Co., Ltd.
High Speed CD-RW	RICOH Co., Ltd. / Mitsubishi Kagaku Media Co., Ltd.
Ultra Speed CD-RW	Mitsubishi Kagaku Media Co., Ltd.

## ■ USB2.0 Interface Cards (performance verified)

Manufacturer	Model No.	
	For PCI board	For PCMCIA card
RATOC	REX-PCIU2	REX-CBU2
ADAPTEC	AUA-2000LP	AUA-1420
MELCO	IFC-USB2P	IFC-USB2CB
I · O DATA	USB2-PCI2	CBUSB2

# Specifications

<b>Ambient temperature</b>	During operation : 41 - 95 °F (5 - 35 °C) For storage : -4 - 131°F (-20 - 55°C)
<b>Humidity range</b>	During operation : 20 - 85% RH (non condensing) For storage : 15 - 85 % RH (non condensing)
<b>Dimensions (W x D x H)</b>	5.12" x 6.18" x 0.73" (130 x 157 x 18.5 mm)
<b>Mass (Weight)</b>	Approx. 0.66 lb. (300 g)
<b>Power source</b>	AC adaptor KX-WZ712 (supplied) 100 – 240 V AC, 50/60 Hz
<b>Power consumption (with AC 120V)</b>	During data transfer : Approx. 10 W while AC adaptor is connected to outlet : Approx. 1 W
<b>Compatible interface</b>	USB2.0 and USB 1.1
<b>Supplied USB cable</b>	Cable length (including connector): Approx. 39.37" (1m) Mass (Weight) : Approx. 0.08 lb. (35 g)
<b>Buffer size</b>	2MB
<b>Compatible format</b>	CD-DA (Audio CD), CD TEXT, CD-EXTRA, CD-ROM (Mode 1, Mode 2 Form 1), CD-ROM XA (Mode 2 Form 2), Photo CD <sup>1</sup> (compatible with Multisession), Video CD
<b>Compatible disc<sup>2</sup></b>	DVD-RAM (80 mm, 120 mm) <sup>3</sup> Single 4.7 GB, 2.6 GB, 1.4 GB Dual 9.4 GB, 5.2 GB, 2.8 GB
	DVD-R (for General, Ver 2.0) 4.7 GB (120 mm) DVD-RW (Ver 1.1) 4.7 GB (120 mm)
	DVD-ROM, DVD-Video, DVD-R (for Authoring) <sup>4</sup> (80 mm, 120 mm)
	CD-R (74 minutes / 80 minutes), CD-RW, High Speed CD-RW, Ultra Speed CD-RW (74 minutes / 80 minutes) (120 mm)

<sup>1</sup> When using a Photo CD, playback software program is required.

<sup>2</sup> Disc capacities are for unformatted discs.

Both sides of "double sided" discs cannot be recorded or played back simultaneously.

<sup>3</sup> Use only non-cartridge type discs, and TYPE 2 and TYPE 4 discs removed from cartridges.  
Writing to DVD-RAM/-R /-RW is not supported.

<sup>4</sup> Compatible with 3.95 GB / 4.7 GB DVD-R for Authoring written with Disc at Once.

<b>Region Code Setting</b>	Factory preset	1
	Max. number of times setting can be changed	4
<b>Seek time</b> (as measured by Panasonic software)	DVD-ROM	180 ms
	CD-ROM	130 ms
<b>Continuous data transfer speed<sup>5</sup></b> (using USB 2.0) 1X transfer rate DVD media : 1385 kB/s CD media : 150 KB/s	DVD-RAM	x 1 (reading) (2.6 GB) x 2 (reading) (4.7 GB)
	DVD-ROM (Single)	Max. x 8 (reading)
	DVD-ROM (Dual)	Max. x 6 (reading)
	DVD-R /-RW DVD-Video	Max. x 4 (reading)
	CD-R	Max. x 24, Max. x 16 / 8 / 4 (writing)
	CD-RW	Max. x 16 / 10 / 8 / 4 (writing)
	CD-ROM /-R CD-RW	Max. x 24 (reading)
	CD-DA	Max. x 20 (reading)

\* Specifications and design are subject to change without notice because of product improvement.

<b>Computers<sup>6</sup></b>	IBM PC / AT compatible computer
<b>Windows OSs<sup>7,8</sup></b>	Windows XP Windows Me Windows 2000 Windows 98SE
<b>CPU<sup>7</sup></b>	<b>When using visual application :</b> Pentium® II 400 MHz or higher <b>When using data application :</b> Pentium® II 300 MHz or higher
<b>Memory<sup>7</sup></b>	<b>When using visual application :</b> 64 MB or more <b>When using data application :</b> 64 MB or more (128 MB or more)
<b>Hard disk space<sup>7</sup></b>	100 MB or more (800 MB or more recommended)

<sup>5</sup> Data transfer speed depends on computer performance and may be lower than speeds given.

<sup>6</sup> Only models with USB port.

<sup>7</sup> Computer environment required depends on application software. Check the software manufacturers' support information beforehand.

<sup>8</sup> Windows 2000 / Windows XP server OSs do not support this drive.

# End-user License Agreement

THIS IS A LEGAL AGREEMENT BETWEEN YOU AND PANASONIC. CAREFULLY READ ALL THE TERMS AND CONDITIONS OF THIS AGREEMENT PRIOR TO OPENING THE SOFTWARE PROGRAM PACKET. OPENING THE PACKET INDICATES YOUR ACCEPTANCE OF THESE TERMS AND CONDITIONS. If you do not agree to these terms and conditions, return the unopened packet and the other components of the Panasonic product to the place of purchase and your money will be refunded. No refunds will be given for product that have an opened packet or missing components.

## 1. COPYRIGHT:

Panasonic has the right to license or has been granted to license the enclosed software program ("SOFTWARE"), developed and copyrighted by Panasonic Communications Co., Ltd. or its licensor ("Licensor"). You acknowledge that you are receiving only a LIMITED LICENSE TO USE the SOFTWARE and related documentation, and that you shall obtain no title, ownership nor any other rights in or to the SOFTWARE and related documentation, all of which title and rights shall remain with Licensor and Panasonic.

## 2. LICENSE:

(1) You have the non-exclusive right to use the one copy of the SOFTWARE on a single computer used by single user. Installation of the SOFTWARE on a network server for the purpose of distribution to one or more other computers shall not be granted in this Agreement. (2) You may not copy, reproduce, or permit to be copied or reproduced, the SOFTWARE or related documentation for any purpose, except that you may either (a) make a reasonable quantity of copies of the SOFTWARE solely for backup or archival purposes, or (b) transfer the SOFTWARE to a single hard disk, provided that you keep the original solely for backup or archival purposes. All other copies of the SOFTWARE are in violation of this Agreement. (3) You may not rent or lease the SOFTWARE, but you may transfer your right under this License Agreement on a permanent basis, provided that you transfer this Agreement, all copies of the SOFTWARE, all related documentation and your Panasonic product, and the recipient thereof agrees the terms of this Agreement. (4) You may not reverse engineer, decompile or disassemble the SOFTWARE, except that in European Union and European Free Trade Association, you may have the limited right to reverse engineer, decompile or disassemble the SOFTWARE solely to the extent specifically permitted by the terms and conditions of Article 6 of the European Community's Directive for the Legal Protection of Computer Programs, OJL 122/42 (17 May 1991). (5) You may not use, copy, modify, alter, or transfer the SOFTWARE, or any copy thereof, in whole or in part, except as expressly provided in this Agreement.



# End-user License Agreement

## **3. TERM:**

This license is effective until terminated. You may terminate this Agreement at any time by destroying the SOFTWARE and related documentation and all copies thereof. This license will also terminate if you fail to comply with any term or condition of this Agreement. Upon such termination, you agree to destroy all copies of the SOFTWARE and related documentation.



## **4. LIMITED WARRANTY:**

Within ninety (90) days of your receipt of the SOFTWARE, Panasonic warrants that the storage media on which the SOFTWARE are furnished is free from defect in materials and workmanship under normal use, and that it will repair or at its option replace any defective media at no charge to you, provided that such defective media is returned to Panasonic within such ninety (90) days period.

## **5. LIMITATION OF LIABILITY:**

EXCEPT AS STATED ABOVE, NEITHER PANASONIC, PANASONIC'S SUPPLIER MAKES OR PASSES ON TO YOU OR OTHER THIRD PARTY, ANY WARRANTY OR REPRESENTATION INCLUDING, BUT NOT LIMITED TO, THE IMPLIED WARRANTY OF MERCHANTABILITY AND FITNESS FOR A PARTICULAR PURPOSE. WITHOUT LIMITING THE GENERALITY OF THE FOREGOING, NEITHER PANASONIC NOR PANASONIC'S SUPPLIER WARRANTS THAT THE SOFTWARE WILL BE ERROR-FREE OR THAT IT WILL MEET YOUR REQUIREMENTS. NEITHER PANASONIC NOR PANASONIC'S SUPPLIER SHALL BE LIABLE FOR ANY DAMAGE SUFFERED BY YOU INCLUDING, BUT NOT LIMITED TO, CONSEQUENTIAL, INCIDENTAL SPECIAL OR PUNITIVE DAMAGES. THE ABOVE LIMITATIONS SHALL APPLY REGARDLESS OF THE FORM OF ACTION WHETHER IN CONTRACT, TORT (INCLUDING NEGLIGENCE), STRICT PRODUCT LIABILITY OR OTHERWISE, EVEN IF SUCH PARTY HAS BEEN ADVISED OF THE POSSIBILITY OF SUCH DAMAGES.

# Glossary

<b>BIOS</b>	Basic Input Output System. The BIOS is a fundamental part of the software that controls the floppy disk drive, hard disk drive, keyboard and other hardware. It is normally preinstalled.
<b>Buffer Under Run or Buffer Under Run Error</b>	Buffer Under Run occurs when drive's buffer memory becomes empty for an instant while writing to a disc. Writing becomes interrupted and writing error occurs.
<b>CD-EXTRA</b>	In addition to Audio data, CD-EXTRA also has CD-ROM data. Audio data is stored on the inner tracks and CD-ROM data on the outer tracks. It bears one of the following logos.  
<b>CD-R</b>	Compact Disc Recordable. Once data is written to it, the data cannot be erased or rewritten. Depending on the writing mode, it may be possible to write additional data in available disc space afterwards.
<b>CD-RW</b>	Compact Disc ReWritable. Data written to a CD-RW can be deleted, either in its entirety or for the last session. CD-RWs are rewritable.
<b>Disc at Once</b>	Records all the data selected onto a single disc at one time. Additional data can not be written to disc afterwards.
<b>DVD</b>	Digital Versatile Disc. A DVD is the same size as a CD, but has a data capacity 7 times larger than that of a CD-ROM.
<b>DVD-RAM</b>	DVD-RAM is one DVD standard. Removable disc that can be read or written repeatedly.
<b>DVD-Video</b>	DVD-Video is one DVD specification. DVDs used for movies and home videos have this specification. It is possible to have soundtrack and subtitles in other languages, or a function to allow switching between camera angles.

<b>DVD Video Recording standards</b>	DVD Video Recording standards is one DVD standard. It is one method for recording a video data to a DVD. Also called "VR standard" or "VR format".
<b>Encode or Encoding</b>	Conversion of moving image data into MPEG files that conform to DVD-Video standards. Encoding can be done by software running on a CPU or a dedicated IC.
<b>High Speed CD-RW</b>	4-10X writing speed-compatible CD-RW media. High Speed CD-RW-compatible drive is required for writing. It bears  logo.
<b>Hot Plug</b>	Enables peripheral device connection and disconnection with computer power ON.
<b>Installation</b>	Process of loading software programs such as device drivers into a computer.
<b>Multiborder</b>	DVD-R format with the equivalent functions to those of Multisession. Enables additional writing to a DVD-R.
<b>Multisession</b>	CD-ROM format. Enables writing of several sessions on one CD.
<b>On The Fly</b>	A method of reading data from source files directly, then writing it to a disc (media). Large image file is not required, therefore data transfer can be completed with minimum hard disk space.
<b>Packet writing</b>	A method of writing data on a CD in small increments.
<b>Photo CD</b>	A technology developed by Eastman Kodak Company. A large amount of image data (photos etc.) can be stored on a CD-ROM.
<b>Region Code</b>	DVD-Videos can only be played back in the region specified by their code. Codes are administered separately for each region. The Region Code for the U.S.A. is "1".
<b>SmoothLink</b>	A technology developed by Matsushita Electric Industrial Co., Ltd. to avoid buffer under run error.

# Glossary

<b>Track at Once</b>	Records one track on a disc at one time. Used for making CD-EXTRA.
<b>UDF format</b>	Universal Disk Format. A disc format used for packet writing and many DVDs (DVD-RAM, DVD-Video, DVD-ROM, DVD-R and DVD-RW).
<b>Ultra Speed CD-RW</b>	8-24X writing speed-compatible CD-RW media. Ultra Speed CD-RW-compatible drive is required for writing. It bears  logo.
<b>USB</b>	Universal Serial Bus. Industry standard for connection between computers and peripheral devices.
<b>USB2.0</b>	High-speed USB interface established by USB-IF (USB Implementers Forum) compatible with USB1.0 and 1.1. Maximum transfer speed is about 40 times faster than that of USB 1.1.

# Index

## A

AC adaptor ..... 8, 9, 10, 30  
AC cord..... 8, 9, 30  
Audio CD ..... 37

## B

BIOS ..... 55, 66  
B's CLiP5 ..... 19, 42, 74  
B's Recorder GOLD5 BASIC  
..... 19, 42, 74  
Buffer Under Run..... 3, 66

## C

CD ..... 12  
CD-DA..... 12  
CD-EXTRA ..... 12, 66  
CD-R ..... 12, 37, 66  
CD-ROM ..... 12, 37  
CD-ROM XA ..... 12  
CD-RW ..... 12, 37, 66  
Copy Control ..... 11, 51, 57

## D

DC Input Terminal ..... 17  
Disc..... 12, 33, 37  
Disc at Once ..... 62, 66  
Disc Cover ..... 16, 33  
DVD ..... 12, 66  
DVD-R ..... 12, 49  
DVD-RAM ..... 12, 13, 14, 36, 49, 66  
DVD-ROM ..... 12, 37  
DVD-RW ..... 12, 49  
DVD-Video..... 12, 37, 59, 66

## H

High Speed CD-RW ..... 61, 67

## I

Interface Card..... 61

## L

Lock Release Lever..... 17, 35

## M

Multiborder..... 67  
Multisession ..... 67

## O

Open Button ..... 16, 33, 34

## P

Packet writing (Packet Write)  
..... 19, 67  
Photo CD ..... 12, 67  
POWER/BUSY Indicator ... 16, 31, 34  
Power Switch..... 16

## R

Region Code..... 12, 40, 41, 67

## S

SmoothLink ..... 3, 67

## T

Technical Support Calls  
.....back cover  
Track at Once ..... 68

# Index

## U

- UDF Format ..... 68
- UDF Reader ..... 19, 26, 27
- Ultra Speed CD-RW ..... 12, 61, 68
- USB cable ..... 30, 31
- USB Connector ..... 17, 30
- USB Driver ..... 19, 24, 45
- USB1.1 ..... 22, 56
- USB2.0 ..... 23, 56, 68

## V

- Video CD ..... 12

## W

- WinDVD 4 ..... 19, 39, 40, 74
- WRITE Indicator ..... 16, 31, 34

# Limited Warranty

Panasonic Digital Document Company  
Unit of Matsushita Electric Corporation of America  
Two Panasonic Way  
Secaucus, NJ 07094

## LIMITED WARRANTY PANASONIC Drive

Panasonic Digital Document Company will either repair this product with new or comparable, reconditioned parts, or exchange this product with a new or comparable rebuilt, reconditioned or reclaimed unit free of charge in the U.S.A. In the event of a defect materials or workmanship as follows:

A. For twelve (12) months from the date of purchase, as established by the purchase receipt or other proof of purchase.

OR

B. For fifteen (15) months from the date of manufacture, as on the serial number label on the unit.

Whichever comes last.

### SERVICE

Carry-in or mail-in service can be obtained during the warranty period. For instructions on how to obtain service on this product, call the Panasonic Hotline at 1-800-PANASYS. Be sure that all shipping costs are prepaid and that the package is adequately insured before sending the unit to the Panasonic Repair Center. Return Shipping costs will be paid by Panasonic Digital Document Company Unit of Matsushita Electric Corporation of America.

This warranty is extended only to the original purchaser. A purchase receipt or other proof of date of original purchase will be required before warranty performance is rendered.

This warranty only covers failures due to defects in materials or workmanship which occur during normal use. It does not cover failures due to damage which occurs in shipment or failures which are caused by products (including software) not supplied by Panasonic Digital Document Company or failures which result from accident, misuse, abuse neglect, mishandling misapplication, alteration, faulty installation, modification or service by anyone other than a factory service center or damage that is attributable to lightening, line voltage variations, or acts of God.

There are no express warranties except as listed above.

INCIDENTAL OR CONSEQUENTIAL DAMAGES RESULTING FROM THE USE OF, OR INABILITY TO USE THIS PRODUCT, OR CONSEQUENTIAL DAMAGES RESULTING FROM USE OF THIS PRODUCT, OR ARISING OUT OF ANY BREACH OF THIS WARRANTY, INCLUDING WITHOUT LIMITATION. LOSS OF STORED DATA.

DURATION OF IMPLIED WARRANTIES, IF ANY, IS LIMITED TO 90 DAYS.

Some states do not allow the exclusion or limitation of incidental or consequential damages, or limitations on how long an implied warranty lasts, so the above exclusions or limitations may not apply to you.

This warranty gives you specific legal rights and you may also have other rights which vary from state to state.

If a problem with your Panasonic product develops during the warranty period, first contact your Panasonic dealer or Panasonic Digital Document Company listed on other side. If the problem is not handled to your satisfaction, then write to the Service Administration Manager, Panasonic Digital Document Company Unit of Matsushita Electric Corporation of America, Two Panasonic Way, Secaucus, NJ 07094.

Please  
Stamp Here

**PANASONIC DIGITAL DOCUMENT COMPANY**

Two Panasonic Way, Panazip: 7D-7  
Secaucus, N.J. 07094

-----  
Bending line

**SO THAT WE MAY HELP YOU**

Complete and immediately mail the Product Analysis Card. We ask that you complete the questionnaire for two reasons:

1. The US Center for Devices and Radiological Health requires that Panasonic keep a record of installation of all installed optical laser equipment that can be supplied to them upon demand.
2. This data will be used to build a data base of end user application information for analysis that will assist Panasonic in determining how better to provide customer support and for future product enhancements.

**IF YOU SHIP THE PRODUCT**

Carefully pack and send it prepaid, adequately insured and preferably in the original carton. Attach a letter, detailing the complaint, to the outside of the carton.

Do not send the product to the Executive or other Panasonic locations. They are NOT equipped to make repairs.

**Panasonic Digital Document Company  
Unit of Matsushita Electric Corporation of America**

Two Panasonic Way, 7D-7  
Secaucus, NJ 07094

Correspondence only—do not ship defective product to this address. Instead, to locate the closest authorized service to you, please call 1-800-PANASYS (726-2797).



# Panasonic DVD-ROM & CD-R/RW Drive Analysis Card

Model Number:

Serial Number:

Device Driver Software Version:

Date of Purchase:

Type of Organization: \_\_\_\_\_

(e.g. Government, Industrial, Commercial, Educational, Medical, etc.)

Drive Application: \_\_\_\_\_

(e.g. Desk top publishing, Graphics, Data Backup, etc.)

Is this the first Drive system purchased/installed?

Yes      No

If No: Please list model and manufacturer of previous installations: \_\_\_\_\_

What computer will this Drive be used with?

Type of computer: \_\_\_\_\_

(e.g. IBM PC/AT, etc.)

May we use your organization as a reference of being a Panasonic Drive installation to inquirers?

Yes      No

Comments: \_\_\_\_\_

\_\_\_\_\_

\_\_\_\_\_

Where did you purchase your Drive?

Dealer Name: \_\_\_\_\_

Address: \_\_\_\_\_

City: \_\_\_\_\_

State: \_\_\_\_\_ Zip: \_\_\_\_\_

Who is the main user?

Company Name: \_\_\_\_\_

Address: \_\_\_\_\_

City: \_\_\_\_\_

State: \_\_\_\_\_ Zip: \_\_\_\_\_

Telephone: \_\_\_\_\_

FAX: \_\_\_\_\_

Contact: \_\_\_\_\_

Thank you for your effort in filling out this questionnaire. If you should need assistance from Panasonic please call:

1-800-PANASYS (726-2797)

**Panasonic Digital Document Company  
Unit of Matsushita Electric Corporation of America**

Two Panasonic Way  
Secaucus, NJ 07094

# Product Information

**For the applications supplied with this drive, contact software manufacturer directly.**

## **WinDVD 4**

### **InterVideo, Inc.**

If you have any questions about WinDVD 4, contact directly the following support center.

E-mail Support : [support@intervideo.com](mailto:support@intervideo.com)

URL (Home Page) : <http://intervideo.com/>

## **B's Recorder GOLD5 BASIC / B's CLiP5**

### **B.H.A Corporation**

For any technical inquiries regarding B's Recorder GOLD5 BASIC/B's CLiP5, use the contacts given below.

Internet Support : <http://www.bhacorp.com/support/index.html>

URL (Home Page) : <http://www.bhacorp.com/>

This product is designed for use only in the country where it was purchased.

## Technical Support Calls

### FOR USERS IN UNITED STATES

If you have read this manual and tried the troubleshooting procedures and you are still having difficulty, please contact the dealer from which the unit was purchased.

You may also call the end user technical support telephone number which is operational during East Coast business hours (9:00 AM to 5:00 PM).

The end user technical support telephone number is 1-800-PANASYST.

This number is available within the U.S. only.

The serial number of this unit may be found on the label located at the bottom of the unit. Write down this number below and keep this book along with your proof of purchase to serve as a permanent record of your purchase or for future reference.

For warranty service you may be required to show your purchase records.

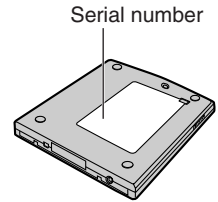

Model No.   **KXL-CB30AU**   Name of Dealer \_\_\_\_\_

Serial No. \_\_\_\_\_ Date of Purchase \_\_\_\_\_

---

**Panasonic Digital Document Company**  
**Unit of Matsushita Electric Corporation of America**  
Two Panasonic Way, Secaucus, New Jersey 07094

© 2003 Panasonic Communications Co., Ltd.

## Free Manuals Download Website

<http://myh66.com>

<http://usermanuals.us>

<http://www.somanuals.com>

<http://www.4manuals.cc>

<http://www.manual-lib.com>

<http://www.404manual.com>

<http://www.luxmanual.com>

<http://aubethermostatmanual.com>

Golf course search by state

<http://golfingnear.com>

Email search by domain

<http://emailbydomain.com>

Auto manuals search

<http://auto.somanuals.com>

TV manuals search

<http://tv.somanuals.com>