

Panasonic



DVD-RAM Drive Operating Instructions

Model No. **LF-D102U**



Before attempting to connect, operate or adjust this drive, please read these instructions completely.
Please save this manual.

Compatible operating system : Windows[®]95, Windows[®]98, Windows NT[®] 4.0



This manual was printed with soy based ink.

VQT8383

Dear Customers

May we take this opportunity to thank you for purchasing this Panasonic DVD-RAM drive. We strongly recommend that you carefully study the Operating Instructions before attempting to operate the drive and that you note the listed precautions.

Table of Contents

IMPORTANT SAFETY NOTICE	3
SAFETY LABEL	4
LASER PRODUCT	5
IMPORTANT SAFETY INSTRUCTIONS	6
DISK DISPOSAL	6
OPERATING PRECAUTIONS	7

Getting Started:

Kit Contents	8
Features	9
Parts and Functions	10

Operation:

Checks and Preparations Before	
Installation	11
• SCSI connecting	11
• Function switch settings	12
Connections	13
Checks and Preparations Before Use	14
• Installing driver software/format software	15
• Checks after installation	16
Using a DVD-RAM Disc	18
• Logical formatting	18
• Reading and writing a DVD-RAM disc	22
Using a PD Cartridge	23
• Logical formatting	23
• Reading and writing a PD cartridge	24
Using CD-ROM, DVD-ROM and Other CD/DVD	
Discs	25
• Playing a disc	25
About the Supplied Application Software	26
• Using MPEG1 Coder (MPEG1 compression software)	26
• Using FileSafe (backup software)	27
• Using MediaSafe (disc copying software)	28
• Using DVDRgn (region number setting utility)	29
• Using DVD Agent (utility)	30
• Installing the supplied application software	32
Uninstalling the Software	33
• Uninstalling driver software	33
• Uninstalling the supplied utility and application software	34

For Your Reference:

When Operation Indicator Lamp Blinks	35
Troubleshooting	36
Handling DVD-RAM Discs	37
Handling PD Cartridges	38
Handling CD-ROM, DVD-ROM and Other CD/DVD Discs	38
Specifications	39

TRADEMARKS, etc.

"Windows", "Windows NT" and "MS-DOS" are registered trademarks of Microsoft Corporation (U.S.) in the U.S. and other countries.

(The long title of "Windows" is "Microsoft® Windows® Operating System".)

All other trademarks are property of their respective owners.

Matsushita Electric Industrial Co., Ltd. herewith declares that it will not be liable in any way for any loss of data or any other damage, whether direct or indirect, caused by the operation or malfunctioning of this product. Make backups of important data in order to protect it from possible loss.

IMPORTANT SAFETY NOTICE

• RADIO FREQUENCY INTERFERENCE STATEMENT

Class B Digital Device/Information Technology Equipment

Note:

This equipment has been tested and found to comply with the limits for a Class B digital device, pursuant to Part 15 of the FCC Rules.

These limits are designed to provide reasonable protection against harmful interference in a residential installation. This equipment generates, uses, and can radiate radio frequency energy and, if not installed and used in accordance with the instructions, may cause harmful interference to radio communications. However, there is no guarantee that interference will not occur in a particular installation. If this equipment does cause harmful interference to radio or television reception, which can be determined by turning the equipment off and on, the user is encouraged to try to correct the interference by one or more of the following measures:

- Reorient or relocate the receiving antenna.
- Increase the separation between the equipment and receiver.
- Connect the equipment into an outlet on a circuit different from that to which the receiver is connected.
- Consult the dealer or an experienced radio/TV technician for help.

FCC Warning:

To assure continued FCC emission limit compliance, use only the provided AC Adaptor, the proper power supply cord and the shielded interface cable when connecting this device to the computer.

Also, any unauthorized changes or modifications to this equipment would void the user's authority to operate this device.

This device complies with Part 15 of the FCC Rules.

Operation is subject to the following two conditions:

- (1) This device may not cause harmful interference, and
- (2) this device must accept any interference received, including interference that may cause undesired operation.

Responsible Party : Matsushita Electric Corporation of America

One Panasonic Way



Secaucus, NJ. 07094 USA

Telephone No.:1-800-PANASYS (1-800-726-2797)

SAFETY LABEL

The following label is used in this DVD-RAM drive to remind you of safety precautions (located on bottom of the DVD-RAM drive).

Please read it and follow the instruction.

Panasonic	
Model No. LF-D102U	
5V---1.4A , 12V---0.7A 	
Matsushita Electric Industrial Co.,Ltd. Kadoma,Osaka, Japan Made in Japan	
Manufactured	
Serial No.	
THIS PRODUCT COMPLIES WITH DHHS RULES 21 CFR CHAPTER I, SUBCHAPTER J. 130K0J	
 TESTED TO COMPLY WITH FCC STANDARDS FOR HOME OR OFFICE USE	 UL1950 8B22 LISTED E140407
VGH4370	

LASER PRODUCT

Class I LASER Product

- This DVD-RAM drive is certified to comply with DHHS Rule 21 CFR Chapter I, Subchapter J in effect as of date of manufacture

This DVD-RAM drive is classified as a Class I LASER product and there is no hazardous LASER radiation with the safety protection

Caution

Use of controls or adjustments or performance of procedures other than those specified herein may result in hazardous radiation exposure

- When the power switch is on, do not place your eyes close to the front panel opening door and other openings to look into the inside of the DVD-RAM drive

LASER Specification

Class I LASER Product

Wave Length 635–675 nm/640–666 nm, 775–815 nm

Laser Power No hazardous radiation is emitted with the safety protection

Included with this booklet is a questionnaire which requests important information required by the U S Center for Devices and Radiological Health

It should be filled out by the end-user/purchaser of this equipment—not the reseller

If you are the end-user and this questionnaire card is missing, please call Panasonic at 1-800-PANASYS and another will be promptly mailed to you

Please also call 1-800-PANASYS (1-800-726-2797) if you require technical support This technical support hotline is available 9 a m to 7 p m EST, normal business days

IMPORTANT SAFETY INSTRUCTIONS

- Do not disassemble or modify the DVD-RAM drive or the AC adaptor.
- Do not place liquids and metallic objects on or near the DVD-RAM drive.
- Do not exceed the limits of the household AC outlet or AC power supply cords. Connect only to a power supply of 100 –120 V.
- Do not damage the AC adaptor, AC power supply cord, and AC power plug.
- Fully insert the AC power plug.
- Regularly remove dust from the AC power plug.
- Do not handle the plug with wet hands.
- Do not handle the plug, AC adaptor, or main DVD-RAM drive during an electrical storm.
- Do not spray the DVD-RAM drive with water or allow it to get wet.
- Do not insert metal or inflammable objects inside the DVD-RAM drive.
- If a liquid or foreign object has found its way inside, turn off the power and disconnect the power plug.
- If the DVD-RAM drive has been dropped or otherwise damaged, turn off the power and disconnect the power plug.
- If smoke, odors, or noises are emitted from the DVD-RAM drive, turn it off and disconnect the AC power supply cord.
- When the AC power supply cord has been damaged (when its conductors are exposed, etc.), stop using the DVD-RAM drive and disconnect the power plug.
- Do not place the DVD-RAM drive where it will be exposed to direct sunlight or where the temperature will become abnormally high.
- Do not use cracked or warped discs.
- Do not place the DVD-RAM drive where it is extremely dusty or where the level of moisture from a humidifier, etc. is high.
- Do not force the tray open! Do not insert your fingers! Do not look inside the DVD-RAM drive!
- Do not use an AC adaptor other than the one supplied. (Using another AC adaptor can cause a fire.)
- Do not move the DVD-RAM drive while a disc is rotating. (Doing so may damage the disc.)
- Place the DVD-RAM drive on a flat surface, protected from vibration and shock.
- Do not place heavy objects on the DVD-RAM drive. Do not block the DVD-RAM drive's ventilation.

DISK DISPOSAL

Caution:

This Optical Disk contains tellurium which may be considered hazardous.
Check and follow your local regulations before Disposal.

OPERATING PRECAUTIONS

Handling

When operating the DVD-RAM drive

- Do not install on a shelf or other high place.
- Do not touch the DVD-RAM drive or its cable connector area. (Doing so may cause it to malfunction.)
- The DVD-RAM drive can be installed horizontally or vertically.
- Do not move the DVD-RAM drive during operation. (Doing so may damage the equipment.)
- Do not leave the tray out. (Doing so will allow dust to get inside the DVD-RAM drive and may damage it.)
- Only load DVD-RAM discs, PD cartridges, and designated 12 cm discs in the tray. (Loading other types of discs or other media may damage the drive.)
- Do not open or close the tray while pressing on the shutter (doing so may damage the DVD-RAM drive).
- Do not force the shutter open (doing so may damage the DVD-RAM drive).
- Do not bring magnets or magnetic objects near the DVD-RAM drive. (Operation may become unstable due to the effects of the magnetism.)
- Do not use the DVD-RAM drive when condensation has formed in or on it.
[When the DVD-RAM drive is suddenly taken from a cold place to a warm location, droplets of water(condensation) will form, causing the drive to malfunction. In such cases, remove the disc and leave the DVD-RAM drive standing for about an hour before proceeding with operation.]
- Do not expose the DVD-RAM drive to the sprays from volatile insecticides, etc. (Doing so may deform the external cabinet or cause the paint to peel off.)
- If the DVD-RAM drive is used near a radio or TV set and it causes interference with reception, place it at least 6'6 " (2 meters) away from the set or use a main outlet which does not share power with the set.

When moving or transporting the DVD-RAM drive

- Before moving the DVD-RAM drive, remove all media, turn off the DVD-RAM drive, and disconnect the AC power supply cord.
- Repackage the DVD-RAM drive in its packaging before shipping it.
- Ensure the DVD-RAM drive is not dropped or hit during shipment.

Maintenance

Maintaining the DVD-RAM drive's panel surfaces

- Turn the DVD-RAM drive off and unplug the AC power supply cord from the household AC outlet.
- Gently wipe off the dirt using a soft dry cloth.
- To remove stubborn dirt, soak the cloth in some diluted kitchen neutral detergent, wring it out well, and then wipe clean.
- Observe any applicable precautions when using chemical cleaning cloths.
- Do not use benzine, paint thinners or other solvents.

Maintaining the lens and discs

- Dust, dirt, etc. will adhere to the DVD-RAM drive's lens, DVD-RAM media, PD cartridges, CD-ROMs, CDs and DVD discs over a prolonged period of use, possibly making it impossible for data to be read and/or written properly. Although the exact period will differ according to the operating environment and number of times the DVD-RAM drive is used, Panasonic recommends that maintenance be performed using the cleaners available as optional accessories once every one to four months.

To maintain the DVD-RAM drive's lens

- Obtain the PD Lens Cleaner (model number: LF-K123LCA). Although this cleaner is for PD/CD-ROM drive, this can be used with this DVD-RAM drive, too.

To maintain the media

- Obtain the DVD-RAM/PD Disc Cleaner (model number: LF-K200DCA).

Kit Contents



Please check and identify the supplied accessories.

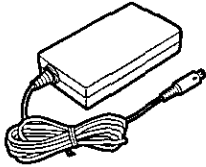

AC adaptor (VSK0558)

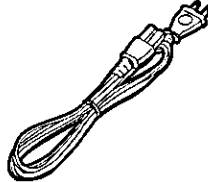

AC power supply cord



DVD-RAM disc



CD-ROM
(application and driver software)

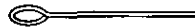

Emergency ejection pin

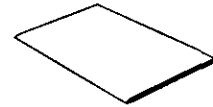

Operating Instructions
(this book)

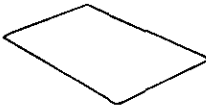

User Registration card

Note:

Please read this manual completely and obtain whatever additional components are required for the uses that you intend for this product.

Features

Extensive multimedia support

Thanks to the dual laser, dual lens optic head and high-performance, high-speed LSI processing technology, this DVD-RAM drive supports not only the playback of conventional CD-compliant media, but also the playback of DVD media, recording and playback of DVD-RAM media and even PD recording and playback.

Supported media		Recording	Playback
DVD format	DVD-RAM [supports 5.2 GB (double-sided), 2.6 GB (single-sided)]	✓	✓
	DVD-VIDEO		✓ *1
	DVD-ROM		✓
	DVD-R (supports playback of Disc-at-Once mode)		✓
PD format	PD	✓	✓
CD format	CD-ROM (supports XA)		✓
	CD-R/RW (supports MultiRead)		✓
	CD-DA		✓
	CD-EXTRA		✓
	Photo CD (supports Multisession)		✓
	Video CD		✓

*1 An MPEG2 decoder board (not included) or MPEG2 decoder software (not included) is also necessary to play DVD-VIDEO discs.

A full lineup of utilities included

MPEG1 Coder (MPEG1 compression software) (See page 26.)

This software allows you to compress, in real time, full-motion video shot with a video camera and other data into the MPEG1 format, and record it to a DVD-RAM disc or PD cartridge.

• A video for Windows-compatible video capture card and sound card are also required.

FileSafe (backup software) (See page 27.)

This software can automatically back up data in specified folders, or back up only updated folders to a DVD-RAM disc or PD cartridge, enabling you to protect important files efficiently.

Backed up files can be used directly in Explorer and various applications.

MediaSafe (disc copying software) (See page 28.)

This software lets you copy data recorded on a DVD-RAM disc or PD cartridge to a different DVD-RAM disc or PD cartridge using a single DVD-RAM drive.

DVDRgn (region number setting utility) (See page 29.)

This software is used to set the region number of the DVD-RAM drive (this setting can only be made a maximum of four times). The regions where DVD-ROM and DVD-VIDEO discs can be played are specified by region numbers. In order to play a disc, the region number on the DVD-RAM drive must match the region number on the disc. When this DVD-RAM drive is shipped from the factory, the region number is set to "1".

DVD Agent (utility) (See page 30.)

This software enhances the standard Windows GUI by replacing the default icons for removable drives and CD-ROM drives with customized DVD-RAM icons. Additionally, DVD Agent provides functionality to automatically launch applications upon insertion of a DVD-RAM disc or PD cartridge.

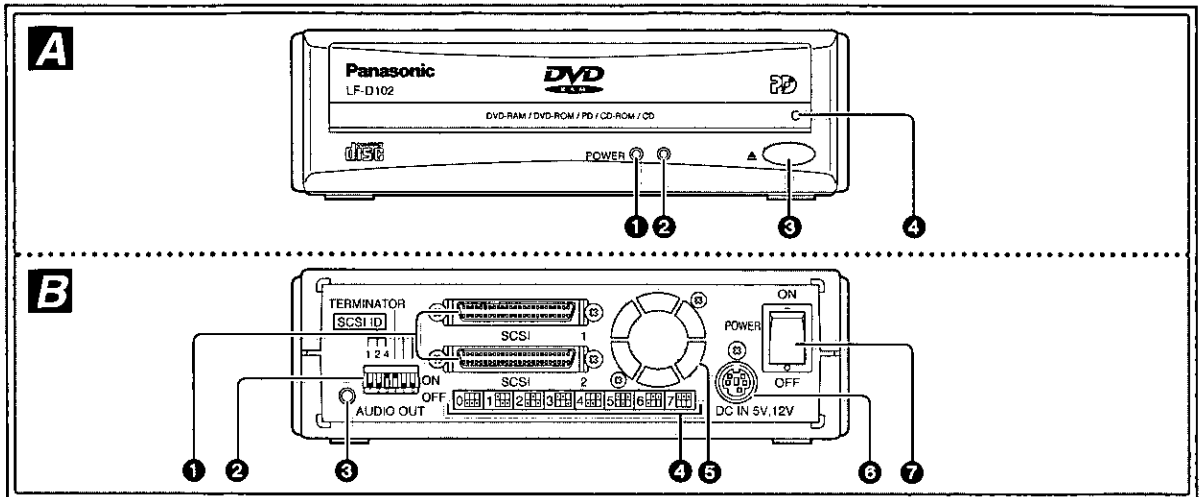

Parts and Functions

Front panel

1 Power indicator

Off: DVD-RAM drive is off
 Green: DVD-RAM drive is on

2 Operation indicator lamp

Off: No media inside
 Steady Green: Media inserted in DVD-RAM drive
 Steady Orange: Recording, playback or tray opening/closing
 Flashing Green: Error (See page 35.)

3 Open/close button

For opening and closing the tray.

4 Manual eject hole

Used to manually eject tray in the event that the tray does not eject normally using the open/close button or software commands.

Pulling out the tray

1. Power off the DVD-RAM drive.
2. Gently insert the emergency ejection pin (included) until shutter opens slightly.
3. Remove the emergency ejection pin.
4. Use your hand to open shutter.
5. Pull out the tray horizontally using your fingertips.

To close the tray after it has been manually pulled out, turn on the DVD-RAM drive's power and press the open/close button. (Depending on the position of the tray, it may automatically retract inside the DVD-RAM drive as soon as the power is turned on.)

Do not use this procedure under normal circumstances as it may result in the malfunctioning of the DVD-RAM drive.

Rear panel

1 SCSI connectors

Connect half-pitch 50-pin SCSI cables (not included).

2 Function switches

Used to change the settings for the terminator and SCSI ID (see page 12).

3 AUDIO OUT terminal

Connect an audio cable (not included).

4 SCSI ID labels

Refer to these when changing the settings with the function switches.

5 Cooling fan

Operates if the temperature in the DVD-RAM drive rises. It does not operate under normal conditions.

6 DC IN terminal

Connect the AC adaptor (included).

7 Power switch

Switch to turn the DVD-RAM drive on and off.

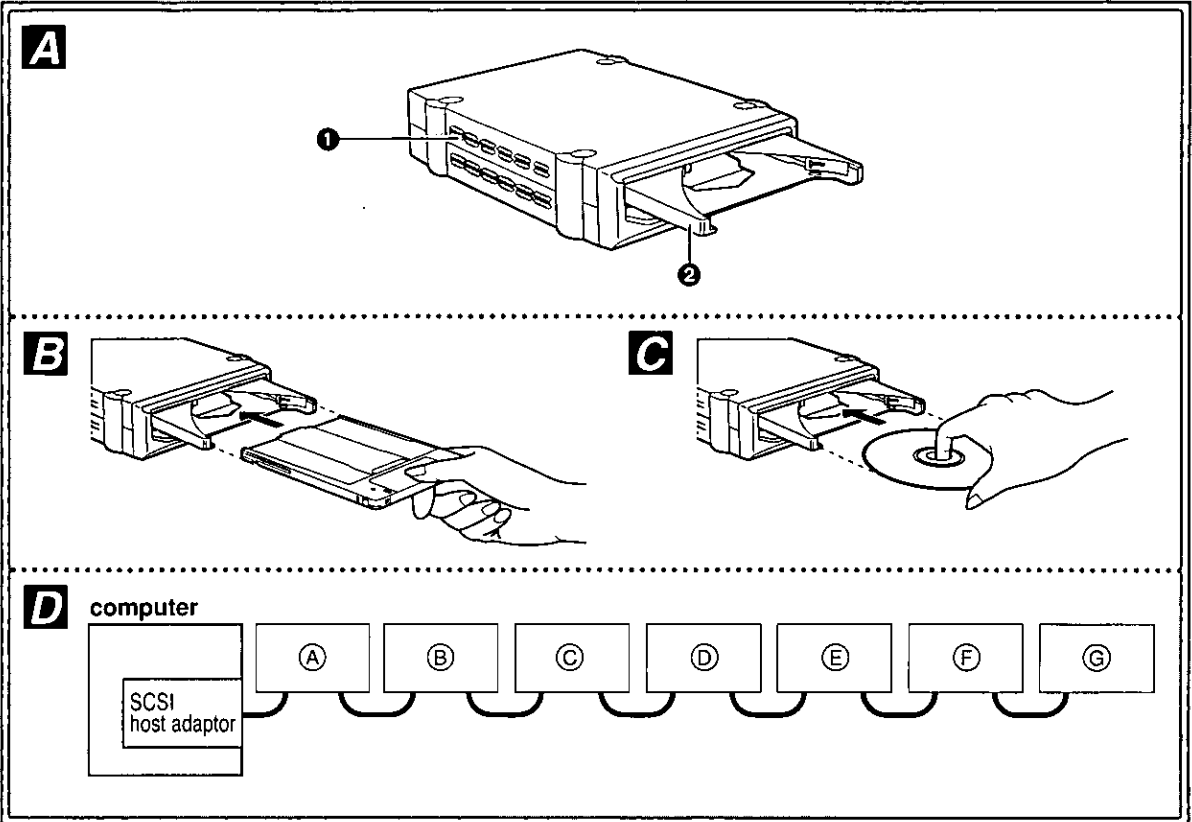

Side panels

1 Ventilation slots (on both sides of the DVD-RAM drive)

These slots allow ventilation to prevent the temperature in the DVD-RAM drive from rising. Ensure these slots are not blocked when installing the DVD-RAM drive to prevent malfunction of the DVD-RAM drive .

2 Tray

The tray is for inserting DVD-RAM discs, PD cartridges and 120 mm Disc Media.

※ **Insert the media with the printed title side facing up.**

- Insert the media in the tray, then push media into the DVD-RAM drive to load the tray. (You can also load the tray by pushing on it directly.)

Cartridge media 

120 mm Disc Media 

Checks and Preparations Before Installation

SCSI connecting

This DVD-RAM drive conforms to the SCSI-2 standard.

A SCSI host adaptor is therefore required to connect the DVD-RAM drive with a computer.

If a SCSI host adaptor is not already installed in your computer, you must purchase one separately.

Example

No more than 7 SCSI units (A – G) can be connected to a computer.

Also, the total length of the SCSI cable from the computer to the last DVD-RAM drive must be shorter than the length specified by the SCSI host adaptor to be used.

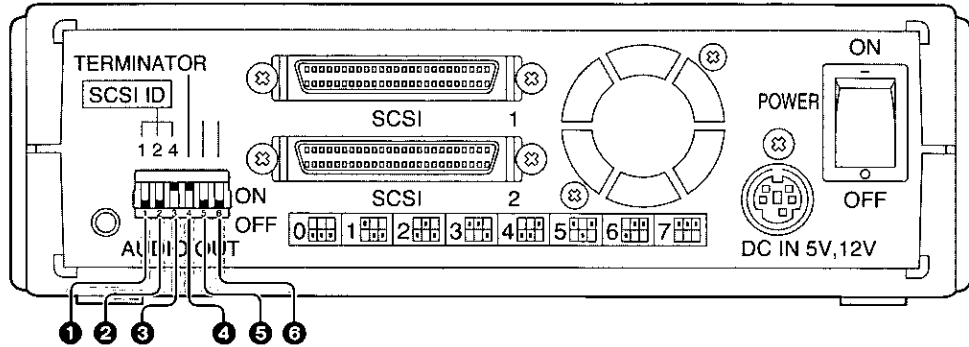
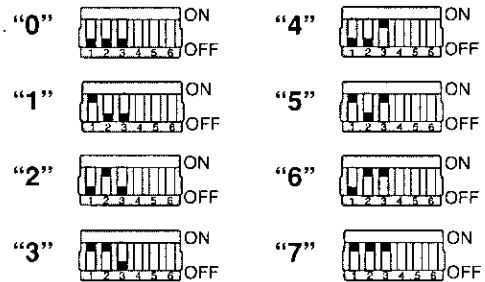
A**Rear panel of this DVD-RAM drive****B****C****Function switch settings**

- ① ② ③ SCSI ID setting
- ④ Terminator setting
- ⑤ ⑥ Factory default only (OFF)

B Terminator setting

(Factory Default: ON)

A terminator refers to a terminating resistance. The terminators must be set properly when SCSI units (including the DVD-RAM drive) have been connected to the computer.

- When the DVD-RAM drive is a terminating device (for example, illustration ③ on page 11)
Set to ON.
- When the DVD-RAM drive is not a terminating device (for example, illustration ④–⑥ on page 11)
Set to OFF.

C SCSI ID setting (Factory Default: 4)

SCSI IDs are a number identifying each SCSI unit. Consequently, SCSI IDs must be set so that no two units duplicate each other on the SCSI bus.

Note:

Generally, the SCSI IDs are set as follows:

- Hard disk drive: 0
- CD-ROM drive: 3
- SCSI host adaptor: 7

Check the SCSI ID (refer to devices instruction manual) for each device connected on the SCSI bus.

Set the DVD-RAM drive's ID so as not to duplicate any other device's ID.

Connections

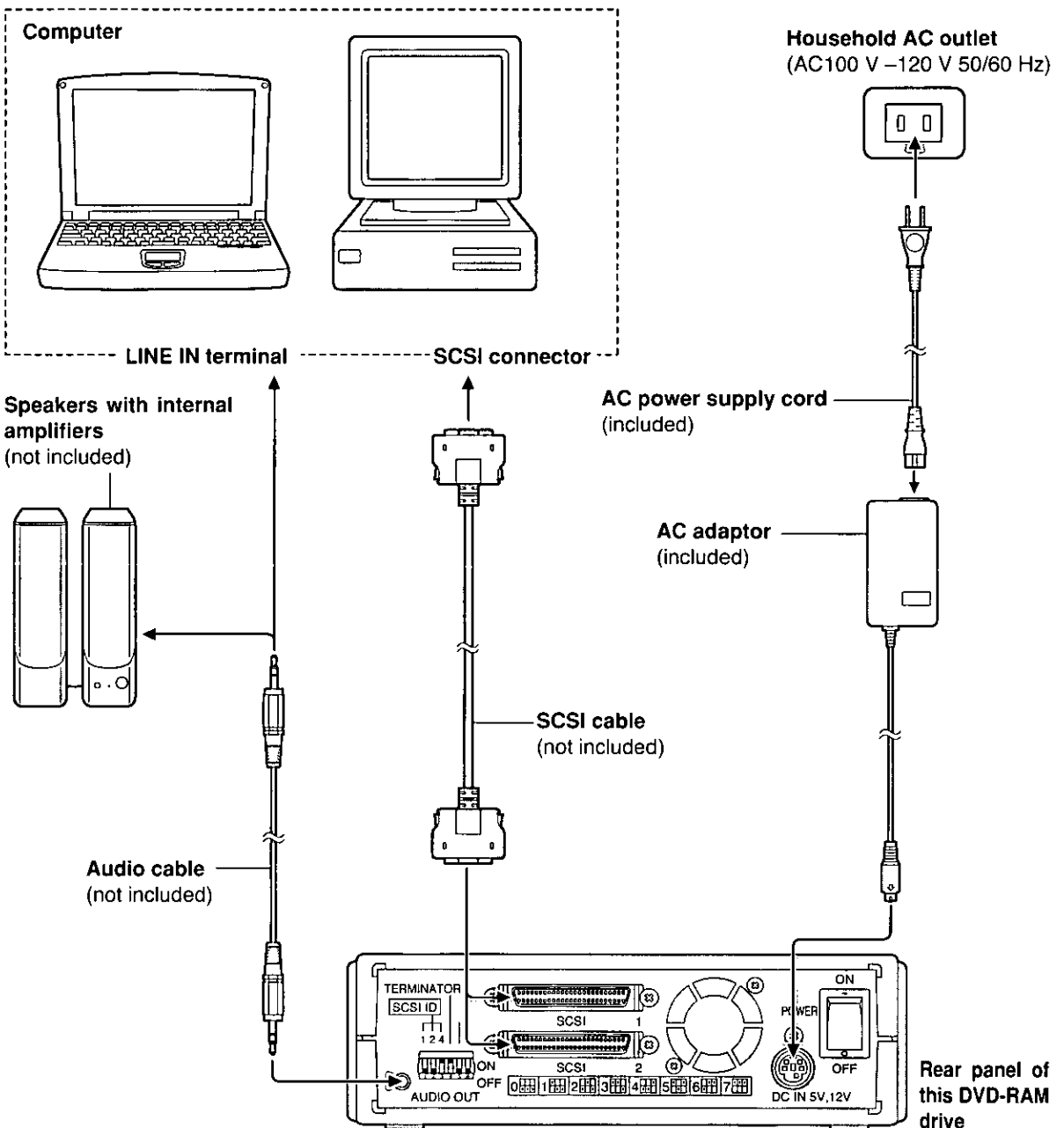

Note:

- When purchasing a sound board, review the product specifications thoroughly. Some sound boards have MPEG play functions. Verify that functions are not duplicated or missing. For details on the connections, refer to the respective instructions accompanying the products concerned.
- Turn off the power to all equipment before making any connections. Do not make any connections while power is supplied to any of the equipment.
- Connect the AC power supply cord only after all other connections have been completed.
- Carefully read the instructions of the other equipment.
- Use shielded SCSI cables.
- Insert the cables correctly and firmly.

Checks and Preparations Before Use

The following programs are supplied on CD-ROM with this DVD-RAM drive (be sure to install them on your computer). All of the software programs listed below are installed when you run the installation program.

■ Driver software

A program containing 2 device drivers that enable your computer to operate properly with the LF-D100 Series DVD-RAM drive.

1. LF-D100 series device driver A device driver that enables Windows to properly communicate with the LF-D100 hardware.
2. UDF file system driver A device driver that enables Windows to read from and write to a UDF-formatted DVD-RAM disc.

■ Format software (DVDForm)

A utility that provides functionality to format a DVD-RAM disc using the UDF format or FAT format and to format a PD cartridge using FAT format.

■ Region setting software (DVDRgn)

A utility that provides functionality to set the region number.

Before installing the above software programs, carefully read the Limited Use License Agreement shown below. This software can only be used if you agree to the terms of the Limited Use License Agreement. By installing this software, you are agreeing to the terms of the Limited Use License Agreement.

■ LIMITED USE LICENSE AGREEMENT

THE SOFTWARE PROGRAM(S) ("PROGRAMS") FURNISHED WITH THIS PANASONIC PRODUCT ("PRODUCT") ARE LICENSED ONLY TO THE END-USER ("YOU"), AND MAY BE USED BY YOU ONLY IN ACCORDANCE WITH THE LICENSE TERMS DESCRIBED BELOW. YOUR USE OF THE PROGRAMS SHALL BE CONCLUSIVELY DEEMED TO CONSTITUTE YOUR ACCEPTANCE OF THE TERMS OF THIS LICENSE.

Matsushita Electric Industrial Co., Ltd. ("MEI") has developed or otherwise obtained the Programs and hereby licenses their use to you. You assume sole responsibility for the selection of the Product (including the associated Programs) to achieve your intended results, and for the installation, use and results obtained therefrom.

LICENSE

- A. MEI hereby grants you a personal, non-transferable and non-exclusive right and license to use the Programs in accordance with the terms and conditions stated in this Agreement. You acknowledge that you are receiving only a LIMITED LICENSE TO USE the Programs and related documentation and that you shall obtain no title, ownership nor any other rights in or to the Programs and related documentation nor in or to the algorithms, concepts, designs and ideas represented by or incorporated in the Programs and related documentation, all of which title, ownership and rights shall remain with MEI.
- B. You may use the Programs only on the single Product which was accompanied by the Programs.
- C. You and your employees and agents are required to protect the confidentiality of the Programs. You may not distribute or otherwise make the Programs or related documentation available to any third party, by time-sharing or otherwise, without the prior written consent of MEI.
- D. You may not copy or reproduce, or permit to be copied or reproduced, the Programs or related documentation for any purpose, except that you may make one (1) copy of the Programs for backup purposes only in support of your use of the Programs on the single Product which was accompanied by the Programs. You shall not modify, or attempt to modify, the Programs.
- E. You may transfer the Programs and license them to another party only in connection with your transfer of the single Product which was accompanied by the Programs to such other party. At the time of such a transfer, you must also transfer all copies, whether in printed or machine readable form, of every Program, and the related documentation, to the same party or destroy any such copies not so transferred.
- F. You may not remove any copyright, trademark or other notice or product identification from the Programs and you must reproduce and include any such notice or product identification on any copy of any Program.

YOU MAY NOT REVERSE ASSEMBLE, REVERSE COMPILE, OR MECHANICALLY OR ELECTRONICALLY TRACE THE PROGRAMS, OR ANY COPY THEREOF, IN WHOLE OR IN PART.
YOU MAY NOT USE, COPY, MODIFY, ALTER, OR TRANSFER THE PROGRAMS OR ANY COPY THEREOF, IN WHOLE OR IN PART, EXCEPT AS EXPRESSLY PROVIDED IN THE LICENSE.
IF YOU TRANSFER POSSESSION OF ANY COPY OF ANY PROGRAM TO ANOTHER PARTY, EXCEPT AS PERMITTED IN PARAGRAPH E ABOVE, YOUR LICENSE IS AUTOMATICALLY TERMINATED.

TERM

This license is effective only for so long as you own or lease the Product, unless earlier terminated. You may terminate this license at any time by destroying, at your expense, the Programs and related documentation together with all copies thereof in any form. This license will also terminate effective immediately upon occurrence of the conditions therefor set forth elsewhere in this Agreement, or if you fail to comply with any term or condition contained herein. Upon any such termination, you agree to destroy, at your expense, the Programs and related documentation together with all copies thereof in any form.

YOU ACKNOWLEDGE THAT YOU HAVE READ THIS AGREEMENT, UNDERSTAND IT AND AGREE TO BE BOUND BY ITS TERMS AND CONDITIONS. YOU FURTHER AGREE THAT IT IS THE COMPLETE AND EXCLUSIVE STATEMENT OF THE AGREEMENT BETWEEN US, WHICH SUPERSEDES ANY PROPOSAL OR PRIOR AGREEMENT, ORAL OR WRITTEN, AND ANY OTHER COMMUNICATIONS BETWEEN US, RELATING TO THE SUBJECT MATTER OF THIS AGREEMENT.

Installing driver software / format software

1 Insert the supplied CD-ROM into the DVD-RAM drive.

The installation program starts automatically.

- If the installation program does not start automatically, start it manually by following the procedure below.

(This assumes that the drive letter assigned to the DVD-RAM drive for CD-ROM media is E:.)

1 From the Start menu select [Run].

2 In the "Open" box, enter "e:\setup.exe" and click [OK].

The installation program starts.

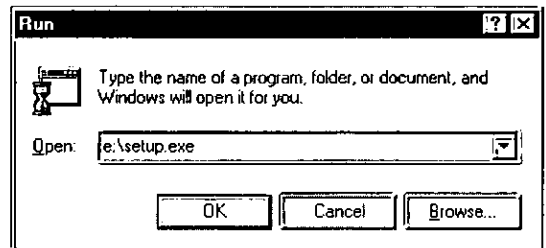

2 Click [Driver & Formatter Setup].

The installation begins.

- Follow the on-screen instructions to proceed.



3

When the dialog at right is displayed, select "Install DVD Driver" and click [Next].

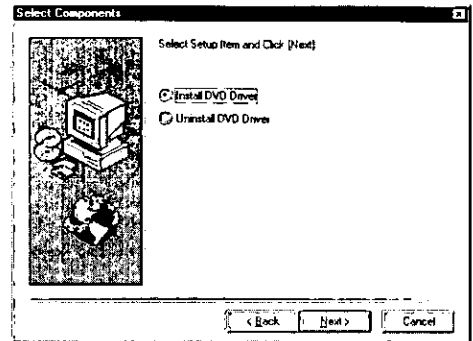

4

After the installation, select "Yes, I want to restart my computer now." and click [Finish].

The computer now reboots.

- You can use the DVD-RAM drive after rebooting.
- To verify that the drivers were installed correctly, refer to "Checks after installation" below (to page 17).

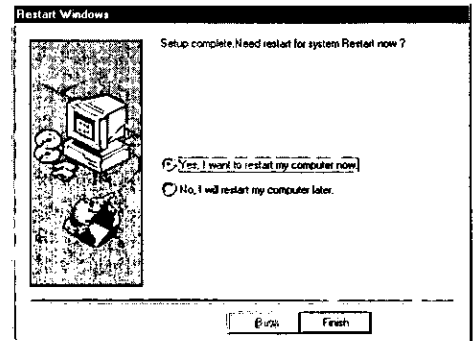

For your reference:

• About the DOS driver

The DOS driver is supplied on a CD-ROM installation disc.

You can use the DVD-RAM drive under MS-DOS® by installing this driver in your computer.

Please refer to [e:\DosDrv\English\readme.txt] of the CD-ROM.

(This assumes that the drive letter assigned to the DVD-RAM drive for CD-ROM media is E:.)

Checks after installation

Follow the steps described below (to page 17) to check that the DVD-RAM drive is recognized properly. If a problem occurs, refer to "Troubleshooting" on page 36.

Checking with [My Computer]

If this DVD-RAM drive was correctly connected and the driver programs were properly installed, icons for DVD-RAM disc/PD cartridge and CD-ROM/DVD-ROM will be added in [My Computer].

In the example below, removable disks (DVD-RAM disc/PD cartridge) have been assigned the drive name D:, and CD-ROMs (CD-ROM/DVD-ROM drive) have been assigned the drive name E:.

- If the correct icons do not appear, select [Refresh] from the View pull-down menu. If the correct icons fail to appear even after selecting [Refresh], check by following the procedure "Checking use [Device Manager]" on page 17, then refer to "Troubleshooting" on page 36.

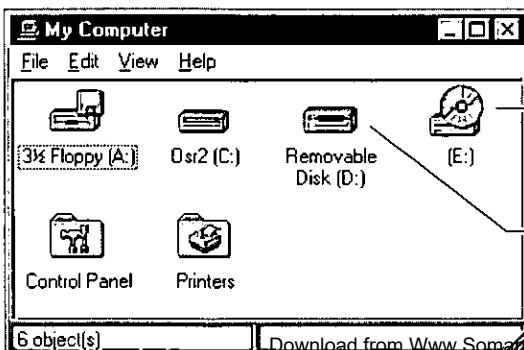

CD-ROM/DVD-ROM icon (example: E drive)

DVD-RAM disc/PD cartridge icon (example: D drive)

Checking use [Device Manager] (Windows 95/Windows 98 only)

1. From the Start menu, select [Settings], then [Control Panel].
2. Select [System], then click on [Device Manager] tab to bring up the window below which shows all devices connected.
3. Double-click "CD-ROM", "Disk drives" and "SCSI controllers" and verify whether items **a**, **b** and **c** appear.
 - If **a**, **b** or **c** fails to appear, or if a yellow [!] or red [x] appears over **a**, **b** or **c**, refer to "Troubleshooting" on page 36.

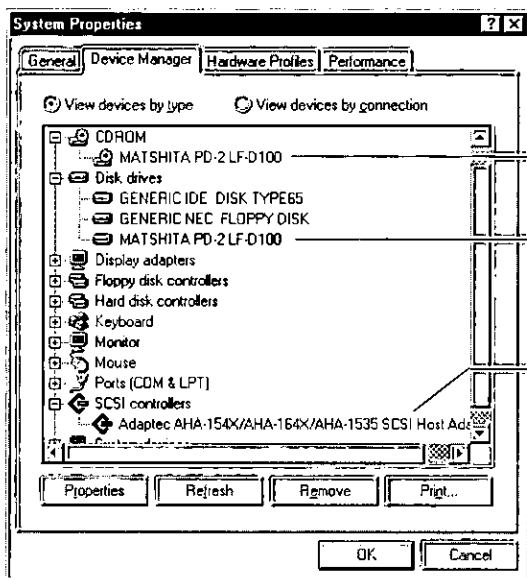

a CD-ROM/DVD-ROM side of this DVD-RAM drive is recognized.

b DVD-RAM disc/PD cartridge side of this DVD-RAM drive is recognized.

c SCSI host adaptor is recognized.

Note:

• Checking with [SCSI Adapters] on Windows NT

Double-click [SCSI Adapters] on [Control Panel], then click [Devices]. The screen shown at right (equipment connection statuses) is displayed.

When the SCSI host adaptor, which is connected to DVD-RAM drive, is double-clicked, only the CD-ROM / DVD-ROM portion is displayed.

This is a limitation of this driver software's specification.

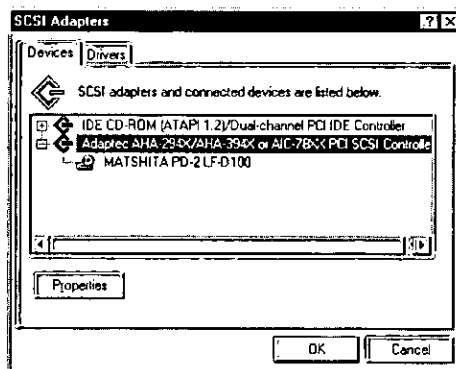

Using a DVD-RAM Disc

A DVD-RAM disc must be logically formatted prior to use, just as you would similarly format a floppy disk prior to use.

However, a DVD-RAM disc is formatted with the UDF file system which is optimized for large capacity, high performance removable media. Windows native formatting utilities do not support UDF, therefore the DVDForm software, supplied with the DVD-RAM drive, needs to be used in order to take advantage of the UDF file system and optimize your DVD-RAM drive's performance.

Logical formatting

A DVD-RAM disc can be formatted using either UDF (Universal Disk Format) or FAT format. Format 5.2 GB double-sided DVD-RAM discs one side at a time.

■ UDF Format

The UDF format is newly specified for the DVD family of products to enable a high level of data compatibility between DVD-ROM, DVD-R and DVD-RAM. This new format is optimized for big capacity files, such as Video and Audio capture and playback, to keep constant, high transfer rates.

- Since the file control structure is relatively complicated compared with FAT, it is not as good when handling a large number of small files.
- When the UDF format is used for formatting, files will be displayed more slowly in Explorer.

■ FAT Format

FAT is the Windows OS embedded file system and used for current hard disk drive and PD cartridge.

- Compared with UDF, it is good for small random files access.

1 Insert the DVD-RAM disc you wish to format into the DVD-RAM drive.

2 Open [My Computer] and click [Removable Disk] icon assigned to DVD-RAM disc/PD cartridge using the right button of the mouse.

3 Click [Format] on the menu screen.

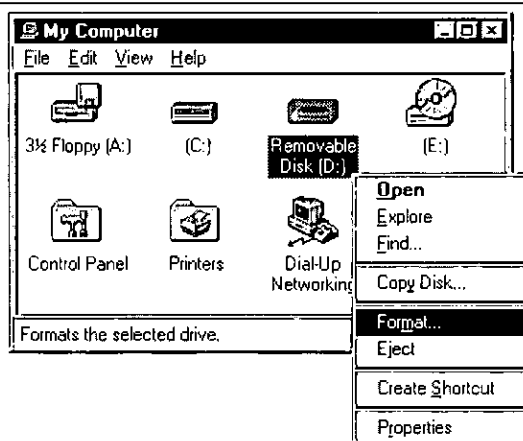

(Continued on the next page)

4

On the screen, click [Start].

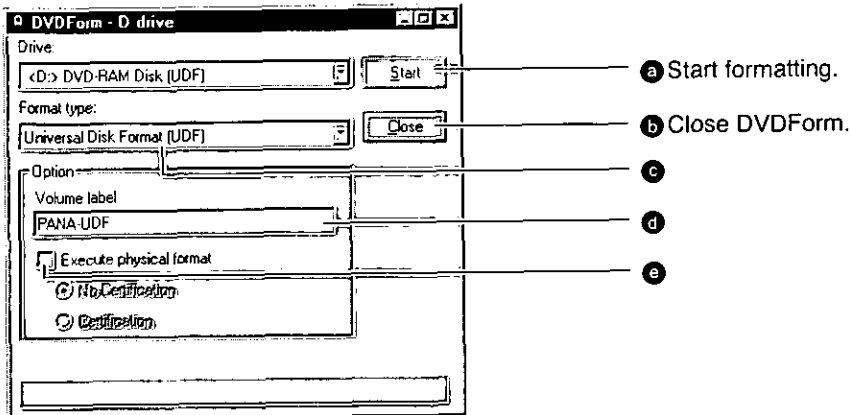

c Click the  area to select the format type.

Universal Disk Format [UDF]	This is the standard format type for DVD-RAM. The available disc space on one side of the disc is 2.3 GB* ¹ after formatted. Immediately after a DVD-RAM disc is formatted in UDF, the used disc space is displayed as 128 KB.
In case of Windows 95/Windows 98 FDISK FAT-16	This is the Windows OS embedded format type. The available disc space is limited to 2.0 GB after formatted. This formatted DVD-RAM disc can be used on Windows NT.
In case of Windows NT FDISK FAT-16 2.0 GB	
FAT-32	This is the additional format type on Windows 95 (OSR2* ²) and Windows 98. This is not displayed in Windows NT. The available disc space on one side of the disc is 2.3 GB* ¹ after formatted. This formatted DVD-RAM disc cannot be used on Windows NT.
FDISK FAT-16 2.32 GB (Windows NT Only)	This is the Windows NT embedded format type. This is not displayed in Windows 95 or Windows 98. The available disc space on one side of the disc is 2.3 GB* ¹ after formatted. Do not use this formatted DVD-RAM disc on Windows 95/98.

*¹ The entire space on one side of the unformatted DVD-RAM disc is 2.6 GB, but the available disc space is 2.3 GB after logical formatting.

*² Windows 95 whose system property is "4.00.950 B" or "4.00.950 C".

d Enter a volume name.

- You must input a volume name when you select UDF format. When you do not input it, a volume name is set as "PANA-UDF" automatically.

e Select this when you want to perform physical formatting. (There is no need to do this every time.)

No Certification:

This mode does not check sectors for defects. Instead, it allocates defective sectors previously registered during usage. (Normally this is completed in 20 or 30 seconds.)

Certification:

This mode forces a check of all sectors for defects and allocates detected defective sectors to the spare area. (Normally this is completed in about an hour.)

(Continued on the next page)

5

When the formatting confirmation message is displayed, click [Yes] in the dialog box.

Formatting begins.

- You can use the DVD-RAM disc after formatting.

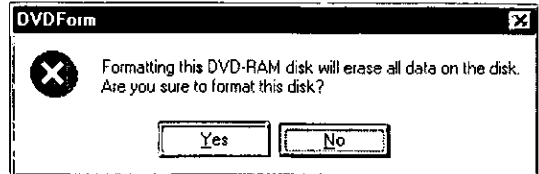

Note:

- Displaying the folder name or file name written on the UDF-formatted DVD-RAM disc on Windows 95 / Windows 98

In case of FAT-formatted DVD-RAM disc

When you are at the MS-DOS prompt or in an MS-DOS or Windows 3.1 application, if you display folder names or file names which are not 8.3 file (folder) names*1 on a FAT-formatted DVD-RAM disc, the folder names or file names will be displayed as 8.3 file (folder) names*1 as shown below.

Display on Windows 95/Windows 98

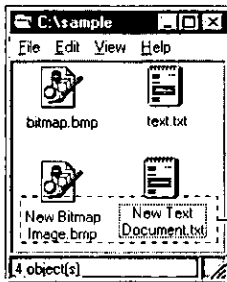

Display on MS-DOS prompt

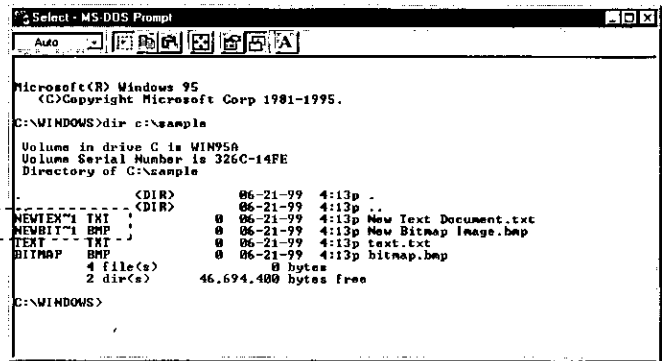

In case of UDF-formatted DVD-RAM disc

When the folder name or file name other than 8.3 file (folder) name*1 is written on the UDF-formatted DVD-RAM disc, it will be displayed only up to 8 characters with the MS-DOS prompt or in an MS-DOS or Windows 3.1 application as shown below. In this case, you cannot copy, delete or perform other operations on these folders or files.

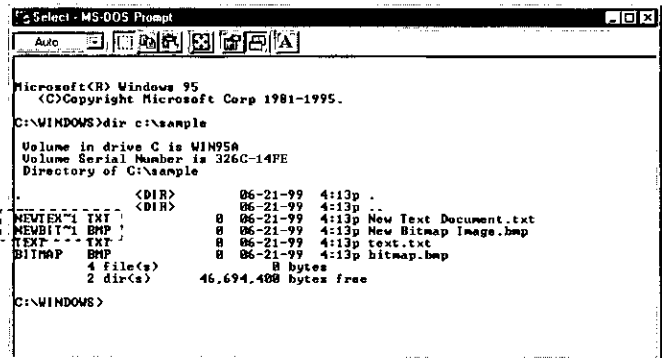

To perform operations at the MS-DOS prompt or in an MS-DOS or Windows 3.1 application on folders or files on the UDF-formatted DVD-RAM disc that are not 8.3 file (folder) names*1, use UDFTOOL.EXE in the "\Program Files\Panasonic DVD-RAM\Utility" folder, and set this application to generate 8.3 file (folder) names*1.

[Select "Create MS-DOS file name according to UDF 1.02 specification." under "Select the creation method of MS-DOS name (8.3 type) for UDF".]

*1 An 8.3 file (folder) name is a file (folder) name in which the name part is 8 characters or less and the extension is 3 characters or less. In file (folder) names following this convention, periods (.) are only used to separate the name part from the extension.

Note:

- **Displaying the folder name or file name written on the UDF-formatted DVD-RAM disc on Windows NT**

In case of FAT- formatted DVD-RAM disc

When you are at the MS-DOS prompt or in an MS-DOS or Windows 3.1 application, if you display folder names or file names which are not 8.3 file (folder) names*1 on a FAT-formatted DVD-RAM disc, the folder names or file names will be displayed as 8.3 file (folder) names*1 as shown below.

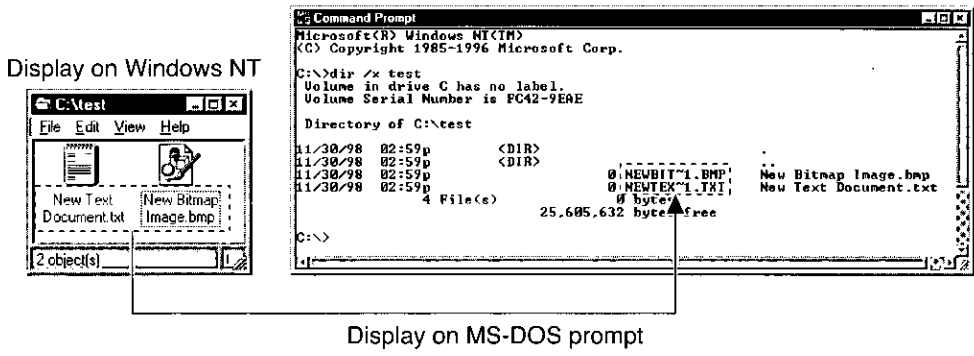

In case of UDF- formatted DVD-RAM disc

When the folder name or file name other than 8.3 file (folder) names*1 is written on the UDF formatted DVD-RAM disc, it will not be displayed with the MS-DOS prompt or in an MS-DOS or Windows 3.1 application.

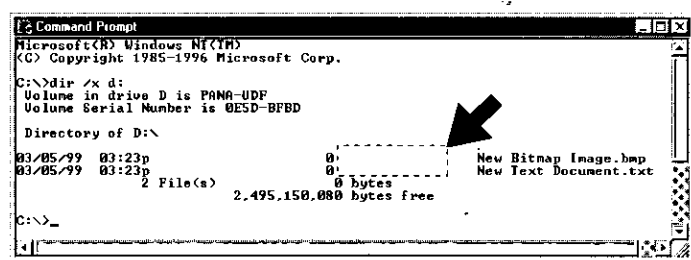

This is a limitation of this driver software.

When you create a folder name or file name other than 8.3 file (folder) name*1 by using MS-DOS prompt or Windows 3.1 application, please use the FAT-formatted DVD-RAM disc.

*1 An 8.3 file (folder) name is a file (folder) name in which the name part is 8 characters or less and the extension is 3 characters or less. In file (folder) names following this convention, periods (.) are only used to separate the name part from the extension.

Caution:

• **Do not format a DVD-RAM disc on Windows 95/Windows 98 in the following manner:**

1. Do not format by using Windows format program opening [My Computer], right-clicking [Removable Disk] icon assigned to DVD-RAM discs and clicking [Format] on the menu that appears.
2. Do not format by using Windows format program opening [My Computer], left-double clicking the [Removable Disk] icon assigned to DVD-RAM discs and clicking [Yes] of the following panel.

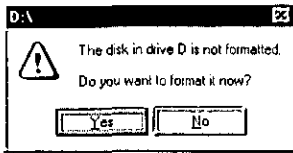

Formatting a DVD-RAM disc with the standard format program included in Windows 95/Windows 98 results in a FAT16 format that exceeds the 2.0 GB limit, which can interfere with subsequent use.

• **Executing Format software on Windows NT**

The following notes apply to the logical format of PD cartridge, too. (See page 23.)

- (1) When using the format software, you must login with the user name that belongs to "Administrator group".
- (2) You must close all applications used on a DVD-RAM disc or a PD cartridge prior to formatting.

Reading and writing a DVD-RAM disc

Once you have logically formatted a DVD-RAM disc, it can be used to read and write files just as you would with a hard disk or floppy disk.

For instance, if the [Removable Disk] icon assigned to this DVD-RAM drive is recognized as D drive, insert the DVD-RAM disc and perform the operations from D drive.

(The actual drive letter of the DVD-RAM drive will differ according to the environment of the system you are using.)

Note:

- The error checking and optimizing programs cannot be used on a UDF-formatted DVD-RAM disc.

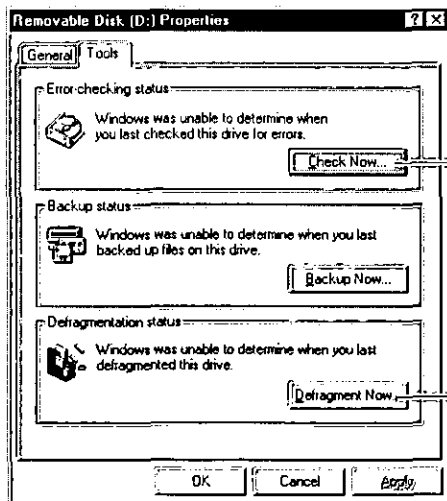

Cannot be used.

Cannot be used.

Using a PD Cartridge

Logical formatting

A PD cartridge must be logically formatted prior to use, just as you would similarly format a floppy disk or hard disk prior to use.

Follow the instructions below to proceed with logical formatting.

1 Insert the PD cartridge you wish to format into the DVD-RAM drive.

2 Open [My Computer] and click [Removable Disk] icon allocated to DVD-RAM disc/PD cartridge using the right button of the mouse.

3 Click [Format] on the menu screen.

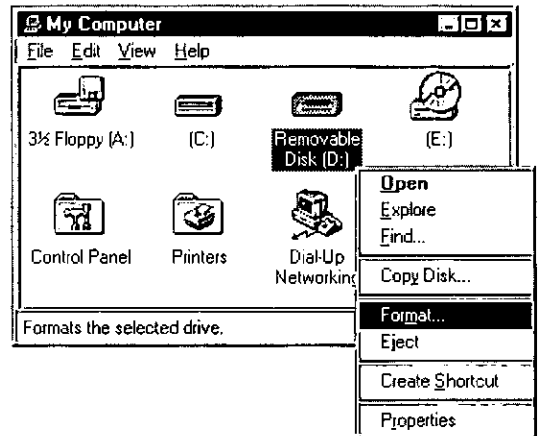

(Continued on the next page)

4

On the screen, click [Start].

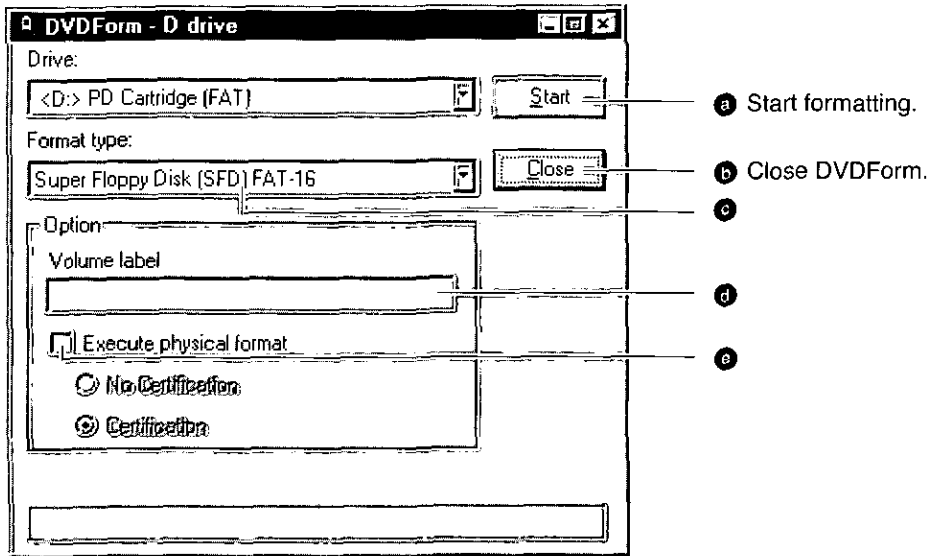

Click the Σ area to select the format type.

Super Floppy Disk [SFD] FAT-16	This is the Windows OS embedded format type.
FDISK FAT-16	This is the Windows OS embedded format type. This format type cannot be used in Windows NT 3.5x and other versions that do not support the FDISK format.

Enter a volume name.

Select this when you want to perform physical formatting. (There is no need to do this every time.)

No Certification:

In case of PD cartridge, this mode cannot be selected.

Certification:

This mode forces a check of all sectors for defects and allocates detected defective sectors to the spare area. Since this mode performs a thorough check of all sectors, it takes about a half-hour for PD cartridge.

5

When the formatting confirmation message is displayed, click [Yes] in the dialog box.

Formatting begins.

- You can use the PD cartridge after formatting.

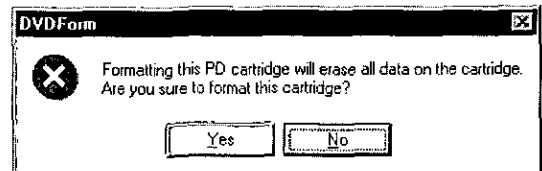

Reading and writing a PD cartridge

Once you have logically formatted a PD cartridge, it can be used to read and write files just as you would with a hard disk or floppy disk.

For instance, if the [Removable Disk] icon assigned to the DVD-RAM drive is recognized as D drive, insert the PD cartridge and perform the operations from D drive.

(The actual drive letter of the DVD-RAM drive will differ according to the environment of the system you are using.)

Using CD-ROM, DVD-ROM and Other CD/DVD Discs

Playing a disc

The DVD-RAM drive can be used to play back music CDs, CD-ROMs, CD-Rs/RWs, DVD-ROMs, DVD-Rs, and other discs just as you would with a CD-ROM drive or DVD-ROM drive.

For details, refer to the instruction manual supplied with the disc you wish to play back.

For instance, if the [CD-ROM] icon assigned to the DVD-RAM drive is recognized as the E drive, insert a CD-ROM or DVD-ROM and access it from E drive.

(The actual drive letter of the DVD-RAM drive will differ according to the environment of the system you are using.)

■ What you will need to play DVD (e.g., DVD-VIDEO and DVD-ROM)

- Your computer will need to have a MPEG2 decoder board (not included) or MPEG2 decoder software (not included).
- The region numbers on the DVD-RAM drive and MPEG2 decoder board (or MPEG2 decoder software) must match the region number on the DVD.

When this DVD-RAM drive was shipped from the factory, the region number was set to "1" to match the region number on DVD sold in your region. Therefore it is normally not necessary to change the region number setting.

Use the included DVDRgn software to change the region number setting on the DVD-RAM drive. (See page 29.)



This mark indicates the region number of a DVD.
It is displayed in areas such as the case jacket of a DVD.
The example shown here is the mark for region number 1.

For your reference:

- When CD-R, CD-RW and DVD-R media are read on this DVD-RAM drive, there may be a decline in the read speed and on rare occasions the reading process may not work properly, depending on the writing drive and disc statuses and compatibility. If such problems occur, this DVD-RAM drive may be able to properly read the media if the write speed on the writing device is lowered.

About the Supplied Application Software

Using MPEG1 Coder (MPEG1 compression software)

MPEG1 Coder

This software allows you to compress, in real time, full-motion video shot with a video camera and other data into the MPEG1 format, and record it to a DVD-RAM disc or PD cartridge.

With a single 2.6 GB DVD-RAM disc, you can record approximately 2 hours of MPEG1 video in standard mode (with a video data rate of 2.0 Mbps and an image size of 320 × 240).

It can also play video recorded in the Windows standard Active Movie (software decoder) format.

Note:

- A sample MPEG1 file is stored in the "Sample" folder in the root directory of supplied CD-ROM disc. This sample data can be used with MPEG1 Coder.

Operating requirements for MPEG1 Coder

Computer:	IBM PC/AT compatible computer
OS:	Windows 95, Windows 98
CPU:	Intel Pentium 166 MHz or higher (MMX capabilities recommended)
Memory:	32 MB or higher (64 MB recommended)
Hard disk space:	3 MB (minimum)
Others:	An environment with a video capture card and sound card

■ **Video capture card**

A video capture card (not included) is required to capture video with MPEG1 Coder.

Below are the two compatibility requirements for video capture cards.

1. Compatible with Video for Windows Ver1.1 or higher
2. Support of the RGB capture data format

Verified compatible video capture cards:

1. Panasonic EggCam™ Camera Kit GP-KR0011

■ **Sound cards**

A Sound Blaster-compatible sound card (not included) is required to record sound.

Verified compatible sound cards

1. Sound Blaster 16 PNP
2. Sound Blaster AWE 32
3. Sound Blaster AWE 64
4. Sound Blaster PCI 64
5. XGYMF-724V 3D Chip PCI

Note:

- Because MPEG1 Coder uses software to compress image data, some computers may not have sufficient performance for data compression (e.g., software processing may take a long time).

Example performance

Mode:	Standard mode
Capture card:	Panasonic EggCam™ Camera Kit GP-KR0011
CPU:	Pentium II 266 MHz (Memory: 64 MB)
Capture settings:	size 320 × 240, capture format RGB15, video rate 3 Mbps, audio rate 96 kbps, audio 11 kHz, mono

With the above conditions, a capture rate of roughly 30 frames per second is possible.

Using DVDRgn (region number setting utility)

DVDRgn

This software is used to set the region number of the DVD-RAM drive (this setting can only be made a maximum of four times). The regions where DVD-ROM and DVD-VIDEO discs can be played are specified by region numbers. In order to play a disc, the region number on the DVD-RAM drive must match the region number on the disc. When this drive is shipped from the factory, the region number is set to "1".

Operating requirements for DVDRgn

Computer:	IBM PC/AT compatible computer
OS:	Windows 95, Windows 98, Windows NT4.0
Hard disk space:	1 MB or higher

Starting DVDRgn

From the Start menu, select [Programs]→[Panasonic DVD-RAM]→[Utility]→[DVDRgn].

■ Settings

- 1 Select the DVD-RAM drive.
- 2 Insert a DVD disc with the desired region number in the DVD-RAM drive.
 - If no disc is inserted, you cannot set the region number.
- 3 Be sure to check the region number currently set and the number of times the region number can be changed.
 - Under the factory default, the region number setting can only be changed a maximum of four times, so keep track of the number of times you change the setting. (You cannot change it more than four times.)
- 4 The radio button(s) representing the region number(s) of the inserted DVD disc will be selectable. Select the region number for the inserted disc.
 - You can select the region number by country name. Click [Select Country Name...], and select your country.
- 5 Click [Set Region Number].

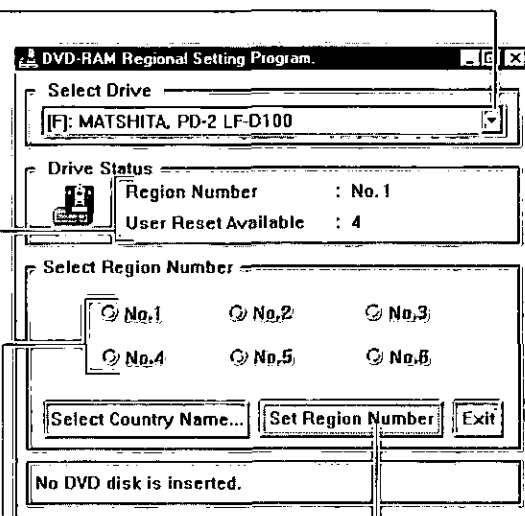

Note:

- Please note that the number of times the DVD-RAM drive region number setting can be set/changed is limited to 4.
- When [User reset available] is "1", be absolutely sure to set the region number for the DVD discs you wish to playback in future.
After this final setting, you will be unable to change the region number again and will only be able to playback DVD discs with the region number that is set.
- When changing the region number for the fourth and last time, be sure to insert a DVD disc that only displays one region number. If a disc displaying multiple region number is inserted, you will be unable to set/change the region number.

Using DVD Agent (utility)

DVD Agent

This software enhances the standard Windows GUI by replacing the default icons for removable drives and CD-ROM drives with customized DVD-RAM icons. Additionally, DVD Agent provides functionality to automatically launch applications upon insertion of a DVD-RAM disc or PD cartridge.

Operating requirements for DVD Agent

Computer:	IBM PC/AT compatible computer
OS:	Windows 95, Windows 98
Hard disk space:	1 MB or higher

Starting DVD Agent

■ Icon Manager

When you install DVD Agent and reboot your computer, the standard Windows icons for the DVD-RAM drive in the [My Computer] window are replaced with special icons for the DVD-RAM drive.

Before installing DVD Agent

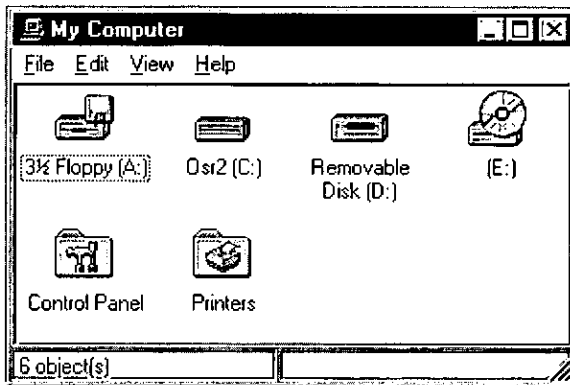

After installing DVD Agent

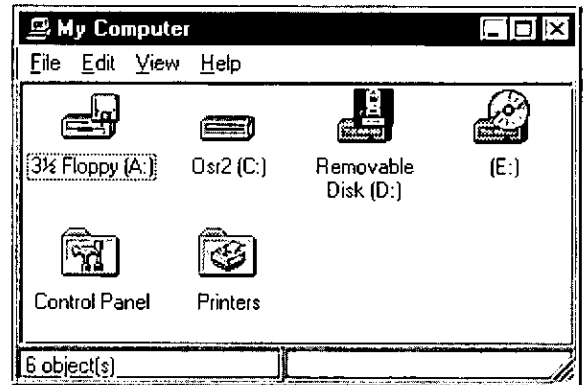

■ Auto Run

When a DVD-RAM disc or PD cartridge is placed in this DVD-RAM drive, a preset application can be run.

Right-click the icon for DVD-RAM discs or PD cartridges, then select [Auto Run]→[Setting].

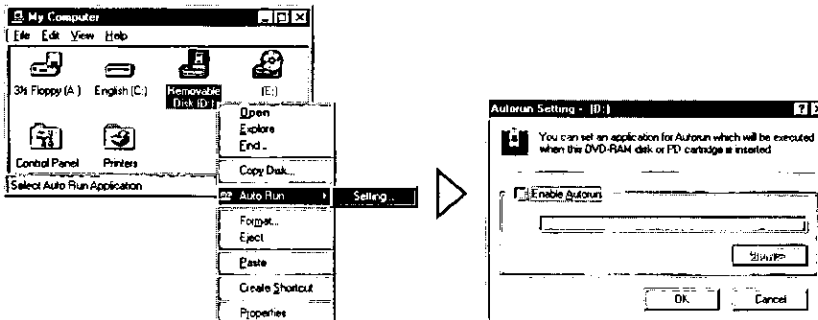

Note:

- If you encounter system problems (i.e. system hangs, performance deteriorates, etc.) after setting Auto Run, you can disable the Auto Run function.

How to disable Auto Run

Click the [DVD-RAM Drive] icon in the Task Bar. The icon will change so that a red "x" is placed over it  indicating that the Auto Run function is disabled.

How to enable Auto Run

When the [DVD-RAM Drive] icon  in the Task Bar indicates that Auto Run is disabled (i.e. icon has red "x" over it), simply click the icon. This will remove the red "x" indicating the Auto Run is enabled.

Starting MPEG1 Coder

From the Start menu, select [Programs]→[Panasonic DVD-RAM]→[MPEG1 Coder]→[MPEG1 Coder].



Caution:

- Select Active Movie before using MPEG1 Coder. To start the Active Movie selection program, from the Start menu select [Programs]→[Panasonic DVD-RAM]→[MPEG1 Coder]→[Active Movie Select Switch].
- Before data that you have recorded with MPEG1 Coder is used in a manner that exceeds the scope of personal use, you must first obtain the permission of the copyright holder in accordance with copyright law.

Note:

- Refer to the help files for operating and troubleshooting procedures. The help files can be opened either by clicking [Help] on the application, or by selecting [Programs]→[Panasonic DVD-RAM]→[MPEG1 Coder]→[Help for MPEG1 Coder] from the Start menu.

Using FileSafe (backup software)

FileSafe

This software can automatically back up data in specified folders, or back up only updated folders, enabling you to protect important files efficiently.

■ Copying in the same file format as the actual file

When a job is run, a folder with the same name as the job name is created in the root directory of the DVD-RAM disc or PD cartridge inserted into the DVD-RAM drive, and the contents of the selected source folder are copied in the actual file format.

As a result, copied folders and files can be used in Explorer and other applications.

■ Copying and restoring

The following modes are supported.

1. Normal Copy

Same as Explorer's Copy in that the selected source folder is simply copied to the DVD-RAM drive.

2. Clone Copy

Duplicates the contents of the selected source folders onto the DVD-RAM or PD media. (Deletes all data in the copy destination and copies the data from the original.)

3. Synchronized Copy

Files which are not the same on the original and this DVD-RAM drive are copied to corresponding folders, and the folder contents are updated to match each other. (When both folders contain a file with the same name, the most recent version of the file is copied.)

4. Restore

Copy files on the DVD-RAM drive back onto the source drive to restore data.

■ Copying only changed files (Default setting)

In this mode, only files that have been changed are copied from the source folders to the DVD-RAM drive.

In the first execution, all files in the specified source folders are copied, but from the second execution on, only those files and folders that have been newly created or changed from the previous execution are copied.

■ Scheduled Execution function

Three Scheduled Execution modes are supported: "Keyboard Not Use Mode", "Clock Mode" and "Interval Mode". This allows you to define a schedule to automatically execute pre-configured jobs at a time best suited for the data and usage of the system.

■ Management of copy Jobs using Job files

It is possible to configure settings for each copy mode ("Normal Copy", "Clone Copy" and "Synchronized Copy") which are saved in a Job file.

This allows you to execute the copy, with all the corresponding settings, simply by selecting the job.

Operating requirements for FileSafe

Computer:	IBM PC/AT compatible computer
OS:	Windows 95, Windows 98, Windows NT4.0
Hard disk space:	1 MB or higher

Starting FileSafe

From the Start menu, select [Programs]→[Panasonic DVD-RAM]→[FileSafe]→[FileSafe].

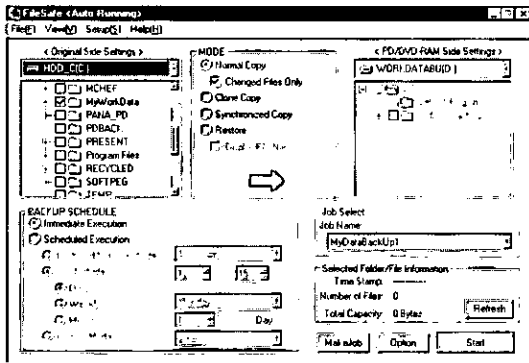

Note:

- FileSafe manages discs based on their volume names, so you must enter volume names on the hard disk, DVD-RAM discs, and PD cartridges you are using.
- Refer to the help files for operating and troubleshooting procedures. The help files can be opened by clicking [Help] on the application. Alternately, move the mouse pointer to any button on the application and click right button of the mouse to see detailed help information about that item.

Using MediaSafe (disc copying software)

MediaSafe

This software lets you copy data recorded on a DVD-RAM disc or PD cartridge to a different DVD-RAM disc or PD cartridge using a single DVD-RAM drive.

Operating requirements for MediaSafe

Computer:	IBM PC/AT compatible computer
OS:	Windows 95, Windows 98, Windows NT4.0
Hard disk space:	1 MB or higher

Starting MediaSafe

From the Start menu, select [Programs]→[Panasonic DVD-RAM]→[MediaSafe]→[MediaSafe].

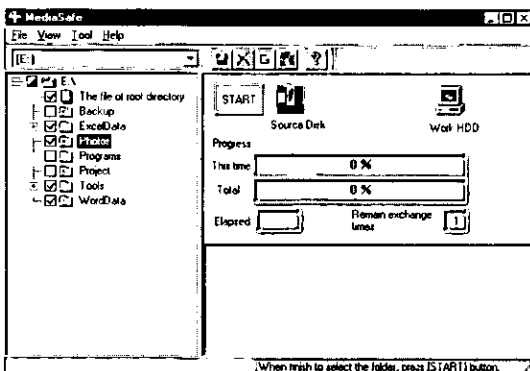

Note:

- Refer to the help files for operating and troubleshooting procedures. The help files can be opened by clicking [Help] on the application. Alternately, move the mouse pointer to any button on the application and click right button of the mouse to see detailed help information about that item.

■ DVD-RAM drive management

You can enter cache settings for this DVD-RAM drive.

Right-click the DVD-RAM disc or PD cartridge icon, then select [Properties]→[Drive Control] (the error checking and optimizing programs found under the Tools tab cannot be used on a UDF-formatted DVD-RAM disc).

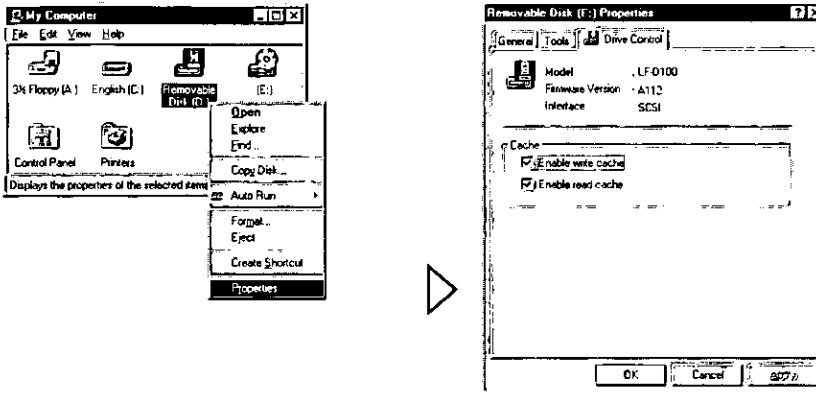

■ WAV Player

The WAV Player lets you capture music CDs on a DVD-RAM disc or PD cartridge, and play captured tracks.

From the Start menu, select [Programs]→[Panasonic DVD-RAM]→[DVD Agent]→[WAV Player].

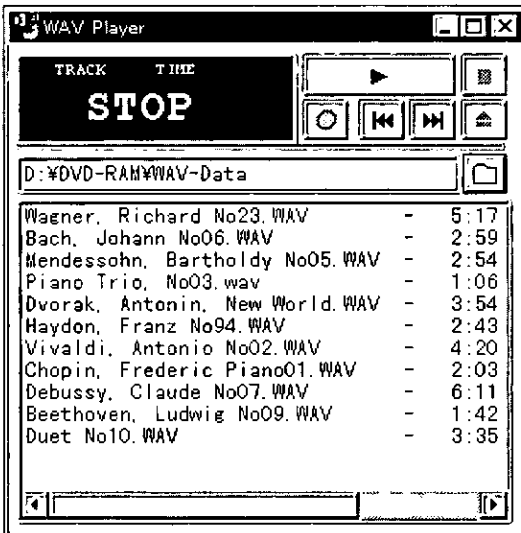

Caution:

- Before data that you have recorded with WAV Player's audio capture feature is used in a manner that exceeds the scope of personal use, you must first obtain the permission of the copyright holder in accordance with copyright law.

Note:

- Refer to the help files for operating and troubleshooting procedures. The help files can be opened either by clicking [Help] on the application, or by selecting [Programs]→[Panasonic DVD-RAM]→[DVD Agent]→[Help for DVD Agent] from the start menu.

In addition, you can access help by clicking the left mouse button on [?] button on the application and then clicking the left mouse button again to select the item you wish to see help. Help information for that item will appear.

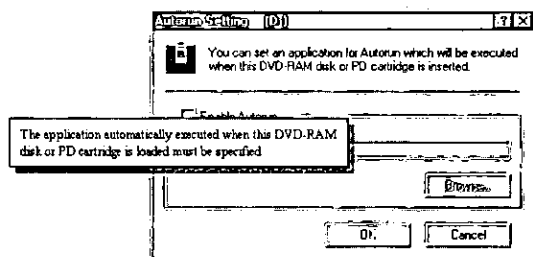

Installing the supplied application software

Note:

- The supplied application software is for use with this DVD-RAM drive only, and will not run on other devices.

1

Insert the supplied CD-ROM into the DVD-RAM drive.

The installation program starts automatically.

- If the installation program does not start automatically, start it manually by following the procedure below.

(This assumes that the drive letter assigned to the DVD-RAM drive for CD-ROM media is E:.)

1 From the Start menu select [Run].

2 In the "Open" box, enter "e:\setup.exe" and click [OK].

The installation program starts.

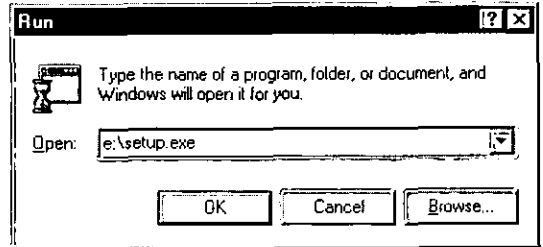

2

Click [Application Setup].

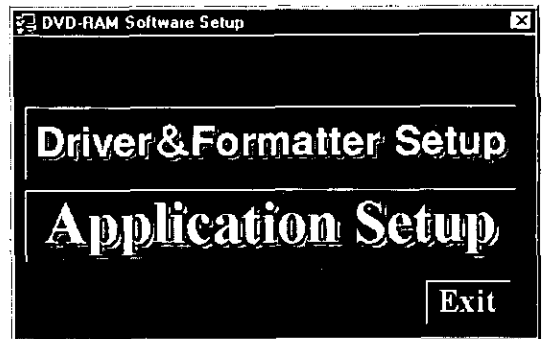

3

Select the application to install and click [Next].

Installation begins.

- You can select multiple programs at the same time.
- Follow the on-screen instructions to proceed.

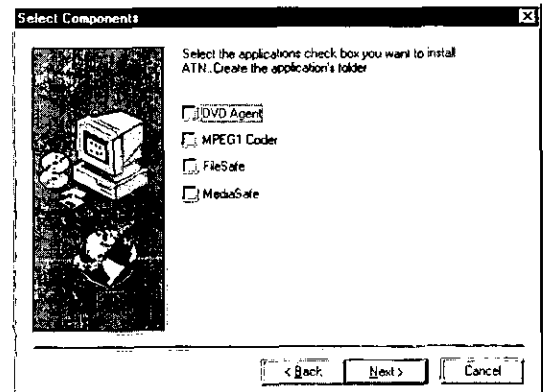

Uninstalling the Software

Uninstalling driver software

To delete the driver software that you have installed on your computer, uninstall it by following the procedure below.

1 Insert the supplied CD-ROM into the DVD-RAM drive.

(This assumes that the drive letter assigned to the DVD-RAM drive for CD-ROM media is E:.)

- If the window as right is displayed, click [Exit].

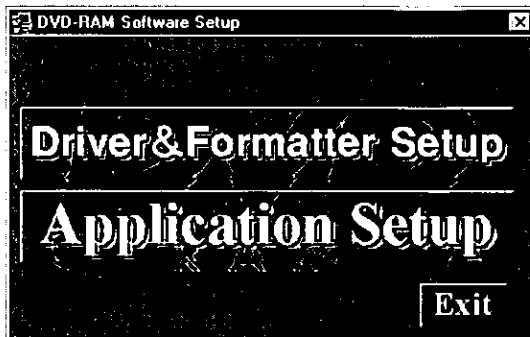

2 From the Start menu select [Run].

3 Enter the following file name in the "Open" box, and click [OK].

The uninstallation program starts automatically.

- In case of Windows 95 / Windows 98
[e:\win9x\english\driver\setup.exe]
- In case of Windows NT
[e:\winnt\english\driver\setup.exe]

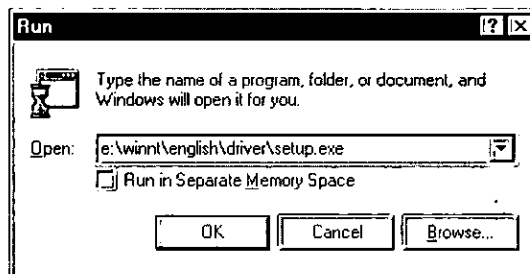

4 Select "Uninstall DVD Driver" and click [Next].

Uninstalling begins.

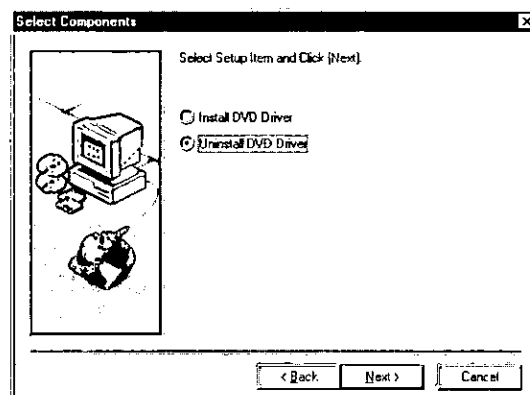

(Continued on the next page)

5

After uninstallation, Select “Yes, I want to restart my computer now.” and click [Finish].

The computer now reboots.

- After rebooting, uninstallation is completed.

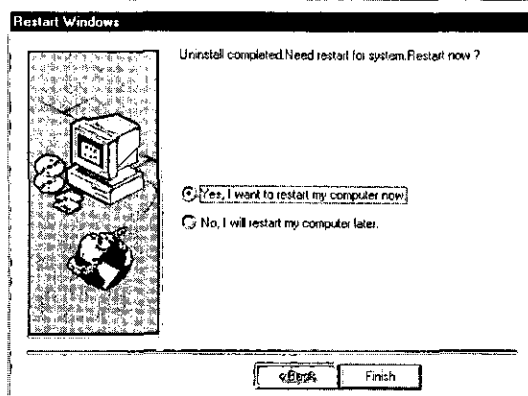

Uninstalling the supplied utility and application software

To delete supplied utility (Format software/Region setting software) and application software that you have installed on your computer, uninstall it by following the procedure below.

1

From the Start menu, select [Settings], then [Control Panel].

- You may also open the [My Computer] window and then select [Control Panel].

2

Double-click [Add/Remove Programs] and select the application you wish to delete.

3

Click [Add/Remove].

- Follow the on-screen instructions to proceed.
- When you finish uninstalling, reboot your system.

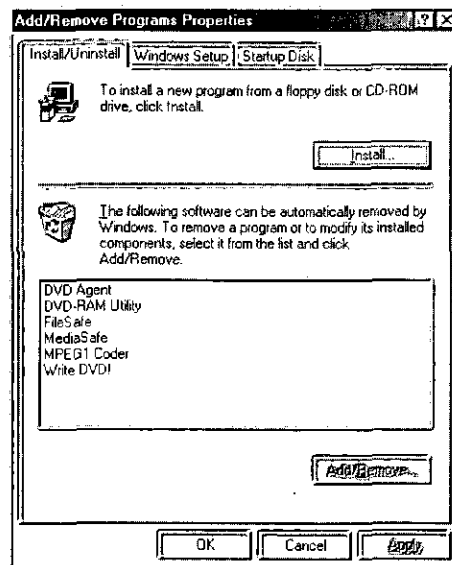

When Operation Indicator Lamp Blinks

This DVD-RAM drive will indicate malfunctions by blinking in green the operation indicator lamp on the front panel.

Blinking mode	Cause possible	Action
Triple blinking mode	Drive has used almost all of spare area sectors for defect management. This symptom typically occurs when drive lens and/or disc are dusty. In this condition, inserted disc will be write-protected.	Use this as Read Only mode disc. Or clean the lens and disc by using special cleaning kit recommended for the drive (see page 7) and format the disc with certification mode (see page 18 for DVD-RAM discs or page 23 for PD cartridges) after backing up the data.
Dual blinking mode	The lens of the drive or inserted disc is dusty. In this condition, inserted disc will be write-protected.	Clean the lens and disc by using special cleaning kit recommended for the drive (see page 7).
Single blinking mode	The drive internal temperature is too high.	Shut down DVD-RAM drive and cool it.

If recommended action does not correct the problem...

Contact the dealer where you purchased the DVD-RAM drive.

When getting technical support to repair the DVD-RAM drive...

Inform us of the operation indicator lamp blinking mode.

Troubleshooting

When this occurs	Possible cause	Refer to Page
No power	<ul style="list-style-type: none"> • Ensure connections through the AC adaptor are complete and correct. 	13
Tray fails to open.	<ul style="list-style-type: none"> • Is the DVD-RAM drive powered on? 	10
Tray fails to close.	<ul style="list-style-type: none"> • Has the media been inserted correctly? 	11
Computer fails to work.	<ul style="list-style-type: none"> • Has the drive's SCSI ID been set correctly? • Has the drive's terminator been set correctly? • Has a floppy disk been left inside the computer? 	12 12 —
Drive cannot be accessed normally.	<ul style="list-style-type: none"> • Is the DVD-RAM drive powered on? • Is the total length of SCSI cable shorter than the length specified by the SCSI host adaptor to be used? • Has the drive's terminator been set correctly? • Is the driver software installed correctly? 	10 11 12 15,16
Drive is not recognized on Windows.	<ul style="list-style-type: none"> • Is the SCSI host adaptor recognized correctly? • Is the driver software installed correctly? ☞ In case drive letter of CD-ROM/DVD-ROM side is recognized only, driver software is not installed. 	16,17 15,16
DVD-RAM disc cannot be read or written to.	<ul style="list-style-type: none"> • Did you initialize (format) the DVD-RAM disc? • Did you access the correct drive letter assigned to the drive? • Did you insert a single-sided DVD-RAM disc with the space for an adhesive label facing up? • Is the DVD-RAM disc dirty? • Has condensation formed in the drive? (Wait an hour or so after turning on the DVD-RAM drive for the drive to dry out and then try operating.) 	18 22 11 7 7
PD cartridge cannot be read or written to.	<ul style="list-style-type: none"> • Did you initialize (format) the PD cartridge? • Did you access the correct drive letter assigned to the drive? • Did you insert the PD cartridge with the space for an adhesive label facing up? • Is the PD cartridge dirty? • Has condensation formed in the drive? (Wait an hour or so after turning on the DVD-RAM drive for the drive to dry out and then try operating.) 	23 24 11 7 7
Discs cannot be read.	<ul style="list-style-type: none"> • Did you access the correct drive letter assigned to the drive? • Only the discs supported by this drive can be used. • Have the discs been placed correctly in the tray? • Did you insert the discs with label facing up? • Are you using correct software program for playing discs? • Is the disc dirty, scratched, cracked, warped, written on the surface or is a label put on the disc? • Has condensation formed in the drive? (Wait an hour or so after turning on the DVD-RAM drive for the drive to dry out and then try operating.) • Have you set the driver's region number? 	25 9 11 11 — 7, 38 7 29
No sound from the computer's speaker	<ul style="list-style-type: none"> • Ensure the connections to the computer (or speakers with internal amplifiers) through this drive's AUDIO OUT terminal are complete and correct. 	13

Handling DVD-RAM Discs

To safeguard DVD-RAM discs from damage Do not place the DVD-RAM discs in the following locations:

- Dirty or dusty locations
- Hot or humid locations or where they will be exposed to direct sunlight
- Locations susceptible to significant differences in temperature (condensation can occur)

Handling notes:

- Do not touch the disc surface.
 - Do not drop, bend or place heavy objects on the DVD-RAM discs.
 - Do not adhere a label which has been peeled off.
 - Do not incinerate the cartridge.
- Dispose of the cartridge correctly.

Preventing loss of valuable information

• To prohibit writing

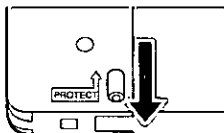

Write enable status

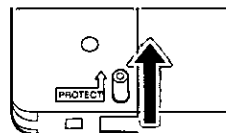

Write prohibit status

• Making backups

Just as with a hard disk or floppy disk, Panasonic recommends that you make backups (copy the data) at regular intervals.

Keeping the cartridges in their cases

(when they are not being used)

Remove the cartridge from the DVD-RAM drive and store it in its case.

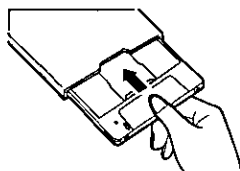

To remove the disc out of the TYPE2 cartridge

- 1 Push out the pin for disc removing using an object with a pointed end such as the emergency ejection pin (included).

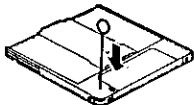

- 2 Pressing the hole located on the left side using an object with a pointed end, open the open/close cover.

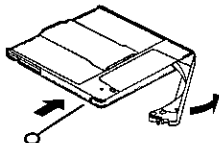

- 3 Taking care not to soil or damage the disc surface, remove the disc horizontally.

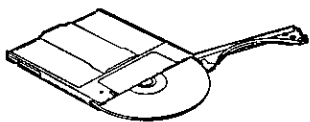

Notes:

- The disc which has been removed out of the TYPE2 cartridge can be used as read-only media.
 - ☞ When the disc is returned inside the cartridge, writing is possible again.
 - ☞ Writing speed may be reduced in some cases if a disc is removed and then returned to the cartridge.
- Be sure not to soil the disc surface with dirt, dust and fingerprints or damage the disc. In addition, do not drop it, bend it or adhere paper to it. (This may cause data read error.)
- To return a removed disc to its cartridge, first set the printed side of the shutter and the printed side of the disc to the same side. When doing this, make note of the write protection setting.

DVD-RAM disc

A DVD-RAM disc is a removable media developed as a "DVD to which data can be written", aiming at reading and writing large amounts of computer data. There are two types of DVD-RAM discs.

■ TYPE1

The disc inside cannot be removed. Single-sided discs have a capacity of 2.6 GB. Double-sided discs have a capacity of 5.2 GB.

■ TYPE2

Single-sided 2.6 GB DVD-RAM discs. The disc inside can be removed for future use in DVD-ROM drives which have DVD-RAM read compatibility.

Download from www.Somanuals.com. All Manuals Search And Download.

Handling PD Cartridges

To safeguard PD cartridges from damage
Do not place PD cartridges in the following locations:

- Dirty or dusty locations
- Hot or humid locations or where they will be exposed to direct sunlight
- Locations susceptible to significant differences in temperature (condensation can occur).

Handling notes:

- Do not open the shutter and touch the disk surface.
- Do not drop, bend or place heavy objects on the PD cartridges.
- Do not adhere a label which has been peeled off.
- Do not incinerate the cartridge.
Dispose of the cartridge correctly.

Preventing loss of valuable information

• To prohibit writing

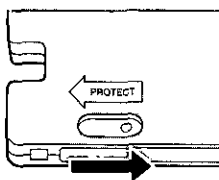

Write enable status

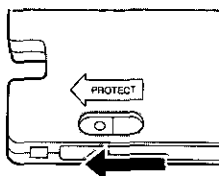

Write prohibit status

• Making backups

Just as with a hard disk or floppy disk, Panasonic recommends that you make backups (copy the data) at regular intervals.

Keeping the cartridges in their cases (when they are not being used)

Remove the cartridge from the DVD-RAM drive and store it in its case.

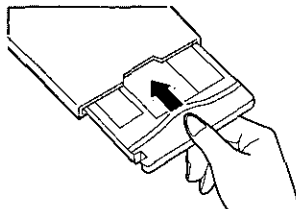

Handling CD-ROM, DVD-ROM and Other CD/DVD Discs

To safeguard discs from damage

Do not place the discs in the following locations:

- Hot or humid locations or where they will be exposed to direct sunlight.
- Locations susceptible to significant differences in temperature (condensation can occur).

Handling notes:

- Do not dirty or damage them.
- Do not drop or bend them.
- Do not write on or adhere labels to them.

What to do when a disc is dirty

Wipe the disc using a soft cloth which has been dipped in water, and then wipe with a dry cloth.

The disc must be wiped from the inside toward the outside.

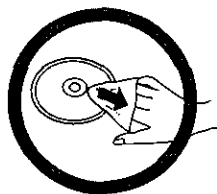

How to remove a disc from its case

Press down on the center part and lift the disc free.

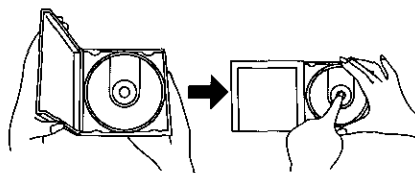

How to place a disc in its case

With its label side facing up, press the disc into place.

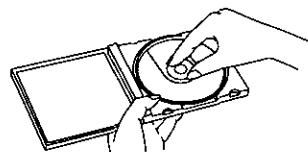

How to hold a disc

Take care not to touch the side which has no label printing.

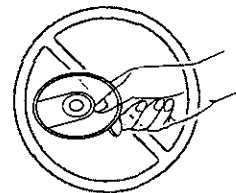

Specifications

DVD-RAM Drive

Power requirements (AC adaptor VSK 0558)	AC100 –120 V 50/60 Hz
Input current	0.3 – 0.25 A

Drive model number		LF-D102
Interface supported		SCSI-2 (Fast SCSI) (Supports SCAM Level 1)
Seek time (using Panasonic's measurement method)	DVD-RAM	120 ms
	DVD-ROM	85 ms
	PD	
	CD-ROM	
Sustained data transfer rate	DVD-RAM	1,385 KB/s
	DVD-ROM	2,770 KB/s (2 × speed mode)
	PD	518–1,141 KB/s
	CD-ROM	1,293–3,000 KB/s (Max. 20 × speed)
Buffer memory		2 MB
Audio output level (impedance)	Line out	0.84 Vrms (47 kΩ)
Drive orientation		Horizontal/Vertical
Allowable operating temperature range		41–95°F (5–35°C) (during operation)
Allowable operating humidity range (no condensation)		10–80% RH (during operation)
Dimensions (W × H × D)		6 ⁵ / ₈ " × 1 ³¹ / ₃₂ " × 9 ²¹ / ₃₂ " (168 × 50 × 245 mm) (excluding protrusions)
Weight (main unit)		3.3 lbs. (1.5 kg)
SCSI connector type		50-pin connector (pin type)
Applicable media	Read/Write	DVD-RAM, PD
	Read only	DVD-ROM, DVD-VIDEO* ¹ , DVD-R* ² * ³ , CD-DA* ⁴ , CD-ROM (Supports XA), Photo CD (Supports multisession), Video CD, CD-EXTRA, CD-R/RW* ³ * ⁵ , [120 mm Disc Media]

*¹ A MPEG2 decoder board (not included) or MPEG2 decoder software (not included) is also necessary to play DVD-VIDEO discs.

*² Supports discs with a capacity of 3.95 GB that are written with the Disc-at-Once option.

*³ Depending on how the disc is written, performance may not match the specified levels.

*⁴ CD-G not supported.

*⁵ Supports MultiRead for CD-R and CD-RW.

Specifications and external design are subject to change without notice because of product improvements.

DVD-RAM Disc

Model number	LM-DB26U (optional)	LM-DA26U (optional)	LM-DA52U (optional)
Disc type	Phase-change rewritable		
Disc diameter/thickness	4 $\frac{3}{4}$ " (120 mm)/ $\frac{1}{16}$ " (1.2 mm) (0.6 mm \times 2)		
Memory size (unformat)	2.6 GB (single side)	2.6 GB (single side)	5.2 GB (dual side)
Bytes/sector	2,048 Bytes/sector		
Sector/track	17–40 (ZCLV)		
Track/side	45,701		
Track pitch	0.74 μ m		
Track format	Wobbled Land & Groove Format		
Disc life	More than 30 years		
Ambient temperature	41–140°F (5–60°C) (during operation)		
Humidity range (no condensation)	3–85% RH (during operation)		
Dimensions (W \times H \times D)	4 $\frac{15}{16}$ " \times 5 $\frac{7}{16}$ " \times $\frac{3}{8}$ " (124.6 \times 138.0 \times 8.0 mm)		
Weight	Approx. 0.2 lb. (75 g)		
Cartridge type	TYPE2 (Removable)	TYPE1(Non-Removable)	TYPE1(Non-Removable)

Specifications and external design are subject to change without notice because of product improvements.

Technical Support

To answer questions or requests from customers who have bought the Panasonic DVD-RAM drive, the following Hotline is available for Panasonic customers. Please do not hesitate to call us.

The Hotline number is 1-800-PANASYS (1-800-726-2797)

This number is available 9 a.m. to 7 p.m. EST, normal business days.

Panasonic Document Imaging Company

Two Panasonic Way, 7D-9 Secaucus,
New Jersey 07094

© 1999 Matsushita Electric Industrial Co., Ltd.

Printed in Japan

M0999TY0 (D)

VQT8383

Free Manuals Download Website

<http://myh66.com>

<http://usermanuals.us>

<http://www.somanuals.com>

<http://www.4manuals.cc>

<http://www.manual-lib.com>

<http://www.404manual.com>

<http://www.luxmanual.com>

<http://aubethermostatmanual.com>

Golf course search by state

<http://golfingnear.com>

Email search by domain

<http://emailbydomain.com>

Auto manuals search

<http://auto.somanuals.com>

TV manuals search

<http://tv.somanuals.com>