

# Panasonic Broadcast Mechanical Parts List

Model No. : BT-LH80WP/E/MC, BT-YA80G/MC, BT-CS80G/MC

---

---

Note:

1. \*Be sure to make your orders of replacement parts according to this list.
2. Unless otherwise specified, all resistors are in OHMS, K=1,000 OHMS, all capacitors are in MICROFARADS ( $\mu$ F), P= $\mu$  $\mu$ F.
3. The P.C. Board unit marked with "■" shown below the main assembled parts.
4. The parts marked with  $\text{\textcircled{E}}$  on the exploded view show the electric parts.
5. IMPORTANT SAFETY NOTICE  
Components identified with the mark  $\Delta$  have the special characteristics for safety. When replacing any of these components, use only the same type.
6. The marking (RTL) indicates the retention time is limited for this item.  
After the discontinuation of this assembly in production, it will no longer be available.
7. "M" in Remark column indicates needed in the periodical maintenance.

## CONTENTS

CASING PARTS ASSEMBLY .....	MPL-1
PACKING PARTS ASSEMBLY (BT-LH80WP/E/MC) .....	MPL-3
PACKING PARTS ASSEMBLY (BT-YA80G/MC) .....	MPL-5
PACKING PARTS ASSEMBLY (BT-CS80G/MC) .....	MPL-7

# CASING PARTS ASSEMBLY

Components identified with the mark  have the special characteristics for safety.  
When replacing any of these components, use only the same type.

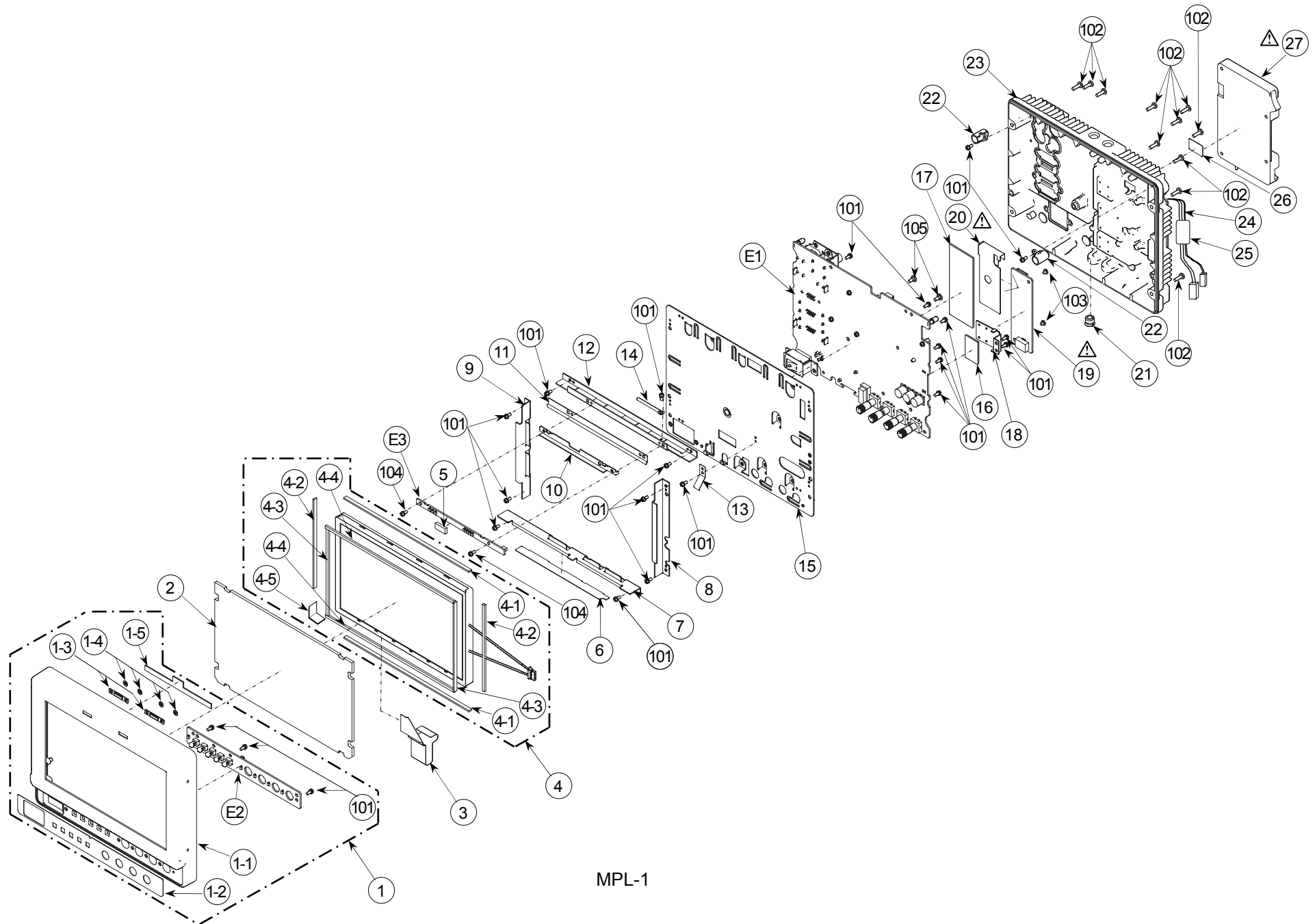



# PACKING PARTS ASSEMBLY (BT-LH80WP/E/MC)

Components identified with the mark  have the special characteristics for safety. When replacing any of these components, use only the same type.

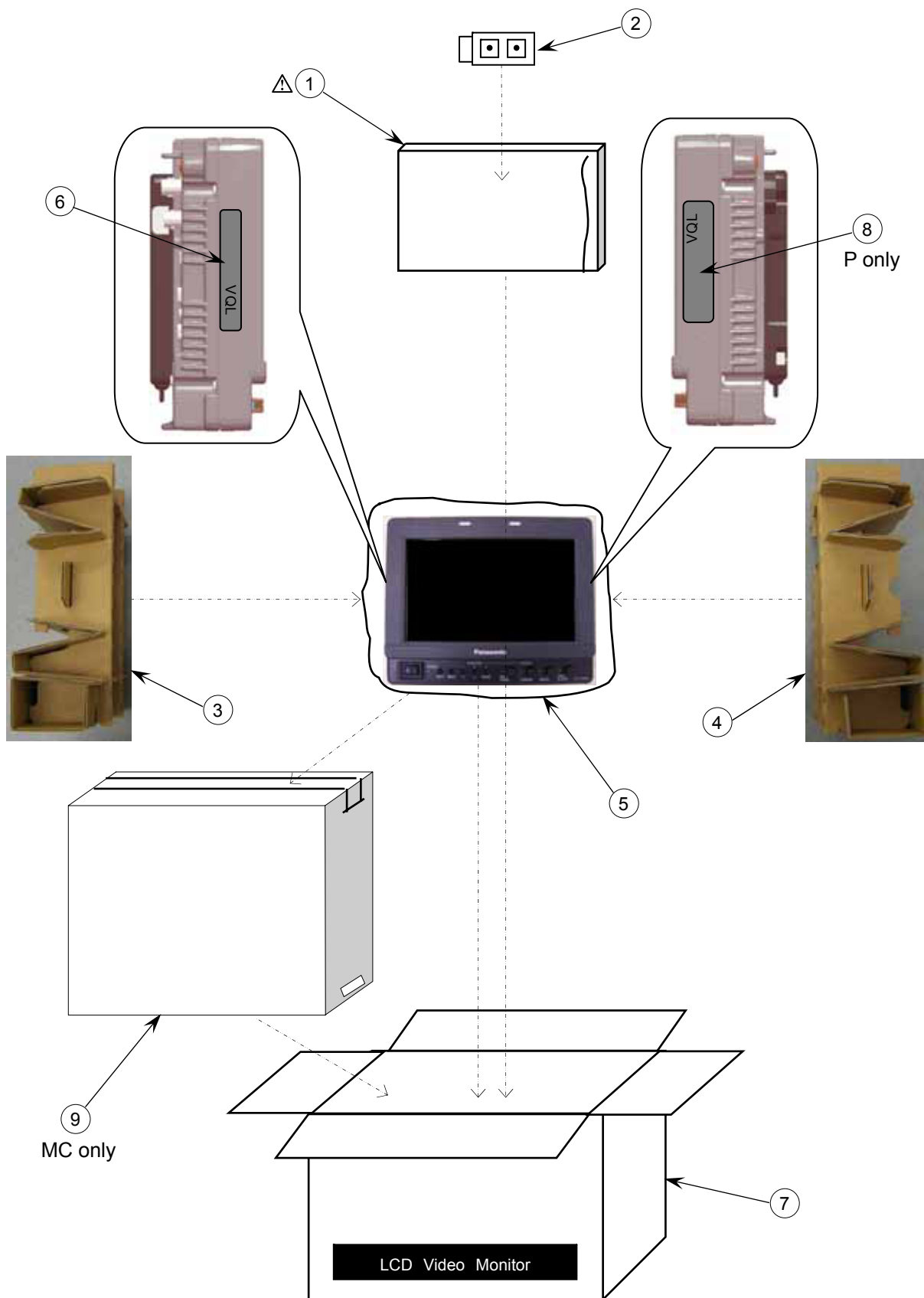



# PACKING PARTS ASSEMBLY (BT-YA80G/MC)

Components identified with the mark  have the special characteristics for safety. When replacing any of these components, use only the same type.

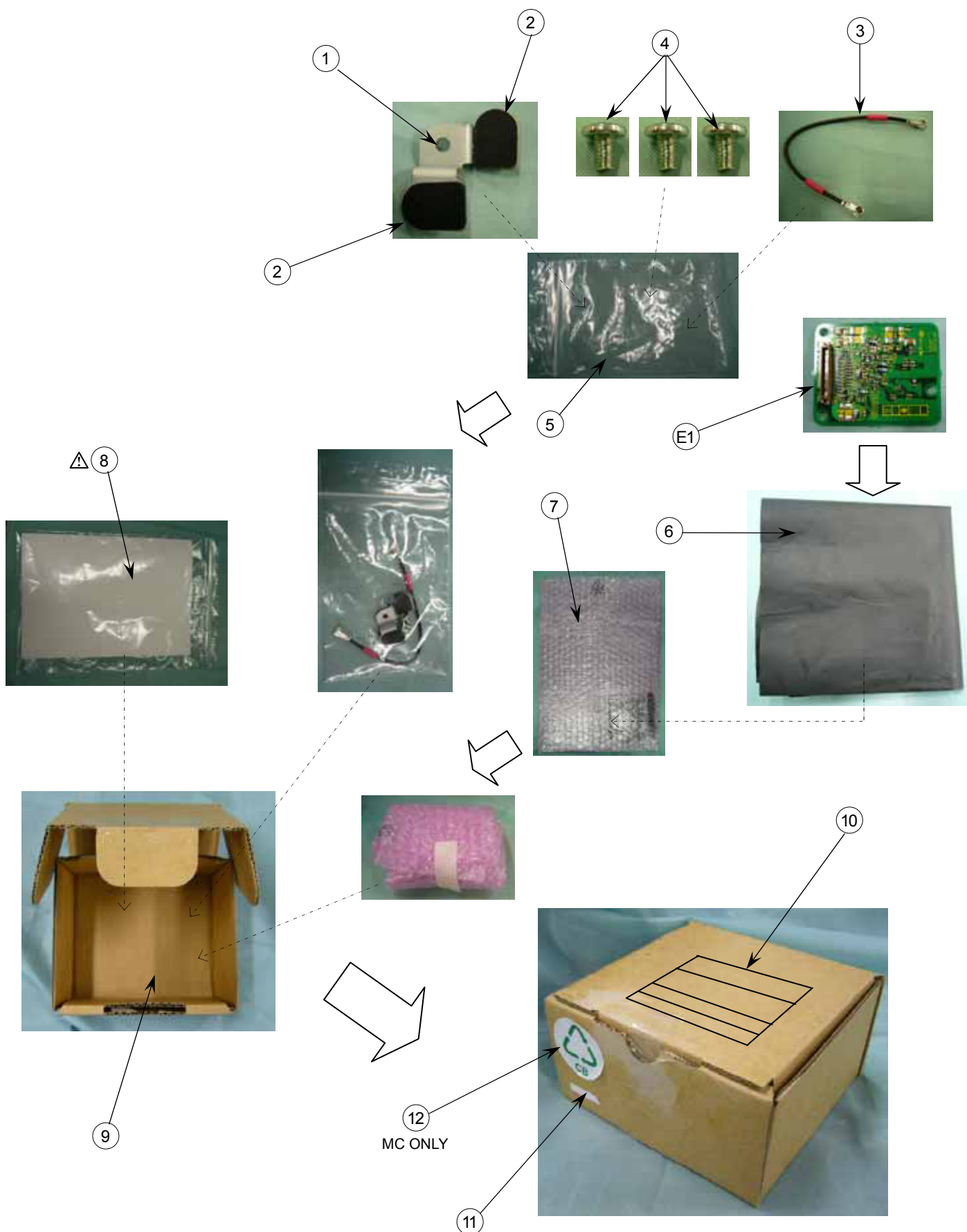

MPL-5



# PACKING PARTS ASSEMBLY (BT-CS80G/MC)

Components identified with the mark  have the special characteristics for safety. When replacing any of these components, use only the same type.

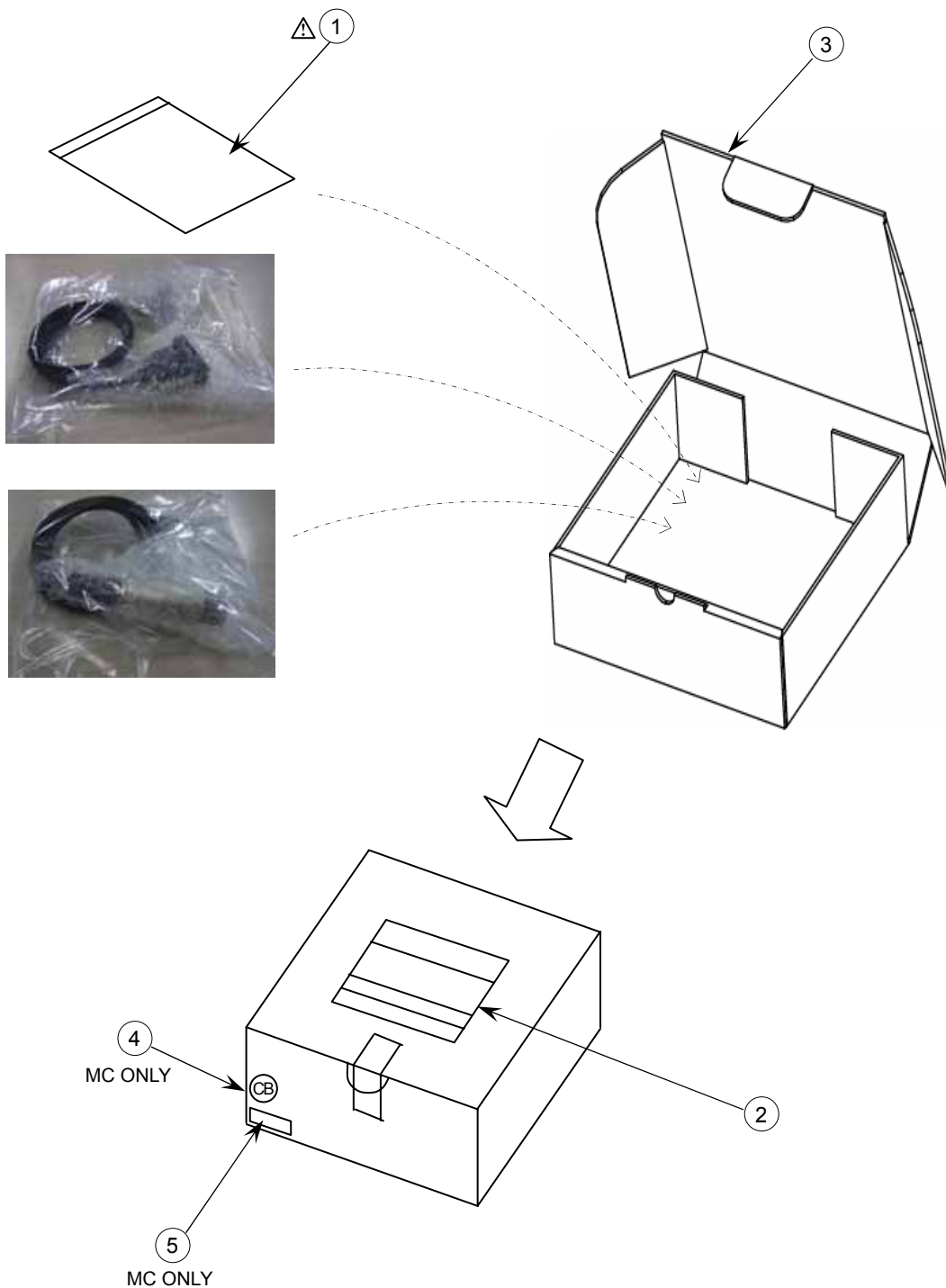





## Free Manuals Download Website

<http://myh66.com>

<http://usermanuals.us>

<http://www.somanuals.com>

<http://www.4manuals.cc>

<http://www.manual-lib.com>

<http://www.404manual.com>

<http://www.luxmanual.com>

<http://aubethermostatmanual.com>

Golf course search by state

<http://golfingnear.com>

Email search by domain

<http://emailbydomain.com>

Auto manuals search

<http://auto.somanuals.com>

TV manuals search

<http://tv.somanuals.com>