

Operating Instructions

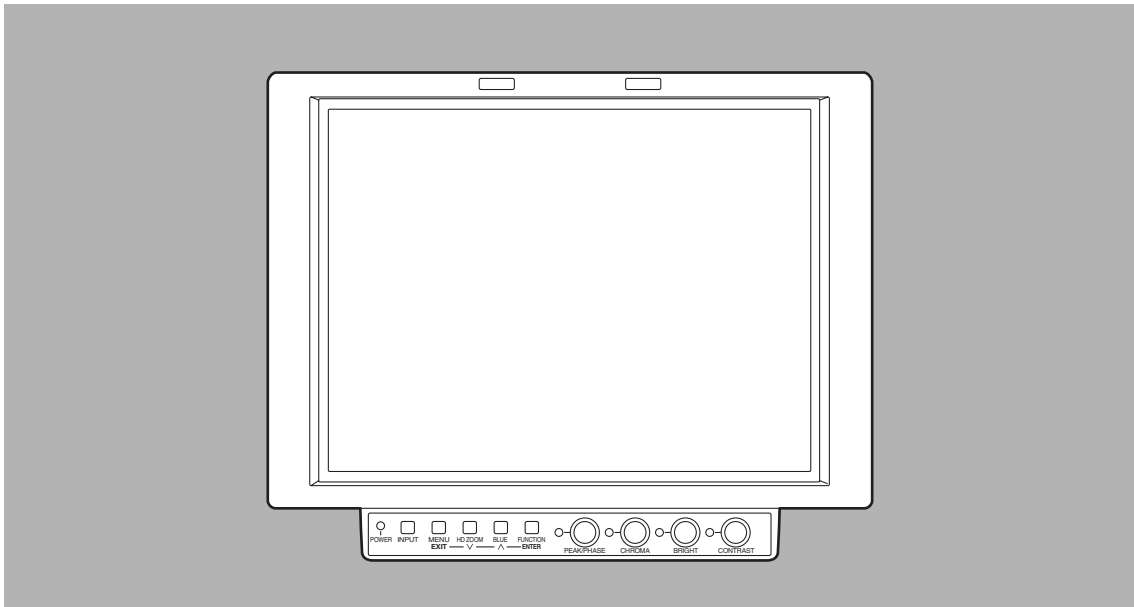

Liquid Crystal Video Monitor
BT-LH900P



Panasonic[®]

Before attempting to connect, operate or adjust this product, please read these instructions completely.

For your safety

	CAUTION RISK OF ELECTRIC SHOCK DO NOT OPEN	
CAUTION: TO REDUCE THE RISK OF ELECTRIC SHOCK, DO NOT REMOVE COVER (OR BACK). NO USER SERVICEABLE PARTS INSIDE. REFER TO SERVICING TO QUALIFIED SERVICE PERSONNEL.		



The lightning flash with arrowhead symbol, within an equilateral triangle, is intended to alert the user to the presence of uninsulated "dangerous voltage" within the product's enclosure that may be of sufficient magnitude to constitute a risk of electric shock to persons.



The exclamation point within an equilateral triangle is intended to alert the user to the presence of important operating and maintenance (service) instructions in the literature accompanying the appliance.

WARNING:

TO REDUCE THE RISK OF FIRE OR SHOCK HAZARD, DO NOT EXPOSE THIS EQUIPMENT TO RAIN OR MOISTURE AND KEEP THIS EQUIPMENT AWAY FROM ALL LIQUIDS—USE AND STORE ONLY IN LOCATIONS WHICH ARE NOT EXPOSED TO THE RISK OF DRIPPING OR SPLASHING LIQUIDS, AND DO NOT PLACE ANY LIQUID CONTAINERS ON TOP OF THE EQUIPMENT.

CAUTION:

TO REDUCE THE RISK OF FIRE OR SHOCK HAZARD AND ANNOYING INTERFERENCE, USE THE RECOMMENDED ACCESSORIES ONLY.

FCC Note:

This device complies with Part 15 of the FCC Rules. To assure continued compliance follow the attached installation instructions and do not make any unauthorized modifications.

This equipment has been tested and found to comply with the limits for a class A digital device, pursuant to Part 15 of the FCC Rules. These limits are designed to provide reasonable protection against harmful interference when the equipment is operated in a commercial environment. This equipment generates, uses, and can radiate radio frequency energy and, if not installed and used in accordance with the instruction manual, may cause harmful interference to radio communications. Operation of this equipment in a residential area is likely to cause harmful interference in which case the user will be required to correct the interference at his own expense.

Notice (U.S.A. only):

This product has a fluorescent lamp that contains a small amount of mercury.

It also contains lead in some components. Disposal of these materials may be regulated in your community due to environmental considerations.

For disposal or recycling information please contact your local authorities, or the Electronics Industries Alliance:

<<http://www.eiae.org>>

CAUTION:

Do not install or place this unit in a bookcase, built-in cabinet or any other confined space in order to maintain adequate ventilation. Ensure that curtains and any other materials do not obstruct the ventilation to prevent risk of electric shock or fire hazard due to overheating.

 indicates safety information.

Contents

Precautions for use	3	User data	14
Introduction	4	MAIN MENU	15
Parts and their functions	5	REMOTE specifications	22
Relocating the main controls	8	Error and warning displays	23
Supplying the power	9	Maintenance	24
Cosmetic screws	10	Maintenance and inspections	24
How to use the on-screen menus ...	11	Specifications	25
Menu operations	13		

Precautions for use

This product has been specially designed for commercial use. As such, it should be used and operated only by persons with related expertise.

- The liquid crystal parts are fabricated using high-precision technology. The screen has effective pixels that cover more than 99.99% of its area, but pixels may be missing or remain permanently lighted (red, blue and/or green) in less than 0.01% of the area. This is not indicative of malfunctioning.
- The panel which protects the liquid crystal display has been specially treated.
Do not wipe it with hard cloths or rub it heavily as this will damage the surface of the panel.
- If a still image is displayed continuously for a long period of time, the image may be burnt onto the screen for some time. (The shadow of the image will usually disappear after moving images are displayed for while.)
- The response speed and brightness of the liquid crystals will vary with the surrounding temperature.

Introduction

Designed for use in broadcasting and commercial applications, the model BT-LH900P is a slim-line and lightweight liquid crystal video monitor with an 8.4-type liquid crystal screen.

For use, secure it in place by, for instance, installing it in a rack by using the optional rack-mounting adaptors BT-MA900G or mounting it on a tripod. (For details, refer to the instructions in the operation guide of the BT-MA900G.)

■ Slim design, light weight, compact size, low power consumption and driven by DC power

Since this monitor uses an LCD panel, it has a slim design, light weight and compact size. Furthermore, while supporting HD specifications, it has a low power consumption, and it can be operated using DC power: these are all features which make the monitor useful in outdoor locations.

■ Multiple formats supported

In addition to its two lines of SDI input connectors (automatic HD/SD switching), the monitor provides one line each of component input connectors and composite input connectors.

■ Wide viewing angle

The monitor can display excellent images over an angle extending for 170 degrees in both the top-bottom and left-right directions.

■ High-definition images

At 1024 × 768 dots (XGA), the large number of screen pixels ensures a high color reproducibility and tonal range.

■ Functions

The main controls can be relocated to the bottom surface or right panel of the main unit to support monitor specifications, viewfinder specifications and other applications.

- The monitor comes with a film gamma correction function to support its use as the viewfinder for the AJ-HDC27F. (For further details, consult with your dealer or a Panasonic Service Center.)
- Waveform monitor functions provided
- Marker functions and blue-only function incorporated
- RS-232C external control, remote control using GPI connector enabled

■ Outline diagrams of monitor as seen from three sides

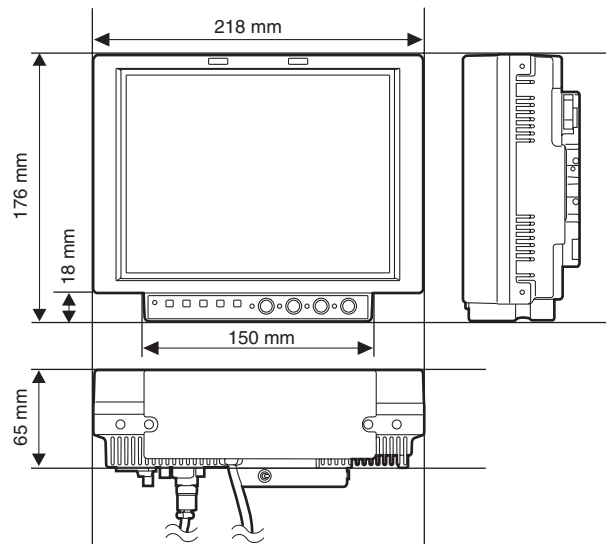

Parts and their functions

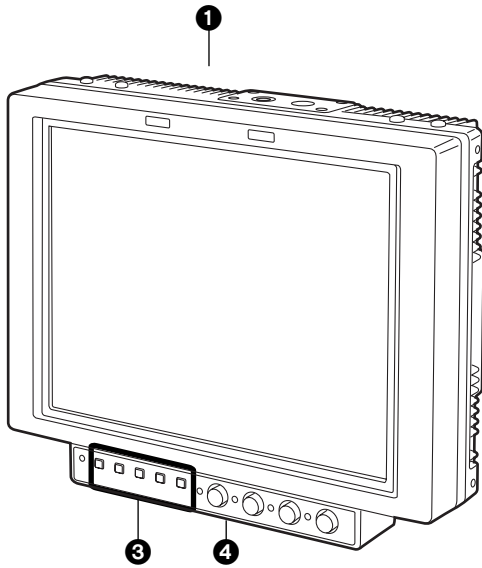

① Tally lamps

In the above illustration, the R (red) tally lamp is shown on the left and the G (green) lamp appears on the right. These tally lamps can be lighted by initiating the GPI ON/OFF operation.

<Note>

When the monitor is used outdoors, it may be hard to see that the tally lamps are in fact lighted.

② Power LED

This is the power LED. It lights while the power is ON.

③ Function buttons

① INPUT button

This button is used to select the signal input. Each time it is pressed, the input channels are switched by one setting in the following sequence: SDI 1 → SDI 2 → VIDEO → YPBPR/RGB.

By means of the INPUT menu settings, the unused channels can be skipped.

② MENU/EXIT button

This button is used to display the menus. When it is pressed while a menu is already displayed, the menu display is cleared or the menu at one hierarchical level above is restored.

When the button is pressed while a setting is being changed, the setting established prior to the change is restored, and the menu at one hierarchical level above is restored.

③ HD ZOOM/∨ button

This button is used to move the cursor or change settings while a menu is displayed.

If there is no menu display, it turns the HD ZOOM function ON or OFF. When the button is pressed, both the left and right sides of the images with a 16:9 aspect ratio produced by HD signals are cut off, and images with a 4:3 aspect ratio are displayed on the entire screen. When it is pressed, the original images are restored.

The HD zoom function does not work when images of SD signals are displayed.

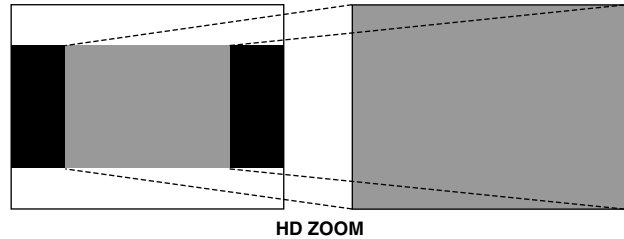

④ BLUE/∧ button

This button is used to move the cursor or change settings while a menu is displayed.

If there is no menu display, it turns the blue-only function ON or OFF. When this function is set to ON, only the blue components among the RGB components are displayed.

Parts and their functions

⑤ FUNCTION/ENTER button

This button is used to enter changes or settings while a menu is displayed.

If there is no menu display, the button's function changes depending on which FUNCTION item on the menu is selected. One of the following three items can be selected. (Refer to page 19)

UNDEF: No function is allocated to this item.

HV DELAY: Image blanking is displayed. Each time the button is pressed, the blanking display is switched by one setting in the following sequence: H blanking display → V blanking display → H and V blanking display → no blanking display.

WFM ON/OFF: The Y signal (luminance) waveform is displayed at the bottom right of the image. When the button is pressed again, the display is cleared.

When waveforms are displayed in the 16:9 mode, the image displayed on the screen moves to the upper part of the screen so that it will not be superimposed onto the waveform display.

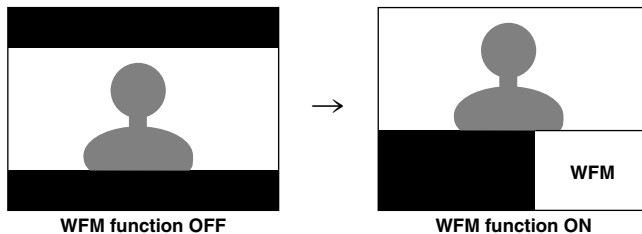

The image remains unchanged in the 4:3 mode.

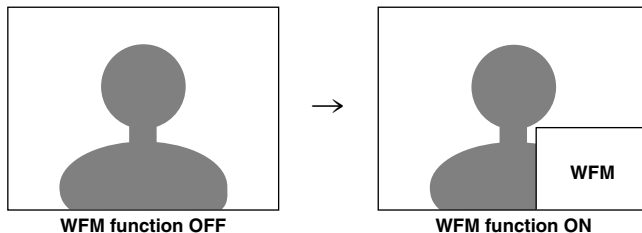

<Notes>

- In order for this function to be used, it is necessary to select WFM as the FUNCTION item setting on the SYSTEM CONFIG screen, and then select FUNCTION as the WFM item setting.
- The WFM function is a simplified one and, as such, finely detailed waveforms may not be displayed accurately. In addition, differences in the input signal format or input function may result in the display having a different horizontal width.

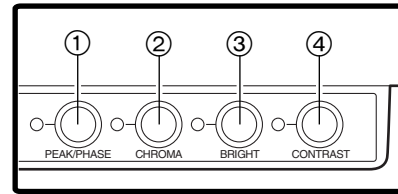

④ Image controls

These controls are used to adjust the peaking/color phase, chroma, brightness and contrast. When a control is pushed in, it pops out to enable adjustment. When a numerical value is changed from the default setting, the lamp to the left of the control lights.

The adjustments performed using these controls are valid only when the controls are in the "out" position, and when a control is pushed back in, the value adjusted by that control is returned to its default setting.

① PEAK/PHASE (PEAKING/PHASE)

This control is used to adjust the peaking or phase. Which of these is to be adjusted is set using the PEAKING/PHASE item on the SYSTEM CONFIG screen.

• PEAKING

This function is selected when the monitor is to be used as a viewfinder.

It is used to set the edge sharpness. Any value from 0 to 30 can be set: the higher the value, the sharper the edges. The default setting is 0.

• PHASE

This function is selected when the monitor is to be used as a monitor.

It is used to set the color phase of the screen. Any value from 0 to 60 can be set. The default setting is 30.

<Notes>

- When the blue-only function is ON, the control functions as the PHASE control regardless of the setting.
- The color phase cannot be adjusted when RGB signals are input.

② CHROMA

This control is used to adjust the image chroma. Any value from 0 to 60 can be set. The default setting is 30.

<Note>

The chroma cannot be adjusted when RGB signals are input or when the MONO setting is ON.

③ BRIGHT

This control is used to adjust the image brightness. Any value from 0 to 60 can be set. The default setting is 30.

However, the brightness cannot be adjusted when blanking is displayed using the HV DELAY function.

④ CONTRAST

This control is used to adjust the image contrast. Any value from 0 to 60 can be set. The default setting is 50.

Parts and their functions

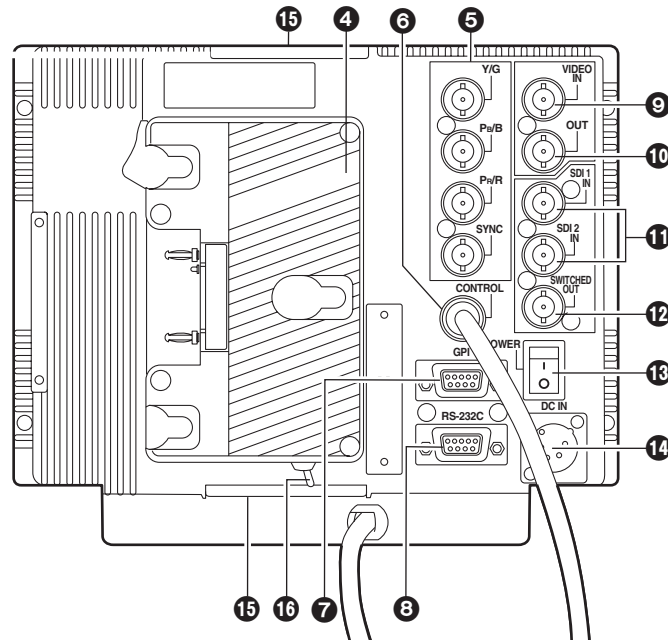

4 Battery holder

This holder is used with a battery made by Anton Bauer.

5 Analog component/RGBS connectors

These are the BNC input connectors for the analog component (Y/Pb/Pr) or RGBS signals. When RGB signals are supplied, external sync (gen-lock) can also be used.

6 Main controls dedicated connector

The cable from the main controls is connected here.

<Note>

The monitor is shipped with the cable disconnected from the connector. Prior to use, therefore, check out the shape of the cable connector and plug it properly into this connector.

7 GPI connector

When GPI signals are connected here, external operations can be performed.

8 RS-232C connector

External operations can be performed under the RS-232C standard.

9 VIDEO IN connector

The video input signals are supplied to this connector.

10 VIDEO OUT connector

The video signals are output from this connector. Signals are passed through the 9 VIDEO IN connector and output from this connector.

11 SDI input connectors

The SDI input signals are supplied to these connectors which support automatic HD/SD switching.

12 SDI output connector

The SDI signals are output from this connector. It is the switched output of the 11 SDI input connectors.

The signals displayed on the screen, whether they are the ones supplied to the SDI 1 connector or SDI 2 connector, are output.

However, the switched output signals are not output when the component or video input signals have been selected.

13 Power switch

This is the power switch.

14 External DC power socket

The external DC power source is connected here. When a DC power supply is connected concurrently with the battery, the external power input takes precedence.

15 Tripod fastening screws

Two screws (UNC3/8-16 compatible) for securing a tripod are provided each on the top of the monitor and at its bottom where the main controls are removed.

A removable screw spacer is provided in one of the screw holes in the bottom of the monitor, and this supports a UNC1/4-20 screw. To secure the tripod, use the hole that fits the diameter of the fastening screw on the tripod.

16 Light control switch

This is not used on this monitor.

Relocating the main controls

The main controls can be relocated to the bottom surface or right panel of the monitor depending on such factors as where and how the monitor will be used.

<Note>

Before relocating the main control, make absolutely sure that the power has been turned off.

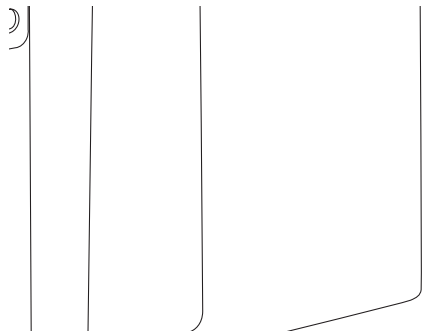

Sup

An Anton

1 Install

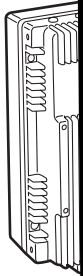

2 Insert battery pack and  the direction of the arrow

to
re

Dir

Supplying the power

Using an AC power supply

- 1 Connect the DC OUT connector on the AJ-B75 AC adapter to the DC IN socket on the unit.

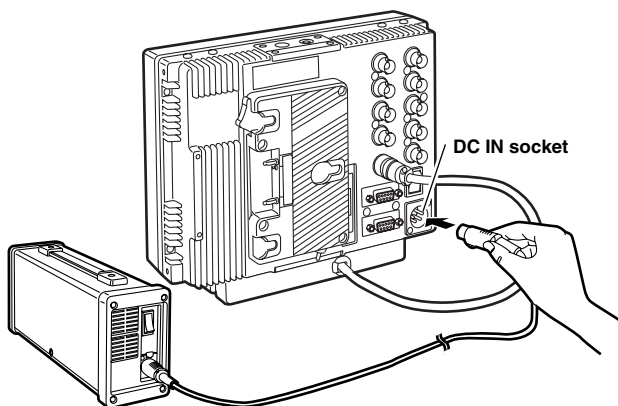

AC adapter
AJ-B75 (optional accessory)

- 2 Set the power of the AC adapter to ON.

- 3 Set the unit's power switch to ON.
When using an external power supply other than the AJ-B75 AC adapter, check the pin signals of its external DC input connector and use the polarities correctly.

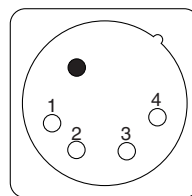

External DC input socket

Pin no.	Signal
1	GND
2, 3	-
4	+12V

<Notes>

- Power from the AC adapter takes precedence when both a battery pack and AC adapter have been connected. It is also possible to attach/remove a battery while the AC adapter is being used.
- When using the AC adapter, be absolutely sure to first set the power of the AC adapter to ON and then set the unit's power switch to ON.
- A voltage of 20V or more will not be indicated accurately on the battery voltage display.

Cosmetic screws

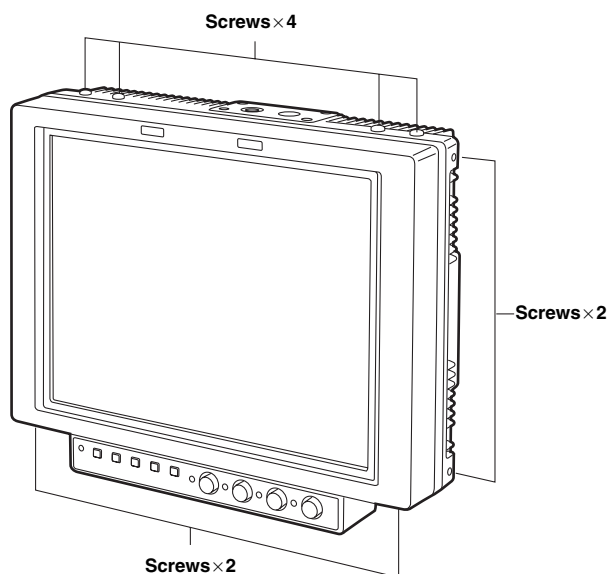

A total of eight cosmetic screws are provided with the monitor for use at such times when the main controls have been relocated. (Refer to page 8)

Since these screws also serve to protect the internal mechanisms, do not leave the screw holes empty but place the screws inside them and tighten them up. Any screws which are not being used should be kept in a safe place.

How to use the on-screen menus

Four kinds of information—menus, status displays, image control settings and battery voltage—can be displayed on the screen.

Menu display

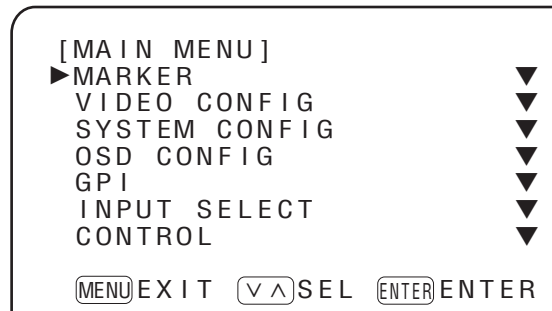

This display appears when the MENU/EXIT button is pressed. If no further action is taken for the next 120 seconds, the display will be automatically cleared.

The position where the display appears on the screen can be changed using the marker setting.

For details on the menu, refer to "MAIN MENU" (page 15).

Status display

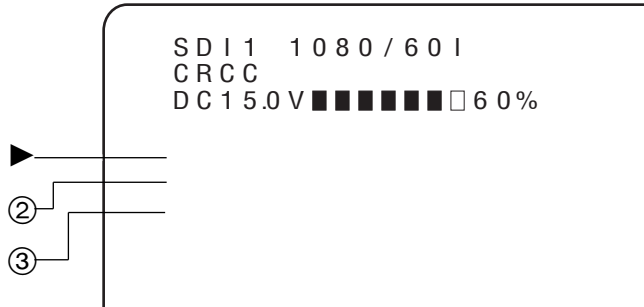

① Channel and signal format

The channel which has been selected—whether SDI 1, SDI 2, VIDEO, YPBPR or RGB—is displayed here.

Indicated as the signal format is the format of the signals which have been input. However, "UNSUPPORTED SIGNAL" will appear if signals which are not supported have been input.

Similarly, "UNSUPPORTED SIGNAL" will also appear if signals not selected as the FORMAT item setting on the INPUT SELECT screen of the main menu are input even when those signals are supported.

For details on the signals supported and format displays, refer to page 12.

The status display information is displayed under the following conditions while the menu display is not on the screen.

- When the input signals have been switched
- When the input channel has been changed
- When no signals are supplied

The display location and display time can be changed using the menu settings. When images are adjusted using the image controls while the status display information is on the screen, the display is cleared, and the settings adjusted by the controls are displayed instead.

② Warning display

This appears when an error has occurred or when a special mode is being used.

CRCC This indicates a CRCC error, and it appears when the SDI signals contain an error.

FILM This appears when the film mode (FILM) has been selected as the GAMMA SELECT item setting on the VIDEO CONFIG screen of the main menu.

REMOTE This appears when REMOTE has been selected as the CONTROL item setting on the CONTROL screen of the main unit. The monitor controls will no longer function at this time.

③ Battery voltage display

This indicates the voltage level of the battery. If an Anton Bauer digital battery is being used, its remaining level is indicated as a number of "[/]" blocks and as a percentage along with the voltage value.

How to use the on-screen menus

Image control display



The image control information is displayed when an image has been adjusted using the image controls. (Refer to page 6)

It appears when a control has been pressed in so that it has popped out or when an adjustment is made by turning an already popped out control.

It is cleared when a control is pressed again and returned to its original position. It is also cleared when a popped out control is not touched for 10 seconds.

Battery voltage display



The battery voltage information is displayed all the time when ON has been selected as the BATTERY REMAIN item setting on the OSD screen of the main menu.

It indicates the voltage level of the battery. If an Anton Bauer digital battery is being used, its remaining level is indicated as a number of "■" blocks and as a percentage along with the voltage value.

Concerning the signal formats

Menu setting	Signals whose input is accepted	Status display
AUTO	All supported signals	The format of the input signals is displayed.
1080/60I	1080/60I	1080/60I
	1080/59.94I	1080/59.94I
1080/50I	1080/50I	1080/50I
1080/30P	1080/30P	1080/30P
	1080/29.97P	1080/29.97P
1080/25P	1080/25P	1080/25P
1080/24P	1080/24P	1080/24P
	1080/23.98P	1080/23.98P
1080/24PsF	1080/24PsF	1080/24PsF
	1080/23.98PsF	1080/23.98PsF
1035/60I	1035/60I	1035/60I
	1035/59.94I	1035/59.94I
720/60P	720/60P	720/60P
	720/59.94P	720/59.94P
720/60P ANAMO	720/60P	720/60P
	720/59.94P	720/59.94P
576/50I	576/50I	576/50I
480/60P	480/59.94P	480/60P
480/60I	480/59.94I	480/60I
NTSC	NTSC	NTSC
PAL	PAL	PAL

Menu operations

Menu operations

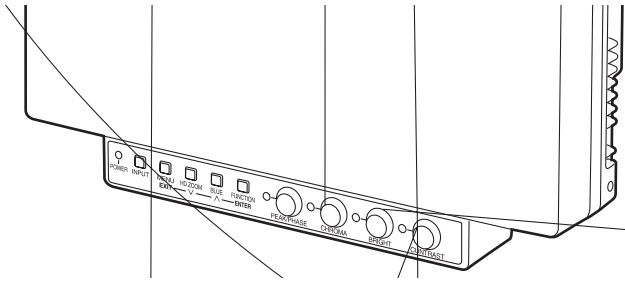

User data

This monitor enables the menu settings and screen values which have been adjusted by the image controls to be saved in five user data files which can then be loaded as required.

The following data can be saved and loaded as user data files:

- All menu settings (including the function settings of the buttons at the front of the monitor) with the exception of USER MODE LOAD/SAVE
- Screen values which have been adjusted by the image controls

Saving the user data

- 1 When the MENU/EXIT button is pressed, the main menu appears on the screen.
- 2 Using menu operations (see page 13), select USER MODE SAVE on the SYSTEM CONFIG screen, and press the FUNCTION/ENTER button. The setting is now displayed in green.

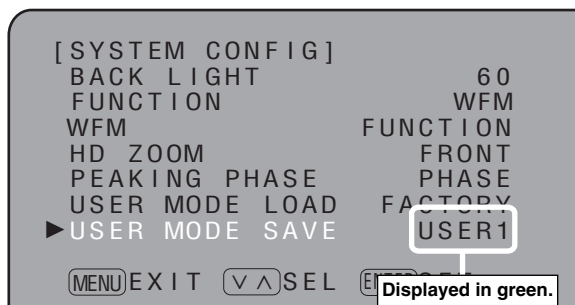

- 3 When the file whose data is to be saved is selected from the USER1 to USER5 files and the FUNCTION/ENTER button is then pressed, the screen shown below appears.

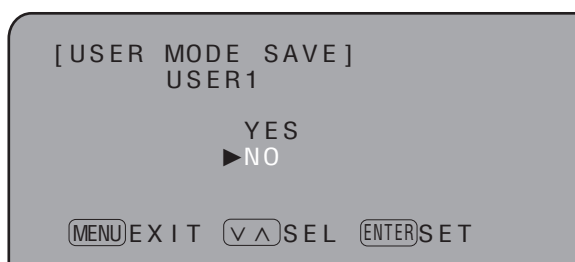

- 4 Align the cursor with YES, and press the FUNCTION/ENTER button.

Loading the user data

- 1 When the MENU/EXIT button is pressed, the main menu appears on the screen.
- 2 Using menu operations (see page 13), select USER MODE LOAD on the SYSTEM CONFIG screen, and press the FUNCTION/ENTER button. The setting is now displayed in green.

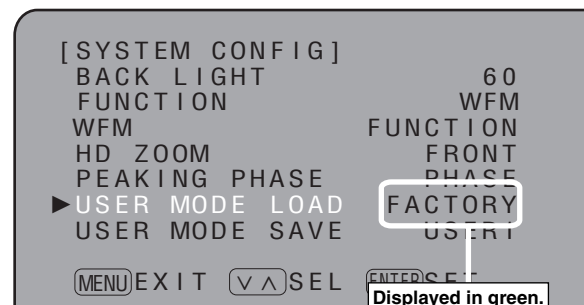

- 3 When the file whose data is to be loaded is selected from the FACTORY or USER1 to USER5 files and the FUNCTION/ENTER button is then pressed, the screen shown below appears. If FACTORY is selected at this time, the data is restored to the factory settings.

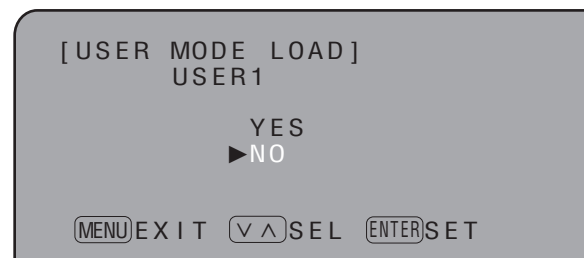

- 4 Align the cursor with YES, and press the FUNCTION/ENTER button.

MAIN MENU

Menu configuration

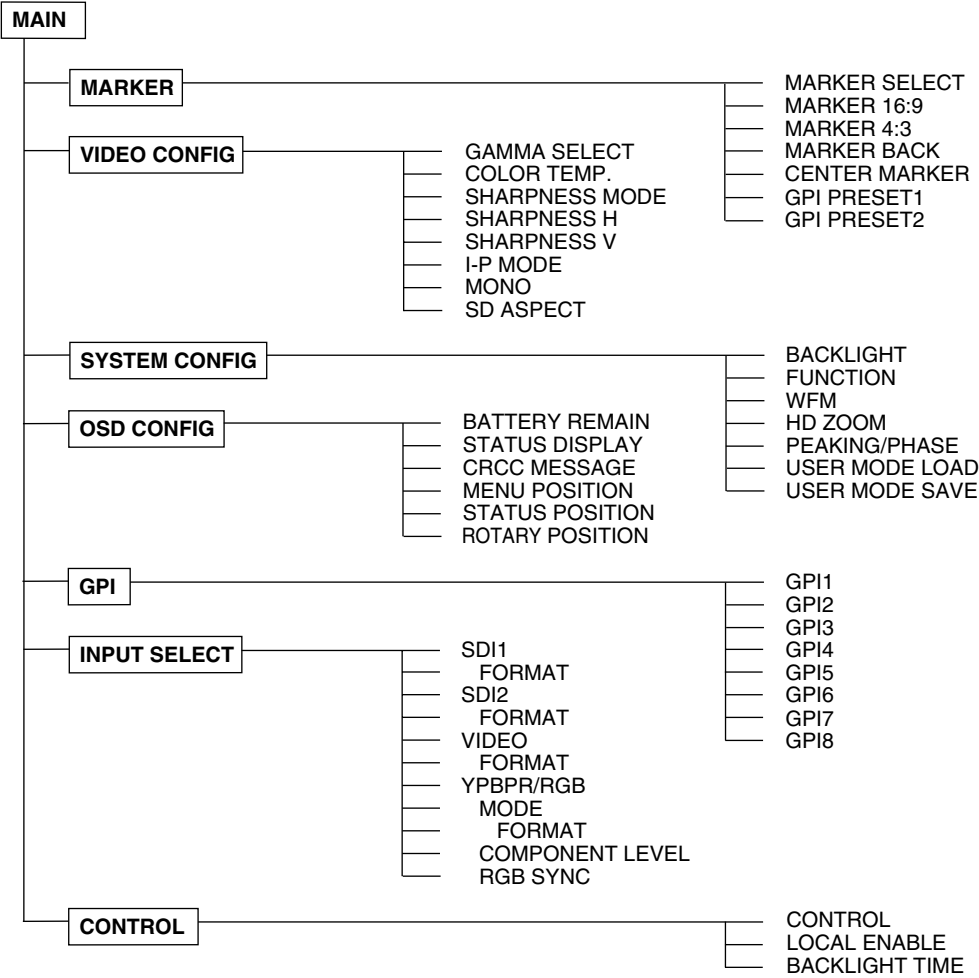

MAIN MENU

Menu items

MARKER

Item	Setting	Description
MARKER SELECT	<u>MENU</u> GPI	For setting whether the marker display settings are to be performed using the menu or from the GPI connector. MENU: The operations are performed using the menu. Operations from the GPI connector are canceled. GPI: The operations are performed from the GPI connector. The settings established using the menu are canceled.
MARKER 16:9	<u>OFF</u> 4:3 13:9 14:9 95% 93% 88% 80%	For selecting the type of marker used for 16:9 images. OFF: No markers are displayed. 4:3: Markers indicating the 4:3 size are displayed. 13:9: Markers indicating the 13:9 size are displayed. 14:9: Markers indicating the 14:9 size are displayed. 95%: The 95% area markers are displayed. 93%: The 93% area markers are displayed. 88%: The 88% area markers are displayed. 80%: The 80% area markers are displayed. <Note> When 4:3 images are displayed, the setting of this item is not reflected.
MARKER 4:3	<u>OFF</u> 95% 93% 88% 80%	For selecting the type of marker used for 4:3 images. OFF: No markers are displayed. 95%: The 95% area markers are displayed. 93%: The 93% area markers are displayed. 88%: The 88% area markers are displayed. 80%: The 80% area markers are displayed. <Note> When 16:9 images are displayed, the setting of this item is not reflected.
MARKER BACK	<u>NORMAL</u> HALF BLACK	For setting the background brightness of the markers. NORMAL: The background is set to the normal brightness. HALF: The background brightness is set to 50%. BLACK: The background brightness is set to 0%. <Note> The setting of this item is valid only when 4:3, 13:9 or 14:9 has been selected as the MARKER 16:9 item setting.
CENTER MARKER	<u>OFF</u> ON	For selecting whether to display the center marker. OFF: The center marker is not displayed. ON: The center marker is displayed.

Item	Setting	Description
GPI PRESET1	4:3 13:9 14:9 95% 93% 88% <u>80%</u>	For setting the markers to be displayed if, when MARKER1 ON/OFF has been allocated to any item and GPI has been selected as the MARKER SELECT item setting on the GPI screen, the corresponding pin has been set to ON. For details, refer to "REMOTE specifications" (page 22). 4:3: Markers indicating the 4:3 size are displayed. 13:9: Markers indicating the 13:9 size are displayed. 14:9: Markers indicating the 14:9 size are displayed. 95%: The 95% area markers are displayed. 93%: The 93% area markers are displayed. 88%: The 88% area markers are displayed. 80%: The 80% area markers are displayed.
GPI PRESET2	4:3 13:9 14:9 95% 93% 88% <u>80%</u>	For setting the markers to be displayed if, when MARKER2 ON/OFF has been allocated to any item and GPI has been selected as the MARKER SELECT item setting on the GPI screen, the corresponding pin has been set to ON. For details, refer to "REMOTE specifications" (page 22). 4:3: Markers indicating the 4:3 size are displayed. 13:9: Markers indicating the 13:9 size are displayed. 14:9: Markers indicating the 14:9 size are displayed. 95%: The 95% area markers are displayed. 93%: The 93% area markers are displayed. 88%: The 88% area markers are displayed. 80%: The 80% area markers are displayed.

The underlined setting indicates the factory setting mode.

MAIN MENU

Types of markers

16:9 markers

(These appear when HD signals or when SD signals with a 16:9 aspect ratio are supplied.)

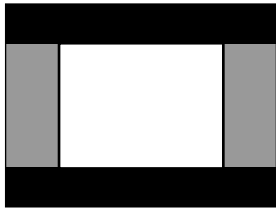

4:3 markers



13:9 markers



14:9 markers

Markers are displayed only in the form of vertical lines. The shaded areas  indicate what is set by the MARKER BACK item.

4:3 markers

(These appear when SD signals with a 4:3 aspect ratio are supplied.)



95% area markers



93% area markers

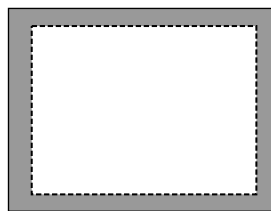

88% area markers

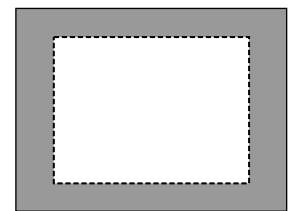

80% area markers

Dotted lines are displayed as the markers.

Center marker

This appears at the center of the image.

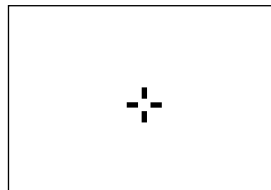

Center marker



95% area markers

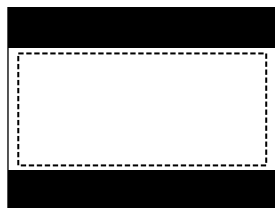

93% area markers

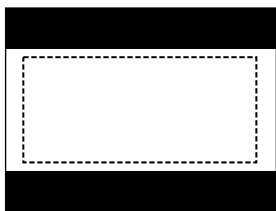

88% area markers

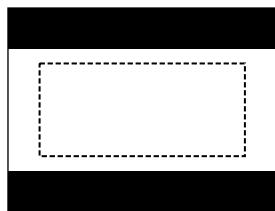

80% area markers

Dotted lines are displayed as the markers.

MAIN MENU

VIDEO CONFIG

Item	Setting	Description
GAMMA SELECT	GPI <u>NORMAL</u> FILM	For setting the gamma mode. GPI: This is the GPI setting. For details, refer to "REMOTE specifications" (page 22). NORMAL: The normal gamma mode is established. FILM: The film mode that supports the Varicam digital cine camera is established.
COLOR TEMP.	USER D93 <u>D65</u> D56	For setting the color temperature. USER: Any setting from 0 to 63 (equivalent to a color temperature range from 3000 K to 9300 K) can be established. D93: This is equivalent to a color temperature of 9300 K. D65: This is equivalent to a color temperature of 6500 K. D56: This is equivalent to a color temperature of 5600 K. <Note> The color temperature can be set for each gamma mode (NORMAL, FILM).
SHARPNESS MODE	HIGH <u>LOW</u>	For setting the image sharpness. HIGH: The images are accentuated with fine edges. LOW: The images are accentuated with thick edges. <Note> The sharpness can be set for VIDEO and all other input channels.
SHARPNESS H	0 : <u>2</u> : 30	For setting the image sharpness in the horizontal direction. This item enables two settings, one for the VIDEO input signals and one for other signals, to be stored in the memory. <Notes> • While this item's setting is selected, the only information displayed on the screen is this item which appears at the bottom left regardless of the MENU POSI setting selected on the OSD screen. • The sharpness can be set for VIDEO and all other input channels.
SHARPNESS V	0 : <u>2</u> : 30	For setting the image sharpness in the vertical direction. This item enables two settings, one for the VIDEO input signals and one for other signals, to be stored in the memory. <Notes> • While this item's setting is selected, the only information displayed on the screen is this item which appears at the bottom left regardless of the MENU POSI setting selected on the OSD screen. • The sharpness can be set for VIDEO and all other input channels.

Item	Setting	Description
I-P MODE	MODE2 <u>MODE1</u>	For switching the IP conversion mode. MODE2: Movement compensation mode MODE1: Normal mode <Note> This setting takes effect when progressive signals (1080/30P, 1080/25P, 1080/24P, 720/60P or 480/60P) are input.
MONO	GPI <u>OFF</u> ON	For selecting monochrome images. GPI: This is the GPI setting. For details, refer to "Concerning the REMOTE specifications" (page 22). OFF: Normal images ON: Monochrome images <Notes> • No adjustments are possible when RGB signals are input. • When ON has been selected as this item's setting, the setting for the CHROMA image control is fixed at 0. When the setting is returned to OFF, the CHROMA setting prior to the change is restored.
SD ASPECT	GPI 16:9 <u>4:3</u>	For setting the aspect ratio of the SD signals. GPI: This is the GPI setting. For details, refer to "REMOTE specifications" (page 22). 16:9: The images are displayed with a 16:9 aspect ratio. 4:3: The images are displayed with a 4:3 aspect ratio.

The underlined setting indicates the factory setting mode.

MAIN MENU

SYSTEM CONFIG

Item	Setting	Description
BACKLIGHT	0 : <u>60</u>	For adjusting the backlight brightness to a level from 0 to 60. The higher the setting, the brighter the backlight.
FUNCTION	<u>WFM</u> ON/OFF HV DELAY UNDEF	For setting the function to be allocated to the FUNCTION/ENTER button. WFM ON/OFF: The Y signal (luminance) waveforms are displayed. HV DELAY: The blanked parts of the images are displayed. UNDEF: No function is allocated.
WFM	<u>FUNCTION</u> GPI	For selecting whether the Y signal (luminance) waveforms are to be displayed using the FUNCTION/ENTER button or from the GPI connector. FUNCTION: The waveforms are displayed using the FUNCTION/ENTER button. GPI: The operations are performed from the GPI connector. For details, refer to "REMOTE specifications" (page 22).
HD ZOOM	<u>FRONT</u> GPI	For selecting whether the HD ZOOM function is to be operated using the HD ZOOM/√ button or from the GPI connector. FRONT: The function is operated using the HD ZOOM/√ button. GPI: The operations are performed from the GPI connector. For details, refer to "REMOTE specifications" (page 22).
PEAKING/ PHASE	<u>PEAKING</u> PHASE	For selecting the PEAKING or PHASE function for the image control. PEAKING: The PEAKING function is allocated to the control. PHASE: The PHASE function is allocated to the control.
USER MODE LOAD	USER5 USER4 USER3 USER2 USER1 <u>FACTORY</u>	For calling the file in which the user data is stored. USER1-5: These are the files in which the user has stored data. If the user data has not yet been stored, the settings are the same as the ones in the FACTORY file. FACTORY: This file contains the factory settings.
USER MODE SAVE	USER5 USER4 USER3 USER2 USER1	For saving the user data.

The underlined setting indicates the factory setting mode.

OSD CONFIG

Item	Setting	Description
BATTERY REMAIN	OFF ON	For selecting whether to display the remaining battery charge. OFF: The remaining charge is not displayed. ON: The remaining charge is displayed.
STATUS DISPLAY	CONTINUE <u>3SEC_OFF</u> OFF	For setting how long the status display is to remain on the screen. CONTINUE: The status display appears continuously at all times. 3SEC.OFF: The status display appears for three seconds. OFF: The status display does not appear.
CRCC MESSAGE	OFF <u>ON</u>	For selecting whether a message is to be displayed when a CRCC error has been detected. OFF: A CRCC error message is not displayed. ON: A CRCC error message is displayed.
MENU POSITION	<u>LT</u> CENTER LB RB RT	For setting the menu display position. LT: The menu is displayed at the top left. CENTER: The menu is displayed in the center. LB: The menu is displayed at the bottom left. RB: The menu is displayed at the bottom right. RT: The menu is displayed at the top right.
STATUS POSITION	<u>LT</u> CENTER LB RB RT	For setting the status display position. LT: The menu is displayed at the top left. CENTER: The menu is displayed in the center. LB: The menu is displayed at the bottom left. RB: The menu is displayed at the bottom right. RT: The menu is displayed at the top right.
ROTARY POSITION	LB CB RB RT LT CENTER OFF	For setting the display position of the settings when images have been adjusted using the image controls. LB: The settings are displayed at the bottom left. CB: The settings are displayed below the center. RB: The settings are displayed at the bottom right. RT: The settings are displayed at the top right. LT: The settings are displayed at the top left. CENTER: The settings are displayed in the center. OFF: The settings are not displayed.

GPI

Item	Setting	Description
GPI1-8	UNDEF MARKER1 ON/OFF MARKER2 ON/OFF MARKER BACK HALF MARKER BACK BLACK CENTER MARKER INPUT SEL. SD11 INPUT SEL. SD12 INPUT SEL. VIDEO INPUT SEL. YPBPR/RGB SD ASPECT HD ZOOM BACKLIGHT MIN. R.TALLY G.TALLY MONO ON/OFF GAMMA SELECT WFM ON/OFF	For allocating particular functions to particular pins when remote control operations are to be performed using the GPI signals. For details, refer to "REMOTE specifications" (page 22).

MAIN MENU

INPUT SELECT

Item	Setting	Description
SDI1 *	OFF <u>ON</u>	For setting whether the SDI 1 signals can be selected when the channels are to be switched using the INPUT button. OFF: The SDI 1 signals cannot be selected. ON: The SDI 1 signals can be selected.
FORMAT	<u>AUTO</u> 1080/60I 1080/50I 1080/30P 1080/25P 1080/24P 1080/24PsF 1035/60I 720/60P 720/60P ANAMO 576/50I 480/60I	For selecting the signals whose input is to be accepted at the SDI 1 connector. AUTO: All supported signals are accepted. 1080/60I: 1080/60I or 1080/59.94I format signals are accepted. 1080/50I: 1080/50I format signals are accepted. 1080/30P: 1080/30P or 1080/29.97P format signals are accepted. 1080/25P: 1080/25P format signals are accepted. 1080/24P: 1080/24P or 1080/23.98P format signals are accepted. 1080/24PsF: 1080/24PsF or 1080/23.98PsF format signals are accepted. 1035/60I: 1035/60I or 1035/59.94I format signals are accepted. 720/60P: 720/60P or 720/59.94P format signals are accepted. 720/60P ANAMO: 720/60P or 720/59.94P format signals which support an anamorphic lens are accepted. 576/50I: 576/50I format signals are accepted. 480/60I: 480/59.94I format signals are accepted.

Item	Setting	Description
SDI2 *	OFF <u>ON</u>	For setting whether the SDI 2 signals can be selected when the channels are to be switched using the INPUT button. OFF: The SDI 2 signals cannot be selected. ON: The SDI 2 signals can be selected.
FORMAT	<u>AUTO</u> 1080/60I 1080/50I 1080/30P 1080/25P 1080/24P 1080/24PsF 1035/60I 720/60P 720/60P ANAMO 576/50I 480/60I	For selecting the signals whose input is to be accepted at the SDI 2 connector. The setting selection is the same as for the SDI 1 FORMAT item.
VIDEO *	OFF <u>ON</u>	For setting whether the VIDEO signals can be selected when the channels are to be switched using the INPUT button. OFF: The VIDEO signals cannot be selected. ON: The VIDEO signals can be selected.
FORMAT	<u>AUTO</u> NTSC PAL	For selecting the signals whose input is to be accepted at the VIDEO connector. AUTO: All supported signals are accepted. NTSC: NTSC signals are accepted. PAL: PAL signals are accepted.
YPBPR *	OFF <u>ON</u>	For setting whether the YPBPR/RGB signals can be selected when the channels are to be switched using the INPUT button. OFF: The YPBPR/RGB signals cannot be selected. ON: The YPBPR/RGB signals can be selected.
MODE	<u>YPBPR</u> RGB	For switching between the YPBPR and RGB analog signals. YPBPR: The analog signals are switched to Y/Pb/Pr. RGB: The analog signals are switched to RGB.

*1 Up to three of these items can be set to OFF at the same time. Once the three items have been set to OFF, it is no longer possible to set a fourth item to OFF. It is not possible to set all the inputs to OFF.

The underlined setting indicates the factory setting mode.

MAIN MENU

INPUT SELECT

Item	Setting	Description
FORMAT	<u>AUTO</u> 1080/60I 1080/50I 1080/30P 1080/25P 1080/24P 1080/24PsF 1035/60I 720/60P 576/50I 480/60P 480/60I	<p>For selecting the signals whose input is to be accepted in the YPBPR mode and in the RGB mode.</p> <p>The signals can be set for each mode, and when the MODE item setting is switched from YPBPR to RGB or vice versa, the mode is automatically switched so that the signal format which has been set for the mode now set is accepted.</p> <p>AUTO: All supported signals are accepted.</p> <p>1080/60I: 1080/60I or 1080/59.94I format signals are accepted.</p> <p>1080/50I: 1080/50I format signals are accepted.</p> <p>1080/30P: 1080/30P or 1080/29.97P format signals are accepted. (This setting takes effect only when YPBPR is selected.)</p> <p>1080/25P: 1080/25P format signals are accepted. (This setting takes effect only when YPBPR is selected.)</p> <p>1080/24P: 1080/24P or 1080/23.98P format signals are accepted. (This setting takes effect only when YPBPR is selected.)</p> <p>1080/24PsF: 1080/24PsF or 1080/23.98PsF format signals are accepted. (This setting takes effect only when YPBPR is selected.)</p> <p>1035/60I: 1035/60I or 1035/59.94I format signals are accepted. (This setting takes effect only when YPBPR is selected.)</p> <p>720/60P: 720/60P or 720/59.94P format signals are accepted.</p> <p>576/50I: 576/50I format signals are accepted.</p> <p>480/60P: 480/60P format signals are accepted.</p> <p>480/60I: 480/59.94I format signals are accepted.</p>
COMPONENT LEVEL	<u>SMPTE</u> B75	<p>For selecting the input level of the Y/Pb/Pr signals.</p> <p>SMPTE: This is selected when the signals are to be output from an MII VTR.</p> <p>B75: This is selected when the signals are to be output from a Betacam VTR.</p>
RGB-SYNC	<u>G-ON</u> EXT	<p>For switching the connector where the sync signal is to be accepted.</p> <p>G-ON: This is selected when the sync signal has been superimposed onto the G signal.</p> <p>EXT: The sync signal is accepted at the SYNC connector among the analog component/RGBS connectors.</p>

CONTROL

Item	Setting	Description
CONTROL	<u>LOCAL</u> REMOTE	<p>For selecting where the operations are to be initiated.</p> <p>LOCAL: Only operations initiated from the main controls can be performed. Remote control operations cannot be performed.</p> <p>REMOTE: Remote control operations can be performed, but no operations initiated by the main controls can be performed although there are a few exceptions to this.</p> <p><Notes></p> <ul style="list-style-type: none"> When REMOTE has been selected, the "🔒" lock mark appears on the status display. When REMOTE has been selected, only the settings of the CONTROL item and LOCALENABLE item on the CONTROL screen can be changed as menu operations.
LOCALENABLE	<u>DIS.</u> INPUT	<p>For selecting whether to enable the input to be switched to the main controls when REMOTE has been selected.</p> <p>DIS: When REMOTE has been selected, the input can no longer be switched to the main controls.</p> <p>INPUT: Even when REMOTE has been selected, the input can be switched to the main controls.</p>
BACKLIGHT TIME		For displaying the total operation time of the backlight.

The underlined setting indicates the factory setting mode.

REMOTE specifications

This monitor can be operated by remote control using the GPI connector and RS-232C connector.

GPI connector

The items on the GPI screen correspond to the connector pins shown below. Functions can be allocated to these pins on the GPI screen of the main menu. (Refer to page 19)

The functions allocated to the pins are enabled when the corresponding pin is shorted (ON) to the GND pin and disabled when it is left open (OFF).

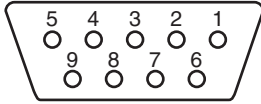

Connector (9P)

Pin no.	Signal
1	GPI1
2	GPI2
3	GPI3
4	GPI4
5	GND
6	GPI5
7	GPI6
8	GPI7
9	GPI8

List of functions allocated

The function which can be allocated to the pins are listed below.

Function	Description
UNDEF	Not set (no function allocated)
MARKER1 ON/OFF Level operation	This displays the markers which have been set by the GPI PRESET1 item on the MARKER screen. (Refer to page 16) However, it is not valid when MENU has been selected as the MARKER SELECT item setting on the MARKER screen. <Note> When this function has been set to ON at the same time as MARKER2, MARKER1 takes precedence.
MARKER2 ON/OFF Level operation	This displays the markers which have been set by the GPI PRESET2 item on the MARKER screen. (Refer to page 16) However, it is not valid when MENU has been selected as the MARKER SELECT item setting on the MARKER screen.
MARKER BACK HALF Level operation	This sets the background brightness to 50% when 4:3, 13:9 or 14:9 has been selected for the GPI PRESET1 item setting on the MARKER screen. However, it is not valid when MENU has been selected as the MARKER SELECT item setting on the MARKER screen.
MARKER BACK BLACK Level operation	This sets the background brightness to 0% when 4:3, 13:9 or 14:9 has been selected for the GPI PRESET1 item setting on the MARKER screen. However, it is not valid when MENU has been selected as the MARKER SELECT item setting on the MARKER screen. <Note> When this function has been set to ON at the same time as MARKER BACK HALF, MARKER BACK BLACK takes precedence.
CENTER MARKER Level operation	This displays the center marker. However, it is not valid when MENU has been selected as the MARKER SELECT item setting on the MARKER screen. <Note> When any other markers are displayed, the center marker is superimposed onto the same display.

Function	Description
Operation condition	
INPUT SEL. SDI1 Edge operation	This switches the input channel to SDI 1. <Note> This function is not valid when OFF has been selected as the SDI 1 item (see page 20) setting on the FORMAT screen.
INPUT SEL. SDI2 Edge operation	This switches the input channel to SDI 2. <Note> This function is not valid when OFF has been selected as the SDI 2 item (see page 20) setting on the FORMAT screen.
INPUT SEL. VIDEO Edge operation	This switches the input channel to VIDEO. <Note> This function is not valid when OFF has been selected as the VIDEO item (see page 20) setting on the FORMAT screen.
INPUT SEL. YPBPR/RGB Edge operation	This switches the input channel to ANALOG. <Note> This function is not valid when OFF has been selected as the YPBPR/RGB item (see page 20) setting on the FORMAT screen.
SD ASPECT Level operation	This sets the aspect ratio of the SD images. However, it is not valid if a setting other than GPI has been selected for the SD ASPECT item on the VIDEO CONFIG screen. <Note> This function is not valid when HD signals are supplied.
HD ZOOM Level operation	This performs the HD ZOOM operations. (For details on HD ZOOM, refer to page 5.) <Notes> • This function is not valid when SD signals are supplied. • It is not valid when FRONT has been selected as the HD ZOOM item setting on the SYSTEM CONFIG screen.
BACKLIGHT MIN. Level operation	This sets the backlight brightness to the minimum level. <Note> The setting for the BACKLIGHT item can be changed on the SYSTEM CONFIG screen while BACKLIGHT MIN. is kept at ON. When BACKLIGHT MIN. is set to OFF and back to ON at this time, the brightness will be set to the minimum level.
R TALLY Level operation	For lighting up the red tally lamp.
G TALLY Level operation	For lighting up the green tally lamp.
MONO ON/OFF Level operation	For setting the images to the monochrome mode. However, this function is not valid when a setting other than GPI has been selected for the MONO item on the VIDEO CONFIG screen.
GAMMA SELECT Level operation	This switches the gamma setting to FILM. (Refer to page 18)
WFM ON/OFF Level operation	This displays the Y signal (brightness) waveforms.

* Concerning the operation conditions

Level operation: The function is operational while the pin to which it has been allocated is shorted to ground.

Edge operation: The function is operational when the pin to which it has been allocated changes from open to shorted to ground.

<Note>

If a function whose operation condition is triggered by the level has been allocated to a multiple number of pins, it will continue to be operational while any one of those pins is shorted.

REMOTE specifications

RS-232C connector

For the RS-232C connector pin layout and connections, refer to the figure below and tables on the right.

<Note>

For details on systems that use the RS-232C connector, consult with your dealer or a Panasonic Service Center.

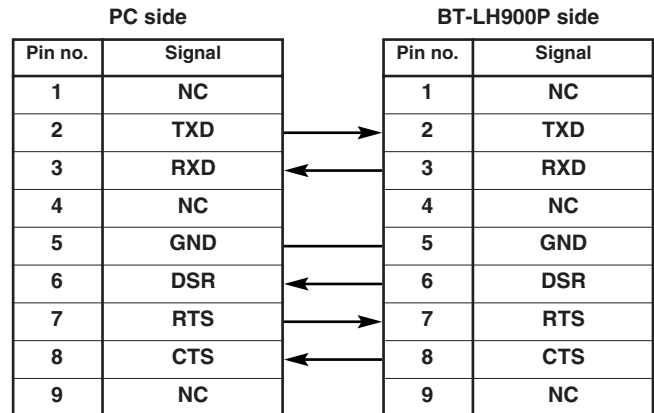
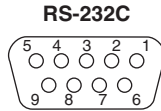

Error and warning displays

If an error has occurred in the monitor for some reason, an error or warning display will appear on the screen.

○ CRCC error

● **When this error appears**

When the SDI signals contain an error, the CRCC error display appears on the screen.

When a menu is displayed, the error is indicated in the menu area. At all other times, it is indicated on the status display. However, only the error will be displayed when 3SEC OFF or OFF has been selected as the STATUS DISPLAY item setting on the OSD screen. On the other hand, if OFF has been selected as the CRCC MESSAGE item setting on the OSD screen, the error will not be displayed even when it has been detected.

● **Countermeasure**

Check the input signals and connection statuses.

○ Inverter error

● **When this error appears**

If trouble has occurred in the inverter which controls the brightness of the backlight, the backlight is turned off, and all the lamps by the sides of the image controls and tally lamps flash at 1-second intervals.

● **Countermeasure**

Turn off the power and turn it back on. If the error display persists, contact a Panasonic service center.

○ Low remaining battery charge warning/error

● **When this warning/error appears**

If the battery voltage is 10.5V to 11.3V:

(If the remaining charge is less than 10% when an Anton Bauer digital battery is being used)

→ The remaining battery charge and voltage are displayed on the screen, and the display flashes.

If the battery voltage is less than 10.5V:

→ "END BATTERY" appears on screen in red for about three seconds, and the power is turned off.

● **Countermeasure**

Replace the battery with one containing a sufficient charge.

Maintenance

- **Wipe off any dust or dirt on the monitor and LCD panel with a soft cloth.**

For stubborn dirt or stains, wipe the monitor and LCD panel with a cloth that has been lightly dampened with well-diluted kitchen detergent and wrung out thoroughly, then finish it off with a dry cloth. The monitor may malfunction if even one drop of water gets into the internals.

- **Do not use benzene, paint thinners, etc. to clean the monitor.**

They may discolor the monitor's surfaces or cause the paint to peel off.

- **Do not spray detergent or other cleaners directly on the monitor or LCD panel.**

The monitor may malfunction if even one drop of water gets into the internals.

Maintenance and inspections

In order to ensure that this video component will provide many hours of trouble-free operation, provide the appropriate maintenance and servicing at periodic intervals so that the monitor's functions will be kept in perfect working order at all times. In order to ensure that the monitor's functions will perform to the best of their ability for a long time to come, be absolutely sure to conduct the maintenance and inspections described here.

1. Necessity for periodic maintenance and servicing

A backlight power supply is used in this LCD monitor. This part (which is a consumable) will deteriorate over time and lead to a reduced level of performance and failure.

For this reason, do not confine the maintenance activities to the kind of after-sale servicing which is performed when the usual failures have occurred. The user should know that it is important to follow through with comprehensive servicing which involves periodic maintenance and servicing aimed at keeping up the performance that the monitor is designed to provide and preventing sudden failures caused by consumable parts, etc.

2. Maintenance timeframe and implementation item

The maintenance implementation time given below is provided as a standard guideline, and it does not represent the service life of the part concerned. It should also be borne in mind that the period over which the part's performance will deteriorate differs according to the operating environment and method.

Part	Quantity	Periodic maintenance/inspection and time (hours)
Backlight	1	Replace every 38,000 hours.

Specifications

[GENERAL]

Power supply: DC 12 V (11.0 V to 17.0 V) Input current: 1.45 A

--

 indicates safety information.

Dimensions (W × H × D):

218 × 176 × 65 mm

(When the main controls have been installed at the bottom of the monitor)

Weight:

2.0 kg (main unit only)

Ambient operating temperature:

0 °C to 40 °C

Ambient operating humidity:

10% to 85% (no condensation)

Ambient temperature for storage:

−4 °F to 140 °F (−20 °C to +60 °C)

[Panel]

Size:

8.4 type

Number of pixels:

1024 × 768 (XGA)

Display colors:

Approx. 16.77 million colors

Angle of view:

Top-bottom direction: 170°

Left-right direction: 170°

[Input connectors]

Image input:

VIDEO:

1 line, BNC × 2

(1 connector with through-out configuration)

Analog component:

1 line for YPBPR/RGB, BNC × 4

SDI:

2 lines, BNC × 3

(1 connector with switched out facility)

GPI:

D-sub, 9 pins

RS-232C:

D-sub, 9 pins

DC input:

XLR, 4 pins

Battery holder:

Battery holder made by Anton Bauer

[Signal formats supported]

Formats when SDI signals are used

480/59.94I	576/50I
720/60P	720/59.94P
1035/60I	1035/59.94I
1080/24PsF	1080/23.98PsF
1080/24P	1080/23.98P
1080/25P	1080/30P
1080/29.97P	1080/50I
1080/60I	1080/59.94I

Formats when RGB signals are used

480/59.94I	576/50I
480/59.94P	720/60P
720/59.94P	1035/60I
1035/59.94I	1080/50I
1080/60I	1080/59.94I

Formats when Y/Pb/Pr signals are used

480/59.94I	576/50I
480/59.94P	720/60P
720/59.94P	1035/60I
1035/59.94I	1080/24PsF
1080/23.98PsF	1080/24P
1080/23.98P	1080/25P
1080/30P	1080/29.97P
1080/50I	1080/60I
1080/59.94I	

Formats when video signals are used

480/59.94I	576/50I
------------	---------

[Accessories provided with the monitor]

Metal battery mount

MEMO

MEMO

Panasonic

PANASONIC BROADCAST & TELEVISION SYSTEMS COMPANY
UNIT COMPANY OF MATSUSHITA ELECTRIC CORPORATION OF AMERICA

Executive Office:

One Panasonic Way 4E-7, Secaucus, NJ 07094 (201) 348-7000

EASTERN ZONE:

One Panasonic Way 4E-7, Secaucus, NJ 07094 (201) 348-7621

Southeast Region:

1225 Northbrook Parkway, Ste 1-160, Suwanee, GA 30024 (770) 338-6835

Central Region:

1707 N Randall Road E1-C-1, Elgin, IL 60123 (847) 468-5200

WESTERN ZONE:

3330 Cahuenga Blvd W., Los Angeles, CA 90068 (323) 436-3500

Government Marketing Department:

52 West Gude Drive, Rockville, MD 20850 (301) 738-3840

Broadcast PARTS INFORMATION & ORDERING:

9:00 a.m. – 5:00 p.m. (EST) (800) 334-4881/24 Hr. Fax (800) 334-4880

Emergency after hour parts orders (800) 334-4881

TECHNICAL SUPPORT:

Emergency 24 Hour Service (800) 222-0741

Panasonic Canada Inc.

5770 Ambler Drive, Mississauga, Ontario L4W 2T3 (905) 624-5010

Panasonic de Mexico S.A. de C.V.

Av angel Urraza Num. 1209 Col. de Valle 03100 Mexico, D.F. (52) 1 951 2127

Panasonic Sales Company

Division of Matsushita Electric of Puerto Rico Inc.

San Gabriel Industrial Park, 65th Infantry Ave., Km. 9.5, Carolina, Puerto Rico 00630 (787) 750-4300

Free Manuals Download Website

<http://myh66.com>

<http://usermanuals.us>

<http://www.somanuals.com>

<http://www.4manuals.cc>

<http://www.manual-lib.com>

<http://www.404manual.com>

<http://www.luxmanual.com>

<http://aubethermostatmanual.com>

Golf course search by state

<http://golfingnear.com>

Email search by domain

<http://emailbydomain.com>

Auto manuals search

<http://auto.somanuals.com>

TV manuals search

<http://tv.somanuals.com>