

Panasonic

Dual DIN In-dash 6.5" Widescreen Color LCD Monitor/DVD Receiver
듀얼 DIN 인대쉬 6.5" 와이드스크린 컬러 LCD 모니터/DVD 리시버
Сдвоенный DIN 6,5-дюймовый автомобильный широкоэкранный цветной ЖК-монитор/DVD-ресивер

Model: **CQ-VD6505W**



Operating Instructions

사용 설명서

Инструкция по эксплуатации



WMA MP3

- Please read these instructions carefully before using this product and keep this manual for future reference.
- 본 제품의 바른 사용을 위해, 이 사용설명서를 잘 읽어 주십시오.
잘 보관하시어 필요하실 때마다 읽어주시기 바랍니다.
- Перед началом эксплуатации просим прочитать настоящую инструкцию внимательно и хранить ее на пользование на будущее.

Safety Information

■ Read the operating instructions for the unit and all other components of your car audio system carefully before using the system. They contain instructions about how to use the system in a safe and effective manner. Panasonic assumes no responsibility for any problems resulting from failure to observe the instructions given in this manual.

■ This manual uses pictographs to show you how to use the product safely and to alert you to potential dangers resulting from improper connections and operations. The meanings of the pictographs are explained below. It is important that you fully understand the meanings of the pictographs in order to use this manual and the system properly.



Warning

This pictograph intends to alert you to the presence of important operating instructions and installation instructions. Failure to heed the instructions may result in severe injury or death.



Caution

This pictograph intends to alert you to the presence of important operating instructions and installation instructions. Failure to heed the instructions may result in injury or material damage.

Warning

Observe the following warnings when using this unit.

- ❑ **The driver should neither watch the display nor operate the system while driving.**

Watching the display or operating the system will distract the driver from looking ahead of the vehicle and can cause accidents. Always stop the vehicle in a safe location and use the parking brake before watching the display or operating the system.

- ❑ **Use the proper power supply.**

This product is designed for operation with a negative grounded 12 V DC battery system. Never operate this product with other battery systems, especially a 24 V DC battery system.

- ❑ **Keep batteries and insulation film out of reach of infants.**

Batteries and insulation film can be ingested, so keep them out of the reach of infants. If an infant ingests a battery or insulation film, please seek immediate medical attention.

- ❑ **Protect the Deck Mechanism.**

Do not insert any foreign objects into the slot of this unit.

- ❑ **Do not disassemble or modify the unit.**

Do not disassemble, modify the unit or attempt to repair the product yourself. If the product needs to be repaired, consult your dealer or an authorized Panasonic Service Center.

- ❑ **Do not use the unit when it is out of order.**

If the unit is out of order (no power, no sound) or in an abnormal state (has foreign objects in it, is exposed to water, is smoking, or smells), turn it off immediately and consult your dealer.

- ❑ **The remote control unit should not lie about in the car.**

If the remote control unit lies about, it could fall on the floor while driving, get wedged under the brake pedal, and lead to a traffic accident.

- ❑ **Refer fuse replacement to qualified service personnel.**

When the fuse blows out, eliminate the cause and have it replaced with the fuse prescribed for this unit by a qualified service engineer. Incorrect replacement of the fuse may lead to smoke, fire, and damage to the product.

Observe the following warnings when installing.

- ❑ **Disconnect the lead from the negative (–) battery terminal before installation.**

Wiring and installation with the negative (–) battery terminal connected may cause electrical shock and injury due to a short circuit.

Some cars equipped with the electrical safety system have specific procedures of battery terminal disconnection.

FAILURE TO FOLLOW THE PROCEDURE MAY LEAD TO THE UNINTENDED ACTIVATION OF THE ELECTRICAL SAFETY SYSTEM RESULTING IN DAMAGE TO THE VEHICLE AND PERSONAL INJURY OR DEATH.

- ❑ **Never use safety-related components for installation, grounding, and other such functions.**

Do not use safety-related vehicle components (fuel tank, brake, suspension, steering wheel, pedals, airbag, etc.) for wiring or fixing the product or its accessories.

- ❑ **Installing the product on the air bag cover or in a location where it interferes with airbag operation is prohibited.**

- ❑ **Check for piping, gasoline tank, electric wiring, and other items before installing the product.**

If you need to open a hole in the vehicle chassis to attach or wire the product, first check where the wire harness, gasoline tank, and electric wiring are located. Then open the hole from outside if possible.

- ❑ **Never install the product in a location where it interferes with your field of vision.**

- ❑ **Never have the power cord branched to supply other equipment with power.**

- ❑ **After installation and wiring, you should check the normal operation of other electrical equipment.**

The continuation of their using in abnormal conditions may cause fire, electrical shock or a traffic accident.

- ❑ **In the case of installation to an airbag equipped car, confirm warnings and cautions of the vehicle manufacturer before installation.**

- ❑ **Make sure the leads do not interfere with driving or getting in and out of the vehicle.**

- ❑ **Insulate all exposed wires to prevent short circuiting.**

Caution

Observe the following cautions when using this unit.

- ❑ **Keep the sound volume at an appropriate level.**
Keep the volume level low enough to be aware of road and traffic conditions while driving.
- ❑ **Do not insert or allow your hand or fingers to be caught in the unit.**
To prevent injury, do not get your hand or fingers caught in moving parts or in the disc slot. Especially watch out for infants.
- ❑ **This unit is designed for use exclusively in automobiles.**
- ❑ **Do not operate the unit for a prolonged period with the engine turned off.**
Operating the audio system for a long period of time with the engine turned off will drain the battery.
- ❑ **Do not expose the unit to direct sunlight or excessive heat.**
Otherwise these will raise the interior temperature of the unit, and it may lead to smoke, fire, or other damage to the unit.
- ❑ **Do not use the product where it will be exposed to water, moisture, or dust.**
Exposure of the unit to water, moisture, or dust may lead to smoke, fire, or other damage to the unit. Make especially sure that the unit does not get wet in car washes or on rainy days.

Observe the following cautions when installing.

- ❑ **Refer wiring and installation to qualified service personnel.**
Installation of this unit requires special skills and experience. For maximum safety, have it installed by your dealer. Panasonic is not liable for any problems resulting from your own installation of the unit.
- ❑ **Follow the instructions to install and wire the product.**
Not following the instructions to properly install and wire the product could cause an accident or fire.
- ❑ **Take care not to damage the leads.**
When wiring, take care not to damage the leads. Prevent them from getting caught in the vehicle chassis, screws, and moving parts such as seat rails. Do not scratch, pull, bend or twist the leads. Do not run them near heat sources or place heavy objects on them. If leads must be run over sharp metal edges, protect the leads by winding them with vinyl tape or similar protection.

- ❑ **Use the designated parts and tools for installation.**
Use the supplied or designated parts and appropriate tools to install the product. The use of parts other than those supplied or designated may result in internal damage to the unit. Faulty installation may lead to an accident, a malfunction or fire.

- ❑ **Do not block the air vent or the cooling plate of the unit.**

Blocking these parts will cause the interior of the unit to overheat and will result in fire or other damage.

- ❑ **Do not install the product where it is exposed to strong vibrations or is unstable.**

Avoid slanted or strongly curved surfaces for installation. If the installation is not stable, the unit may fall down while driving and this can lead to an accident or injury.

- ❑ **Installation Angle**

The product should be installed in a horizontal position with the front end up at a convenient angle, but not more than 30°.

The user should bear in mind that in some areas there may be restrictions on how and where this unit must be installed. Consult your dealer for further details.

- ❑ **Wear gloves for safety. Make sure that wiring is completed before installation.**
- ❑ **To prevent damage to the unit, do not connect the power connector until the whole wiring is completed.**
- ❑ **Do not connect more than one speaker to one set of speaker leads. (except for connecting to a tweeter)**

Observe the following cautions when handling the battery for the remote control unit.

- Use only specified battery (CR2025).
- Match the polarity of the battery with the (+) and (-) marks in the battery case.
- Replace a dead battery as soon as possible.
- Remove the battery from the remote control unit when not using it for an extended period of time.
- Insulate the battery (by placing them in a plastic bag or covering them with vinyl tape) before disposal or storage.
- Dispose of the battery according to the local regulations.
- Do not disassemble, recharge, heat or short the battery. Do not throw a battery into a fire or water.

In case of battery leakage

- Thoroughly wipe the battery liquid off the battery case and insert new battery.
- If any part of your body or clothing comes into contact with battery liquid, wash it with plenty of water.
- If battery liquid comes into contact with your eyes, wash them with plenty of water and get immediate medical attention.

CAUTION:

- **PLEASE FOLLOW THE LAWS AND REGULATIONS OF YOUR STATE, PROVINCE OR COUNTRY FOR WIRING, INSTALLATION, AND USE OF THIS UNIT AND THE DEVICES TO BE CONNECTED.**

Safety Information (continued)

Caution

THIS PRODUCT IS A CLASS I LASER PRODUCT.
USE OF CONTROLS OR ADJUSTMENTS OR PERFORMANCE
OF PROCEDURES OTHER THAN THOSE SPECIFIED HEREIN
MAY RESULT IN HAZARDOUS RADIATION EXPOSURE.
DO NOT OPEN COVERS AND DO NOT REPAIR BY YOUR-
SELF. REFER SERVICING TO QUALIFIED PERSONNEL.



This system is designed so that you cannot see moving pictures while you are driving.

- Park your car in a safe place and pull the side brake (parking brake) lever before watching the monitor.
- A rear monitor (option) displays moving pictures while driving.

Note:

- Be sure to connect the side brake (parking brake) connection lead. (⇒ Installation Instructions)

Notes on Use

Liquid Crystal Panel

- Do not cause impact to the liquid crystal panel.
- Usage temperature range: 0 °C to 40 °C
When the temperature is very cold or very hot, the image may not appear clearly or may move slowly. Also, movement of the image may seem to be out of synchronization or the image quality may decline in such environments. Note that this is not a malfunction or problem.
- In order to protect the liquid crystal panel, keep it out of direct sunlight while the unit is not in use.
- Sudden changes in the temperature inside the car such as those which occur immediately after the car's air conditioner or heater has been turned on may cause the inside of the liquid crystal panel to cloud over due to water vapor or it may cause condensation (droplets of water) to form and, as a result, the panel may not work properly. Do not use the unit while these symptoms are in evidence but leave the unit standing for about an hour, and then resume or start use.

Before Reading These Instructions

Differences among 4 Models

This operating instruction manual is for 4 models CQ-VD6505W2/CQ-VD6505W3/CQ-VD6505W4 and CQ-VD6505W5.

The following table shows the playable region number for each model.

Model	Playable region number
CQ-VD6505W2	2 (ALL)
CQ-VD6505W3	3 (ALL)
CQ-VD6505W4	4 (ALL)
CQ-VD6505W5	5 (ALL)

Example:



“Before Disc Playback”
(→ page 16)

Components



1. Main Unit
(LCD monitor/DVD player)

Qty.: 1



2. Remote Control Unit
<EUR7641060>
(includes a battery: CR2025)

Qty.: 1



3. Wiping Cloth
<YEFX9991793>

Qty.: 1



4. Operating Instructions
<YFM284C681ZA>

Qty.: 1



5. System Upgrade Guidebook
<YFM284C682ZA>

Qty.: 1



6. Installation Instructions
<YFM294C102ZA>

Qty.: 1

7. Installation Hardware (screws, cords, etc.)
(→ Installation Instructions)

Note:

- The number in parenthesis underneath each accessory part name is the part number for maintenance and service.
- Accessories and their parts numbers are subject to modification without prior notice due to improvements.

Features

Panasonic welcomes you to our constantly growing family of electronic products owners. We endeavor to give you the advantages of precise electronic and mechanical engineering, manufactured with carefully selected components, and assembled by people who are proud of the reputation their work has built for our company. We know this product will bring you many hours of enjoyment, and after you discover the quality, value and reliability we have built into it, you too will be proud to be a member of our family.

Please refer to the separate “System Upgrade Guidebook” for how to operate this unit when optional devices are connected.

- No device is connected to this unit. ➔ Basic operations are covered only by this book.
- Optional devices are connected to this unit. ➔ Refer to the “System Upgrade Guidebook” in addition.

■ Simultaneous Multi-Device Connection (with Expansion Module (hub unit))

You can connect the optional Expansion Module (hub unit) (CY-EM100N). Connection of the Expansion Module allows you to simultaneously connect optional devices mentioned before as well as other AV devices. For details, refer to the operating instructions for the Expansion Module.

Connectable devices

- CD/DVD changer (max. 1)
- iPod® (max. 2)
- iPod with Video (max. 1)
- Hands-Free Phone System (max. 1)
- TV tuner (max. 1)

Note:

- Market conditions regarding optional devices vary with countries and regions. For further information, consult your dealer.
- If a non-Panasonic product is connected to this unit, we do not guarantee the operations of the product.
- If iPod with Video is connected, no more iPod can be connected.

■ Integration of the monitor, FM/AM radio, DVD Video/Video CD player and CD/MP3/WMA player

■ Built-in AV Input/Output Terminals

For more convenient connection and setup, all terminals are now provided on the unit itself.

■ Built-in Dolby Digital decoder, DTS decoder

You can enjoy a powerful 5.1 channel surround system by connecting optional center speaker, power amplifier and sub-woofer.

■ Built-in DSP

7 bands graphic equalizer. (➔ page 32)

■ GUI (Graphic User Interface)

GUI displays various indications with colorful symbols to enhance visibility, enjoyment, and operability.

■ Disc type and input signal auto-detection

The signal auto-detection function of this unit allows users to be free from selection between PAL and NTSC before use of your discs or devices. (For output signal, set [TV TYPE]. (➔ page 36))

■ CS Auto (Circle Surround Automotive)

CS Auto allows your car interior to change to a splendid audio room in a moment. Every speaker can be fine-tuned. (➔ page 33)



is a trademark of SRS Labs, Inc.

CS Auto technology is incorporated under license from SRS Labs, Inc.

Note:

- If you enable CS Auto, the following functions are automatically disabled:
[GRAPHIC-EQ], [CROSS OVER], [DOWN MIX], [MULTI-CH], (➔ page 32-37).

■ Touch Panel Operation

Simply touch the screen lightly to operate virtually all functions. Easy-to-use menus and icons let you “touch and choose” what you want, so you can start using your system from the very first day. That also means that while you drive, you can concentrate on the road.

■ DVD-R, DVD-RW Playback

(➔ page 16, 48 for details)

■ ID code

4-digit ID code for increased security.

Fill in the ID code memo (➔ page 46).

Contents



English	2
한국어	52
Русский	102

<input type="checkbox"/> Safety Information	2
<input type="checkbox"/> Notes on Use	5
<input type="checkbox"/> Before Reading These Instructions	5
<input type="checkbox"/> Components	5
<input type="checkbox"/> Features	6

<input type="checkbox"/> Preparation	8
First time power on, other settings, remote control unit, symbols used in this manual	
<input type="checkbox"/> Name of Controls and Functions	10
<input type="checkbox"/> Touch Panel Operation Overview	12

<input type="checkbox"/> General	14
Power on/power off, display open/close, source selection, volume, mute, tilt angle	
<input type="checkbox"/> Before Disc Playback	16
<input type="checkbox"/> Disc Player	18
<input type="checkbox"/> Notes on MP3/WMA	22
<input type="checkbox"/> Radio	24
<input type="checkbox"/> AV1/AV2	26

<input type="checkbox"/> Settings	28
Menu operation	
User, screen, audio, DVD, input/output, radio	

<input type="checkbox"/> Troubleshooting	41
<input type="checkbox"/> Maintenance	47
<input type="checkbox"/> Notes on Discs	48
<input type="checkbox"/> Language Code List	49
<input type="checkbox"/> Definition of Terms	50
<input type="checkbox"/> Specifications	51

Preparation

First Time Power On

The speaker setup screen appears after the opening display when the power is turned on for the first time. Perform speaker setup according to the car conditions in which this unit is installed. (**SP SETUP** → page 34)

Other Settings

Please refer to the separate “System Upgrade Guidebook” for how to operate this unit when optional devices are connected.

USER (user settings) (→ page 30)

display unit, **clock**, ID code, memory clear, other

SCREEN (screen settings) (→ page 32)

dimmer, picture

AUDIO (audio settings) (→ page 32)

sound setup, graphic equalizer, CS Auto, speaker set up, speaker level, time alignment, source level, cross over

DVD (DVD settings) (→ page 36)

language, display, pro logic, down mix, dynamic range compression, multiple channel

INPUT/OUTPUT (AV-IN/OUT settings) (→ page 37)

source skip

RADIO (radio settings) (→ page 38)

FM set up, AM set up

Note:

- Refer to “Settings” (→ page 28) for further information about operations, settings, and others of the menu screen.

You may need to set the following depending on the devices to be connected.

Subwoofer

- Execute **SP LEVEL** (speaker level). (→ page 34)

AV1/AV2 (Camcorder, VCR, etc.)

- Adjust **SOURCE LEVEL** (AV1/AV2 input level). (→ page 35)

Warning

- When you connect external devices to AV1-IN/AV2-IN (AV1/AV2), be sure to connect the side brake connection lead (→ Installation Instructions).

Remote Control Unit

Before Initial Use

Pull the insulation film out from the backside of the remote control gently.

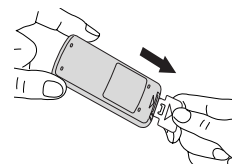

Battery Replacement

- 1 Remove the battery holder with the remote control unit placed on a flat surface.
 - 1 Stick your thumbnail into the groove and push the holder in the direction of the arrow at the same time.
 - 2 Pull it out in the direction of the arrow using a tough pointed object.

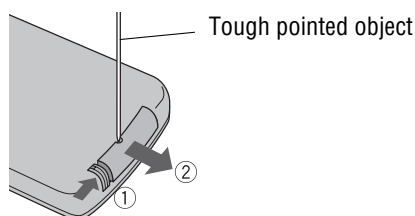

- 2 Put a battery in the case with (+)-side facing up.
- 3 Put the case back.

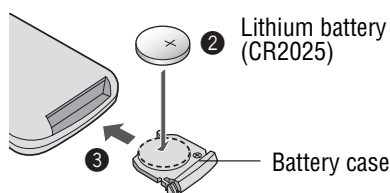

Warning

- Keep batteries away from children to avoid the risk of accidents. If an infant ingests a battery, please seek immediate medical attention.

Caution

- Remove and dispose of an old battery immediately.
- Do not disassemble, heat or short a battery. Do not throw a battery into a fire or water.
- Follow local regulations when disposing of a battery.
- Improper use of a battery may cause overheating, an explosion or ignition, resulting in injury or a fire.

Note:

- Battery Information:
 Battery Type: Panasonic lithium battery (CR2025)
 Battery Life: Approximately 6 months under normal use (at room temperature)

Symbols used in this manual

Pictographs

You can perform some operations of this unit in one or more methods with the touch panel or remote control. This book explains such operations in tabular form as follows. Refer to the following for the pictographs located in the upper part of each table.



Compatible types of disc

The discs compatible with the targeted operation.

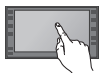

Operation on the Touch Panel

You can use the touch panel to perform the targeted operation. If the operation is not executable with the touch panel, “—” is displayed.



Operation on the Remote Control Unit

You can use the remote control to perform the targeted operation. If the operation is not executable with the remote control, “—” is displayed.



Operation on the Main Unit

You can use the Main Unit to perform the targeted operation. If the operation is not executable with the Main Unit, “—” is displayed.

Disc Marks

The following pictographs are used for the descriptions of disc operation. (→ page 17-21)

: DVD

: VCD (Video CD)

: CD

: CD-R/RWs containing MP3 files

: CD-R/RWs containing WMA files

Name of Controls and Functions

Main Unit

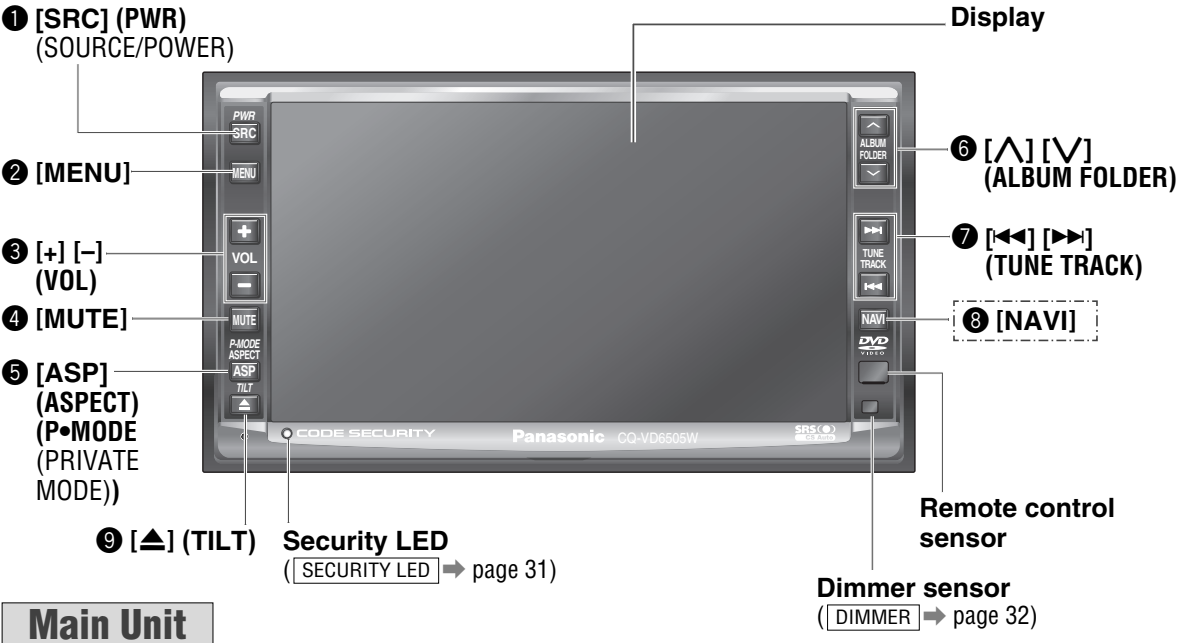

Main Unit

(Panel Open)

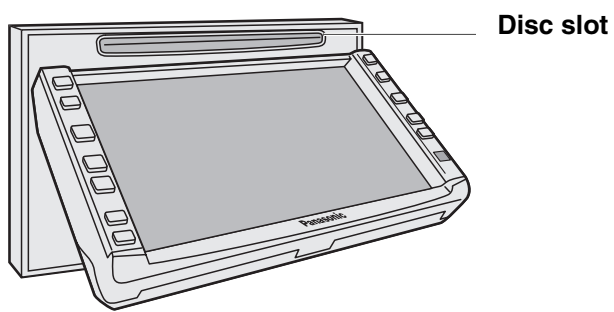

Note:

• [MENU], [ASP], [NAVI], [▲] are available only on the main unit.

[]: This book refers to connections to the Panasonic car navigation system that will come onto the market in the future. Descriptions regarding the car navigation system are boxed with a dotted line.

- | | |
|---|---|
| <p>1 [SRC] (PWR)</p> <ul style="list-style-type: none"> • Switches on/off the power. • Changes the modes such as sound and picture. <p>2 [MENU]</p> <ul style="list-style-type: none"> • Shows the menu screen. <p>3 [+] [-] (VOL)</p> <ul style="list-style-type: none"> • Adjusts the sound volume. <p>4 [MUTE]</p> <ul style="list-style-type: none"> • Mutes the sound temporarily. <p>5 [ASP] (ASPECT) (P•MODE)</p> <ul style="list-style-type: none"> • Selects the aspect ratio. • Activates/inactivates the private mode. <p>6 [^] [v] (ALBUM FOLDER)</p> <ul style="list-style-type: none"> • Selects a folder or a disc. • Selects (vertically) or adjusts an operation or item. | <p>7 [◀] [▶] (TUNE TRACK)</p> <ul style="list-style-type: none"> • Goes to beginning. • Fast forward/fast reverse. • Slow playback ([▶▶]). <p>8 [NAVI]</p> <ul style="list-style-type: none"> • Switches navigation mode on and off. (available in the future) <p>9 [▲] (TILT)</p> <ul style="list-style-type: none"> • Adjusts the monitor position. • Opens/closes the panel. • Ejects the disc. |
|---|---|

Remote Control

Aim the remote control at the remote control sensor of the main unit and operate it.

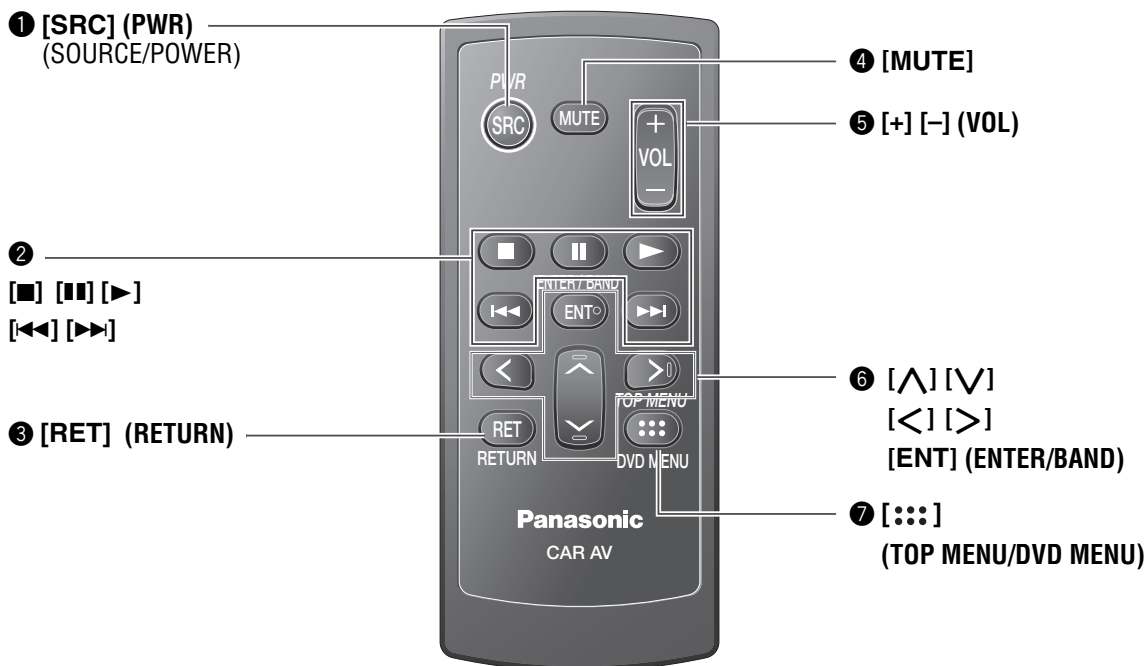

Note:

- [ENT], [RET], [■], [■], [▶], [:::] are available only on the remote control unit.

1 [SRC] (PWR)	<ul style="list-style-type: none"> • Switches the power on/off. • Changes the modes such as sound and picture. 	5 [+] [-] (VOL)	<ul style="list-style-type: none"> • Adjusts the sound volume.
2 [■]	<ul style="list-style-type: none"> • Stops playback. 	6 [<] [>]	<ul style="list-style-type: none"> • Selects or searches for a track, file, station. • Selects (horizontally) or adjusts an operation or item.
[■]	<ul style="list-style-type: none"> • Pause 	[^] [v]	<ul style="list-style-type: none"> • Selects (vertically) or adjusts an operation or item.
[▶]	<ul style="list-style-type: none"> • Playback 	[ENT] (ENTER/BAND)	<ul style="list-style-type: none"> • Selects a band. • Shows OSD. • Searches for broadcast stations and memorizes them automatically. • Determines an operation or item.
[◀◀] [▶▶]	<ul style="list-style-type: none"> • Goes to beginning. • Fast forward/fast reverse. • Slow playback ([▶▶]). 	[:::] (TOP MENU/DVD MENU)	<ul style="list-style-type: none"> • Displays the DVD/title menu. (Operations vary according to the media.)
3 [RET] (RETURN)	<ul style="list-style-type: none"> • Returns to the previous display. • Inputs the number again. • Displays the VCD's menu. 		
4 [MUTE]	<ul style="list-style-type: none"> • Mutes the sound temporarily. 		

Touch Panel Operation Overview

Notes on the Touch Panel

Before operation

- Clean the surface of the touch panel. (⇒ page 47)

Operation

- Use only your fingers to operate the touch panel.
- Do not press the panel forcefully.
- Do not scratch the panel with fingernails or any hard objects.

- Do not use a pen or other sharp implements to operate the touch panel.
- Do not bump the front panel.
 - ⇒ Failure to observe the above may damage or break the glass on the surface of the touch panel.

The State of Operation Screen

Example: DVD mode

Note:

- The following picture is partly darkened for explanation.
- Displaying contents and their positions partly vary with each mode. Refer to the description of each mode for details.

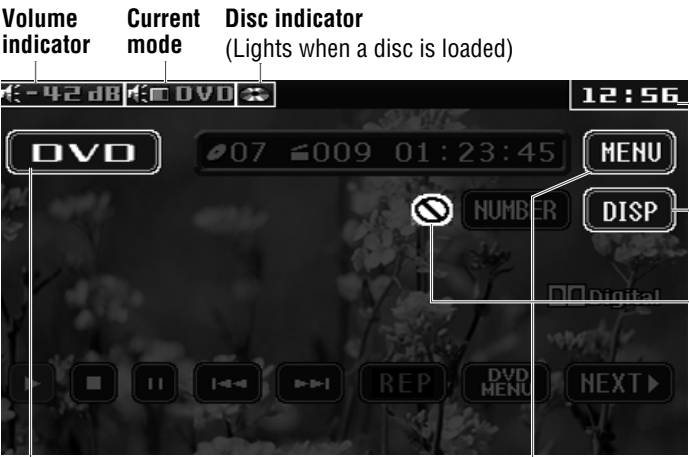

Clock time (⇒ page 30)

DISP Display Button
(⇒ next page)

Prohibition
Input is not possible because the user has attempted to perform an operation which is not supported by the disc contents.

DVD Source Button
(Content varies with each source)

Displays the Source Selection Screen.

Source Selection Screen



Source Selection Screen appears.
Touch desired source button.
Touch **END** to quit.

Press **[SRC]** to change to desired mode.

MENU Menu Button

Displays the Menu Screen.

Menu Screen

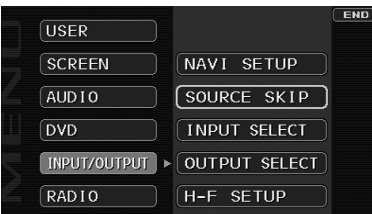

Menu Screen appears. Select desired setting.

Menu Setting, (⇒ page 28)

Press **[MENU]** to let menu screen appear.

Note:

- The screen above appears when no external device is connected to AV1, AV2, and the Expansion Module (CY-EM100N, option).

Switching the display

Please refer to the separate “System Upgrade Guidebook” for how to operate this unit when optional devices are connected.

Touching **DISP** allows users to switch between screens as follows.

□ How to Call up Operation Screen

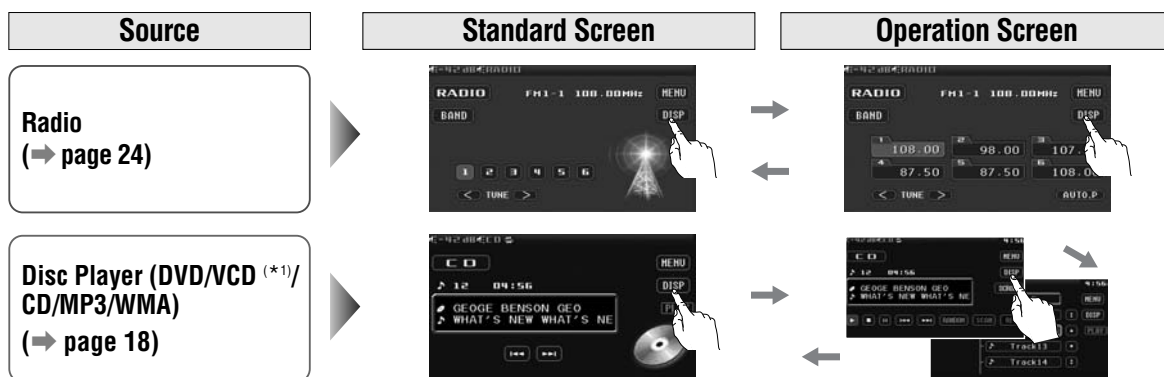

□ How to Cancel OSD (On Screen Display)



*1 To switch Operation Screen ON, touch the center of touch panel or press **[ENTER]** on the remote control.

*2 The operation screen is not available in the video mode.

Note:

- Refer to the description of each mode for how to operate the operation screen.

Showing the hidden part of the screen.

Some items have continued parts. You can see the continued parts by pressing **▶NEXT** or **◀BACK**.

DVD mode

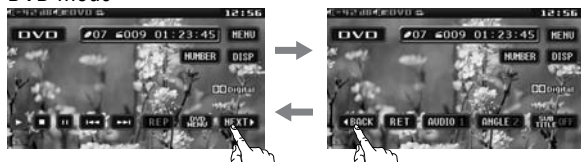

General



Preparation: Turn your car's ignition key to the ACC or ON position.

General Operations

Operations				
Power ON :	-	[SRC]	[SRC]	Note: • You cannot turn on the power via the remote control when ACC SELECT is set to OFF . (⇒ ACC SELECT , page 31)
Power OFF :	-			
Display Open/Close	-	-	[▲]	• Press once to open. Press again to close. Note: • The display automatically closes after a warning alarm sounds if no operation is performed for approximately 30 seconds. • When a disc is already loaded, the disc will be ejected.
Source selection	(⇒ page 12)	[SRC]	[SRC]	<div style="border: 1px solid black; padding: 5px; margin-bottom: 5px;"> RADIO (AM/FM) (⇒ page 24) </div> <div style="border: 1px solid black; padding: 5px; margin-bottom: 5px;"> DVD (DVD/VCD (Video CD)/CD/MP3/WMA) (⇒ page 18) </div> <div style="border: 1px solid black; padding: 5px; margin-bottom: 5px;"> AV1/AV2 (⇒ page 26) </div> <div style="border: 1px solid black; padding: 5px;"> Sources connected to the Expansion Module (CY-EM100N) *1 (⇒ System Upgrade Guidebook) </div> <p>*1 When the Expansion Module (CY-EM100N, option) is connected. (⇒ System Upgrade Guidebook)</p> <p>Note: • If there is no external sources connected, AV1/AV2 mode can be set to skip. (⇒ page 37)</p>

..... Touch/Press and hold for more than 2 seconds

[SRC] (PWR: power)





[MUTE]

[+] [-]
(VOL)

[<] [>]



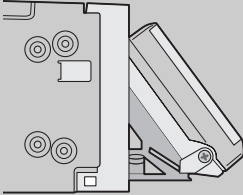



General Operations (continued)

Operations				
Volume Note: <ul style="list-style-type: none"> The sound level for each source is stored in memory. 	-	[+] [-]	[+] [-]	Up Down Setting Range: -82 dB to 0 dB, default: -40 dB Note: <ul style="list-style-type: none"> The volume level can be set independently for each source and each disc format.
Mute	-	[MUTE]	[MUTE]	Mutes the sound. To cancel, press again.
Tilt Angle 	-	-	[TILT]	<ol style="list-style-type: none"> Press and hold for more than 2 seconds. Press to adjust. Setup is the same as from MENU. Refer to [DISPLAY UNIT] for details. (→ page 30)
<div style="border: 1px solid black; padding: 5px;"> <p>Warning</p> <ul style="list-style-type: none"> Do not touch the unit while the display is moving. Inserting hands, fingers or foreign objects into the unit can cause injuries and damage to the unit. </div>				
<p>Note:</p> <ul style="list-style-type: none"> After adjusting its angle, also adjust the brightness as well. (→ page 32) The car model and installation conditions may impose some restrictions on the adjustment of the monitor's angle. 				

Before Disc Playback

Discs that can be Played Back

Disc Type

DISC	DVD	VCD (Video CD)	CD	CD-R/RW
Mark/logo	 		 	 
Disc Size	12 cm			
Video Format	NTSC/PAL			
Audio Format	LPCM, MPEG1, MPEG2, dts, Dolby Digital	LPCM, MPEG1	LPCM (CD-DA), dts	LPCM (CD-DA), MP3/WMA
Region No.	2 ^(*) , 3 ^(*) , 4 ^(*) , 5 ^(*) , (ALL)			

*1 CQ-VD6505W2 *2 CQ-VD6505W3 *3 CQ-VD6505W4
*4 CQ-VD6505W5

Note:

- About CD-Rs/RWs and DVD-Rs/RWs, refer to "Notes on CD-Rs/RWs, DVD-Rs/RWs". (⇒ page 48)
- Some copy-protected music CDs are not playable.

Notes on DVD-Rs/RWs

- Only video formatted discs are playable. **Discs in the video recording (VR) format are unplayable.**
- **Unfinalized discs are unplayable.**
- Some discs are unplayable depending on the disc itself, device, drive and software that are used for disc recording.

Discs not supported

The following discs are not played back on this product.



- DVD-Audio
- DVD-ROM
- DVD-RAM
- DVD+R
- DVD+RW
- SVCD
- VSD
- CVD
- CD-G
- CD-ROM (except MP3/WMA)
- CD-RW (except MP3/WMA and CD-DA)
- CD-R (except MP3/WMA and CD-DA)
- SACD
- Photo CD
- CDV
- Hybrid SACD (except CD-DA)
- Divx Video Discs
- CD-EXTRA (audio-only playback possible)
- DVDs with a region number other than "2"^(*), "3"^(*), "4"^(*), "5"^(*) or "ALL"

- **Playing back a photo CD disc with this unit could damage the data that is recorded on the disc.**

*1 CQ-VD6505W2 *2 CQ-VD6505W3 *3 CQ-VD6505W4
*4 CQ-VD6505W5



Symbols used on jackets



(Examples of such symbols include)

-  : Number of subtitle languages
-  : Number of audio tracks
-  : Number of angles

The numbers indicate the number of languages, tracks, angles, etc., recorded on the disc.

Screen size (H:V aspect ratio)

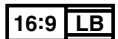
-  : 4:3 standard size
-  : Letterbox (⇒ page 36)
- 16:9 wide size

 : Playback in  format on a standard screen (4:3).

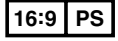
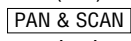
 : Playback in  (⇒ page 36) format on a standard screen (4:3).

Note:

- The size of the image that is displayed on the screen depends on the screen mode ("Aspect Ratio" ⇒ page 39), and on the screen size for the content on the disc.

Region Management Information

This product is designed and manufactured to respond to the Region Management Information that is recorded on a DVD disc. If the Region number described on the DVD disc does not correspond to the Region number of this product, this product does not play the disc.

The Region number for this product is "2"^(*), "3"^(*), "4"^(*), "5"^(*) and "ALL".

*1 CQ-VD6505W2
*2 CQ-VD6505W3
*3 CQ-VD6505W4
*4 CQ-VD6505W5

Example:

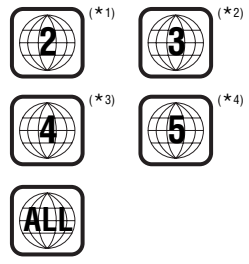

Disc Insert/Eject



[▲] (eject)

⚠ Warning

- Do not touch the unit while the display is moving. Inserting hands, fingers or foreign objects into the unit can cause injuries and damage to the unit.

Disc Insert

Press [▲] to open the display.

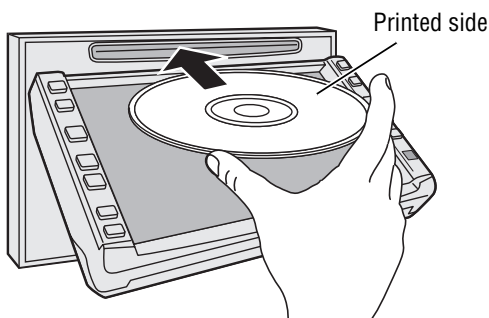

- The mode that supports the disc is selected, and playback starts.

⚠ Caution

- When the disc is inserted or ejected, to prevent disc scratches never exert any downward force on the disc.

DVD VCD

- The audio format is automatically identified. (→ page 16)
- When the menu screen appears, see “Chapter/title Selection” on page 20.

When a disc is in the player, change to disc player mode (CD, MP3, WMA, DVD or VCD (Video CD)) and playback starts.

Note:

- The power will be turned on automatically when a disc is loaded.
- You can play a disc even if the monitor is closed.

DVD VCD

- The sound may be interrupted for a few moments while the audio format is being identified.

⚠ Caution

- Do not use irregularly shaped discs.
- Do not insert foreign object into the disc slot.
- **This unit does not support 8-cm disc. In case of load such a disc, eject and remove the disc from the slot immediately.**

Disc Eject

Press [▲] to stop playback and eject the disc.
(Press [▲] again to reload the disc.)

Note:

- If you leave a disc in the slot for more than 30 seconds after its ejection, the disc will be automatically reloaded after loud beep is energized three times.

DVD VCD

- Due to limitations of certain discs, some DVD and VCD (Video CD) discs may not operate as described in this manual. Refer to the disc jacket for further details.
- This unit does not support DVD and VCD (Video CD) karaoke functions.

Disc Player

Disc Mode (DVD) Selection

1 Touch "Source Button".

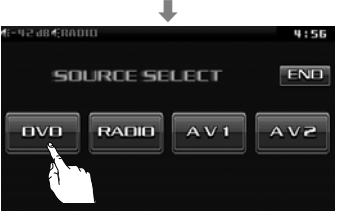

2 Touch [DVD] on the Source Selection Screen.

Press [SRC] to change to the desired mode.

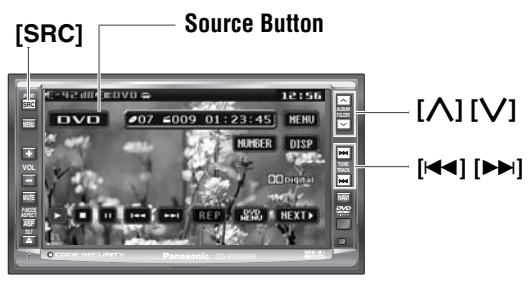

To switch Operation Screen ON, touch the center of touch panel or press [ENTER] on the remote control. (Only for Video Mode)

Video Mode

DVD mode display

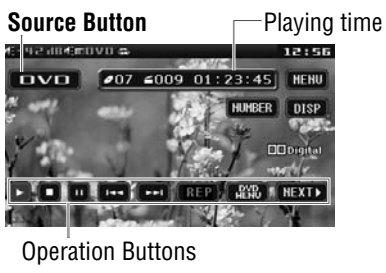

VCD (Video CD) mode display

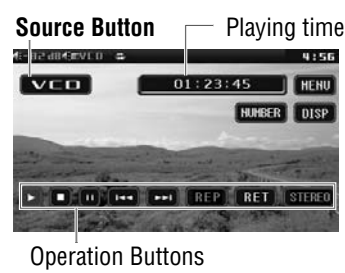

Audio Mode

MP3/WMA mode display

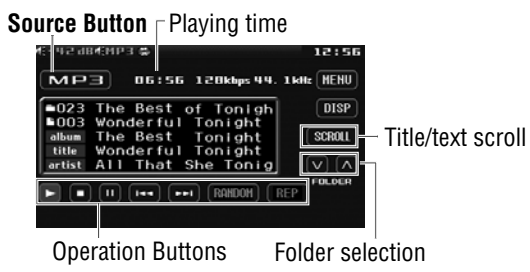

Folder/File/Track Selection

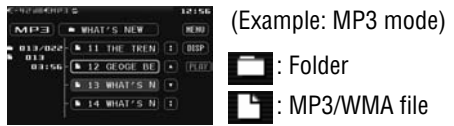

- Touch [WHAT'S NEW] (folder name) to select a folder.
 [↑], [↓] : scrolls up/down the file list by 1 page.
 [▲], [▼] : scrolls up/down the file list by 1 line.
- Touch [11 THE TREK] (file name) to play.



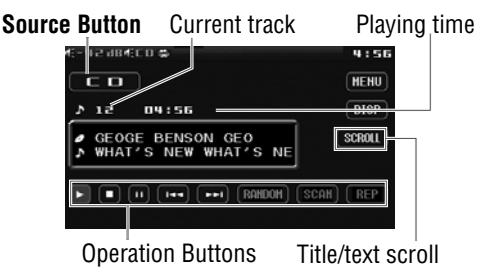





























































CD mode display





- Press [◀], [▶], [^] or [v]
 [◀] [▶]: movement among different levels of trees
 [^] [v]: movement in the same tree
- Press [ENTER].

Note:

- It is not possible to display the whole tree and file list in a folder.
- The displayed contents on the touch panel vary with circumstances.

Basic Operations						
Operations	Compatible Discs	Operations				
						
Track/file Selection	  	  	  			Next track/file Beginning of the current track/file Previous track/file (Touch/press twice.)
		Note: ● When playing a DVD, there are cases where it is not possible to return to the start of a chapter that spans 2 titles. (→ page 50)				
Fast Forward/ Fast Reverse	  	  	  			Fast forward Release to resume playback. Fast reverse Release to resume playback.
		The speed changes if the button is held down as follows. Regular speed → 1.5 times (DVD) → 10 times (DVD) → 20 times				
Folder Selection		 Touch desired folder	 	 		Next folder Previous folder
			-	-		Scrolls the title/text once
Stop	  	 	-			To resume playback, touch/press  /  .
Pause	  	 				To resume playback, touch/press again or touch/press  /  .
Slow Playback		  				● Touch/press and hold in the pause mode. Playback is at about 1/3 normal speed. To resume normal playback, touch/press  /  .
		Note: ● Reverse slow playback is not possible.				
Repeat Play	  	 *	-	-		To cancel, touch again.
		 *	-	-		To cancel, touch and hold for more than 2 seconds again.
Scan Play			-	-		To cancel, touch again.
Random Play	 	 *	-	-		To cancel, touch again.
		 *	-	-		To cancel, touch and hold again.

 Touch/Press and hold

* Touch panel symbols will change to indicate these current mode.  ,  (F= FOLDER (folder))

Disc Player (continued)

To switch Operation Screen ON, touch the center of touch panel or press [ENTER] on the remote control.

Chapter/title Selection		Operations			
Operations	Compatible Discs	Operations			
Showing menu and selecting an item *1 Note on VCD: For VCD, touch/press [RET] / [RETURN] instead of [DVD MENU] / [DVD MENU].	*1 *1	 or *1 ↓ - *2 ↓ - *2	[DVD MENU] or [RETURN] *1 ↓ [< >] [<< >>] [^ v] [^ v] ↓ [ENTER] -	- - -	① Menu appears. ↓ ② Select the desired item. ↓ ③ Determine the setting. - Returns to the previous display.
Starting Playback from a specific chapter/title Touch the numerical key to enter a number directly 		 ↓ 0 to 9 ↓ 	- - [ENTER]	- - -	① Toggles "Chapter number input mode", "Title number input mode" and "Number input mode". ↓ ② Input desired number. ↓ ③ Playback starts. Note: • For retrying selection during number entry, touch/press [RET]/[RETURN].

Note:

- If no operation is performed for 8 seconds after you have touched [NUMBER], the operation buttons disappear.
- If the title/chapter number is inputted and no operation is performed for 2 seconds, playback will start from the number of the title/chapter entered.

*2 **On-Screen Direct Operation (Only for DVD)**
 Some DVDs allow you to operate the DVD menu by touching the screen.
 In such a case, if your targeted button is located too close to other buttons, a part of the screen may be enlarged in order that you can press the button for sure.

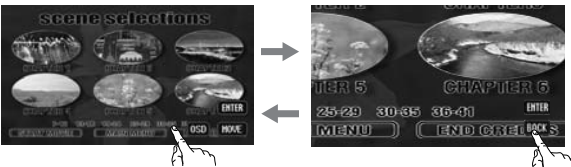

Note:

- When the current disc is not ready for the on-screen direct operation, perform operations with the buttons on the remote control or the unit.
- The on-screen direct operation of the DVD menu is not available in the DVD changer mode.

Showing Source button and Menu button
 Press [OSD]. The Source button and Menu button appear.

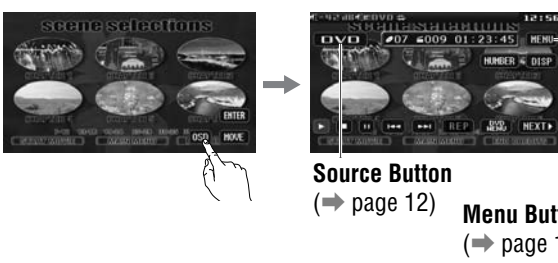

Moving operation buttons (Only for DVD)
 When the operation buttons interfere with operations, press [MOVE]. The buttons are transferred as shown below.



DVD mode display



Play/stop/pause
 Chapter/title selection
 Fast forward/fast reverse
 Repeat play
 DVD menu

Return
 Audio language/
 Angle/
 Subtitle language

Useful Function

Operations	Compatible Discs	Operations			
Subtitle Language			-	-	<ul style="list-style-type: none"> ● Touch during playback. <p>It is possible to change the subtitle language during play if multiple languages are recorded on the disc.</p> <p>Note:</p> <ul style="list-style-type: none"> ● There may be a brief delay before the subtitles appear.
Audio Language			-	-	<ul style="list-style-type: none"> ● Touch during playback. <p>It is possible to change the audio language during play if multiple audio languages are recorded on the disc.</p>
Angle			-	-	<ul style="list-style-type: none"> ● Touch during playback. <p>For DVDs which contain scenes which have been shot simultaneously from a number of different angles the same scene can be viewed from each of these different angles during play. (⇒ page 36)</p>
Stereo & Monaural			-	-	<p>It is possible to switch the audio between stereo sound and monaural sound (L or R).</p> <div style="border: 1px solid black; padding: 5px; margin-top: 10px;"> <p> : stereo sound</p> <p>↓</p> <p> : the left channel audio is output on both the left and right speakers.</p> <p>↓</p> <p> : the right channel audio is output on both the left and right speakers.</p> </div>

Note:

- If no operation is performed for 10 seconds or is touched, the operation buttons disappear.
- It may not be possible to switch the language unless the unit is at the DVD menu (⇒ previous page) or is at the DVD settings. (⇒ page 36)
- The language on the DVD settings takes priority when the power is turned on or the disc is loaded.
- The number of languages and angles depend on the disc. Some discs have only one language/angle or have no language/angle.

Notes on MP3/WMA

What is MP3/WMA?

MP3* (MPEG Audio Layer-3) and WMA (Windows Media™ Audio) are the compression formats of digital audio. The former is developed by MPEG (Motion Picture Experts Group), and the latter is developed by Microsoft Corporation. Using these compression formats, you can record the contents of about 10 music CDs on a single CD (This figure refers to data recorded on a 650 MB CD-R or CD-RW at a fixed bit rate of 128 kbps and a sampling frequency of 44.1 kHz).

*MPEG Layer-3 audio coding technology licensed from Fraunhofer IIS and Thomson.

Note:

- MP3/WMA encoding and CD writing software programs are not supplied with this unit.

Points to remember when making MP3/WMA files

Common

- High bit rate and high sampling frequency are recommended for high quality sound.
- Selecting VBR (Variable Bit Rate) is not recommended because playing time is not displayed properly and sound may be skipped.
- The playback sound quality differs depending on the encoding circumstances. For details, refer to the instructions of your own encoding software and writing software.

MP3

- It is recommended to set the bit rate to “128 kbps or more” and “fixed”.

WMA

- It is recommended to set the bit rate to “64 kbps or more” and “fixed”.
- Do not set the copy protection on the WMA file to enable this unit to play back.

⚠ Caution

- **Never assign the “.mp3”, or “.wma” file name extension to a file that is not in the MP3/WMA format. This may not only produce noise from the speaker damage, but also damage your hearing.**

Display Information

Displayed items

- | | |
|------------------|------------------------|
| ● CD-TEXT | ● MP3 (ID3 tag) |
| Disc title | Album name |
| Track title | Title and artist name |
| ● MP3/WMA | ● WMA (WMA tag) |
| Folder name | Album name |
| File name | Title and artist name |

Displayable characters

- Displayable length of file name/folder name: within 64 characters. (Unicode file and folder names are reduced by half in the number of displayable characters.)
- Name files and folders in accordance with the standard of each file system. Refer to the instructions of writing software for details.
- ASCII character set and special characters in each language can be displayed.
- Some Cyrillic characters in the Unicode can be displayed.

ASCII character set

A to Z, a to z, digits 0 to 9, and the following symbols:
(space) ! " # \$ % & ' () * + , - . / : ; < = > ? @ [\] ^ _ ` { | } ~

Note:

- With some software in which MP3/WMA format files have been encoded, the character information may not be displayed properly.
- Undisplayable characters and symbols will be converted into an asterisk (*).
- It is recommended that the length of the file name is less than 8 (excluding the file extension).

Windows Media, and the Windows logo are trademarks, or registered trademarks of Microsoft Corporation in the United States and/or other countries/regions.



Recording MP3/WMA files on a CD-media

- You are recommended to minimize the chances of making a disc that contains both CD-DA files and MP3/WMA files.
- If CD-DA files are on the same disc as MP3 or WMA files, the songs may not play in the intended order, or some songs may not play at all.
- When storing MP3 data and WMA data on the same disc, use different folders for each data.
- Do not record files other than MP3/WMA files and unnecessary folder on a disc.
- The name of an MP3/WMA file should be added by rules as shown in the following descriptions and also comply with the rules of each file system.
- The file extension “.mp3” or “.wma” should be assigned to each file depending on the file format.
- You may encounter trouble in playing MP3/WMA files or displaying the information of MP3/WMA files recorded with certain writing software or CD recorders.
- This unit does not have a play list function.
- Although Multi-session recording is supported, the use of Disc-at-Once is recommended.

Supported file systems

ISO 9660 Level 1/Level 2, Apple Extension to ISO 9660, Joliet, Romeo

Note:

- Apple HFS, UDF 1.50, Mix CD and CD Extra are not supported.

Compression formats (Recommendation: “Points to remember when making MP3/WMA files” on the previous page)

Compression method	Bit rate	VBR	Sampling frequency
MPEG 1 audio layer 3 (MP3)	32 k – 320 kbps	Yes	32, 44.1, 48 kHz
MPEG 2 audio layer 3 (MP3)	8 k – 160 kbps	Yes	16, 22.05, 24 kHz
Windows Media Audio Ver. 2, 8, 9*	32 k – 192 kbps	Yes	32, 44.1, 48 kHz

* WMA 9 Professional/LossLess/Voice are not supported.

Folder selection order/file playback order

Maximum number of files/folders

- Maximum number of files: 511 (file and folders)
- Maximum number of files in one folder: 255
- Maximum depth of trees: 8
- Maximum number of folders: 255 (Root folder is included.)

Note:

- You can shorten the duration between data read and playback by decreasing the quantity of files or folders, or the depth of the hierarchy.
- This unit counts the number of folders irrespective of the presence or absence of an MP3/WMA file.
- If the selected folder does not contain any MP3/WMA files, the nearest MP3/WMA files in the order of playback will be played.
- Playback order may be different from other MP3/WMA players even if the same disc is used.
- “ROOT” appears when displaying the root folder name.

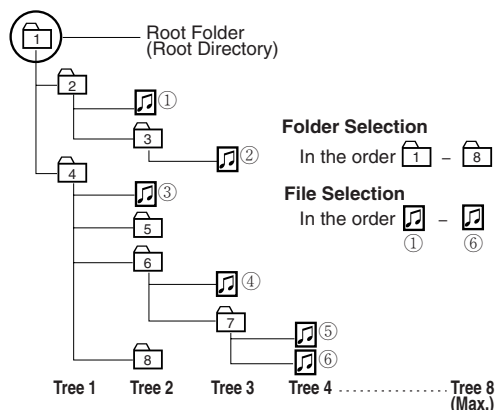

Copyright

It is prohibited by copyright laws to copy, distribute and deliver copyrighted materials such as music without the approval of copyright holder except enjoying yourself personally.

No warranty

The above description complies with our investigations as of December 2006. It has no warranty for reproducibility and displayability of MP3/WMA.

Radio

Radio Mode Selection

1 Touch "Source Button".



2 Touch **[RADIO]** on the Source Selection Screen.

Press **[SRC]** to change to the desired mode.

To switch Operation Screen ON, touch **[DISP]**.

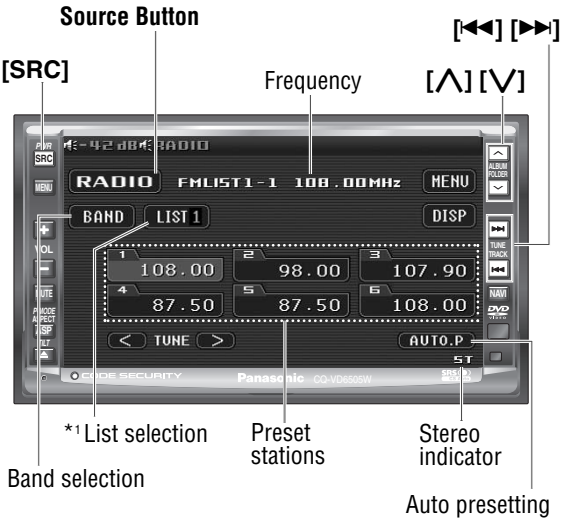

*1 Appears when **[ALL]** is selected. (⇒ page 38)
[MENU] ⇒ **[RADIO]** ⇒ **[FM SETUP]** ⇒ **[AUTO PRESET]** ⇒ **[EACH]** / **[ALL]**

Tuning

Operations				
Band Selection	[BAND] *2	[BAND]	-	*2 The displayed contents on the touch panel vary with circumstances.
List Selection	Preparation: Select [ALL]. (⇒ page 38)			
Refer to the next page.	[MENU] ⇒ [RADIO] ⇒ [FM SETUP] ⇒ [AUTO PRESET] ⇒ [EACH] / [ALL]			
	[LIST 1] *2	[BAND]	-	*2 The displayed contents on the touch panel vary with circumstances.
				*3 From the touch panel, you can toggle only Lists 1-3, but not [AM] . To change to [AM] , touch [BAND] .
	There are 6 stations in each list. You can call up next 6 stations by switching from one list to another.			
Station Selection				Up Down
Seek Tuning				Up Down
Touch/press and hold for more than 0.5 second then release. Seeking starts.				

..... Touch/Press and hold

Preset Memory

Manual Preset Memory

Up to 6 stations can be preset in each band.

Select a band and frequency.

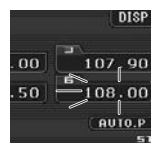

blinks once

- Touch and hold for more than 2 seconds.
- The frequency blinks once, and a receiving station is saved in the memory. New stations overwrite existing saved stations.

Auto Preset Memory

A BAND

Six stations are automatically preset in each band.

Preparation: Select [EACH]. (→ page 38) (default: [EACH])

[MENU] ⇒ [RADIO] ⇒ [FM SETUP] ⇒ [AUTO PRESET] ⇒ [EACH] / [ALL]

Select a band.



6 stations with first to 6th highest in signal strength of each band will be preset.

- Touch/press and hold for more than 2 seconds.
- Once set, the preset stations are sequentially scanned for 5 seconds each. (scanning) New stations overwrite existing saved stations.

B LIST 1

In total 18 FM stations are automatically preset.

Preparation: Select [ALL]. (→ page 38)

[MENU] ⇒ [RADIO] ⇒ [FM SETUP] ⇒ [AUTO PRESET] ⇒ [EACH] / [ALL]



18 stations with first to 18th highest in signal strength of all FMs will be preset at once.

- Touch/press and hold for more than 2 seconds.
- Once set, the preset stations are sequentially scanned for 5 seconds each. (scanning) New stations overwrite existing saved stations.

Preset Station Calling

Select a band or a list.



- Touch desired preset button.

Preset Swap

A station preset is interchangeable with another station preset.

Preparation: Select [ALL]. (→ page 38)

[MENU] ⇒ [RADIO] ⇒ [FM SETUP] ⇒ [AUTO PRESET] ⇒ [EACH] / [ALL]



The preset station selected in the step ① is interchangeable with the targeted preset channel selected in the step ② (Preset Swap).

- ① Select the list and the preset number that contains the station to be interchanged (see "Preset station calling" above).
- ② Select the list and hold down the preset number that contains the targeted channel for more than 2 seconds.

..... Touch/Press and hold

AV1/AV2

Please refer to the separate "System Upgrade Guidebook" for how to operate this unit when optional devices are connected.

25

Preparation:

- Connect an optional external device to the AV1/AV2.

AV Mode Selection

You can view the images and listen to the sounds from the connected external devices in the AV1/AV2 mode respectively.

1 Touch "Source Button".



2 Touch **AV1/AV2** (AV1/AV2) on the Source Selection Screen.

Source Button
[SRC]



To switch Operation Screen ON, touch the center of touch panel or press [ENTER] on the remote control.



Press [SRC] to change to the desired mode.

Note:

- You can set up the system so that the AV mode is not selected (source skip). (➔ page 37) (AV set to NAVI INPUT is not skipped even if [SOURCE SKIP] is set to [ON].)
- If no operation is performed for 10 seconds or [DISP] is touched, the operation buttons disappear.

• AV terminal is not used for the Panasonic car navigation system (available in future). Refer to [NAVI SETUP] for setting. (➔ System Upgrade Guidebook)

Settings



Preparation: To display menu in Chinese, Execute **MENU DISPLAY** (Language setting). (⇒ page 31)

USER

DISPLAY UNIT	Display adjustment	(⇒ page 30)
CLOCK	Clock setting	(⇒ page 30)
ID-CODE	ID Code Setting	(⇒ page 30)
MEMORY CLEAR	Memory clearance	(⇒ page 31)
OTHER	Other settings	(⇒ page 31)

SCREEN

DIMMER	Adjusting the brightness	(⇒ page 32)
PICTURE	Display appearance	(⇒ page 32)

AUDIO

SOUND SETUP	Sound setting	(⇒ page 32)
GRAPHIC-EQ	Setting and adjusting of graphic equalizer	(⇒ page 32)
CS Auto	CS Auto setting	(⇒ page 33)
SP SETUP	Setting of the absence/presence of each speaker	(⇒ page 34)
SP LEVEL	Adjusting the output balance of each speaker	(⇒ page 34)
TIME ALIGNMENT	Delay time setting of each speaker	(⇒ page 35)
SOURCE LEVEL	Setting the AV1/AV2 input level	(⇒ page 35)
CROSS OVER	Cut off frequency	(⇒ page 35)

DVD

LANGUAGE	Language Setting	(⇒ page 36)
DISPLAY	Appearance of DVD image	(⇒ page 36)
DVD SOUND	DVD sound setting	(⇒ page 37)
MULTI-CH	Sound output selection	(⇒ page 37)

INPUT/OUTPUT

NAVI SETUP	Navigation setting	(*1)
SOURCE SKIP	Source skip	(⇒ page 37)
INPUT SELECT	Input selection	(*1)
OUTPUT SELECT	Output selection	(*1)
H-F SETUP	Hands-free setting	(*1)

RADIO

FM SETUP	Setting for FM stations	(⇒ page 38)
AM SETUP	Setting for AM stations	(⇒ page 38)

(*1) Please refer to the System Upgrade Guidebook.

MENU Operation

(Example: DVD mode)

1



Touch **MENU** in Operation Screen.

2



Touch desired setting.

3

(Example: setting screen of "DISPLAY UNIT" → page 30)

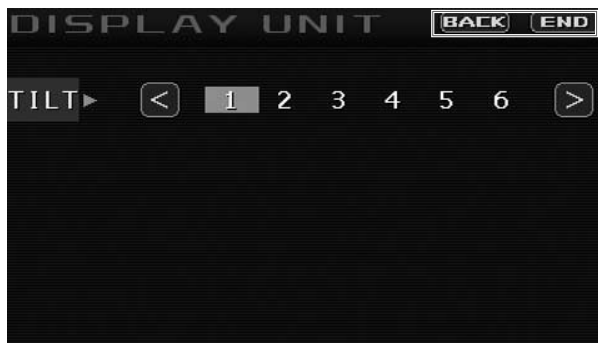
**BACK**

Determines the setting and goes back to the previous menu out of the menu.

END

Determines the setting and gets out of the menu.

Note:

- The display returns to the previous status if there is no operation for more than 60 seconds after changing to the setting menu.

[SRC]

(Exit from the menu)

**[NAVI]**
(Select/adjust)**[MENU]**

(Shows the menu screen/Goes back to the previous menu)

Settings (continued)

- USER
- SCREEN
- AUDIO
- DVD
- INPUT/OUTPUT
- RADIO

DISPLAY UNIT

29

Display adjustment

TILT (Tilt angle adjustment)

- 1
- 2
- 3
- 4
- 5
- 6

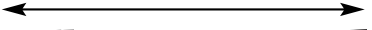

default: 1

CLOCK

Clock setting

DISPLAY (Clock display)

ON : clock display ON (“0:00” is displayed before adjusting the clock.)

OFF : clock display OFF

default: OFF

HOUR ADJUST (Hour adjustment)

< : puts back hour.

> : puts forward hour.

MINUTE ADJUST (Minute adjustment)

< : puts back minute.

> : puts forward minute.

Note:

- To start the clock, touch/press **END**/[SRC].
- Set the Daylight Saving Time manually.

default: HOUR ADJUST: 0
MINUTE ADJUST: 0

ID-CODE

ID Code Setting

Prior to operating this unit, it is advisable to assign a 4-digit ID code for security. Once the ID code has been set, the unit cannot be operated if the main power supply is disconnected then re-connected. It is electronically locked so that a thief cannot use the stolen unit unless that person knows the code you have set.

The ID code operation must be performed only by the person to whom the unit belongs.

Generally, it is not necessary to enter the ID code each time when using the unit if it has not been disconnected from the main power supply (car battery).

0 to 9 4 digits numeric code

default: none

How to set your ID code (for the first time)

- ① Enter an 4 digit ID code.
- ② Enter the same 4 digit ID code again.

How to change your ID code

- ① Enter the preset (old) 4 digit ID code. If the wrong ID code is entered, a new ID code cannot be registered.
- ② Enter a new 4 digit ID code.
- ③ Enter the new 4 digit ID code again.

How to cancel the known ID code

- ① Enter the preset (old) 4 digit ID code. If the wrong ID code is entered, it is not possible to cancel the ID code function.
- ② Touch and hold **CLEAR** until “COMPLETED!” is displayed. The ID code cancelling procedure is completed. The unit now works without an ID code.

Note:

- Should your unit ever require service, cancel your ID code before sending for repair.
- The ID code setting cannot be eliminated even by the memory clear function.
- The inputted code is not displayed for your security.

⚠ Caution

- Record your registered ID code and keep it in a secure location. (Fill in the ID code memo (⇒ page 46).) If you forget it, you will be unable to use the unit. In case you forget the ID code, please consult your nearest Panasonic Service Center.

MEMORY CLEAR

Memory clearance

The state of all of the current memories are returned to default settings.

Note:

- The ID code is not deleted by executing memory clear.

: clears the memory to default settings

: no memory clear.
The display returns to the previous one.



appears when is selected.

: proceed.

: no memory clear.

⚠ Caution

- Be aware that this setting restores the unit to default settings, so that all the memories and settings that you have set will be eliminated.

OTHER

Other settings

(Beep setting)

: operation sound (beep) ON

: operation sound (beep) OFF

default:

(Setting ACC selection ON and OFF)

: sets to ON if your car has ACC position.

: sets to OFF if your car has no ACC position.

default:

Note:

- For an ACC-equipped car, select ON. The following functions are available.
 - The power is turned on automatically when inserting a disc or magazine.
 - selection disables turning on the power of the main unit through the remote control.

⚠ Caution

- Be sure to select OFF when your car has no ACC position in the ignition switch. Failure to do this could cause the battery to go dead.

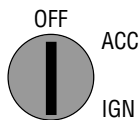

(Remote control setting)

: main unit-specific remote control

: rear monitor (option)-specific remote control

default:

(Security LED setting)

: LED indicator not blinking with ignition key being at out-of-ACC

: LED indicator blinking with ignition key being at out-of-ACC

default:

(Language setting)

: displays the menu in English.

: displays the menu in Chinese.

default:

Settings (continued)

SCREEN (Display)

DIMMER

31

Adjusting the brightness

: automatically adjusted according to ambient light intensity.

← Darker Brighter →

default:

PICTURE

Display appearance

(Adjust the image contrast)

: decreases the contrast between black and white.

: increases the contrast between black and white.

(Adjust the image brightness)

: darkens.

: lightens.

(Adjust the image color depth)

: lightens the depth of color on the display.

: deepens the depth of color on the display.

(Adjust the image tone or tint)

: emphasizes red in the color image.

: emphasizes green in the color image.

AUDIO

SOUND SETUP

Sound Set Up

(Sound effect setting)

: no GEQ or CS Auto setting

: goes to GEQ (GRAPHIC-EQ) setting

: goes to CS Auto setting

default:

GRAPHIC-EQ (Graphic-equalizer)

Graphic-equalizer

Six EQ presets are already provided at shipment in this unit. To recall a preset memory, select the corresponding preset buttons [1] to [6].

: (Flat) flat frequency response

: (Rock) speedy and heavy sound

: (Pop) wide-ranged and deep sound

: (Vocal) clear sound

: (Jazz) jazz-specific deep sound

: (Club) club and disco-specific sound

You may set your own EQ or modify factory presettings in each memory button by following the instructions below:

Adjusting level of each preset

The level of each of the 7 frequency bands can be adjusted.

① Select the preset number that you prefer to adjust.

② Touch/press / to adjust each frequency.

③ Touch/press the same preset number for more than 2 seconds.

Frequency band

(Hz)

Adjustment range: -12 dB to +12 dB (in 2 dB steps)
default: ±0 dB for each band

Note:

- The new level adjustment will overwrite the previous level adjustment.
- For resuming the factory settings, touch and hold (INIT (initialize)) for more than 2 seconds.

- To set the level to flat, touch and hold **FLAT** (flat) for more than 2 seconds.
- Expectable effects vary with the audio format to be used, settings in the menu, and other factors.



CS Auto

CS Auto Setting

SELECT

(Customizing the setting)

FOCUS

(Raises the sound image)

FRONT FOCUS

(Raises the front sound image)

> : more

< : less

REAR FOCUS

(Raises the rear sound image)

> : more

< : less

CENTER FOCUS

(Raises the central sound image)

> : more

< : less

Setting range: off, +1 to +10
default: off

Note:

• FOCUS®

Focus is an audio technology that moves the sound image of playing sound vertically to reproduce the sounds of instruments and voices clearly.

TruBass

(TruBass Setting)

FRONT TruBass

(Applies to the front speakers)

> : more

< : less

REAR TruBass

(Applies to the rear speakers)

> : more

< : less

SUB-W TruBass

(Applies to the Sub-woofer)

> : more

< : less

Setting range: off, +1 to +10
default: off

Note:

• TruBass®

TruBass is an audio technology to which the technique of bass sound reproduction used in pipe organs is electrically applied, and in which an equalizer is not used at all and bass sound from the speakers to be used is richly reproduced.

Mixing

(Adjusts the SRS effect)

FRONT TO REAR Mixing

(Adjusts the SRS effect (front) on rear speakers)

> : more

< : less

CENTER TO REAR Mixing

(Adjusts the SRS effect (center) on rear speakers)

> : more

< : less

Setting range: off, +1 to +10
default: +5

Settings (continued)

(AUDIO continued)

33

SP SETUP (Speaker set up)

Setting the absence/presence and size of each speaker

FRONT (Front speaker setting)

SMALL : for small speakers, or when bass playback is not possible

LARGE : for large speakers, when bass playback is possible (at least 100 Hz or lower)

default: **LARGE**

CENTER (Center speaker setting)

NONE : when not using a center speaker

SMALL : for small speakers, or when bass playback is not possible

LARGE : for large speakers, when bass playback is possible (at least 100 Hz or lower)

default: **NONE**

* A center speaker (option, EAB-CF2 recommended) is required.

SUR (Surround speaker setting)

NONE : when not using a surround speaker

SMALL : for small speakers, or when bass playback is not possible

LARGE : for large speakers, when bass playback is possible (at least 100 Hz or lower)

default: **LARGE**

SUB - W (Subwoofer speaker setting)

YES : when using a subwoofer

NO : when not using a subwoofer

default: **NO**

* A subwoofer (option, CJ-SW3003 recommended) is required. A power amplifier (option) is also required for connecting a subwoofer.

Note:

- While the private mode is active, only **FRONT** can be adjusted.

PHASE (Phase setting)

0° : subwoofer phase 0 degree

180° : subwoofer phase 180-degree inverted

Note:

- This setting is feasible only when **SUB-W** is set to **YES**.

default: **0°**

SP LEVEL (Speaker level)

Adjusting the output balance of each speaker

FRONT L (Left front speaker output balance)

< : down, **>** : up

CENTER (Center speaker output balance)

< : down, **>** : up

FRONT R (Right front speaker output balance)

< : down, **>** : up

R • SUR (Right surround speaker output balance)

< : down, **>** : up

L • SUR (Left surround speaker output balance)

< : down, **>** : up

SUB - W (Subwoofer speaker output balance)

< : down, **>** : up

Setting range: -10 dB to +10 dB (1 dB steps)
default: ± 0 dB for all speakers

- If the speaker setting is **NONE** or **NO** for a speaker, the test signal is not output and that speaker cannot be selected.
- Press **[+]** or **[-] (VOL)** to adjust the volume of the test signal.

**Note:**

- While the private mode is active, only **FRONT L** and **FRONT R** can be adjusted.

TEST TONE (Test tone output)

ON : enables the test tone.

OFF : disables the test tone.

default: **OFF**

- When the test tone is set to on, test signal (a continuous tone) is output from each speaker for approximately 2 seconds.

Adjust the output balance so that the tone appears to have the same volume from each speaker.

Adjusting the output balance:

Adjust the volume of all of the other speakers to the volume level of the speaker from which the test signal appears to be the quietest.

TIME ALIGNMENT

(Delay time setting of each speaker)

Adjusting the timing with which the audio from each speaker reaches the listener's position

CENTER (Center speaker delay time setting)

< : down, **>** : up

Setting range: 0 ms to 5 ms (1 ms steps)
1 ms = 0.001 seconds
default: 0 ms

SUR (Surround speaker delay time setting)

< : down, **>** : up

Setting range: 0 ms to 15 ms (1 ms steps)
1 ms = 0.001 seconds
default: 0 ms

- Make this adjustment while listening to sound.
- If the speaker setting is **NONE** for a speaker, that speaker cannot be selected.
- When "PRO LOGIC" is displayed, 15 ms are automatically added to the delay time setting for the surround speakers.

SOURCE LEVEL

Setting the AV1/AV2 input level

Make this setting if it is not possible to adjust the volume through the connected device (on the output side).

AV1 LEVEL (Setting for AV1)

LOW : sets the level low/sound volume increases.

HIGH : sets the level high/sound volume decreases.

default: **HIGH**

AV2 LEVEL (Setting for AV2)

LOW : sets the level low/sound volume increases.

HIGH : sets the level high/sound volume decreases.

Note:

- If the input level from AV1/AV2 is too high, the audio will not be output normally.
- **After setting the input level**
The volume can be adjusted by pressing **[+]** or **[-]** (**VOL**).

default: **HIGH**

CROSS OVER

Cut off frequency

LPF CUT OFF (Sub-woofer Low Pass Filter)

< : down, **>** : up

Setting range: 63 Hz to 200 Hz
default: 125 Hz

HPF CUT OFF (High Pass Filter)

< : down, **>** : up

Setting range: off, 63 Hz to 200 Hz
default: off

Note:

- This setting is not available if **CS Auto** is set to **ON**.
- **HPF CUT OFF** is enabled only on the front speakers (R/L) and rear speakers (L/R).

Settings (continued)



LANGUAGE

35

Language Setting

MENU (DVD menu language)

- ENG** : English
 - CHN** : Chinese
 - FRA** : French
 - OTHER** : other language. Input the language code.
(⇒ page 49)
- default: **ENG**

SUBTITLE (Subtitle language)

Note:

- A disc supporting closed captioning and subtitles may overlap each other on the screen. In this case, turn the subtitle off.

- ENG** : English
 - CHN** : Chinese
 - FRA** : French
 - OTHER** : other language. Input the language code.
(⇒ page 49)
- default: **ENG**

AUDIO (Audio language)

Note:

- These adjustments being executed, playback will start from the beginning of a disc.

- ENG** : English
 - CHN** : Chinese
 - FRA** : French
 - OTHER** : other language. Input the language code.
(⇒ page 49)
- default: **ENG**

DISPLAY

Display aspect and DVD software mode

DVD ASPECT (Display aspect setting)

- NARROW** : plays a video in 4:3 screen.
 - WIDE** : plays a video in wide screen (16:9).
- default: **WIDE**

LETTER BOX (DVD software mode)

- PAN & SCAN** : plays wide-screen video in Pan & Scan mode (in which the left and right edges of the screen are cut off).
 - LETTER BOX** : plays wide-screen video in letterbox mode (in which black bands appear at the top and bottom of the screen).
- default: **PAN & SCAN**

Note:

- Set the software setting according to the symbol used on jacket. (⇒ page 16)
- DVD software mode setting is ignored if **PAN & SCAN** or **LETTER BOX** is already set in the software.
- Screen aspect of the display unit is changed according to the aspect ratio setting (⇒ page 39) and DVD software's aspect.

TV TYPE (AV-OUT terminal setting)

- PAL** : sets PAL in accordance with the equipment connected to AV-OUT.
 - NTSC** : sets NTSC in accordance with the equipment connected to AV-OUT.
- default: **PAL**

ANGLE MARK (Angle mark setting)

The angle mark is displayed to indicate the parts where multi-angle data is recorded.

- ON** : activates angle mark.
 - OFF** : inactivates angle mark.
- default: **ON**

DVD SOUND

DVD sound setting

PRO LOGIC

(5.1 channel listening in Dolby surround sound)

ON

: activates Pro Logic.

OFF

: inactivates Pro Logic.

default: OFF

Note:

- This setting is enabled only in the DVD/VCD/CD player mode.
- ON selection in some audio settings may disable audio output from the subwoofer.

DOWN MIX

(To use the down mix function, specify the type.)

Lo/Ro

: simple stereo down mix
(Lo = Left only, Ro = Right only)

Lt/Rt

: surround element decodable down mix
(Lt = Left total, Rt = Right total)

Note:

- This function is available only when "Dolby Digital" or "dts" source is playing and when sound comes out only from the front speakers adjusted with SP SETUP.

default: Lt/Rt

DR COMP

(Dynamic Range Compression)

Maintaining the ambience even while listening at a low volume level

Compression style selecting

STD

: DR COMP ON

MIN

: made with the greatest compression, roughly equivalent to a TV broadcast.

OFF

: DR COMP OFF

default: OFF

MULTI-CH (Multiple channel)

Sound output of Dolby Digital 2 ch. from all speakers

ON

: changes sound from 2 ch. to 5.1 ch.

OFF

: keeps the source output 2 ch. sound.

default: OFF

USER

SCREEN

AUDIO

DVD

INPUT/OUTPUT

RADIO

NAVI SETUP (Navigation set up)

(→ System Upgrade Guidebook)

SOURCE SKIP

Source skip

AV1 SKIP

(AV1 skip)

If AV1 is not used, the AV1 mode is skipped when changing the mode.

ON

: skips AV1.

OFF

: does not skip.

default: OFF

AV2 SKIP

(AV2 skip)

If AV2 is not used, the AV2 mode is skipped when changing the mode.

ON

: skips AV2.

OFF

: does not skip.

default: OFF

Note:

- When external devices are connected to this unit without involving the Expansion Module (CY-EM100N, option), AV2 SKIP is not enabled because the connected external devices are identified as AV2.

INPUT SELECT

(→ System Upgrade Guidebook)

OUTPUT SELECT

(→ System Upgrade Guidebook)

H-F SETUP

(→ System Upgrade Guidebook)

Settings (continued)

USER SCREEN AUDIO DVD INPUT/OUTPUT **RADIO**

FM SETUP

Setting for FM stations

NOISE SUPPRESSION (FM IF filter switching)

AUTO : adjusted automatically

NARROW : narrows the frequency bandwidth to be received to prioritize noise reduction.

WIDE : widens the frequency bandwidth to be received to prioritize sound quality.

default: **AUTO**

AUTO PRESET (Auto preset setting)

EACH : saves the preset stations in each band.

ALL : saves the preset stations in all FM lists regardless of band.

default: **EACH**

AM SETUP

Setting for AM stations

NOISE SUPPRESSION (Noise suppression)

NARROW : narrows the frequency bandwidth to be received to prioritize noise reduction.

MID : goes between **NARROW** and **WIDE**.

WIDE : widens the frequency bandwidth to be received to prioritize sound quality.

default: **MID**

Other Settings



[ASP]

Aspect Ratio

Default: NORMAL

Mode: 4 types

Press and hold **[ASP]** on the display unit to change the aspect ratio as follows.

NORMAL

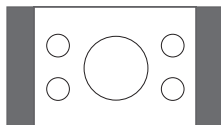

- The conventional display image has a 4 to 3 ratio of horizontal to vertical.
- In this case, a blank area remains on the right and left sides of the display.

FULL

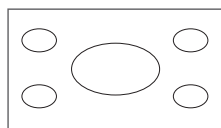

- The screen is extended horizontally as a whole to the aspect ratio of 16 to 9.
- The extension ratio is the same at any point of the screen.

ZOOM

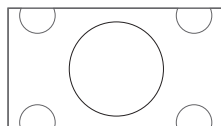

- The screen is fully extended at the normal aspect ratio of 4 to 3.
- The top and bottom of the screen are slightly cut.

JUST

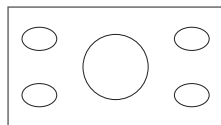

- The screen is extended horizontally to the aspect ratio of 16 to 9.
- The extension ratio increases toward the right and left ends of the screen.

Note:

- This adjustment is common to video mode.
- You cannot change the aspect in the menu screen and a screen in the CD, MP3/WMA, radio and CD changer mode. These are fixed to "FULL" as well as a Navigation Image.
- When the rear view camera is in operation with the transmission gear shift in the reverse position, the image is shown on the "FULL" screen only.
- In some cases, the picture looks different from the original one due to your selection of aspect.

Caution

- This is to remind you that compression or extension of the screen using the aspect ratio (screen mode) changing function of this product for commercial purpose of profit making or viewing/listening by the public could infringe on the rights of the author protected by the copyright law.
- If you expand normal picture (4 to 3) by using "JUST", "ZOOM" or "FULL" aspect to the full of the screen, you might not see the periphery of the picture, or you might see a distorted picture. Therefore, use the "NORMAL" mode to see the original picture as the author intended it.

Settings (continued)

Other Settings (continued)



[ASP] (P•MODE)

Private Mode

You can mute the sounds from the rear speakers if necessary. Activation of the private mode allows you to enjoy the front monitor and rear monitor independently with different sources at the same time.

Default: Private mode off



“P • MODE” indicator lights when the Private Mode is activated.

Press and hold [ASP] (P•MODE) on the main unit for more than 2 seconds to activate the private mode function or inactivate it in turn.

Note:

- Be sure to set to OFF when you do not use the private mode.
- It is not possible to choose and set the **CS Auto** (⇒ page 33) and **TIME ALIGNMENT** (⇒ page 35) on the sound setting menu while private mode is active.

Private mode
Off

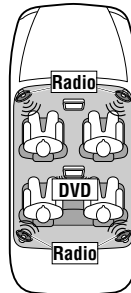

Private mode
On

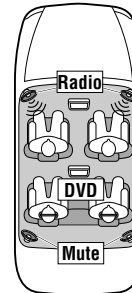

Troubleshooting



□ If You Suspect Something Wrong

Check and take steps as described below.

If the described suggestions do not solve the problem, it is recommended to take the unit to your nearest authorized Panasonic Service Center. The product should be serviced only by qualified personnel. Please refer checking and repair to professionals. Panasonic shall not be liable for any accidents arising out of neglect of checking the unit or your own repair after your checking. **Never take measures especially those other than indicated by *italic* letters in "Possible Solution" described below because those are too dangerous for users to handle themselves.**

⚠ Warning

- Do not use the unit in an irregular condition, for example, without sound, or with smoke or a foul smell, which can cause ignition or electric shock. Immediately stop using the unit and consult your dealer.
- Never try to repair the unit by yourself because it is dangerous to do so.

■ Common

Problem	Possible cause → Possible solution
No power to the unit	<p>The power cord (battery, power and ground) is connected in the wrong way. → Check the wiring.</p> <p>Fuse blows out. → Eliminate the cause of fuse blowout and replace the fuse with new one. Consult your dealer.</p>
Sound is not generated.	<p>MUTE is set to ON. → Set MUTE to OFF.</p> <p>The wiring of speaker lines is not correct, or a break or poor contact arises. → Check the wiring in accordance with the wiring diagram. (Installation Instructions)</p>
Noise	<p>There is an electromagnetic-wave generator such as a cellular phone near the unit or its electrical lines. → Keep the electromagnetic-wave generator such as a cellular phone away from the unit and the wiring of the unit. In case noise cannot be eliminated due to the wiring harness of the car, consult your dealer.</p> <p>The contact of the ground lead is poor. → Make sure that the ground lead is connected to an unpainted part of the chassis securely.</p>
Noise is made in step with engine revolutions.	<p>Alternator noise comes from the car. → Change the wiring position of the ground lead. → Mount a noise filter.</p>
Some operations are not executable.	<p>Some operations are not executable in particular modes such as menu mode. → Read the operating instructions carefully and cancel the mode. If the unit is still out of order, consult your dealer.</p>
No sound from speaker(s)	<p>There is a break, a short circuit, poor contact or wrong wiring regarding the speaker wiring. → Check the speaker wiring.</p>
The speaker channels are reversed between right and left.	<p>The speaker wiring is reversed between right and left. → Perform the speaker wiring in accordance with the wiring diagram.</p>
The power of the unit fails unintentionally.	<p>The safety device works. → Consult your dealer, or your nearest Panasonic Service Center.</p>

Troubleshooting (continued)

Radio

<p>Poor reception or noise</p>	<p>Antenna installation or wiring of antenna cable is faulty. → Check whether the antenna mounting position and its wiring are correct. In addition, check to see whether the antenna ground is securely connected to the chassis.</p> <p>No power is supplied to the antenna amplifier (when using a film antenna, etc.). → Check the wiring of the antenna power lead.</p>
<p>The number of auto preset stations is less than 6.</p>	<p>The number of receivable stations is less than 6. → Move to an area where receivable stations number is maximum, and try presetting.</p>
<p>Preset stations cannot be stored.</p>	<p>The contact of the battery lead is poor, or the battery lead is not always powered. → Make sure that the battery lead is connected securely, and preset stations again.</p>

CD

<p>No playback or disc ejected</p>	<p>The disc is inserted upside down. → Insert a disc correctly.</p> <p>There is a flaw or foreign object on the disc. → Remove the foreign object, or use a flawless disc.</p>
<p>Sound skipping or noise</p>	<p>There is a flaw or foreign object on the disc. → Remove the foreign object, or use a flawless disc.</p>
<p>Sound skipping due to vibration</p>	<p>The unit is not sufficiently secured. → Secure the unit to the console box.</p> <p>The unit is tilted at over 30° in the front-to-end direction. → Make the angle 30° or less.</p>
<p>Disc unejectable</p>	<p>Something such as a peeled label obstructs the disc coming out. → Press and hold the [▲] for more than 10 seconds (disc forced ejection). In case that the disc forced ejection does not work, consult your dealer.</p> <p>The microcontroller in the unit operates abnormally due to noise or other factors. → Unplug the power cord and plug it again. In case the unit is still out of order, consult your dealer.</p>

■ MP3/WMA

No playback or disc ejected

The disc has unplayable formatted data.
 ➔ **Refer to the description about MP3/WMA for playable sound data except CD-DA (i.e. music CD).**

The CD-R/RWs that are playable on other devices are not playable on this unit.

The playability of some CD-R/RWs may depend on the combination of media, recording software and recorder to be used even if these CD-R/RWs are playable on other devices such as a PC.
 ➔ **Make CD-R/RWs in a different combination of media, recording software and recorder after referring to the description about MP3/WMA.**

Sound skipping or noise

There is a flaw or foreign objects on the disc.
 ➔ **Remove the foreign objects, or use a flawless disc. For MP3/WMA, refer to the description about MP3/WMA.**

Playing VBR (Variable Bit Rate) files may cause sound skipping.
 ➔ **Play Non-VBR files.**

Note:

- Refer to “Notes on MP3/WMA” (➔ page 22)

■ DVD

Cannot switch the audio language/subtitle language/angle.

- It is not possible to switch if the disc does not have multiple audio languages/subtitle languages/angles recorded on it. (Refer to the guide provided with your disc.)
- Some discs permit switching through a menu screen.
- Sometimes, switching angles is possible only with certain scenes.

The audio/subtitle language selected in the DVD settings is not used.

If audio or subtitles in that language are not recorded on the disc, the audio or subtitles do not switch to that language. (Some discs permit switching through a menu screen. Refer to the guide provided with your disc.)

A DVD-R or DVD-RW is not playable.

The disc is still unfinalized.
 ➔ **Finalize the disc.**
Refer to “Before Disc Playback” (➔ page 16) or “Notes on Discs” (➔ page 48) for other cases.

The disc is in the video recording (VR) format.
 ➔ **Play video formatted discs.**
Refer to “Before Disc Playback” (➔ page 16) or “Notes on Discs” (➔ page 48) for other cases.

Troubleshooting (continued)

■ Display Settings

The brightness of the screen is not stable.

AUTO dimmer is selected.
 ➔ **Select one of the dimmer levels from among 1 to 4 to make the dimmer adjustment become free from light intensity.**

The picture is dark. The picture is whitish. Something is wrong with the picture. The picture is light in color.

The screen is not adjusted properly.
 ➔ **Make every adjustment of the screen.**

■ Remote control unit

No response to pressing buttons

The battery is inserted in the wrong direction. A wrong battery is inserted.
 ➔ **Insert a correct battery in the correct direction.**

The battery is weak.
 ➔ **Replace the battery with new one.**

The aiming direction of the remote control unit is wrong.
 ➔ **Aim the remote control unit at the sensor of the unit and press buttons.**

The sensor is exposed to direct sunlight. (The remote control unit may not be operable when the sensor is exposed to direct sunlight. In such a case, the system is not faulty.)
 ➔ **Block off sunlight to the sensor.**

REAR is selected for the remote control setting.
 ➔ **Select **FRONT** for the remote control setting.**

Unable to turn on the power of the main unit through the remote control

OFF is selected for the ACC selection.
 ➔ **Select **ON** for the ACC selection.**
 ➔ **Press **[SRC]** (**PWR**) of the main unit to turn on the power.**

■ Sound settings

No sound from left, right, front, or rear speaker.

Cables are not correctly connected.
➔ **Connect the cables correctly.**

Left and right sounds are reversed.

The speaker leads are connected in reverse between right and left.
➔ **Connect the speaker wires to the correct one.**

No sound on the speaker.

The speaker setting is NO or NONE.
➔ **Set it correctly.**

No sound from the subwoofer

Playing back a disc having a subwoofer channel

- Subwoofer is set to NO in the speaker setting.
➔ **Set subwoofer to YES.**
- Private mode is set to ON.
➔ **Set private mode to OFF.**
- Pro Logic is set to ON.
➔ **Set Pro Logic to OFF.**

Troubleshooting (continued)

❑ Error Display Messages

■ CD/MP3/WMA/DVD/VCD (Video CD)

45

Display	Possible cause → Possible solution
NON PLAYABLE DISC	Disc is dirty, or is upside down. → Check disc. Disc has scratches. → Check disc.
MECHANISM ERROR	No operation by some cause. → Press [▲]. If failure persists, press the reset switch. If normal operation is not restored, call the store where you purchased the unit or the nearest Panasonic Service Center.
FILE ERROR	The type of the file that is selected is not supported. → Check disc.
PROTECTED	A WMA file can be copyrighted. → The file protected by copyright is not playable.
NO DISC	No disc is in the player. → Insert disc into the disc slot.
REGION ERROR	The region code of the disc to be used is not compatible with this unit. → Press [▲] and check the disc.

Note:

- There may be cases when the disc numbers affected by an error are displayed before “NON PLAYABLE DISC”.

❑ In case you forget the ID code...

In case you forget the ID code, please consult your nearest Panasonic Service Center.

ID code memo

Copy the memo below, fill in the ID code, and keep it in a secure location.

Model No. CQ-VD6505W

ID CODE

❑ Product Servicing

If the suggestions in the charts do not solve the problem, we recommend that you take it to your nearest authorized Panasonic Service Center. The product should be serviced only by a qualified technician.

❑ Replacing the Fuse

Use fuses of the same specified rating (**15 A**). Using different substitutes or fuses with higher rating, or connecting the product directly without a fuse, could cause fire or damage to this unit.

If the replacement fuse fails, contact your nearest Panasonic Service Center for service.

❑ If the Unit Begins to Malfunction...

Reset switch

Insert a hard, slender stick into the hole and push the switch.

Important

Push the switch only when the unit fails to operate with any buttons. (Stored settings and adjustments are not cleared.)

If the unit fails to return to normal condition, call the nearest Panasonic Service Center and ask for repairs.



Reset switch

Note:

- If the ID-CODE has been already set, you will be asked to enter the ID-CODE right after the unit is restarted.

Maintenance

❑ Caution on Cleaning

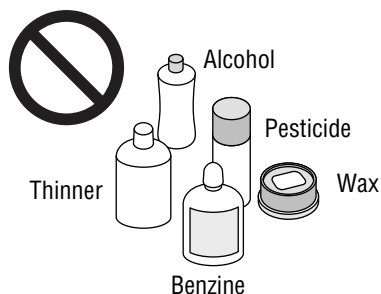

Your product is designed and manufactured to ensure a minimum of maintenance. Use a dry soft cloth for routine exterior cleaning. Never use benzine, thinner or other solvents.

❑ Cleaning this Unit

When the unit is dirty, wipe the surface of the display using the Wiping Cloth (supplied).

Cleaning without the supplied cloth

- 1 Moisten the soft cloth in dishwashing soap diluted with water and wring well.
- 2 Wipe lightly. Go over the same surface with a dry cloth.



Note:

- Since there is the possibility of water drops getting inside of the unit, do not directly apply cleanser to the surface.
- Do not scratch the screen with your nails or other hard objects. The resulting scratches or marks will obscure the images.

⚠ Caution

- If water drops or similar wet substances get inside the monitor, it may cause a malfunction.

Notes on Discs



How to hold the disc

- Do not touch the underside of the disc.
- Do not scratch the disc.
- Do not bend disc.
- When not in use, keep disc in the case.

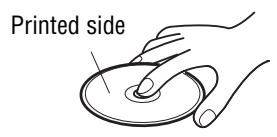

Do not use discs that fit any of the descriptions given below. Using these discs may damage the discs or cause the unit to malfunction.

- Special discs in a shape which is not round



- Partly or wholly transparent disc

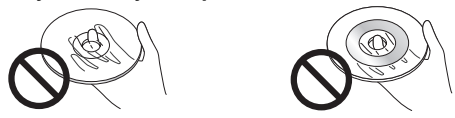

Wholly transparent disc* Partly transparent disc
 *Wholly semi-transparent disc may not be played back.

- Discs with adhered labels, etc. on them



Disc with adhered stickers or tape Labels created by a printer or tape

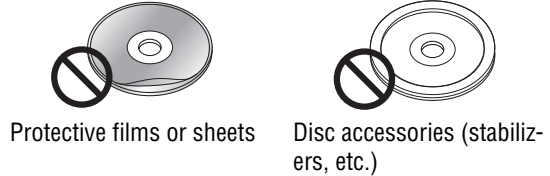

Protective films or sheets Disc accessories (stabilizers, etc.)

- Damaged or deformed discs



Shoddily made discs Discs with cracks, scratches or parts missing



Discs with burrs
 Please remove the burrs before use.

Disc insert

The surfaces of new discs tend to be slippery. Therefore, when using such a disc for the first time, it may not load satisfactorily even when it has been inserted into the unit. At a time like this, insert the disc into the unit as far as it will go until it is loaded properly.

- When inserting a disc into or ejecting and removing it from the unit, insert it straight in or eject and remove it straight out in parallel with the unit. Otherwise, the disc may be scratched or marked in the process.
- When inserting a disc, do not put one disc on another. Failure to observe this may cause the discs to be jammed.

Do not leave discs in the following places:

- Direct sunlight
- Near car heaters
- Dirty, dusty and damp areas
- On seats and dashboards

Disc cleaning

Use a dry, soft cloth to wipe from the center outward. Do not attach any seals or labels to your discs. Do not write on the disc label in a heavy pen or ballpoint pen.



Notes on CD-Rs/RWs, DVD-Rs/RWs

- You may have trouble playing back some CD-R/RW, DVD-Rs/RWs discs recorded on CD/DVD recorders (CD-R/RW, DVD-Rs/RWs drives), either due to their recording characteristics or dirt, fingerprints, scratches, etc. on the disc surface.
- CD-R/RW, DVD-Rs/RWs discs are less resistant to high temperatures and high humidity than ordinary music CDs. Leaving them inside a car for extended periods may damage and make playback impossible.
- The unit may not successfully playback a CD-R/RW, DVD-Rs/RWs that was made by the combination of writing software, a CD/DVD recorder (CD-R/RW, DVD-Rs/RWs drive) and a disc if they are incompatible with one another.
- This player does not play CD-R/RW, DVD-Rs/RWs discs if the session is not closed.
- Be sure to observe the handling instructions of CD-R/RW, DVD-Rs/RWs discs.
- This player does not play CD-R/RW discs which contain other than CD-DA or MP3/WMA data.

Language Code List



DVD language menu (→ page 36)

In “OTHER” cases... (→ page 36)

Input the four digit language code pressing the buttons 0 to 9.
Touch **ENTER** to determine.

Note:

- Setting is finished and the display returns to the main menu.
- For retrying selection during number entry, touch/press **RET** / **[RETURN]**.

Code	Language Name
6565	Afar
6566	Abkhazian
6570	Afrikaans
6577	Ameharic
6582	Arabic
6583	Assamese
6589	Aymara
6590	Azerbaijani
6665	Bashkir
6669	Byelorussian
6671	Bulgarian
6672	Bihari
6678	Bengali; Bangla
6679	Tibetan
6682	Breton
6765	Catalan
6779	Corsican
6783	Czech
6789	Welsh
6865	Danish
6869	German
6890	Bhutani
6976	Greek
6978	English
6979	Esperanto
6983	Spanish
6984	Estonian
6985	Basque
7065	Persian
7073	Finnish
7074	Fiji
7079	Faroese
7082	French
7089	Frisian
7165	Irish
7168	Scots Gaelic
7176	Galician
7178	Guarani
7185	Gujarati
7265	Hausa
7273	Hindi
7282	Croatian
7285	Hungarian

Code	Language Name
7289	Armenian
7365	Interlingua
7378	Indonesian
7383	Icelandic
7384	Italian
7387	Hebrew
7465	Japanese
7473	Yiddish
7487	Javanese
7565	Georgian
7575	Kazakh
7576	Greenlandic
7577	Cambodian
7578	Kannada
7579	Korean
7583	Kashmiri
7585	Kurdish
7589	Kirghiz
7665	Latin
7678	Lingala
7679	Laothian
7684	Lithuanian
7686	Latvian, Lettish
7771	Malagasy
7773	Maori
7775	Macedonian
7776	Malayalam
7778	Mongolian
7779	Moldavian
7782	Marathi
7783	Malay
7784	Maltese
7789	Burmese
7865	Nauru
7869	Nepali
7876	Dutch
7879	Norwegian
7982	Oriya
8065	Panjabi
8076	Polish
8083	Pashto, Pushto
8084	Portuguese
8185	Quechua

Code	Language Name
8277	Rhaeto-Romance
8279	Romanian
8285	Russian
8365	Sanskrit
8368	Sindhi
8372	Serbo-Croatian
8373	Singhalese
8375	Slovak
8376	Slovenian
8377	Samoan
8378	Shona
8379	Somali
8381	Albanian
8382	Serbian
8385	Sundanese
8386	Swedish
8387	Swahili
8465	Tamil
8469	Telugu
8471	Tajik
8472	Thai
8473	Tigrinya
8475	Turkmen
8476	Tagalog
8479	Tonga
8482	Turkish
8484	Tatar
8487	Twi
8575	Ukrainian
8582	Urdu
8590	Uzbek
8673	Vietnamese
8679	Volapük
8779	Wolof
8872	Xhosa
8979	Yoruba
9072	Chinese
9085	Zulu

Definition of Terms



Dolby Digital

This fully discrete format divides the music signals into 5.1 channels: Front Left (L), Front Right (R), Center (C), Left Surround (LS), Right Surround (RS) and Subwoofer (SW: 0.1 channel) for recording and playback. The number of channels that are recorded depends on the software. (1 to 5.1 channels)

Manufactured under license from Dolby Laboratories. "Dolby", "Pro Logic", and the double-D symbol are trademarks of Dolby Laboratories.

Dolby Pro Logic

This format records signals from four channels [Front Left (L), Front Right (R), Center (C), and Monaural Surround (S)] in two channels, decodes those channels through a Dolby Pro Logic decoder, and then outputs the resulting signals in four channels.

dts

This format requires more data than Dolby Digital, and provides higher quality surround playback. Similar to Dolby Digital, this fully discrete format divides the music signals into 5.1 channels: Front Left (L), Front Right (R), Center (C), Left Surround (LS), Right Surround (RS) and Subwoofer (SW: 0.1 channel) for recording and playback.

Interactive DVD

An interactive DVD is DVD software which includes multiple angles, multiple plot endings, etc.

Letterbox screen

This refers to a screen on which the playback picture of wide-screen DVDs or VCD (Video CD)s appears with black bands running along the top and bottom.

LPCM (Linear PCM audio)

In this format, the audio signal is converted to digital data and recorded in two channels without compression. Because the capacity of a DVD disc is large, it can store more data with better accuracy than a CD.

Pan & Scan screen

This refers to a screen on which the playback picture of wide-screen DVDs or VCD (Video CD)s is cut off at the left and right sides.

Playback control (VCD (Video CD))

If the VCD (Video CD) has "With Playback Control" or others written on the disc surface or on the jacket, the scenes or information to be viewed (or listened to) can be selected interactively with the screen by looking at the menu shown on the screen. In these instructions, playback using the menu screen is referred to as the "menu play" for video CDs. This player supports Video CDs with playback control.

Title, Chapter (DVD)

DVDs are divided into some large sections (titles) or some small sections (chapters). Each section is numbered; these numbers are called "Title number" or "Chapter number".

Title 1			Title 2	
Chapter 1	Chapter 2	Chapter 1

Track (Video CD/CD)

Video CDs or CDs are divided into some sections (tracks). Each section is numbered; these numbers are called "Track number".

Track 1	Track 2	Track 3	Track
---------	---------	---------	-------------

"DTS" and "DTS Digital Surround" are registered trademarks of Digital Theater Systems, Inc.

"This product incorporates copyright protection technology that is protected by U.S. patents and other intellectual property rights. Use of this copyright protection technology must be authorized by Macrovision, and is intended for home and other limited viewing uses only unless otherwise authorized by Macrovision. Reverse engineering or disassembly is prohibited."

Specifications

General

- Power supply : 12 V DC (11 V – 16 V), test voltage 14.4 V, negative ground
- Current consumption : Less than 10 A (during disc playback)
- Power Output : 18 W x 4 ch (1 kHz, 1 %, 4 Ω)
- Maximum power output : 50 W x 4 ch
- Compatible speaker impedance : 4 Ω
- Video input signal : Composite video signal, 1.0 Vp-p (75 Ω)
- Audio input sensitivity : 2 Vrms
- Video output signal : Composite video signal, 1.0 Vp-p (75 Ω)
- Pre-Amp output voltage : 2 Vrms
- Pre-Amp output impedance: Less than 600 Ω
- Dimensions (W x H x D) : 178 x 100 x 165 mm
- Weight : 2.4 kg

FM stereo radio

- Frequency range : 87.5 MHz – 108 MHz
- Usable sensitivity : 7 dB/ μ V
- Stereo separation : 40 dB (1 kHz)
- S/N ratio : 63 dB

AM radio

- Frequency range : 531 kHz – 1 602 kHz
- Usable sensitivity : 25 dB/ μ V
- Image rejection ratio : 50 dB

Note:

- Specifications and the design are subject to modification without notice due to improvements in technology.
- Some figures and illustrations on this manual may be different from your product.

Playable region number

This operating instruction manual is for 4 models CQ-VD6505W2/CQ-VD6505W3/CQ-VD6505W4 and CQ-VD6505W5. The following table shows the playable region number for each model.

Model	Playable region number
CQ-VD6505W2	2 (ALL)
CQ-VD6505W3	3 (ALL)
CQ-VD6505W4	4 (ALL)
CQ-VD6505W5	5 (ALL)

Audio section

- Output voltage/Impedance: 2 Vrms/600 Ω
- Frequency characteristics (when "LARGE" is selected)
Front L/R, Center, Rear (surround) L/R : 20 Hz – 20 kHz (\pm 1 dB)
- Delay time
 - Dolby Digital
Center : 0 – 5 ms
Rear (surround) L/R : 0 – 15 ms
 - Dolby Pro Logic
Rear (surround) L/R : 15 – 30 ms
- Distortion
Front L/R (1 kHz, 0 dB, PCM input) : 0.01 %
- Dynamic range : 96 dB (during CD playback)
- S/N ratio : 100 dB (during CD playback)

Monitor

- Storage temperature range : -20 $^{\circ}$ C – +80 $^{\circ}$ C
- Liquid crystal panel : 6.5-inch wide
- Screen dimensions (W x H x D) : 143 x 79 x 164 mm
- Number of pixels : 280 880 pixels (234 vertical x 400 horizontal x 3)
- Valid pixel ratio : Over 99.99%
- Display method : Transparent color filter format
- Drive method : TFT (Thin Film Transistor) active matrix format

■ 보증서

모델명	CQ-VD6505W		
고객란	고객 성명:	_____ 님	
	고객 주소 : 우편번호	_____	
		시	구(읍, 면) 동(리)
	전화 번호 : (_____)	_____ - _____	
구입 년월일	판매점 명, 주소, 전화 번호 :		
년 월 일			
보증 기간 (구입일부터)	전화 번호 : (_____) _____ - _____		
1 년간	제품의 시리얼 번호 :		

※ 구입일과 구입처(판매점)를 분명히 기재하여, 고객에게 전달하시기 바랍니다. 차후의 A/S수리와 관련하여 매우 중요하오니 반드시 보관하시기 바랍니다.

※ 당사에서는 제품의 시리얼 번호를 전산 처리하여 관리하고 있습니다. 보증서에 시리얼 번호를 기록 하여 두시기 바랍니다.

제조년월

Panasonic Car Audio 세풍전자공업주식회사
 한국총대리점 본사 : 서울특별시 영등포구 양평동5가 56-2
 전화 : (02)2633-0856(대표전화)
 고객상담실 : (02)2633-0878
 홈페이지 : www.sepung.co.kr

Matsushita Electric Industrial Co., Ltd.

Web Site : <http://panasonic.net>

YFM284C681CA PTW0107-1027 Printed in China

Panasonic

Installation Instructions

설치 설명서

Инструкция по монтажу

Model: **CQ-VD6505W**



WMA MP3

- Please read these instructions carefully before using this product and keep this manual for future reference.
- 본 제품의 바른 사용을 위해, 이 사용설명서를 잘 읽어 주십시오.
잘 보관하시어 필요하실 때마다 읽어주시기 바랍니다.
- Перед началом эксплуатации просим прочитать настоящую инструкцию внимательно и хранить ее на пользование на будущее.

Safety Information

**CAUTION:**

- PLEASE FOLLOW THE LAWS AND REGULATIONS OF YOUR STATE, PROVINCE OR COUNTRY FOR INSTALLATION OF THE UNIT.
- TO REDUCE THE RISK OF FIRE OR ELECTRIC SHOCK OR PRODUCT DAMAGE, DO NOT EXPOSE THIS APPLIANCE TO RAIN, SPLASHING, DRIPPING OR MOISTURE.

Upgrade Options

TV Tuner
(CY-TUP133W,
CY-TUN133W option)

Rear Monitor

Main Unit
CQ-VD6505W

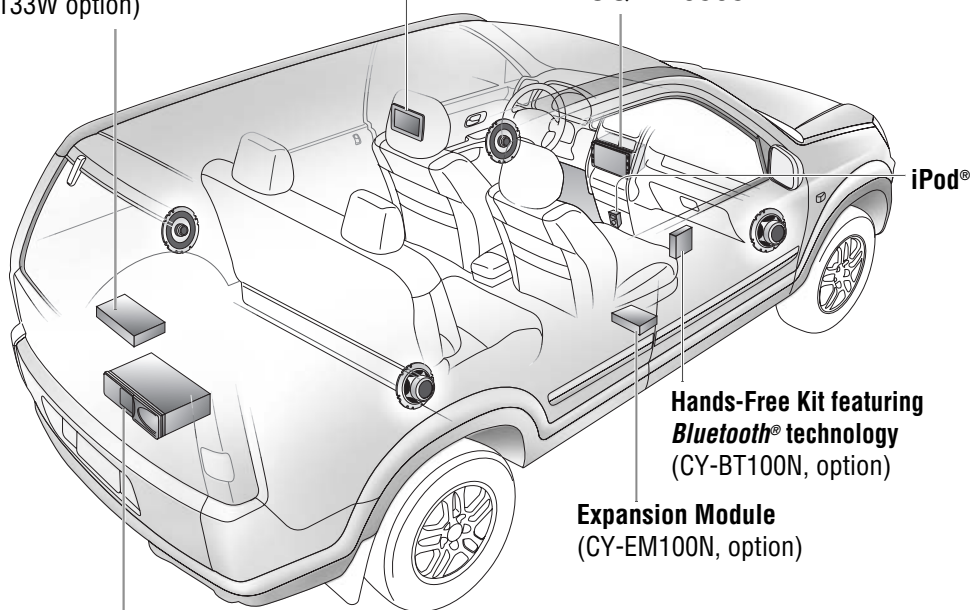

iPod®

Hands-Free Kit featuring
Bluetooth® technology
(CY-BT100N, option)

Expansion Module
(CY-EM100N, option)

CD Changer
(CX-DP880, option)

DVD Changer
(CX-DH801W, option)

Contents

Safety Information.....	2
Upgrade Options.....	3
Installation.....	4
Electrical Connections.....	8

Installation

Preparation

3

⚠ Caution

- Please follow the laws and regulations of your province or country for installation of the unit.
- When bending the mounting tab of the mounting collar with a screwdriver, be careful not to injure your hands and fingers.
- We strongly recommend you to wear gloves for installation work to protect yourself from injuries.

- Before installation, check the radio operation with antenna and speakers.
- Disconnect the cable from the negative (-) battery terminal (see caution below).
- The unit should be installed in a horizontal position with the front end up at a convenient angle, but not more than 30°.

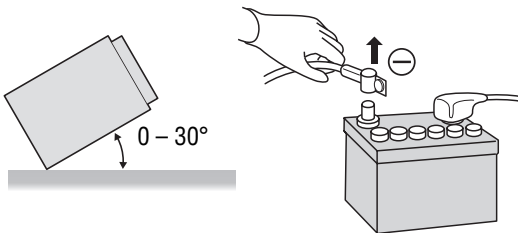

⚠ Caution

- Do not disconnect the battery terminals of a car with trip or navigational computer since all user settings stored in memory will be lost. Instead take extra care with installing the unit to prevent shorts.

Dashboard Installation

Installation Opening

The unit can be installed in any dashboard having an opening as shown below. The dashboard should be 4.5 mm – 6 mm thick in order to be able to support the unit.

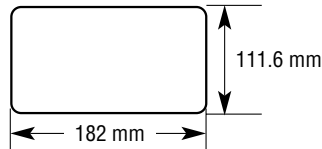

Installation Precautions

This product should be installed by a professional installer, if possible.



In case of difficulty, please consult your nearest authorized Panasonic Service Centre.

1. This system is to be used only in a 12 V DC battery system (car) with negative ground.
2. Follow the electrical connections carefully (→ page 8-16). Failure to do so may result in damage to the unit.
3. Connect the power lead after all other connections are made.
4. Be sure to connect the battery lead (yellow) to the positive terminal (+) of the battery or fuse block (BAT) terminal.
5. Insulate all exposed wires to prevent short circuiting.
6. Secure all loose wires after installing the unit.
7. Please carefully read the operating and installation instructions of the respective equipment before connecting it to this unit.

❑ Installation Hardware (For Installation)

No.	Item	Diagram	Qty.
①	Trim Plate		1
<YFC054C088ZA>			
②	Mounting Collar		1
<YFX214C437ZA>			
③	Lock Cancel Plate		2
<YFX994C134ZA>			
④	Mounting Bolt (5 mmø)		1
⑤	Tapping Screw (5 mmø x 16 mm)		1
⑥	Hex. Nut (5 mmø)		1
<ZZBISVD7001A>			
⑦	Rear Support Strap		1
<YEFG044C002>			
⑧	Round Head Screw (5 mmø x 8 mm)		2
⑨	Flat-Head Screw (5 mmø x 8 mm)		6
<ZZBISVD6503>			

❑ Installation Hardware (For Wiring)

No.	Item	Diagram	Qty.
⑩	Power Connector (ISO connector)		1
⑪	Reverse Extension Cord		1
⑫	Clip Connector		1
<YEAJ012890>			

Note:

- The number in parenthesis underneath each accessory part name is the part number for maintenance and service.
- Accessories and their parts numbers are subject to modification without prior notice due to improvements.
- Mounting Collar ② is mounted on the main unit at shipment.
- Use the supplied screws for installation exclusively. In case of losing any of them, please order the specific screw.

❑ Transportation Bracket Removal

Be sure to remove the transportation brackets before use (installation). **Use round head screws (5 mmø x 8 mm) for installation.** (→ page 7)

Be careful not to lose these screws.

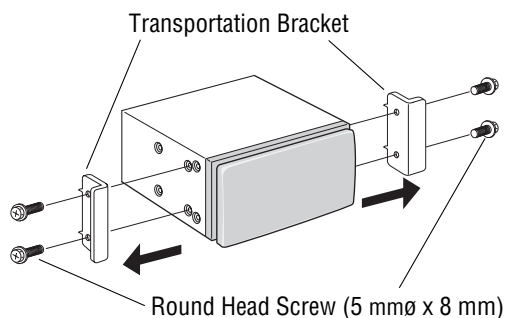

❑ Before Installation

⚠ Caution

- Do not press the panel forcefully.
- Do not scratch the panel with fingernails or any hard objects.
- Do not bump the front panel.
 - ➔ Failure to observe the above may damage or break the glass on the surface of the touch panel.

Installation (continued)

Mounting and removing the Main Unit

□ Mounting Procedures (A) (When using Mounting Collar ②)

5

Note:

- The car model, installation conditions and combination of the units used may impose some restrictions on opening and closing the monitor as well as on the angle and position to which the monitor can be adjusted.

IMPORTANT

When this unit is installed in dashboard, ensure that there is sufficient air flow around the unit to prevent damage from overheating. Do not block any ventilation holes on the unit.

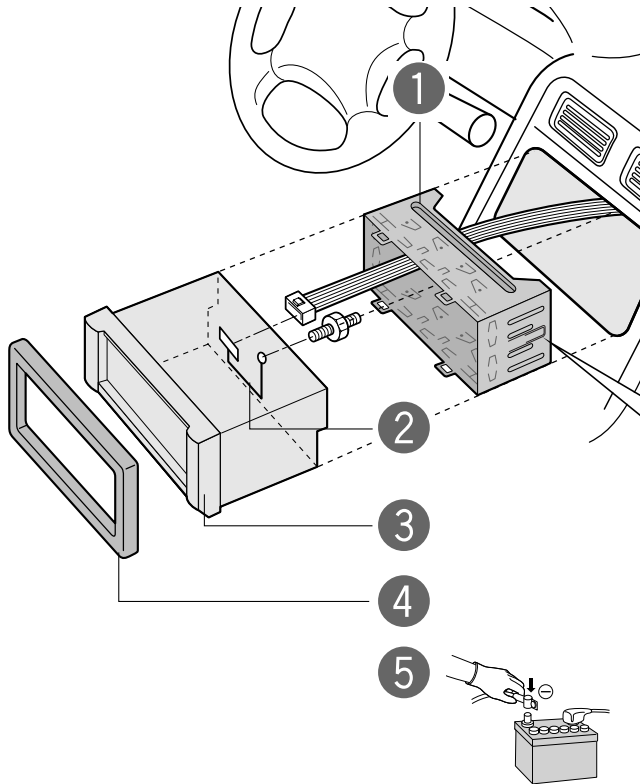

① Insert the Mounting Collar ② into the dashboard, and bend the mounting tabs out with a screwdriver.

② Establish the rear connection of the unit. After fixing Power Connector ⑩, fix the rear of the unit to the car body by either method (a) or (b).

③ Insert the unit into Mounting Collar ②. Secure the clamp plate of Mounting Collar ② to the hook.

④ Insert Trim Plate ①.

⑤ After installation reconnect the negative (-) battery terminal.

Snapping point

Method for Fixing the Rear of the Unit

(a) Using the Rear Support Strap ⑦.

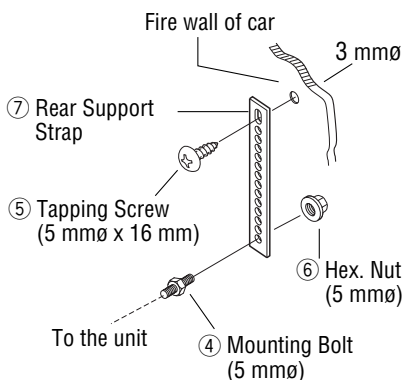

(b) Using the Rubber Cushion (option)

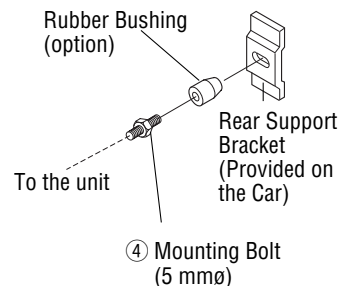

□ Mounting Procedures (B)

(When not using Mounting Collar ②)

Use the brackets supplied with your car when mounting this unit. The bracket shape and mounting method vary with car manufacturers, car types and manufacturing year. Please consult your nearest dealer or installer.

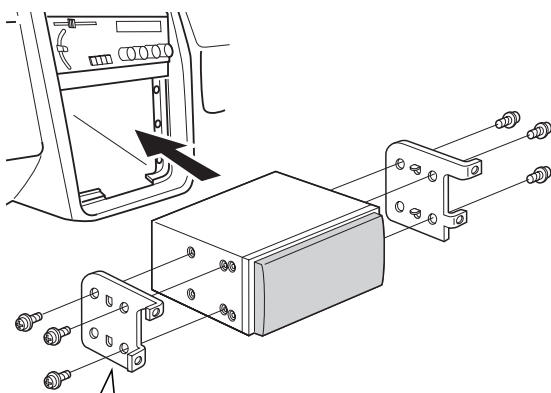

Note:

- Use pliers to bend the fingers on the bracket vertically.

Select mounting screws according to the hole positions and hole shape of the bracket.



- ⑧ Round Head Screw
(5 mm \varnothing x 8 mm)

Note:

- Recycle the Round Head Screws that fixed the transportation brackets for two more positions.
(→ page 5)



- ⑨ Flat-Head Screw
(5 mm \varnothing x 8 mm)

□ Removing Procedures

- ① Remove the trim plate ①.

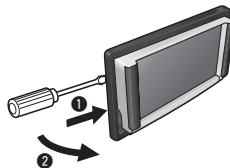

- ② Lock release.

- ① Insert the lock cancel plate ③ until you hear a click.

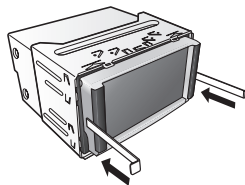

- ② Pull the unit out.

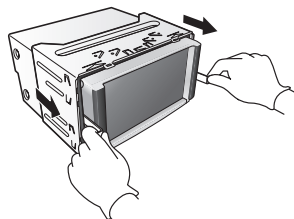

- ③ Pull the unit out with both hands.

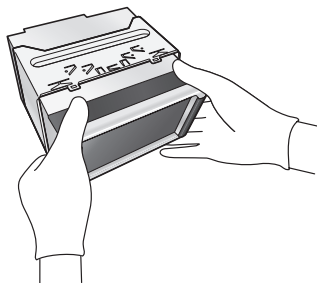

Electrical Connections

⚠ Caution

- This unit is designed for use in a car having a 12 V negative ground battery system.
- Be sure to insulate any exposed wires from the car chassis. Bundle all cables and keep cable terminals free from any metal parts.
- Note that if your car has a driving computer or a navigation computer, disconnecting the cable from the battery may clear the memory.
- Run the cords avoiding the spots where the temperature can be extremely high.

CQ-VD6505W (Rear)

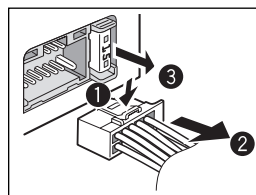
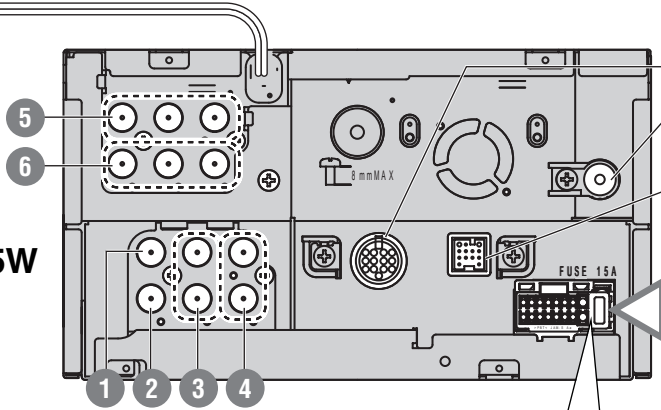

Fuse (15 A) Refer fuse replacement to your nearest authorized Panasonic Service Centre. Do not try fuse replacement by yourself.

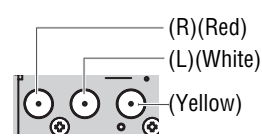
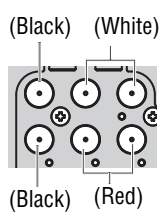

- 1 Pre-Out Connector (center)**
To an external amplifier.
- 2 Pre-Out Subwoofer connector (mono)**
To an external amplifier.
- 3 Pre-Out Connector (rear)**
To an external amplifier.
- 4 Pre-Out Connector (front)**
To an external amplifier.

- 5 Video Input Terminal (AV1-IN)**
- 6 Video Input Terminal (AV2-IN)**
Connect a VCR, camcorder, other brand's car navigation system, etc. (⇒ page 15)
Note:
• When an external device is connected to the system-up connector, the audio terminals, {(R)(Red), (L)(White)}, of AV2-IN are disabled.

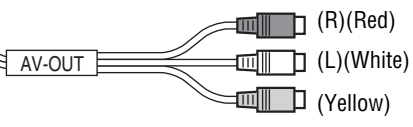

Video Output Terminal (AV-OUT)
Connect the rear monitor. (⇒ page 15)

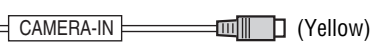

Camera Input Terminal (CAMERA-IN)
Connect a rear view camera. (⇒ page 16)

Note:

- To prevent from damage to the unit, be sure to follow the wiring diagrams below.
- Be sure to fully plug in the connectors. Secure them with clamps and tapes.
- All other installation methods require the use of dedicated metal fittings. Consult with a qualified servicing engineer or your dealer if other methods are required.

 : This book refers to connections to the Panasonic car navigation system that will come onto the market in the future. Descriptions regarding the car navigation system are boxed with a dotted line.

RGB Connector

To the Panasonic Car Navigation System (available in future).

Radio Antenna Connector (RADIO ANT IN)**System-up Connector**

To external devices equipped with system-up connector.

⑩ Power Connector**Navi Mute Lead (Orange)**

Connect to the Navi Mute Lead of the Panasonic car navigation system. (available in future)

Motor Antenna Relay Control Lead (Blue)

(To motor antenna) (Max. 100 mA)

This lead is not intended for use with a switch actuated power antenna.

Side Brake (Parking Brake) Connection Lead (Bright green)

Be sure to wire the side brake (parking brake) for safety and preventing accidents. (➔ page 10)

SIDE BRAKE

External Amplifier Control Power Lead (Blue/white stripe)

To an external amplifier.

Note:

- Use the power control lead of the TV tuner for TV tuner connection.
- Connect both the power control lead of the TV tuner and the amplifier control connector of the external amplifier when the TV tuner and external amplifier are connected at the same time.

Reverse Lead (Violet/white stripe)

When connecting the rear view camera, use the reverse lead. (➔ page 16)

REVERSE

Note: Use a Reverse Extension Cord ⑩ if needed.

Power Lead (Red)

To ACC power, +12 V DC.

ACC

Battery Lead (Yellow)

To the car battery, continuous +12 V DC.

BATTERY 15A

Ground Lead (Black)

To a clean, bare metallic part of the car chassis

Front Right + (Gray)
Front Right - (Gray/black stripe)

Front Left + (White)
Front Left - (White/black stripe)

Rear Right + (Violet)
Rear Right - (Violet/black stripe)

Rear Left + (Green)
Rear Left - (Green/black stripe)

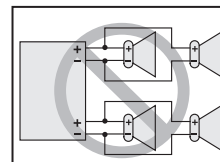
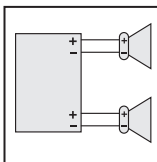
Speaker connections

- Do not connect more than one speaker to one set of speaker leads (except for connecting to a tweeter). **Use of speakers which do not match the specifications can cause burning, smoking or damage of the speakers.**
- Do not use a 3-wire type speaker system having a common earth lead.

Electrical Connections (continued)

Connecting the Side Brake (Parking Brake) Connection Lead

9

⚠ Caution

• For safety, be sure to ask your nearest professional installer to do this connection.

Hand brake

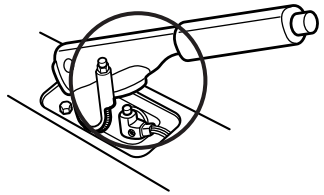

Foot brake

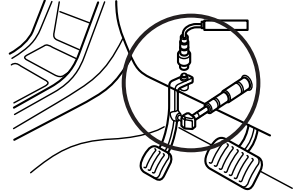

Side brake (parking brake) switch

The side brake (parking brake) switch position varies with car model. For details on the exact location of the side brake (parking brake) switch in your car, contact your dealer.

Side Brake (Parking Brake) Connection Lead (Bright green)

When the side brake (parking brake) lever is engaged, the unit is grounded by the chassis.

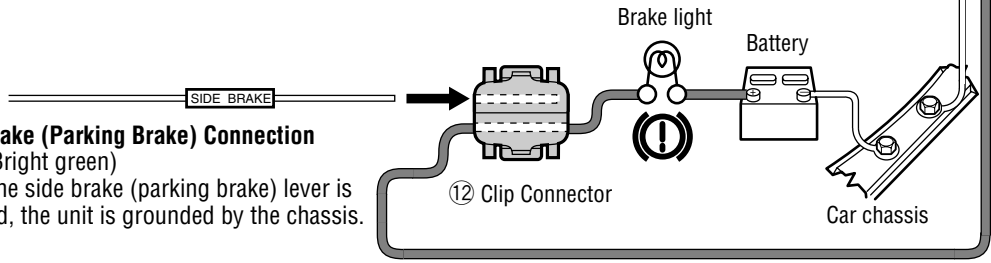

1 Attach a Clip Connector 12 to the end of the side brake (parking brake) connection lead.

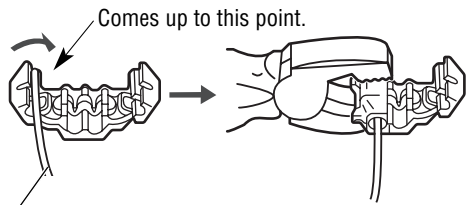

Side Brake (Parking Brake) Connection Lead (Bright green)

2 The Clip Connector 12 is connected to the power source side lead of the side brake (parking brake) lever.

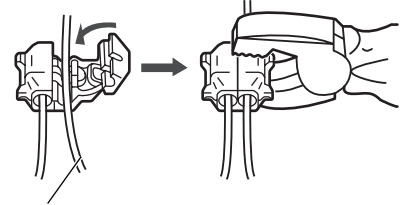

Power source side lead

Connection with TV Tuner

Note:

- Refer to the operating instructions for the connected devices, in addition.

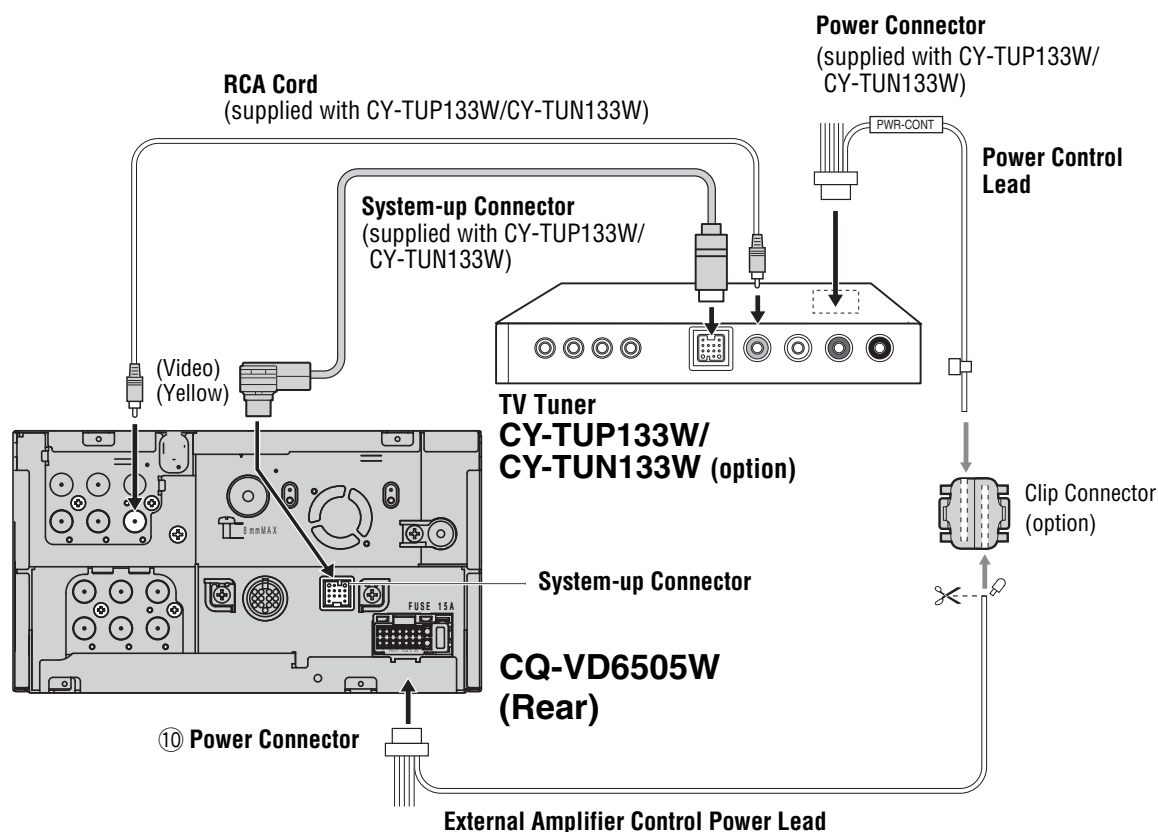

Note:

- Connect both the power control lead of the TV tuner and the amplifier control connector of the external amplifier when the TV tuner and external amplifier are connected at the same time.

Electrical Connections (continued)

Connection with DVD Changer (CX-DH801W)

Note:

- Refer to the operating instructions for the connected devices, in addition.

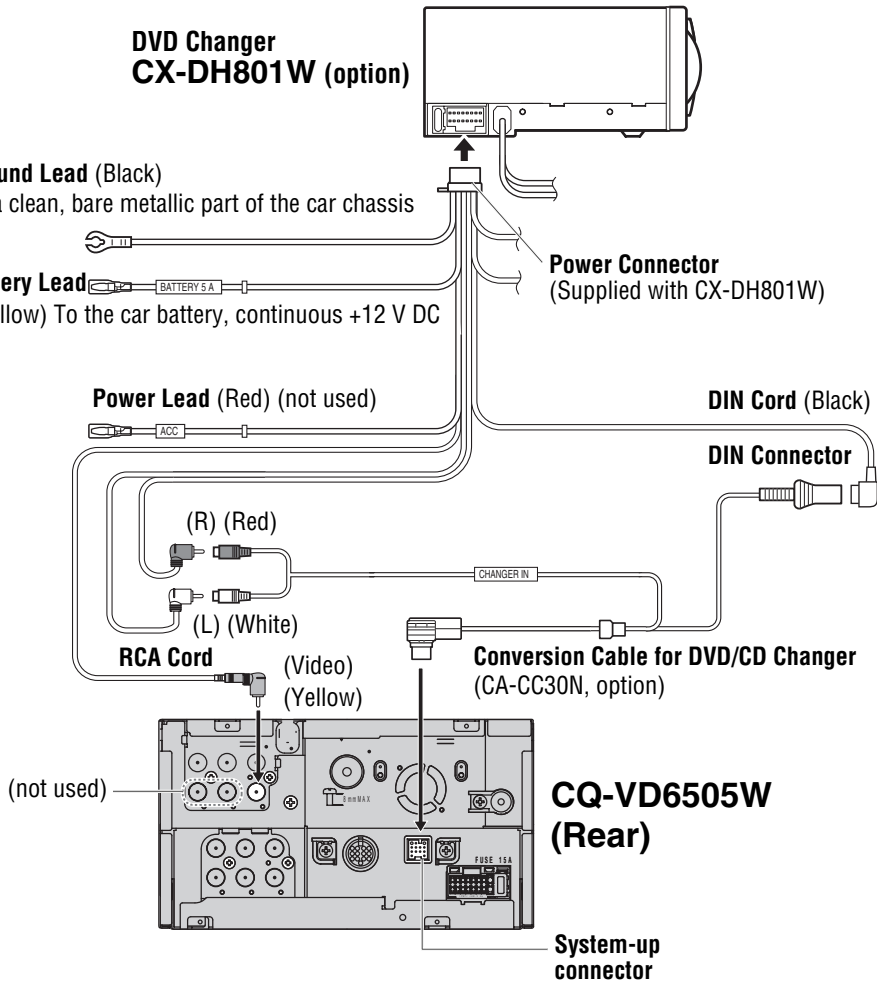

Connection with CD Changer (CX-DP880)

Note:

- Refer to the operating instructions for the connected devices, in addition.

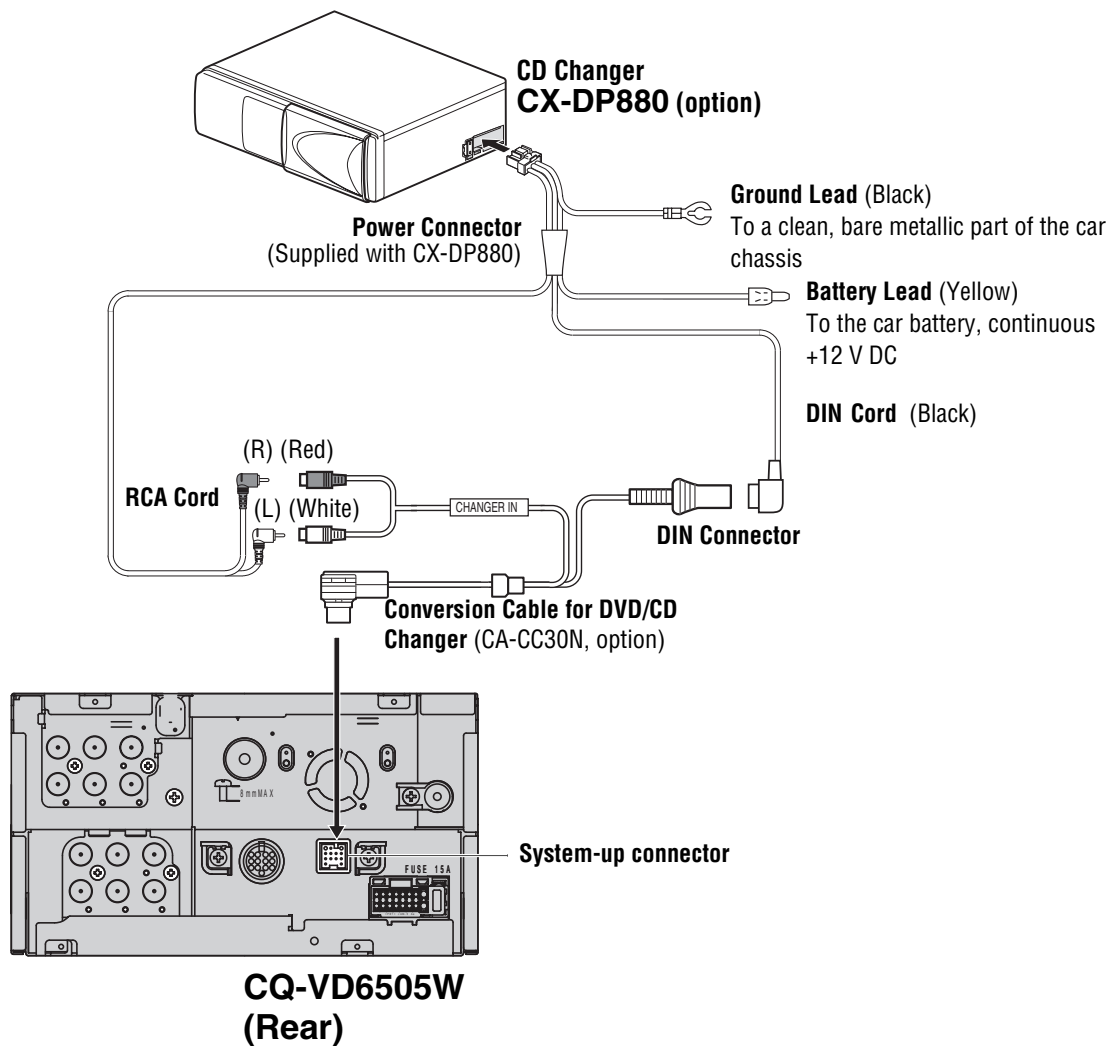

Electrical Connections (continued)

Connection with Expansion Module (CY-EM100N)

Note:

- Refer to the operating instructions for the connected devices, in addition.

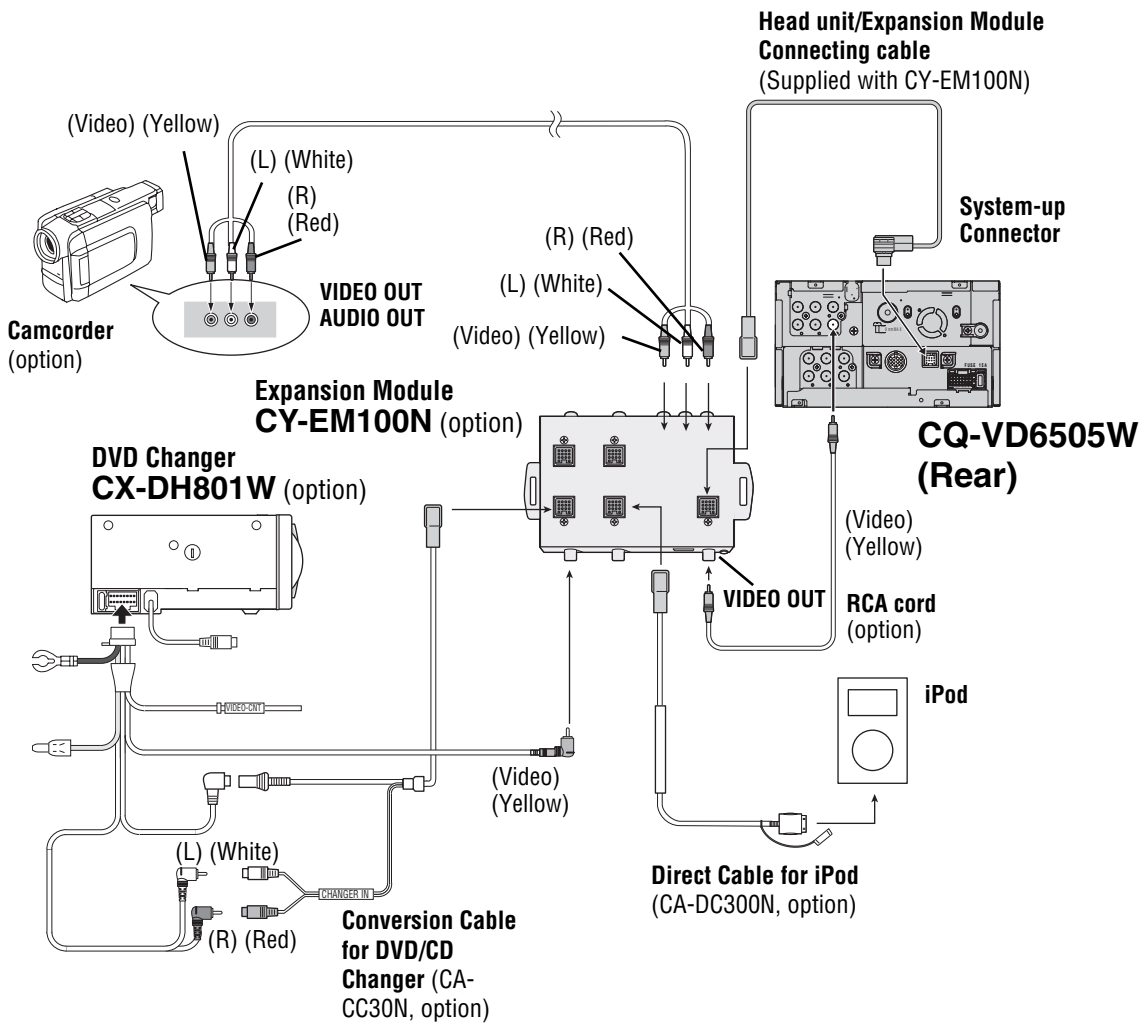

Connection with Rear Monitor

Note:

- Refer to the operating instructions for the connected devices, in addition.
- Please observe what shapes the connectors of the connecting devices are and where each of them is connected to in order to establish a proper connection.

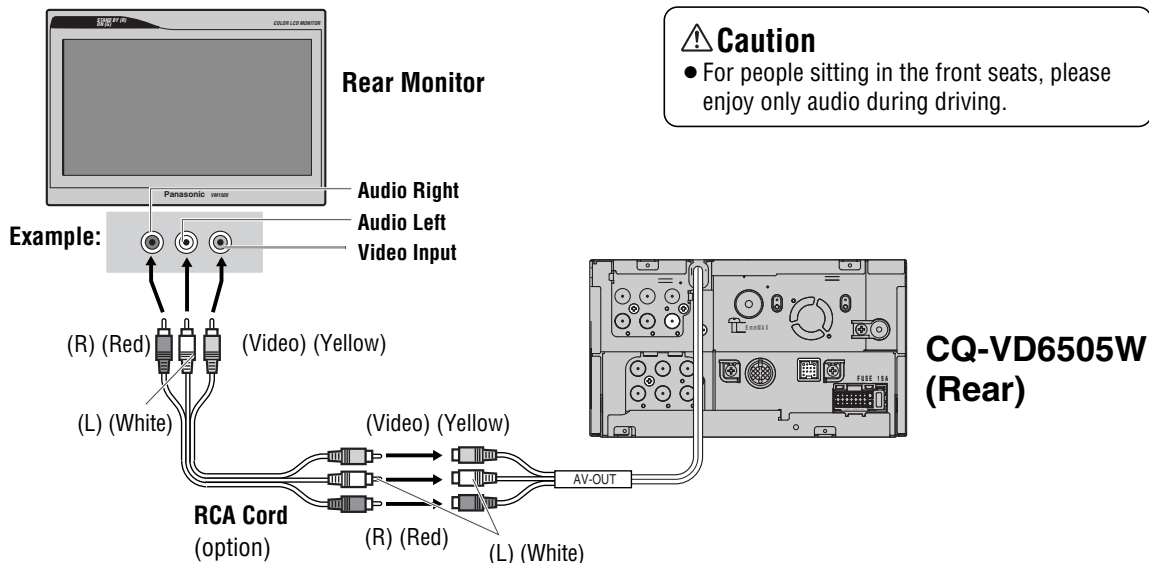

Connection with VCR or Camcorder

Note:

- Refer to the operating instructions for the connected devices, in addition.
- Please observe what shapes the connectors of the connecting devices are and where each of them is connected to in order to establish a proper connection.

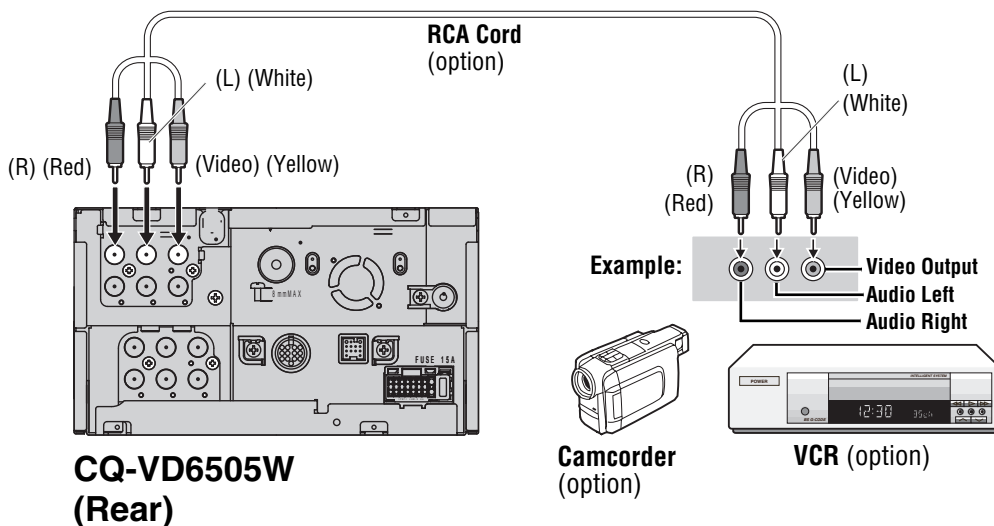

Electrical Connections (continued)

Connection with Rear View Camera

15

Note:

- Refer to the operating instructions for the connected devices, in addition.

CQ-VD6505W (Rear)

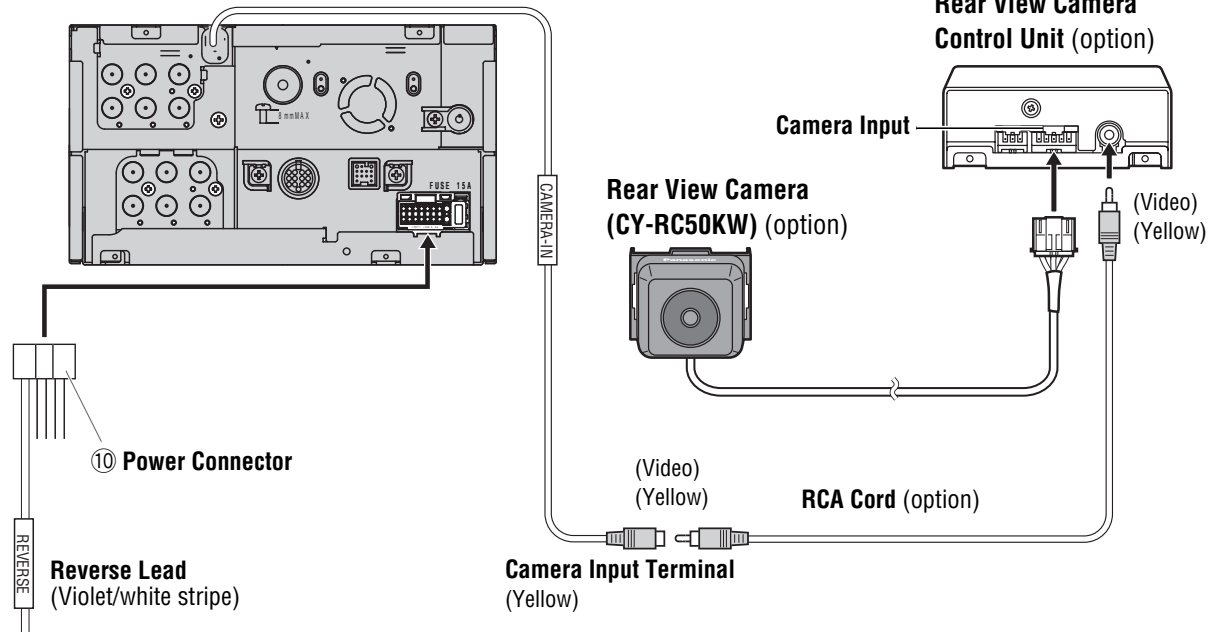

Connecting the Reverse Lead

If using an optional rear view camera, the reverse lead must be connected.

Connect the reverse lead (violet/white stripe) to the positive (+) lead of the reverse lamp (the lamp with a clear lens that lights when the transmission gear is shifted into the reverse position).

Note:

- Connect the reverse lead after cutting the terminal at the end.
- Use a Reverse Extension Cord (11) if needed.

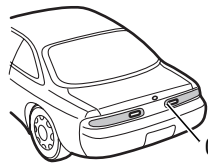

Check the reverse lamp.



Take it out of the back of the tail lamp mount.

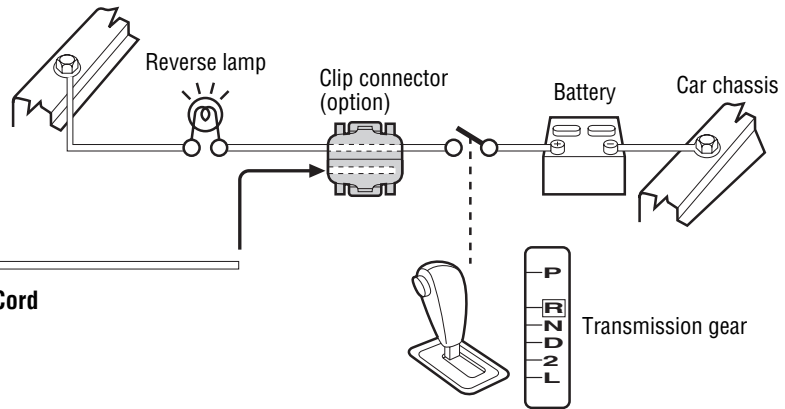

11 Reverse Extension Cord (Violet/white stripe)



Matsushita Electric Industrial Co., Ltd.
Web Site : <http://panasonic.net>

Panasonic

System Upgrade Guidebook 시스템 업그레이드 가이드북 Инструкция по расширению системы

Model: **CQ-VD6505W**



- Please read these instructions carefully before using this product and keep this manual for future reference.
- 본 제품의 바른 사용을 위해, 이 사용설명서를 잘 읽어 주십시오.
잘 보관하시어 필요하실 때마다 읽어주시기 바랍니다.
- Перед началом эксплуатации просим прочитать настоящую инструкцию внимательно и хранить ее на пользование на будущее.

Safety Information

■ Read the operating instructions for the unit and all other components of your car audio system carefully before using the system. They contain instructions about how to use the system in a safe and effective manner. Panasonic assumes no responsibility for any problems resulting from failure to observe the instructions given in this manual.

■ This manual uses pictographs to show you how to use the product safely and to alert you to potential dangers resulting from improper connections and operations. The meanings of the pictographs are explained below. It is important that you fully understand the meanings of the pictographs in order to use this manual and the system properly.



Warning

This pictograph intends to alert you to the presence of important operating instructions and installation instructions. Failure to heed the instructions may result in severe injury or death.



Caution

This pictograph intends to alert you to the presence of important operating instructions and installation instructions. Failure to heed the instructions may result in injury or material damage.

Warning

Observe the following warnings when using this unit.

- ❑ **The driver should neither watch the display nor operate the system while driving.**

Watching the display or operating the system will distract the driver from looking ahead of the vehicle and can cause accidents. Always stop the vehicle in a safe location and use the parking brake before watching the display or operating the system.

- ❑ **Use the proper power supply.**

This product is designed for operation with a negative grounded 12 V DC battery system. Never operate this product with other battery systems, especially a 24 V DC battery system.

- ❑ **Keep batteries and insulation film out of reach of infants.**

Batteries and insulation film can be ingested, so keep them out of the reach of infants. If an infant ingests a battery or insulation film, please seek immediate medical attention.

- ❑ **Protect the Deck Mechanism.**

Do not insert any foreign objects into the slot of this unit.

- ❑ **Do not disassemble or modify the unit.**

Do not disassemble, modify the unit or attempt to repair the product yourself. If the product needs to be repaired, consult your dealer or an authorized Panasonic Service Center.

- ❑ **Do not use the unit when it is out of order.**

If the unit is out of order (no power, no sound) or in an abnormal state (has foreign objects in it, is exposed to water, is smoking, or smells), turn it off immediately and consult your dealer.

- ❑ **The remote control unit should not lie about in the car.**

If the remote control unit lies about, it could fall on the floor while driving, get wedged under the brake pedal, and lead to a traffic accident.

- ❑ **Refer fuse replacement to qualified service personnel.**

When the fuse blows out, eliminate the cause and have it replaced with the fuse prescribed for this unit by a qualified service engineer. Incorrect replacement of the fuse may lead to smoke, fire, and damage to the product.

Observe the following warnings when installing.

- ❑ **Disconnect the lead from the negative (–) battery terminal before installation.**

Wiring and installation with the negative (–) battery terminal connected may cause electrical shock and injury due to a short circuit.

Some cars equipped with the electrical safety system have specific procedures of battery terminal disconnection.

FAILURE TO FOLLOW THE PROCEDURE MAY LEAD TO THE UNINTENDED ACTIVATION OF THE ELECTRICAL SAFETY SYSTEM RESULTING IN DAMAGE TO THE VEHICLE AND PERSONAL INJURY OR DEATH.

- ❑ **Never use safety-related components for installation, grounding, and other such functions.**

Do not use safety-related vehicle components (fuel tank, brake, suspension, steering wheel, pedals, airbag, etc.) for wiring or fixing the product or its accessories.

- ❑ **Installing the product on the air bag cover or in a location where it interferes with airbag operation is prohibited.**

- ❑ **Check for piping, gasoline tank, electric wiring, and other items before installing the product.**

If you need to open a hole in the vehicle chassis to attach or wire the product, first check where the wire harness, gasoline tank, and electric wiring are located. Then open the hole from outside if possible.

- ❑ **Never install the product in a location where it interferes with your field of vision.**

- ❑ **Never have the power cord branched to supply other equipment with power.**

- ❑ **After installation and wiring, you should check the normal operation of other electrical equipment.**

The continuation of their using in abnormal conditions may cause fire, electrical shock or a traffic accident.

- ❑ **In the case of installation to an airbag equipped car, confirm warnings and cautions of the vehicle manufacturer before installation.**

- ❑ **Make sure the leads do not interfere with driving or getting in and out of the vehicle.**

- ❑ **Insulate all exposed wires to prevent short circuiting.**

Caution

Observe the following cautions when using this unit.

- ❑ **Keep the sound volume at an appropriate level.**
Keep the volume level low enough to be aware of road and traffic conditions while driving.
- ❑ **Do not insert or allow your hand or fingers to be caught in the unit.**
To prevent injury, do not get your hand or fingers caught in moving parts or in the disc slot. Especially watch out for infants.
- ❑ **This unit is designed for use exclusively in automobiles.**
- ❑ **Do not operate the unit for a prolonged period with the engine turned off.**
Operating the audio system for a long period of time with the engine turned off will drain the battery.
- ❑ **Do not expose the unit to direct sunlight or excessive heat.**
Otherwise these will raise the interior temperature of the unit, and it may lead to smoke, fire, or other damage to the unit.
- ❑ **Do not use the product where it will be exposed to water, moisture, or dust.**
Exposure of the unit to water, moisture, or dust may lead to smoke, fire, or other damage to the unit. Make especially sure that the unit does not get wet in car washes or on rainy days.

Observe the following cautions when installing.

- ❑ **Refer wiring and installation to qualified service personnel.**
Installation of this unit requires special skills and experience. For maximum safety, have it installed by your dealer. Panasonic is not liable for any problems resulting from your own installation of the unit.
- ❑ **Follow the instructions to install and wire the product.**
Not following the instructions to properly install and wire the product could cause an accident or fire.
- ❑ **Take care not to damage the leads.**
When wiring, take care not to damage the leads. Prevent them from getting caught in the vehicle chassis, screws, and moving parts such as seat rails. Do not scratch, pull, bend or twist the leads. Do not run them near heat sources or place heavy objects on them. If leads must be run over sharp metal edges, protect the leads by winding them with vinyl tape or similar protection.
- ❑ **Use the designated parts and tools for installation.**
Use the supplied or designated parts and appropriate tools to install the product. The use of parts other than those supplied or designated may result in internal damage to the unit. Faulty installation may lead to an accident, a malfunction or fire.

- ❑ **Do not block the air vent or the cooling plate of the unit.**

Blocking these parts will cause the interior of the unit to overheat and will result in fire or other damage.

- ❑ **Do not install the product where it is exposed to strong vibrations or is unstable.**
Avoid slanted or strongly curved surfaces for installation. If the installation is not stable, the unit may fall down while driving and this can lead to an accident or injury.
- ❑ **Installation Angle**
The product should be installed in a horizontal position with the front end up at a convenient angle, but not more than 30°.
The user should bear in mind that in some areas there may be restrictions on how and where this unit must be installed. Consult your dealer for further details.
- ❑ **Wear gloves for safety. Make sure that wiring is completed before installation.**
- ❑ **To prevent damage to the unit, do not connect the power connector until the whole wiring is completed.**
- ❑ **Do not connect more than one speaker to one set of speaker leads. (except for connecting to a tweeter)**

Observe the following cautions when handling the battery for the remote control unit.

- Use only specified battery (CR2025).
- Match the polarity of the battery with the (+) and (-) marks in the battery case.
- Replace a dead battery as soon as possible.
- Remove the battery from the remote control unit when not using it for an extended period of time.
- Insulate the battery (by placing them in a plastic bag or covering them with vinyl tape) before disposal or storage.
- Dispose of the battery according to the local regulations.
- Do not disassemble, recharge, heat or short the battery. Do not throw a battery into a fire or water.

In case of battery leakage

- Thoroughly wipe the battery liquid off the battery case and insert new battery.
- If any part of your body or clothing comes into contact with battery liquid, wash it with plenty of water.
- If battery liquid comes into contact with your eyes, wash them with plenty of water and get immediate medical attention.

CAUTION:

- **PLEASE FOLLOW THE LAWS AND REGULATIONS OF YOUR STATE, PROVINCE OR COUNTRY FOR WIRING, INSTALLATION, AND USE OF THIS UNIT AND THE DEVICES TO BE CONNECTED.**

Before Reading These Instructions

Panasonic welcomes you to our constantly growing family of electronic products owners.

We endeavor to give you the advantages of precise electronic and mechanical engineering, manufactured with carefully selected components, and assembled by people who are proud of the reputation their work has built for our company.

We know this product will bring you many hours of enjoyment, and after you discover the quality, value and reliability we have built into it, you too will be proud to be a member of our family.

3

This is a guide book specific to system upgrading. Please refer to the operating instructions for basic operations, menu operations, specifications, etc.

System upgrade sample

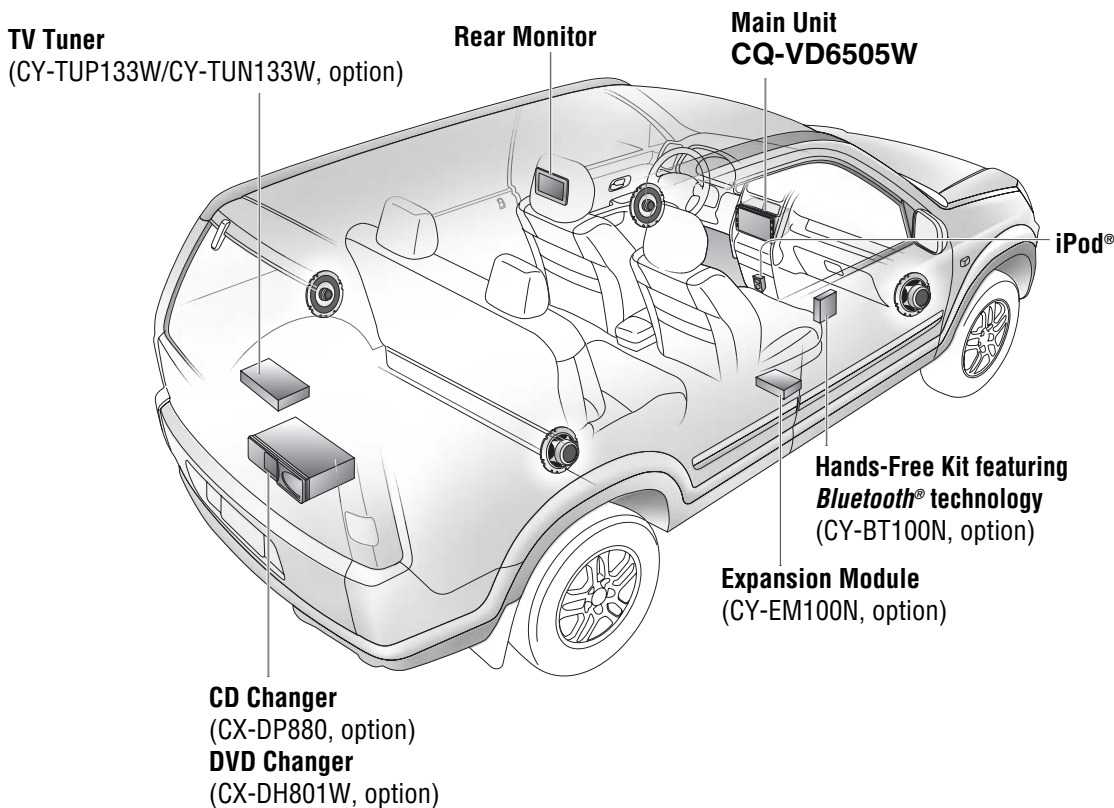

Connectable devices

■ DVD Changer

The optional adapter (Conversion Cable for DVD/CD Changer: CA-CC30N) allows you to connect the optional Panasonic DVD changer unit (CX-DH801W). For details, refer to the operating instructions for the DVD changer unit.

■ CD Changer

The optional adapter (Conversion Cable for DVD/CD Changer: CA-CC30N) allows you to connect the optional Panasonic CD changer unit (CX-DP880). For details, refer to the operating instructions for the CD changer unit.

■ TV tuner

You can connect the optional Panasonic TV tuner unit (CY-TUP133W/CY-TUN133W). For details, refer to the operating instructions for the TV tuner unit.

Note:

- CY-TUP133W/CY-TUN133W is an analog TV-specific tuner.
- If the analog broadcast system is replaced with the digital broadcast system in a country or area where CY-TUP133W/CY-TUN133W is used, TV broadcasts cannot be received.
- Inquire about the termination of analog broadcasting to the authorities concerned in the country or area where CY-TUP133W/CY-TUN133W is used.

■ iPod®

The optional adapter (Direct Cable for iPod: CA-DC300N) allows you to connect the optional iPod series.

The iPod equipped with a dock connector is exclusively connectable. Further information about the controllable iPod is described below.

Controllable iPod/software version

- 3rd generation iPod/ver. 2.3
- 4th generation iPod/ver. 3.1.1
- 5th generation iPod/ver. 1.2 (Refer to "Precautions in using an iPod with Video")
- iPod photo/ver. 1.2.1
- iPod mini/ver. 1.4.1
- iPod nano/ver. 1.2

* Operation check has been completed with software available at the end of September, 2006. We do not guarantee the operation with our future products or upgraded software.

iPod is a trademark of Apple Inc., registered in the U.S.A. and other countries.

■ Hands-Free Phone System

You can connect the optional Hands-Free Phone System (Hands-Free Kit featuring *Bluetooth*® technology: CY-BT100N). For details, refer to the operating instructions for the Hands-Free Phone System.

Note: This unit is designed **only for receiving calls**. It cannot send calls.

Bluetooth®

The Bluetooth word mark and logo are owned by the Bluetooth SIG, Inc. and any use of such marks by Matsushita Electric Industrial Co., Ltd. is under license. Other trademarks and trade name are those of their respective owners.

■ Expansion Module (hub unit)

You can connect the optional Expansion Module (hub unit) (CY-EM100N). Connection of the Expansion Module allows you to simultaneously connect optional devices mentioned before as well as other AV devices. For details, refer to the operating instructions for the Expansion Module.

Connectable devices

- CD/DVD changer (max. 1)
- iPod (max. 2)
- iPod with Video (max. 1)
- Hands-Free Phone System (max. 1)
- TV tuner (max. 1)

Note:

- Market conditions regarding optional devices vary with countries and regions. For further information, consult your dealer.
- If a non-Panasonic product is connected to this unit, we do not guarantee the operations of the product.
- If iPod with Video is connected, no more iPod can be connected.

Before Reading These Instructions (continued)

System upgrade sample

5

■ Simultaneous Multi-Device Connection

CQ-VD6505W

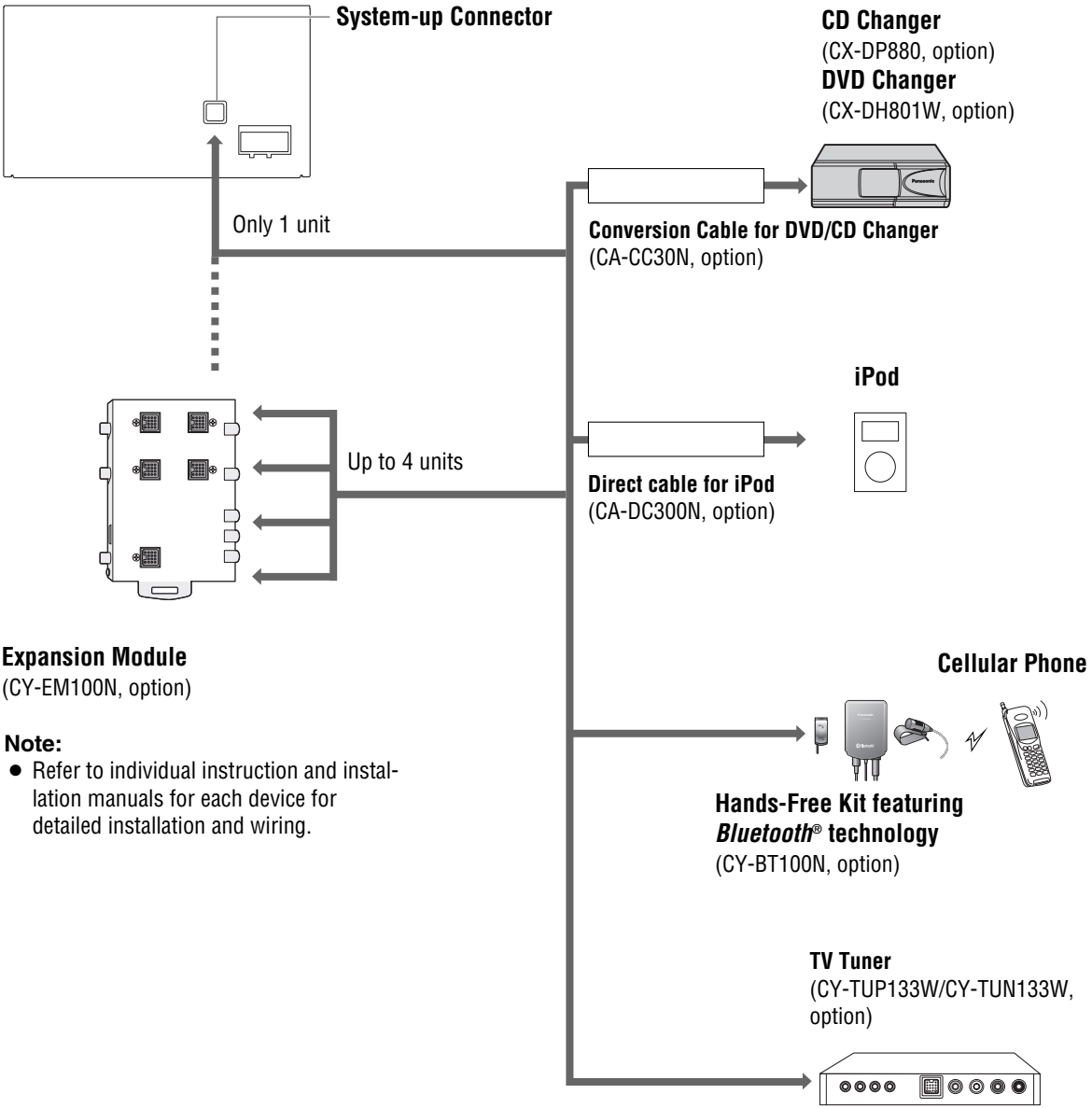

Note:

- Refer to individual instruction and installation manuals for each device for detailed installation and wiring.

■ 5.1-channel Surround System

This unit has a built-in 4-channel amplifier. The procedure for setting up a 5.1-channel surround system in order to play DVD software in a way that creates a “you are there” feel in a car is described below.

Note:

- Even if you are using this unit without installing a center speaker, surround speakers, or a subwoofer, it is still necessary to make the speaker settings in order to adjust the sound balance.

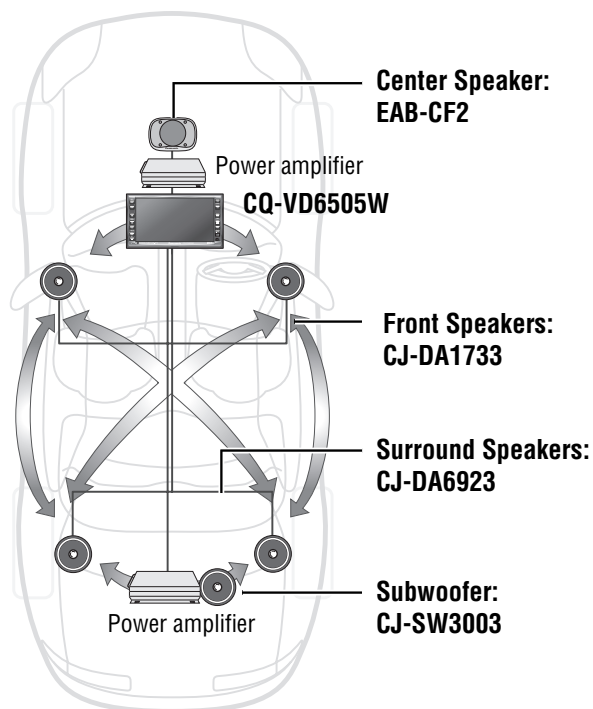

Contents

Common

Safety Information.....	2
Before Reading These Instructions.....	4
Touch Panel Operation Overview.....	8

Each Source

TV Tuner Control.....	10
CD Changer Control.....	12
DVD Changer Control	13
Bluetooth Hands-Free Kit	16
iPod Control.....	18

Settings

Settings.....	20
---------------	----

As needed

Troubleshooting.....	22
----------------------	----

Touch Panel Operation Overview

Notes on the Touch Panel

Before operation

- Clean the surface of the touch panel. (⇒ Operating Instructions)

Operation

- Use only your fingers to operate the touch panel.
- Do not press the panel forcefully.
- Do not scratch the panel with fingernails or any hard objects.

- Do not use a pen or other sharp implements to operate the touch panel.
- Do not bump the front panel.
 - ⇒ Failure to observe the above may damage or break the glass on the surface of the touch panel.

The State of Operation Screen

Example: CD Changer mode

Note:

- The following picture is partly darkened for explanation.
- Displaying contents and their positions partly vary with each mode. Refer to the description of each mode for details.



DISP Display Button
(⇒ next page)

CH-C Source Button
(Content varies with each source)

Displays the Source Selection Screen.

Source Selection Screen



Source Selection Screen appears.
Touch desired source button.
Touch **END** to quit.

Press **[SRC]** to change to desired mode.

MENU Menu Button

Displays the Menu Screen.

Menu Screen

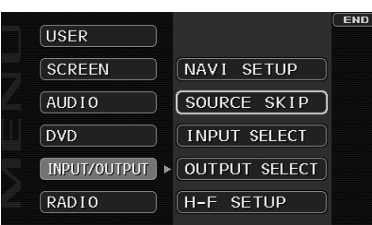

Menu Screen appears. Select desired setting.

Menu Setting, (⇒ Operating Instructions)

Press **[MENU]** to let menu screen appear.

Note:

- When an **iPod**, **H-F**, **TV** or **CH-C** is connected to this unit without involving the Expansion Module (CY-EM100N, option), any of them appears at the AV2 position.
- When **AV2** is selected on the condition that the Expansion Module is connected to this unit, the video and audio of the source connected to AUDIO IN/VIDEO IN of the Expansion Module come out.

Switching the display

Touching **DISP** allows users to switch between screens as follows.

□ How to Call up Operation Screen

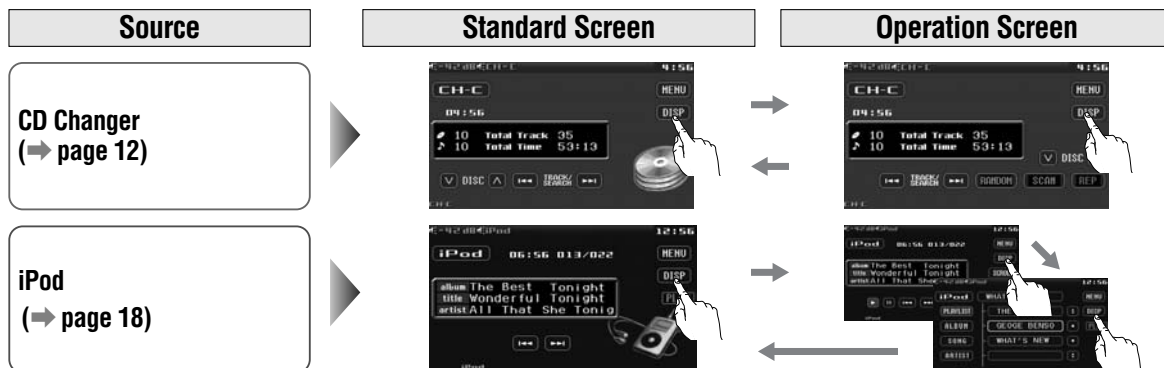

□ How to Cancel OSD (On Screen Display)

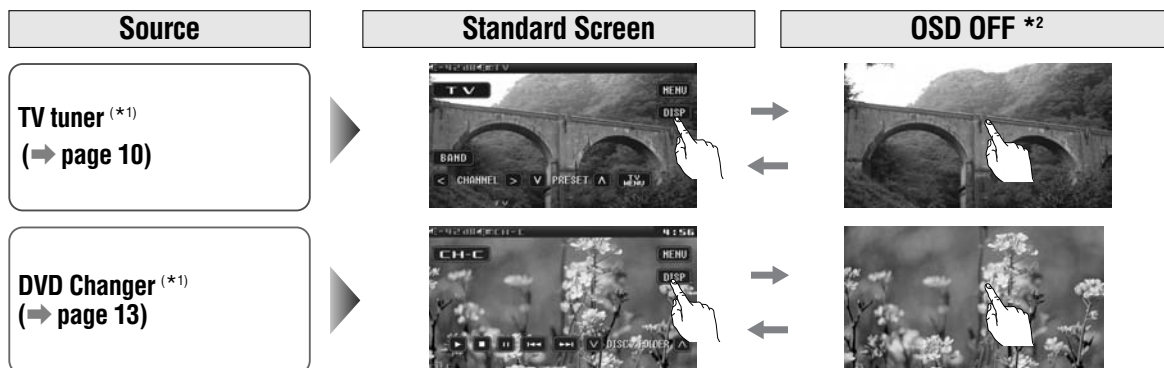

*1 To switch Operation Screen ON, touch the center of touch panel or press **[ENTER]** on the remote control.

*2 The operation screen is not available in the video mode.

Note:

- Refer to the description of each mode for how to operate the operation screen.

TV Tuner Control

Preparation:

- Connect a TV tuner (CY-TUP133W/CY-TUN133W, option) to the unit.
- It is required to install the TV antenna to receive TV broadcasts.

- For receiving TV broadcasts, stop your car where there is no obstacle to broadcast reception around.

TV Mode Selection

1 Touch "Source Button".



2 Touch (TV) on the Source Selection Screen. (Content varies with connected devices)



Press [SRC] to change to the TV mode.

Note:

- For the operations of the TV tuner with its remote control, aim the remote control at the remote control sensor of this unit.
- The remote control of the TV tuner (CY-TUP133W/CY-TUN133W, option) cannot turn on or off the power of the TV tuner.

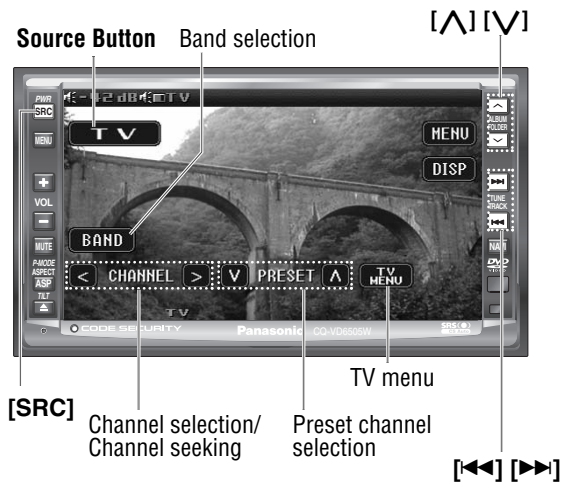



















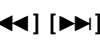











To switch Operation Screen ON, touch the center of touch panel or press [ENTER] on the remote control.

Tuning

Operations				
Band Selection		[BAND]	-	
Station Selection	 	 	 	Up Down
Channel Seeking	 	 	 	Up Down
Displaying TV Menu		-	-	Calls up the menu of the tuner. To cancel, touch again.
Selecting an Item on the TV Menu	 	[^] [v] [<] [>]	[^] [v] [<] [>]	Up/down Left/right

..... Touch/Press and hold

Preset Memory				
Operations				
Auto Preset Memory	12 channels with first to 12th highest in signal strength will be preset to each band.			
			–	Select a band. <ul style="list-style-type: none"> • Touch/press and hold for more than 2 seconds. • “–” appears if the number of receivable channels is less than 12. New channels overwrite existing saved channels.
Writing Preset Memory <p>Favorite preset channels can be written after you have set the preset channel once.</p>	Select a band and a channel.			
				
	 <ul style="list-style-type: none"> • Preset channel writing mode display appears. 			
				Select a channel that you want to exchange.
			–	Determine.
		–	–	<ul style="list-style-type: none"> • Exit from the preset writing.
Preset Channel Calling				Down
				Up
Deleting Preset Memory <p>Favorite preset channels can be deleted after you have set the preset channel once.</p>	Select a band and a channel.			
				
	 <ul style="list-style-type: none"> • Preset channel deleting mode display appears. 			
				Select a preset number that you want to delete.
			–	Determine.
		–	–	<ul style="list-style-type: none"> • Exit from the preset channel deletion.

 Touch/Press and hold for more than 2 seconds

CD Changer Control



• CD changer functions are designed for optional Panasonic CD changer unit. (CX-DP880)

Preparation:
 • Connect the CD changer, and load a magazine (discs).

CD Changer Mode Selection

1 Touch "Source Button".



2 Touch **CH-C (CH-C)** on the Source Selection Screen. (Content varies with connected devices)

Press **[SRC]** to change to the CD Changer mode.

To switch Operation Screen ON, touch **DISP**.

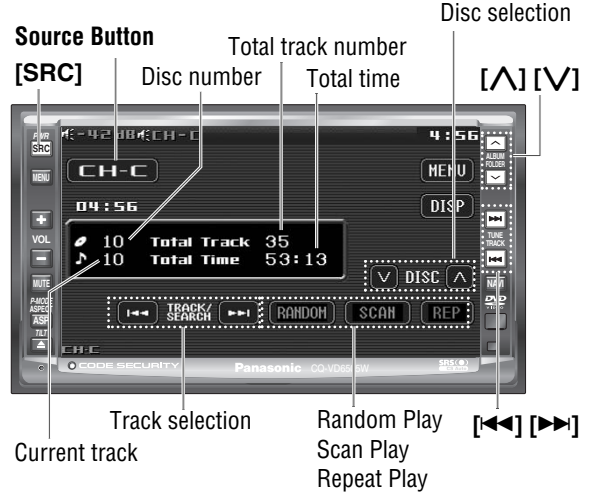

Basic Operations

Operations				
Disc Selection				Next disc
				Previous disc
Track Selection				Next track
				Beginning of the current track
				Previous track (Touch/press twice.)
Fast Forward/ Fast Reverse				Fast forward Release to resume playback.
				Fast reverse Release to resume playback.
Repeat Play		-	-	To cancel, touch again.
Repeat Play within the current Disc	*	-	-	To cancel, touch and hold for more than 2 seconds again.
Scan Play		-	-	To cancel, touch again.
Disc Scan Play	*	-	-	The first 10 seconds of the all the discs is played. To cancel, touch and hold for more than 2 seconds again.
Random Play		-	-	To cancel, touch again.
Random Play within the Current Disc	*	-	-	To cancel, touch and hold for more than 2 seconds again.

..... Touch/Press and hold

* Touch panel symbols will change to indicate these current mode.
 , , {D= DISC (disc)}

DVD Changer Control



- DVD changer functions are designed for optional Panasonic DVD changer unit. (CX-DH801W)

Preparation:

- Connect the DVD changer, and load a magazine (discs).

DVD Changer Mode Selection

① Touch "Source Button".



② Touch **CH-C** (CH-C) on the Source Selection Screen. (Content varies with connected devices)

Press **[SRC]** to change to the DVD Changer mode.

Note:

- Be sure to connect RCA cord (video)(yellow) of the Panasonic DVD Changer to AV2-IN and set **[CH VIDEO INPUT]** to **[ON]** (→ page 20). Otherwise the changer cannot be controlled through this unit.
- Refer to the operating instructions and installation instructions of CX-DH801W as well.

Source Button

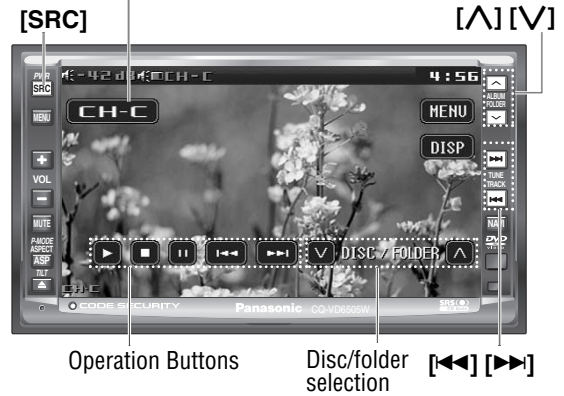

To switch Operation Screen ON, touch the center of touch panel or press **[ENTER]** on the remote control.

Basic Operations

Operations	Compatible Discs	Operations			
Track/file Selection				-	Next track/file
				-	Beginning of the current track/file Previous track/file (Touch/press twice.)
		Note: • When playing a DVD, there are cases where it is not possible to return to the start of a chapter that spans 2 titles. (→ Operating Instructions)			
Fast Forward/ Fast Reverse				-	Fast forward Release to resume playback.
				-	Fast reverse Release to resume playback.
		The speed changes if the button is held down as follows. Regular speed → 2 times → 5 times → 10 times → 30 times			
Folder Selection			-	-	Next folder
			-	-	Previous folder
Stop				-	To resume playback, touch/press / .
Pause				-	To resume playback, touch/press / .
		 Touch/Press and hold		

DVD Changer Control (continued)



Basic Operations (continued)

Slow Playback		 Note: <ul style="list-style-type: none"> Reverse slow playback is not possible. 	 	-	<ul style="list-style-type: none"> Touch/press and hold in the pause mode. Playback is at about 1/4 normal speed. To resume normal playback, touch/press / .
Disc Selection	 	 	- -	- -	Next disc Previous disc

..... Touch/Press and hold

Chapter/title/track Selection

Showing menu and selecting an item <div style="border: 1px solid black; padding: 5px;"> <p>* Note on VCD: For VCD, press [RETURN] instead of [DVD MENU].</p> </div>		-	[DVD MENU] ↓ [<] [>] [^] [v] ↓ [ENTER] [RETURN]	- [◀] [▶] [^] [v] - -	❶ Menu appears. ↓ ❷ Select the desired item. ↓ ❸ Determine the setting. ----- Returns to the previous display.
--	--	---	---	-----------------------------------	--



Bluetooth Hands-Free Kit

Preparation:

- Connect the Bluetooth hands-free kit (CY-BT100N) and establish the pairing. Refer to the instruction manual for the Bluetooth hands-free kit for further information.

Connection of the optional Bluetooth hands-free kit allows users to talk on a handsfree cellular phone in a car.

Note:

- **CY-BT100N is designed only for receiving calls. It cannot send calls.**

Bluetooth Hands-Free Mode

This mode is not selectable by pressing **[SRC]** or touching an item on the panel, but activated by receiving an incoming call. (To pick up the phone, press **[Hang-on]** on the hands-free kit.)

Note:

- The telephone number of the calling party is displayed.
- "CONNECT" is displayed when information of the calling party cannot be acquired.
- We shall not guarantee all the functions of the Bluetooth-ready mobile phone to be connected.

[+] [-]



Switch unit

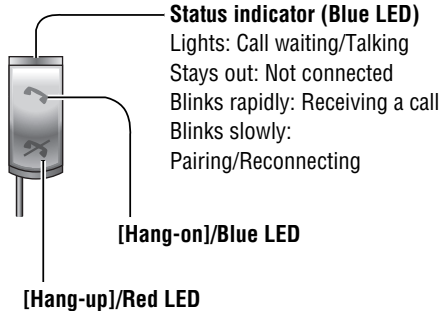









Example: DVD mode



When receiving a call...



Useful Function

Operations				
<p>Adjustment of Ring Volume</p> <p>When the ringtone is the same as that of the cellular phone,</p>	Adjust the volume when a call is coming in.			
	-	[-]	[-]	down
	-	[+]	[+]	up
<p>When the ringtone is not the same as that of the cellular phone (but this unit-specific sound),</p> 	Adjust the volume when a call is coming in.			
		[+] or [<]	[+]	on
		[-] or [>]	[-]	mute
	<ul style="list-style-type: none"> •  and  appear only when the ringtone is not the same as that of the cellular phone. The buttons disappear when communication starts. 			
<p>Adjustment of phone receiver volume</p>				
	-	[-]	[-]	down
	-	[+]	[+]	up
<p>Back to Previous Source</p>				
	-	-	-	<ul style="list-style-type: none"> • Press [Hang-up] on the hands-free kit.
	<ul style="list-style-type: none"> • When [Hang-up] on the hands-free kit is pressed to hang up the phone, the previous mode resumes. 			

Note:

- Reception of a call during the camera or navigation system is activated does not call up the Hands Free screen but displays only the telephone number of the calling party. Pressing **[Hang-on]** deletes the telephone number from the screen. **CALL** does not appear.
- Reception of a call at MUTE-on temporarily cancels the mute function and disables operations. After end of phone communication, the mute function resumes.
- Source change and **AUDIO**-related operations in the menu are not feasible during reception of a call. But volume is adjustable and the power can be turned off even during reception of a call.
- Reception of a call at power-off does not turn on the power of this unit.

iPod Control



Preparation:
 • Connect the iPod through connecting cable (CA-DC300N, option).

iPod Mode Selection

1 Touch "Source Button".



2 Touch  (iPod) on the Source Selection Screen. (Content varies with connected devices)

Press [SRC] to change to the iPod mode.

To switch Operation Screen ON, touch .

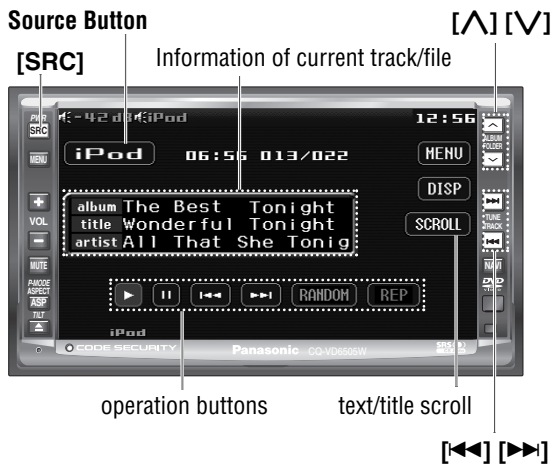





















Note:



- Disconnect the iPod from this unit, reset the iPod, and connect the iPod again when a problem occurs including the following: the iPod is not recognized/the iPod is not operable from the iPod itself or this unit/the image or sound from the iPod connected to this unit is not correctly reproduced.
- "NO iPod" appears until the iPod is recognized after connecting the iPod, turning on the power of the main unit, or performing source selection on the main unit side. This indicates there is nothing wrong with the main unit.
- We shall not guarantee all the functions of the iPod to be connected.
- The iPod equipped with a dock connector is exclusively connectable.

- The number of displayable characters for a file name is limited. (up to 252 bytes)
- Controllable iPod/software version**
 - 3rd generation iPod/ver. 2.3
 - 4th generation iPod/ver. 3.1.1
 - 5th generation iPod/ver. 1.2 (Refer to "Precautions in using an iPod with Video")
 - iPod photo/ver. 1.2.1
 - iPod mini/ver. 1.4.1
 - iPod nano/ver. 1.2
- * Operation check has been completed with software available at the end of September, 2006. We do not guarantee the operation with our future products or upgraded software.

Basic Operations



Operations				
Track/file Selection				Next track/file
				Beginning of the current track/file Previous track/file (Touch/press twice.)
Fast Forward/ Fast Reverse				Fast forward Release to resume playback.
				Fast reverse Release to resume playback.
Title Scroll		-	-	Scrolls the title once
Pause			-	To resume playback, touch/press again or touch/press  /  .

 Touch/Press and hold

Useful Function				
Shuffle Songs		-	-	To cancel, touch again.
Shuffle Albums		-	-	To cancel, touch and hold again.
Note: ● The shuffle function of iPod corresponds to the RANDOM function of this unit.				
Repeat Play		-	-	To cancel, touch again.
Note: ● The All Repeat Play function of iPod is always activated and cannot be canceled from this unit.				

 Touch/Press and hold

* Touch panel symbols will change to indicate these current mode.

 {A= ALBUM (album)},  {S= SONG (song)}

Touching  allows users to switch between screens as follows.

Standard Screen



File indicator
A number up to 999 is displayable.

Current state

File up/down

Operation Screen



File indicator
A number up to 999 is displayable.

Title scroll

Play/pause

Play setting

File up/down

Folder List/File List Screen





Back to 1-upper directory

Playback category selection button

 Playback by playlist (default)

 Playback by album

 Playback by song

 Playback by artist

Folder list/file list

Settings

This is a guide book specific to system upgrading. Please refer to the operating instructions for basic operations, menu operations, specifications, etc.

USER SCREEN AUDIO DVD **INPUT/OUTPUT** RADIO

NAVI SETUP (Navigation set up)

Navigation Setting

NAVI SP (Navigation Speaker)

BOTH : Front Left/Right speaker

L ch : Front Left only

R ch : Front Right only

default: **BOTH**

NAVI MUTE (Navigation mute level)

Preparation: Connect the navi mute lead.

OFF : unchanged

LEV 1 : -20 dB

LEV 2 : -30 dB

LEV 3 : no sound

default: **LEV 1**

Note:

- You can set the navigation mute level when **RGB** is selected on **NAVI INPUT**.

NAVI VOLUME (Navigation Volume)

Volume adjustment of the car navigation system.

< : down, **>** : up

Setting range: 0 to 40
default: 20

Connection with Panasonic car navigation system

 : This book refers to connections to the Panasonic car navigation system that will come onto the market in the future. Descriptions regarding the car navigation system are boxed with a dotted line.

Note:

- If a non-Panasonic navigation system is connected to this unit, we do not guarantee the operations of the navigation system.

INPUT SELECT

Input selection

NAVI INPUT (Navigation Input)

RGB : connected to the RGB input cord, or a car navigation system not connected

AV1 : connected to the AV1-IN

default: **RGB**

CH VIDEO INPUT (Video input for DVD Changer)

ON : connected to the AV2-IN

OFF : unconnected

default: **OFF**

Note:

- The audio output should be connected to the AV2-IN.

CAMERA (Rear view camera set up)

Selection of the terminal that connects to the rear view camera.

Preparation: Connect the reverse lead. (⇒ Installation Instructions)

ON : connected to the CAMERA-IN

OFF : unconnected

default: **OFF**

Note:

- Make sure to select **OFF** when no rear view camera is connected.
- The image from the rear view camera may be blurred in the night or a dark place.

OUTPUT SELECT

Output Selection

REAR MONITOR (Rear Monitor Set up)

You can have different picture and sound on the front and rear monitors at the same time.

Preparation: Connect another optional rear monitor.
(⇒ Installation Instruction)

When the Expansion Module (CY-EM100N, option) is disconnected:



AUTO : same as front monitor*

DVD : DVD/VCD/CD/MP3/WMA

AV1 : AV1

AV2 : AV2

* iPod with Video is included.

default: AUTO

Note:

- This menu can also be opened by touching/pressing and holding **MENU** / **[MENU]**.
- Images are not displayed on the rear monitor in the DVD changer mode even if **AUTO** is selected.

When the Expansion Module (CY-EM100N, option) is connected:



- Connection of the Expansion Module (CY-EM100N, option) provides two additional source buttons.
- Connection of audio-only source to the Expansion Module (CY-EM100N, option) provides no additional button.

Note:



- The screen above shows the case that no device is connected to the Expansion Module. In such a case, the additional buttons are displayed gray and not selectable.
- Only single source of audio and video can come out through the Expansion Module (CY-EM100N, option). Therefore, if the audio and video from the changer are played on the front monitor, the audio and video from the TV cannot be played on the rear monitor at the same time.

Example:

When a DVD changer and a TV are connected to the Expansion Module (CY-EM100N, option),



- **TV** is selectable. However, the setting is not feasible because the changer is in operation on the front monitor.
- To play the TV on the rear monitor, select **TV** for the front monitor, or select a source other than the Expansion Module.

H-F SETUP (Hands-free Set Up)

Hands-free Set Up

H-F SP (Hands-free speaker)

Preparation: Connect Bluetooth hands-free kit (CY-BT100N). (⇒ Installation Instructions)

BOTH : Front Left/Right speaker

L ch : Front Left only

R ch : Front Right only

default: BOTH

Troubleshooting



□ If You Suspect Something Wrong

Check and take steps as described below.

21

If the described suggestions do not solve the problem, it is recommended to take the unit to your nearest authorized Panasonic Service Center. The product should be serviced only by qualified personnel. Please refer checking and repair to professionals. Panasonic shall not be liable for any accidents arising out of neglect of checking the unit or your own repair after your checking. **Never take measures especially those other than indicated by *italic* letters in "Possible Solution" described below because those are too dangerous for users to handle themselves.**

⚠ Warning

- Do not use the unit in an irregular condition, for example, without sound, or with smoke or a foul smell, which can cause ignition or electric shock. Immediately stop using the unit and consult your dealer.
- Never try to repair the unit by yourself because it is dangerous to do so.

■ Car Navigation, VCR, Camcorder, Rear View Camera, Rear Monitor

Problem	Possible cause → Possible solution
The picture from a car navigation system is not displayed.	The connection of a car navigation system is not correct. → Connect it correctly. Input setting of a car navigation system is not correct. → Correct the input setting.
The picture from a VCR or a camcorder is not displayed.	A VCR or Camcorder is not connected correctly. → Connect a VCR or Camcorder correctly.
The picture from a rear view camera is not displayed.	Rear view camera is not connected correctly. → Connect a rear view camera correctly. Input setting of camera is not correct. → Correct the input setting.
The picture or the sound of the rear monitor is not switchable.	[AUTO] is not selected as the rear monitor setting. → Select [AUTO] for the setting.

■ iPod Control

The iPod is not recognized. The iPod is not operable from the iPod itself or this unit. The image or sound from the iPod connected to this unit is not correctly reproduced.	Communication between this unit and the iPod may be temporarily interrupted even when both of them are active. This phenomenon does not indicate that this unit is out of order. → Disconnect the iPod and reset the iPod. After completion of iPod reset, connect the iPod again.
--	--

❑ Error Display Messages

■ CD Changer/DVD Changer Control

Display	Possible cause → Possible solution
NON PLAYABLE DISC	<p>Disc is dirty, or is upside down. → Check disc.</p> <p>Disc has scratches. → Check disc.</p>
MECHANISM ERROR	<p>No operation by some cause. → Press [▲]. If failure persists, press the reset switch. (Press the reset switch in the CD changer). If normal operation is not restored, call the store where you purchased the unit or the nearest Panasonic Service Center.</p>
FILE ERROR	<p>The type of the file that is selected is not supported. → Check disc.</p>
PROTECTED	<p>A WMA file can be copyrighted. → The file protected by copyright is not playable.</p>
NO DISC	<p>No disc is in the player. → Insert disc into the disc slot.</p>
NO MAGAZINE	<p>No magazine is in the changer. → Load the changer with CD-loaded magazine.</p>
REGION ERROR	<p>An attempt was made to play a disc with a region number other than "3" or "ALL". → Press [▲] and check the disc.</p>

Note:

- There may be cases when the disc numbers affected by an error are displayed before "NON PLAYABLE DISC".
- Displays and the steps to be taken for errors vary in part from changer to changer. For details, refer to the Operating Instructions for the changer used.

■ iPod Control

NO iPod	<p>The iPod cable was disconnected in the iPod mode. → Reconnect the iPod cable.</p>
NO SONGS	<p>Your iPod has no playable music. → Download playable music to your iPod.</p>

Matsushita Electric Industrial Co., Ltd.
Web Site : <http://panasonic.net>

Free Manuals Download Website

<http://myh66.com>

<http://usermanuals.us>

<http://www.somanuals.com>

<http://www.4manuals.cc>

<http://www.manual-lib.com>

<http://www.404manual.com>

<http://www.luxmanual.com>

<http://aubethermostatmanual.com>

Golf course search by state

<http://golfingnear.com>

Email search by domain

<http://emailbydomain.com>

Auto manuals search

<http://auto.somanuals.com>

TV manuals search

<http://tv.somanuals.com>