

Panasonic®

Dual DIN In-dash 7" Widescreen Color LCD Monitor/DVD Receiver
듀얼 DIN 인대쉬 7" 와이드스크린 컬러 LCD 모니터/DVD 리시버
Сдвоенный DIN 7-дюймовый автомобильный широкоэкранный цветной ЖК-монитор/DVD-ресивер



Model: **CQ-VW100W**



- Please read these instructions carefully before using this product and keep this manual for future reference.
- 본 제품의 바른 사용을 위해, 이 사용설명서를 잘 읽어 주십시오.
잘 보관하시어 필요하실 때마다 읽어주시기 바랍니다.
- Перед началом эксплуатации просим прочитать настоящую инструкцию внимательно и хранить ее на пользование на будущее.

Safety Information

■ Read the operating instructions for the unit and all other components of your car audio system carefully before using the system. They contain instructions about how to use the system in a safe and effective manner. Panasonic assumes no responsibility for any problems resulting from failure to observe the instructions given in this manual.

■ This manual uses pictographs to show you how to use the product safely and to alert you to potential dangers resulting from improper connections and operations. The meanings of the pictographs are explained below. It is important that you fully understand the meanings of the pictographs in order to use this manual and the system properly.



Warning

This pictograph intends to alert you to the presence of important operating instructions and installation instructions. Failure to heed the instructions may result in severe injury or death.



Caution

This pictograph intends to alert you to the presence of important operating instructions and installation instructions. Failure to heed the instructions may result in injury or material damage.

Warning

Observe the following warnings when using this unit.

- ❑ **The driver should neither watch the display nor operate the system while driving.**
Watching the display or operating the system will distract the driver from looking ahead of the vehicle and can cause accidents. Always stop the vehicle in a safe location and use the parking brake before watching the display or operating the system.
- ❑ **Use the proper power supply.**
This product is designed for operation with a negative grounded 12 V DC battery system. Never operate this product with other battery systems, especially a 24 V DC battery system.
- ❑ **Protect the Deck Mechanism.**
Do not insert any foreign objects into the slot of this unit.
- ❑ **Do not disassemble or modify the unit.**
Do not disassemble, modify the unit or attempt to repair the product yourself. If the product needs to be repaired, consult your dealer or an authorized Panasonic Service Center.
- ❑ **Do not use the unit when it is out of order.**
If the unit is out of order (no power, no sound) or in an abnormal state (has foreign objects in it, is exposed to water, is smoking, or smells), turn it off immediately and consult your dealer.
- ❑ **Refer fuse replacement to qualified service personnel.**
When the fuse blows out, eliminate the cause and have it replaced with the fuse prescribed for this unit by a qualified service engineer. Incorrect replacement of the fuse may lead to smoke, fire, and damage to the product.

Observe the following warnings when installing.

- ❑ **Disconnect the lead from the negative (–) battery terminal before installation.**
Wiring and installation with the negative (–) battery terminal connected may cause electrical shock and injury due to a short circuit.
Some cars equipped with the electrical safety system have specific procedures of battery terminal disconnection.
FAILURE TO FOLLOW THE PROCEDURE MAY LEAD TO THE UNINTENDED ACTIVATION OF THE ELECTRICAL SAFETY SYSTEM RESULTING IN DAMAGE TO THE VEHICLE AND PERSONAL INJURY OR DEATH.
- ❑ **Never use safety-related components for installation, grounding, and other such functions.**
Do not use safety-related vehicle components (fuel tank, brake, suspension, steering wheel, pedals, airbag, etc.) for wiring or fixing the product or its accessories.
- ❑ **Installing the product on the air bag cover or in a location where it interferes with airbag operation is prohibited.**
- ❑ **Check for piping, gasoline tank, electric wiring, and other items before installing the product.**
If you need to open a hole in the vehicle chassis to attach or wire the product, first check where the wire harness, gasoline tank, and electric wiring are located. Then open the hole from outside if possible.
- ❑ **Never install the product in a location where it interferes with your field of vision.**
- ❑ **Never have the power cord branched to supply other equipment with power.**
- ❑ **After installation and wiring, you should check the normal operation of other electrical equipment.**
The continuation of their using in abnormal conditions may cause fire, electrical shock or a traffic accident.
- ❑ **In the case of installation to an airbag-equipping car, confirm warnings and cautions of the vehicle manufacturer before installation.**
- ❑ **Make sure the leads do not interfere with driving or getting in and out of the vehicle.**
- ❑ **Insulate all exposed wires to prevent short circuiting.**

Caution

Observe the following cautions when using this unit.

- ❑ **Keep the sound volume at an appropriate level.**
Keep the volume level low enough to be aware of road and traffic conditions while driving.
- ❑ **Do not insert or allow your hand or fingers to be caught in the unit.**
To prevent injury, do not get your hand or fingers caught in moving parts or in the disc slot. Especially watch out for infants.
- ❑ **This unit is designed for use exclusively in automobiles.**
- ❑ **Do not operate the unit for a prolonged period with the engine turned off.**
Operating the audio system for a long period of time with the engine turned off will drain the battery.
- ❑ **Do not expose the unit to direct sunlight or excessive heat.**
Otherwise these will raise the interior temperature of the unit, and it may lead to smoke, fire, or other damage to the unit.
- ❑ **Do not use the product where it will be exposed to water, moisture, or dust.**
Exposure of the unit to water, moisture, or dust may lead to smoke, fire, or other damage to the unit. Make especially sure that the unit does not get wet in car washes or on rainy days.

Observe the following cautions when installing.

- ❑ **Refer wiring and installation to qualified service personnel.**
Installation of this unit requires special skills and experience. For maximum safety, have it installed by your dealer. Panasonic is not liable for any problems resulting from your own installation of the unit.
- ❑ **Follow the instructions to install and wire the product.**
Not following the instructions to properly install and wire the product could cause an accident or fire.
- ❑ **Take care not to damage the leads.**
When wiring, take care not to damage the leads. Prevent them from getting caught in the vehicle chassis, screws, and moving parts such as seat rails. Do not scratch, pull, bend or twist the leads. Do not run them near heat sources or place heavy objects on them. If leads must be run over sharp metal edges, protect the leads by winding them with vinyl tape or similar protection.

- ❑ **Use the designated parts and tools for installation.**
Use the supplied or designated parts and appropriate tools to install the product. The use of parts other than those supplied or designated may result in internal damage to the unit. Faulty installation may lead to an accident, a malfunction or fire.
- ❑ **Do not block the air vent or the cooling plate of the unit.**
Blocking these parts will cause the interior of the unit to overheat and will result in fire or other damage.
- ❑ **Do not install the product where it is exposed to strong vibrations or is unstable.**
Avoid slanted or strongly curved surfaces for installation. If the installation is not stable, the unit may fall down while driving and this can lead to an accident or injury.
- ❑ **Installation Angle**
The product should be installed in a horizontal position with the front end up at a convenient angle, but not more than 30°.
The user should bear in mind that in some areas there may be restrictions on how and where this unit must be installed. Consult your dealer for further details.
- ❑ **Wear gloves for safety. Make sure that wiring is completed before installation.**
- ❑ **To prevent damage to the unit, do not connect the power connector until the whole wiring is completed.**
- ❑ **Do not connect more than one speaker to one set of speaker leads. (except for connecting to a tweeter)**

CAUTION:

- **PLEASE FOLLOW THE LAWS AND REGULATIONS OF YOUR STATE, PROVINCE OR COUNTRY FOR WIRING, INSTALLATION, AND USE OF THIS UNIT AND THE DEVICES TO BE CONNECTED.**

Safety Information (continued)

⚠ Caution

THIS PRODUCT IS A CLASS I LASER PRODUCT.
USE OF CONTROLS OR ADJUSTMENTS OR PERFORMANCE
OF PROCEDURES OTHER THAN THOSE SPECIFIED HEREIN
MAY RESULT IN HAZARDOUS RADIATION EXPOSURE.
DO NOT OPEN COVERS AND DO NOT REPAIR BY YOUR-
SELF. REFER SERVICING TO QUALIFIED PERSONNEL.



This system is designed so that you cannot see moving pictures while you are driving.

- Park your car in a safe place and pull the side brake (parking brake) lever before watching the monitor.
- A rear monitor (option) displays moving pictures while driving.

Note:

- Be sure to connect the side brake (parking brake) connection lead. (⇒ Installation Instructions)

Notes on Use

Liquid Crystal Panel

- Do not cause impact to the liquid crystal panel.
- Usage temperature range: 0 °C to 40 °C
When the temperature is very cold or very hot, the image may not appear clearly or may move slowly. Also, movement of the image may seem to be out of synchronization or the image quality may decline in such environments. Note that this is not a malfunction or problem.
- In order to protect the liquid crystal panel, keep it out of direct sunlight while the unit is not in use.
- Sudden changes in the temperature inside the car such as those which occur immediately after the car's air conditioner or heater has been turned on may cause the inside of the liquid crystal panel to cloud over due to water vapor or it may cause condensation (droplets of water) to form and, as a result, the panel may not work properly. Do not use the unit while these symptoms are in evidence but leave the unit standing for about an hour, and then resume or start use.

Before Reading These Instructions

Differences Among 3 Models

This operating instruction manual is for 3 models CQ-VW100W2/CQ-VW100W3 and CQ-VW100W5.

The following table shows the playable region number for each model.

Model	Playable region number
CQ-VW100W2	2 (ALL)
CQ-VW100W3	3 (ALL)
CQ-VW100W5	5 (ALL)

Example:



“Before Disc Playback”
(→ page 16)

Components



1. Main Unit
(LCD monitor/DVD player)

Qty.: 1



2. Operating Instructions
<YFM264C061CA>

Qty.: 1



3. System Upgrade Guidebook
<YFM264C062CA>

Qty.: 1



4. Installation Instructions
<YFM294C126CA>

Qty.: 1

5. Installation Hardware (screws, cords, etc.)
(→ Installation Instructions)

Note:

- The number in parenthesis underneath each accessory part name is the part number for maintenance and service.
- Accessories and their parts numbers are subject to modification without prior notice due to improvements.

Features

Panasonic welcomes you to our constantly growing family of electronic products owners. We endeavor to give you the advantages of precise electronic and mechanical engineering, manufactured with carefully selected components, and assembled by people who are proud of the reputation their work has built for our company. We know this product will bring you many hours of enjoyment, and after you discover the quality, value and reliability we have built into it, you too will be proud to be a member of our family.

Please refer to the separate “System Upgrade Guidebook” for how to operate this unit when optional devices are connected.

- No device is connected to this unit. → Basic operations are covered only by this book.
- Optional devices are connected to this unit. → Refer to the “System Upgrade Guidebook” in addition.

■ Simultaneous Multi-Device Connection (with Expansion Module (hub unit))

You can connect the optional Expansion Module (hub unit) (CY-EM100N). Connection of the Expansion Module allows you to simultaneously connect optional devices mentioned before as well as other AV devices. For details, refer to the operating instructions for the Expansion Module.

Connectable devices

- CD/DVD changer (max. 1)
- iPod® (max. 2)
- Hands Free Kit with Audio Streaming featuring Bluetooth® technology (Bluetooth unit) (max. 1)
- TV tuner (max. 1)

Note:

- Market conditions regarding optional devices vary with countries and regions. For further information, consult your dealer.
- If a non-Panasonic product is connected to this unit, we do not guarantee the operations of the product.

■ Integration of the monitor, FM/AM radio, DVD Video/Video CD player and CD/MP3/DivX player

■ Built-in AV Input/Output Terminals

For more convenient connection and setup, all terminals are now provided on the unit itself.

Note:

- If a non-Panasonic product is connected to this unit, we do not guarantee the operations of the product.

■ SQ (Sound Quality)

You have 6 preset modes (Flat, Rock, Pop, Vocal, Jazz, Club). You can customize your setting for these (except Flat) and save them for instant recall.

SQ3 (3-Band Sound Quality)

Center frequency and level are adjustable in each of 3 bands. This lets you fine-tune sound quality for each genre to suit car-interior acoustics and your personal preferences. (→ page 33)

■ GUI (Graphic User Interface)

GUI displays various indications with colorful symbols to enhance visibility, enjoyment, and operability.

■ Disc type auto-detection

The signal auto-detection function of this unit allows users to be free from selection between PAL and NTSC before use of your discs. (For output signal, set . (→ page 34))

■ Touch Panel Operation

Simply touch the screen lightly to operate virtually all functions. Easy-to-use menus and icons let you “touch and choose” what you want, so you can start using your system from the very first day. That also means that while you drive, you can concentrate on the road.

■ DVD-R, DVD-RW Playback (→ page 16, 42 for details)

■ ID code

4-digit ID code for increased security.

Fill in the ID code memo (→ page 40).

Contents



English	2
한국어	46
Русский	90

<input type="checkbox"/> Safety Information	2
<input type="checkbox"/> Notes on Use	5
<input type="checkbox"/> Before Reading These Instructions	5
<input type="checkbox"/> Components	5
<input type="checkbox"/> Features	6

<input type="checkbox"/> Preparation	8
First time power on, other settings, symbols used in this manual	
<input type="checkbox"/> Name of Controls and Functions	10
<input type="checkbox"/> Touch Panel Operation Overview	12

<input type="checkbox"/> General	14
Power on/power off, display open/close, source selection, volume, mute, tilt angle	
<input type="checkbox"/> Before Disc Playback	16
<input type="checkbox"/> Disc Player	18
<input type="checkbox"/> Notes on MP3/DivX	22
<input type="checkbox"/> Radio	24
<input type="checkbox"/> AV1/AV2	26

<input type="checkbox"/> Settings	28
Setup operation	
Basic setting, screen, sound, disc, radio	

<input type="checkbox"/> About DivX VOD Content	36
<input type="checkbox"/> Troubleshooting	37
<input type="checkbox"/> Maintenance	41
<input type="checkbox"/> Notes on Discs	42
<input type="checkbox"/> Language Code List	43
<input type="checkbox"/> Definition of Terms	44
<input type="checkbox"/> Specifications	45

Preparation

First Time Power On

When the power of this unit is turned on for the first time, the following screen appears. Perform the settings in accordance with the specifications of the car on which this unit is mounted.

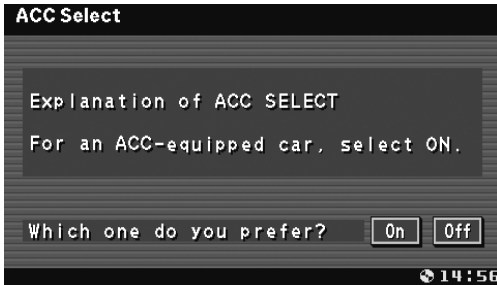

: sets to ON if your car has ACC position.

: sets to OFF if your car has no ACC position.

default:

Note:

- For an ACC-equipped car, select ON. The following functions are available.
 - The power is turned on automatically when inserting a disc or magazine.
 - selection disables turning on the power of the main unit through the remote control.

⚠ Caution

- **Be sure to select off when your car has no ACC position in the ignition switch. Failure to do this could cause the battery to go dead.**

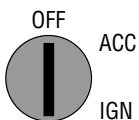

Other Settings

Please refer to the separate “System Upgrade Guidebook” for how to operate this unit when optional devices are connected.

Basic Setting (basic settings) (→ page 30)

clock, ID code, input, memory clear, other

Screen (screen settings) (→ page 32)

dimmer, display, aspect

Sound (sound settings) (→ page 33)

SQ3, bass/treble, balance/fader

Disc (disc settings) (→ page 34)

audio language, subtitle language, menu language, video setting, audio setting, DivX registration

Radio (radio settings) (→ page 35)

FM setup

Note:

- Refer to “Settings” (→ page 28) for further information about operations, settings, and others of the menu screen.

You may need to set the following depending on the devices to be connected.

AV1/AV2 (Camcorder, VCR, etc.)

- Adjust . (→ page 31)

⚠ Warning

- **When you connect external devices to this unit, be sure to connect the side brake connection lead (→ Installation Instructions).**

Symbols used in this manual

Pictographs

You can perform some operations of this unit in one or more methods with the touch panel or remote control. This book explains such operations in tabular form as follows. Refer to the following for the pictographs located in the upper part of each table.



Compatible types of disc

The discs compatible with the targeted operation.



Operation on the Touch Panel

You can use the touch panel to perform the targeted operation. If the operation is not executable with the touch panel, “—” is displayed.



Operation on the Main Unit

You can use the Main Unit to perform the targeted operation. If the operation is not executable with the Main Unit, “—” is displayed.

Disc Marks

The following pictographs are used for the descriptions of disc operation. (→ page 17-21)

: DVD

: VCD (Video CD)

: CD

: CD-Rs/RWs containing MP3 files

: CD-Rs/RWs or DVD-Rs/RWs containing DivX files

Name of Controls and Functions

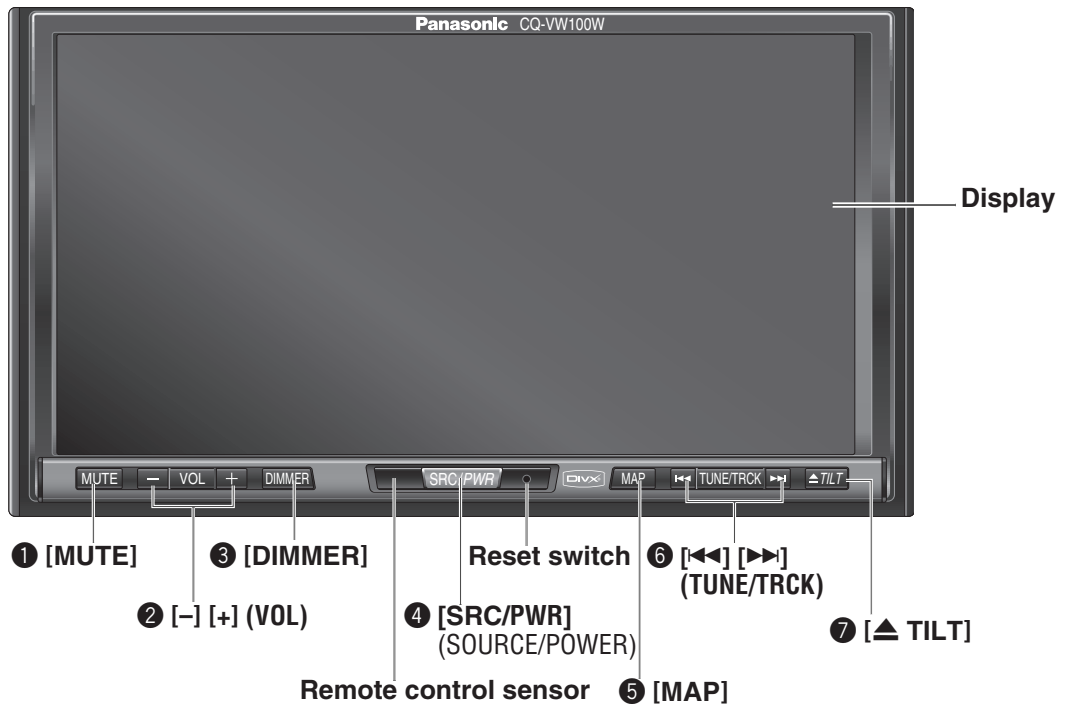

[]: This book refers to connections to the Panasonic car navigation system that will come onto the market in the future. Descriptions regarding the car navigation system are boxed with a dotted line.

- | | |
|---|--|
| <p>1 [MUTE]</p> <ul style="list-style-type: none"> • Mutes the sound temporarily. | <p>6 [◀▶] (TUNE/TRCK)</p> <ul style="list-style-type: none"> • Selects or searches for a track, file, station. • Fast forward/fast reverse. • Slow playback ([▶▶]). |
| <p>2 [+] [-] (VOL)</p> <ul style="list-style-type: none"> • Adjusts the sound volume. | <p>7 [▲ TILT]</p> <ul style="list-style-type: none"> • Adjusts the monitor position. • Opens/closes the panel. • Ejects the disc. |
| <p>3 [DIMMER]</p> <ul style="list-style-type: none"> • The screen brightness is toggled between the set level and maximum luminance. | |
| <p>4 [SRC/PWR]</p> <ul style="list-style-type: none"> • Switches on/off the power. • Changes the modes such as sound and picture. | |
| <p>5 [MAP]</p> <ul style="list-style-type: none"> • Switches navigation mode on and off. (available in the future) | |

Note:

- This button is available only when the Panasonic Car Navigation System (available in the future) is connected to the RGB connector of this unit.



(Panel Open)

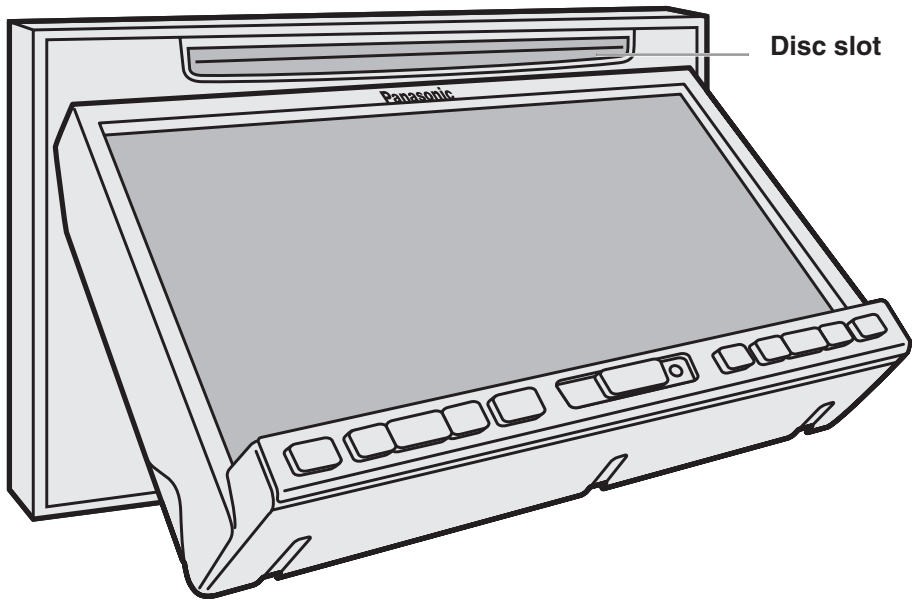

Touch Panel Operation Overview

Notes on the Touch Panel

Before operation

- Clean the surface of the touch panel. (→ page 41)

Operation

- Use only your fingers to operate the touch panel.
- Do not press the panel forcefully.
- Do not scratch the panel with fingernails or any hard objects.

- Do not use a pen or other sharp implements to operate the touch panel.
- Do not bump the front panel.
 - Failure to observe the above may damage or break the glass on the surface of the touch panel.

The State of Operation Screen

Example: DVD mode

Note:

- The following picture is partly darkened for explanation.
- Displaying contents and their positions partly vary with each mode. Refer to the description of each mode for details.

Aspect Button (→ page 32) (only for video source)

Screen Button (→ page 32) (only for video source)

Sound Button (→ page 33)

Source Button (Content varies with each source)

Setup Button

Prohibition (No input symbol) Input is not possible because the user has attempted to perform an operation which is not supported by the disc contents.

Clock time (→ page 30)

Disc indicator (→ page 17) (Lights when a disc is loaded)

Displays the Source Selection Screen.

Source Selection Screen

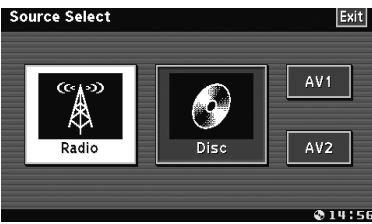

Source Selection Screen appears. Touch desired source button. Touch **Exit** to quit.

Press **[SRC/PWR]** to change to desired source.

Note:

- The screen above appears when no external device is connected to this unit.

Displays the Setup Screen.

Setup Screen

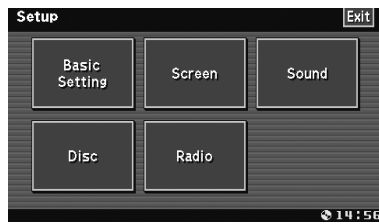

Setup Screen appears. Select desired setting. **Setup menu, (→ page 28)**

Switching the Display

Please refer to the separate "System Upgrade Guidebook" for how to operate this unit when optional devices are connected.

Note:

- Refer to the instructions of each source.
- To switch Operation Screen on, touch the center of touch panel. (Touch **Exit** to cancel)
- If no operation takes place for more than 10 seconds when Operation Screen is ON, Operation Screen is turned off.

Audio Source

CD

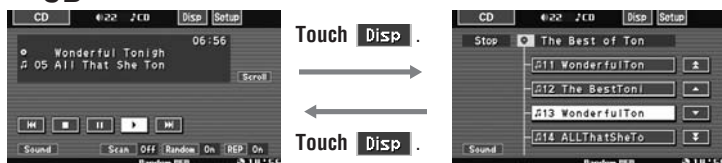

Operation Screen

MP3



Operation Screen 1 (folder/file name)

Operation Screen 2 (ID3 tag)

List Screen

Touch **Disp**.

Video Source

DVD

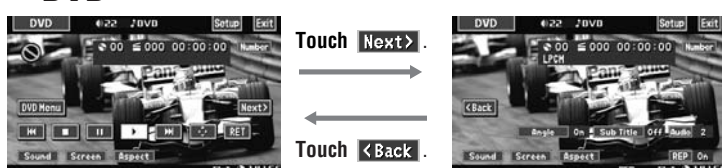

Operation Screen 1

Operation Screen 2

DivX



Operation Screen 1

Operation Screen 2

List Screen

Touch **Disp**.







Preparation: Turn your car's ignition key to the ACC or ON position.

General Operations			
Operations			
Power			
ON :	-	[SRC/PWR]	
Power			
OFF :	-	[SRC/PWR]	
Display Open/Close	-	[▲ TILT]	● Press once to open. Press again to close.
Note:			
● The display automatically closes after a warning alarm sounds if no operation is performed for approximately 30 seconds.			
● When a disc is already loaded, the disc will be ejected.			
Source selection	(⇒ page 12)	[SRC/PWR]	
Note:			
● The sources AV1 and AV2 provide the audio and video from the devices connected to AV1 IN and AV2 IN of this unit respectively, and the source Ext. In provides the audio and video from the device connected to EXT VIDEO IN of this unit via the expansion module (CY-EM100N, option).			
● If there is no external sources connected, AV1/AV2 mode can be set to skip. (⇒ page 31)			
<div style="display: flex; align-items: center;"> <div style="border: 1px solid black; padding: 5px; margin-right: 10px;"> Sources connected to the Expansion Module (CY-EM100N) When the Expansion Module (CY-EM100N, option) is connected. (⇒ System Upgrade Guidebook) </div> <div style="flex-grow: 1;"> <pre> graph TD RADIO[RADIO (AM/FM)] --> DVD[DVD (DVD/VCD (Video CD)/CD/MP3/DivX)] DVD --> AV1[AV1] AV1 --> AV2[AV2] AV2 --> ExtIn[Ext. In] ExtIn --> HUB1[HUB1] HUB1 --> HUB2[HUB2] HUB2 --> HUB3[HUB3] HUB3 --> HUB4[HUB4] </pre> </div> </div>			

..... Touch/Press and hold for more than 2 seconds

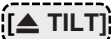

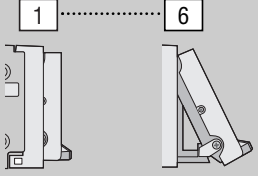





General Operations (continued)

Operations			
Volume Note: <ul style="list-style-type: none"> The sound level for each source is stored in memory. 	-	[+] [-]	Up Down Setting range: 0 to 40, default: 18 Note: <ul style="list-style-type: none"> The volume level can be set independently for each source and each disc format.
Mute	-	[MUTE]	Mutes the sound. To cancel, press again.
Tilt Angle	-		① Press and hold for more than 2 seconds.
	 or 	-	② Touch to adjust. Setting range: 1 to 6 default: 1
<div style="border: 1px solid black; padding: 5px;"> <p>⚠ Warning</p> <ul style="list-style-type: none"> Do not touch the unit while the display is moving. Inserting hands, fingers or foreign objects into the unit can cause injuries and damage to the unit. </div>			
<div style="display: flex; align-items: center;">  <div style="margin-left: 20px;"> <p>Note:</p> <ul style="list-style-type: none"> After adjusting its angle, also adjust the brightness as well. (→ page 32) The car model and installation conditions may impose some restrictions on the adjustment of the monitor's angle. </div> </div>			

Before Disc Playback

Discs that can be Played Back

Disc Type

DISC	DVD	VCD (Video CD)	CD	CD-R/RW
Mark/logo	 	  (IEC62107)	 	 
Disc Size	12 cm			
Video Format	NTSC / PAL			
Audio Format	LPCM, MPEG1, MPEG2, Dolby Digital	LPCM (CD-DA*1), MPEG1, MPEG2 (SVCD)	LPCM (CD-DA*1), MP3	
Region No.	2, 3, 5, ALL*2			

*1 CD-DA : A general music CD format.

Note:

- Only discs with logos shown in the “Mark/logo” row of the table above are playable.
- About CD-Rs and CD-RWs, refer to “Notes on CD-Rs/RWs, DVD-Rs/RWs”. (⇒ page 42)
- Some copy-protected music CDs are not playable.
- Even if you play a dts DVD or a dts CD, analog sound cannot be reproduced.

Notes on DVD-Rs/RWs

- Do not mix DVD-Video formatted data and other formatted data on the same disc.
- **Discs in the video recording (VR) format are unplayable.**
- **Unfinalized discs are unplayable.**
- Use disc-at-once recording for DVD-R DL (double-layer).
- Some discs are unplayable depending on the disc itself, device, drive and software that are used for disc recording.

Discs not supported

The following discs are not played back on this product.



- DVD-Audio
- DVD-ROM
- DVD-RAM
- DVD+R
- DVD+RW
- VSD
- CVD
- CD-G
- CD-ROM (except MP3)
- CD-RW (except MP3/DivX and CD-DA)
- CD-R (except MP3/DivX and CD-DA)
- SACD
- Photo CD
- CDV
- Hybrid SACD (except CD-DA)
- CD-EXTRA (audio-only playback possible)
- DVDs with a region number other than “2”, “3”, “5” or “ALL”*2
- **Playing back a photo CD disc with this unit could damage the data that is recorded on the disc.**

About DivX

- DivX files recorded on CD-Rs/RWs and DVD-Rs/RWs are playable. Refer to “Notes on MP3/DivX” for further information. (⇒ page 22)



Symbols used on jackets

(Examples of such symbols include)

-  : Number of subtitle languages
-  : Number of audio tracks
-  : Number of angles

The numbers indicate the number of languages, tracks, angles, etc., recorded on the disc.

Screen size (H:V aspect ratio)

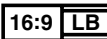
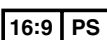
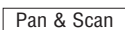
-  : 4:3 standard size
-  : Letterbox (⇒ page 34)
- 16:9 wide size
-  : Playback in letterbox format on a standard screen (4:3).
-  : Playback in  (pan and scan) (⇒ page 34) format on a standard screen (4:3).

Note:

- The size of the image that is displayed on the screen depends on the screen mode ( ⇒ page 32), and on the screen size for the content on the disc.

Region Management Information

This product is designed and manufactured to respond to the Region Management Information that is recorded on a DVD disc. If the Region number described on the DVD disc does not correspond to the Region number of this product, this product does not play the disc.

*2The Region number for this product is “2” (for CQ-VW100W2), “3” (for CQ-VW100W3), “5” (for CQ-VW100W5) or “ALL”.

Example:



Disc Insert/Eject



[▲ TILT] (eject)

⚠ Warning

- Do not touch the unit while the display is moving. Inserting hands, fingers or foreign objects into the unit can cause injuries and damage to the unit.

Disc Insert

Press [▲ TILT] to open the display.

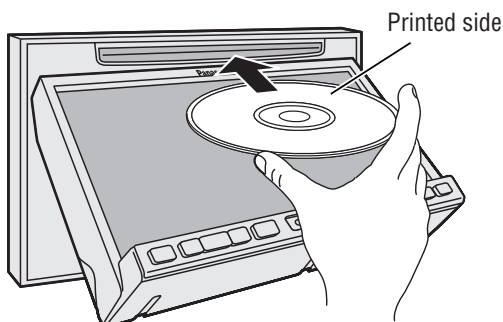

- The mode that supports the disc is selected, and playback starts.

⚠ Caution

- When the disc is inserted or ejected, to prevent disc scratches never exert any downward force on the disc.

- The audio format is automatically identified. (→ page 16)
- When the menu screen appears, see “Chapter/title Selection” on page 20.

When a disc is in the player, change to disc player mode (CD, MP3, DivX, DVD or VCD (Video CD)) and playback starts.

- The sound may be interrupted for a few moments while the audio format is being identified.

⚠ Caution

- Do not use irregularly shaped discs.
- Do not insert foreign object into the disc slot.
- This unit does not support 8-cm disc. In case of load such a disc, eject and remove the disc from the slot immediately.**

Disc Eject

Press [▲ TILT] to stop playback and eject the disc. (Press [▲ TILT] again to reload the disc.)

Note:

- If you leave a disc in the slot for more than 30 seconds after its ejection, the disc will be automatically reloaded after loud beep is energized three times.

- Due to limitations of certain discs, some DVD and VCD (Video CD) discs may not operate as described in this manual. Refer to the disc jacket for further details.
- This unit does not support DVD and VCD (Video CD) karaoke functions.

Disc Player

Source Selection

① Touch "Source Button".



② Touch (Disc) on the Source Selection Screen.

Press [SRC/PWR] to change to the desired mode.

To switch Operation Screen ON, touch the center of touch panel.

Source Button

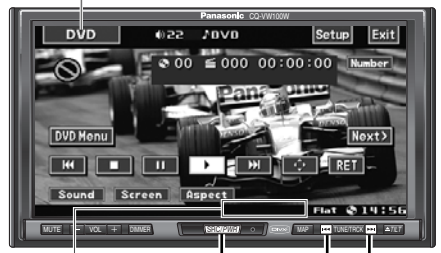

[SRC/PWR] [◀▶]

Repeat/random indicator

Video Mode Display

DVD



Operation Buttons

VCD (Video CD)



Operation Buttons

DivX



Operation Buttons

Audio Mode Display

MP3



Operation Buttons

Note:
• Touch **Disp** to change the display. (→ page 13)

List (Folder/File/Track) Selection



(Example: MP3 mode)

- : Folder
- : MP3/DivX file



- ① Touch **The Best of Ton** (folder name) to select a folder.
 , : scrolls up/down the file list by 1 page.
 , : scrolls up/down the file list by 1 line.
- ② Touch **11 WonderfulTon** (file name) to play.







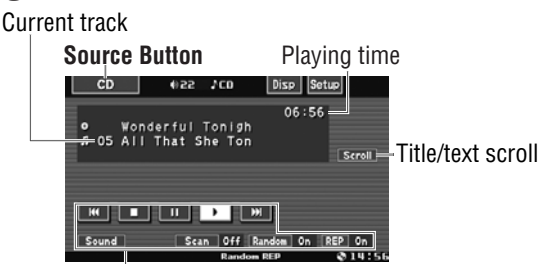













































Note:

- [◀▶] and [▶▶] of the main unit can scroll up and down the file list by 1 page, respectively, too.
- It is not possible to display the whole tree and file list in a folder.
- The displayed contents on the touch panel vary with circumstances.

CD



Operation Buttons

Basic Operations				
Operations	Compatible Discs	Operations		
				
Track/file Selection	  			Next track/file
				Beginning of the current track/file Previous track/file (Touch/press twice.)
		Note: ● When playing a DVD, there are cases where it is not possible to return to the start of a chapter that spans 2 titles.		
Fast Forward/ Fast Reverse	  	 	 	Fast forward Release to resume playback. Fast reverse Release to resume playback.
		The speeds of fast forward and fast reverse change incrementally in 4 steps every time the corresponding button is pressed.		
Folder Selection		 	-	Next folder Previous folder
			-	Scrolls the title/text once
Stop	  		-	To resume playback, touch  .
Pause	  		-	To resume playback, touch again or touch  .
Slow Playback	 	 	 	● Touch/press and hold in the pause mode. Playback is at about 1/3 normal speed. To resume normal playback, touch  .
		Note: ● Reverse slow playback is not possible.		
Repeat Play	  		-	To cancel, touch again.
Repeat Play within the Current Folder			-	To cancel, touch and hold for more than 2 seconds again.
Scan Play			-	To cancel, touch again.
Random Play	 		-	To cancel, touch again.
Random Play within the Current Folder			-	To cancel, touch and hold again.













 Touch/Press and hold

* Touch panel symbols will change to indicate these current mode. **Random Folder**, **REP Folder**

Disc Player (continued)

To switch Operation Screen ON, touch the center of touch panel.

Chapter/title Selection

Operations	Compatible Discs	Operations		
				
Showing menu and selecting an item <div style="border: 1px solid black; padding: 5px; margin: 5px 0;"> *1 Note on VCD: For VCD, touch RET instead of DVD Menu. </div>	  *1	DVD Menu OR RET *1 ↓    	—	1 Menu appears. ↓ 2 Select the desired item. (Touch  when the direction buttons shown at left are not displayed.) ↓ 3 Determine the setting.
		Enter *2 —	—	—
		Move —	—	Toggles the position of the buttons on the screen between upper and lower.
	OSD —	—	—	Returns to the previous display.
Starting Playback from a specific chapter/title Touch the numerical key to enter a number directly 	 	Number ↓ 0 to 9 ↓ Enter	—	1 Toggles “Chapter number input mode”, “Title number input mode” and “Number input mode”. ↓ 2 Input desired number. ↓ 3 Playback starts.
		Note: ● For retrying selection during number entry, touch Clear .	—	—

Note:

- If no operation is performed for 8 seconds after you have touched **Number**, the operation buttons disappear.
- If the title/chapter number is inputted and no operation is performed for 8 seconds, playback will start from the number of the title/chapter entered.

***2 On-Screen Direct Operation (Only for DVD)**

Some DVDs allow you to operate the DVD menu by touching the screen.



DVD mode display

Chapter/title selection
Fast forward/fast reverse

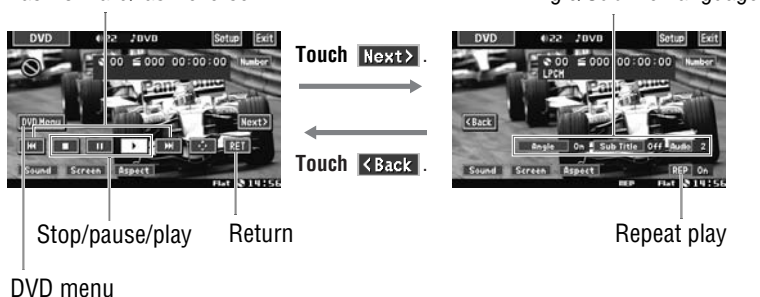

Useful Function

Operations	Compatible Discs	Operations		
Subtitle Language	 	Sub Title Off	—	<ul style="list-style-type: none"> ● Touch during playback. <p>It is possible to change the subtitle language during play if multiple languages are recorded on the disc.</p> <p>Note:</p> <ul style="list-style-type: none"> ● There may be a brief delay before the subtitles appear.
Audio Language	 	Audio 2	—	<ul style="list-style-type: none"> ● Touch during playback. <p>It is possible to change the audio language during play if multiple audio languages are recorded on the disc.</p>
Angle		Angle 2	—	<ul style="list-style-type: none"> ● Touch during playback. <p>For DVDs which contain scenes which have been shot simultaneously from a number of different angles the same scene can be viewed from each of these different angles during play. (Angle Mark → page 34)</p>
Stereo & Monaural		Audio L-ch	—	<p>It is possible to switch the audio between stereo sound and monaural sound (L or R).</p> <div style="border: 1px solid black; padding: 5px;"> <pre> graph TD ST[ST] --> Lch[L-ch] Lch --> Rch[R-ch] </pre> <p>ST : stereo sound</p> <p>L-ch : the left channel audio is output on both the left and right speakers.</p> <p>R-ch : the right channel audio is output on both the left and right speakers.</p> </div>

Note:

- If no operation is performed for 10 seconds or **Exit** is touched, the operation buttons disappear.
- It may not be possible to switch the language unless the unit is at the DVD menu (⇒ previous page) or is at the DVD settings. (⇒ page 34)
- The language on the DVD settings takes priority when the power is turned on or the disc is loaded.
- The number of languages and angles depend on the disc. Some discs have only one language/angle or have no language/angle.

Notes on MP3/DivX

What is MP3/DivX?

MP3*: MP3 (MPEG Audio Layer-3) is the compression format of digital audio. It is developed by MPEG (Motion Picture Experts Group). Using this compression format, you can record the contents of about 10 music CDs on a single CD (This figure refers to data recorded on a 650 MB CD-R or CD-RW at a fixed bit rate of 128 kbps and a sampling frequency of 44.1 kHz).

*MPEG Layer-3 audio coding technology licensed from Fraunhofer IIS and Thomson.

DivX: The video compression format developed by DivX, Inc. compresses video files without any considerable loss of video quality.

Note:

- MP3/DivX encoding and CD writing software programs are not supplied with this unit.

Points to remember when making MP3/DivX files

Common

- High bit rate and high sampling frequency are recommended for high quality sound.
- Selecting VBR (Variable Bit Rate) is not recommended because playing time is not displayed properly and sound may be skipped.
- The playback sound quality differs depending on the encoding circumstances. For details, refer to the instructions of your own encoding software and writing software.

MP3

- It is recommended to set the bit rate to “128 kbps or more” and “fixed”.

DivX

- DivX files greater than 2GB or having no index may not play properly on this unit.
- This unit supports all resolutions up to maximum of 720 x 480 (NTSC)/720 x 576 (PAL).
- You can select up to 8 types of audios and subtitles on this unit.
- GMC (Global Motion Compensation) is not supported.

Caution

- Put only “.mp3” files on an MP3-formatted disc. Put only “.DIVX”, “.divx”, “.AVI” and “.avi” files on an DivX-formatted disc. Otherwise, abnormal sound may be produced during play which can damage the speaker and your hearing.

Display Information (on the Main Unit)

Displayed items

- | | |
|-------------------|------------------------|
| ● CD-TEXT | ● MP3 (ID3 tag) |
| Disc title | Album name |
| Track title | Title and artist name |
| ● MP3/DivX | |
| Folder name | |
| File name | |

Displayable characters

- Displayable length of file name/folder name: within 64 characters. (Unicoded file and folder names are reduced by half in the number of displayable characters.)
- Name files and folders in accordance with the standard of each file system. Refer to the instructions of writing software for details.
- ASCII character set can be displayed.
- Some Cyrillic characters in the Unicode can be displayed.

ASCII character set

A to Z, a to z, digits 0 to 9, and the following symbols:

(space) ! " # \$ % & ' () * + , - . / : ; < = > ? @ [\] ^ _ ` { | } ~

Note:

- With some software in which MP3/DivX format files have been encoded, the character information may not be displayed properly.
- Undisplayable characters and symbols will be converted into an asterisk (*).
- It is recommended that the length of the file name is less than 8 (excluding the file extension).

Recording MP3/DivX files on a CD/DVD-media

- It is recommended not to use a disc holding two or more different format types of files.
- If CD-DA files are on the same disc as MP3 or DivX files, the songs and the movies may not play in the intended order, or some songs or movies may not play at all.
- When storing MP3 data and DivX data on the same disc, use different folders for each data.
- Do not record files other than MP3/DivX files and unnecessary folder on a disc.
- The name of an MP3/DivX file should be added by rules as shown in the following descriptions and also comply with the rules of each file system.
- The file extension “.mp3” should be assigned to MP3 files.
- The file extension “.DIVX”, “.divx”, “.AVI” or “.avi” should be assigned to DivX files.
- You may encounter trouble in playing MP3/DivX files or displaying the information of MP3/DivX files recorded with certain writing software or CD/DVD recorders.
- This unit does not have a play list function.
- Although Multi-session recording is supported, the use of Disc-at-Once is recommended.

Supported file systems

ISO 9660 Level 1/Level 2, Apple Extension to ISO 9660, Joliet, Romeo

Note:

- Apple HFS, UDF 1.50, Mix CD and CD Extra are not supported.

Audio compression formats (Recommendation: “Points to remember when making MP3/DivX files” on the previous page)

Compression method	Bit rate	VBR	Sampling frequency
MPEG 1 audio layer 3 (MP3)	32 k – 320 kbps	Yes	32, 44.1, 48 kHz
MPEG 2 audio layer 3 (MP3)	8 k – 160 kbps	Yes	16, 22.05, 24 kHz
DivX data created using ver.3.11, 4.x, 5.x*	8 k – 320 kbps	Yes	8 k – 48 kHz

* DivX video system/MP2, MP3

Note:

- VBR is not recommended.

Folder selection order/file playback order

Maximum number of files/folders

- Maximum number of files: 999
- Maximum number of files in one folder: 999
- Maximum depth of trees: 8
- Maximum number of folders: 255 (Root folder is included.)

Note:

- You can shorten the duration between data read and playback by decreasing the quantity of files or folders, or the depth of the hierarchy.
- This unit counts the number of folders irrespective of the presence or absence of an MP3/DivX file.
- If the selected folder does not contain any MP3/DivX files, the nearest MP3/DivX files in the order of playback will be played.
- Playback order may be different from other MP3/DivX players even if the same disc is used.
- “ROOT” appears when displaying the root folder name.

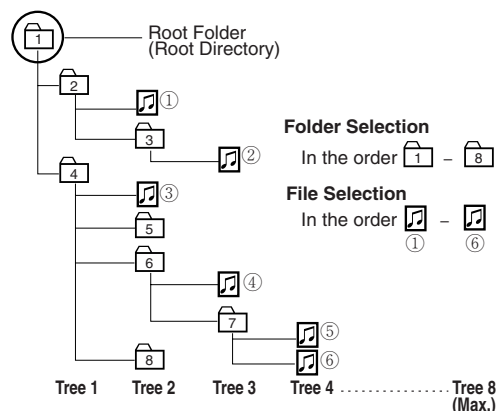

Copyright

It is prohibited by copyright laws to copy, distribute and deliver copyrighted materials such as music without the approval of copyright holder except enjoying yourself personally.

No warranty

The above description complies with our investigations as of December 2007. It has no warranty for reproducibility and displayability of MP3/DivX.

Radio

Source Selection

1 Touch "Source Button".

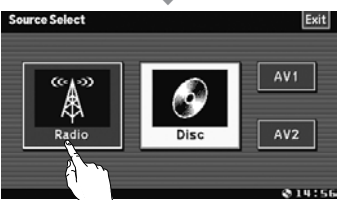

2 Touch **Radio** on the Source Selection Screen.

Press **[SRC/PWR]** to change to the desired mode.

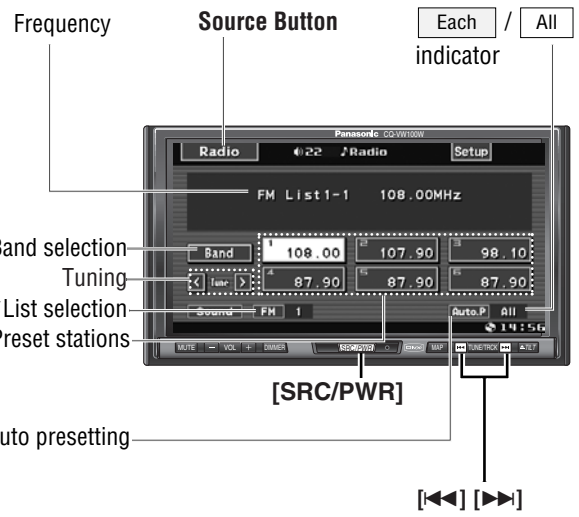

* Appears only when **All** is selected. (→ page 35)
 Setup ⇨ Radio ⇨ FM Setup ⇨ Auto Preset ⇨ Each / All

Tuning

Operations			
Band Selection	Band	-	
	Each	FM 1 → FM 2 → FM 3 → AM	
List Selection	Preparation: Select All . (→ page 35)		
	Setup ⇨ Radio ⇨ FM Setup ⇨ Auto Preset ⇨ Each / All		
Station Selection	FM 1	-	
	FM 1 (list 1) → FM 2 (list 2) → FM 3 (list 3)		
Seek Tuning			Up
			Down

There are 6 stations in each list. You can call up next 6 stations by switching from one list to another.

Touch/press and hold for more than 0.5 second then release. Seeking starts.

..... Touch/press and hold

Preset Memory

Manual Preset Memory

Up to 6 stations can be preset in each band.

Select a band and frequency.



blinks once

- Touch and hold for more than 2 seconds.
- The frequency blinks once, and a receiving station is saved in the memory. New stations overwrite existing saved stations.

Auto Preset Memory

A Each

Six stations are automatically preset in each band.

Preparation: Select **Each**. (→ page 35) (default: **Each**)

Setup ⇨ Radio ⇨ FM Setup ⇨ Auto Preset ⇨ **Each** / **All**

Select a band.

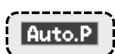

6 stations with first to 6th highest in signal strength of each band will be preset.

- Touch and hold for more than 2 seconds.
- Once set, the preset stations are sequentially scanned for 5 seconds each. (scanning) New stations overwrite existing saved stations.

B All

In total 18 FM stations are automatically preset.

Preparation: Select **All**. (→ page 35)

Setup ⇨ Radio ⇨ FM Setup ⇨ Auto Preset ⇨ **Each** / **All**



18 stations with first to 18th highest in signal strength of all FMs will be preset at once.

- Touch and hold for more than 2 seconds.
- Once set, the preset stations are sequentially scanned for 5 seconds each. (scanning) New stations overwrite existing saved stations.

Preset Station Calling

Select a band or a list.

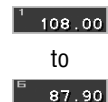

- Touch desired preset button.

Preset Swap

A station preset is interchangeable with another station preset.

Preparation: Select **All**. (→ page 35)

Setup ⇨ Radio ⇨ FM Setup ⇨ Auto Preset ⇨ **Each** / **All**

- 1 Select the list and the preset number that contains the station to be interchanged (see "Preset station calling" above).
- 2 Select the list and hold down the preset number that contains the targeted channel for more than 2 seconds.

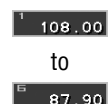

The preset station selected in the step 1 is interchanged with the targeted preset channel selected in the step 2 (Preset Swap).

 Touch and hold

AV1/AV2

Preparation:

- Connect an optional external device to the AV1/AV2.

Source Selection

25

You can view the images and listen to the sounds from the connected external devices in the AV1/AV2 mode respectively.

- 1 Touch "Source Button".

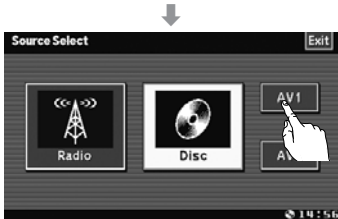

- 2 Touch **AV1 / AV2** on the Source Selection Screen.



Press **[SRC/PWR]** to change to the desired mode.

To switch Operation Screen ON, touch the center of touch panel.

Note:

- You can set up the system so that the AV mode is not selected (source skip). (→ page 31)
- If no operation is performed for 10 seconds or **Exit** is touched, the operation buttons disappear.

Source Button



[SRC/PWR]

Settings

Basic Setting

Clock
ID-Code
Input
Memory Clear
Other

Basic Setting

Clock setting (→ page 30)
ID Code Setting (→ page 30)
Input Selection (→ page 31)
Memory clearance (→ page 31)
Other settings (→ page 31)

Screen

Dimmer
Display
Aspect

Screen

Adjusting the brightness (→ page 32)
Display appearance (→ page 32)
Display aspect setting (→ page 32)

Sound

SQ3
Bass/Treble
Balance/Fader

Sound

SQ3 setting (→ page 33)
Bass/treble adjustment (→ page 33)
Balance/fader adjustment (→ page 33)

Disc

Audio Language
Subtitle Language
Menu Language
Video Setting
Audio Setting
DivX Registration

Disc

DVD Audio Language Setting (→ page 34)
DVD Subtitle Language Setting (→ page 34)
DVD Menu Language Setting (→ page 34)
DVD Video Setting (→ page 34)
DVD Audio Setting (→ page 35)
DivX Registration (→ page 35)

Radio

FM Setup

Radio

Setting for FM stations (→ page 35)

□ Setup Operation

(Example: DVD mode)

1



Touch **Setup** in Operation Screen.

2

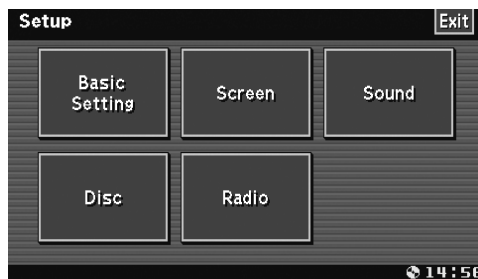

Touch desired setting.

3

(Example: setting screen of **Input** → page 31)

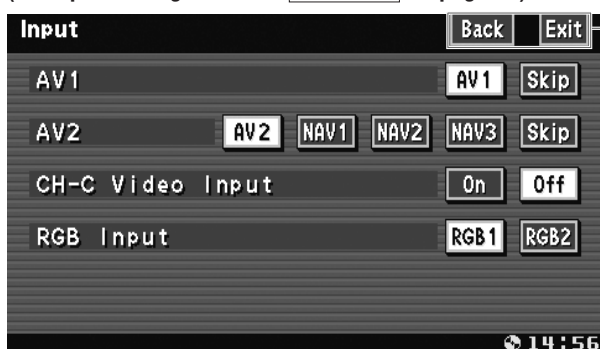

Back

Determines the setting and goes back to the previous menu out of the menu.

Exit

Determines the setting and gets out of the menu

Note:

- The display returns to the previous status if there is no operation for more than 60 seconds after changing to the setting menu.
- The item may not be temporarily selected depending on the current disc type or the state of this unit. In such a case, change the source to another one and try to set up the item again.



[DIMMER]

(The screen brightness is toggled between the set level and maximum luminance.)

[SRC/PWR]

(Exit from the menu)

Settings (continued)

Basic Setting

Screen

Sound

Disc

Radio

Clock

Clock setting

Display

(Clock display)

On

: clock display ON (“-:-:-” is displayed before adjusting the clock.)

Off

: clock display OFF

default: Off

Adjust

(Clock adjustment)

^

: Forward

v

: Backward

Note:

- To start the clock, touch/press **Start** / **Exit** / **[SRC/PWR]**.
- Set the Daylight Saving Time manually.

default: Hour Adjust: 0
Minute Adjust: 0

ID-Code

ID Code Setting

Prior to operating this unit, it is advisable to assign a 4-digit ID code for security. Once the ID code has been set, the unit cannot be operated if the main power supply is disconnected then re-connected. It is electronically locked so that a thief cannot use the stolen unit unless that person knows the code you have set.

The ID code operation must be performed only by the person to whom the unit belongs.

Generally, it is not necessary to enter the ID code each time when using the unit if it has not been disconnected from the main power supply (car battery).

0 to **9** 4 digits numeric code

default: none

How to set your ID code (for the first time)

- ① Enter an 4 digit ID code.
- ② Enter the same 4 digit ID code again.

How to change your ID code

- ① Enter the preset (old) 4 digit ID code. If the wrong ID code is entered, a new ID code cannot be registered.
- ② Enter a new 4 digit ID code.
- ③ Enter the new 4 digit ID code again.

How to cancel the known ID code

- ① Enter the preset (old) 4 digit ID code. If the wrong ID code is entered, it is not possible to cancel the ID code function.
- ② Touch and hold **Off** until “Completed!” is displayed. The ID code cancelling procedure is completed. The unit now works without an ID code.

Note:

- Should your unit ever require service, cancel your ID code before sending for repair.
- The ID code setting cannot be eliminated even by the memory clear function.
- The inputted code is not displayed for your security.

⚠ Caution

- **Record your registered ID code and keep it in a secure location. (Fill in the ID code memo (⇒ page 40).) If you forget it, you will be unable to use the unit. In case you forget the ID code, please consult your nearest Panasonic Service Center.**

Input

Input selection

Note:

- If a non-Panasonic navigation system is connected to this unit, we do not guarantee the operations of the navigation system.

AV1

(AV1 input selection)

AV1

: an external device is connected to AV1.

Skip

: skips AV1.

default:

AV2

(AV2 input selection)

AV2

: an external device is connected to AV2.

NAV1-3

: Select one from among NAV1, NAV2, and NAV3 with which images are displayed most beautifully when a non-Panasonic car navigation system is connected.

Skip

: skips AV2.

default:

CH-C Video Input

(⇒ System Upgrade Guidebook)

RGB Input

(RGB input selection)

RGB1/2

: Select one between RGB1 and RGB2 with which images are displayed most regularly when a car navigation system is connected via RGB connector.

default:

Ext. In

(⇒ System Upgrade Guidebook)

Memory Clear

Memory clearance

The state of all of the current memories are returned to default settings.

Note:

- The ID code is not deleted by executing memory clear.

Yes

: clears the memory to default settings

No

: no memory clear.

The display returns to the previous one.

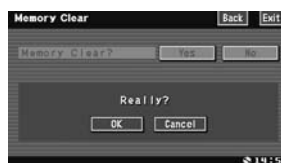

appears when is selected.

OK

: proceed.

Cancel

: no memory clear.

⚠ Caution

- Be aware that this setting restores the unit to default settings, so that all the memories and settings that you have set will be eliminated.

Other

Other settings

ACC Select

(Setting ACC selection ON and OFF)

On

: sets to ON if your car has ACC position.

Off

: sets to OFF if your car has no ACC position.

default:

Note:

- For an ACC-equipped car, select ON. The following functions are available.
 - The power is turned on automatically when inserting a disc or magazine.
 - selection disables turning on the power of the main unit through the remote control.

⚠ Caution

- Be sure to select off when your car has no ACC position in the ignition switch. Failure to do this could cause the battery to go dead.

Settings (continued)

Basic Setting **Screen** (Display) Sound Disc Radio

Note:
 • The screen setting screen can be also activated by touching **Screen** when the button is displayed. (→ page 12)

Dimmer

Adjusting the brightness

1 2 3
 ←————→
 Darker Brighter

default: 1

Note:
 • When **[DIMMER]** is pressed, the screen brightness is toggled between the set level that is adjusted by the procedure above and the maximum luminance.

Display

Display appearance

Contrast (Adjust the image contrast)

< : decreases the contrast between black and white.
 > : increases the contrast between black and white.

Bright (Adjust the image brightness)

< : darkens.
 > : lightens.

Color (Adjust the image color depth)

< : lightens the depth of color on the display.
 > : deepens the depth of color on the display.

Tint (Adjust the image tone or tint)

< : emphasizes green in the color image.
 > : emphasizes red in the color image.

Note:
 • When the video signal is PAL/SECAM format, adjustment cannot be performed.

Setting range: -15 to +15
 default: ±0

Aspect

Display aspect setting

Normal

- The conventional display image has a 4 to 3 ratio of horizontal to vertical.
- In this case, a blank area remains on the right and left sides of the display.

Full

- The screen is extended horizontally as a whole to the aspect ratio of 16 to 9.
- The extension ratio is the same at any point of the screen.

Zoom

- The screen is fully extended at the normal aspect ratio of 4 to 3.
- The top and bottom of the screen are slightly cut.

Just

- The screen is extended horizontally to the aspect ratio of 16 to 9.
- The extension ratio increases toward the right and left ends of the screen.

default: Normal

Note:

- The aspect setting screen can be also activated by touching **Aspect** when the button is displayed. (→ page 12)
- This adjustment is common to video mode.
- You cannot change the aspect in the menu screen and a screen in the CD, MP3 and radio mode. These are fixed to "Full".
- When the rear view camera is in operation with the transmission gear shift in the reverse position, the image is shown on the "Full" screen only.
- In some cases, the picture looks different from the original one due to your selection of aspect.

Caution

- This is to remind you that compression or extension of the screen using the aspect ratio (screen mode) changing function of this product for commercial purpose of profit making or viewing/listening by the public could infringe on the rights of the author protected by the copyright law.
- If you expand normal picture (4 to 3) by using "Just", "Zoom" or "Full" aspect to the full of the screen, you might not see the periphery of the picture, or you might see a distorted picture. Therefore, use the "Normal" mode to see the original picture as the author intended it.

Basic Setting | Screen | **Sound** | Disc | Radio

Note:

- The sound setting screen can be also activated by touching **Sound** when the button is displayed. (⇒ page 12)

SQ3

SQ3 setting

Six SQ presets are already provided at shipment in this unit.

Flat : flat frequency response

Pop : wide-ranged and deep sound

Rock : speedy and heavy sound

Jazz : jazz-specific deep sound

Club : club and disco-specific sound

Vocal : clear sound

default: **Flat**

You may set your own SQ or modify factory presets in each memories by following the instructions below:

Adjusting level of each preset

- 1 Select the preset SQ that you prefer to adjust.
- 2 Touch **<** or **>** to select a frequency in a frequency band (BASS/MID/TRE).
- 3 Touch **^** or **v** to adjust each frequency.

Adjustable range: -12 dB to +12 dB

Adjustable frequency:

BASS; 60 Hz, 80 Hz, 100 Hz, 200 Hz

MID; 500 Hz, 1 kHz, 2 kHz, 3 kHz

TRE; 10 kHz, 12 kHz, 15 kHz, 18 kHz

Note:

- The new level adjustment will overwrite the previous level adjustment.
- For resuming the factory settings, touch and hold **Default** for more than 2 seconds.

Bass/Treble

Bass/treble adjustment

Bass (Bass adjustment)

> : more

< : less

Treble (Treble adjustment)

> : more

< : less

Setting range: -12 dB to +12 dB
default: 0 dB

Balance/Fader

Balance/fader adjustment

Balance (Sound level adjustment between right and left speakers)

> : right enhanced

< : left enhanced

Setting range: Right 15 to Left 15
default: 0

Fader (Sound level adjustment between front and rear speakers)

> : front enhanced

< : rear enhanced

Setting range: Front 15 to Rear 15
default: 0

Settings (continued)



- Basic Setting
- Screen
- Sound
- Disc**
- Radio

Audio Language

33

DVD audio language setting

Note:

- These adjustments being executed, playback will start from the beginning of a disc.

- : English
 - : Chinese
 - : French
 - : other language. Input the language code. (→ page 43)
- default:

Subtitle Language

DVD subtitle language setting

Note:

- A disc supporting closed captioning and subtitles may overlap each other on the screen. In this case, turn the subtitle off.

- : English
 - : Chinese
 - : French
 - : other language. Input the language code. (→ page 43)
- default:

Menu Language

DVD menu language setting

- : English
 - : Chinese
 - : French
 - : other language. Input the language code. (→ page 43)
- default:

Video Setting

Display aspect and DVD software mode

- (Display aspect setting)
- : plays a video in 4:3 screen.
 - : plays a video in wide screen (16:9).
- default:

(DVD software mode)

- : plays wide-screen video in Pan & Scan mode (in which the left and right edges of the screen are cut off).
 - : plays wide-screen video in letterbox mode (in which black bands appear at the top and bottom of the screen).
- default:

Note:

- This function is available only when is set to .
- Set the software setting according to the symbol used on jacket. (→ page 16)
- DVD software mode setting is ignored if or is already set in the software.
- Screen aspect of the display unit is changed according to the aspect ratio setting (→ page 32) and DVD software's aspect.

(VIDEO OUT terminal setting)

- : sets PAL in accordance with the equipment connected to VIDEO OUT.
 - : sets NTSC in accordance with the equipment connected to VIDEO OUT.
- default:

(Angle mark setting)

The angle mark is displayed to indicate the parts where multi-angle data is recorded.

- : activates angle mark.
 - : inactivates angle mark.
- default:

Audio Setting

Audio setting at DVD playing

Down Mix (Down mix setting)

Lt/Rt : surround element decodable down mix
(Lt = Left total, Rt = Right total)

Lo/Ro : simple stereo down mix
(Lo = Left only, Ro = Right only)

Note:

- This function is available only when “Dolby Digital” source is playing.

default:

DR COMP (Dynamic Range Compression setting)

STD : DR COMP ON

MIN : made with the greatest compression,
roughly equivalent to a TV broadcast.

Off : DR COMP OFF

Note:

- This function is available only when “Dolby Digital” source is playing.

default:

DivX Registration

Show the DivX Registration Code (⇒ page 36)



Basic Setting

Screen

Sound

Disc

Radio

FM Setup

Setting for FM stations

Auto Preset (Auto preset setting)

Each : saves the preset stations in each band.

All : saves the preset stations in all FM lists
regardless of band.

default:

About DivX VOD Content



DivX Video-on-Demand (VOD) content is encrypted for copyright protection. In order to play DivX VOD content on this unit, you first need to register the unit.

Follow the on line instructions for purchasing DivX VOD content to enter the unit's registration code and register the unit. For more information about DivX VOD, visit www.divx.com/vod.

Display the unit's registration code

- ① Touch **Setup**.
- ② Touch **Disc**.
- ② Touch **DivX Registration**.



8 alphanumeric characters

Note:

- We recommend that you make a note of this code for future reference.
- After playing DivX VOD content for the first time, another registration code is then displayed in "DivX Registration". Do not use this registration code to purchase DivX VOD content. If you use this code to purchase DivX VOD content, and then play the content on this unit, you will no longer be able to play any content that you purchased using the previous code.
- If you purchase DivX VOD content using a registration code different from this unit's code, you will not be able to play this content. ("Authorization Error" is displayed.)

Regarding DivX content that can only be played a set number of times

Some DivX VOD content can only be played a set number of times. When you play this content, the remaining number of plays is displayed. You cannot play this content when the number of remaining plays is zero.

("Rental Expired" is displayed.)

When playing this content

- The number of remaining plays is reduced by one if
 - you press **[SRC/PWR]**.
 - you press **[◀◀] / [▶▶]** (**◀◀ / ▶▶**) etc. and arrive at another content or the start of the content being played.

Troubleshooting



□ If You Suspect Something Wrong

Check and take steps as described below.

If the described suggestions do not solve the problem, it is recommended to take the unit to your nearest authorized Panasonic Service Center. The product should be serviced only by qualified personnel. Please refer checking and repair to professionals. Panasonic shall not be liable for any accidents arising out of neglect of checking the unit or your own repair after your checking. **Never take measures especially those other than indicated by *italic* letters in "Possible Solution" described below because those are too dangerous for users to handle themselves.**

⚠ Warning

- Do not use the unit in an irregular condition, for example, without sound, or with smoke or a foul smell, which can cause ignition or electric shock. Immediately stop using the unit and consult your dealer.
- Never try to repair the unit by yourself because it is dangerous to do so.

■ Common

Problem	Possible cause → Possible solution
No power to the unit	The power cord (battery, power and ground) is connected in the wrong way. → Check the wiring.
	Fuse blows out. → Eliminate the cause of fuse blowout and replace the fuse with new one. Consult your dealer.
Sound is not generated.	MUTE is set to ON. → Set MUTE to OFF.
	The wiring of speaker lines is not correct, or a break or poor contact arises. → Check the wiring in accordance with the wiring diagram. (Installation Instructions)
Noise	There is an electromagnetic-wave generator such as a cellular phone near the unit or its electrical lines. → Keep the electromagnetic-wave generator such as a cellular phone away from the unit and the wiring of the unit. In case noise cannot be eliminated due to the wiring harness of the car, consult your dealer.
	The contact of the ground lead is poor. → Make sure that the ground lead is connected to an unpainted part of the chassis securely.
Noise is made in step with engine revolutions.	Alternator noise comes from the car. → Change the wiring position of the ground lead. → Mount a noise filter.
Some operations are not executable.	Some operations are not executable in particular modes such as menu mode. → Read the operating instructions carefully and cancel the mode. If the unit is still out of order, consult your dealer.
No sound from speaker(s)	There is a break, a short circuit, poor contact or wrong wiring regarding the speaker wiring. → Check the speaker wiring.
The speaker channels are reversed between right and left.	The speaker wiring is reversed between right and left. → Perform the speaker wiring in accordance with the wiring diagram.
The power of the unit fails unintentionally.	The safety device works. → Consult your dealer, or your nearest Panasonic Service Center.

Troubleshooting (continued)

Display Settings

The picture is dark. The picture is whitish. Something is wrong with the picture. The picture is light in color.

The screen is not adjusted properly.
 ➔ **Make every adjustment of the screen.**

Radio

Poor reception or noise

Antenna installation or wiring of antenna cable is faulty.
 ➔ **Check whether the antenna mounting position and its wiring are correct. In addition, check to see whether the antenna ground is securely connected to the chassis.**

No power is supplied to the antenna amplifier (when using a film antenna, etc.).
 ➔ **Check the wiring of the antenna power lead.**

The number of auto preset stations is less than 6.

The number of receivable stations is less than 6.
 ➔ **Move to an area where receivable stations number is maximum, and try pre-setting.**

Preset stations cannot be stored.

The contact of the battery lead is poor, or the battery lead is not always powered.
 ➔ **Make sure that the battery lead is connected securely, and preset stations again.**

CD

No playback or disc ejected

The disc is inserted upside down.
 ➔ **Insert a disc correctly.**

There is a flaw or foreign object on the disc.
 ➔ **Remove the foreign object, or use a flawless disc.**

Sound skipping or noise

There is a flaw or foreign object on the disc.
 ➔ **Remove the foreign object, or use a flawless disc.**

Sound skipping due to vibration

The unit is not sufficiently secured.
 ➔ **Secure the unit to the console box.**

The unit is tilted at over 30° in the front-to-end direction.
 ➔ **Make the angle 30° or less.**

Disc unejectable

Something such as a peeled label obstructs the disc coming out.
 ➔ **Press and hold the [▲ TILT] for more than 10 seconds (disc forced ejection). In case that the disc forced ejection does not work, consult your dealer.**

The microcontroller in the unit operates abnormally due to noise or other factors.
 ➔ **Unplug the power cord and plug it again. In case the unit is still out of order, consult your dealer.**

■ MP3/DivX

<p>No playback or disc ejected</p>	<p>The disc has unplayable formatted data. ➔ Refer to the description about MP3/DivX for playable formats.</p>
<p>The CD-Rs/RWs/DVD-Rs/RWs that are playable on other devices are not playable on this unit.</p>	<p>The playability of some CD-Rs/RWs/DVD-Rs/RWs may depend on the combination of media, recording software and recorder to be used even if these CD-Rs/RWs/DVD-Rs/RWs are playable on other devices such as a PC. ➔ Make CD-Rs/RWs/DVD-Rs/RWs in a different combination of media, recording software and recorder after referring to the description about MP3/DivX.</p>
<p>Sound skipping or noise</p>	<p>There is a flaw or foreign objects on the disc. ➔ Remove the foreign objects, or use a flawless disc. For MP3/DivX, refer to the description about MP3/DivX.</p> <p>Playing VBR (Variable Bit Rate) files may cause sound skipping. ➔ Play Non-VBR files.</p>
<p>The picture stops.</p>	<p>The picture may stop if the DivX files are greater than 2 GB. ➔ Keep the file size under 2 GB.</p>

Note:

- Refer to “Notes on MP3/DivX”. (➔ page 22)

■ DVD



<p>Cannot switch the audio language/subtitle language/angle.</p>	<ul style="list-style-type: none"> • It is not possible to switch if the disc does not have multiple audio languages/subtitle languages/angles recorded on it. (Refer to the guide provided with your disc.) • Some discs permit switching through a menu screen. • Sometimes, switching angles is possible only with certain scenes.
<p>The audio/subtitle language selected in the DVD settings is not used.</p>	<p>If audio or subtitles in that language are not recorded on the disc, the audio or subtitles do not switch to that language. (Some discs permit switching through a menu screen. Refer to the guide provided with your disc.)</p>
<p>A DVD-R or DVD-RW is not playable.</p>	<p>The disc is still unfinalized. ➔ Finalize the disc. Refer to “Before Disc Playback” (➔ page 16) or “Notes on Discs” (➔ page 42) for other cases.</p> <p>The disc is in the video recording (VR) format. ➔ Play video formatted discs. Refer to “Before Disc Playback” (➔ page 16) or “Notes on Discs” (➔ page 42) for other cases.</p>
<p>Sound is not generated.</p>	<p>The audio format is output disabled for this unit such as dts. ➔ Use output enabled discs. Refer to “Before Disc Playback” (➔ page 16) or “Notes on Discs” (➔ page 42) for other cases.</p>

Troubleshooting (continued)

❑ Error Display Messages

■ CD/MP3/DivX/DVD/VCD (Video CD)

39

Display	Possible cause → Possible solution
Non Playable Disc	<p>Disc is dirty, or is upside down. → Check disc.</p> <p>Disc has scratches. → Check disc.</p>
Mechanism error	<p>No operation by some cause. → Press [▲ TILT]. If failure persists, press the reset switch. If normal operation is not restored, call the store where you purchased the unit or the nearest Panasonic Service Center.</p>
File error	<p>The type of the file that is selected is not supported. → Check disc.</p>
No Disc	<p>No disc is in the player. → Insert disc into the disc slot.</p>
Region Code error	<p>The region code of the disc to be used is not compatible with this unit. → Press [▲ TILT] and check the disc.</p>
	<p>You are trying to play the DivX VOD content that was purchased with a different registration code. → Purchase the DivX VOD content with the registration code of this unit. (⇒ page 36)</p>
	<p>The DivX VOD content has no available play count. → Purchase again the content or play another content. (⇒ page 36)</p>

Note:

- There may be cases when the disc numbers affected by an error are displayed before “Non Playable Disc”.

❑ In case you forget the ID code...

In case you forget the ID code, please consult your nearest Panasonic Service Center.

ID code memo

Copy the memo at right, fill in the ID code, and keep it in a secure location.

Model No. CQ-VW100W

ID CODE

❑ Product Servicing

If the suggestions in the charts do not solve the problem, we recommend that you take it to your nearest authorized Panasonic Service Center. The product should be serviced only by a qualified technician.

❑ Replacing the Fuse

Use fuses of the same specified rating (**15 A**). Using different substitutes or fuses with higher rating, or connecting the product directly without a fuse, could cause fire or damage to this unit.

If the replacement fuse fails, contact your nearest Panasonic Service Center for service.

❑ If the Unit Begins to Malfunction...

Reset switch

Insert a hard, slender stick into the hole and push the switch.

Important

Push the switch only when the unit fails to operate with any buttons. (Stored settings and adjustments are not cleared.)

If the unit fails to return to normal condition, call the nearest Panasonic Service Center and ask for repairs.



Reset switch

Note:

- If the ID-CODE has been already set, you will be asked to enter the ID-CODE right after the unit is restarted.

Maintenance

❑ Cleaning this Unit

Your product is designed and manufactured to ensure a minimum of maintenance. Use a dry soft cloth for routine exterior cleaning. Never use benzene, thinner or other solvents.



To remove stubborn stains

- ① Moisten the soft cloth in dishwashing soap diluted with water and wring well.
- ② Wipe lightly. Go over the same surface with a dry cloth.



Note:

- Since there is the possibility of water drops getting inside of the unit, do not directly apply cleanser to the surface.
- Do not scratch the screen with your nails or other hard objects. The resulting scratches or marks will obscure the images.

⚠ Caution

- If water drops or similar wet substances get inside the monitor, it may cause a malfunction.

Notes on Discs



How to hold the disc

- Do not touch the underside of the disc.
- Do not scratch the disc.
- Do not bend disc.
- When not in use, keep disc in the case.

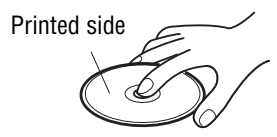

Do not use discs that fit any of the descriptions given below. Using these discs may damage the discs or cause the unit to malfunction.

• Special discs in a shape which is not round



• Partly or wholly transparent disc

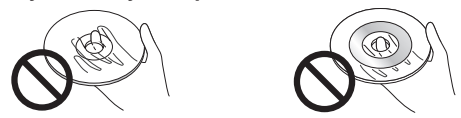

Wholly transparent disc* Partly transparent disc
 *Wholly semi-transparent disc may not be played back.

• Discs with adhered labels, etc. on them



Disc with adhered stickers or tape Labels created by a printer

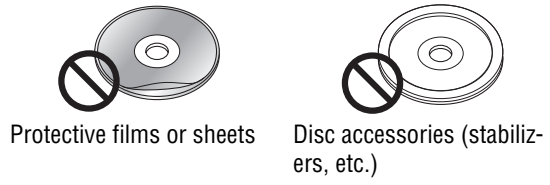

Protective films or sheets Disc accessories (stabilizers, etc.)

• Damaged or deformed discs



Shoddily made discs Discs with cracks, scratches or parts missing



Discs with burrs
 Please remove the burrs before use.

Disc insert

The surfaces of new discs tend to be slippery. Therefore, when using such a disc for the first time, it may not load satisfactorily even when it has been inserted into the unit. At a time like this, insert the disc into the unit as far as it will go until it is loaded properly.

- **When inserting a disc into or ejecting and removing it from the unit, insert it straight in or eject and remove it straight out in parallel with the unit. Otherwise, the disc may be scratched or marked in the process.**
- **When inserting a disc, do not put one disc on another. Failure to observe this may cause the discs to be jammed.**

Do not leave discs in the following places:

- Direct sunlight
- Near car heaters
- Dirty, dusty and damp areas
- On seats and dashboards

Disc cleaning

Use a dry, soft cloth to wipe from the center outward. Do not attach any seals or labels to your discs. Do not write on the disc label in a heavy pen or ballpoint pen.

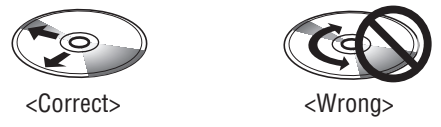

Notes on CD-Rs/RWs, DVD-Rs/RWs

- You may have trouble playing back some CD-R/RW, DVD-R/RW discs recorded on CD/DVD recorders (CD-R/RW, DVD-R/RW drives), either due to their recording characteristics or dirt, fingerprints, scratches, etc. on the disc surface.
- CD-R/RW, DVD-R/RW discs are less resistant to high temperatures and high humidity than ordinary music CDs. Leaving them inside a car for extended periods may damage and make playback impossible.
- The unit may not successfully playback a CD-R/RW, DVD-R/RW that was made by the combination of writing software, a CD/DVD recorder (CD-R/RW, DVD-R/RW drives) and a disc if they are incompatible with one another.
- This player does not play CD-R/RW, DVD-R/RW discs if the session is not closed.
- Be sure to observe the handling instructions of CD-R/RW, DVD-R/RW discs.
- This player does not play CD-R/RW, DVD-R/RW discs which contain other than CD-DA or MP3/DivX data.

Language Code List



DVD language menu (→ page 34)

In “Other” cases... (→ page 34)

Input the four digit language code pressing the buttons **0** to **9**. Touch **Enter** to determine.

Note:

- Setting is finished and the display returns to the main menu.
- For retrying selection during number entry, touch **Clear**.

Code	Language Name
6565	Afar
6566	Abkhazian
6570	Afrikaans
6577	Ameharic
6582	Arabic
6583	Assamese
6589	Aymara
6590	Azerbaijani
6665	Bashkir
6669	Byelorussian
6671	Bulgarian
6672	Bihari
6678	Bengali; Bangla
6679	Tibetan
6682	Breton
6765	Catalan
6779	Corsican
6783	Czech
6789	Welsh
6865	Danish
6869	German
6890	Bhutani
6976	Greek
6978	English
6979	Esperanto
6983	Spanish
6984	Estonian
6985	Basque
7065	Persian
7073	Finnish
7074	Fiji
7079	Faroese
7082	French
7089	Frisian
7165	Irish
7168	Scots Gaelic
7176	Galician
7178	Guarani
7185	Gujarati
7265	Hausa
7273	Hindi
7282	Croatian
7285	Hungarian

Code	Language Name
7289	Armenian
7365	Interlingua
7378	Indonesian
7383	Icelandic
7384	Italian
7387	Hebrew
7465	Japanese
7473	Yiddish
7487	Javanese
7565	Georgian
7575	Kazakh
7576	Greenlandic
7577	Cambodian
7578	Kannada
7579	Korean
7583	Kashmiri
7585	Kurdish
7589	Kirghiz
7665	Latin
7678	Lingala
7679	Laothian
7684	Lithuanian
7686	Latvian, Lettish
7771	Malagasy
7773	Maori
7775	Macedonian
7776	Malayalam
7778	Mongolian
7779	Moldavian
7782	Marathi
7783	Malay
7784	Maltese
7789	Burmese
7865	Nauru
7869	Nepali
7876	Dutch
7879	Norwegian
7982	Oriya
8065	Panjabi
8076	Polish
8083	Pashto, Pushto
8084	Portuguese
8185	Quechua

Code	Language Name
8277	Rhaeto-Romance
8279	Romanian
8285	Russian
8365	Sanskrit
8368	Sindhi
8372	Serbo-Croatian
8373	Singhalese
8375	Slovak
8376	Slovenian
8377	Samoan
8378	Shona
8379	Somali
8381	Albanian
8382	Serbian
8385	Sundanese
8386	Swedish
8387	Swahili
8465	Tamil
8469	Telugu
8471	Tajik
8472	Thai
8473	Tigrinya
8475	Turkmen
8476	Tagalog
8479	Tonga
8482	Turkish
8484	Tatar
8487	Twi
8575	Ukrainian
8582	Urdu
8590	Uzbek
8673	Vietnamese
8679	Volapük
8779	Wolof
8872	Xhosa
8979	Yoruba
9072	Chinese
9085	Zulu

Definition of Terms

Dolby Digital

This fully discrete format divides the music signals into 5.1 channels: Front Left (L), Front Right (R), Centre (C), Left Surround (LS), Right Surround (RS) and Subwoofer (SW: 0.1 channel) for recording and playback. The number of channels that are recorded depends on the software. (1 to 5.1 channels)

Manufactured under license from Dolby Laboratories.
 "Dolby" and the double-D symbol are trademarks of Dolby Laboratories.
 Confidential unpublished works. Copyright 1992–1997 Dolby Laboratories. All rights reserved.

Interactive DVD

An interactive DVD is DVD software which includes multiple angles, multiple plot endings, etc.

Letterbox screen

This refers to a screen on which the playback picture of wide-screen DVDs or VCD (Video CD)s appears with black bands running along the top and bottom.

LPCM (Linear PCM audio)

In this format, the audio signal is converted to digital data and recorded in two channels without compression. Because the capacity of a DVD disc is large, it can store more data with better accuracy than a CD.

Pan & Scan screen

This refers to a screen on which the playback picture of wide-screen DVDs or VCD (Video CD)s is cut off at the left and right sides.

Playback control (VCD (Video CD))

If the VCD (Video CD) has "With Playback Control" or others written on the disc surface or on the jacket, the scenes or information to be viewed (or listened to) can be selected interactively with the screen by looking at the menu shown on the screen.

In these instructions, playback using the menu screen is referred to as the "menu play" for video CDs. This player supports Video CDs with playback control.

DivX

DivX is a popular media technology created by DivX, Inc. DivX media files contain highly compressed video with high visual quality that maintains a relatively small file size. DivX files can also include advanced media features like menus, subtitles, and alternate audio tracks. Many DivX media files are available for download online, and you can create your own using your personal content and easy-to-use tools from DivX.com.

This product incorporates copyright protection technology that is protected by U.S. patents and other intellectual property rights. Use of this copyright protection technology must be authorized by Macrovision, and is intended for home and other limited viewing uses only unless otherwise authorized by Macrovision. Reverse engineering or disassembly is prohibited.

Official DivX® Certified product
 Plays all versions of DivX® video with standard playback of DivX® media files
 DivX, DivX Certified, and associated logos are trademarks of DivX, Inc. and are used under license.

Specifications

General

- Power supply : 12 V DC (11 V – 16 V), test voltage 14.4 V, negative ground
- Current consumption : Less than 10 A (during disc playback)
- Power Output : 20 W x 4 ch (1 kHz, 1 %, 4 Ω)
- Maximum power output : 50 W x 4 ch
- Compatible speaker impedance : 4 Ω
- Video input signal : Composite video signal, 1.0 Vp-p (75 Ω)
- Audio input sensitivity : 2 Vrms
- Video output signal : Composite video signal, 1.0 Vp-p (75 Ω)
- Pre-Amp output voltage : 2 Vrms
- Pre-Amp output impedance: Less than 600 Ω
- Dimensions (W x H x D) : 178 x 100 x 160 mm
- Weight : 2.3 kg

FM stereo radio

- Frequency range : 87.5 MHz – 108 MHz
- Usable sensitivity : 7 dB/μV
- Stereo separation : 30 dB (1 kHz)
- S/N ratio : 62 dB

AM radio

- Frequency range : 531 kHz – 1 602 kHz
- Usable sensitivity : 28 dB/μV
- Image rejection ratio : 50 dB

Note:

- Specifications and the design are subject to modification without notice due to improvements in technology.
- Some figures and illustrations on this manual may be different from your product.

Playable region number

This operating instruction manual is for 3 models CQ-VW100W2/CQ-VW100W3 and CQ-VW100W5. The following table shows the playable region number for each model.

Model	Playable region number
CQ-VW100W2	2 (ALL)
CQ-VW100W3	3 (ALL)
CQ-VW100W5	5 (ALL)

Audio section

- Output voltage/ Impedance : 2 Vrms/600 Ω
- Frequency characteristics : 20 Hz – 20 kHz (±1 dB)
- Dynamic range : 96 dB (during CD playback)
- S/N ratio : 95 dB (during CD playback)

Monitor

- Liquid crystal panel : 7-inch wide
- Screen dimensions (W x H x D) : 154 x 87 x 177 mm
- Number of pixels : 336 960 pixels (234 vertical x 480 horizontal x 3)
- Valid pixel ratio : Over 99.99%
- Display method : Transparent color filter format
- Drive method : TFT (Thin Film Transistor) active matrix format

■ 보증서

모델명	CQ-VW100W		
고객란	고객 성명:	_____ 님	
	고객 주소 : 우편번호	_____ 동(리)	
		시	구(읍, 면)
	전화 번호 : (_____)	_____ - _____	
구입 년월일	판매점 명, 주소, 전화 번호 :		
년 월 일			
보증 기간 (구입일부터)	전화 번호 : (_____) _____ - _____		
1 년간	제품의 시리얼 번호 :		

※ 구입일과 구입처(판매점)를 분명히 기재하여, 고객에게 전달하시기 바랍니다. 차후의 A/S수리와 관련하여 매우 중요하오니 반드시 보관하시기 바랍니다.

※ 당사에서는 제품의 시리얼 번호를 전산 처리하여 관리하고 있습니다. 보증서에 시리얼 번호를 기록 하여 두시기 바랍니다.

제조년월

Panasonic Car Audio 세풍전자공업주식회사
 한국총대리점 본사 : 서울특별시 영등포구 양평동5가 56-2
 전화 : (02)2633-0856(대표전화)
 고객상담실 : (02)2633-0878
 홈페이지 : www.sepung.co.kr

Matsushita Electric Industrial Co., Ltd.

Web Site : <http://panasonic.net>

YFM264C061CA PTW1107-1018

Printed in China

Free Manuals Download Website

<http://myh66.com>

<http://usermanuals.us>

<http://www.somanuals.com>

<http://www.4manuals.cc>

<http://www.manual-lib.com>

<http://www.404manual.com>

<http://www.luxmanual.com>

<http://aubethermostatmanual.com>

Golf course search by state

<http://golfingnear.com>

Email search by domain

<http://emailbydomain.com>

Auto manuals search

<http://auto.somanuals.com>

TV manuals search

<http://tv.somanuals.com>